

Pico Reentry Probes: Affordable Options for Reentry Measurements and Testing

**William H. Ailor⁽¹⁾, Vinod B. Kapoor⁽²⁾, Gary A. Allen, Jr.⁽³⁾, Ethiraj Venkatapathy⁽⁴⁾,
James O. Arnold⁽⁵⁾ and Daniel J. Rasky⁽⁶⁾**

⁽¹⁾ Director, Center for Orbital and Reentry Debris Studies, The Aerospace Corporation, 2350 E El Segundo Blvd, El Segundo, CA 90245, william.h.ailor@aero.org

⁽²⁾ Senior Project Engineer, The Aerospace Corporation, 2350 E El Segundo Blvd., El Segundo, CA 90245, vinod.kapoor@aero.org

⁽³⁾ Senior Research Scientist, Eloret Corporation

⁽⁴⁾ Senior Staff Scientist and Planetary Exploration Technology Manager, NASA Ames Research Center, Moffett Field, CA 94035, ethiraj.venkatapathy-1@nasa.gov

⁽⁵⁾ Senior Scientist, NASA Ames Center for Nanotechnology and Nanotechnology Area Manager, University Affiliated Research Center (UARC), Moffett Field, CA 94035, jarnold@arc.nasa.gov

⁽⁶⁾ Senior Staff Scientist, NASA Ames Research Center, Moffett Field, CA 94035, drasky@arc.nasa.gov

ABSTRACT

It is generally very costly to perform in-space and atmospheric entry experiments. This paper presents a new platform - the Pico Reentry Probe (PREP) - that we believe will make targeted flight-tests and planetary atmospheric probe science missions considerably more affordable. Small, lightweight, self-contained, it is designed as a “launch and forget” system, suitable for experiments that require no ongoing communication with the ground. It contains a data recorder, battery, transmitter, and user-customized instrumentation. Data recorded during reentry or space operations is returned at end-of-mission via transmission to Iridium satellites (in the case of earth-based operations) or a similar orbiting communication system for planetary missions. This paper discusses possible applications of this concept for Earth and Martian atmospheric entry science. Two well-known heritage aerodynamic shapes are considered as candidates for PREP: the shape developed for the Planetary Atmospheric Experiment Test (PAET) and that for the Deep Space II Mars Probe.

1.0 INTRODUCTION

Space hardware reentering Earth’s atmosphere faces a harsh heating and loads environment. In general, unprotected spacecraft hardware in this environment will melt, come apart, and disperse over a large area. While computer models can predict how such objects will respond to the environment and estimate the hazard to people and property on the ground from

such events, very little debris has been recovered that can be used to calibrate these models. With the exception of the tragic loss of the Space Shuttle Columbia and its crew, over the last 44 years of space activities, it is estimated that fewer than 250 pieces have been recovered, and most of these were not examined. Columbia’s heatshield protected most of that vehicle for a portion of the reentry, so many of the fragments recovered from it may not be representative of the reentry of an unprotected object.

The ideal approach for obtaining sufficient information to calibrate reentry breakup models would be to record information on attitudes, rates, temperatures, etc., as an object is actually reentering and breaking apart. Unfortunately, the environment prohibits reliable communications, so rather than transmit the data as it is recorded, it is better to retrieve it during the descent, when communication is feasible, or from ground recovery of the recorder after landing. Clearly, the data recorder must be protected from the entry heating and loads (it must have a heatshield and be designed to survive) and it must either be retrieved or broadcast its data. Since debris from a reentering satellite will be spread over hundreds of square miles anywhere on earth and possibly over water, recovery may be very difficult or impossible. If the survivable device is properly designed, it will separate from the host vehicle, follow its own trajectory, and reach a free fall state (terminal velocity, dropping straight down) at above 50,000 ft. The time to impact from this point depends on the trajectory, which in turn depends on the entry system shape and weight of the device, but typically ranges from 5 to 7 minutes.

These factors led to the design of a small, lightweight, survivable, self-contained device containing a data recorder, instrumentation, battery, and transmitter. The device, called a Reentry Breakup Recorder (REBR) and illustrated in Fig.1, will weigh less than 1 kg, has a heatshield, and will use internal sensors to measure and record attitude, rates, temperatures, and GPS location data. Some of these sensors could be externally mounted to the REBR device and would be demolished as reentry progresses. The recorded data would be “phoned home” during the free fall using the Iridium or similar orbiting communications satellites. There is no need to recover the device, although the GPS data could make that possible, in some cases. As illustrated in Fig.2, one or more of the devices would be “glued” to specific pieces of space hardware to record data during reentry of that hardware.

Design of REBR and its communications architecture has been ongoing for the last few years at The Aerospace Corporation. An initial design of the REBR payload (battery, basic sensors, data recorder, transmitter, and antennae) indicates a payload weight of about 0.35 kg. Preliminary testing, including a drop test from a high altitude balloon using Iridium as the communications pathway, has provided confidence in the overall concept. A major unknown has been the heatshield design and weight, and this paper highlights results of a study of these components.

While REBR was designed for reentry breakup research, a more general version of this device, which we call the Pico Reentry Probe (PREP), addresses the entry system design including the trajectory, the entry probe shape, and the thermal protection system (TPS). PREP is a modular concept and can be designed to conduct flight-testing of an integrated entry system, or flight qualification of subsystems such as TPS and innovative sensors and science instruments. It can also be used to perform low cost atmospheric science experiments.

Like REBR, PREP could be carried to orbit on a ride of opportunity, but would separate from the host vehicle prior to or early in the reentry. In the case of flight qualification of a TPS, PREP will be designed to record the TPS performance data during the high-speed portion of the flight and would send this information home during the terminal descent phase. The flight data will allow the TPS technologist to reconstruct the trajectory, compare the measured values with the predicted heating rates, and thereby establish the quality of the TPS performance. Since the proposed concept does not require ground

tracking, targeting a reentry, or other operations normally entailed in atmospheric entry experiments, it is potentially a very inexpensive option for conducting some types of testing.

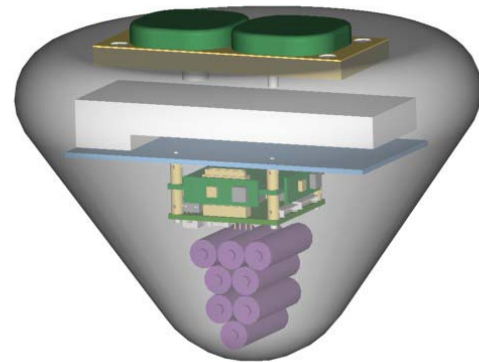

Fig. 1. The PREP design concept showing (from the bottom) batteries, data recorder, command and control board, transmitter, and antennae, all enclosed within the entry system with protective heat shield. Base diameter for PREP is 0.22 m (8.5 inches).

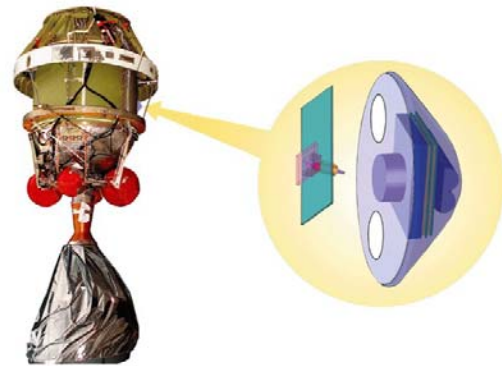

Fig. 2. The REBR or PREP would be attached to a launch stage or other hardware and carried to orbit. In the case of a reentry test-bed for TPS or sensor flight test and qualification, PREP will be part of an orbital system to be released on command.

2.0 OPERATIONAL CONCEPT (MISSION DESIGN)

Fig. 3 illustrates the mission concept for a typical reentry. PREP is dormant during the launch and operational lifetime of the host vehicle; it wakes up

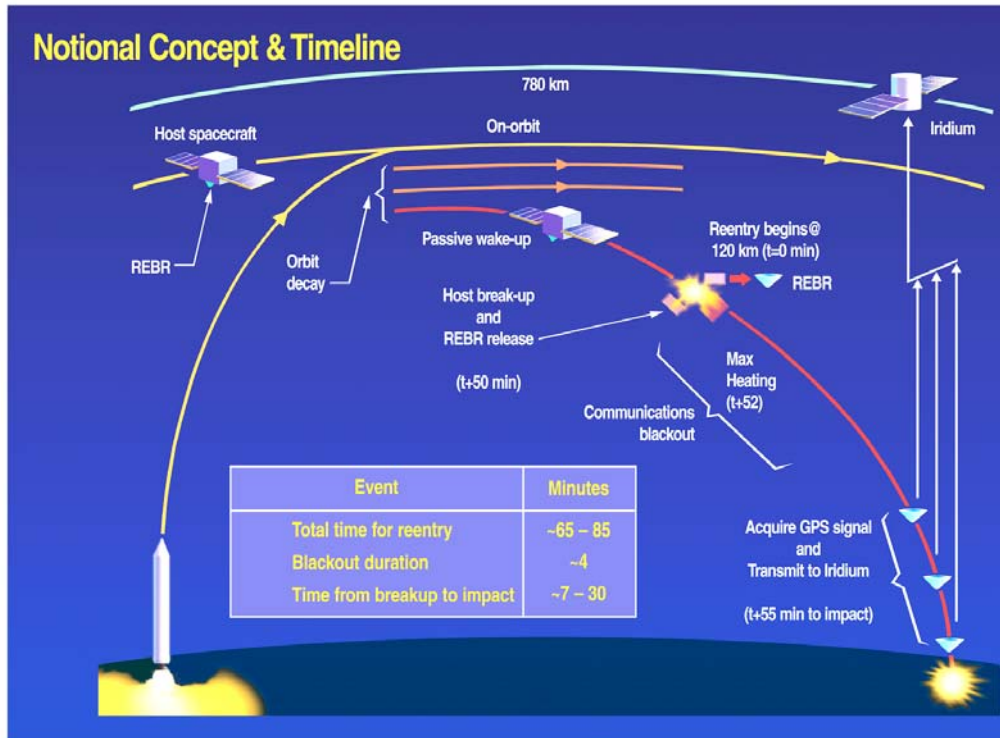

Fig. 3. Schematic of the mission scenario of REBR or PREP. The host launch stage or satellite would decay from orbit, reenter, and release the REBR or PREP.

and initializes itself as the host reenters the atmosphere. It acquires and stores data from its sensor suite during the reentry (and, in relevant cases, the breakup) of the host vehicle. A heat shield protects the PREP electronics from heating as reentry progresses, allowing it to survive while major parts of the host vehicle melt or ablate. It separates from the host vehicle at some point during the breakup process, and transmits the stored data through an overhead communication system (e.g. Iridium) prior to impact.

The times from the beginning of reentry to breakup and from breakup to impact will vary with each situation, but generally PREP has approximately 5 minutes to broadcast its data prior to impact. A host vehicle could carry several PREPs for redundancy and to record data specific to a particular location on the body or other area of interest. This feature may be of particular interest as a way to get in vivo information concerning satellite breakup.

One advantage of this concept is the cost of the hardware itself and, perhaps more importantly, of the infrastructure needed to conduct a test. A typical reentry test involves a specialized vehicle that can deorbit or insert the reentry vehicle into a specified location where radar, optical trackers and others wait

to gather data. The cost of this infrastructure can be millions of dollars for each test. Since REBR and PREP take a ride of opportunity to space and use an existing communications network, very little infrastructure is required and much of the cost is eliminated.

The reentry heatshield is a key subsystem for these applications, and the TPS design requirements and material availability are discussed in the next section. Another key component is the communications system, discussed below in Section 4.3. Finally, this low-cost approach may enable new areas of atmospheric and material response investigations, and some potential applications of this system are proposed in this paper.

3.0 ENTRY SYSTEM DESIGN

Typical re-entry systems transport a payload package safely through the hypersonic/supersonic entry phases while protecting it from the external thermal and mechanical loads. If a soft landing is a requirement, then, in addition, the entry system will be designed to deploy a descent system (e.g., a parachute) to slow the vehicle. While it has been accomplished many times, deployment of a

descent/parachute system is a complex and risky operation, requiring the ejection of the heat-shield and the backshell TPS prior to the deployment of the parachute at the right time during entry.

The design requirements for a PREP entry system are much simpler. The primary requirement is a system that allows sufficient time during the low-speed ($M < 4$) phase to transmit the data to the orbiting communication system. Recovery of the data, not of the payload, is paramount. The subsystem requirements derived from this prime requirement drive the overall design towards a design solution with the least complexity, weight and cost. The system design is an iterative process and a brief description of the preliminary design process and the tools employed to guide the design is provided below.

The PREP design begins with an estimate for the payload mass and the volume. The current best estimate of the weight of the PREP payload (batteries, memory, command and control electronics, transmitter, and antennae) is about 350 grams. The objective is to keep this weight as low as possible to keep the overall entry system mass to a minimum, and to maximize the descent time for a given vehicle size. The largest data recorder/communication system component (see Fig. 1) can easily be accommodated with a maximum probe dimension of about 8.5 inches or 0.22 m diameter.

The next task is to select potential entry shapes. The shape, or Outer Mold Line (OML), determines the static-aerodynamic characteristics. The shape and the mass properties determine the static and dynamic stability (or orientation) of the probe during entry and descent. In keeping with the design philosophy of simplicity, we elected to evaluate the PAET and DS-II probe shapes shown in Figures 4 and 5.

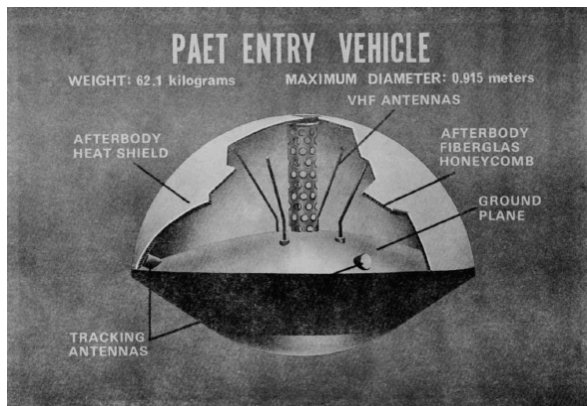

Fig. 4. Cut-away view of PAET Vehicle.

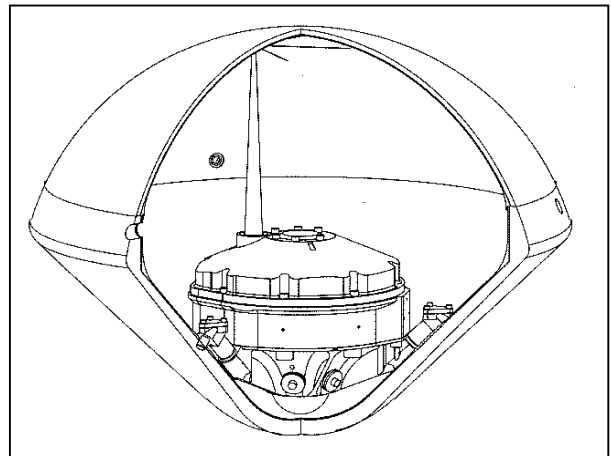

Fig. 5. DS-II Probe – Cut-away view of payload and the OML.

The well-studied aerodynamic characteristics of these two heritage aerodynamic shapes make them good candidates for PREP design. The PAET [1] flew in 1971; the OML of its heatshield is a simple sphere-cone with a cone half-angle of 55° . The DS-II Mars Probe [2] flew to Mars in 1998, but was lost. Compared to PAET, the shape of the DS-II is slender. Its forebody is also a sphere cone with a conical frustum half-angle of 45° . DS-II shape has lower drag than PAET for a given base diameter. Considerable effort was spent during the DS-II design phase to determine the afterbody shape that assured not only stability but also the ability for the probe to orient itself correctly (forebody heat shield pointing in the direction of travel), independent of the orientation during orbital release from host spacecraft.

Given the aerodynamic characteristics, vehicle mass properties, and initial conditions (velocity, altitude, flight-path angle, and initial rates where appropriate), either three degrees of freedom (3-DOF) or 6-DOF simulations of the trajectory can be constructed. Higher fidelity 6-DOF Monte Carlo simulations can account for perturbation of a number of trajectory parameters or inputs and are often used in the detailed design phase to determine temperature limits. The 6-DOF simulations require both static and dynamic aerodynamic databases, detailed mass properties, and atmospheric properties. Such a level of analysis is beyond the scope of this paper. For the purposes of our current preliminary design, 3-DOF simulations are sufficient to determine the subsystem requirements and to determine whether the trajectory provides sufficient descent time for data transmission.

Once the velocity and altitude as a function of time are determined using 3-DOF simulations, the heating profile can be determined using well-known engineering formulas for the stagnation point, or using high fidelity CFD methods. The TPS material and the thickness required to keep the payload from over-heating are determined from the heating profile, using simulation methods for TPS response. It is a standard practice during preliminary design, especially with simple forebody shapes, to assume a TPS of constant thickness, based on its thickness at the stagnation point. Unless TPS mass fraction is significant, a constant thickness TPS is maintained to be conservative. For example, the Mars Pathfinder and Mars Exploration Rover heatshields used constant thickness TPS.

NASA Ames has spent considerable effort over the past decade to develop a fast, iterative, coupled trajectory and TPS sizing tool-kit known as TRAJ [3]. TRAJ has been validated using data from Pathfinder, PAET, Pioneer-Venus and other missions. TRAJ has been successfully applied to the TPS design of numerous missions including MER and MSL.

4.0 DESIGN ASSUMPTIONS FOR EARTH AND MARS MISSIONS

A total entry mass of 0.85 kg was assumed, including 0.35kg of payload. The design exercise is to assure that the entry probe aeroshell mass, which includes the mass of the TPS and structures, is less than 0.5 kg. The base-diameter of 0.22m (8.5 inches) was selected. The baseline TPS was Silicone Impregnated Reusable Ceramic Ablator (SIRCA) with a density of 260 kg/meter³. If SIRCA is found not to meet the requirement, another TPS material, Phenolic Impregnated Ceramic Ablator (PICA), with a density of 228 kg/meter³ and higher heat-flux performance is available. The internal structure was based on Pioneer-Venus structure: 0.0148-inch thick RTV-560 bondline with 0.125-inch thick sheet aluminum (2024 alloy). The TPS thickness is iterated until it meets the constraint that the bondline reach very close to 250°C; it is a function of the initial temperature of the TPS at the point of reentry (cold-soak temperature), and the best practice is to assume the cold-soak temperature to be 20 °C.

4.1 PREP Earth Mission Design Simulations and Key Results

In order to accommodate a range of missions, two entry angles (0° and -39°) were selected to represent the extreme entry angle conditions for entry trajectory simulation. An entry angle of zero represents a slow orbital decay and entry, while an entry angle of -39° represents a very steep entry that the system might encounter after an abort, or to accommodate requirements for a flight test-bed for subsystems such as TPS or Instrumentation. The starting state vector and the input conditions are listed in Table 1.

Table 1. Input conditions assumed in simulating the trajectory for PREP Earth entry.

Altitude at entry, km	93.0
Radial distance at entry, km	6464 km
Inertial velocity at entry, km/s	6.88 km/sec
Inertial entry angle (gamma)	-(0, 39°)
Inertial heading angle (psi)	108°
Geocentric latitude	34.16°
TPS temperature at entry	293 °K

The predicted trajectories and corresponding heat flux histories for the four cases (the two shapes, PAET and DS-II, each at two entry angles) are shown in Figs. 6 and 7, respectively. As mentioned earlier, in addition to predicting the trajectory, the TRAJ code also predicts the heat-flux profile and computes the TPS required at the stagnation point, based on a prescribed baseline TPS.

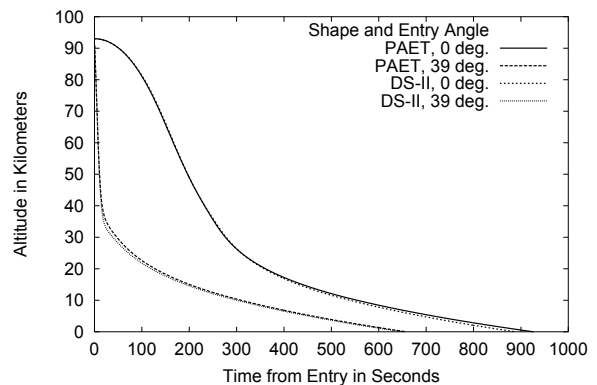

Fig. 6. The trajectory histories in terms of altitude vs. time are compared for the two entry flight path angles.

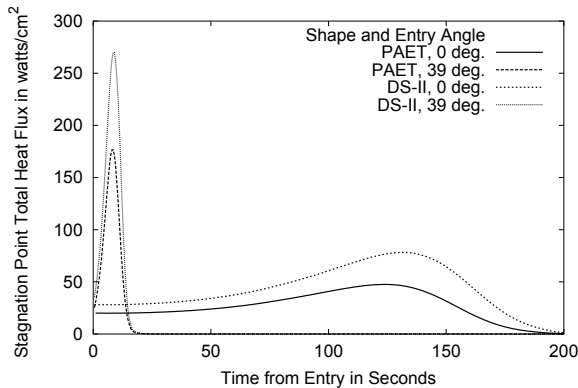

Fig. 7. Predicted heat-flux histories for the PAET and DS-II shapes and for the limiting entry angles (0 deg., -39 deg.) are compared for sub-orbital entry conditions.

The DS-II and the PAET are very similar in terms of the altitude descent characteristics, both for the slow decay sub-orbital descent (zero entry angle) and for a steep (-39°) entry angle descent. As expected, the most severe heat-flux is experienced by the steepest trajectory, but the highest heatload is experienced by the shallow trajectory. The TPS material selection depends on the peak heat-flux, whereas its thickness is determined by the shallow trajectory. SIRCA is a most efficient and lightweight solution for moderate heat-fluxes up to 180 W/cm² and is a very good choice for the PAET-shaped probe. On the other hand, the peak heat-flux experienced by the DS-II shape at the steep entry angle (-39°) far exceeds the SIRCA performance limit. As a result, the TPS choice for the DS-II was PICA, which can withstand peak heat-fluxes up to 1200 W/cm². The maximum allowed stagnation pressure for PICA (1/2 atm) was not exceeded during the heat pulse.

The key results from the coupled trajectory and TPS sizing simulations are provided in Table 2. As noted, the TPS sizing is performed at the stagnation point and a constant TPS thickness is assumed all around the forebody in determining the weight and the mass fraction of the heatshield. The heatshield mass includes an aluminum skin (structures). The aft-shell TPS and structural mass were not computed, but it is typically a small percentage of the forebody mass, since the aft region heating is typically less than 4% of the stagnation heating. A PAET-shaped probe heat shield with a mass of about 0.16 kg or 19% of

the total entry mass will be adequate to withstand the heating encountered in any trajectory between the two extreme entry angles studied here. The mass required for the heatshield of the DS-II shaped probe (estimated to be close to 67% of the entry mass, or 0.57kg) is unacceptably large. As a result, the PAET shape is preferred for earth entry applications.

In addition to the heat load, mechanical entry loads of up to 67 g's will be experienced, and the aeroshell and the payload must be designed to withstand such loads (the Pioneer-Venus Probe was designed to withstand up to 400 g's). They are not considered a problem for either the aeroshell or the payload.

The results clearly show that the PAET probe shape is preferable to the DS-II shape. The heating experienced by PAET shape is well within the capability of SIRCA. A mass fraction allocation of 20% for the heatshield, based on a 0.85 kg entry mass, is adequate to handle the expected range of entry angles. In the case of PAET, there is adequate mass margin available to accommodate aft-shell TPS and structures, as well as additional lightweight instrument or sensors, if necessary for the Earth applications.

4.2 PREP Mars Mission Simulations and Key Design Results

One of the potential applications of PREP involves science missions on Mars: a series of PREP devices containing sensors to detect atmospheric volatiles could be released from orbit periodically, to measure seasonal variations of the atmospheric composition [4]. This could possibly be performed by a very small, dedicated mass spectrograph or by the novel sensors from the emerging field of nanotechnology. The motivation to consider Pico-Probes for Mars is a result of the science goals outlined in the Decadal Survey [5], asking for revolutionary advances in nano/micro sensors that point to future miniaturized sensor detector systems and the need to find low-cost alternatives to current mission designs.

The input conditions assumed for the Mars mission scenario are similar to the Viking entry conditions. As mentioned above, the TRAJ code has been validated with data from Viking and Pathfinder, and is designed to simulate trajectories in various planetary systems. Once again we consider two shapes, the DS-II and the PAET, released from orbit with an inertial velocity of 4.6 km/s (Viking entry conditions). The entry angle is assumed to be -17°.

The probe size, entry mass and payload mass are exactly the same as the Earth entry case discussed earlier. The baseline TPS is SIRCA and the initial

cold-soak temperature of the heatshield is conservatively assumed to be 20⁰ C.

Table 2. Results from the four cases (DS-II and PAET shapes at two different entry angles), obtained from the TRAJ code.

	DS-II		PAET	
	0 ⁰	-39 ⁰	0 ⁰	-39 ⁰
Entry Angle	0 ⁰	-39 ⁰	0 ⁰	-39 ⁰
Ballistic Coefficient	31	31	27	27
Deceleration load, G	7.5	70	7.48	67
Stag. Point peak Heat Flux, W/cm ²	78	271	48	177
Stag. Point heat-load, joules/cm ²	8641	2204	5317	1417
TPS material	PICA	PICA	SIRCA	SIRCA
TPS thickness, cm	4.85	1.05	1.39	0.29
Heatshield mass fraction, % of entry mass of 0.85 kg	67%	15%	19%	4%
Total mass, kg	0.85	0.85	0.85	0.85
Payload mass, kg	0.35	0.35	0.35	0.35
Heatshield mass, kg	0.57	0.12	0.16	0.033
Excess mass capacity to account for backshell, etc., kg	(-0.07)	0.38	0.34	0.467
Total EDL time, s	888	650	927	658
Transit time for communication, s	644	623	689	627

The key results from the simulations are shown in Figs. 8 and 9, and in Table 3. The results are very encouraging and the heat-flux, heat-load and the heatshield mass fraction are much smaller than the Earth entry cases and a mass fraction of less than 7% is adequate. Though the results are very encouraging, designing a Mars mission requires additional consideration. The lack of a GPS system requires 6-axis accelerometers on-board for trajectory reconstructions. Uplink to the orbiting satellite is a more demanding task and requires evaluation of orbital uplinks available during entry. One option is to use the spacecraft that releases the probe as the uplink station, and then the PREP mission would have to be designed to ensure adequate visibility between the probe and the spacecraft during the communications phase.

Future study of point designs of PREP or slightly larger nanocraft should be conducted to address the possibility of flying novel nano/micro volatile gas detectors and currently-evolving lightweight mass spectrographs to meet the New Frontiers Science mission objectives mentioned earlier.

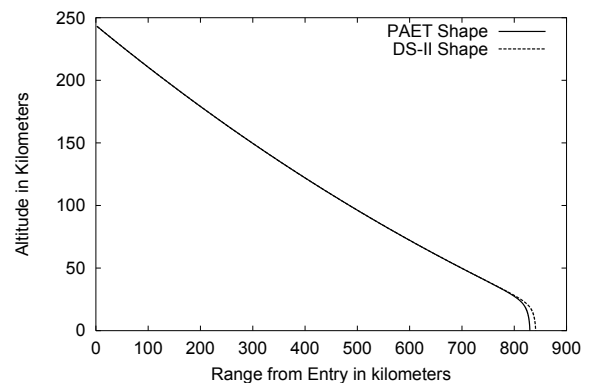

Fig. 8. PREP Mars entry trajectory of altitude vs. range shows the PAET and the DS-II shapes are very similar, and the requirements for communication uplink (or look angle) are not a discriminating factor in determining the shape.

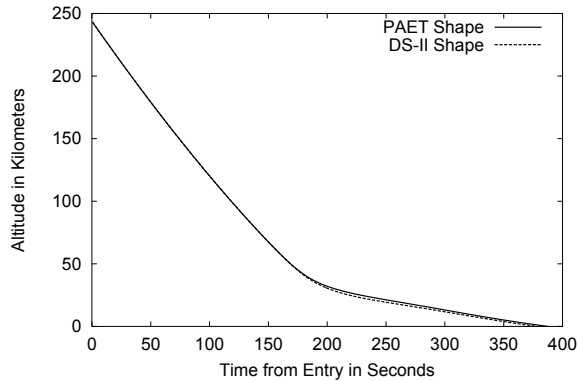

Fig. 9. PREP Mars entry trajectories for the PAET and the DS-II configurations are very similar - not a discriminating factor in the design.

Table 3. Key results for the PREP entry simulation for Mars entry from orbit. As a result of the low orbital entry speed and the thin Martian atmosphere, the TPS requirements are less severe than for Earth. SIRCA as the baseline material will provide adequate thermal protection for either of the two shapes. The required heatshield mass fraction is less than 7%.

	DS-II	PAET
Ballistic Coefficient kg/m ²	22	16
Deceleration load, g's	9.4	9.8
Stagnation point Heat Flux (max), W/cm ²	49.39	31.39
Stagnation point heat-load, J/cm ²	1977	1248
TPS thickness, cm	0.41	0.31
TPS mass, kg	0.0551	0.0358
TPS mass fraction, %	6.5	4.2
Total EDL time, s	378	387
Time for communication, s	107	112

4.3 Communications Architecture

A key component of the PREP design is the communication of data before impact, requiring that a receiver be above the reentry vehicle during its final free-fall. If PREP is returning to Earth, several options are available to receive and relay the broadcast data. These include commercial GEO

systems (Astrolink, Spaceway, and Inmarsat), commercial LEO/MEO systems (Iridium, Globalstar, ICO, and Orbcomm), dedicated GEO (TDRSS), and dedicated aircraft (P3 Orion). After analysis of the requirements for coverage, availability, required power (Effective Isotropic Radiated Power), and cost, Iridium was chosen as the preferred candidate for PREP. The main consideration for Iridium was its full-time global coverage, coupled with its immediate availability: PREP would simply “phone home” at the end of its mission, with no advance scheduling required. On the basis of this selection, more detailed analysis of the Iridium constellation is required, including an investigation of the effect of the vehicle position and velocity on the communications link. A side benefit of the choice of Iridium is that the frequencies of the L1 carrier for GPS and of Iridium are within a few percent of each other, allowing the possibility of using a single antenna for both applications simultaneously, with appropriate filtering.

The initial concept for data transmission was the use of two omni-directional antennas to get full-sky coverage of the transmitted data. One of the associated drawbacks is the high power required to transmit continuously using both antennas, which would also entail high mass because of the additional hardware required, and data dropout if the vehicle is tumbling. To simplify the communications architecture and reduce the mass and power requirements, a design that uses a single antenna was selected. This required a method of assuring that the single antenna could point “up” toward the communications assets and will be achieved through center-of-gravity management: aeroshaping the heat shield to produce an aerodynamically stable freefall. While a parachute or streamer could be used, such a system would add to the complexity of the device, and every effort will be made to avoid use of such “active” systems. For the Mars mission experiments, the communications system will be engineered to interface with the available Mars communications infrastructure, using the existing Orbiter constellation at the time of the experiment. REBR and PREP hardware design is modular, with standard industry interfaces. The modems will be different for different applications and communications environments.

4.4 Safety

PREP uses the “fire and forget” concept—the probes can come down anywhere and complete their mission before impacting the ground. On ground impact, it is possible that one of the devices could strike an individual or cause property damage. The

probability that a PREP device will injure an individual can be estimated on the basis of orbit inclination. Assuming a 1-ft² size, the highest casualty expectation would be on the order of 1x10⁻⁶ per device. This is well within the published DoD and NASA safety guidelines (1x10⁻⁴) for reentering hardware. Assuming a terminal ballistic coefficient of 31.1 kg/m², (DS/2 shape, worst case) the impact velocity at sea level is 22.3 m/sec. The likelihood of an individual being struck and injured by a PREP device is very small.

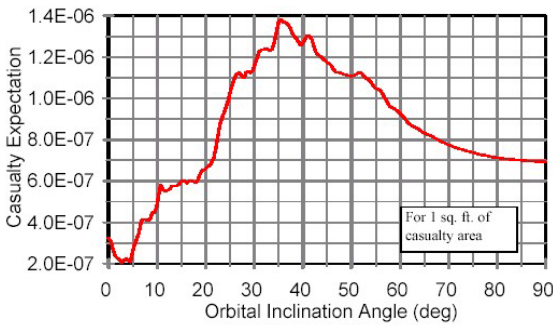

Fig. 10. The variation in casualty expectation as a function of orbit inclination is due to the population density under the orbit [6].

Safety related to orbiting satellites and manned systems such as the Space Shuttle and the International Space Station is not believed to be an issue with PREP, which is designed to operate in a reentry environment and would normally be attached to, or deployed from, space hardware that is going to reenter. As a result, it would not be left in orbit for extended periods as a stand-alone item, but would be attached to a larger, trackable object for much of its life.

4.5 Mission Applications

As a small, lightweight, instrumented reentry probe designed to collect information on heatshield performance, the upper atmosphere, or other information during an actual reentry, PREP will employ technology that enables other applications. For example, the PREP technology could be used for a “black box” for hardware designed to survive reentry [7], such as a single-stage-to-orbit vehicle. In this case, telemetry data would be recorded by the device, and in the event of a reentry accident, the data would be recovered from the device either by direct broadcast as discussed above or by recovery of the device, if GPS data as to its location is available.

PREP could be made available in kit form, allowing universities and researchers relatively inexpensive access to an environment that has been virtually inaccessible prior to this time. In this application, a researcher would use the kit for the basic data collection and communications functions, but would add instruments customized for the particular application.

5.0 SUMMARY AND CONCLUSIONS

Basic design of a small, lightweight, self-contained device to record data during reentry and breakup of space hardware and to broadcast the information to an orbiting communications system prior to ground impact has been ongoing for several years. These devices would collect data during actual breakup of space hardware during reentry, information that would be used to validate and calibrate reentry survival models critical to predicting reentry casualty risks and to help spacecraft manufacturers design space hardware that will respond in predictable and repeatable ways to the reentry environment. A major uncertainty in the design of this REBR has been specific information about the heatshield material and design. The preliminary studies described here indicate that a small, sub-1 kg reentry probe looks very promising. Two materials, SIRCA and PICA, and two shapes, from the DS-II and PAET probes, were considered in this study. Results show that the PAET probe shape using SIRCA is preferred for this application. The total weight of the REBR with this shape and material is 0.85 kg - less than the goal of 1 kg, and providing some margin for refining the shield design, modifying structures, adding sensors, and the like. The heatshield mass fraction for this case is approximately 20% of the total mass of the Recorder.

The novel mission design and communications approach used for the REBR could have benefits for other mission concepts: eliminating the requirement of a dedicated launch and reentry into an instrumented range could substantially lower the cost of testing new heat shield materials. The same basic mission design and communications architecture would be used for this application.

The heatshield design for a possible Mars atmospheric probe was also considered. Results for the SIRCA shield material are more favorable than those for a reentry into Earth’s atmosphere, yielding a mass fraction for the heatshield of less than 7% of the total probe mass. It was noted that use of this concept on another planetary body requires careful mission design, to assure that a receiver for

communications from the small probe is properly located during the probe's broadcast period.

Data collected by small probes of the type described here could provide actual physical evidence about the environments of other planets, could enable new ways of testing and evaluating heat shield materials by exposing them to an actual reentry environment, and could serve as inexpensive flight test vehicles for the validation of TPS engineering and science instrumentation. In such ways, these devices would help new technologies bridge the "valley of death" from TRL 4 to 6, helping secure mission insertion by providing hard performance information to risk-adverse project managers.

Maturation of the concept of using small probes in the atmospheric entry environment may lead to improved models for estimating hazards associated with reentering space hardware. This work may also lead to some very interesting, and potentially very cost effective, science missions of the type advocated in the decadal report.

6.0 REFERENCES

1. Seiff, A., D. Reese, S. Sommer, D. Kirk, E. Whiting and H. Niemann, "PAET, An Entry Probe Experiment in the Earth's Atmosphere," *ICARUS*, 18, 525-563, 1973.
2. "Deep Space 2, Entry System (Aeroshell)," <http://nmp.jpl.nasa.gov/ds2/tech/entry.html>.
3. Allen G.A., P.J. Gage, E. Venkatapathy, D.R. Olynick and P.F. Wercinski, "A Web-Based Analysis System for Planetary Entry Vehicle Design," AIAA Paper No. 98-4826, Jun. 1998.
4. Arnold, J.O. and E. Venkatapathy, "Developments in Nanotechnology and Implications for Future Atmospheric Entry Probes," International Workshop on Planetary Probe Atmospheric Entry and Descent Trajectory Analyses and Science, October 6-9, 2003, Lisbon, Portugal.
5. "New Frontiers in the Solar System: An Integrated Exploration Strategy," Space Studies Board, National Research Council, July 8, 2002, <http://www.nap.edu>.
6. Patera, R.P. and W.H. Ailor, "The Realities of Reentry Disposal," *Advances in Astronautical Science*, AAS 98-174, September 1998.
7. Kapoor, V. and W.H. Ailor, "The Reentry Breakup Recorder: A Black Box for Space Hardware," 17th Annual AIAA/USU Conference on Small Satellites, 2003.