

DEVELOPMENT OF A RAPID CYCLING CO₂ and H₂O REMOVAL SORBENT

Gökhan Alptekin, Matthew Cates, Casey Bernal and Margarita Dubovik
TDA Research, Inc.

Heather L. Paul
NASA Lyndon B. Johnson Space Center

ABSTRACT

The National Aeronautics and Space Administration (NASA) planned future missions set stringent demands on the design of the Portable Life Support System (PLSS), requiring dramatic reductions in weight, decreased reliance on supplies and greater flexibility on the types of missions. Use of regenerable systems that reduce weight and volume of the Extravehicular Mobility Unit (EMU) is of critical importance to NASA, both for low orbit operations and for long duration manned missions. The carbon dioxide and humidity control unit in the existing PLSS design is relatively large, since it has to remove and store eight hours worth of carbon dioxide (CO₂). If the sorbent regeneration can be carried out *during* the Extravehicular Activity (EVA) with a relatively high regeneration frequency, the size of the sorbent canister and weight can be significantly reduced.

TDA Research, Inc. is developing compact, regenerable sorbent materials to control CO₂ and humidity in the space suit ventilation loop. The sorbent can be regenerated using space vacuum during the EVA, eliminating all CO₂ and humidity duration-limiting elements in the life support system. The material also has applications in other areas of space exploration including long duration exploration missions requiring regenerable technologies and possibly the Crew Exploration Vehicle (CEV) spacecraft. This paper summarizes the results of the sorbent development, testing, and evaluation efforts to date.

INTRODUCTION

NASA's future missions require dramatic reductions in the weight and volume of the Portable Life Support System (PLSS) (Fullerton, 2001). To minimize the logistics costs associated with an expendable carbon

dioxide (CO₂) removal system, NASA funded the development of a regenerable CO₂ control system that uses a metal oxide sorbent, referred to as "MetOx". The MetOx canister uses a silver oxide-based sorbent to remove practically all CO₂ generated during the EVA. Existing suit designs include separate CO₂ and humidity control units that are designed to operate for eight hours or more. After each Extravehicular Activity (EVA), the MetOx canister is thermally regenerated inside the spacecraft driving off the CO₂ in an oven (Butler, 1998). This system has been successfully used for several years.

The capacity of the CO₂ control unit limits the duration of the EVA. As NASA's missions become more demanding, there is a need to reduce the logistics burden and the weight and volume of the PLSS components. A record 8 hour and 56 minute EVA on STS 102 has already pushed the limits of the system's endurance and capability (NASA STS 102 Post Mission Summary, 2001). If the sorbent regeneration can be carried out *during* the extravehicular activity (EVA) with a relatively high regeneration frequency, the EVA duration could be increased and the size of the sorbent canister and weight can be significantly reduced. A next-generation space suit design that uses a regenerable CO₂/water (H₂O) removal system is under consideration; it is referred to as the Rapid Cycling Amine (RCA) system (Dean, 1998). The RCA system relies on two alternating beds of solid amine sorbent to remove CO₂ and H₂O from the vent loop and is regenerated cyclically during the EVA. Although the solid amine system is simple, durable and dependable, the performance of a rapid-cycling CO₂ and H₂O control unit could be further improved with the use of a higher capacity and faster cycling sorbent.

TDA Research, Inc. (TDA) is developing a regenerable, long-life sorbent to control CO₂ and humidity levels in the gas breather loop of an advanced space suit. The sorbent is regenerated by pressure swing provided by the space vacuum. The system uses two alternating beds; one bed removes CO₂ and H₂O from the ventilation loop while the other regenerates under space vacuum (without additional heating).

SORBENT DEVELOPMENT

The successful operation of the system requires a compact, regenerable, long duration sorbent that can simultaneously adsorb CO₂ and water vapors. The sorbent should be able to maintain its mechanical integrity through multiple adsorption/regeneration cycles and be regenerable by pressure swing only (with no heat provided to the system). The desirable sorbent for this application should have a relatively strong affinity for CO₂ for its effective removal, however, it should not bind it too strongly so that regeneration can be performed without increasing the bed temperature and using space vacuum only. TDA uses a proprietary material to remove CO₂ from the gas mixture. The active material is prepared on commercially available high surface area (550 m²/g) silica, which provides favorable support for the active phase and also serves as an excellent sorbent for water vapor removal. The powder is then pelletized by using either TDA's proprietary geode technology or by our disc pelletizing operations. The former method produces 1/16" or 1/8" cylindrical pellets from an extrusion process while the latter can form spherical pellets in the range of 1/16" up to 1/2". The geode structure allows combining 80% or more of

active material with an inert binder to provide the mechanical integrity and physical strength needed for the intended application. More recently, TDA has been developing formulations using the disc pelletizer, which allows much lower density and very high porosity to achieve better reactivity (although the mechanical strength of the latter pellets were much lower than those prepared with the geode technology). Many different silica substrates and binders have been tested in multiple formulations.

In the past, samples were pelletized solely by pressure extrusion. These extrudates were then dried and broken into 3-10mm long pellets, approximately 1/16" in diameter. This method provides excellent mechanical rigidity and integrity of the sample, but the performance of the pelletized sorbent was substantially lower than that of the active phase in the form of a loose powder. With the use of a disc pelletizer (Figure 1), we were able to process and pelletize sorbent samples while maintaining a high porosity and a favorable pore structure to ensure desirable mass transfer properties (since the pellets formation is in the absence of any significant pressure, the crushing of the internal porosity was eliminated).

We have run experiments on samples prepared in this new manner, however, the structural integrity of the material was much less than the extruded samples. Because of their lower rigidity, these samples produced significant dust in the system and precluded extensive testing. The mechanical strength of disc-pelletized material is a function of the recipe and procedures used in the formation of the pellets. Figure 2 shows some sample substrates prepared with our disc pelletizer. Experiments are still underway with the disc pelletizer to find suitable



Figure 1. TDA's disc pelletizer.

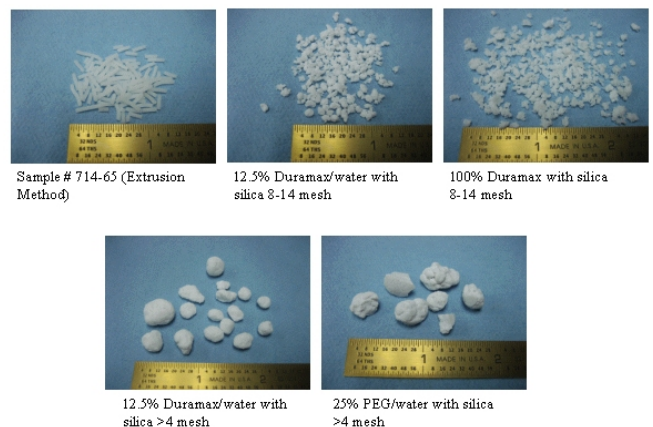

Figure 2. Sorbent pellets made by the disc pelletizer.

formulations of binders and active chemicals that will produce the strength and integrity, as well as the adsorption capacity, required for this application.

Selection of Sorbent Support

One of the most critical factors in selecting the appropriate silica support material was the number of hydroxyl groups (-OH) per surface area in nm^2 of silica surface since these sites are responsible for interaction with and anchoring of the active ingredient. Previously, we also showed that the abundance of the -OH groups in the parent material leads to a better, vacuum regenerable sorbent to control moisture levels. In this work, we established a procedure to identify the number of -OH groups in the materials of interest. The silica surface consists of a combination of different types of hydroxyl groups (i.e. isolated silanol groups – SiOH and geminal silanols – $\text{Si}(\text{OH})_2$) and of siloxane bridges. The number of factors influences the relative concentration of these groups including calcination temperatures, ambient humidity and storage time (Ek, 2001). In addition, all types of surface hydroxyl groups can adsorb water via either physisorption or by forming a hydrogen bond with a water molecule. We used the Fourier Transform Infrared (FTIR) method to measure the hydroxyl group content of the selected silica material. Cab-O-Sil HS-5 (supplied by

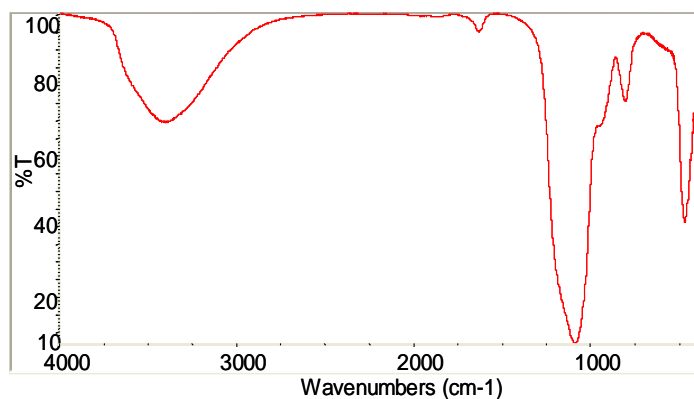

Figure 3. FTIR spectrum of untreated Cab-O-Sil HS-5 material. Cabot Corporation).

Figure 3 shows the FTIR spectrum of untreated Cab-O-Sil HS-5 silica sample. The sample was prepared by using the standard KBr pellet method. In addition, a blank KBr pellet was used as a background. The sample compartment was flushed with Ar prior to

obtaining the sample spectrum to remove carbon dioxide and water. The spectrum was then recorded with 1 cm^{-1} resolution using 32 scans. It shows a strong absorption peak at 1092 cm^{-1} that can be assigned to the Si–O–Si group. This strong absorption peak is not symmetrical and has a shoulder in the area of 1200 cm^{-1} that is characteristic of amorphous silica. In addition, the sample has an absorption peak at 805 cm^{-1} that is also characteristic of the amorphous silica structure. However, the absorption peak at 1850 cm^{-1} that can be assigned to Si–O–Si lattice groups is so weak that it is difficult to distinguish it from the baseline. A small peak at 1625 cm^{-1} is due to the molecular water present in the sample. The broad peak in the $3700\text{-}2900 \text{ cm}^{-1}$ can also be partially assigned to the molecular water. This broad peak is a result of multiple absorptions that are broadened by the O–H stretching of water molecules in the sample. The O–H stretch of hydrogen bonded Si–OH groups show up in the region $3700\text{-}3500 \text{ cm}^{-1}$, while the O–H stretch of isolated Si–OH groups result in a sharp peak at 3750 cm^{-1} . Clearly, these peaks are disrupted and shifted by molecular water.

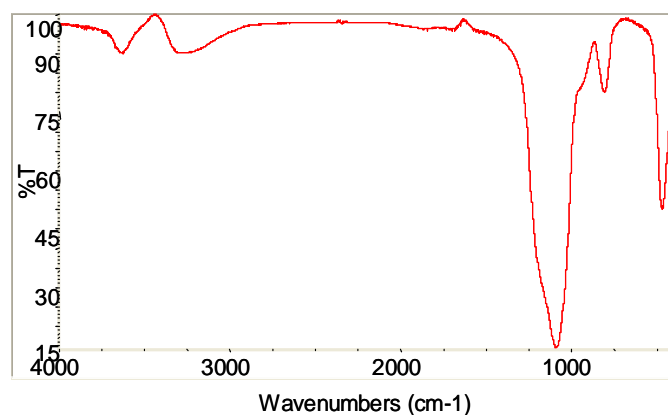

Figure 4. FTIR spectrum of the heat-treated silica sample.

The second FTIR spectrum (Figure 4) was run for the pretreated sample (the Cab-O-Sil sample was heated to 100°C and kept at temperature for five hours in order to remove adsorbed species). This spectrum exhibits several similarities with that of the untreated material. It has the same strong Si–O–Si absorption peak at 1092 cm^{-1} as well as the weaker absorption peak at 805 cm^{-1} . The peak in the $3700\text{-}3500 \text{ cm}^{-1}$ region can be due to hydrogen bonded Si–OH groups, however, we were not able to identify

the peak in the 3400-3000 cm^{-1} region. In addition, the spectrum shows no absorption peak at 3750cm^{-1} that is characteristic of isolated hydrogen bonds.

As part of these efforts we considered several commercially available high surface area silica materials as the possible candidates for the support material. Various silica products were identified and several samples were acquired for further testing as the possible candidates for improved adsorbent synthesis. Table 1 summarizes the physical

Table 1. Commercially available silica materials.

Product name	Surface area (m^2/g)	Pore volume (cc/g)	Pore diameter	(OH) groups / nm^2 of silica surface	Average particle size
Cab-O-Sil EH-5 (powder)	380	Non-porous	Non-porous	3.5 – 4.5 (7.85 groups max.)	0.2 – 0.3 μm (average particle aggregate length)
Cab-O-Sil HS-5 (powder)	325	Non-porous	Non-porous	3.5 – 4.5 (7.85 groups max.)	0.2 – 0.3 μm (average particle aggregate length)
EP 11 (granular)	360–450	1.8	180 Å	3.5 – 4.5 after treatment at 200°C	100 μm
ES 757 (microspheres)	280–350	1.6	195 Å	3.6 – 3.7 after treatment at 400°C	25 μm
ES 70Y (microspheres)	280–350	1.6	195 Å		95 μm
Aerosil 200 (powder)	200 ± 25	Non-porous	Non-porous	2 – 2.5	12 nm (covalent aggregates 60–100–200 nm)
Aerosil 380 (powder)	380 ± 30	Non-porous	Non-porous	2 – 2.5	7 nm (covalent aggregates 60–100–200 nm)
CS-2133 (granular)	350	2.39	272 Å	4.6	Median – 87 μm Vol.% < 46.2 μm = 19% Vol.% < 151 μm = 89%
MS-3030 (microspheres)	321	2.98	372 Å	4.6	Median – 85 μm Vol.% < 46.2 μm = 20% Vol.% < 151 μm = 94%
MS-3050 (microspheres)	517	2.99	231 Å	4.6	Median – 100.3 μm Vol.% < 46.2 μm = 14% Vol.% < 151 μm = 84%

properties of the selected silica materials.

Preliminary TGA Testing

For initial evaluations of the sorbent samples, we used thermogravimetric analysis (TGA). In a typical TGA test, a small amount of fresh sample was loaded into the TGA instrument and tested at the approximate desired temperature ($\sim 22\text{--}26^\circ\text{C}$) for ten cycles. The total cycle duration was set to ten minutes (a two-minute adsorption step and an eight-minute regeneration step). The instrument was set to alternate between the 2% CO_2/N_2 flow during adsorption and 100% N_2 flow during regeneration.

The TGA cycling details are given for sorbent 685-11 in Figure 5. The cycling results were reproducible during nine cycles performed. The CO_2 capacity of

the sorbent was measured at 1% wt. (lb of CO_2 adsorbed per lb of sorbent). As can be seen from the plot, the regeneration rate was (as it was the case for all tested samples) the limiting step and required a much longer period of time than the adsorption.

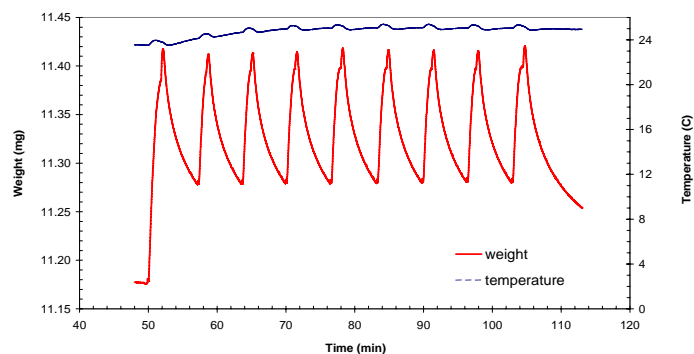

Figure 5. TGA cycling details for sample 685-11 dried at 60°C .

Bench-Scale Test Apparatus

We measured the performance of the new sorbent formulations under representative PLSS operating conditions, in an automated test apparatus. Our old bench-scale reactor setup allowed for single-pass flow tests at only ambient pressures. Figure 6 presents a process and instrumentation diagram and Figure 7 shows a picture of the test apparatus.

The test unit contains two sorbent beds, alternatively switching positions between adsorption and regeneration to conduct very rapid and continuous swing operations. Two vacuum pumps capable of maintaining low pressures allow operation of the low pressure ventilation loop and generate hard vacuum to closely simulate regeneration to space. In the test unit, the gases are re-circulated in the breather loop with continuous gas analysis at the inlet and exit of

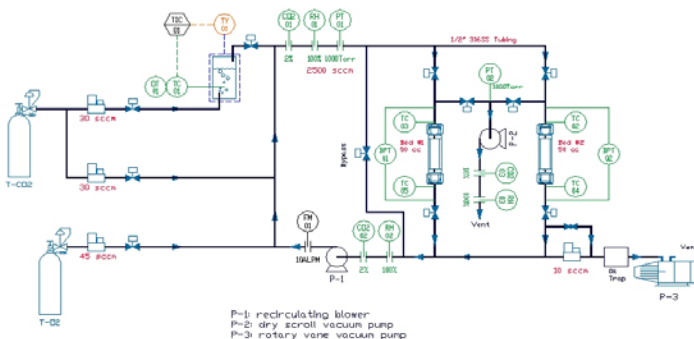

Figure 6. P&ID for bench-scale apparatus.



Figure 7. Bench-scale test apparatus.

the beds provided by passive, sensitive and highly reliable analytical instruments (humidity, CO₂, and ammonia sensors that are accurate and reliable at low pressures).

The recycle blower is used to circulate up to 7 acfm of mostly nitrogen or oxygen (diluent) through the system (for the small-scale tests the flow is 0.35 acfm). While the flow of adsorption gas is directed through Bed 1, sorbent in Bed 2 is regenerated under vacuum. A separate vacuum pump is used to create a desired pressure in the system. Periodically, a series of valves are activated to switch the bed functions. The CO₂ gas stream simulating the metabolic CO₂ production in the breather loop is introduced into the system via a mass flow controller. Oxygen or nitrogen is also introduced into the system to simulate the gas lost due to suit leakage. These diluent flow controllers can be used to adjust the gas flow rates of one or two streams (a wet stream, when used, that is directed through the heated water sparger and a dry stream) to achieve the required humidity level in the system. Alternatively, we have the ability to inject water with a syringe pump to achieve the required humidity at lower flow rates.

In this design, each sorbent bed is capable of holding up to 50 cubic centimeters (cc) of sorbent. The use of two beds allows easy determination of actual loop CO₂ partial pressures based on sorbent

performance and representative ullage losses. The unit design allows testing both small and large-scale. Small-scale tests (the results of which are included in this paper) enables quick screening of small quantities of sorbent without having to produce a large quantity of a material. It is also possible to quickly modify the test system in a way that makes it possible to demonstrate full-scale operation with the use of sorbent beds to hold approximately 1200 cc of material (our preliminary calculations based on the sorbent performance indicates that full-scale system should require approximately 1125 cc of sorbent). The new sorbent beds are constructed from borosilicate glass with minimal mass to allow thermal properties to be determined. This will allow us to see the temperature effects of the adsorption and desorption which are indicative of how strongly bonded the water vapor and CO₂ are to the sorbent.

The system is designed to operate at pressures ranging from 3.0 to 15.0 psia. The pressure in the apparatus is controlled by balancing the flow of N₂/O₂ entering the system and the flow of gas being pumped out of the system by a separate vacuum pump. This is controlled by either specifying a simulated leak rate out of the system and then maintaining the loop pressure by automatically adjusting the inlet diluent gas, or specifying the inlet gas flow and the leakage to maintain the desired pressure. Most tests were performed with the leakage rate being set to a constant value representative of the actual EMU leakage rate. To conduct the regeneration step under simulating hard vacuum conditions, a dry mechanical scroll type vacuum pump is used to maintain the system pressure below 1 torr (typically around 1 torr in the sorbent bed during regeneration). The use of dry mechanical pumps allows analytical measurements of gases without contamination by pump oil. The recirculation in the loop is accomplished using a diaphragm pump controlled with a variable frequency drive. This setup allows us to specify the amount of recycled gas based on system pressure. By using this closed-loop setup we can immediately see the build-up effects of CO₂ due to breakthrough. The return loop CO₂ partial pressure, perhaps the most important factor in the operation of CO₂ control method, was measured on a real system mock-up.

For accurate quantification of the H₂O adsorption capacity of the sorbent, a chilled mirror humidity

sensor is used; a thermoelectric pump is used to cool a mirror that reflects light back to the sensor. When the mirror temperature reaches the dew point temperature of the gas stream, the light detector senses the dew on the mirror, then the mirror temperature is maintained to keep the amount of dew on the mirror constant. This type of sensor is unaffected by the low operating pressure of the system. Knowing the system temperature and pressure will allow us to accurately calculate the relative humidity and absolute water vapor content of the gas stream. The CO₂ sensor is based on IR absorbance. We updated our current sensor by adding an external programming feature that would allow us to calibrate the sensor under low operating pressures. As part of our work, we also investigated the potential of a vacuum-regenerable ammonia sorbent to remove the metabolic ammonia load from the re-circulation loop. In order to measure the stability of our sorbents we installed a Thermo Fisher Scientific, Inc. ammonia analyzer in the system. We also upgraded the software program that is used to control test conditions, log analytical data, and safely shut down the apparatus in case of a malfunction. The new Programmable Automation Controller (PAC) system is much more flexible and user friendly compared to the previously used Control EG software. The new system provides a simple graphical user interface and data control and collection via ethernet. The automated control also allows for changing the CO₂ and H₂O injection rates to simulate the EVA metabolic load profile.

Bench-Scale Testing

The sorbents tested were weighed and loaded into two identical beds to facilitate a continuous, closed-loop evaluation. A minimum of 120 cycles were performed, while the flow rates and CO₂/H₂O concentrations were varied as well as the half-cycle times as desired in every 120 cycle-test. At the completion of the half-cycle, the automated apparatus would switch the required valves to divert the contaminants onto the fresh bed and regenerate the loaded bed. At the beginning of this period, we conducted tests by injecting a constant feed of CO₂ and then measured the capacity and loading of the sorbent. Figure 8 shows an example of one of these cycling tests. The test was conducted in a closed-loop manner to simulate the actual space suit environment. In this test, the capacity of the sorbent

was measured to be approximately 1.3% and the bed outlet CO₂ partial pressure cycled between 2 and 6 Torr. The half-cycle time in this test was set to 10 minutes.

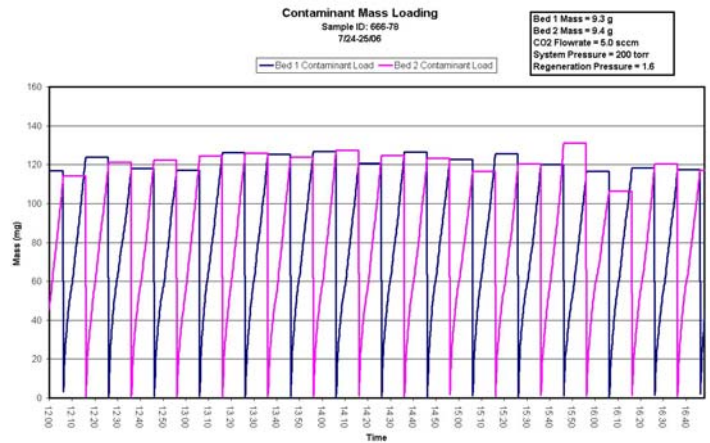

Figure 8. Test profile for an experiment with constant CO₂ feed.

To better simulate an actual EVA, we programmed the 8-hour metabolic loading profile into the automation software (Figure 9). This profile was developed by providing a range of metabolic loads ranging from 350 to 2000 BTU/hr with an average of 850 BTU/hr.

We correlated this profile to the required volumetric flow rate for our system based on our target screening bed volume of 50mL of sorbent. By doing so, we were able to get a better overall performance measurement of the sample being tested. With 50 mL of sorbent material loaded into each reactor bed,

EVA Metabolic Load Profile

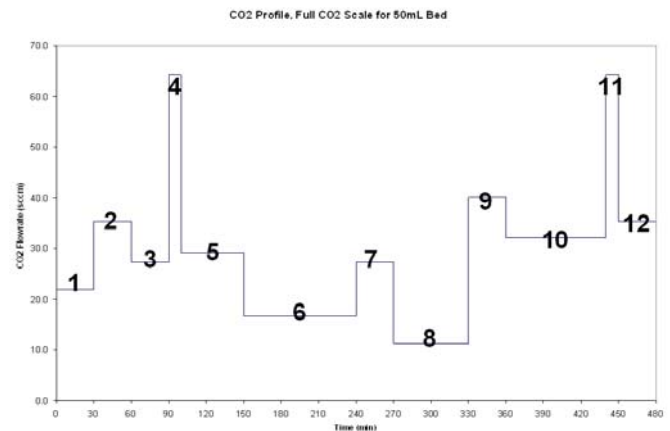

Figure 9. Metabolic load profile.

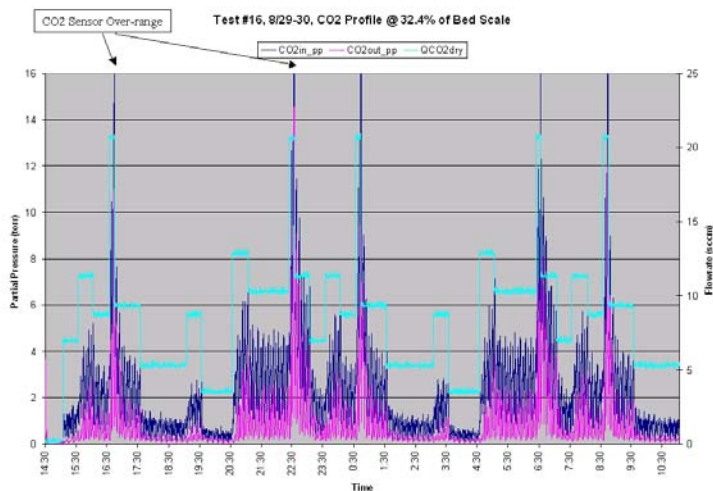

Figure 10. Testing under metabolic profile.

we would then follow this profile continuously for the duration of the cycling test (typically 120 cycles). We performed several of these tests with the CO₂ flow rate into the system varying by the required metabolic loading. Figure 10 presents the data from one of these tests. In this test, the CO₂ flow rate into the system was limited to 1/3 the required amount as a base test to verify the sorbents ability to maintain outlet CO₂ partial pressures less than the required 7.6 torr (15 torr at the high metabolic rates). This graph shows the system CO₂ partial pressures being maintained well below the allowable 7.6 torr.

Water Adsorption Tests

We injected water vapor into the re-circulation line to increase the humidity of the system and determine the water capacity of the sorbent. The humidity level in the gas was measured before and after the sorbent beds using chilled-mirror hygrometers. The hygrometers output the dewpoint to the automation software with a range of -50 to 50°C. The software then calculated (based on dewpoint, pressure and temperature) the mass flowrate of water into and out of the beds. Figure 11 shows the loading of water on 50mL of sorbent. The average water production rate during EVA is reported as 0.2 pph or 1.5 mL/min. To absorb the required amount for a 1/24 scale bed the sorbent should have removed 60 mg/min. This shows that with this test, we are about two-thirds of the full-scale water removal requirement. In future tests, we will increase our water injection to determine the sorbent's full capacity.

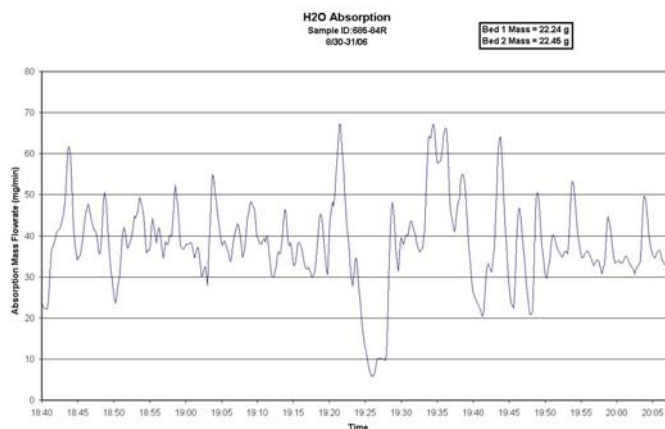

Figure 11. Water adsorption.

CONCLUSIONS

TDA developed a new, regenerable adsorbent for CO₂ and H₂O removal from the PLSS. The sorbent can be regenerated by pressure swing only without the need to increase the bed temperature. We showed that the sorbent maintains its activity over extended cycling under representative conditions.

ACKNOWLEDGMENTS

The authors acknowledge the funding provided for the research by NASA Lyndon B. Johnson Space Center (Contract No: NNJ06JA35C).

REFERENCES

1. Fullerton, R., "Advanced EVA Roadmaps and Requirements", SAE 2001-01-2200, 2001.
2. Butler, L.B., Fascza, J., and G. Thomas, "Development Status of the Metal Oxide Regenerable CO₂ Removal System for the NASA EMU", SAE 972505, Nevada, July 1997.
3. NASA, "STS-102 Post-mission Summary, <http://spaceflight.nasa.gov/shuttle/archives/sts-102/index.html>", March, 2001.
4. Dean, C., T. Filburn, and G. Thomas, "Development of a Prototype Pressure Swing Carbon Dioxide/Water Removal System For an Advanced Space Suit", SAE 981673, Danvers, Massachusetts, July 13-16, 1998.
5. Ek, S., Root, A., Peussa, M., and Niinisto, L., "Determination of the Hydroxyl Group Content in

Silica by Thermogravimetry and a Comparison with ^1H MAS NMR Results”, *Thermochimica Acta*, **379**, 201-212, 2001.

6. Goldfarb, J., and E. Hodgson, “Advanced, Lightweight, Space Suit Primary Life Support System for Mars Exploration”, SAE 2001-01-2167, 2001.
7. Hodgson, E.W., and T. Guyer, “An Advanced EVA System for Planetary Exploration”, SAE 981630, Danvers, Massachusetts, July 13-16, 1998.

CONTACT

Dr. Gökhan O. Alptekin
Principal Investigator
TDA Research, Inc.
12345 West 52nd Avenue
Wheat Ridge, CO 80033
Phone: (303) 940-2349
Fax: (303) 422-7763
Email: galptekin@tda.com