



# *Progress in Spacecraft Environment Interactions: International Space Station (ISS) Development and Operations*



## **International Space Development Conference**

**Dallas, Texas, USA; May 26, 2007**

**Steve Koontz, Robb Suggs, Todd Schneider, Joe Minow, John Alred,  
Bill Cooke, Ron Mikatarian, Leonard Kramer, Paul Boeder, Carlos Soares**

**Environments Working Group**

**Vehicle Integrated Performance, Environments, and Resources (VIPER)**

**International Space Station Program Integration Office**





# Presentation Outline

## Purpose

*To report progress in understanding of spacecraft-environment interactions resulting directly from International Space Station (ISS) development and flight operations*

## Agenda

*Spacecraft Environment Interactions; why do we care?*

- 1) *Safety, Reliability, and Mission Success*
  - a) *ISS system performance verification before flight*
  - b) *Flight operations planning and anomaly resolution*
  - c) *Capture of new knowledge and tools for application to future programs*

*The ISS Space Flight Environment*

- 1) *Environment factors affecting spacecraft systems*
- 2) *ISS flight environments*

*Progress in Spacecraft-Environment Interactions*

- 1) *ISS driven knowledge and products*

*Value to future space exploration programs*

*Floating Potential Measurement Unit (FPMU)*



*The Floating Potential Measurement Unit (FPMU) just after installation, Aug. 3, 2006*



# *Spacecraft Environment Interactions*

## *Why do we care?*

- **Safety, Reliability, and Mission Success**
  - ◆ **Verification of spacecraft design through the mission life cycle environments**
  - ◆ **Which space environment processes or factors can affect:**
    - ☞ *Critical Must-work/Must-not-work system performance requirements?*
      - ☞ *Guidance navigation and control*
      - ☞ *Communications*
      - ☞ *Avionics reliability*
      - ☞ *Propulsion control*
      - ☞ *Structural integrity*
    - ☞ *Requirements for longevity of spacecraft materials and components?*
      - ☞ *Thermal control surfaces*
      - ☞ *Photovoltaic power systems*
      - ☞ *Windows and optics*
      - ☞ *Spacecraft structure*
- **Whenever possible, detrimental spacecraft-environment interactions are identified and eliminated early in spacecraft design and development – minimize cost/risk**
- **Any remaining detrimental spacecraft-environment interactions must be actively managed with specific hardware and procedures**



# *The ISS Space Flight Environment*

- **Meteors and orbital debris**
- **EMI/EMC**
- **Ionizing radiation**
  - ◆ **Galactic cosmic rays**
    - ☞ *geomagnetic shielding*
  - ◆ **Trapped Radiation (Van Allen Belts)**
  - ◆ **Solar Energetic Particle Events**
    - ☞ *geomagnetic shielding*
- **Ionospheric Plasma (spacecraft charging)**
- **Auroral electrons (spacecraft charging)**
- **Geomagnetic field (spacecraft charging and radiation environment)**
- **Solar UV/VUV**
- **Neutral atmosphere**
  - ◆ **Atomic Oxygen**
- **Thermal vacuum**
- **Spacecraft Induced Environments**
  - ◆ **Secondary particle radiation environments (structural shielding mass - cosmic ray interactions)**
  - ◆ **Floating Potential (magnetic induction and SAW driven charging)**
  - ◆ **Surface contamination from materials out-gassing**
  - ◆ **Surface contamination/erosion from thruster plume impingement**
  - ◆ **Surface contamination/mechanical damage from fluid venting stream impingement or re-contact**

# The Geospace Environment

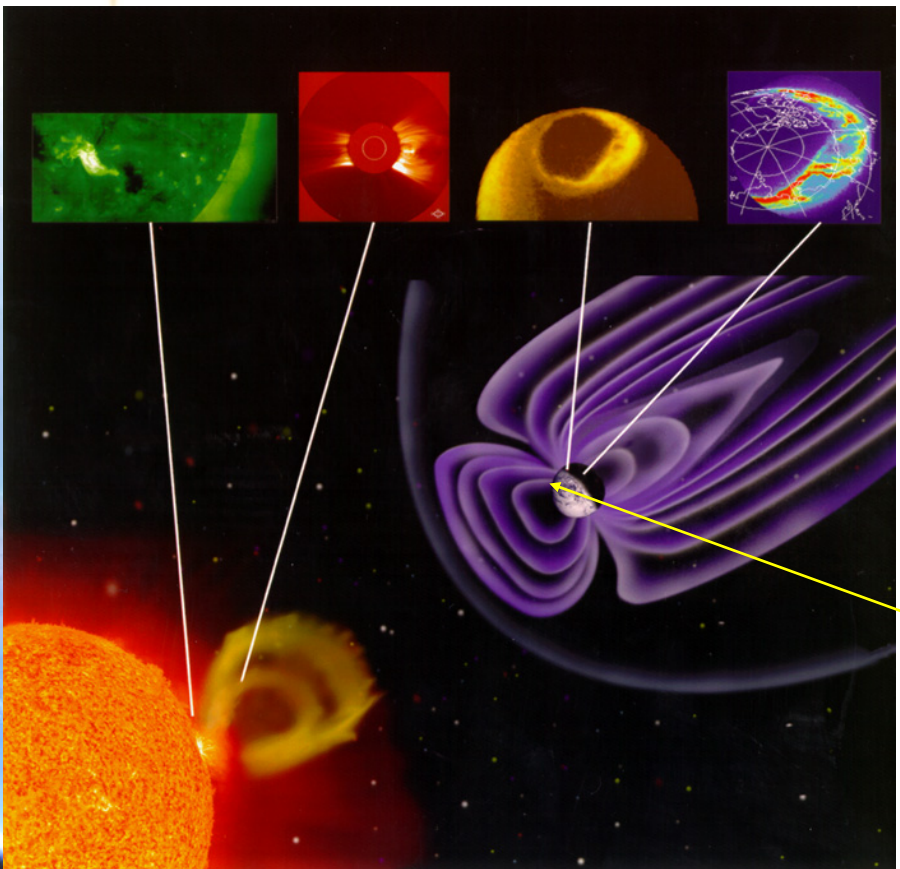

Source, NASA GSFC LWS

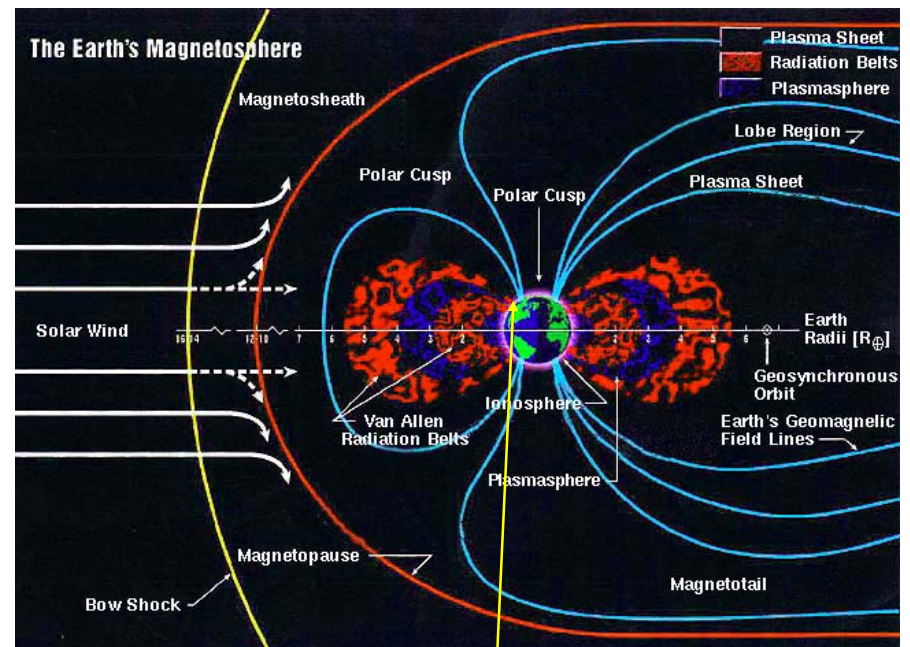

Source, NASA MSFC Space Environments Effects Program

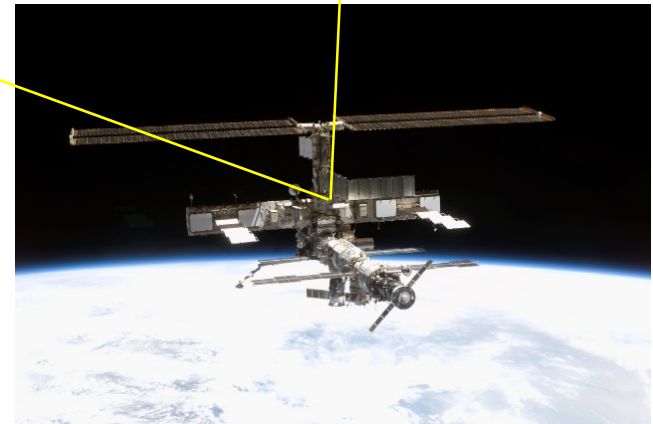

Source, NASA JSC, ISS Program Office



Magnetic Field Strength (Gauss) at 400 km, IGRF 1995

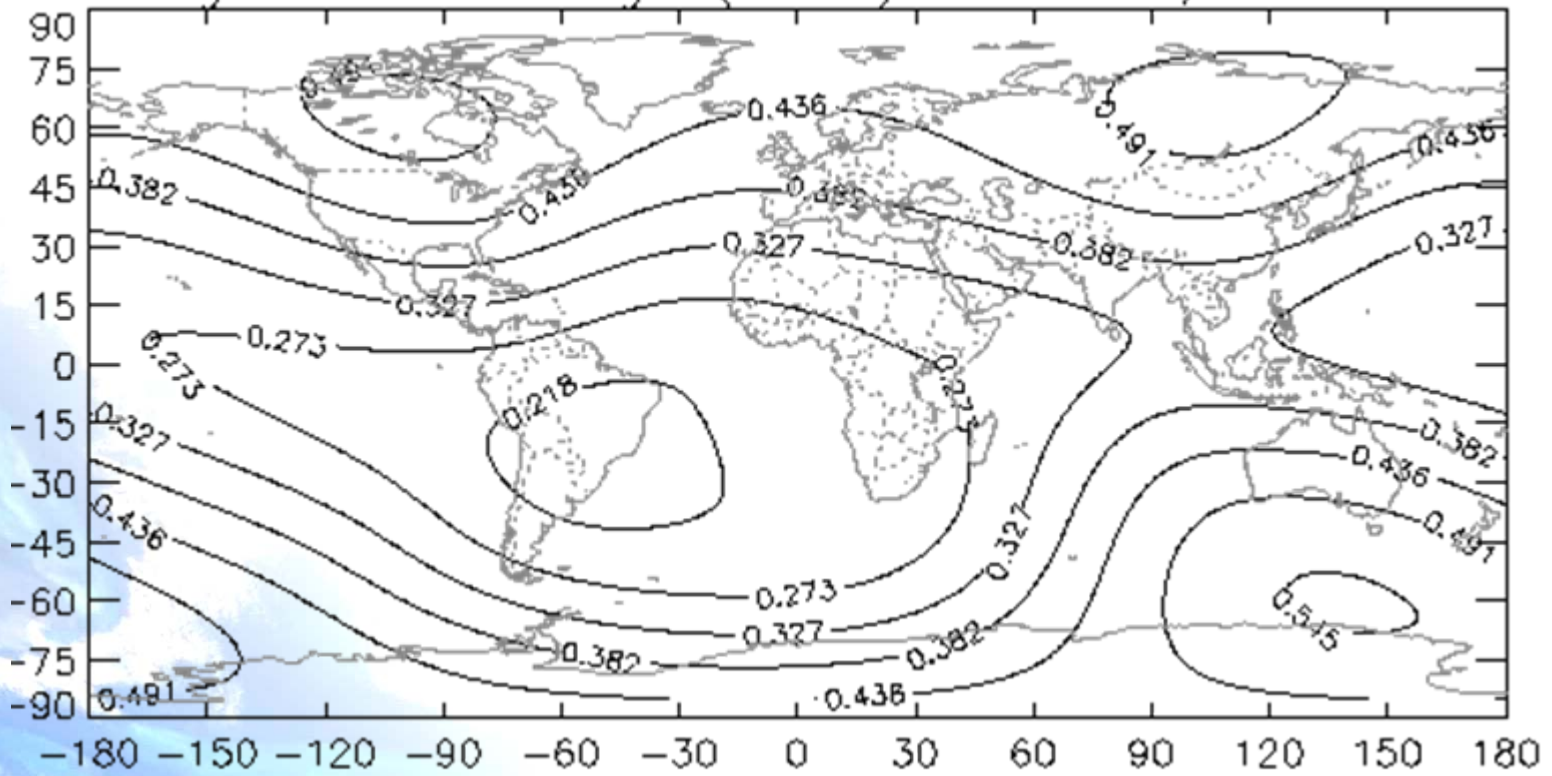

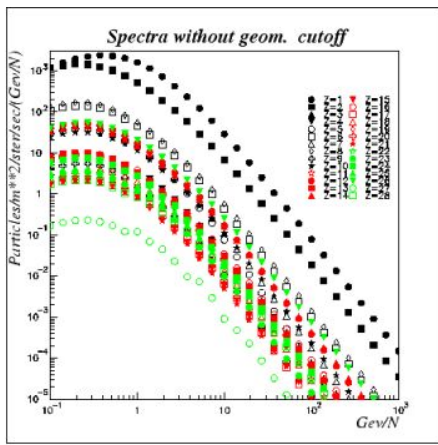

Figure 2: Cosmic ray fluences with no geomagnetic cutoffs

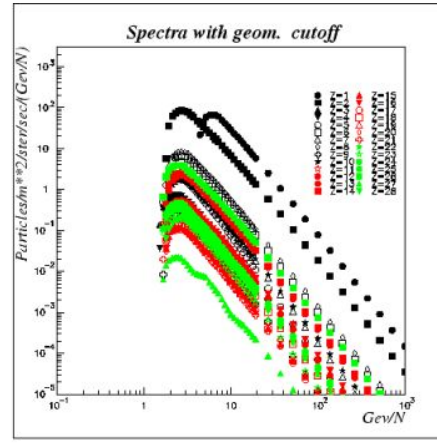
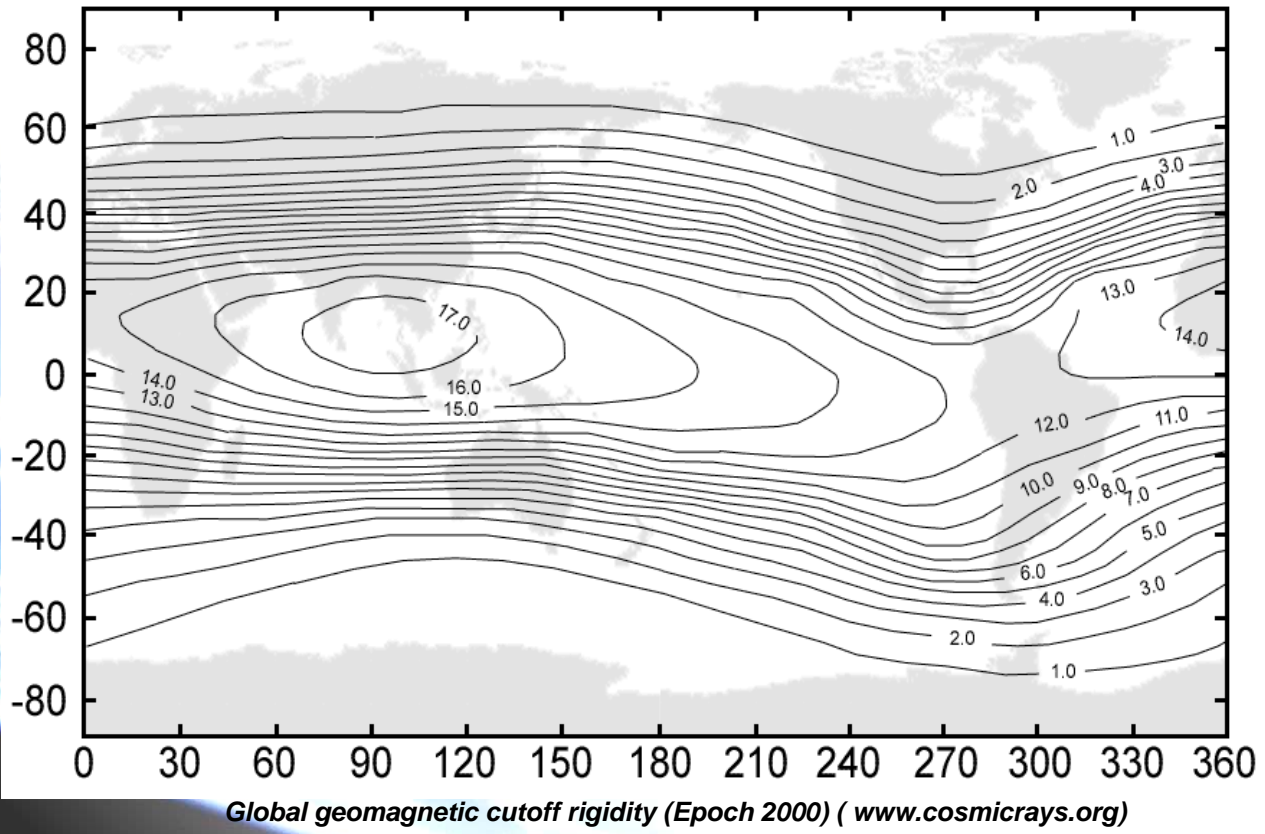

Figure 3: Cosmic ray fluences for an intermediate geomagnetic latitude

Ferrari, A., Sala, P. R.;  
 "Treating High Energy  
 Showers," in Proceedings of  
 the "Training Course on the  
 Use of MCNP in Radiation  
 Protection and Dosimetry",  
 Bologna - Italy, May 13-16  
 1996, G.~Gualdrini and  
 L.~Casalini eds, ENEA ISBN  
 88-8286-000-1, p 231-261  
 (1998)



Global geomagnetic cutoff rigidity (Epoch 2000) ([www.cosmicrays.org](http://www.cosmicrays.org))

# Radiation Belts near ISS nominal operations altitude ( worst case design/verification environment)



**Trapped radiation: Protons  
at 500 km altitude (SEE and  
TID to materials and  
electronics)**

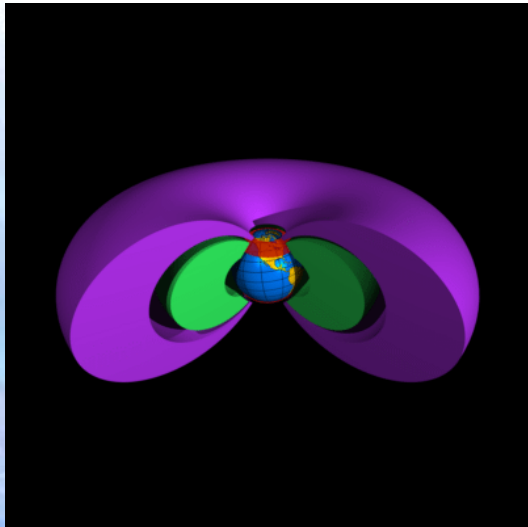

**Trapped radiation: Electrons  
at 500 km altitude (near  
surface TID to materials and  
PV cells)**

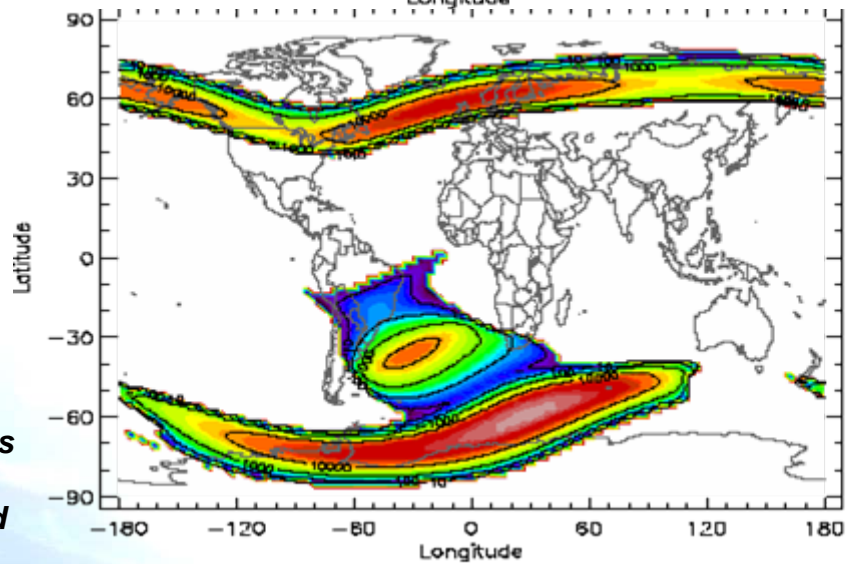
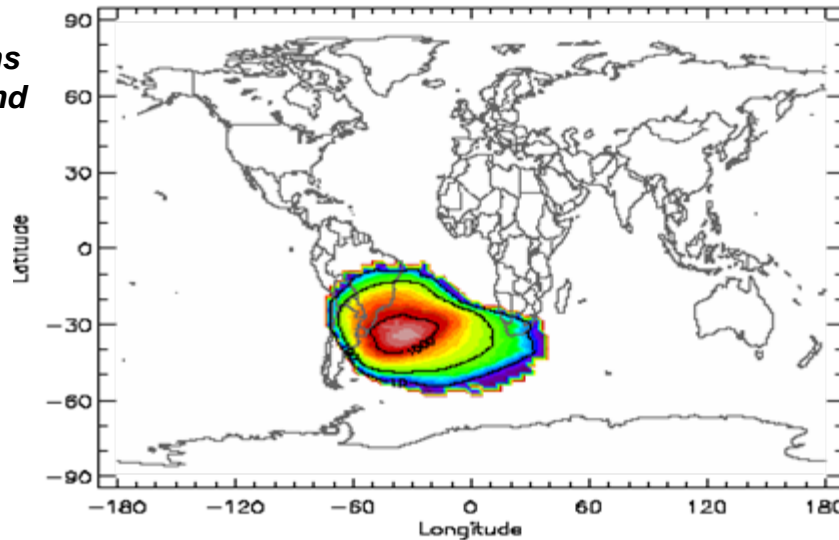

Source – ESA/SPENVIS



## LET Flux Comparison - Interplanetary vs LEO at 28.5 deg &amp; 51.6 deg

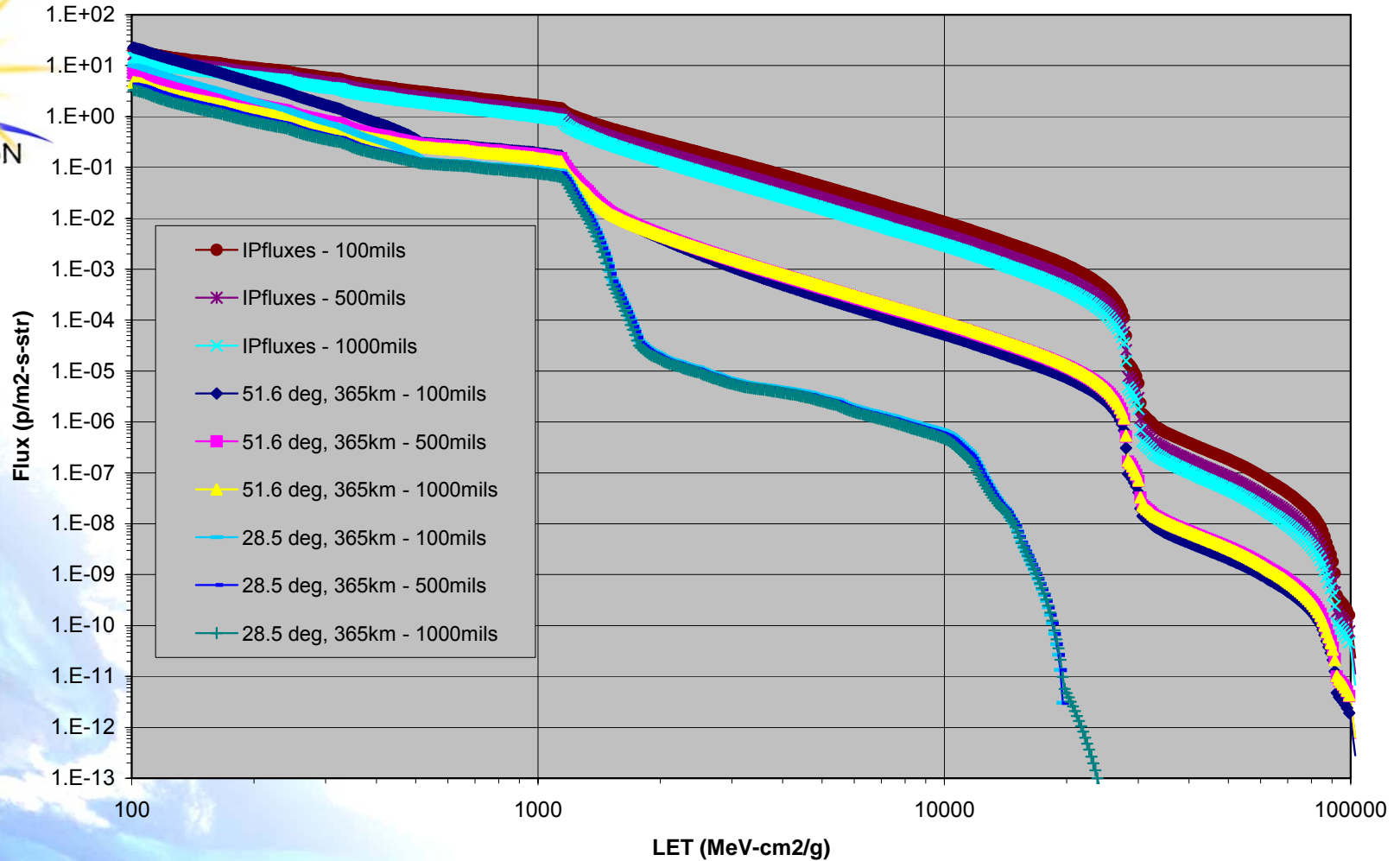

**CREME-96 calculations with shielding mass as mils Al in a spherical configuration. Note that the shielding mass range is low for any manned spacecraft. 1000 mils Al = 7 grams/cm<sup>2</sup>. ISS nominal shielding mass inside the US Lab or Service Module is on the order of 40 grams/cm<sup>2</sup>. However, secondary particle production by cosmic ray interaction with structural shielding materials makes thicker shielding less effective.**



# Single Event Effects

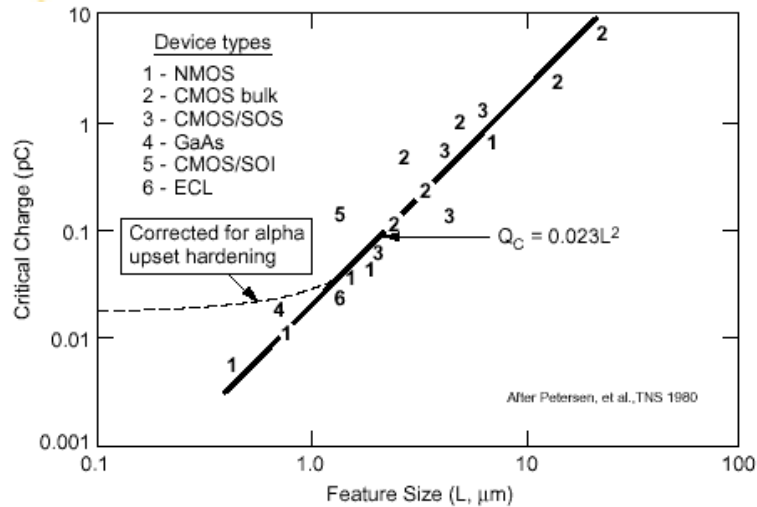

**Ionizing particle passage through solid state device generates charge carriers causing single event: 1) upset, 2) latch-up, 3) gate rupture, 4, burn-out, and 5) transients**

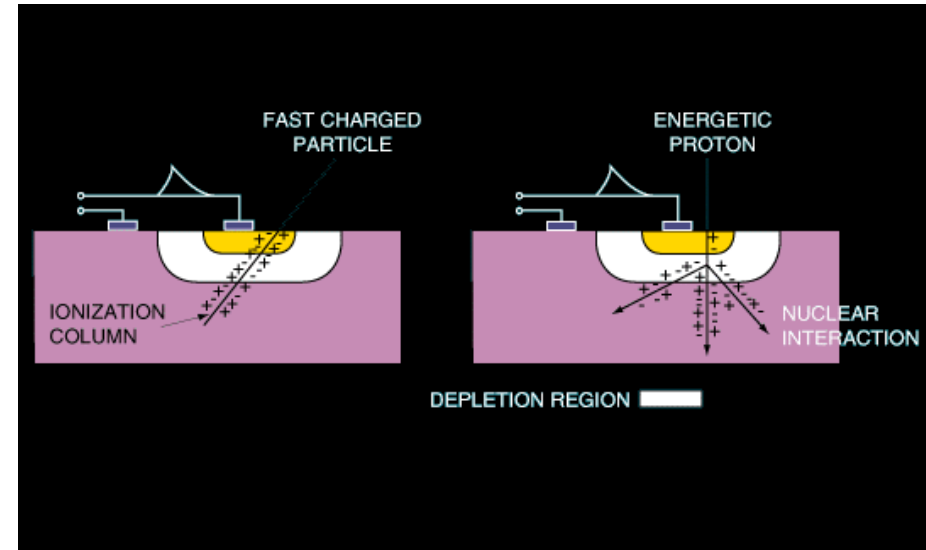

**Fast charged particle and proton (neutron) initiated nuclear reactions**

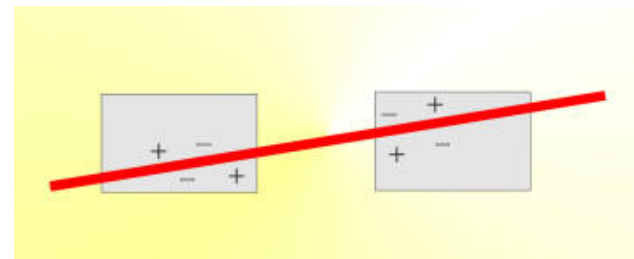

**Depending on the tract, one charged particle can upset more than one device**

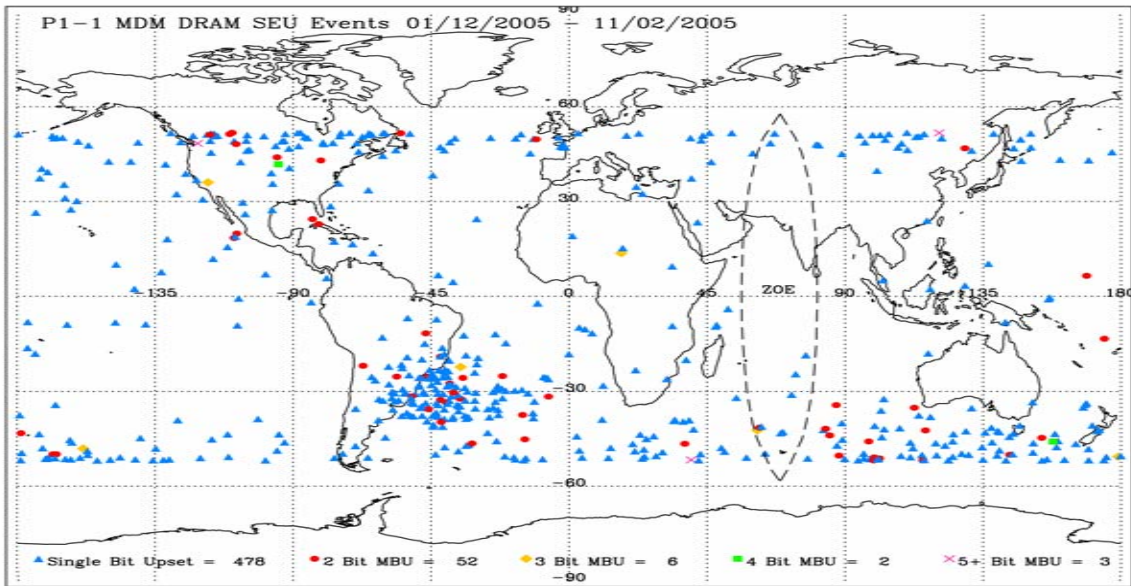

Notes:  
 1) 'ZOE' denotes TDRSS Zone of Exclusion.  
 Data dropouts likely in this region.  
 2) 'MBU' = Multiple Bit Upset.

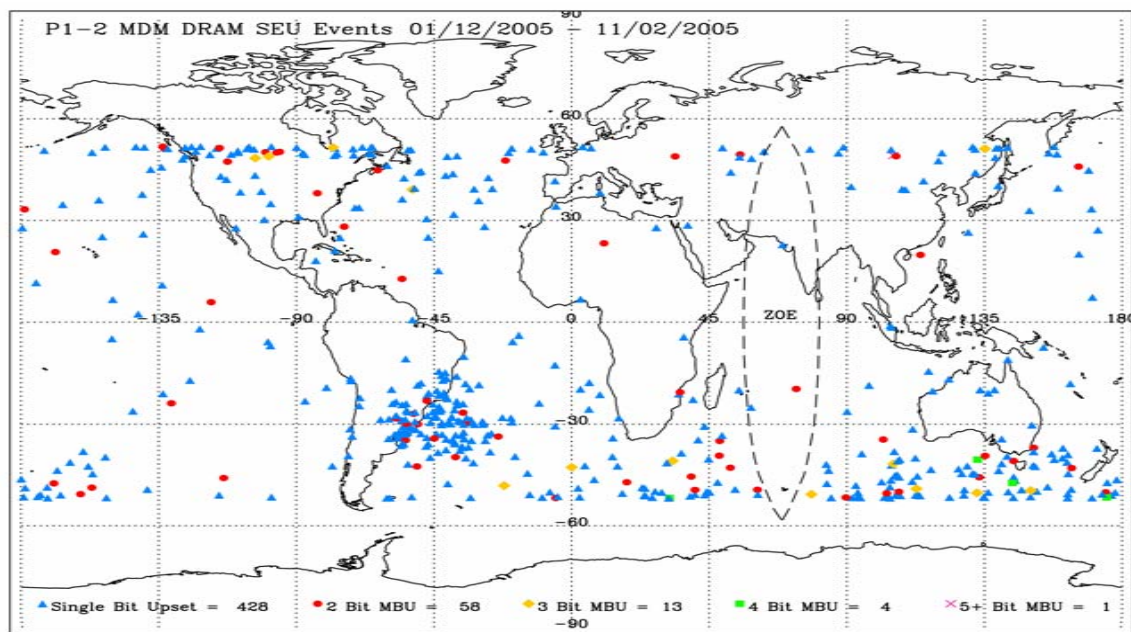



# Induced SEE Environment: ISS Multiplexer/De-multiplexer MDM CMOS DRAM Performance - Shielding Mass Effects

*ISS Internal/External MDM DRAM soft upset events and comparison of on-orbit rates with predictions of Scott Effective Flux Approach (SEFA) and FOM approach using median shielding values for the MRQ estimate (on-orbit count is the total count including correctable multi-bit events)*

<b>MDM: Median Shielding</b>	<b>On-orbit SEU Count SEU/238 days</b>	<b>SEFA SEU Count SEU/238 days</b>	<b>FOM SEU Count SEU/238 days</b>
<b>Lab-1: 40 g/cm<sup>2</sup></b>	<b>488</b>	<b>966</b>	<b>468</b>
<b>Lab-1: 40 g/cm<sup>2</sup></b>	<b>490</b>	<b>966</b>	<b>468</b>
<b>P1-2: 10g/cm<sup>2</sup></b>	<b>536</b>	<b>6309</b>	<b>1673</b>
<b>S1-1: 10g/cm<sup>2</sup></b>	<b>488</b>	<b>6309</b>	<b>1673</b>

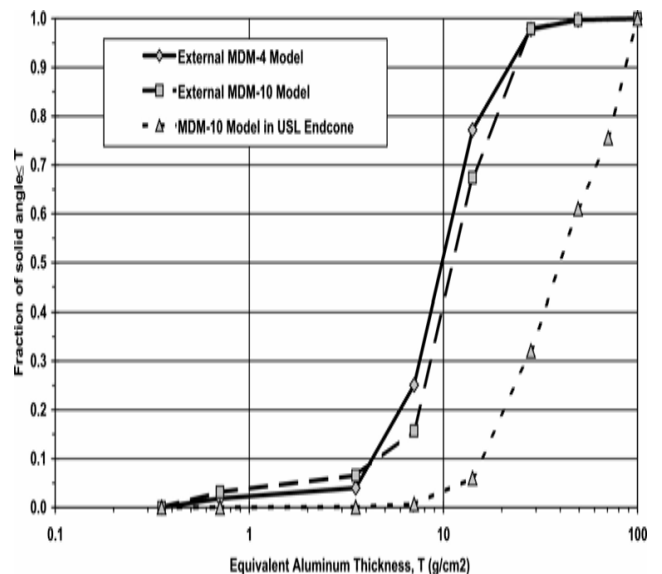

**MDM 1Mx4 DRAM Structural Shielding Distributions.**

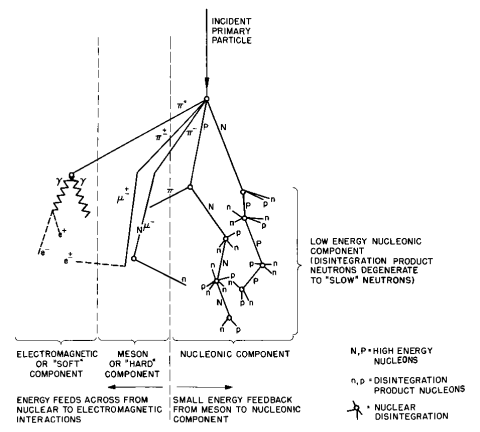

Schematic Diagram of Cosmic Ray Shower



2005-2006 SDRAM Bit Error Location Map

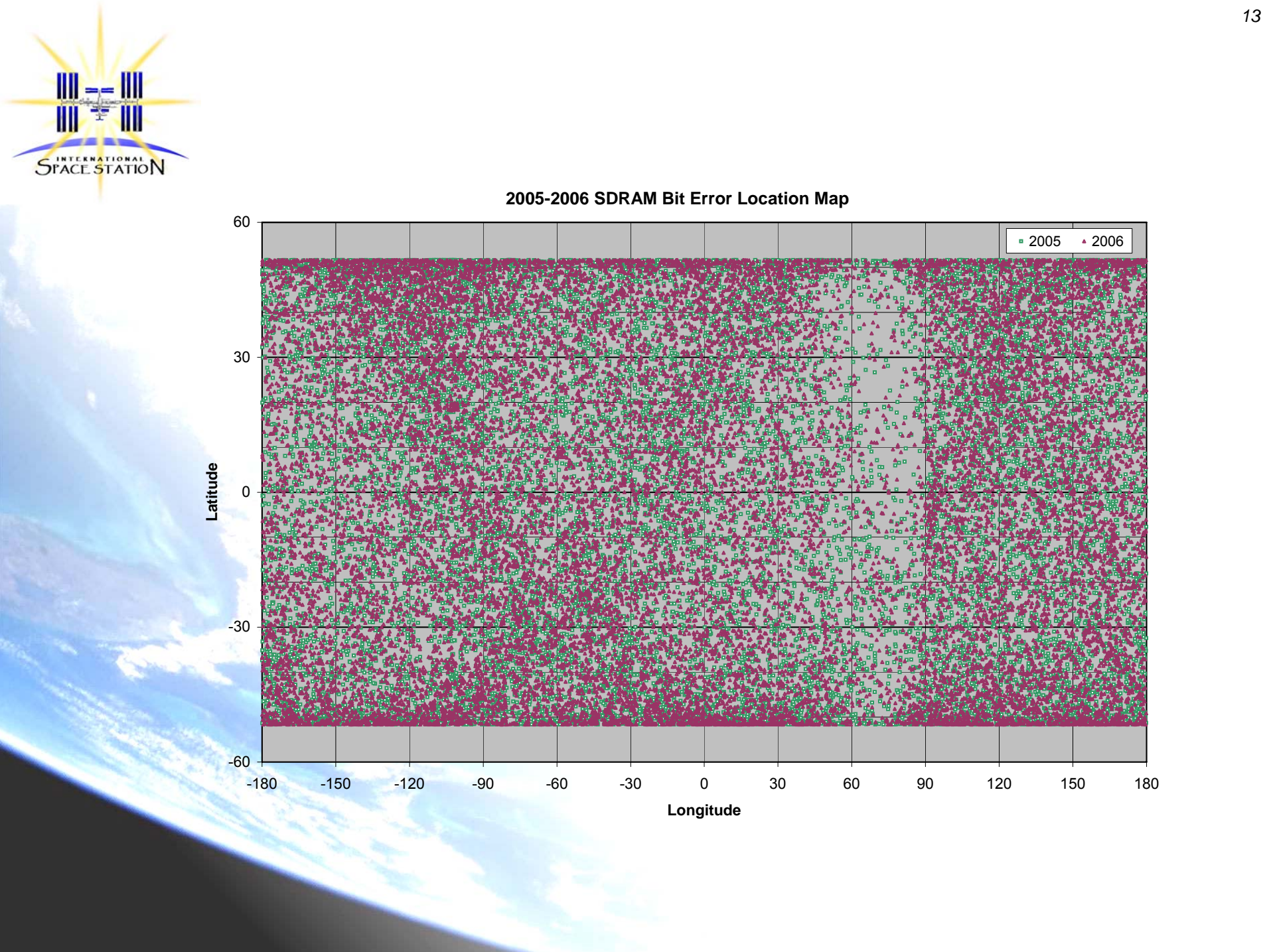
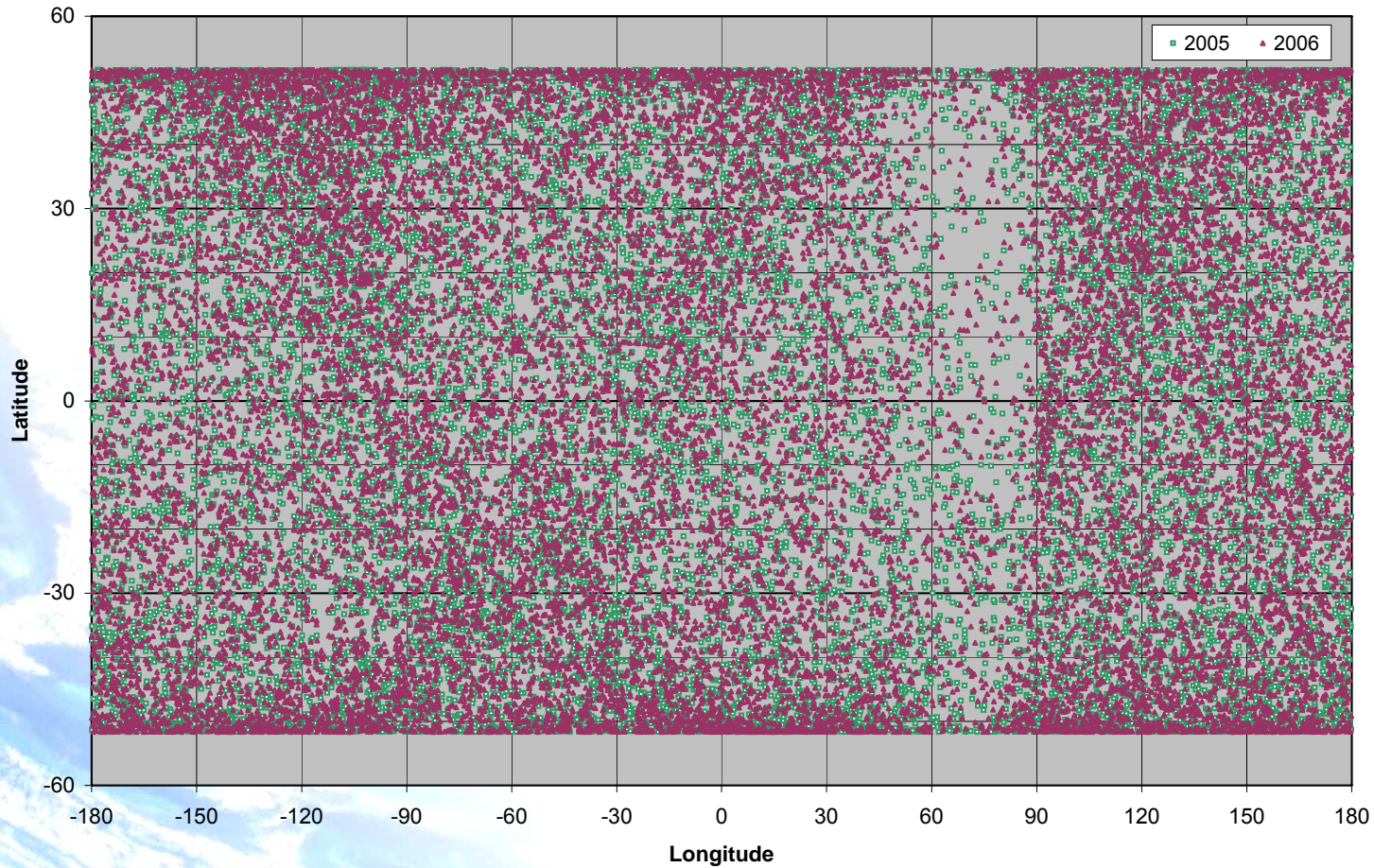



## ISS Neutral Atmosphere Environment

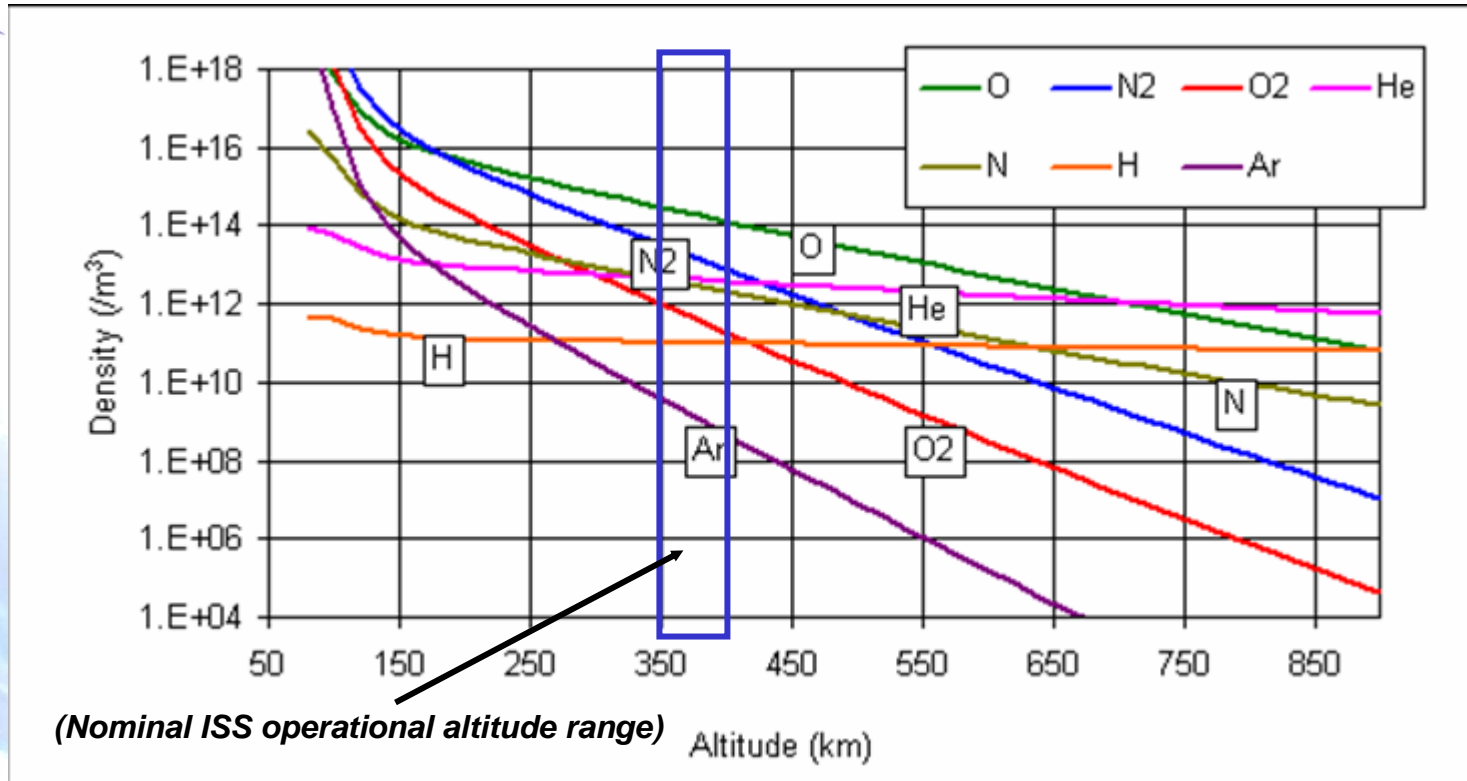

Variation of the MSISE-90 mean concentration profile of the atmosphere constituents N<sub>2</sub>, O, O<sub>2</sub>, He, Ar, H, and N with altitude for mean solar and geomagnetic activities (ESA/SPENVIS)



# *Surface degradation of exposed external materials*

- ***Atomic oxygen***

- ◆ ***Materials reactivity and erosion rates***

- ☞ *Select non-reactive materials whenever possible*

- ◆ ***Development of protective coatings and less reactive materials***

- ***Solar UV/VUV***

- ◆ ***Near surface photochemical damage***

- ***Ionizing radiation (Van Allen Belt trapped electrons)***

- ◆ ***Near surface radiochemical damage***

- ***ISS has experienced no serious failures attributable to these causes during the first 10 years of flight***



# Flight 12A.1 ISS attitude control anomaly

## Geomagnetic storm driven neutral atmosphere density change

**Dec. 15, 2006**

### Conditions:

- Unusual solar activity during Flight 12A.1 resulted in a major coronal mass ejection (CME) which impacted the Earth late on December 14, 2006.
- CME impact produced a twelve hour period of severe geomagnetic storming ( $K_p > 6$ ).

Observed F10.7 and Ap Values					3-Hourly Kp								daily
Year	Day	Julian Day	Daily F10.7	Trailing 81day F10.7 average	0-3	3-6	6-9	9-12	12-15	15-18	18-21	21-24	Ap
2006	14	348	93.4	81.9	3.0	2.3	2.0	2.0	5.0	5.3	5.3	7.7	47
2006	15	349	87.1	82.1	<b>8.3</b>	<b>7.7</b>	<b>6.7</b>	5.7	6.0	4.0	4.0	3.7	94
2006	16	350	82.3	82.3	3.0	3.3	1.3	1.3	0.7	2.7	3.3	3.3	12

### GN&C Activities

- Momentum manager startup attempted on December 15, 2006 at ~01:34UT and ~03:11UT.
  - Both times momentum rose above 90% and flight controllers moded ISS to thruster control.
- CMG control restored at 21:40UT on December 15, 2006.

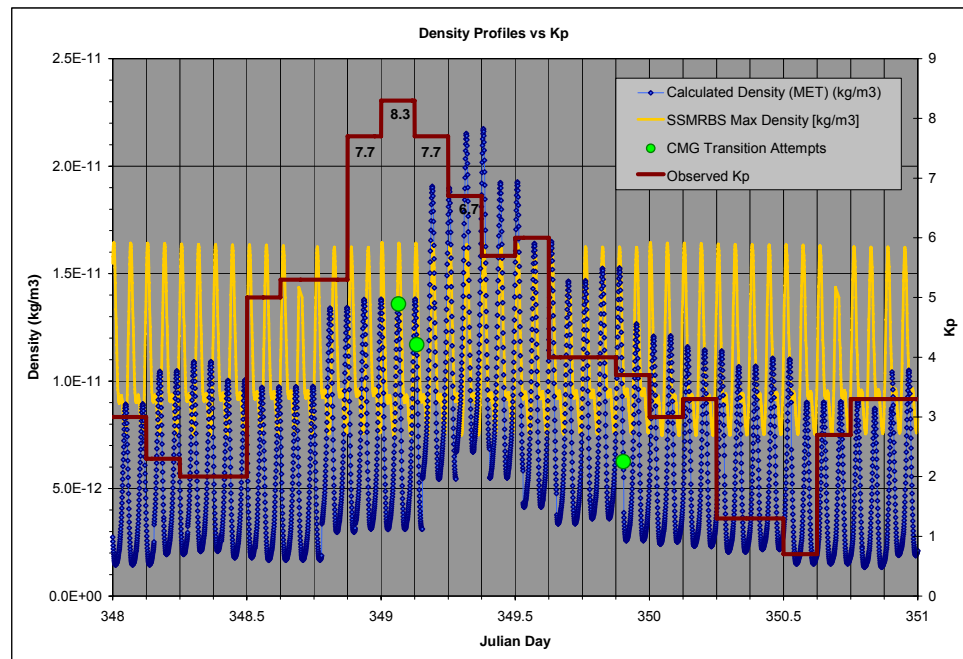





## *MSFC Short-Term Atmospheric (Solar) Prediction Tool*

- ***Used for ISS altitude planning in the 90 - 180 day time frame.***
- ***Uses statistical properties of variations of solar flux, F10.7, at different points in the solar cycle.***
- ***Design Atmosphere (SSP30425) provides little latitude for taking of advantage of decreased solar activity.***
- ***MSFC monthly predictions are 13-month smoothed and react slowly to large changes in solar activity.***
- ***Existing short-term predictions are shown to be as hit or miss as the long-term predictions.***

# Monthly deviations from 13 month smoothed

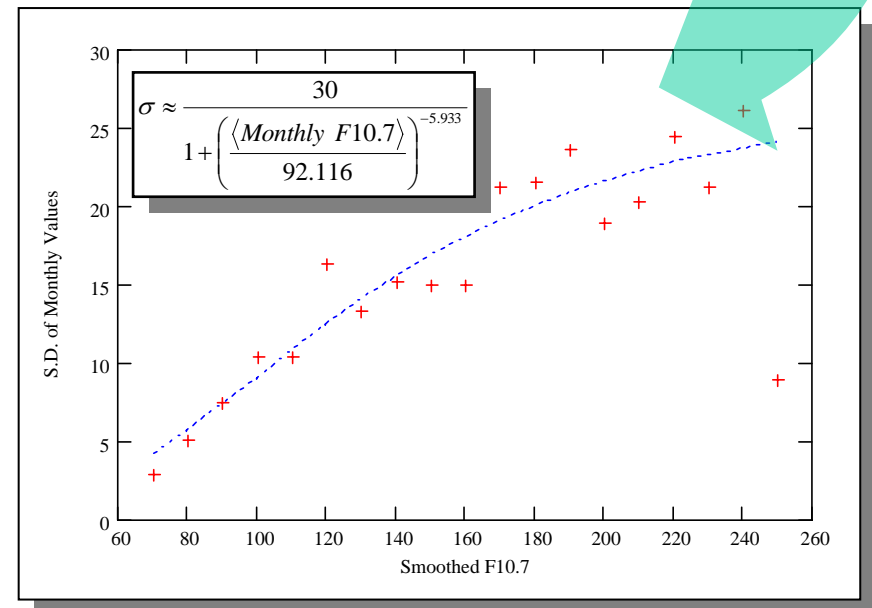
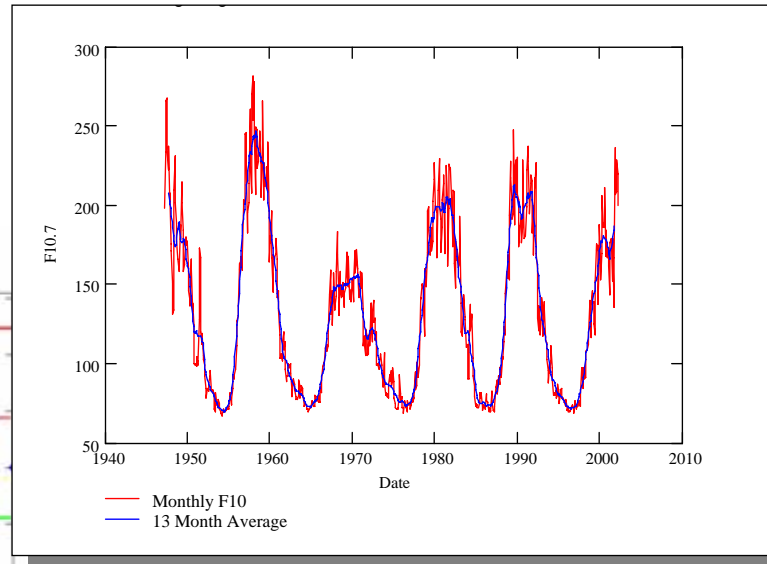
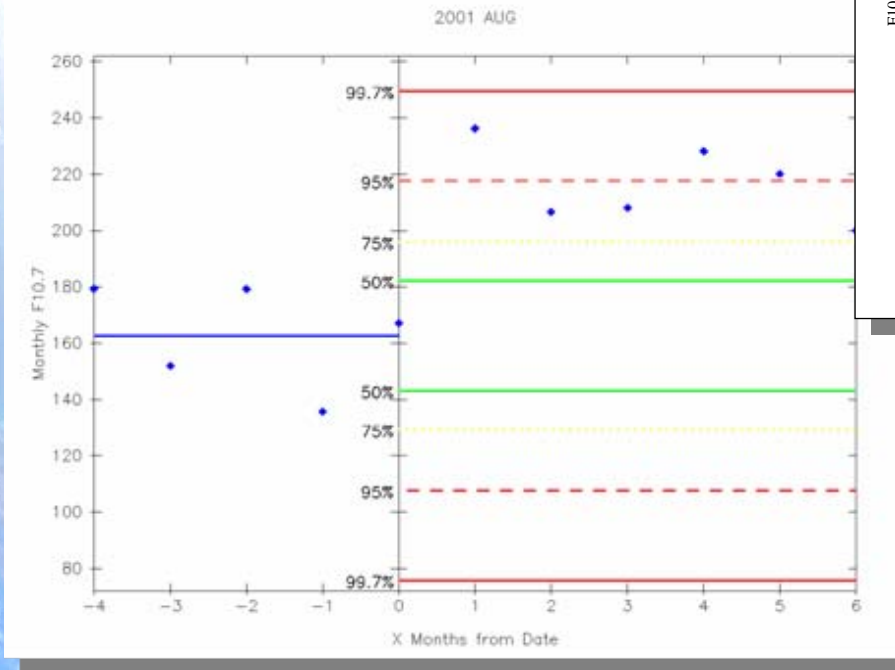

Output of Short-Term Atmospheric Prediction Tool

## Meteor Shower Forecasting



### **MSFC's Meteoroid Environment Office has NASA-wide responsibility for defining the meteoroid environment for spacecraft design and operations**

- **An annual forecast of meteor shower activity is generated using MSFC's Meteor Stream Model and provided to various spacecraft operators. Customization to the appropriate orbit is performed for certain users.**
- **ISS uses the meteor shower forecast to schedule EVAs and other sensitive operations**
- **Meteor Stream Model:**
  - ◆ **Flies various Earth-crossing comets around the sun, ejecting particles at appropriate time with speed, direction, size distributions**
  - ◆ **Particles are propagated with a Radau integrator including planetary perturbations, solar radiation pressure and Poynting-Robertson drag, and relativistic effects.**
  - ◆ **Numbers of particles passing near the Earth's orbital position are used to estimate meteoroid flux versus date/time for spacecraft operations**
  - ◆ **Model has been extensively tested on observed meteor storms/outbursts in the historical record**
  - ◆ **Model is used to plan/constrain ISS flight operations.**

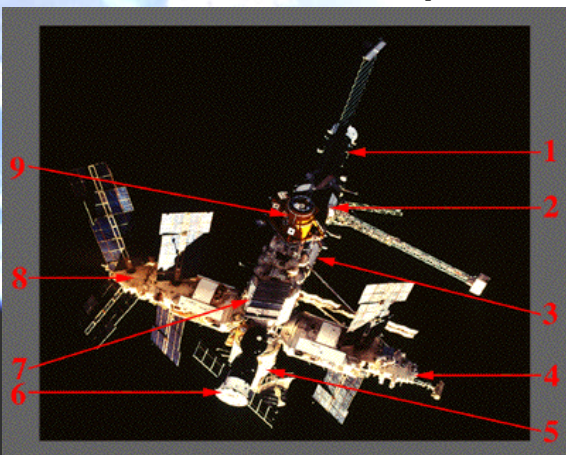

1. Progress
2. Kvant
3. Base Block
4. Kvant-2
5. Priroda
6. Soyuz
7. Kristall
8. Spektr
9. Docking Module

**Space Station Mir suffered more damage from a single severe meteor shower than from 5 years of flight in the nominal orbital MM/OD environment**

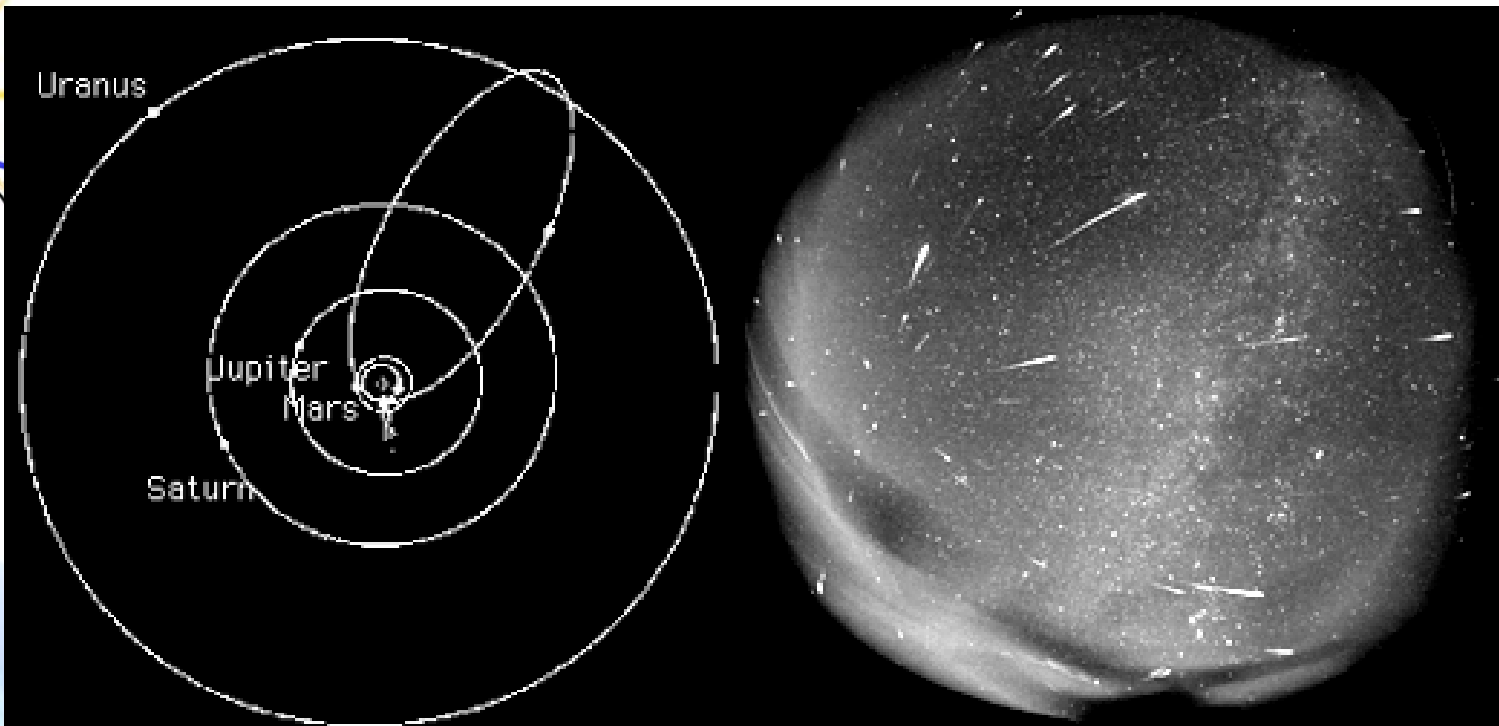

*The orbit of comet 55P Tempel-Tuttle in a diagram by Yeomans et al. (1996). The planet positions are shown for February 28, 1998, when the comet passed the Sun most recently. The comet travels every 33.3 years between the orbits of Earth and Uranus. Right shows an all-sky view of the Leonid outburst from Modra Observatory in a 4 hour exposure on November 17, 1998.*

<http://leonid.arc.nasa.gov/meteor.html>

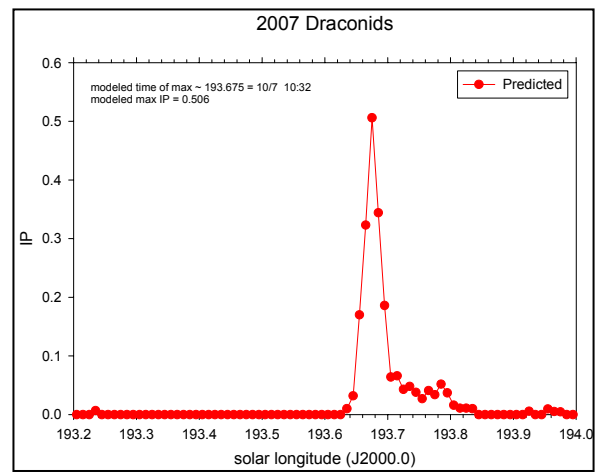
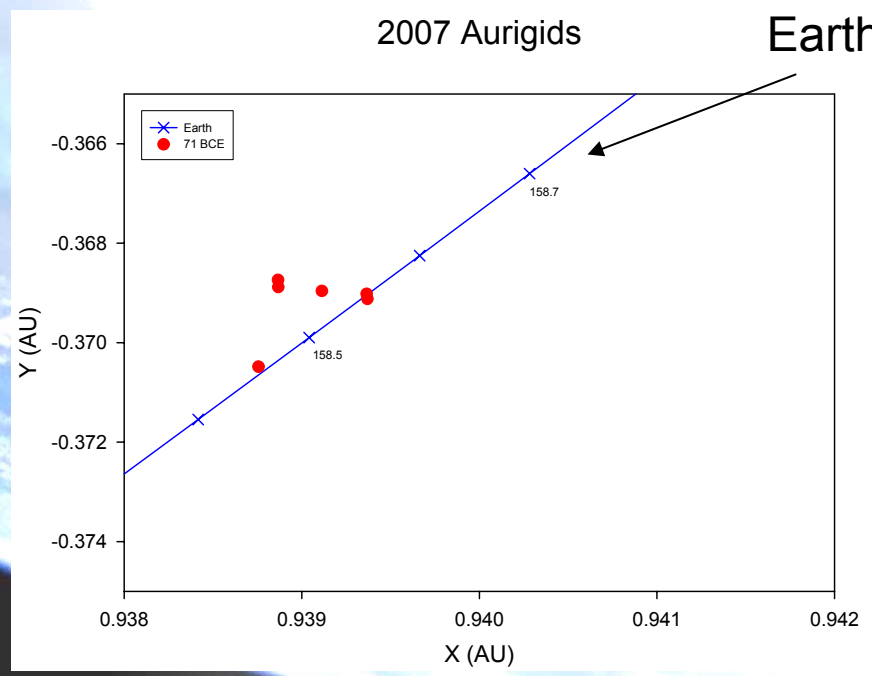
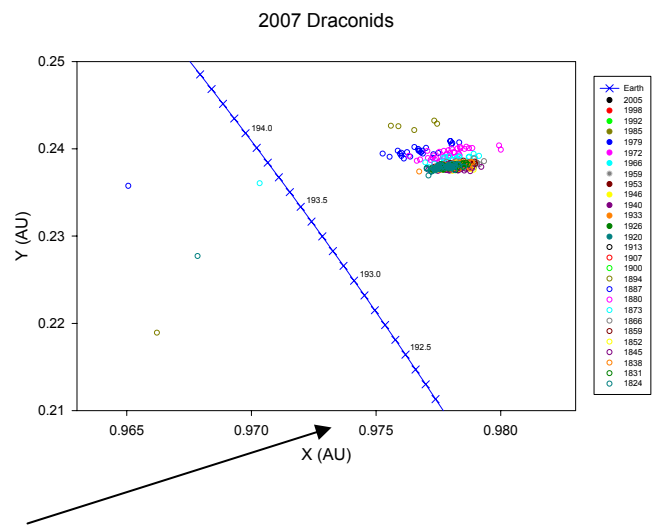
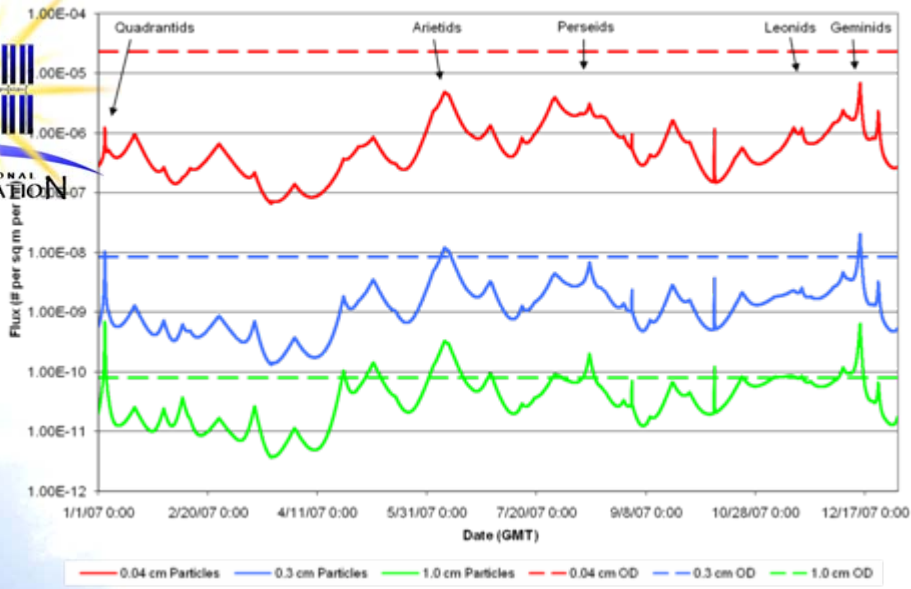



## *Orbital motion of Leonid debris streams*

***“The movie shows Leonid streams from Temple-Tuttle 2. The different colors are streams ejected at different perihelion passes which occur every 33 years. They are perturbed differently and thus “stratify” somewhat which is what makes stream/storm forecasting so interesting”. MSFC/Dr. Rob Suggs***

ClearSky : 1699 Data - Outer View  
Copyright 1998 David L. Clark  
1998/11/03 10:52:39 EST

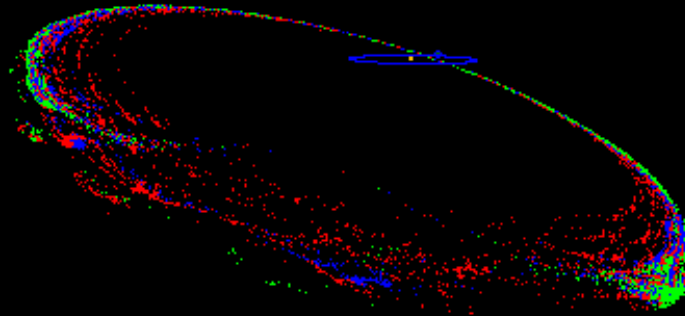

# ISS Spacecraft Charging Interactions



- ISS operates in the F2 region of Earth's ionosphere (a low- temperature high-density plasma)
  - ◆ 51.6 degree orbital inclination
  - ◆ 350 to 400 kilometer orbital altitude
  - ◆ Spacecraft-environment interactions in the ISS operations environment lead to spacecraft electrical charging and possibly hazards arcing events
    - **Possible ISS Vehicle hazards**
      - ◆ EMI/EMC effects on avionics and pyrotechnics
      - ◆ Thermal control surface degradation
    - **Possible crew EVA hazards – arcing could endanger EVA crewmembers**
  - ◆ **By design, ISS is equipped with 2 Plasma Contactor Units (PCUs) to control possible spacecraft charging hazards**
- Primary physical causes of ISS Spacecraft charging processes
  - ◆ Interaction of ionospheric plasma with 160 V USOS Solar Array Wings (SAWs) in negative polarity electrical system common (ground) EPS configuration
  - ◆ Magnetic induction voltages (like electrodynamic tether) on a large vehicle at high latitude (50Volts truss-tip to truss-tip at assembly complete)
  - ◆ Energetic Auroral electron streams (associated with geomagnetic storms) striking Vehicle at high latitudes (low probability, but not zero, based US DoD/ESA/RSA LEO satellite charging data)
- ISS charging severity (floating potential (FP) relative to ionospheric plasma) depends on ISS flight attitude, SAW/EPS configuration, and orbital flight path/Beta angle, as well as the natural variability of the ionosphere and magnetosphere.
  - ◆ **The amount of charging seen on a particular day (with PCUs off) depends on both the state of the natural environment along the Vehicle flight path and Vehicle attitude/configuration and can exhibit substantial variation**

# ISS Ionospheric Plasma Environment

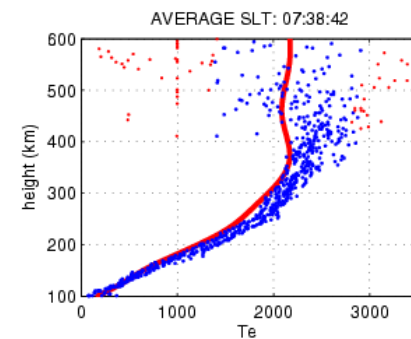
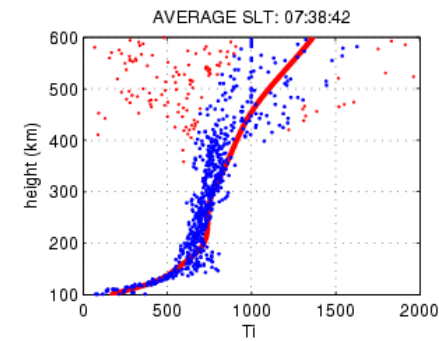
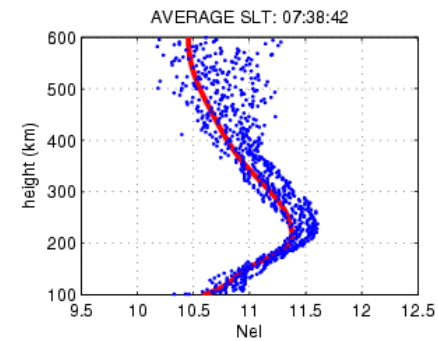
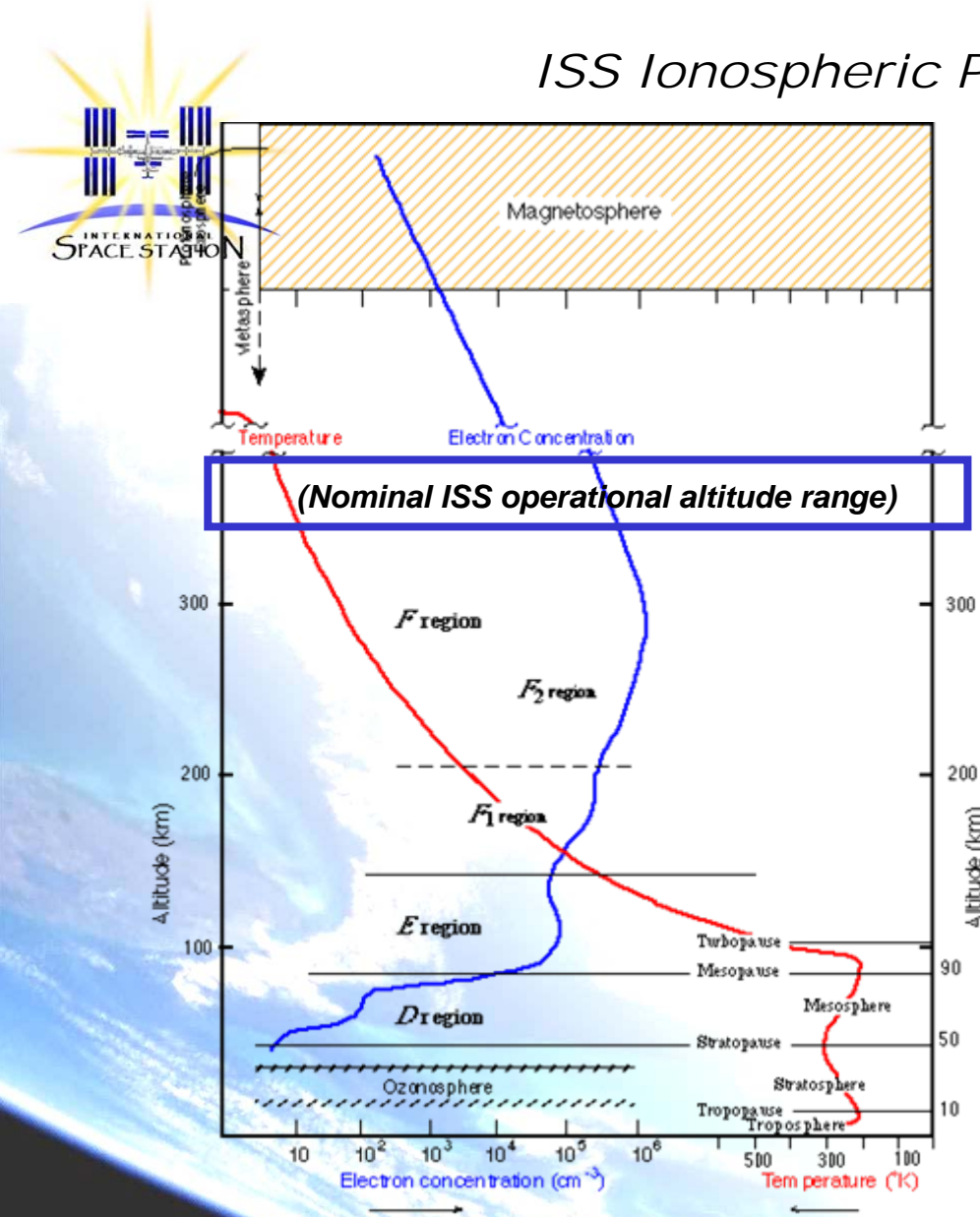

## ISR Data and Model

### for Millstone Hill

in the last 1 hour (A/C)

(red for SNR < 0.15 & 35% off model)

F<sub>107</sub> = 74

ap = 4

Current Local Time 30-Sep-2005 09:00:17



# IRI vs Satellite Measurements: Ionospheric Variability



**Blue:** IRI  
**Green:** +/- 68%  
**Yellow:** +/- 95%  
**Red:** +/- 99.9%

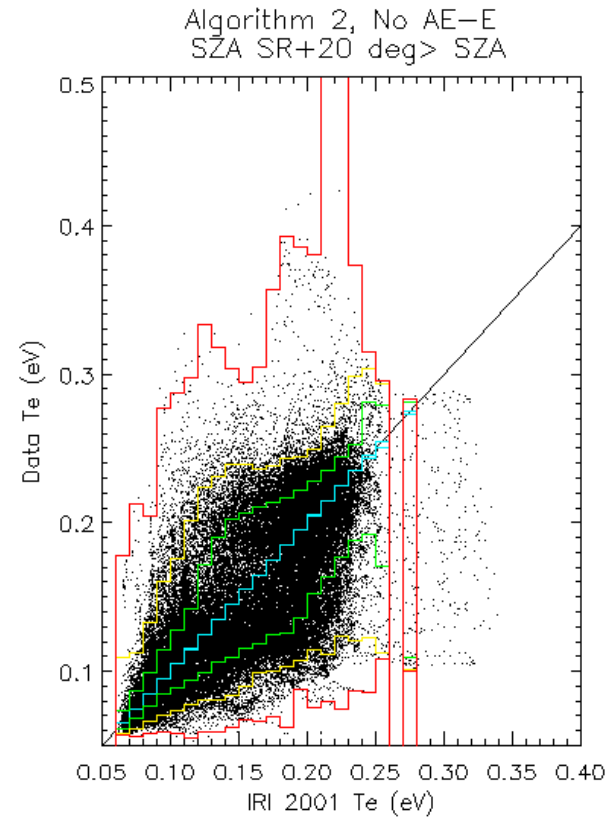
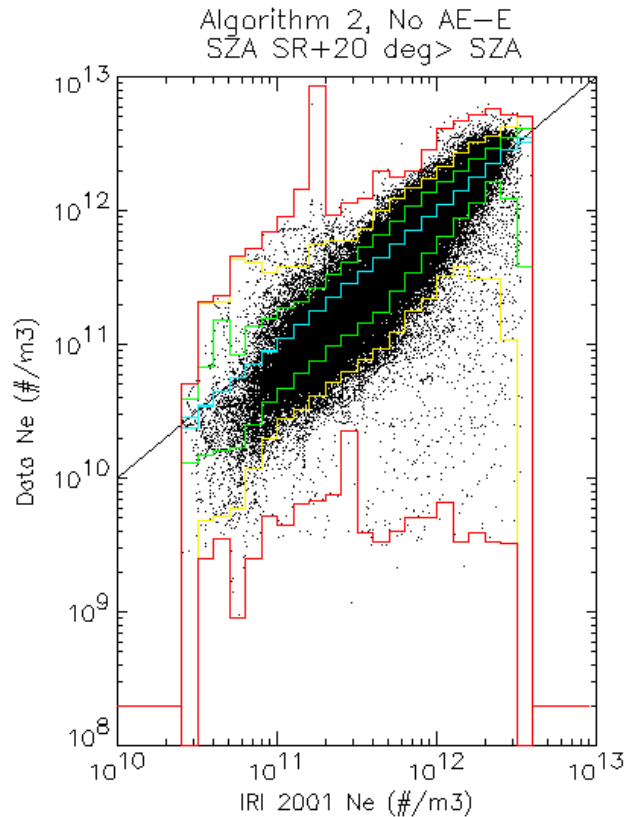

Ne, Te variability model derived from analysis of percentile deviations of AE, DE data about corresponding IRI-2001 estimates

Pre-sunrise, daytime, and post-sunset ( $SZA_{\text{sunrise} + 20 \text{ deg}} > SZA$ ,  $SZA_{\text{sunset} + 20 \text{ deg}} > SZA$ ), and ISS regime ( $|\text{lat}| < 55$ ,  $350 \text{ km} < z < 450 \text{ km}$ ) values only. Night values neglected.

*Z component of the Geomagnetic Field at ISS nominal operations altitude (VXB·L magnetic induction voltage)*

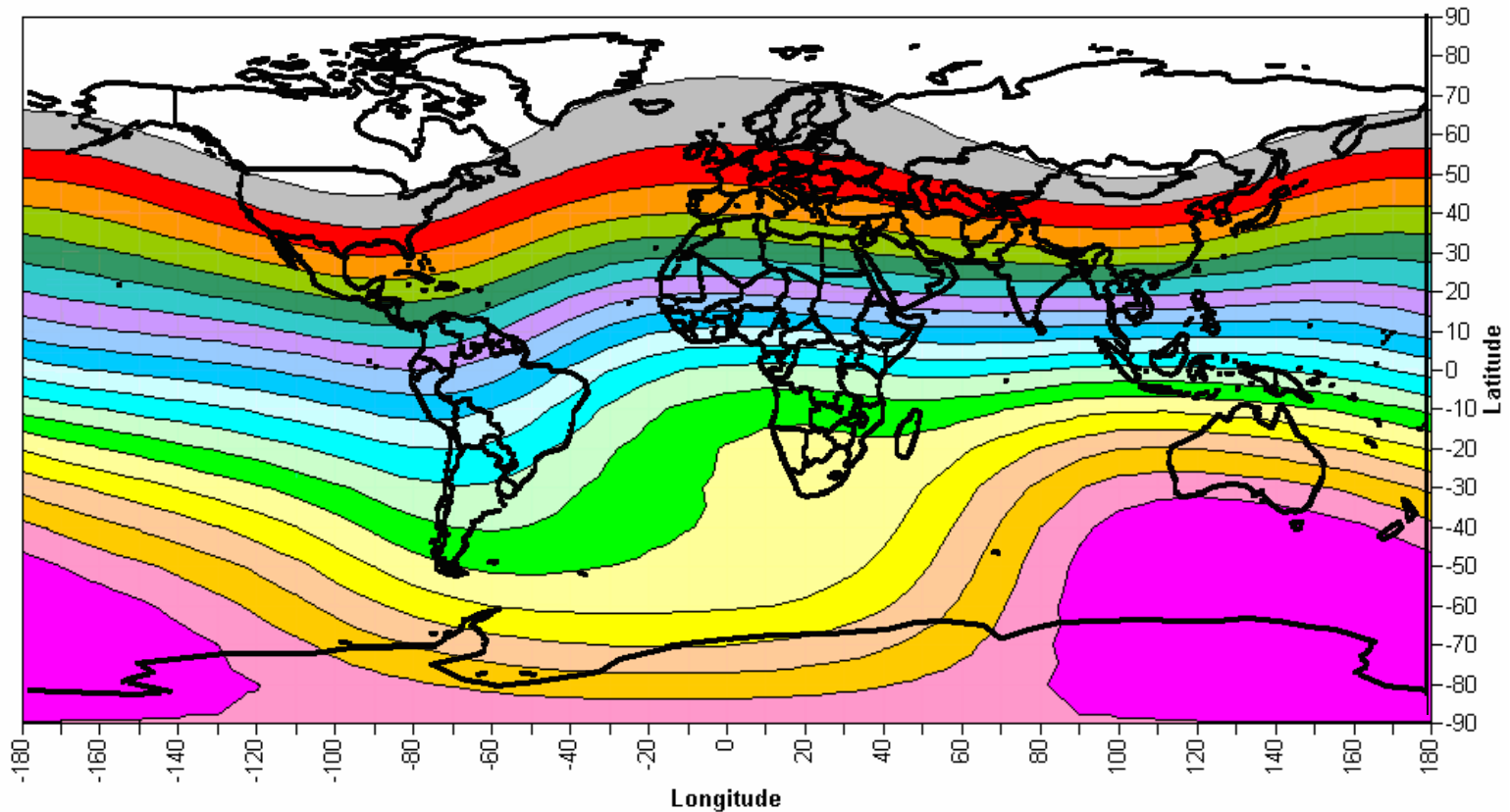

**Magnetic Field  $B_z$  (Gauss)**

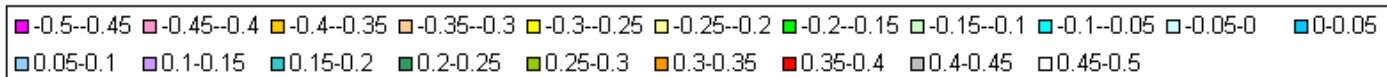

# ISS Orbit - March 29, 2001 (20:04 GMT)

Ionosphere Model (IRI 2001) ISS position at time: 20:04 GMT; Latitude: 48.8; Longitude: 115.2

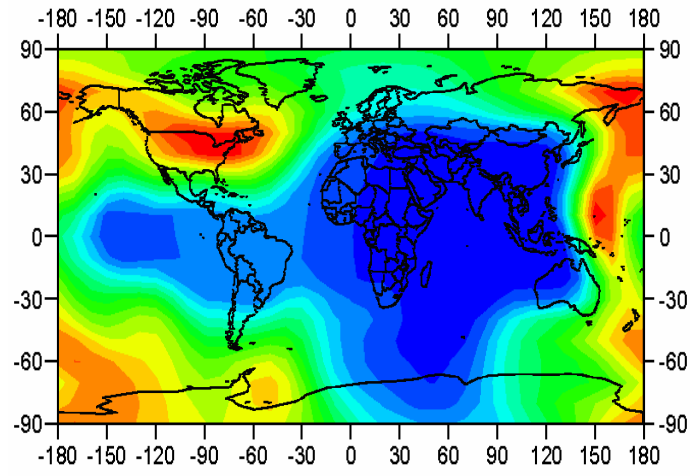

### Plasma Temperature (eV)



### ISS Orbit and Position

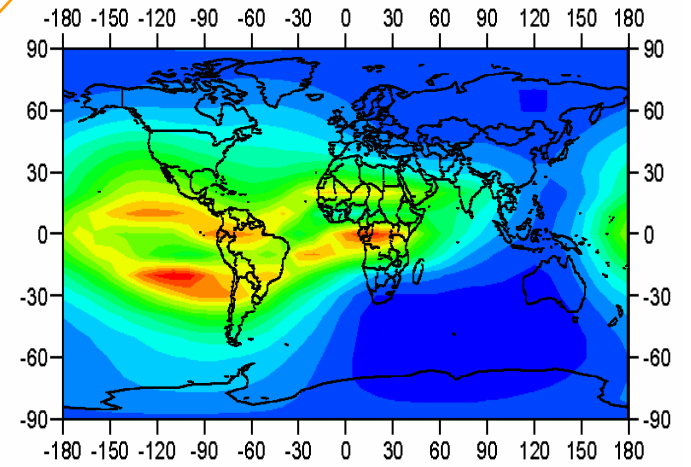
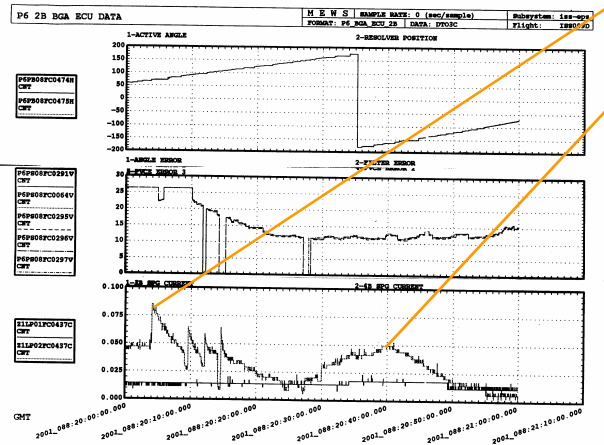
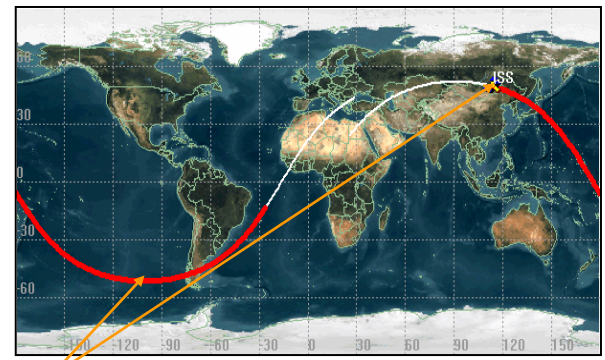

### Plasma Density (#/m^3)

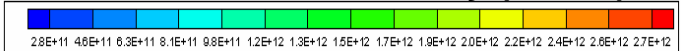



Port side of Z1 Truss / P6 Truss  
AF-6A



## ***Plasma Contactor Units***

- ◆ ***Floating Potential (magnetic induction and SAW driven charging)***



# Do PCU Emission Currents Imply ISS Charging?

- **Yes – PCU emission currents demonstrate PV array driven charging**
  - ◆ **Eclipse Exit – PV array driven contribution**
    - ☞ See figure below
  - ◆ **High Latitude – Magnetic Induction pick-up by conducting area**
- **Note the substantial daily and seasonal variation**

**Eclipse Exit PCU Current**  
Flight Attitude XVV

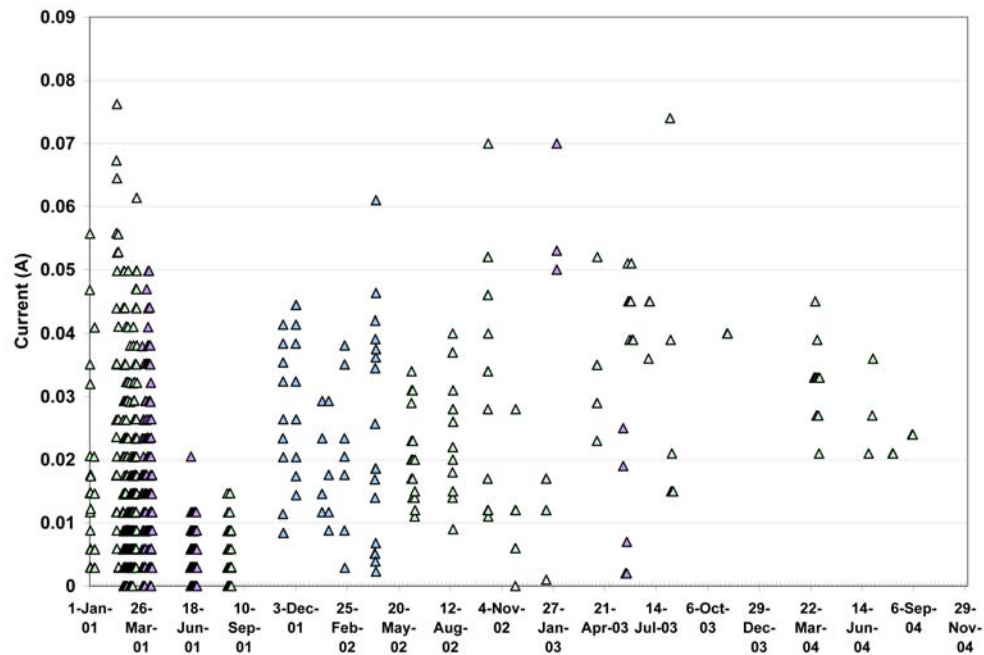



# Does PV array and conducting structure charge collection lead to ISS charging?

- **Yes – Validated floating potential measurements at the FPP measurement point with the plasma contactor system off. April 11, 2001. Shows both PV array and magnetic induction contributions.**
- **Note the variability along the ISS flight path on this day.**

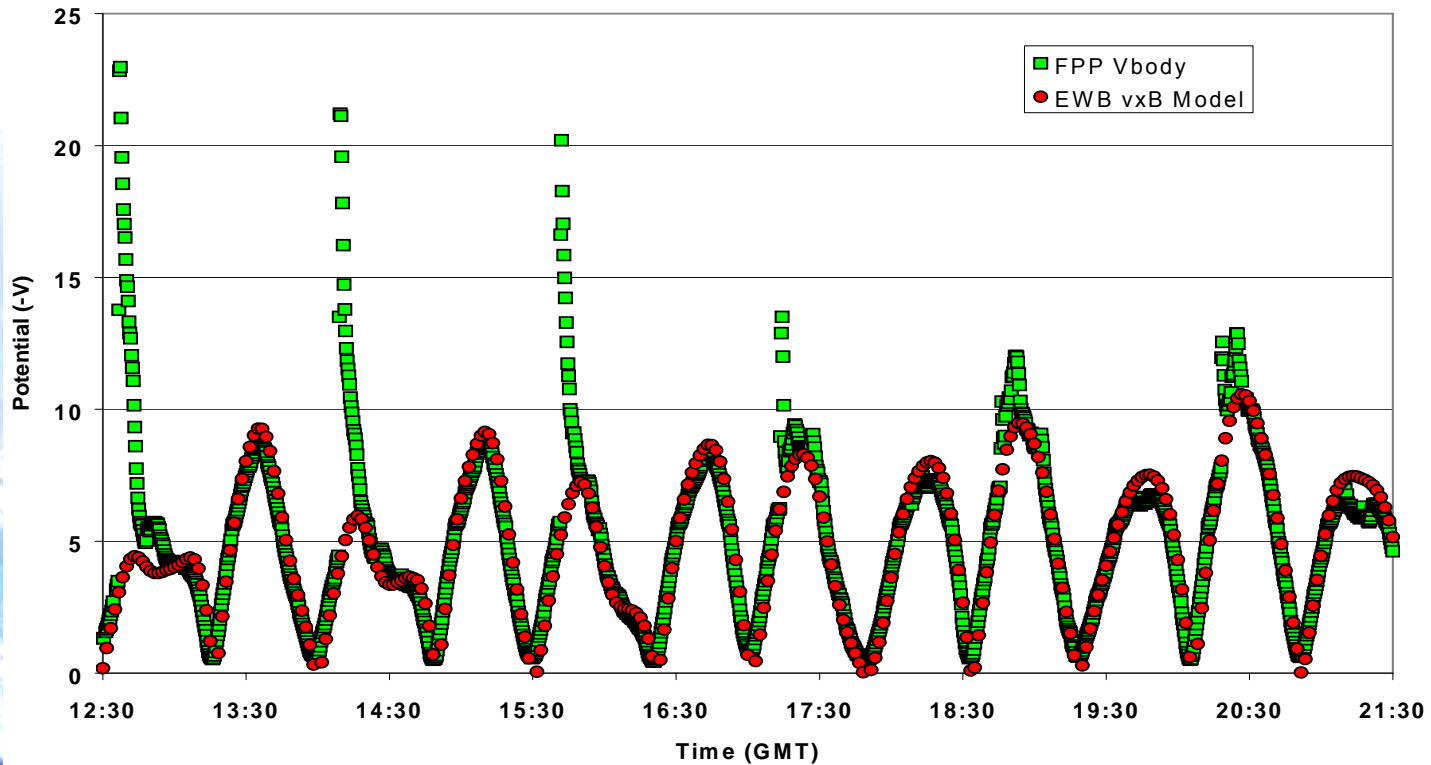



# 160V Solar Array Electron Collection Drives ISS to Negative Potentials:

## PV array driven charging

**ISS ~ - 5V to - 80V**

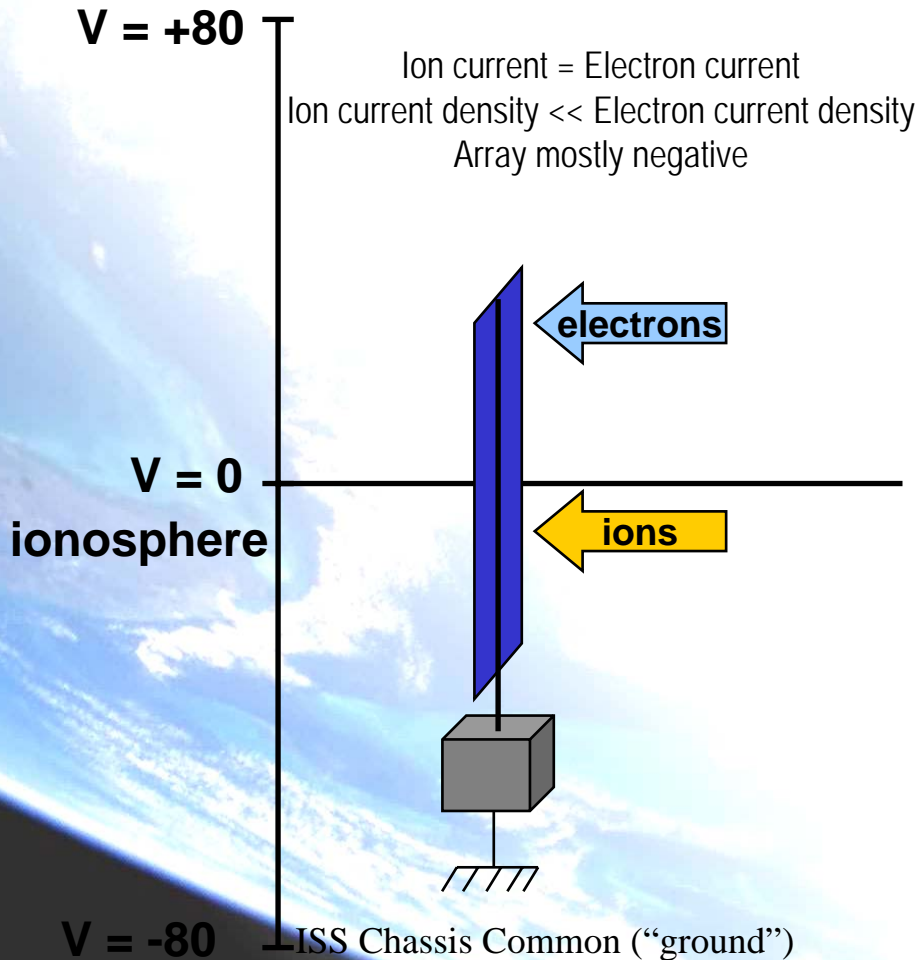

**Circuit**

$$I_e + I_i = 0$$

$$\frac{V + 160}{R_e} + \frac{V}{R_i} = 0, R_i > R_e$$

$$V = -160 \left( \frac{R_i}{R_i + R_e} \right) \approx -5 \text{ to } -80 \text{ Volts}$$

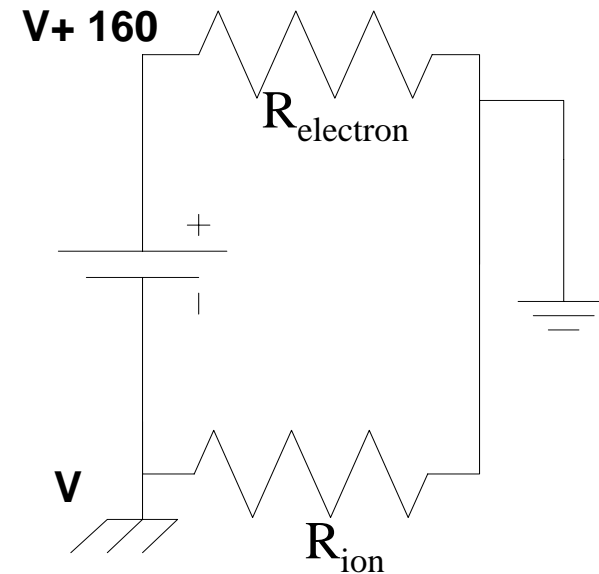



# Effectiveness of ion collection by ram oriented conducting structure in mitigation of PV array driven charging

Example  $N_i = N_e = 10^6/\text{cc}$

<b>Ionospheric Electron Current Collected by 160 V PV Arrays in milliamps</b>	<b>Required Area of Ram Oriented Ion Collection Surface in square meters</b>
10	8
30	24
60	48
100	80



# Assessment and Prediction of ISS Charging and Related Risks



INTERNATIONAL  
SPACE STATION

- **Pre-flight assessment of the severity of ISS SAW/EPS driven spacecraft driven charging were necessarily inconclusive**
  - ◆ *Low fidelity test articles and test systems*
  - ◆ *Uncertainty drives worst case design*
  - ◆ *Plasma Contactors were installed on ISS to assure control of any charging processes*
- **Early flight data indicated that:**
  - ◆ *Charging processes occur and are less severe and occur less frequently than earlier worst case assessments suggested*
  - ◆ *A first-principle model of ISS charging might be successfully developed and verified using real flight data*
- **NASA/Boeing/SAIC charging model, Plasma Interaction Model or PIM, developed and verified with:**
  - ◆ *PCU emission current data*
  - ◆ *Floating potential probe data*
  - ◆ *Most recently Floating Potential Measurement (FPMU) Unit Data*
- **EMU suit electrical safety assessment**
  - ◆ *In parallel the electrical safety of the US EMU suit was re-evaluated in the ISS floating potential environment and a possible hazard needing control was identified*
  - ◆ *ISS floating potential must be less negative than -40V for safe EVA operations*
- **Results of model development and model verification campaigns**
  - ◆ *Charging - Arcing is not a credible threat to ISS hardware or systems*
  - ◆ *No PCU operations are required during non-EVA times*
  - ◆ *PCUs required for EVA operations through end-of-program*



# FPMU FP vs. PIM Predictions

Regression Plots:  $x = \text{PIM FP}$ ;  $y = \text{FPMU FP}$

Nominal IRI 2001 ionosphere

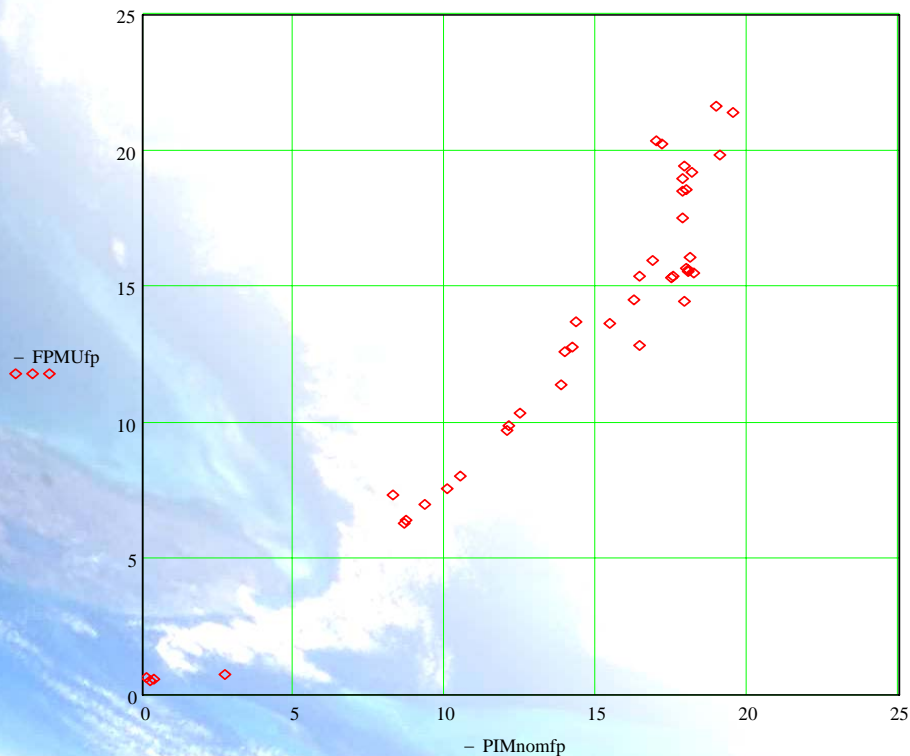

$$\text{corr}(-\text{PIMnomfp}, -\text{FPMUfp}) = 0.954$$

$$\text{line}(-\text{PIMnomfp}, -\text{FPMUfp}) = \begin{pmatrix} -1.606 \\ 1.043 \end{pmatrix}$$

+1  $\sigma$  worst case IRI 2001 ionosphere

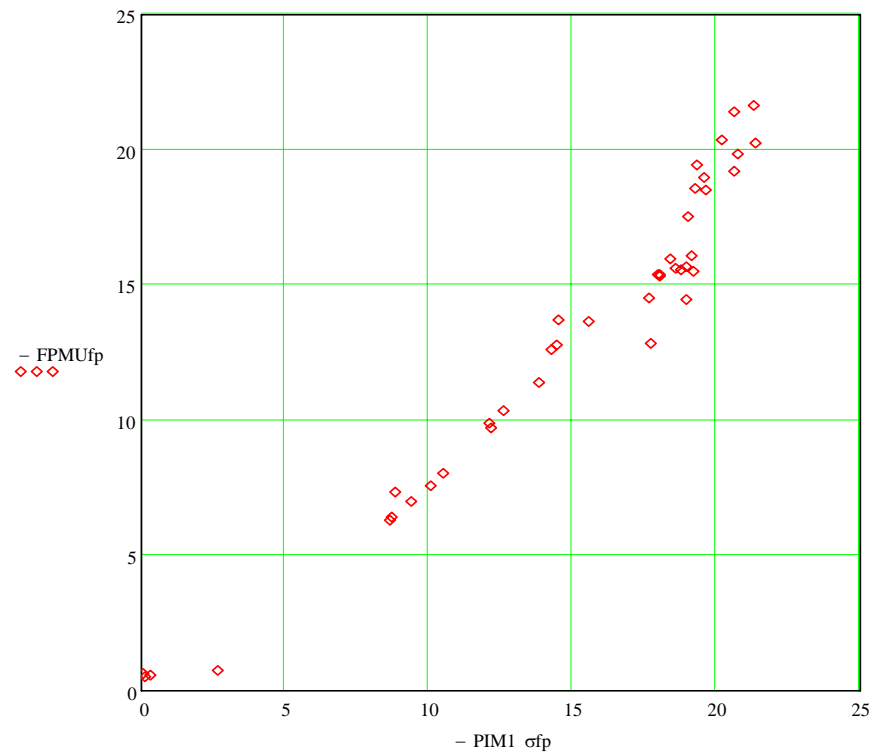

$$\text{cvar}(-\text{PIM1 } \sigma\text{fp}, -\text{FPMUfp}) = 34.373$$

$$\text{corr}(-\text{PIM1 } \sigma\text{fp}, -\text{FPMUfp}) = 0.975$$

$$\text{medfit}(-\text{PIM1 } \sigma\text{fp}, -\text{FPMUfp}) = \begin{pmatrix} -4.156 \\ 1.138 \end{pmatrix}$$

$$\text{line}(-\text{PIM1 } \sigma\text{fp}, -\text{FPMUfp}) = \begin{pmatrix} -1.211 \\ 0.956 \end{pmatrix}$$

Mar 03, 2007 (GMT 062) 08-10

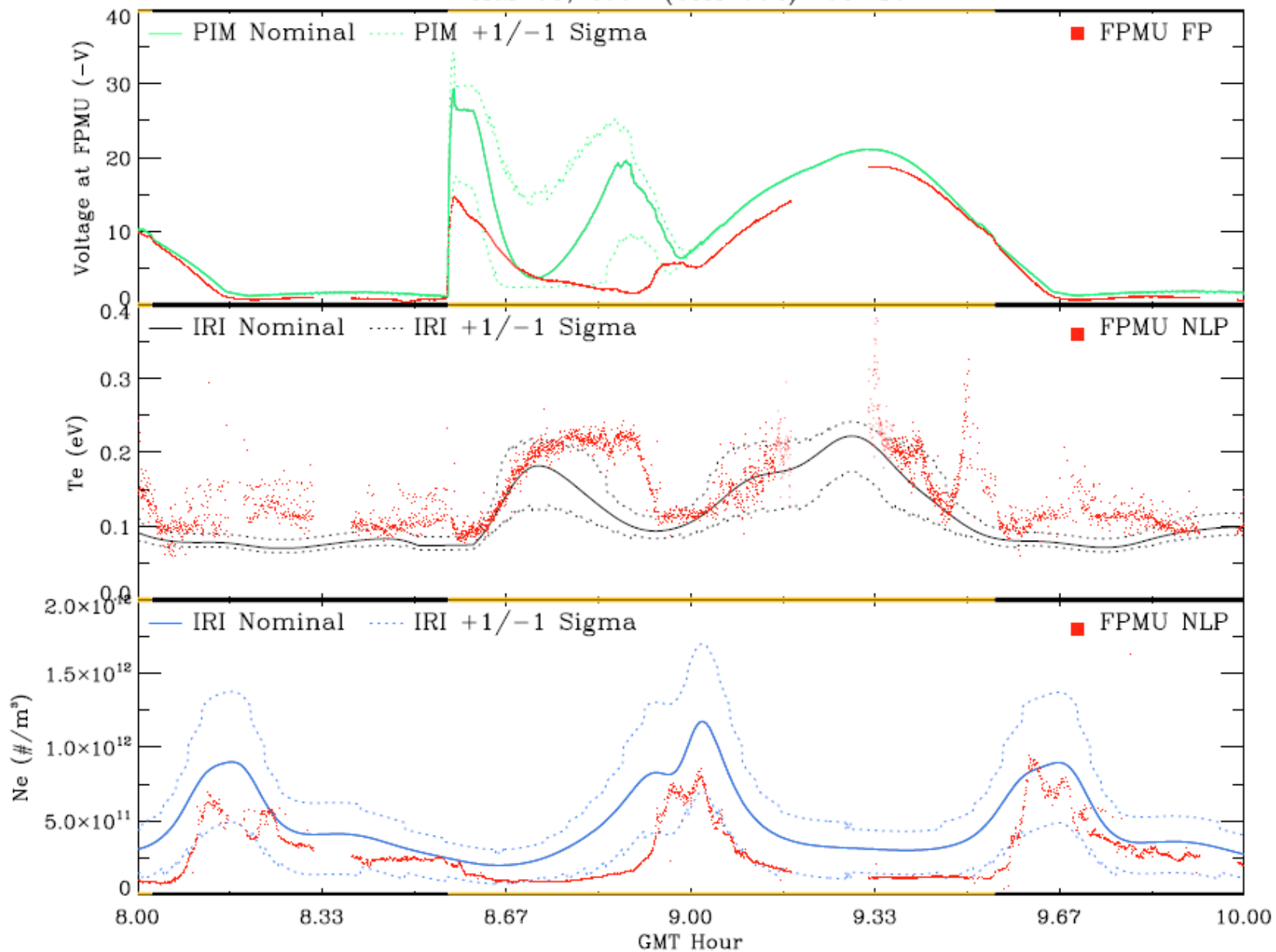

Aug 04, 2006 (GMT 216) 02-04

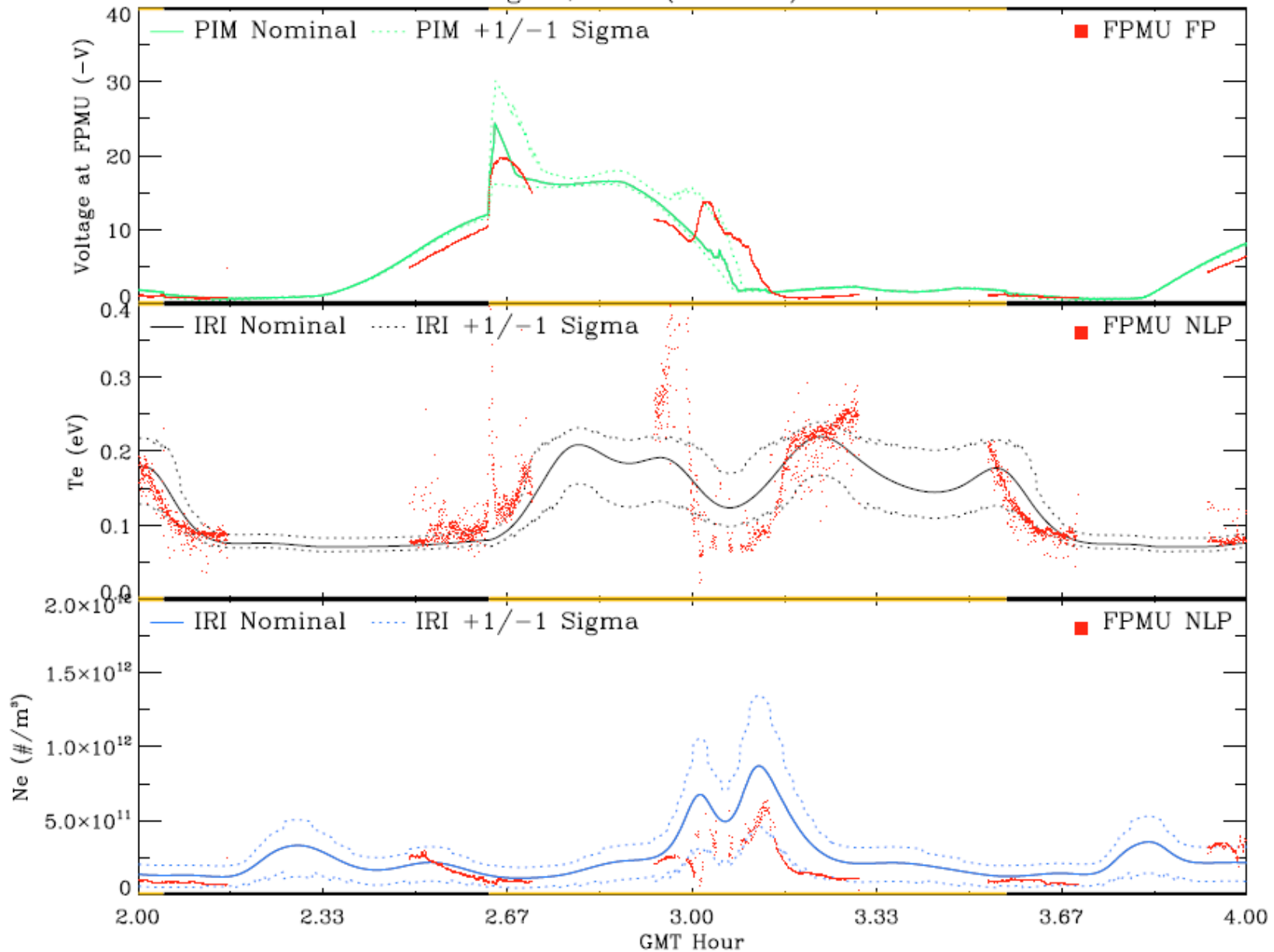



# IRI Model at Millstone Hill ISR – 2006/220/08:

FPMU – ISR – IRI Te/Ne comparisons

**ISS Altitude = 350 km**

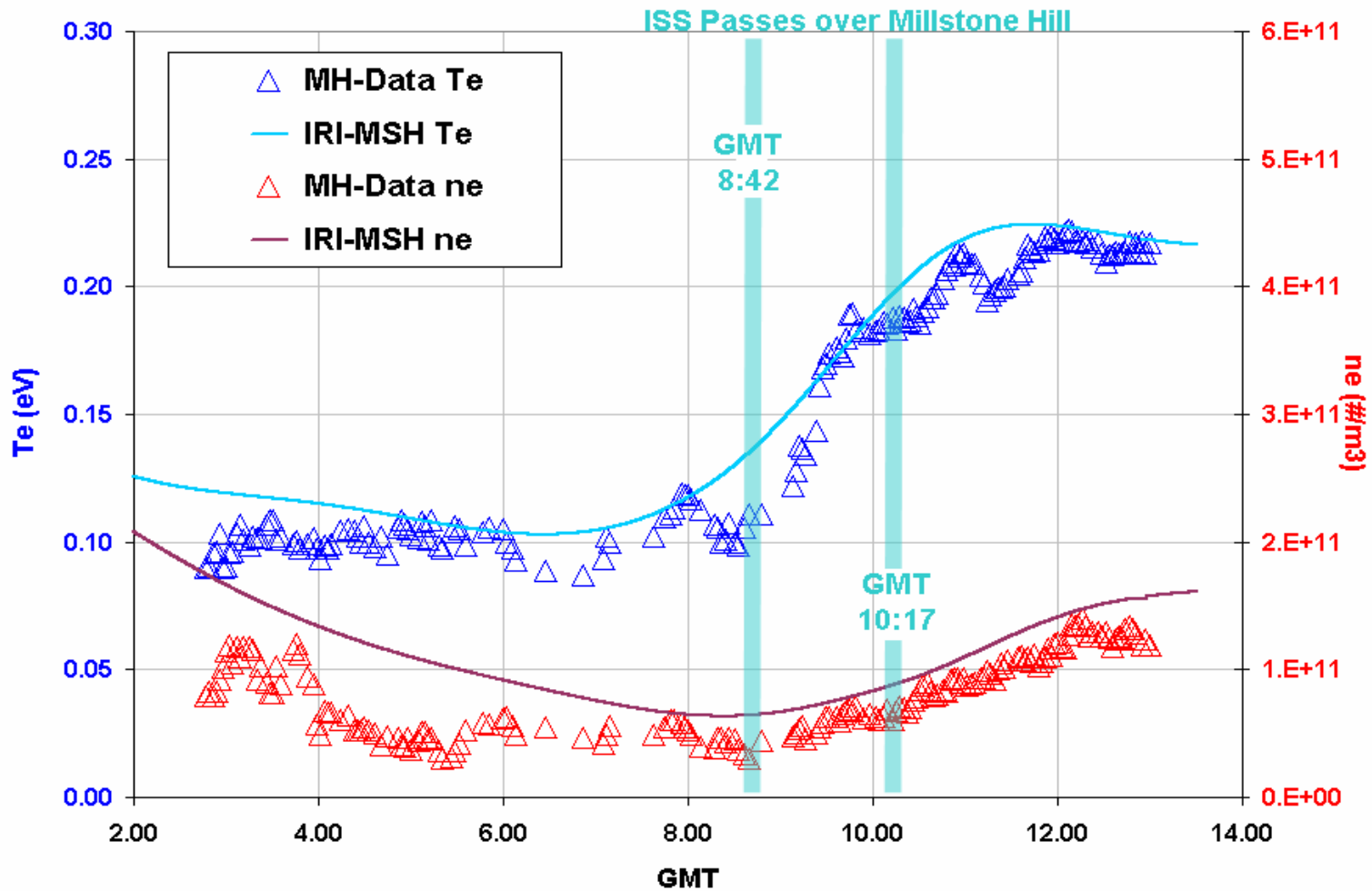



# Millstone Hill Fly-By FPMU - ISR - IRI N/T comparisons

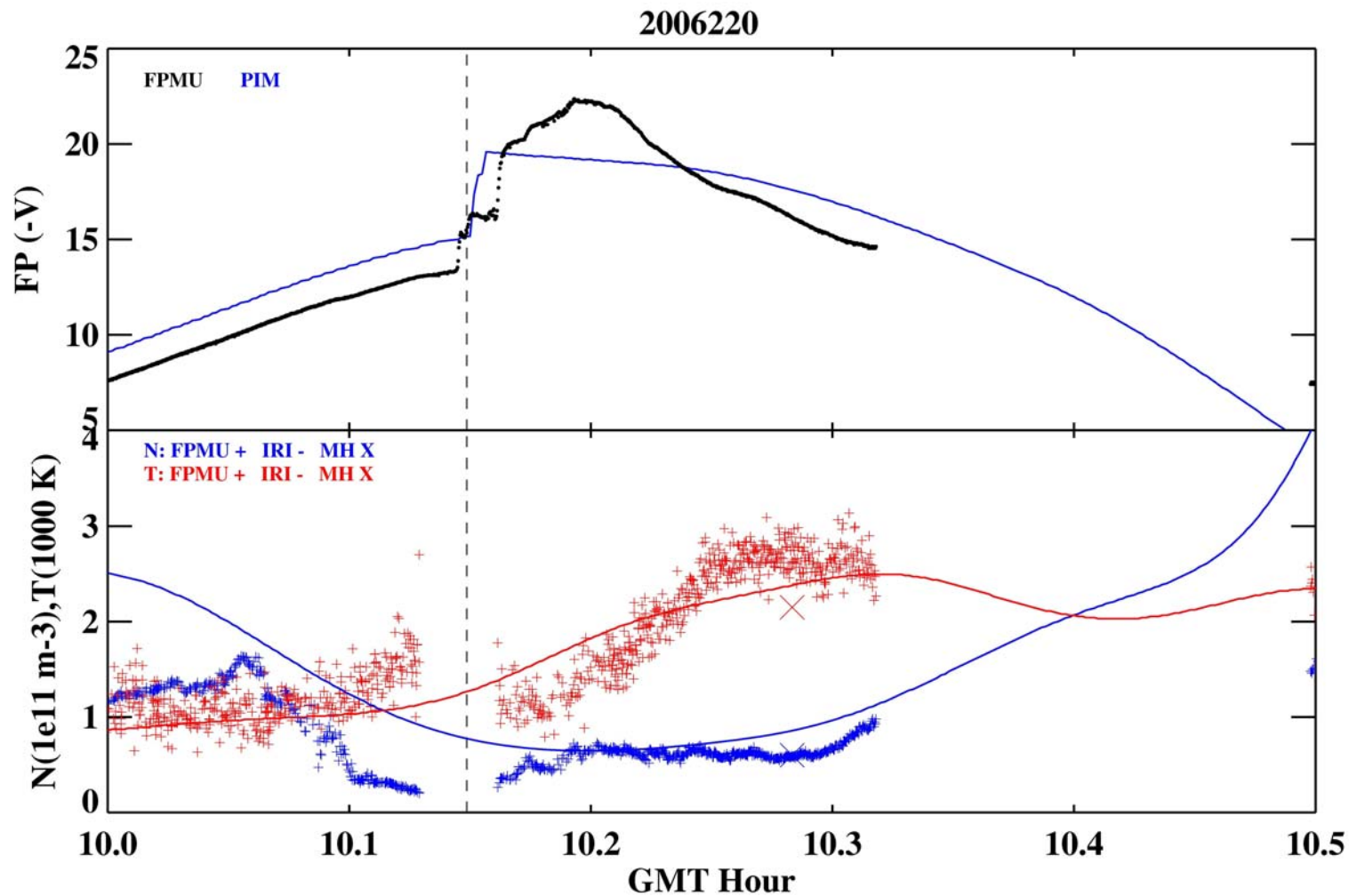



# Millstone Hill Fly-By FPMU - ISR - IRI N/T comparisons

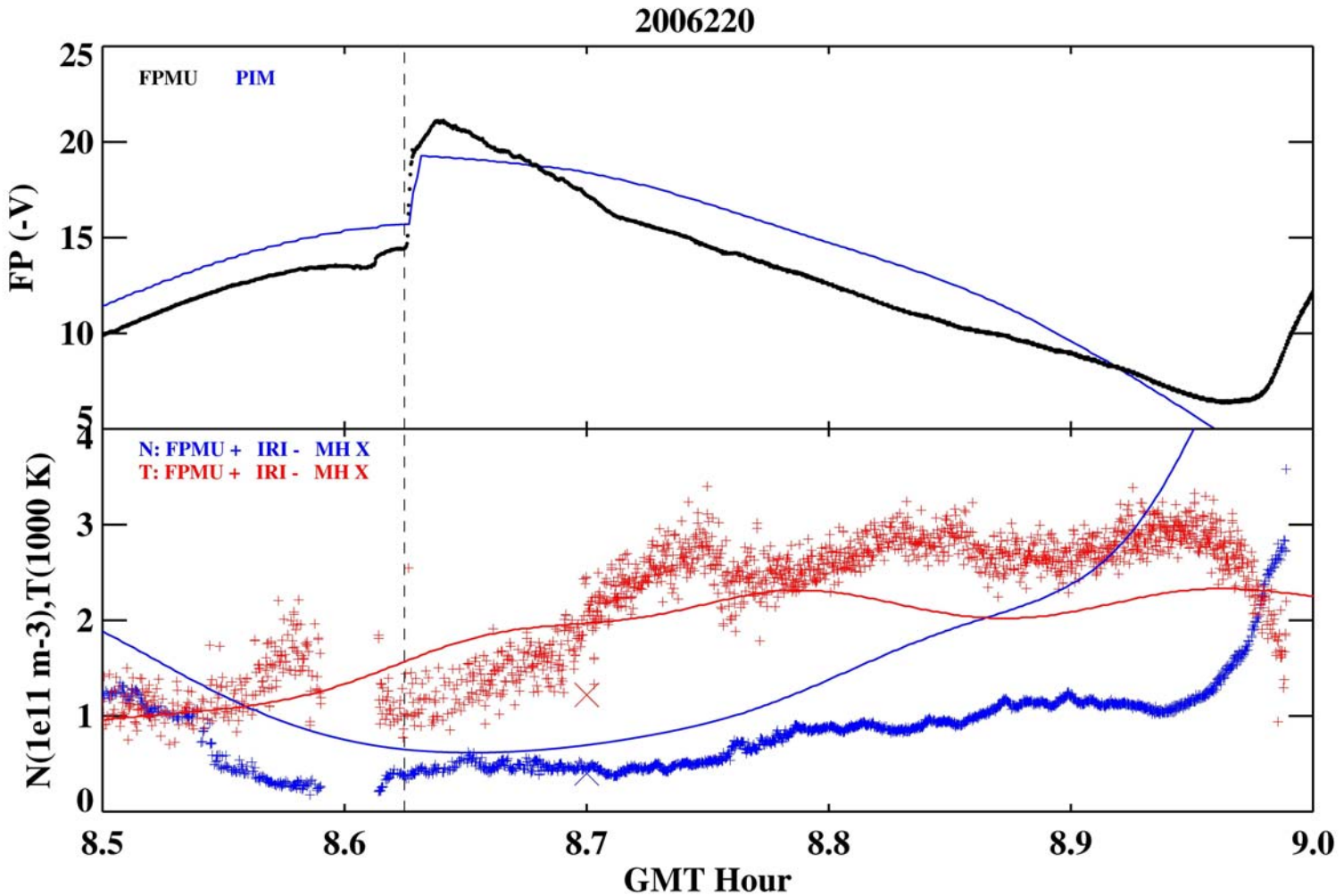

# ISS 13A: Worst Case Charging (see pg. 7) All Solar Arrays Active, Eclipse Exit, PCUs off



*Potential difference  
between ISS and  
local plasma  
environment (volts).*

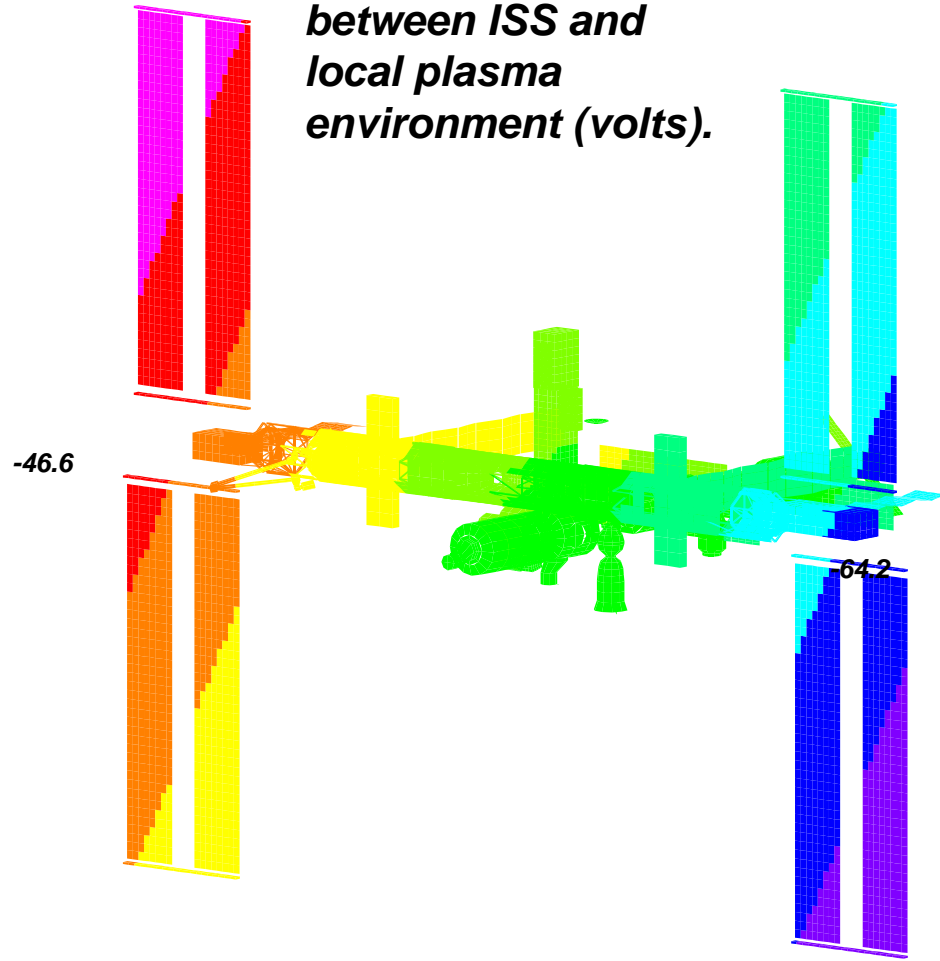
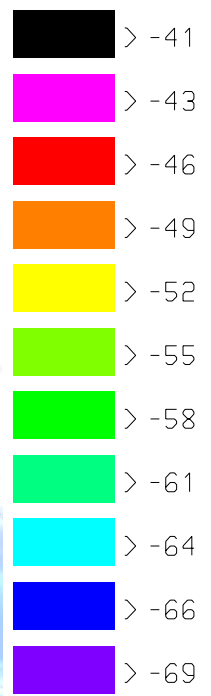





*ISS 13A Vehicle Charging Probability of Occurrence At Centerline - PCUs off*

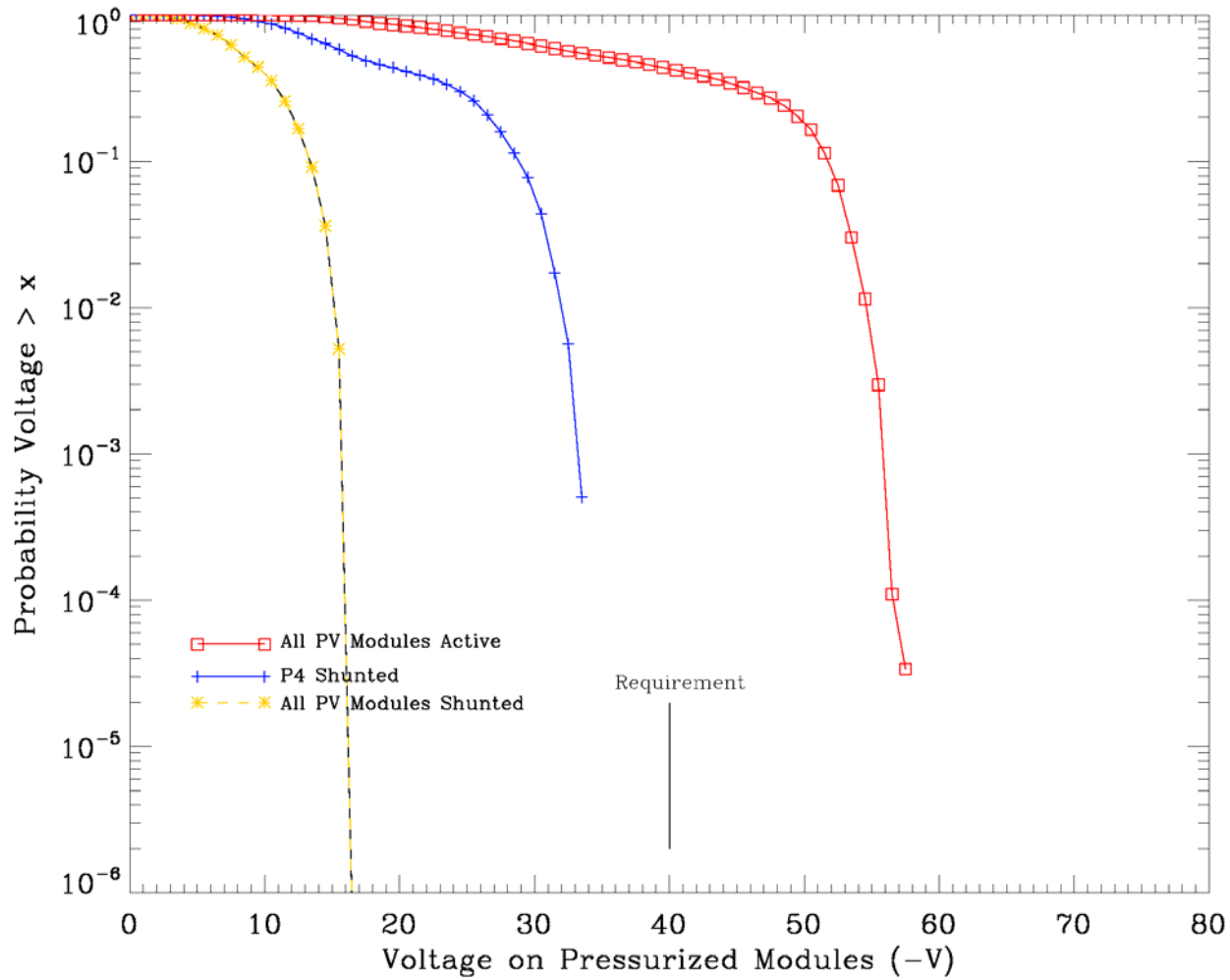

# ISS 15A: Worst Case Charging (see pg. 4) All Solar Arrays Active, Eclipse Exit, PCUs off

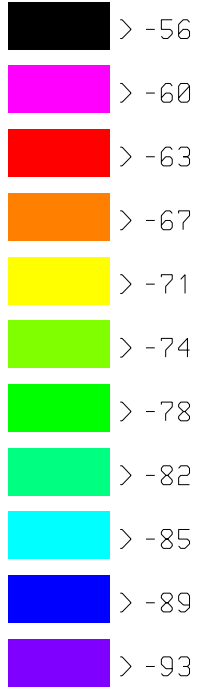

*Potential difference between ISS and local plasma environment (volts).*

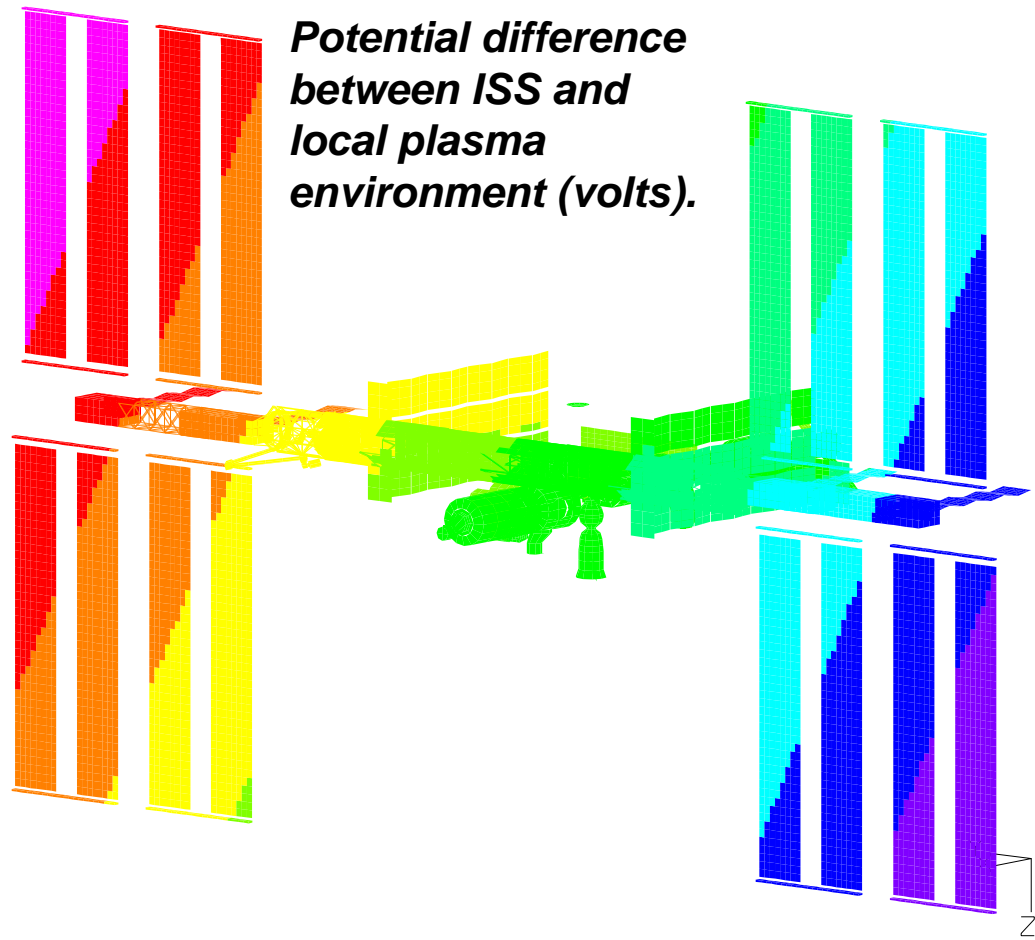

# ISS 15A Vehicle Charging Probability of Occurrence At Centerline - PCUs off

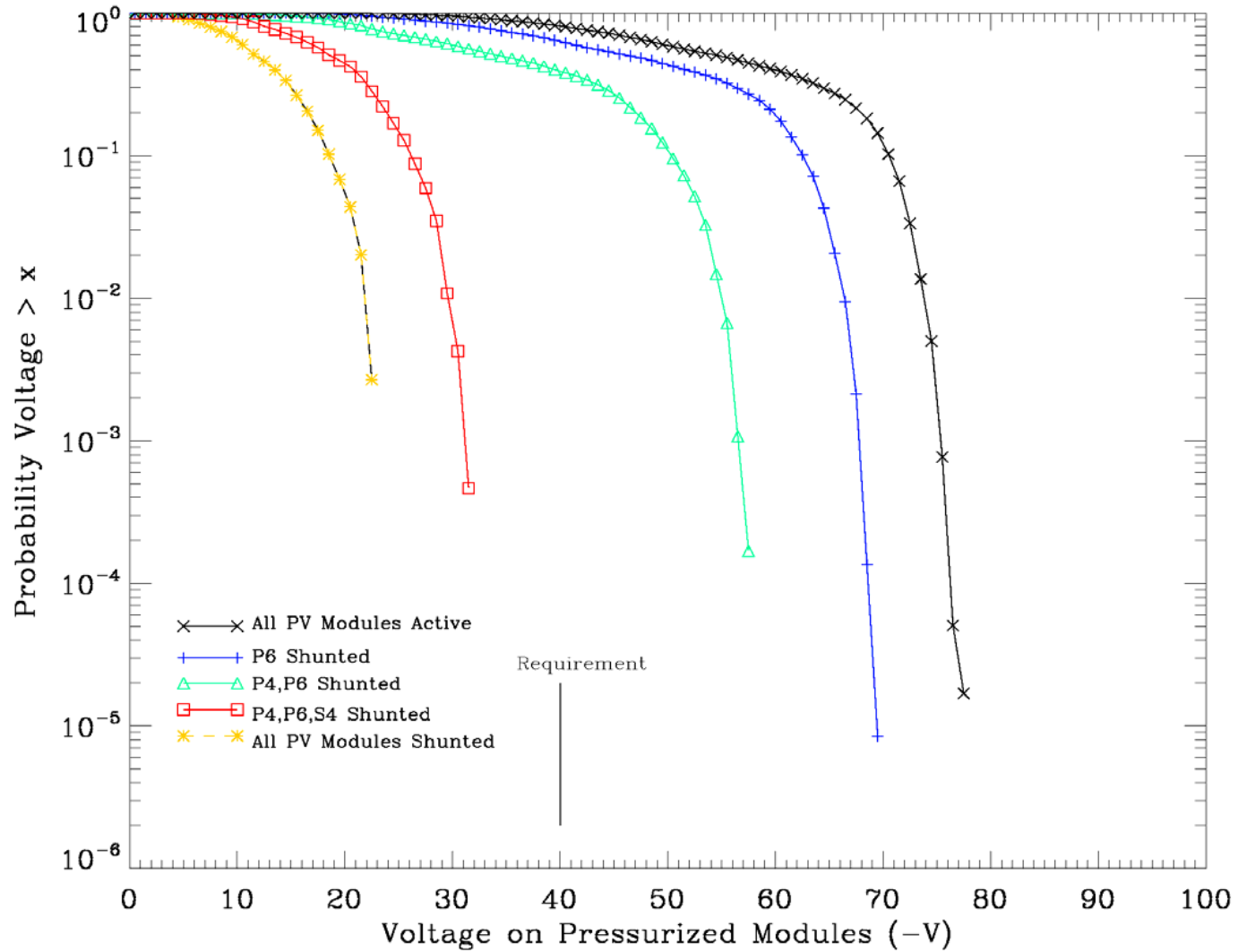



ISS006E41625

**07:55:03 UTC; Latitude = 49.9; Longitude = -139.0  
Looking East**

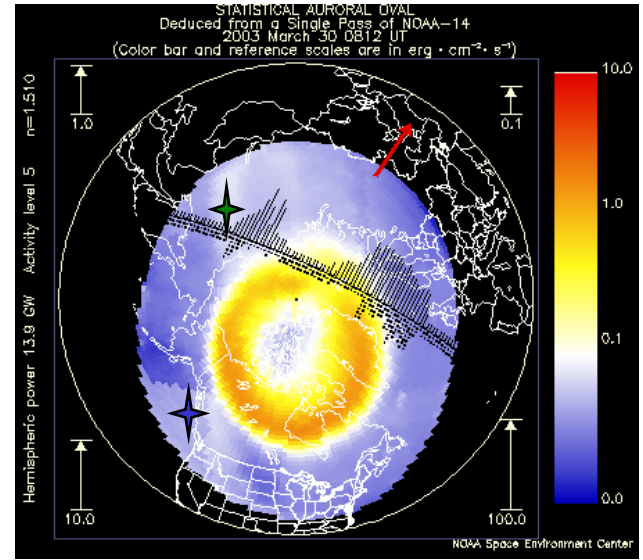

**Relative positions of ISS and NOAA-14 at 07:56 UTC**



ISS006E41616

**07:56:59 UTC; Latitude = 47.3; Longitude = -128.8  
Looking East**

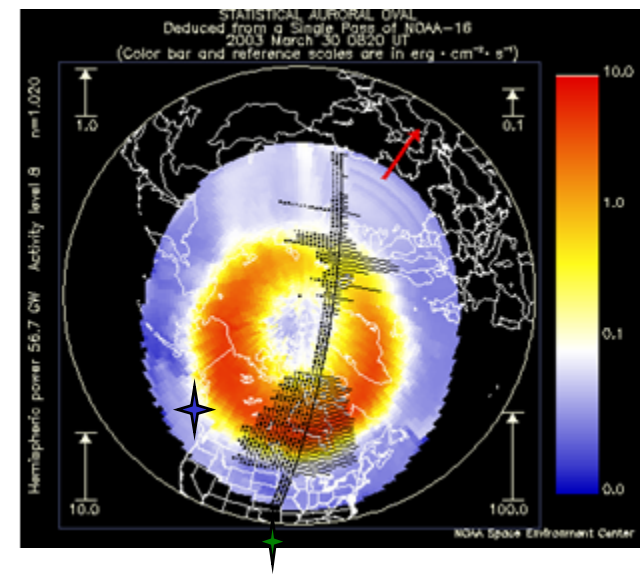

**Relative positions of ISS and NOAA-15 at 07:56 UTC**

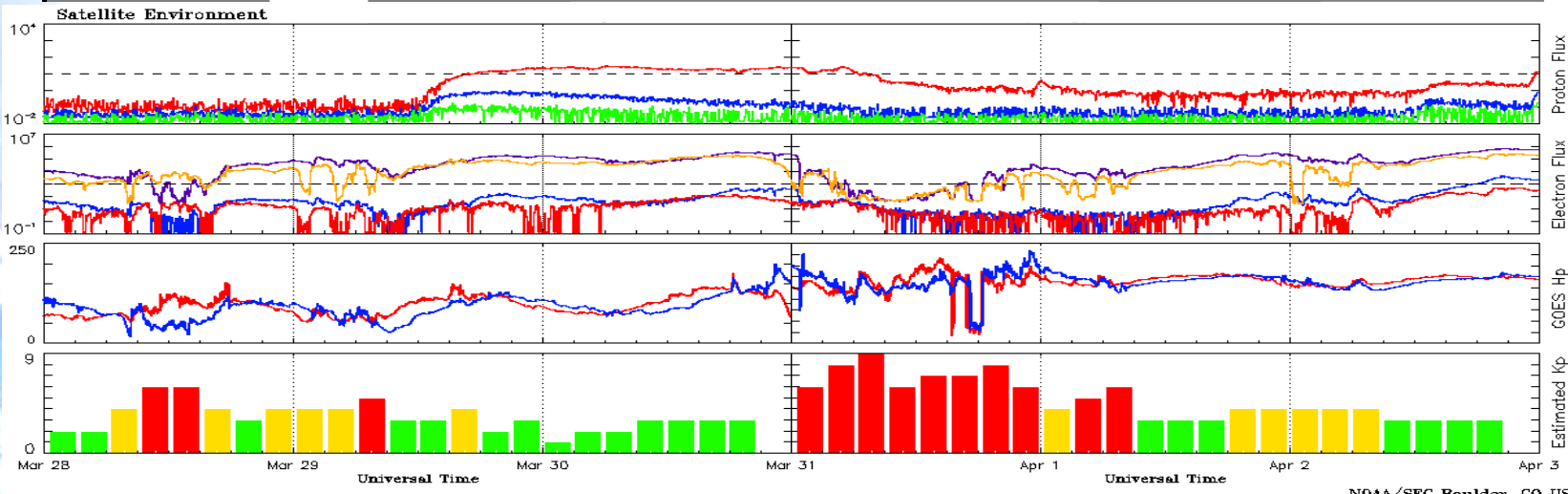
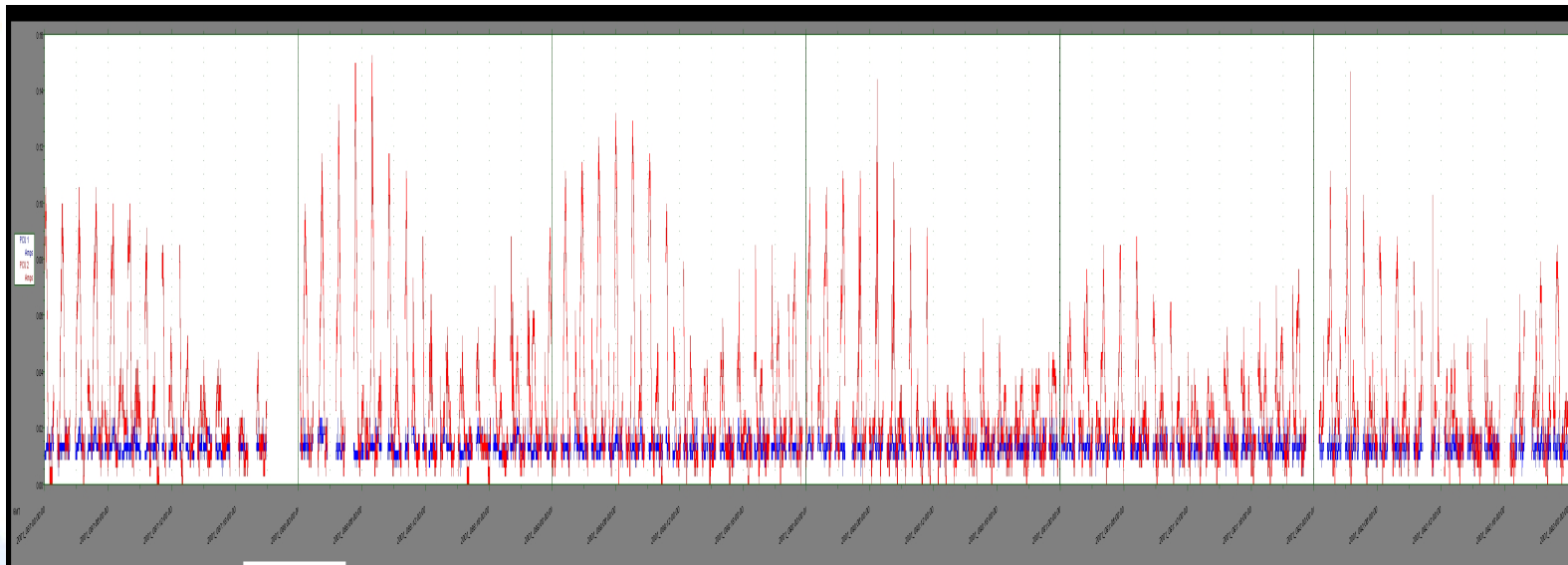

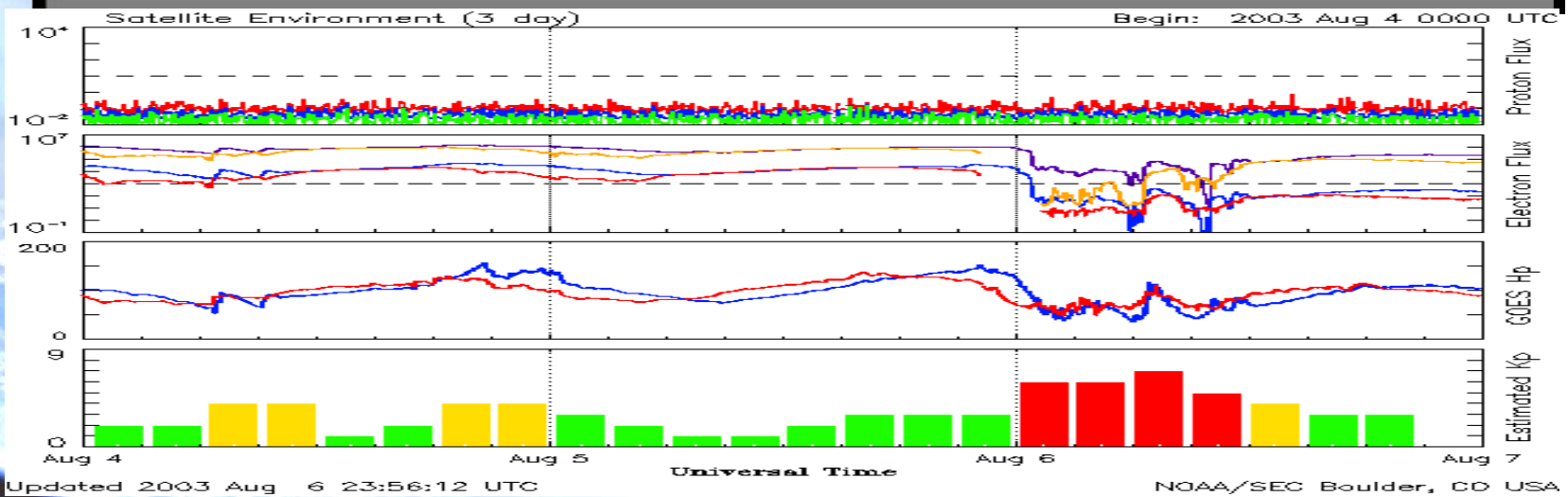
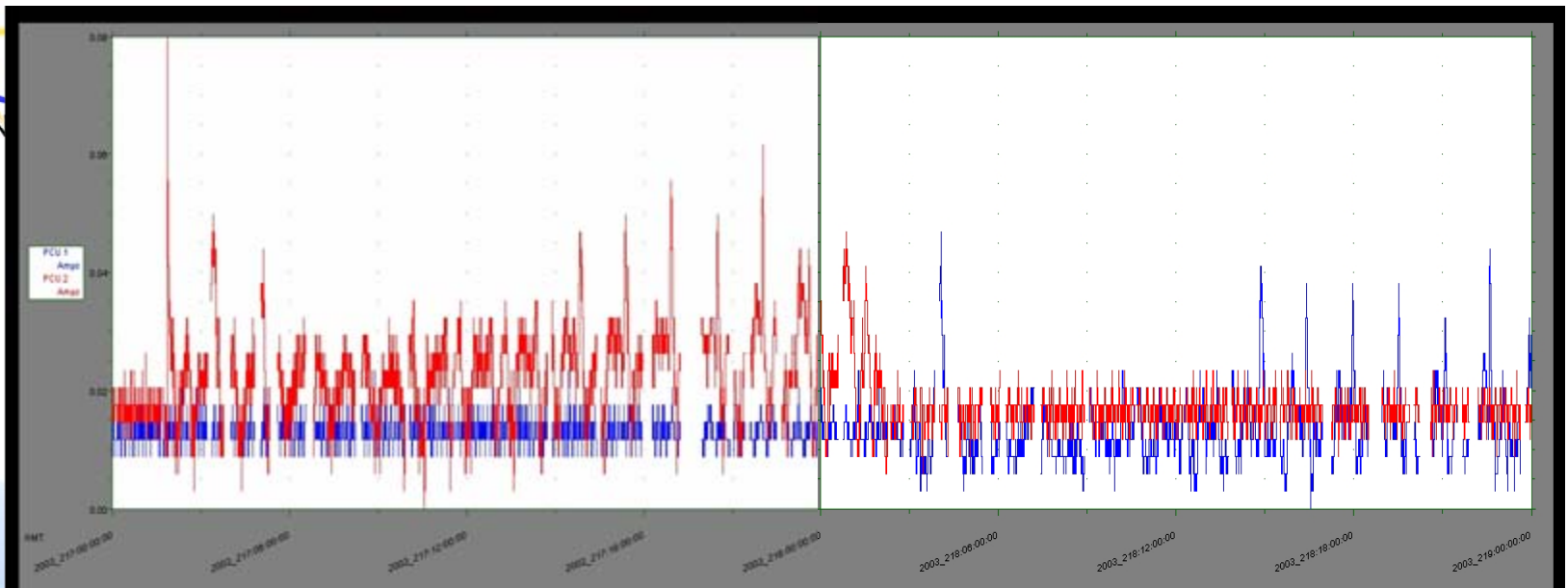

Updated 2003 Aug 6 23:56:12 UTC

NOAA/SEC Boulder, CO USA



## *Induced Environments*



S116E07154

- ***Surface contamination from materials out-gassing***
- ***Surface contamination/erosion from thruster plume impingement***
- ***Surface contamination/mechanical damage from fluid venting stream impingement or re-contact***

# *Proximity Operations*



## ***Soyuz Approach***



## ***Progress Separation*** *(Double-click blue square to start movie)*





## ***Thruster plume impingement erosion flight experiment: STS-64***

***SPIFEX Aluminum witness  
coupon showing craters  
from thruster plume droplets***

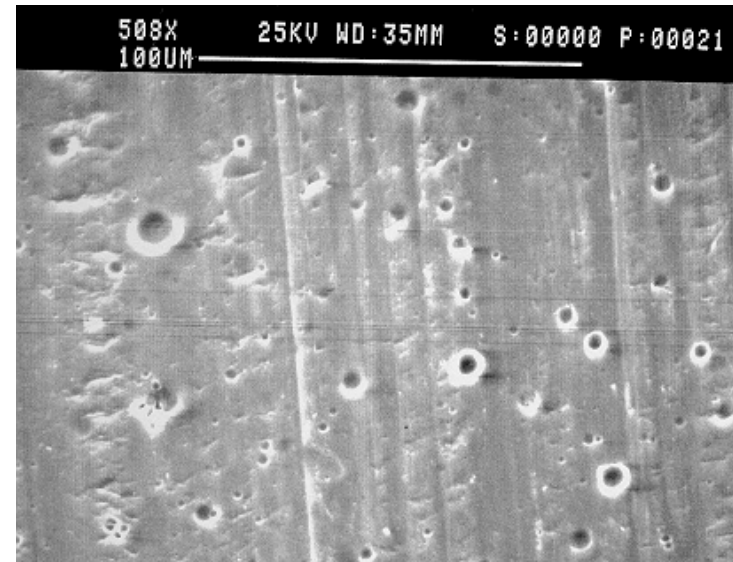

***SPIFEX Kapton witness  
coupon showing craters  
from thruster plume droplets***

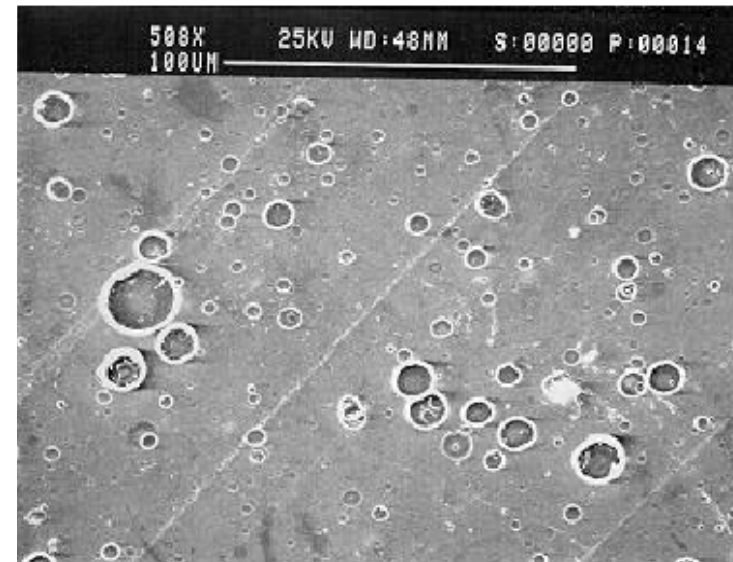

# MLM Thruster Induced Erosion Results for 100 seconds of Thruster Firing with Thruster Canting



MLM Thruster A5

Location : -77.733,5.433,50.409

Direction : 0,1,0

Surface Area Pitted (%)

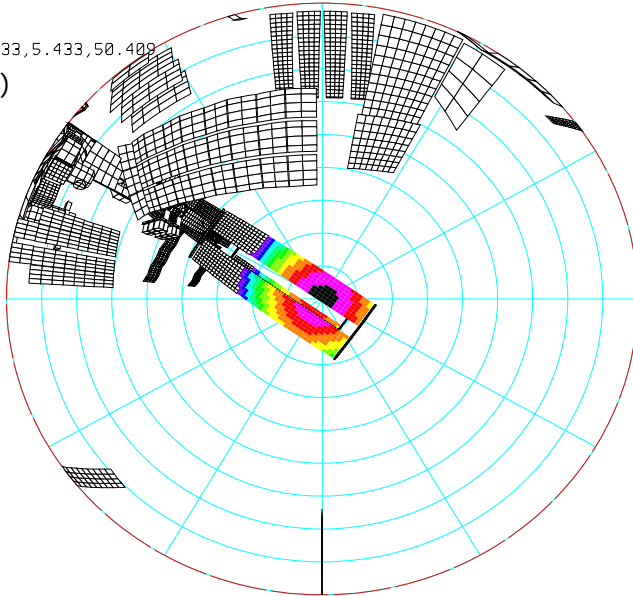

Thruster canting nadir-aft,  $\theta = 0^\circ$   
MLM Located on SM Nadir

Initial MLM design has  $0^\circ$  of canting for roll control thrusters. In this configuration, solar array feathering is required to mitigate erosion effects.

Trade studies are being conducted to determine canting angles required to allow solar array tracking during MLM thruster operations.

MLM Thruster A5

Location : -77.733,5.433,50.409

Direction : -0.354,0.866,0.354

Surface Area Pitted (%)

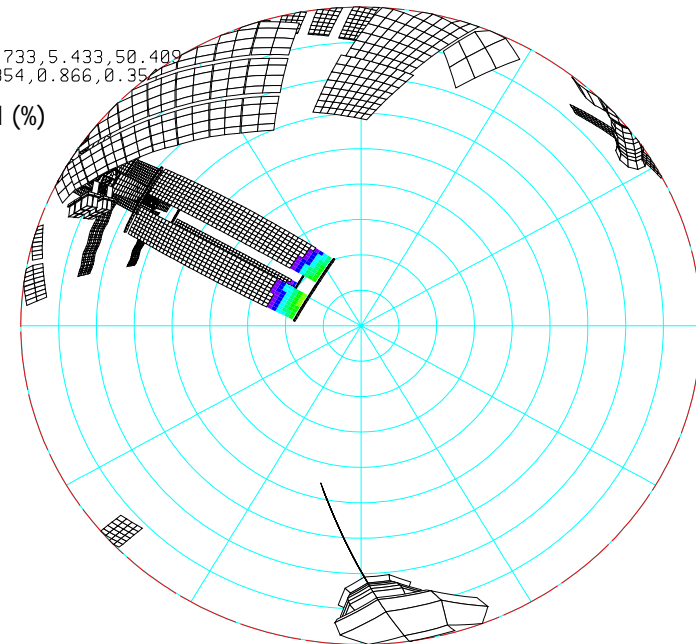
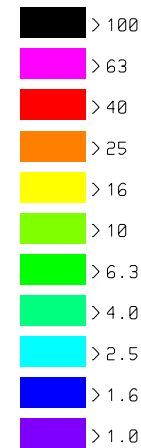

Thruster canting nadir-aft,  $\theta = 30^\circ$   
MLM Located on SM Nadir

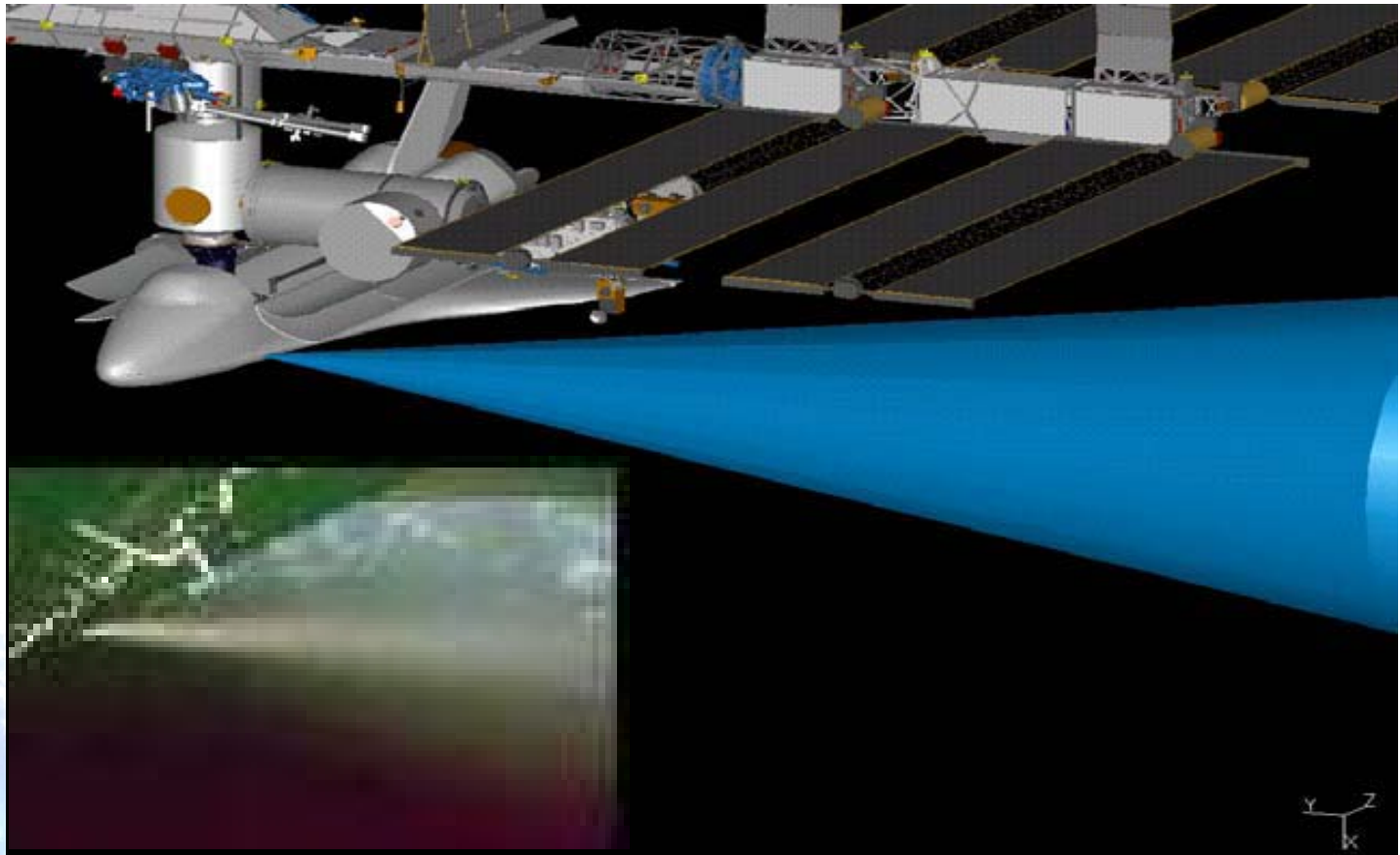

**Orbiter Water Dump Plume: Model and Flight Comparison**



# Spacecraft self contamination: molecular out-gassing and deposition - Columbus onto ISS - Original Analysis

Deposition  
( $\text{\AA}/\text{yr}$ )

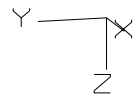
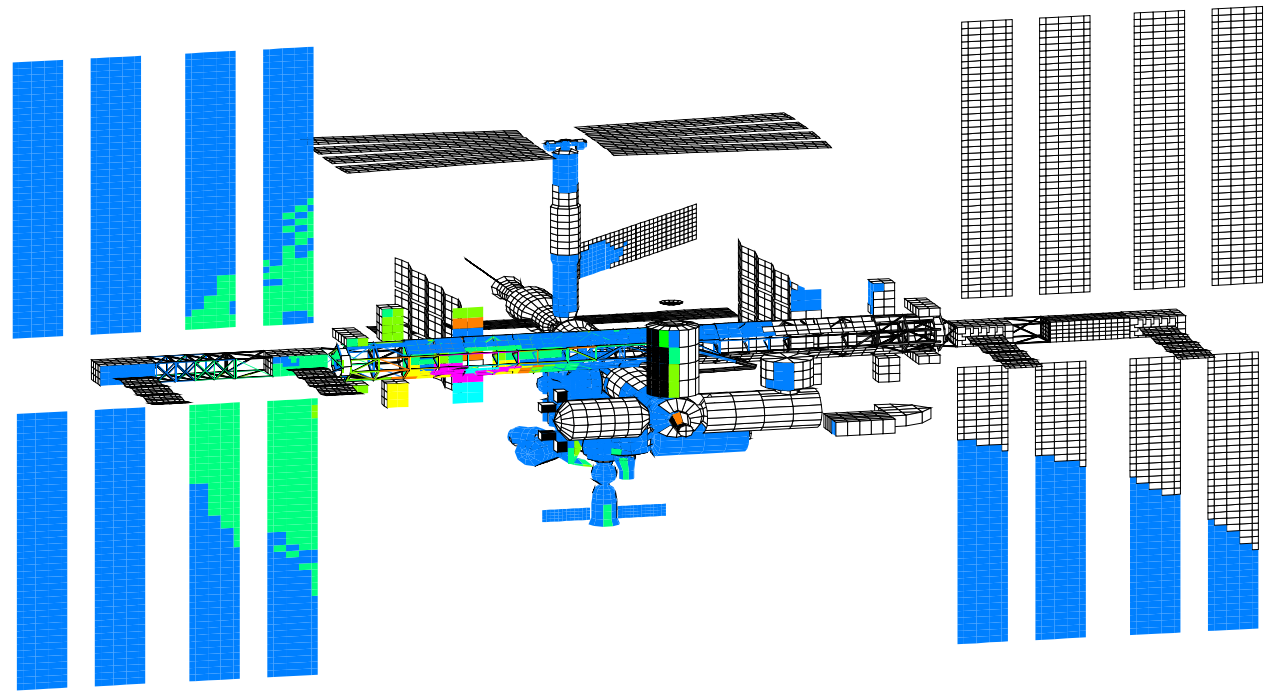

Original analysis using worst  
case ASTM-E595 data

NOT ASTM E 1559 test data

# Spacecraft self contamination: molecular out-gassing and deposition - Columbus onto ISS - Final Analysis

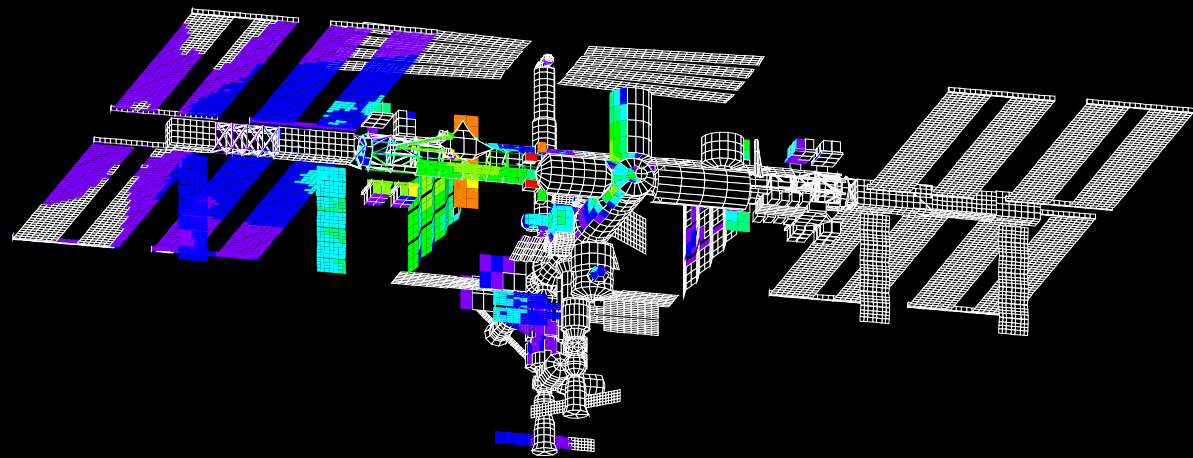

**Final analysis using ASTM-1559 data and  
NASA II transport analysis**

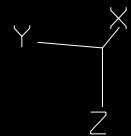

# Progress in Spacecraft Environment Interactions: ISS Products for the Future of Space Exploration – Part 1



## ● **Ionizing Radiation**

### ◆ **SEE environments at high structural shielding mass**

☞ Secondary particle production

### ◆ **Low cost approach to avionics reliability verification SEE**

### ◆ **Spacecraft advanced technology development and test platform**

☞ ISS SEE/TID environments scalable to interplanetary environments

## ● **Spacecraft Charging (Plasma) Assessment and Design Tools**

### ◆ **Accurate, verified (flight and lab data) predictive models of high voltage SAW driven charging**

☞ NASA/Boeing/SAIC Plasma Interaction Model

☞ ISS charging hazard assessment and management

☞ Design of non-charging high voltage arrays

### ◆ **Accurate, verified (flight/lab data) models of spacecraft electrostatic discharge processes for risk assessment**

☞ Plasma sheath as an active circuit element

☞ Role of grounding/bonding and EMI/EMC requirements in mitigation spacecraft charging effects.

### ◆ **Demonstration of ISS as a valuable/accessible ionospheric and magnetospheric geophysical research platform**

☞ FPMU ISR comparisons



## *Progress in Spacecraft Environment Interactions: ISS Products for the Future of Space Exploration – Part 2*

### ● **Meteor Storm Modeling and Prediction Tools**

- ◆ **Generally applicable to interplanetary and lunar/planetary surface environments**
- ◆ **Design/operate at minimum risk**
- ◆ **Operations constraints and planning**

### ● **Near Term Solar Activity Forecast Tools**

- ◆ **Neutral atmosphere density (satellite drag and torque) and atomic oxygen flux predictors for design and mission planning**
- ◆ **Possibly near term ionospheric conditions**

### ● **Induced Environments**

#### ◆ **NASAN-III**

- ☞ *NASA/Boeing/ molecular outgassing contamination transport and deposition model with 3D visualization.*
- ☞ *Atomic oxygen flux/fluence*
- ☞ *thruster vent/dump plume particle impingement, contamination effects, and verified surface damage assessments*
- ☞ *Small medium velocity particle impact damage predictors*
- ☞ *Assessment of re-contact after multiple orbits.*
- ☞ *Proximity operations planning*