

Guidance and Control of an Autonomous Soaring Vehicle with Flight Test Results



Michael J. Allen

NASA Dryden Flight Research Center

Royal Air Force Visit

May 8, 2007

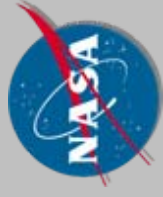

Background

- Many UAVs have similar mission constraints to birds and sailplanes.
 - Surveillance
 - Point to point flight with minimal energy
 - Increased ground speed
- Birds use atmospheric energy to hunt, forage, and migrate thousands of miles.
- Manned sailplanes rely solely on atmospheric energy
 - 2,000km (1,200mi) maximum distance.
 - Cross-country speeds in excess of 160kph (100mph)

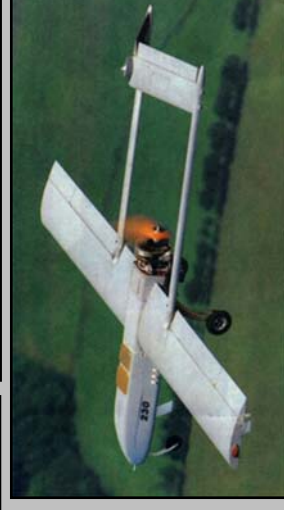



Background:

Energy sources for Unmanned Vehicles

- Fossil fuel
 - Advantages: cheap, high specific power, COTS engines
 - Disadvantages: pollution, noise, must re-fuel, cannot start & stop easily
- Solar Electric
 - Advantages: Quiet, renewable, easy to start & stop, no pollution.
 - Disadvantages: Lower specific power, more expensive, climate and weather dependant
- Atmospheric Energy
 - Advantages: Free, strong, quiet, does not require special hardware (although advanced algorithms may require faster processor)
 - Disadvantages: Climate and weather dependant, usually limited to lower altitudes (h<10Kft), requires maneuvering which may upset sensor measurements
- Best use of atmospheric energy is to augment other sources of energy.

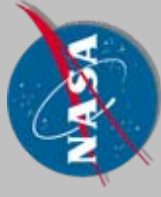

Background: Alan Cocconi

- Alan Cocconi flew the Solong UAV for 48hr using solar energy on June 1-3, 2005
 - Span = 15.6ft
 - Weight = 28.2lb
 - “The energy budget requires riding thermals.”
 - Cocconi also stated that the pilots/UAV operators were exhausted after 48hr of flying.
 - Moving map display with aircraft path was used by the pilots to soar in thermals.

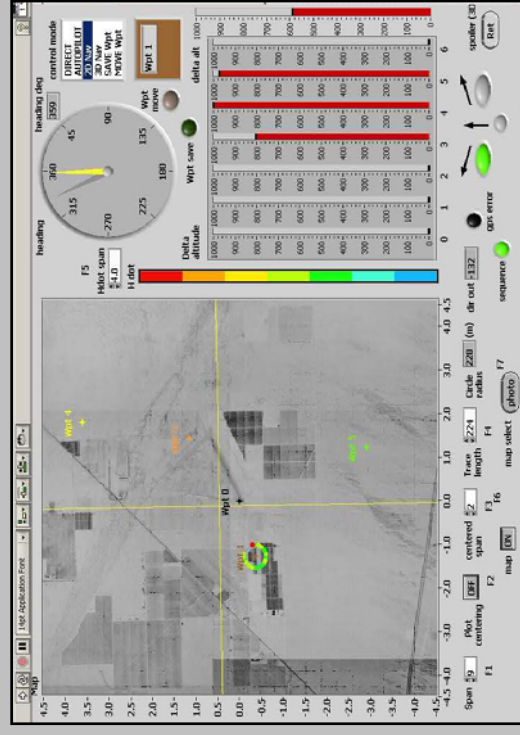

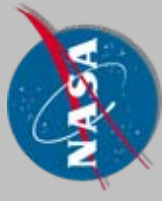

Background: John Wharington

John Wharington first proposed autonomous soaring for UAVs in 1998.

- Recursive learning was used to center updrafts. Neural networks were used to identify updraft positions.
- Algorithms were too computational intensive for real-time use.
- Framework for updraft modeling, simulation, and autonomous soaring was provided.

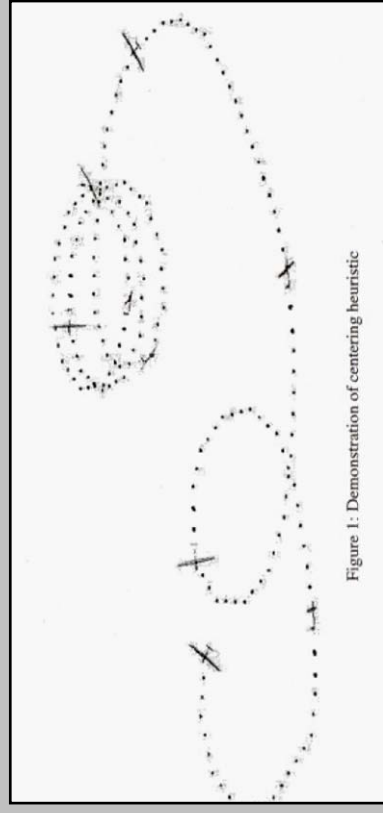
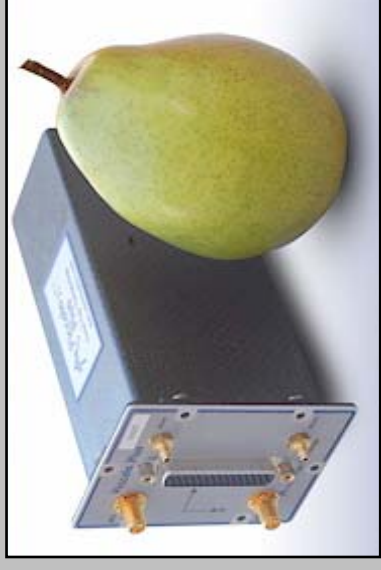

Figure 1: Demonstration of centering heuristic



Test Hardware

- Cloud Swift Aircraft
 - Span: 4.26m (14ft)
 - Weight: 6.58kg (14.5lb)
 - Stall speed: 18kt
 - Mission speed: 25kt
- Piccolo Plus Autopilot
 - Weight: 212g (7.5 oz)
 - Sensors:
 - Rate gyros
 - Accelerations
 - Static & total pressure
 - GPS position & velocity
- Custom software developed for this project



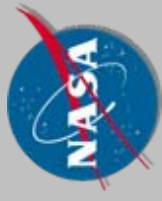

Flight Test, Guidance and Control for Thermal Soaring

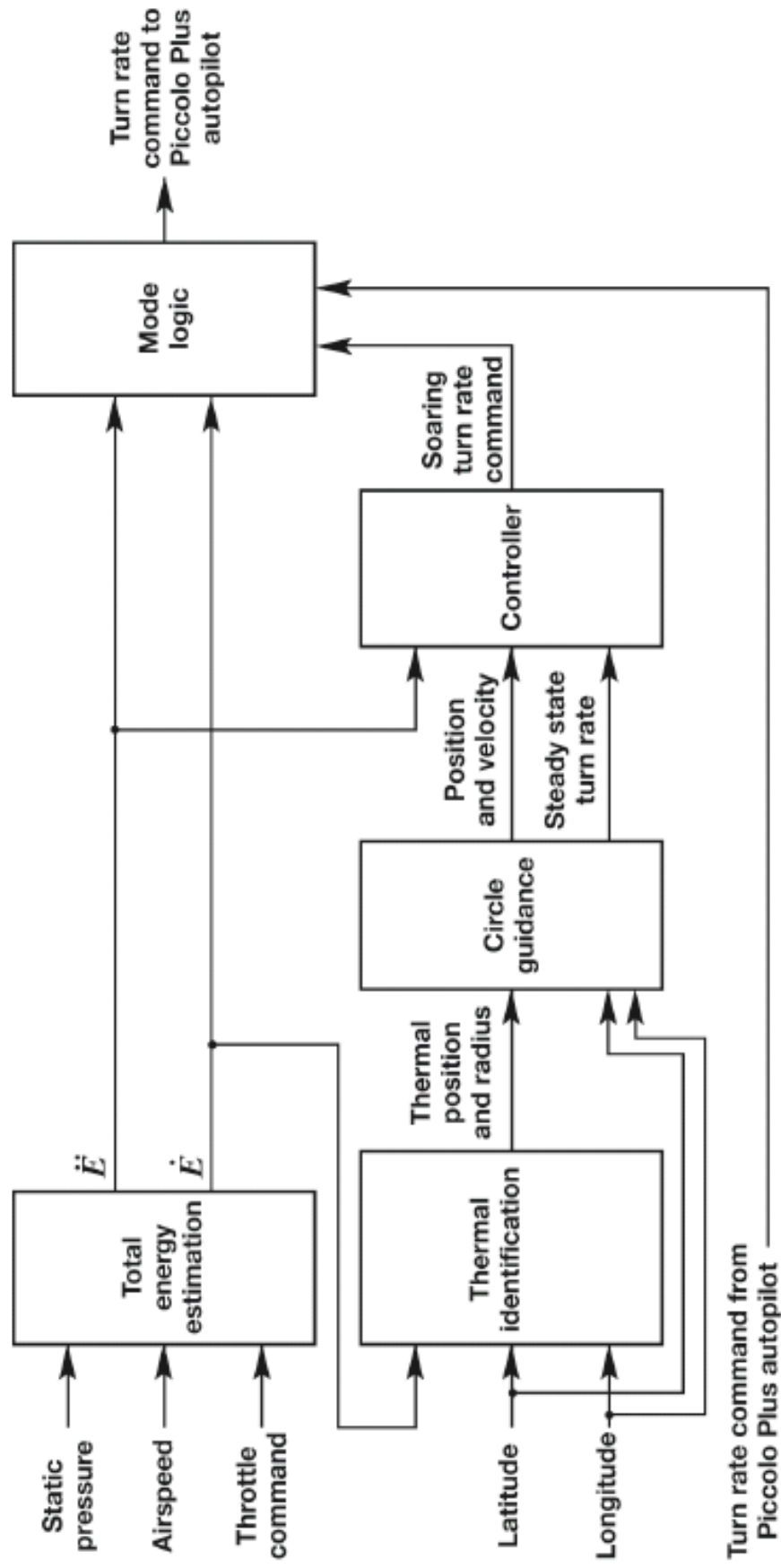

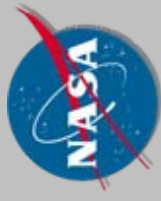

Flight Test Plan

Soaring research flights

- 4,000ft AGL altitude restriction
- Conducted on the edge of Rogers Dry Lakebed
- August – October, 2005

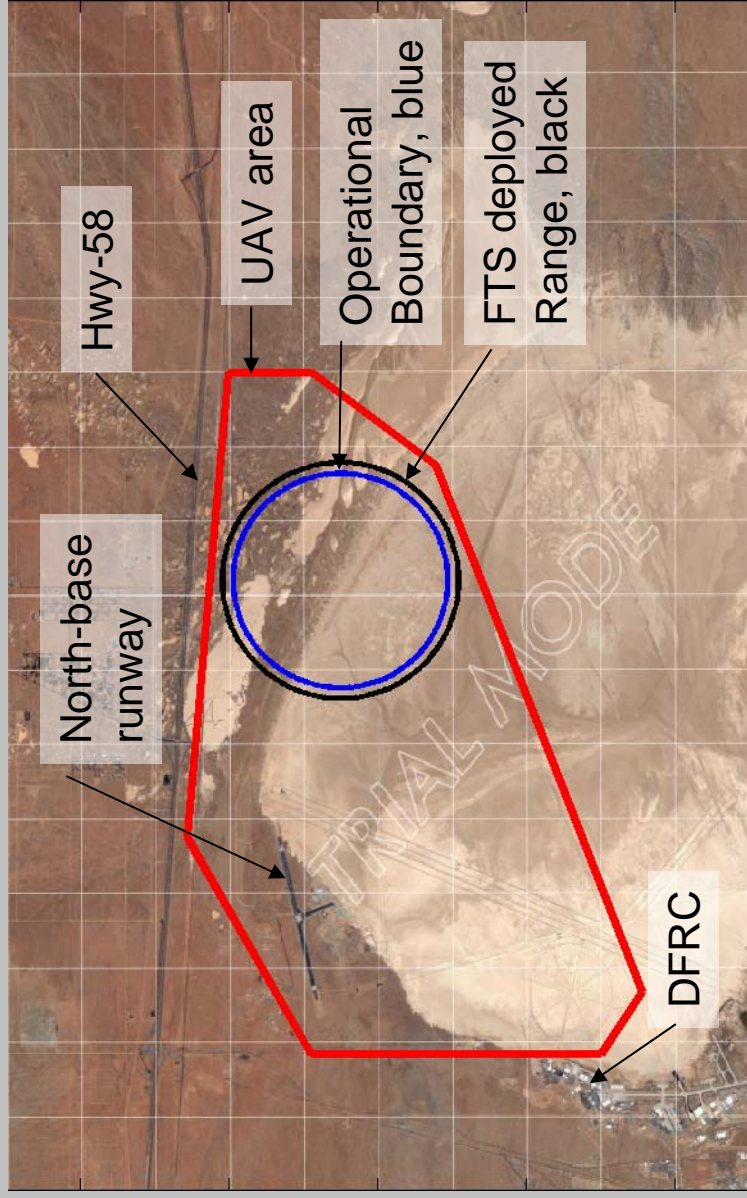

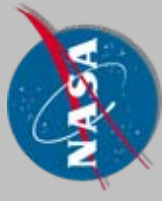

Flight Test Results

- 23 updrafts were autonomously detected and used
- Average height gain was 172m (567ft)
- [Play cloudSwift_flt08_pr.mp2v](#)



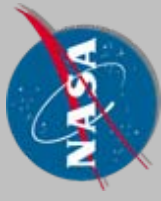

Thermal State Estimation

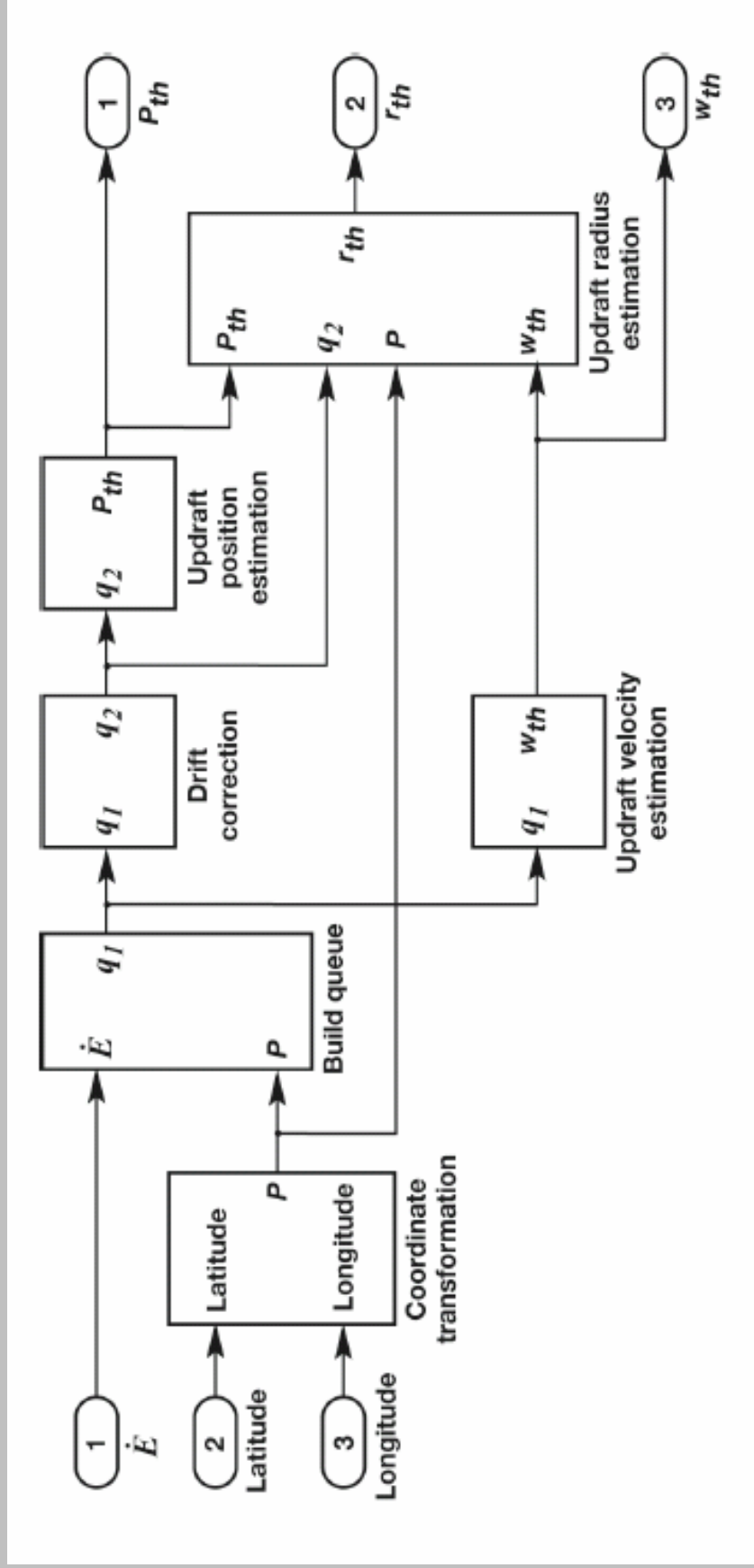



Thermal Drift Estimation

- Drift velocity was estimated from previous values of energy rate.
- Drift was used to define a new reference frame that is moving with the thermal.

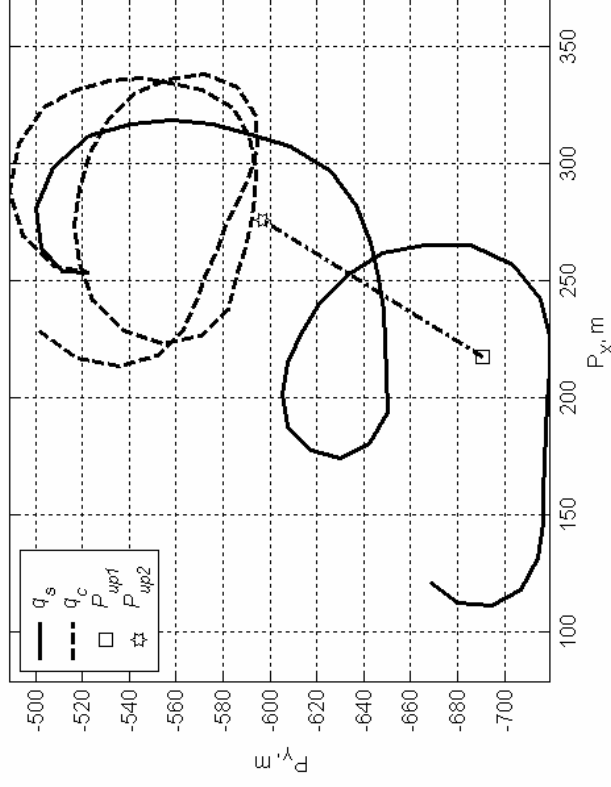

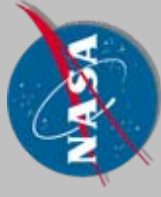

Thermal Radius Estimation

- Thermal radius was estimated by iteratively fitting an assumed thermal velocity distribution to the energy rate measurements.

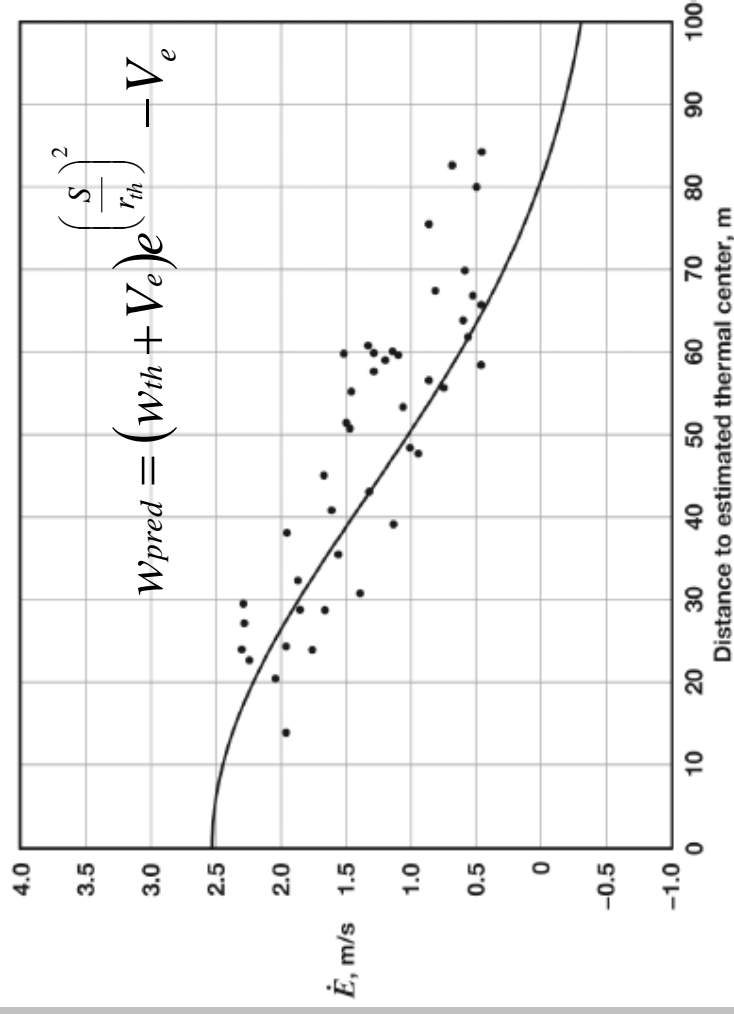

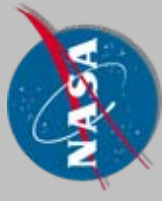

Thermal Position Estimation

- Position was estimated by finding the position centroid of the measured energy rate.
- Advantages: Low computational cost, no tuning required, robust to variations in thermal size.
- Disadvantages: Bias toward the center of the measurement set.

$$X_{th} = \frac{\sum X * \dot{E}^2}{\sum \dot{E}^2}$$

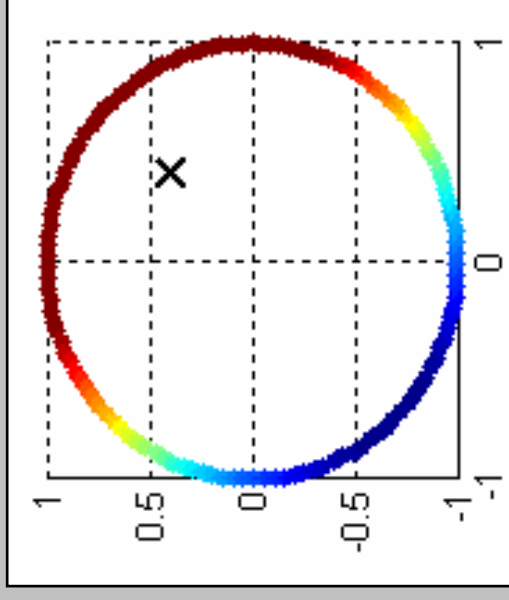

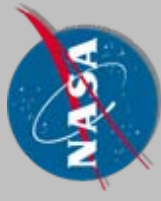

Flight Test Results

- Soaring flight in light lift shown.
- Two small thermals encountered.
- Thermal centering performance could be improved.
 - Energy rate estimation delay.
 - Slow down when soaring.
- Altitude gain = 300ft

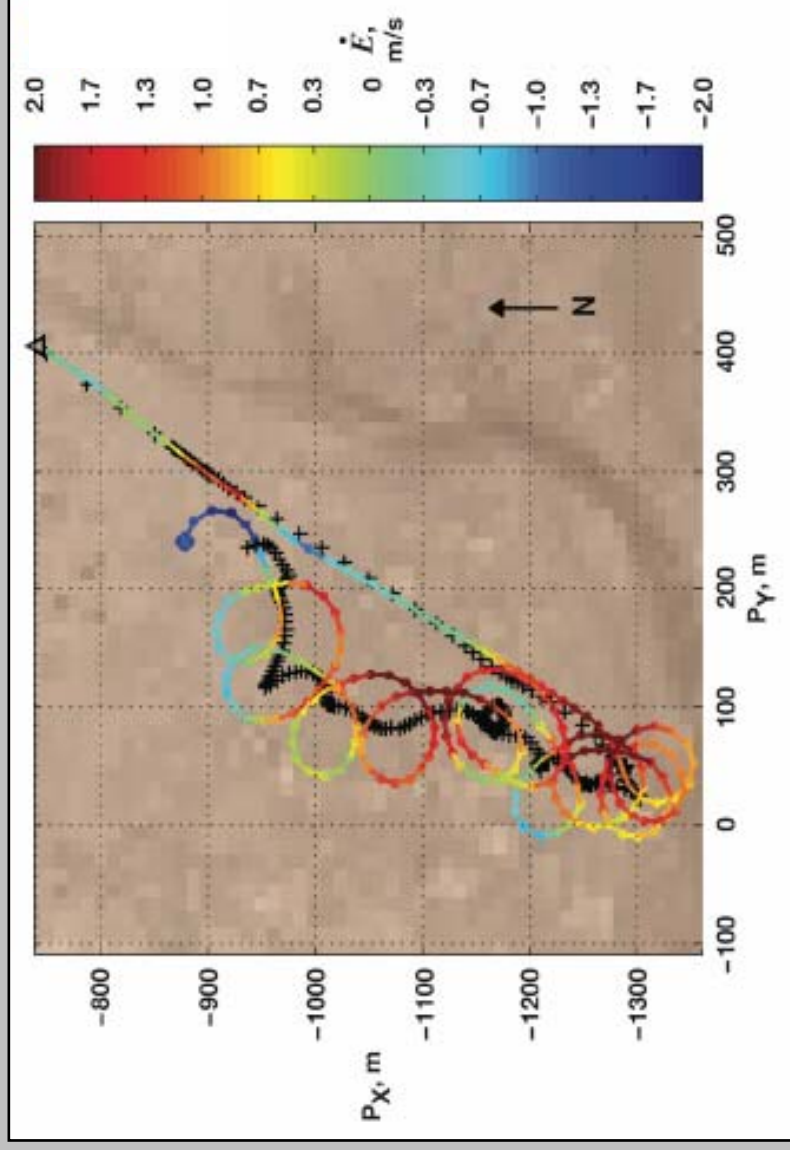



Mode Logic

- Simple mode logic was able to determine when to soar and when to search.
 - Input:
 - Total energy rate
 - Total energy acceleration
 - Output:
 - Soaring on/off
- Possible improvements:
 - Quicker estimate of aircraft energy
 - Additional mode that would allow the UAV to “Investigate” the thermal before moving on.

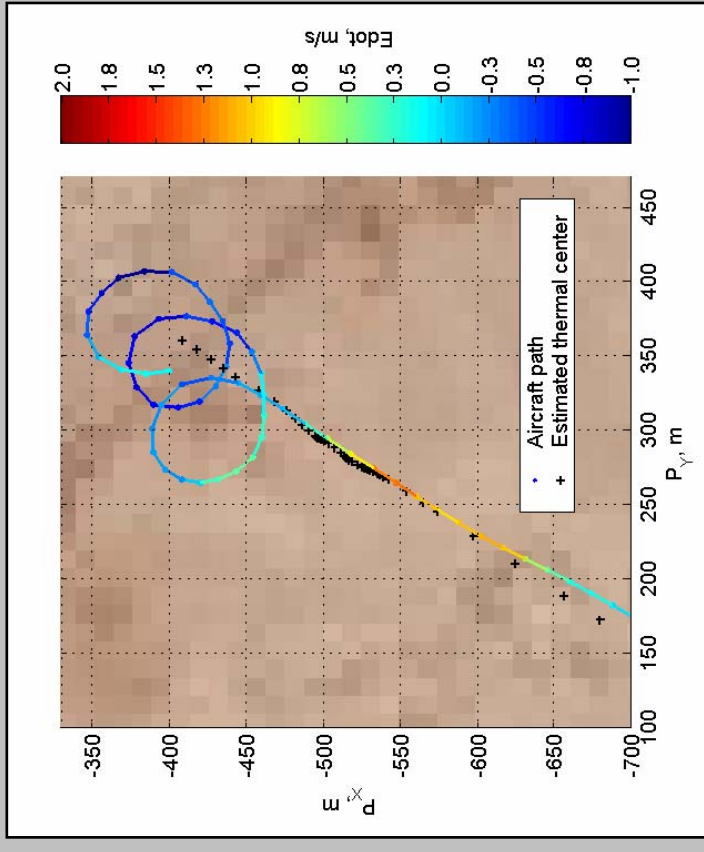

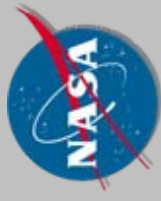

Flight Test Results

September 9, 2005

- Highest climb in a single updraft shown.
- 844m (2770ft) altitude gain.

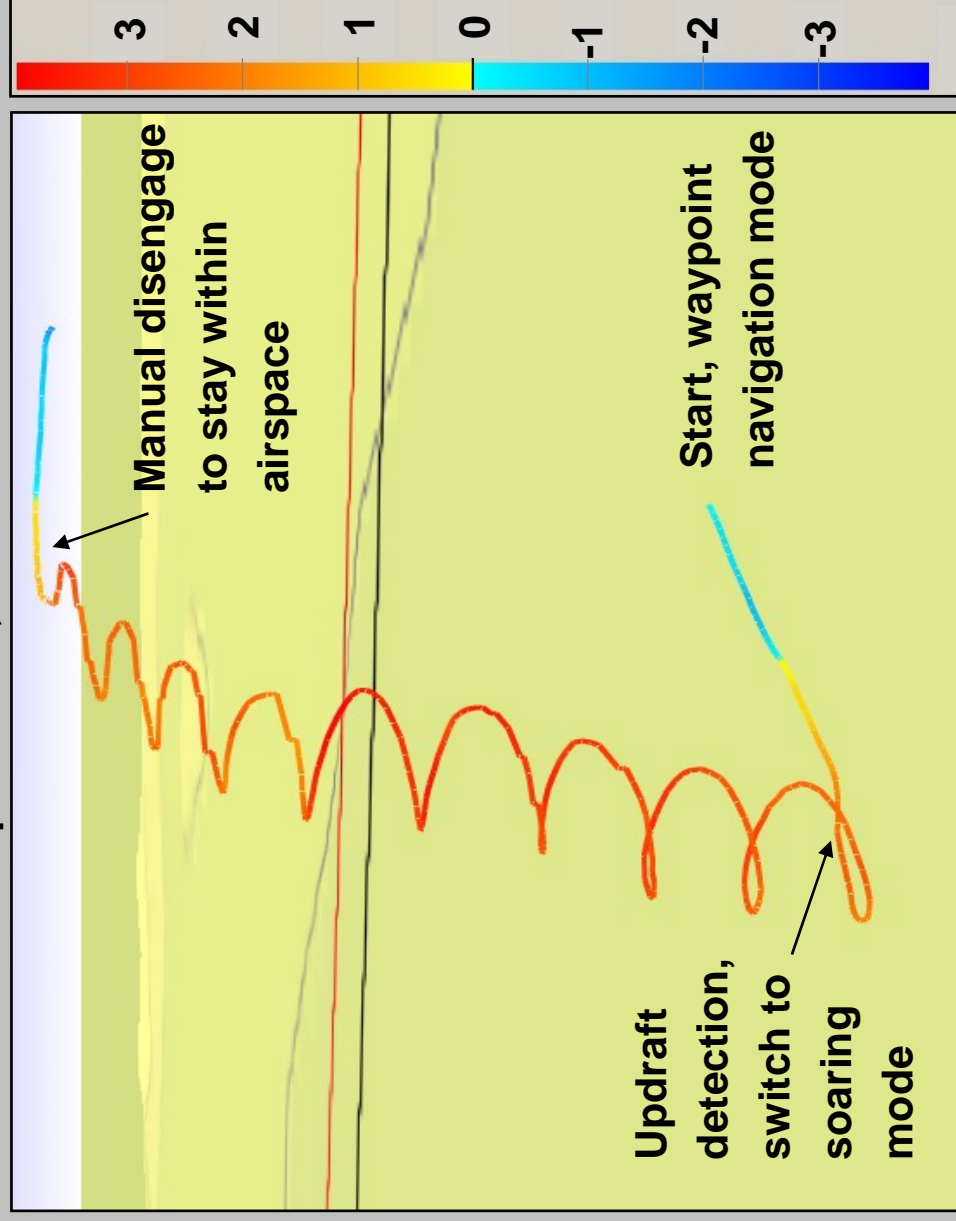

- **Play:** [cloudSwift_ft12_up2.igc](#)

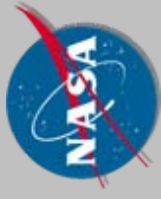

Flight Test Results

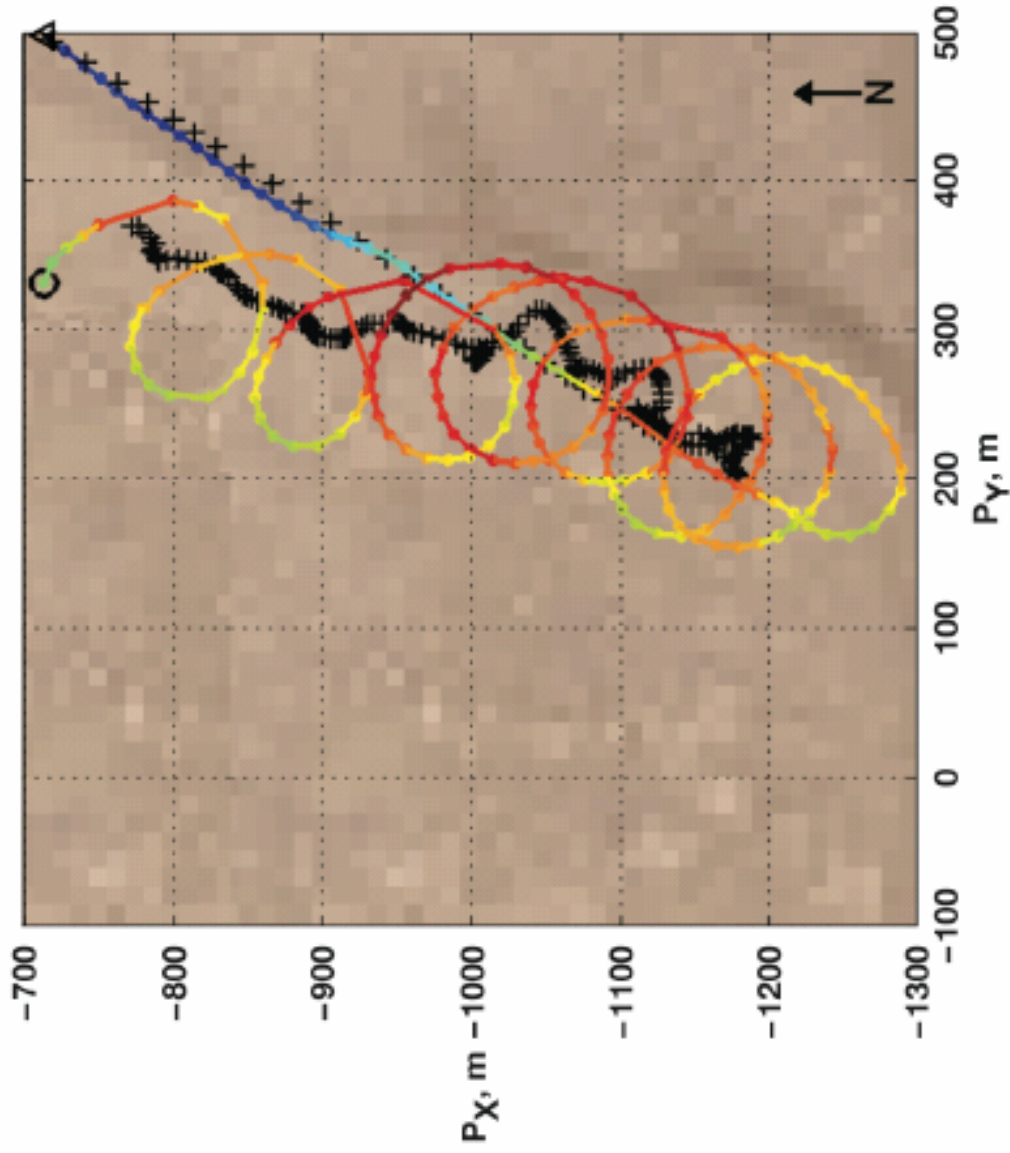

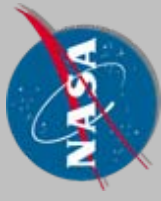

Flight Test Results

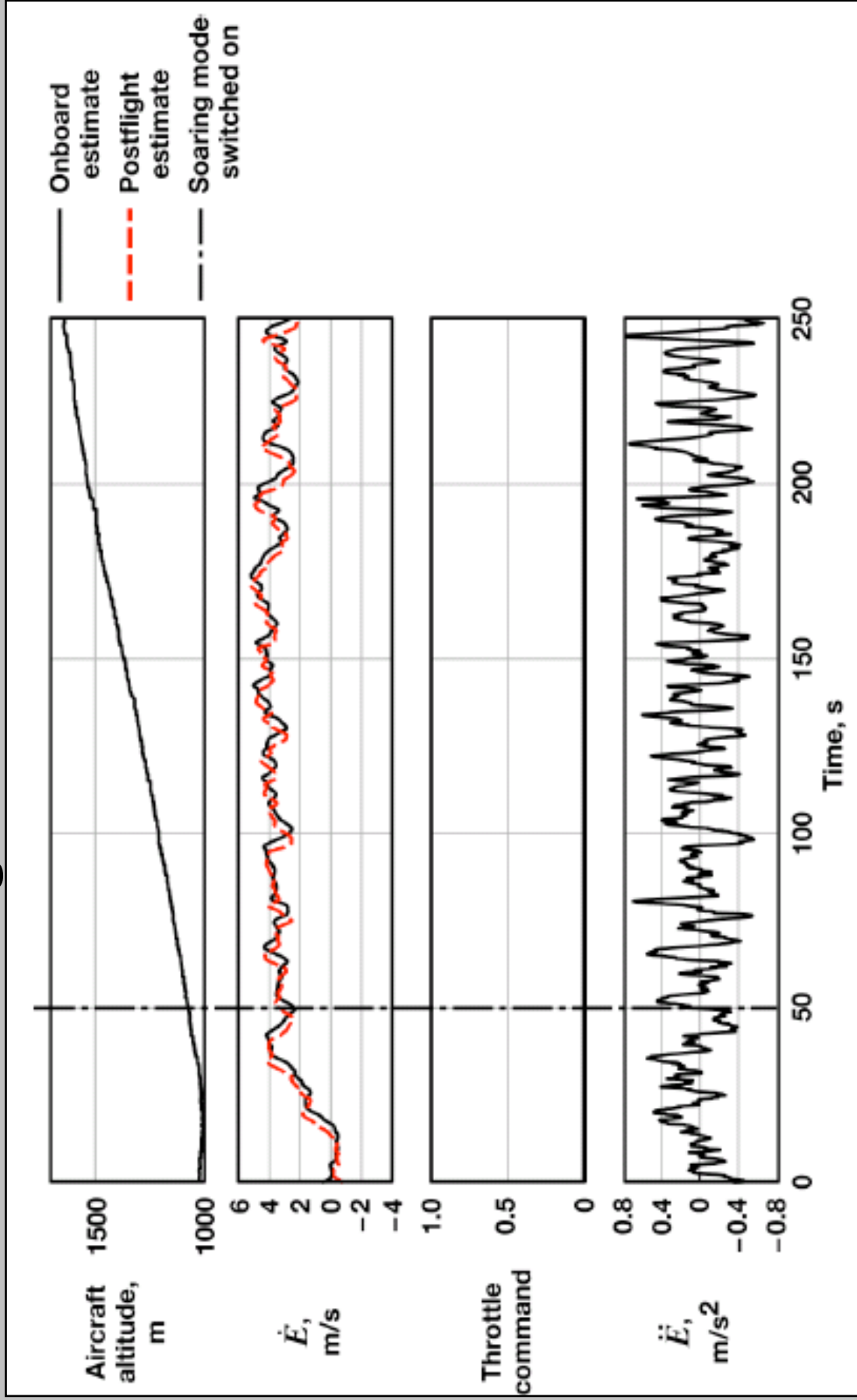



Flight Test Results

- Multiple thermals were used to soar autonomously for over an hour.
- Flight was limited only by actuator battery capacity.
- Altitude time-history is similar to that of migrating birds.

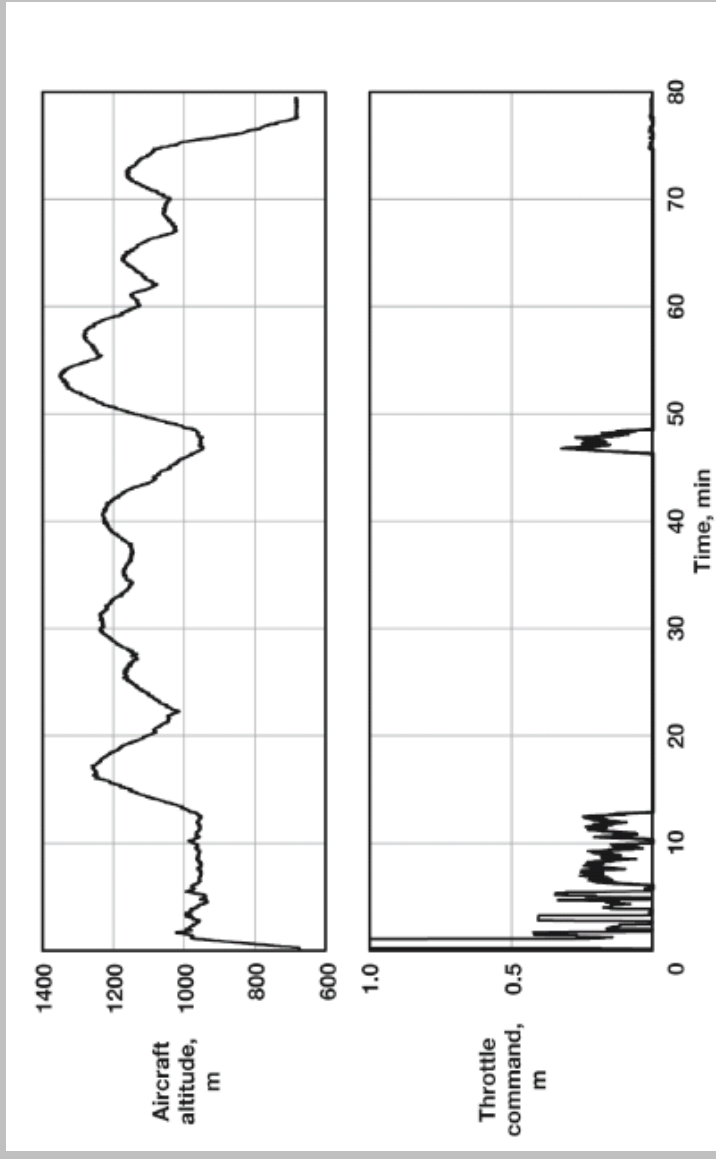



Concluding Remarks

- A guidance and control method was developed to detect and exploit thermals for energy gain.
- Latency in energy rate estimation degraded performance.
- The concept of a UAV harvesting energy from the atmosphere has been shown to be feasible with existing technology.

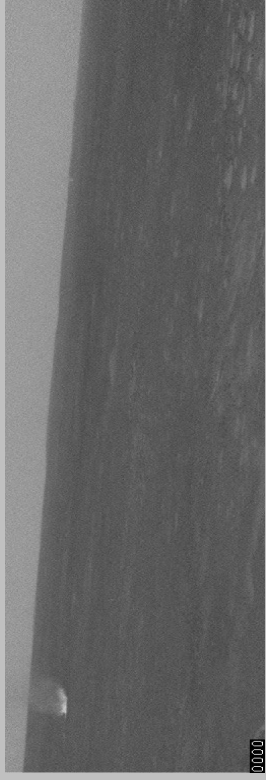

0000

Questions?

