

AN ADVANCED HELIUM BUFFER SEAL FOR THE SSME, ATD OXYGEN PUMP

Wilbur Shapiro
WSA, Inc.
Niskayuna, New York



NASA

- Phase I and Phase II
- Contract - NAS3-97023
- Contracting Officer - Glen Williams
- COTR - Margaret Proctor
- Stein Seal Company - Major subcontractor for Phase II manufacture and test

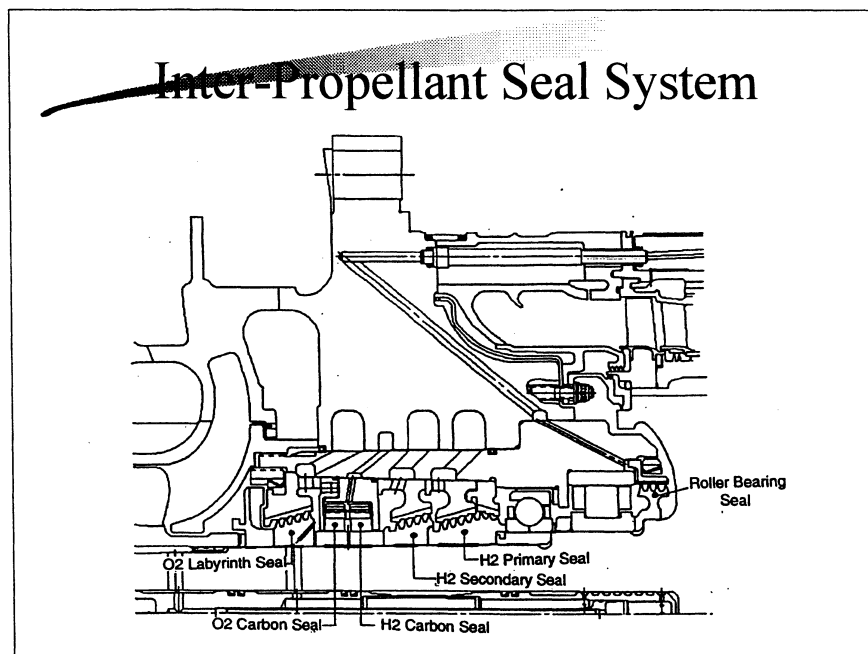

The Inter-Propellant Seal System on the Shuttle Oxidizer pump separates oxygen on the pump side from Hydrogen in the turbine drive region. It consists of a series of pressure breakdown labyrinths on both the hydrogen and oxygen sides. The helium buffer seal (HBS) is located between the hydrogen and oxygen regions and pressurized helium gas prevents egress of fluid from one side to the other. The present configuration of the HBS consists of a pair of opposed carbon rings that are forced axially against their containment housing. Leakage occurs through the clearance between the rings and the shaft. Pressures on the hydrogen side are reduced by the labyrinths from 4968 psia to 31 psia, and on the oxygen side pressure is reduced from 258 psia to 19 psia.



109% RPL Operating Conditions

Buffer Fluid	Helium
Speed	24,230 rpm
Viscosity	2.8×10^{-9} lb-s/in**2
Gas Temperature	487 deg. R
Buffer Pressure	121 psig
Hydrogen Drain	14 psig
Oxygen Drain	4 psig

The 109% Rated Power Level (RPL) condition is where most of the operation will occur. Helium conditions are indicated on the table shown on slide 4.



Objectives

- Leakage of present configuration = 239 SCFM
- Reduce Helium Consumption- 50 SCFM (will result in significant increase in payload)
- Maintain Space Envelope
- Configurations- T-Seal, L-Seal

The objectives of the Phase I effort were to :

- Complete analysis and designs of helium buffer seals for the P&W alternate SSME oxygen pump that could reduce helium leakage to 50 SCFM or less.

The configurations investigated included:

- A T-seal including a secondary seal design that would eliminate high startup preload.
- Back to back L-shaped sectored seals (L-Seal).

Phase II will accomplish build and test.

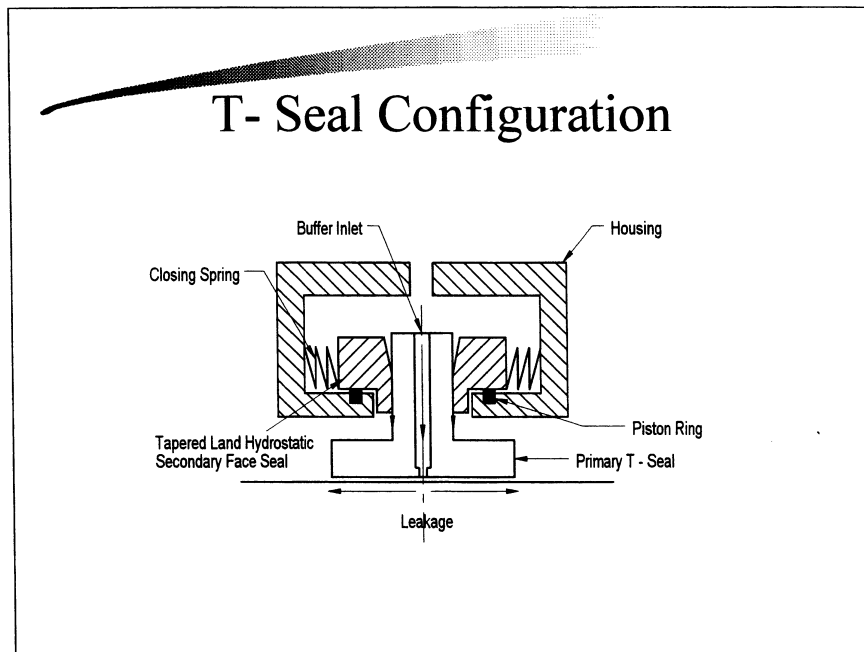

The T-Seal configuration consists of a solid carbon ring with a T-shaped cross-section as viewed at the bottom. At the mid length, 36 equally spaced inlet holes are drilled of 0.020 in. diameter to hydrostatically feed the interface clearance region between the seal and the shaft. The vertical leg of the T is sealed by two opposed hydrostatic tapered land seals that are energized by the pressure buildup in the seal cavity. Activation in this manner precludes high startup clamping loads that could prevent development of the secondary seal film.

The advantages of the T-Seal are

- It makes maximum use of available length.
- It conserves leakage because of the pressure drop through the orifice.
- It can track shaft excursions because of frictionless support.

T- Seal Design

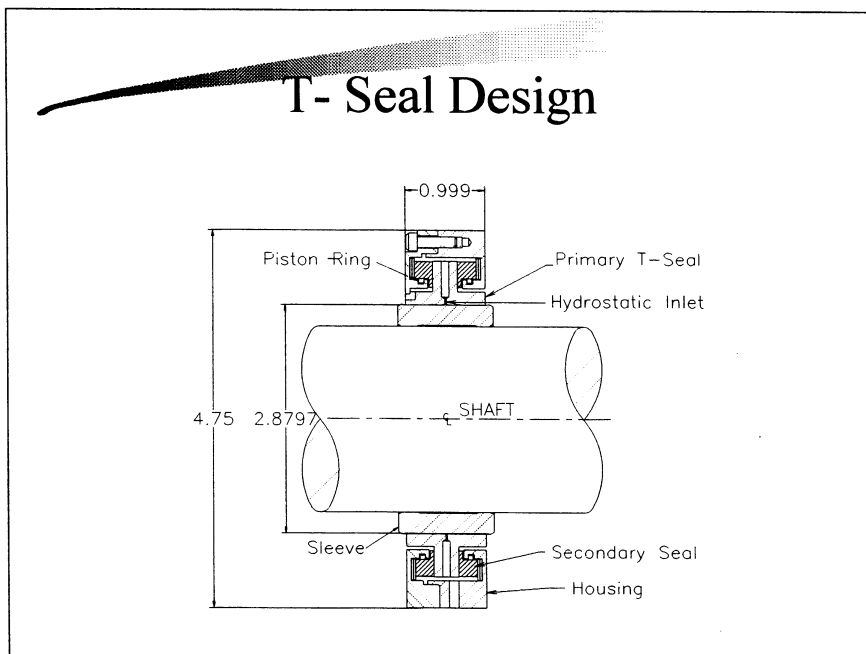

The shaft sleeve diameter is 2.88 in with an overall seal length of 1 in.

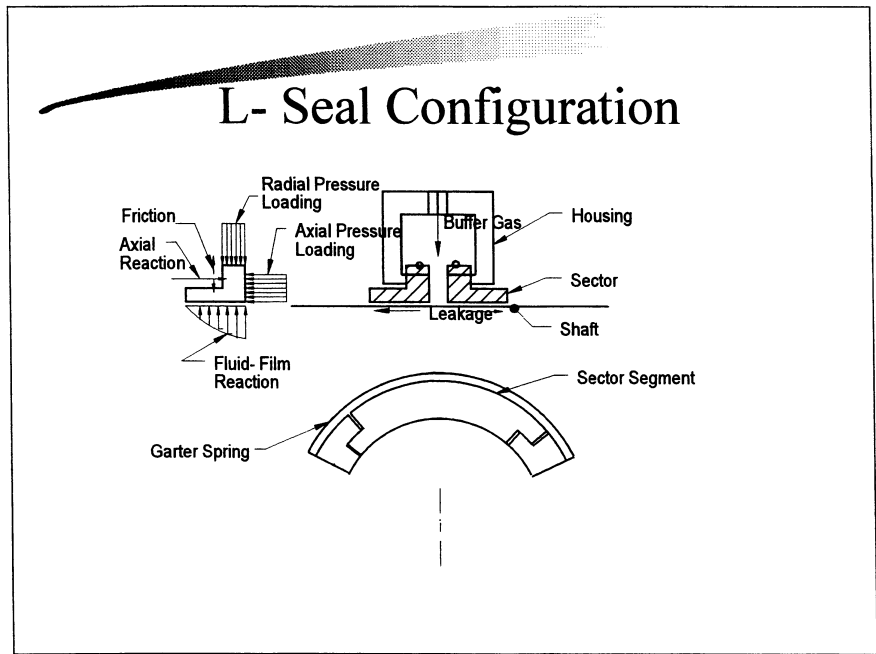

The L-Seal consists of two back-to-back sectored circumferential seals each of which are 0.5 in. in length. The concept is shown diagrammatically on slide 8. The configuration allows added interface length because it can extend beyond the inner walls of the housing. The actual design length ends at the outer housing wall so that the seals can fit into the space provided by the existing buffer seals.

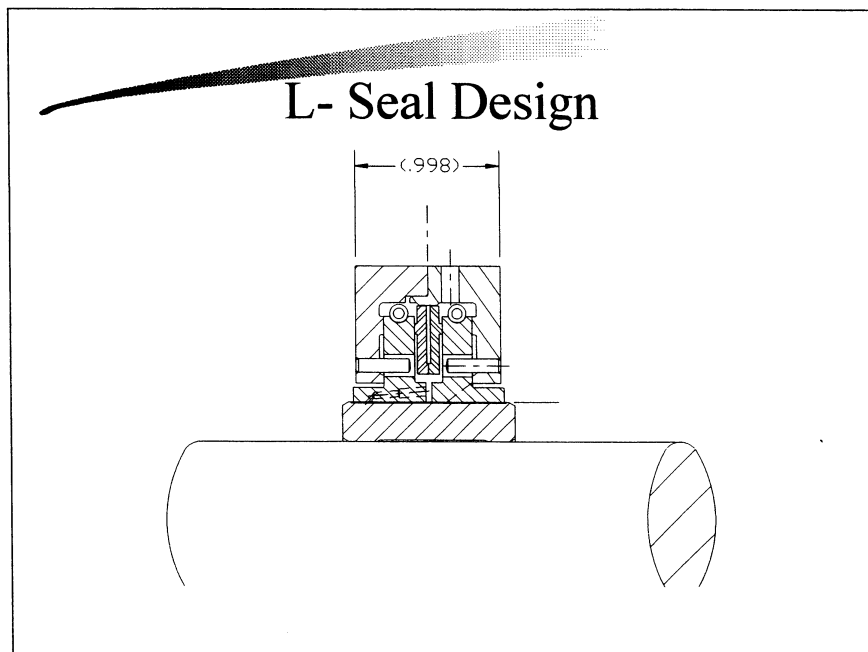

A variety of interface geometries was considered including a plain surface, taper, Rayleigh- Step and Hydrostatic. Comparative studies indicated that the best compromise was the orifice compensated hydrostatic seal. It operates well at all speeds and provides good performance at higher clearances and higher pressures. It will also act hydrodynamically at low clearance conditions and thus provide an added safety factor. Considerable effort was applied to the spring design because a comparatively heavy force was required for moment balance.

L-Seal Sector Moment Balance

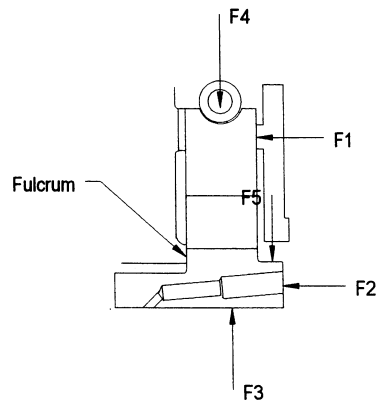

To prevent an overturning moment the spring force on the sector equals 34 lbs. And the total axial load is 100 lbs. The friction force on the sector will add an additional 20 lbs to the radial load. The operating film thickness to overcome the total force will be approximately 0.1 to 0.2 mils which is considered too marginal for the application.



L-Seal Eliminated for Phase II

- High spring load required for moment balance
- High friction results
- Film thickness - 0.1-0.2 mils

Although designs were completed, the L-Seal was eliminated from Phase II consideration because of marginal performance and the far superior performance of the T-Seal.

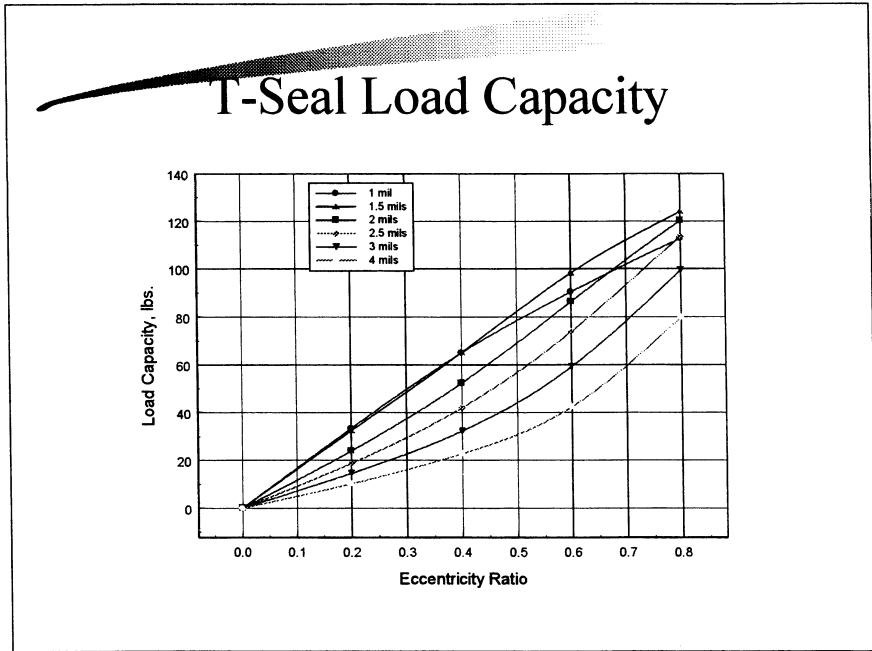

Maximum load occurs at a radial clearance of 1.5 mils and not at the 1 mil clearance that may be expected. Hydrodynamic capacity is not significant at the maximum speed of 24,230 rpm and hydrostatic action is the principal source of load capacity. At the 1 mil condition, the preload from the unloaded side reduces the net load capacity.

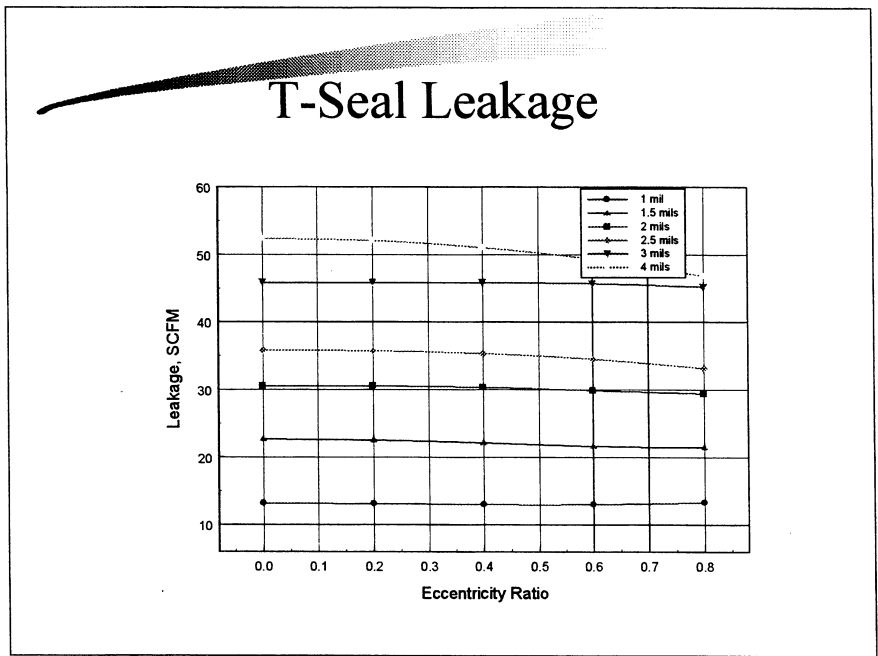

The target leakage of 50 SCFM is approximately 80% less than the two separate seals of the present back to back ring seals. To produce leakage less than 50 SCFM, the operating radial clearance should be no greater than three mils.

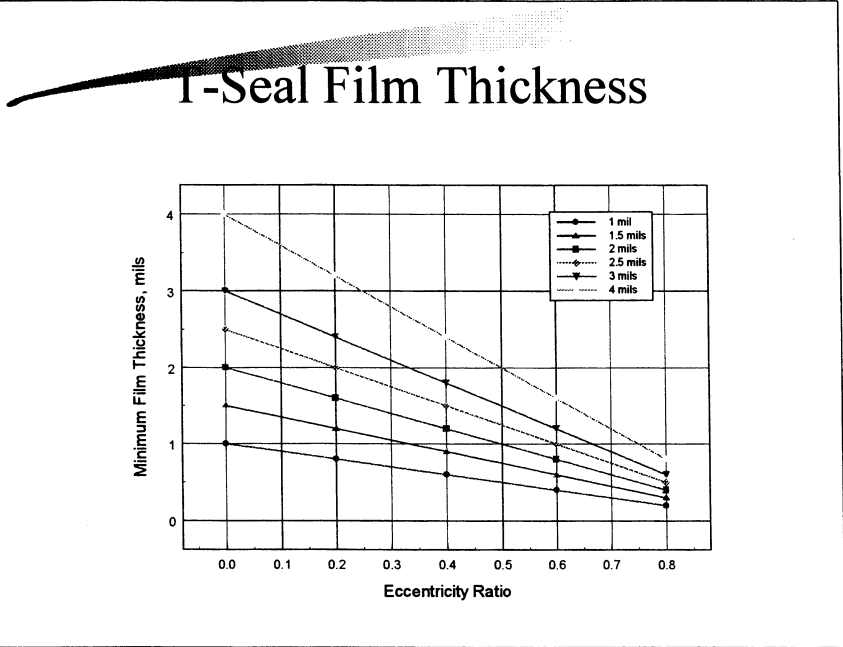

Minimum film thickness is quite adequate even at large eccentricities, because of the relatively large concentric clearances involved. It is anticipated that the seals will be operating in the concentric position because of the near frictionless support of the secondary seals.

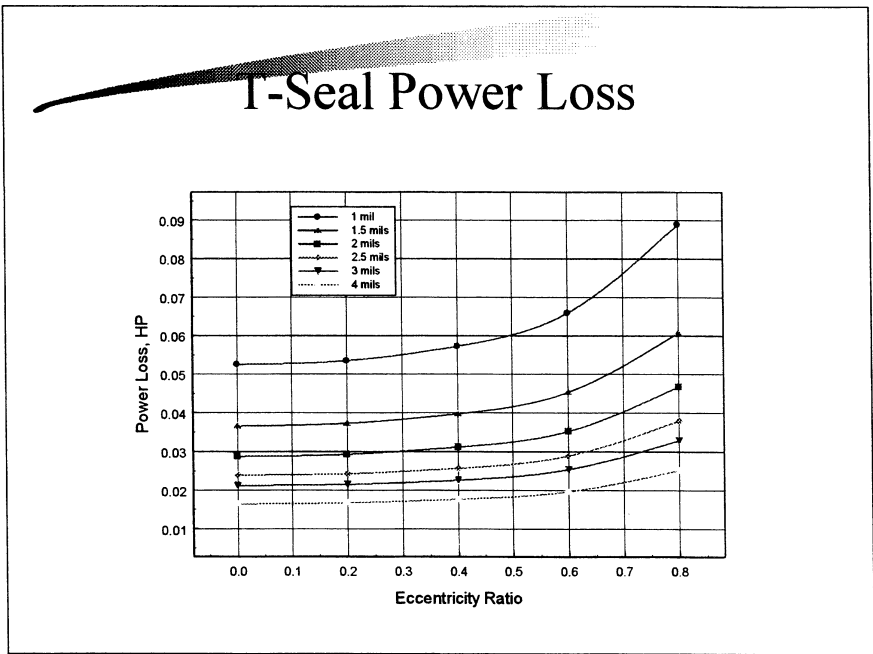

Power consumption is small, and less than 50 watts in most of the operating range.

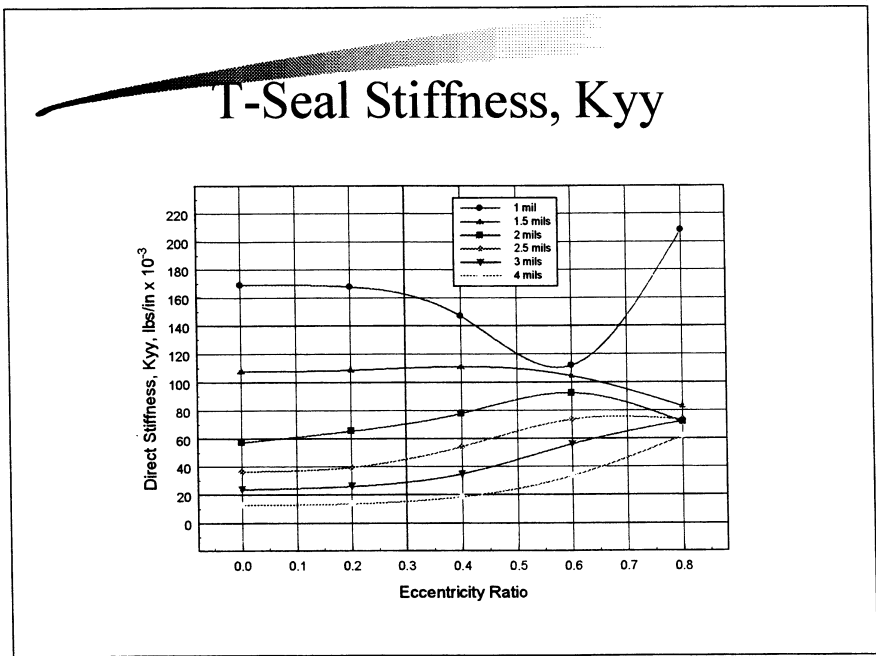

Direct stiffness curves, K_{yy} , indicate a reduction in stiffness at the one mil clearance, until an eccentricity of 0.6, and the stiffness trend reverses and markedly increases, because the hydrodynamics take hold at the lower clearance levels. At a 2.5 mil operating clearance, the stiffness is approximately 40,000 lbs/in.

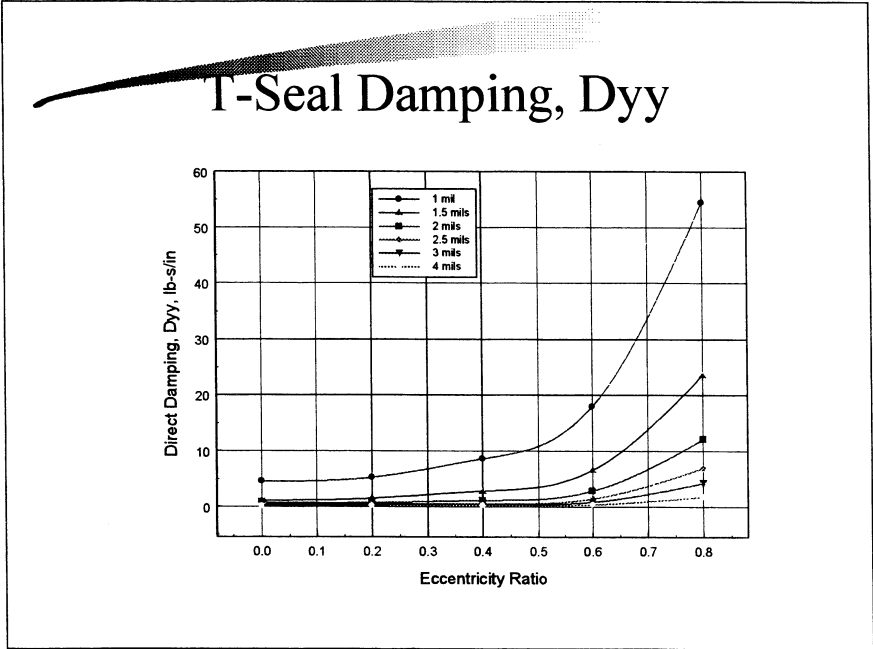

Damping increases markedly with eccentricity ratio. At 2.5 mils in the concentric position the direct damping is 0.45 lb-s/in.

T-Seal, Secondary Seal - Load

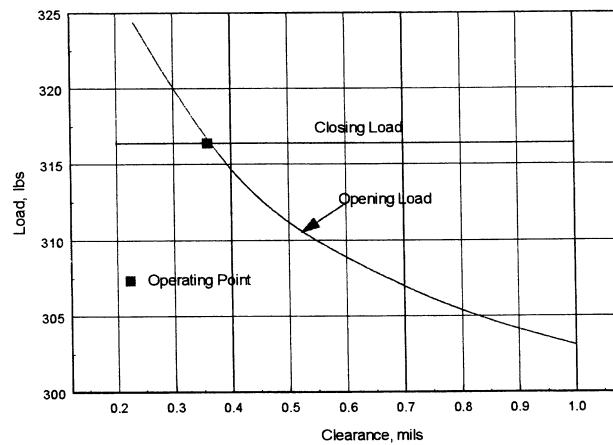

The closing load on the secondary seal was sized to provide a film thickness of about 0.37 mils. The operating film thickness can be small (0.2 to 0.4 mils) because there is no rotation between the opposed surfaces, although there can be motion due to shaft excitation.

T-Seal, Secondary Seal-Leakage

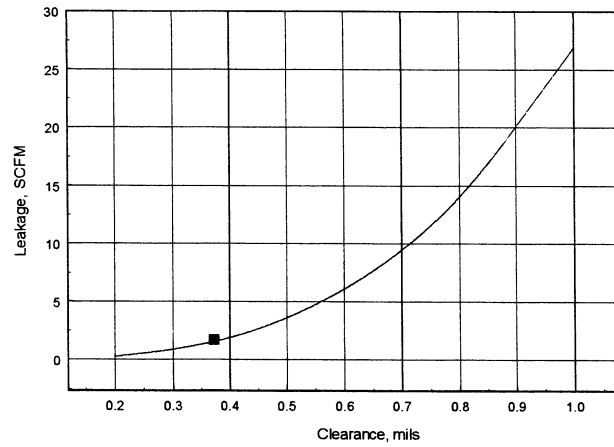

Total Leakage for the two secondary seals is less than 4 SCFM.

T-Seal, Secondary Seal- Kzz

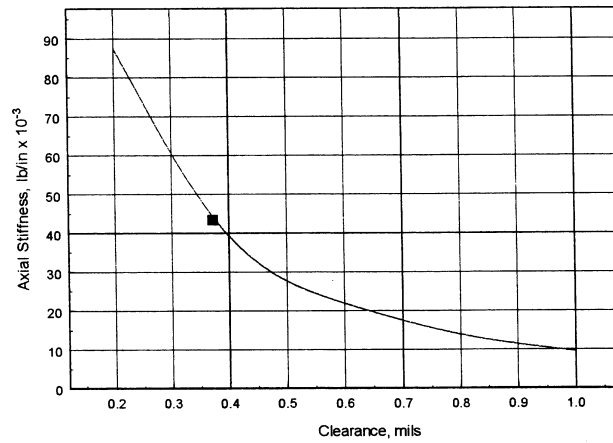

The axial stiffness is approximately 50,000 lbs/in, which is more than adequate to maintain separation during seal ring excursions.

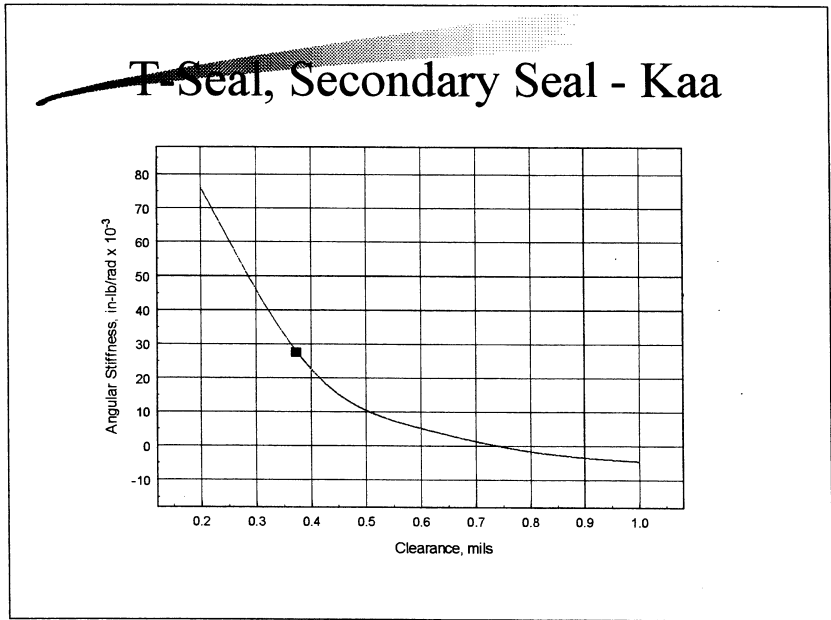

The moment, or angular stiffness remains positive for the operating range, and does not go negative until the film thickness exceeds 0.7 mils, a condition that cannot be encountered because of the hydraulic closing load. The tapered land moment stiffness remains positive at the lower operating clearances. A hydrostatic seal, that was an alternative had negative moment stiffness at lower clearances and turned positive at the higher clearances which opposite to the desired response.

T-Seal, Secondary Seal, Dzz

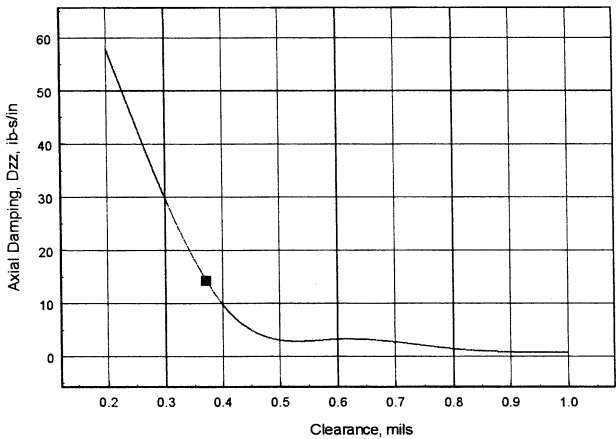

Axial damping is excellent.

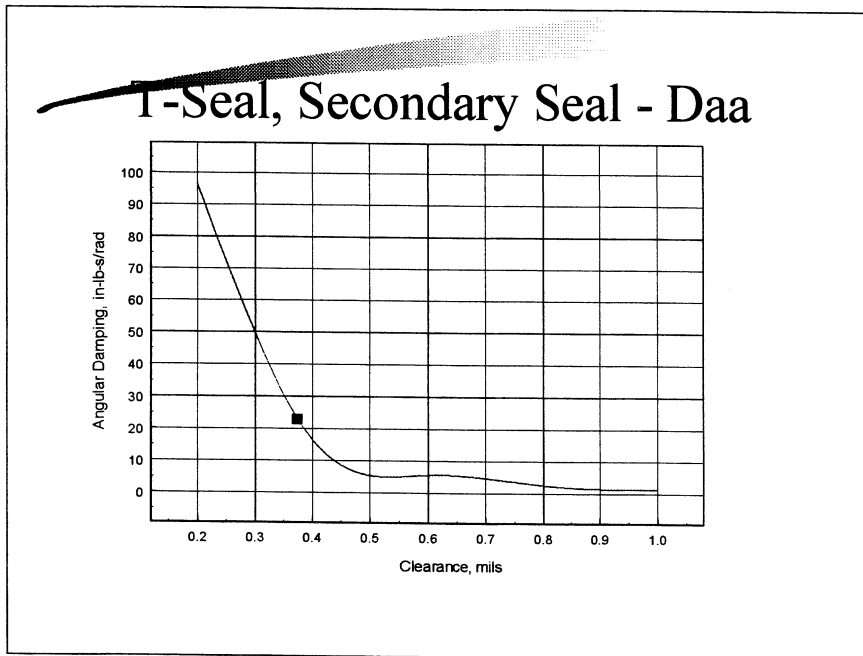

Moment damping is good.

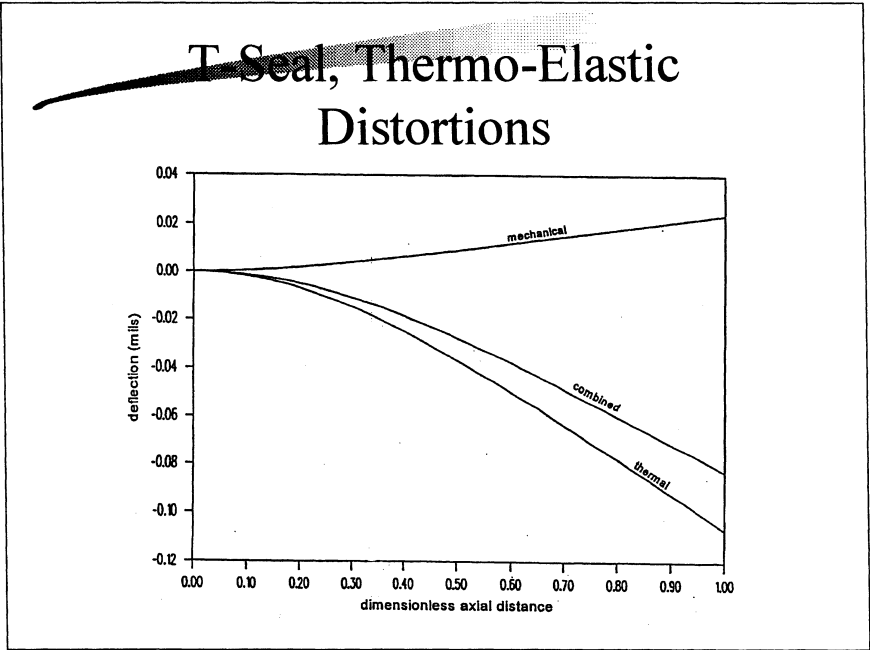

Heat generated in the film will be principally transmitted to the flowing fluid, and temperature gradients are small. The combined effect of mechanical and thermal distortion is approximately 0.1 mils, which is insignificant compared to the operating clearance. Although distortions are small, the clearance increase due to cryogenic operation has been calculated to be 1.95 mils. The manufactured clearance needed to obtain an operating clearance of 2.5 mils should be approximately 1 mil on the diameter.

T-Seal, Dynamic Orbit

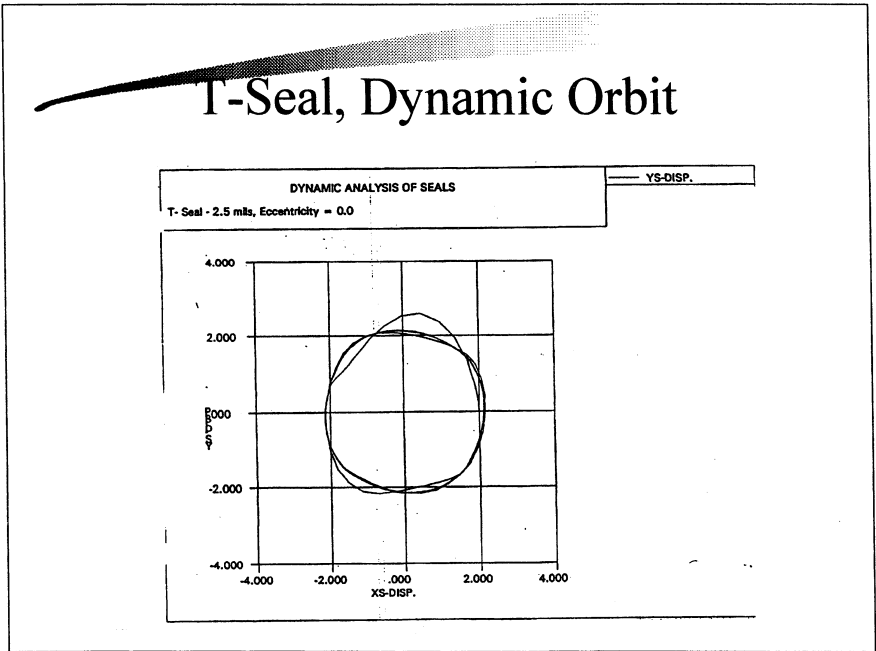

Rotor excursions for the orbit shown were ± 2 mils. Results indicate excellent tracking capability. Friction of the secondary seals was accounted for.

T-Seal, Dynamic Film Thickness

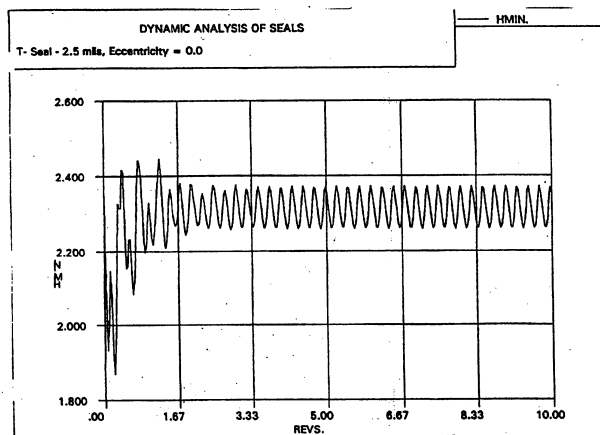

The minimum film thickness is following rotor excursions. There is an insignificant reduction in film thickness to 2.3 mils.



Conclusions

- Predicted performance of the T-Seal is excellent
- Leakage less than 50 SCFM
- Safe Film Thickness of 2 to 2.5 mils
- Thermo-elastic distortions not significant
- Excellent dynamic tracking
- Phase II will accomplish hardware build and test at Stein Seal Company

An Advanced Helium Buffer Seal for the SSME, ATD Oxygen Pump

Wilbur Shapiro
WSA, Inc.

Abstract

The present configuration of the Helium Buffer Seal on the ATD oxygen pump consists of a pair of opposed carbon rings that are forced axially against their containment housings. Leakage occurs through the clearance between the rings and the shaft. The total helium leakage through both sides is approximately 239 SCFM. A reduction in leakage to 50 SCFM will result in less helium storage and consequently permit a substantial increase in payload. Under a Phase I NASA SBIR, a solid T-Ring seal was analyzed and designed that could satisfy the criteria of reducing leakage to 50 SCFM or less. The design makes maximum use of available length and employs a mid length row of hydrostatic orifices that feed buffer helium directly into a 2 to 3 mil clearance region. The flow splits into two opposite paths to buffer oxygen gas on one side and hydrogen gas on the turbine side. The seal employs opposed hydrostatic tapered land secondary seals that provide friction free support of the primary seal and allows the primary seal to follow rotor excursion and maintain concentric operating clearance. The predicted performance of the T-seal is excellent with operation at a safe film thickness of 2 to 2.5 mils and leakage less than 50 SCFM.

Introduction

The Inter-Propellant Seal System on the Shuttle Oxidizer pump separates oxygen on the pump side from Hydrogen in the turbine region. It consists of a series of pressure breakdown labyrinths on both the hydrogen and oxygen sides. The helium buffer seal (HBS) is located between the hydrogen and oxygen pressure breakdown labyrinths and pressurized helium gas prevents egress of fluid from one side to another. The present configuration of the HBS consists of a pair of opposed carbon rings that are forced axially against their containment housing. Leakage occurs through the clearance between the rings and the shaft. The labyrinths reduce pressures on the hydrogen side from 4968 psia to 31 psia, and on the oxygen side pressure is reduced from 258 psia to 19 psia. Leakage of the present configuration is 239 scfm. A reduction in leakage to 50 scfm decreases the amount of on-board helium and allows a substantial increase in payload (approximately 1000 lbs.). Thus, the objectives of the Phase I SBIR effort were:

- Complete HBS designs that could potentially reduce helium consumption to 50 scfm or less
- Maintain existing ATD space envelope

Designs were completed for two configurations:

- A solid T-seal configuration with low friction secondary seals
- Back to back L-shaped sectored seals (L-seal).

The L-seal predicted performance was problematical because of moment balance considerations. The recommended configuration was the T-Seal and is what this paper will discuss. For L-seal information, refer to Reference (1).

The 109% Rated Power Level (RPL) condition is where most of the operation will occur. Helium conditions are indicated on Table 1.

Table 1 – 109% RPL Operating Conditions	
Buffer Fluid	Helium
Speed	24,230 rpm
Viscosity	2.8×10^{-9} lb-s/in ²
Gas Temperature	487 ° R
Buffer Pressure	121 psig
Hydrogen Drain Pressure	14 psig
Oxygen Drain Pressure	4 psig

T-Seal Configuration

The T-seal configuration is schematically shown on Figure 1, and a design assembly of the T-seal is shown on Figure 2. The shaft sleeve diameter is 2.88 in. and the overall seal length is 1 in. The T-seal consists of a solid carbon ring with a T-shaped crosssection as viewed at the bottom. At mid length, 36 equally spaced inlet holes are drilled of 0.020 in. diameter to hydrostatically feed the interface clearance region between the seal and the shaft. Two opposed hydrostatic tapered land seals, that are energized by the pressure buildup in the cavity, seal the vertical legs of the T. Activation in this manner precludes high startup clamping loads that prevent development of the secondary seal film.

The advantages of the T-seal are:

- Maximum use is made of available length
- Leakage is conserved because of the pressure drop through the orifice
- Shaft excursions can be tracked because of frictionless support

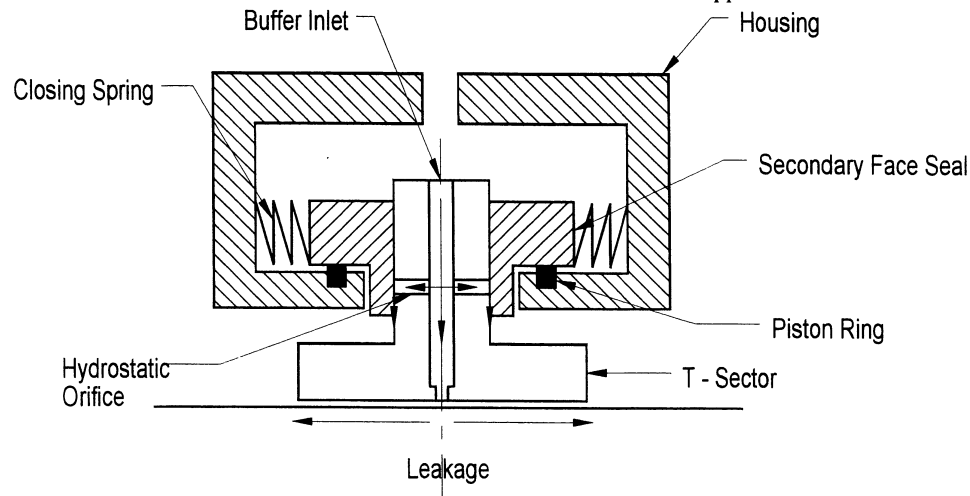

Figure 1 - Schematic of T- Seal

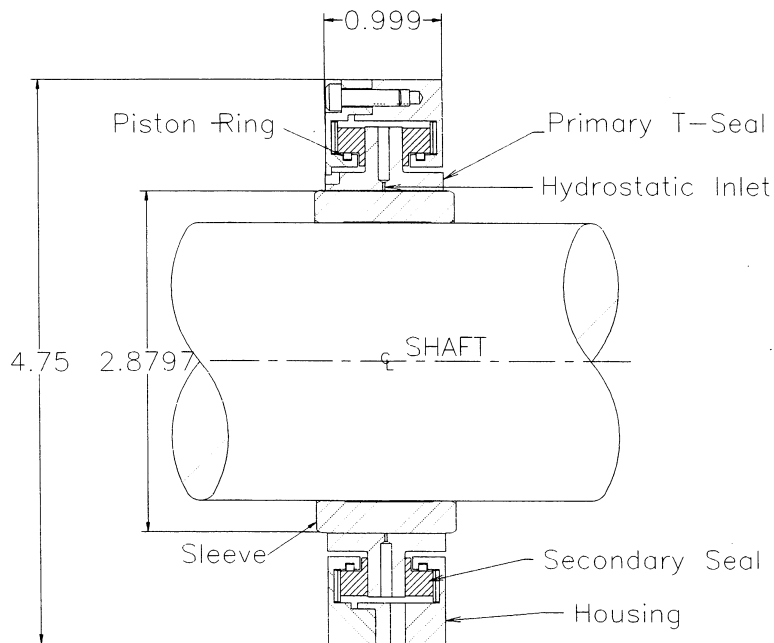

Figure 2 T-seal Assembly

T-Seal Performance

Load capacity is shown on Figure 3. Maximum load occurs at a radial clearance of 1.5 mils and not at the 1 mil clearance that may be expected. Hydrodynamic capacity is not significant at the maximum speed of 24,230 rpm and hydrostatic action is the principal source of load capacity. At the 1-mil condition, the preload from the unloaded side reduces the net load capacity. The design operating clearance was selected as 2.5 mils to accommodate thermal contraction, which occurs under operation.

Leakage as a function of eccentricity ratio and radial clearance is shown on Figure 4. The target leakage of 50 scfm is approximately 80% less than the two separate seals of the present back to back ring seals. To produce leakage less than 50 scfm, the operating radial clearance should be no greater than three mils.

Helium Buffer Seal

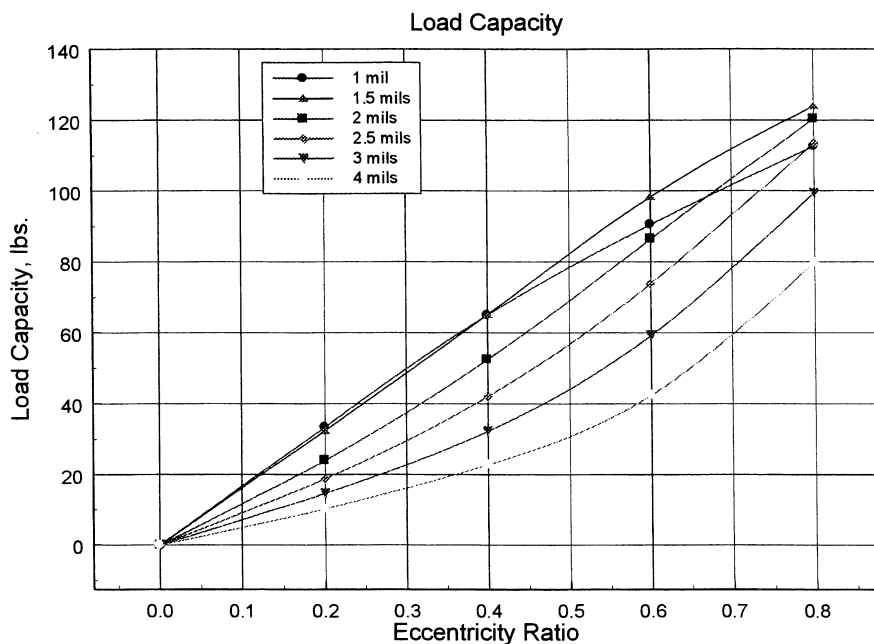

Figure 3 - T-seal Load Capacity

Helium Buffer Seal

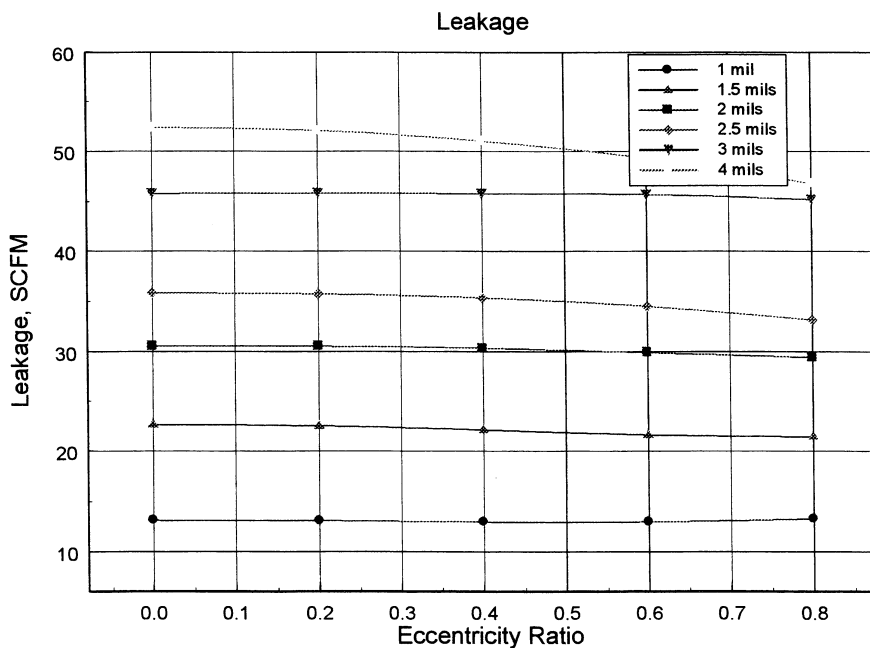

Figure 4 - T- Seal Leakage

The minimum film thickness is shown on Figure 5, and is quite adequate, even at large eccentricities, because of the relatively large concentric clearances involved. It is anticipated that the seals will be operating in the concentric position because of the near frictionless support of the secondary seals.

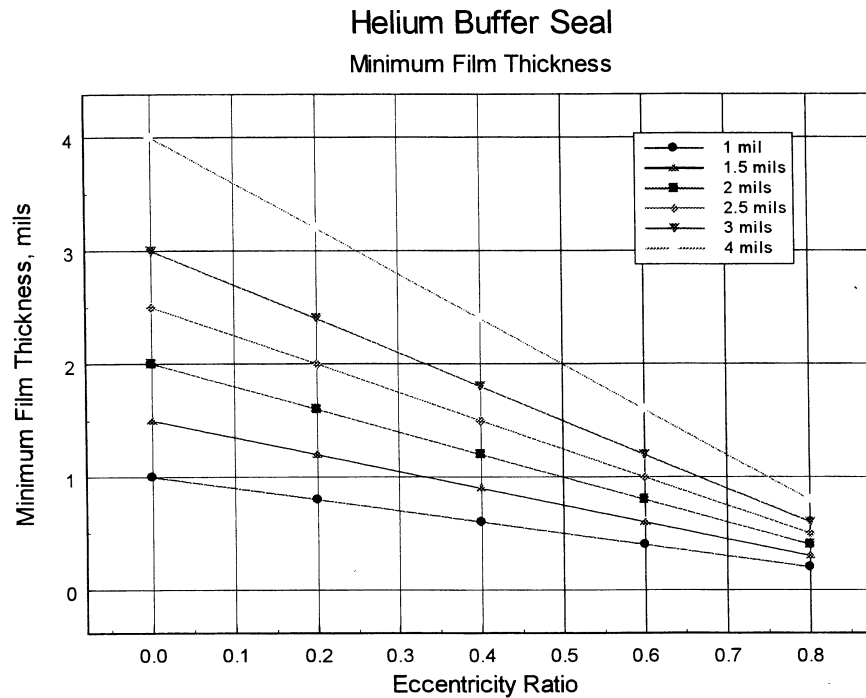

Figure 5 - T- Seal Minimum Film Thickness

Power Consumption is small and less than 50 watts in most of the operating range. Direct radial stiffness, as shown on Figure 6, indicates a reduction in stiffness, at the one mil radial clearance, until an eccentricity of 0.6, when the stiffness trend reverses and markedly increases, because the hydrodynamics take hold at the lower clearance levels. At a 2.5 mil operating clearance, the stiffness is approximately 40,000 lbs/in. Damping increases significantly with eccentricity ratio as indicated on Figure 7. At 2.5 mils, in the concentric position, the direct damping is 0.45 lb-s/in.

Helium Buffer Seal

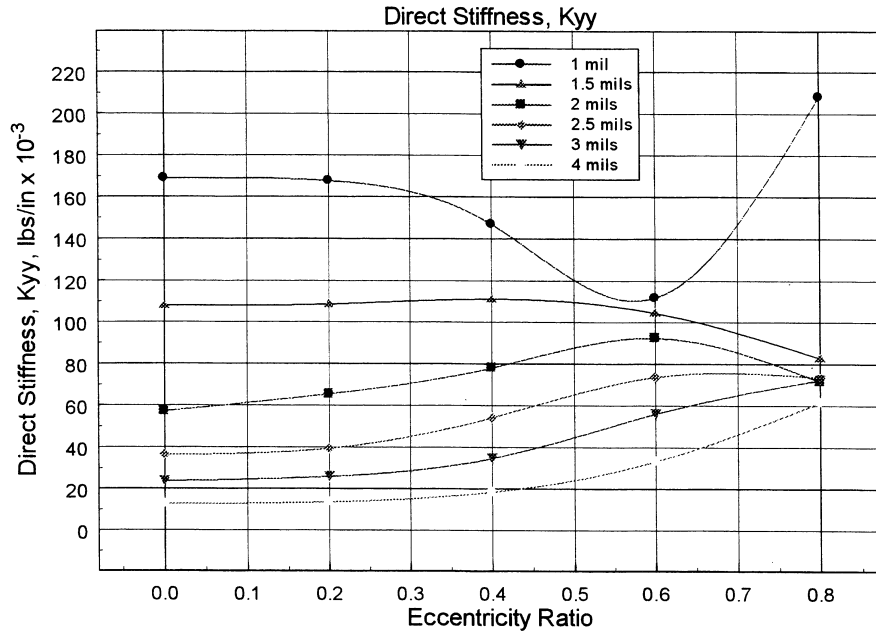

Figure 6 T-seal Direct Damping

Helium Buffer Seal

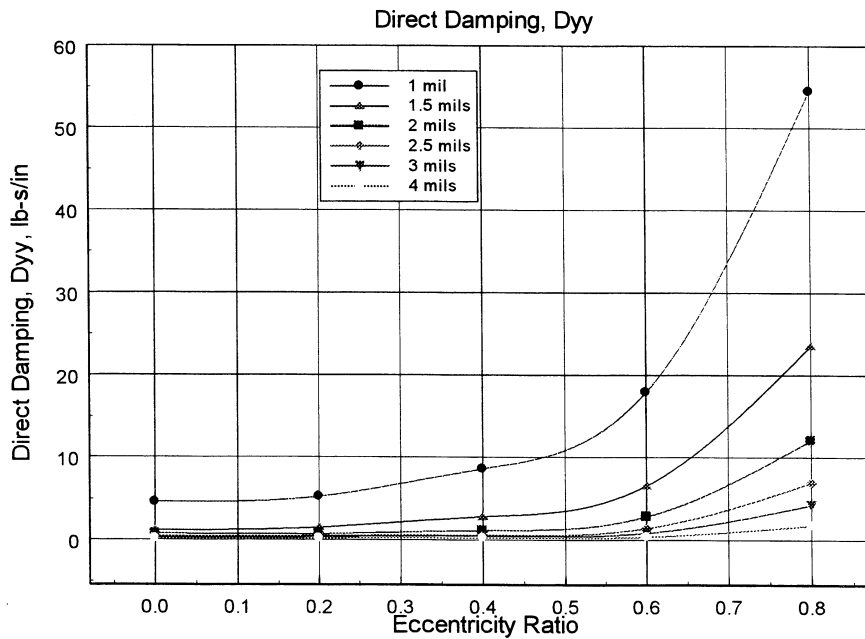

Figure 7 T-seal Direct Damping

Secondary Seal Performance

The closing load on the secondary seal was sized to provide a film thickness of about 0.37 mils. The operating film thickness can be small (0.2 to 0.4 mils) because there is no rotation between the opposed surfaces, although there can be motion due to shaft excitation. Figure 8 shows load capacity as a function of operating clearance and identifies the operating point where the closing and opening loads are in equilibrium.

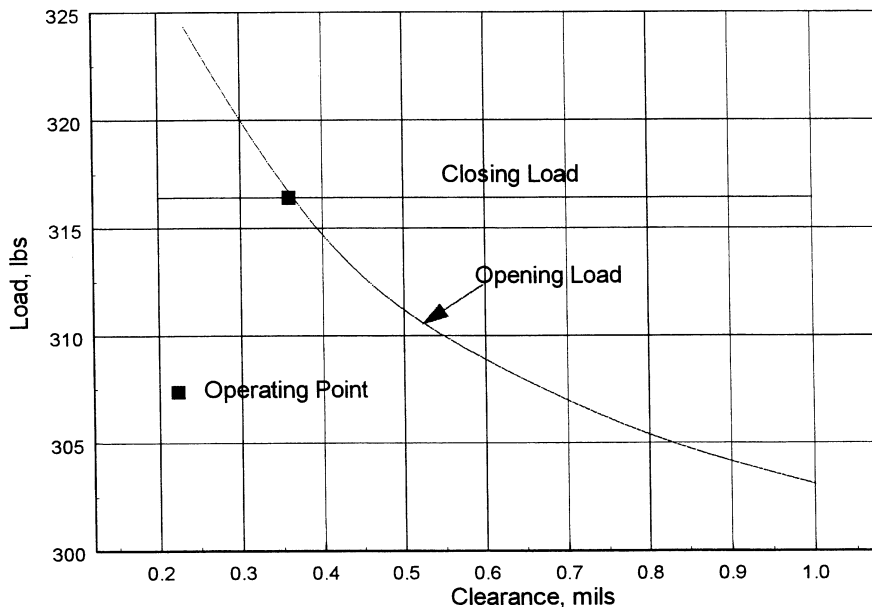

Figure 8 Secondary Seal Load Capacity

Leakage of the secondary seal is shown on Figure 9. Total leakage for the two secondary seals is less than 4 scfm. Axial stiffness is depicted on Figure 10. The axial stiffness is approximately 50,000 lbs/in, which is more than adequate to maintain separation during seal ring excursions. The moment or angular stiffness is shown on Figure 11. The moment stiffness remains positive over the operating range and does not go negative until the film thickness exceeds 0.7 mils, a condition that cannot be encountered because of the hydraulic closing load. The tapered land moment stiffness remains positive at the lower operating clearances. A hydrostatic secondary seal, that was a consideration, had negative moment stiffness at lower clearances and was not acceptable, as it would not resist overturning moments.

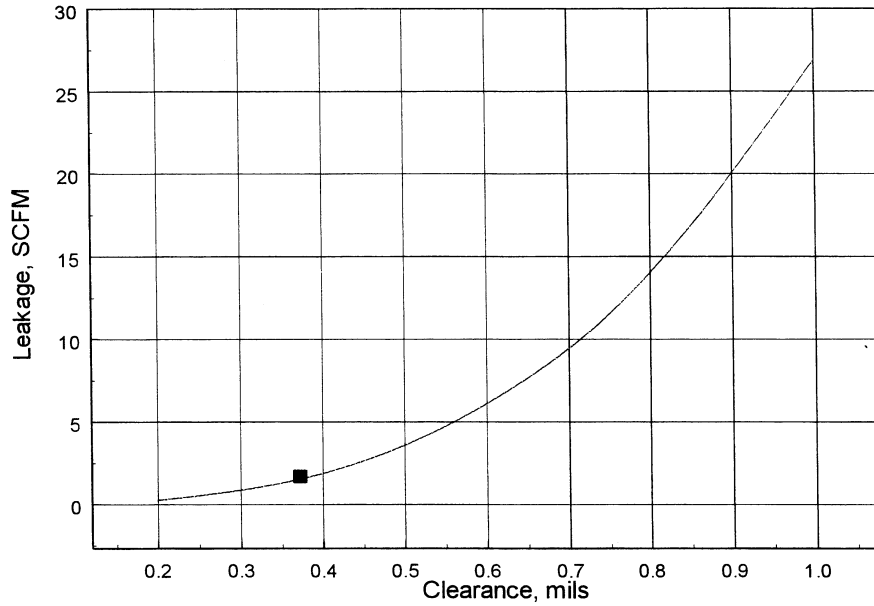

Figure 9 Secondary Seal Leakage

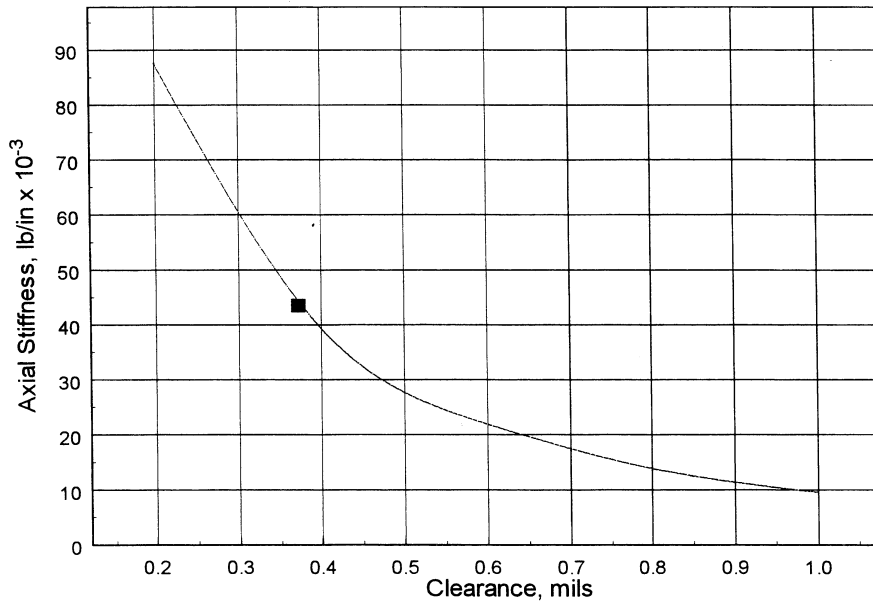

Figure 10 Secondary Seal Axial Stiffness

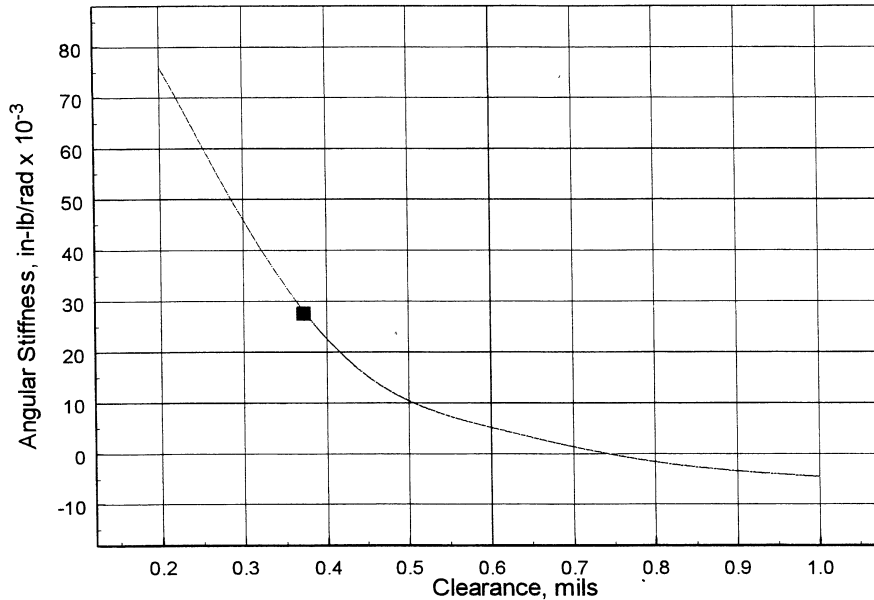

Figure 11 Secondary Seal Moment Stiffness

Thermo-elastic Distortions

Heat generated in the film will be principally transmitted to the flowing fluid, and temperature gradients are small. Figure 12 indicates distortions due to mechanical and thermal effects and the combination of the two. Pressure will tend to close off the T-seal ends and temperature will tend to open them. The combined effect of mechanical and thermal distortion is approximately 0.1 mils, which is insignificant compared to the operating clearance. Although distortions are small, the clearance increase, due to differences in material thermal expansion coefficients, at cryogenic operation has been calculated to be 1.95 mils. The manufactured clearance needed to obtain an operating clearance of 2.5 mils is approximately 1 mil on the diameter.

Dynamic Response

Dynamic analysis was also conducted to determine seal response to rotor excursions. Since the secondary seal friction is low, because of the gas film, seal tracking should be good. Indeed as shown on Figure 13, the seal is tracking rotor excursions without difficulty. A shaft orbit of 4 mils was applied and the seal is moving in unison with the shaft.

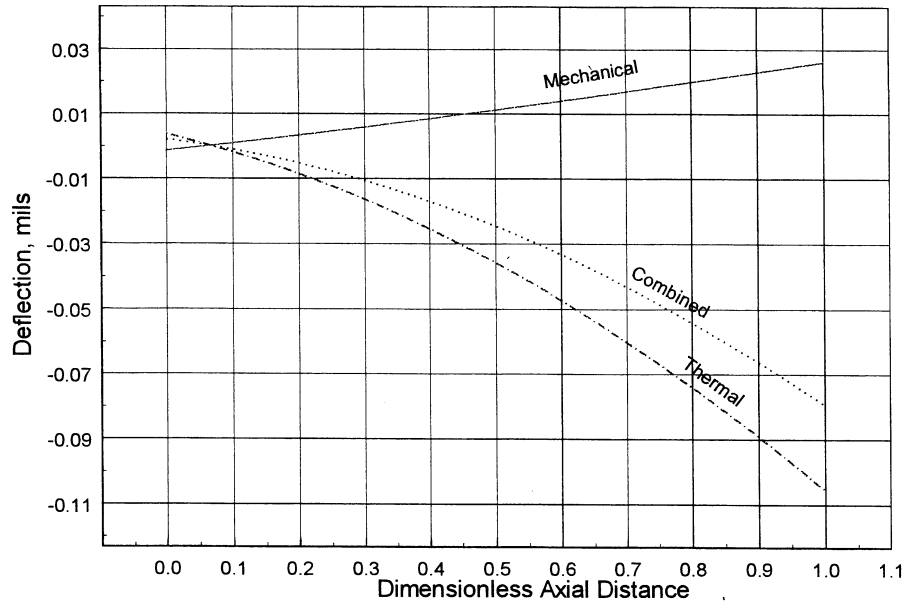

Figure 12 Thermo-Elastic Distortions

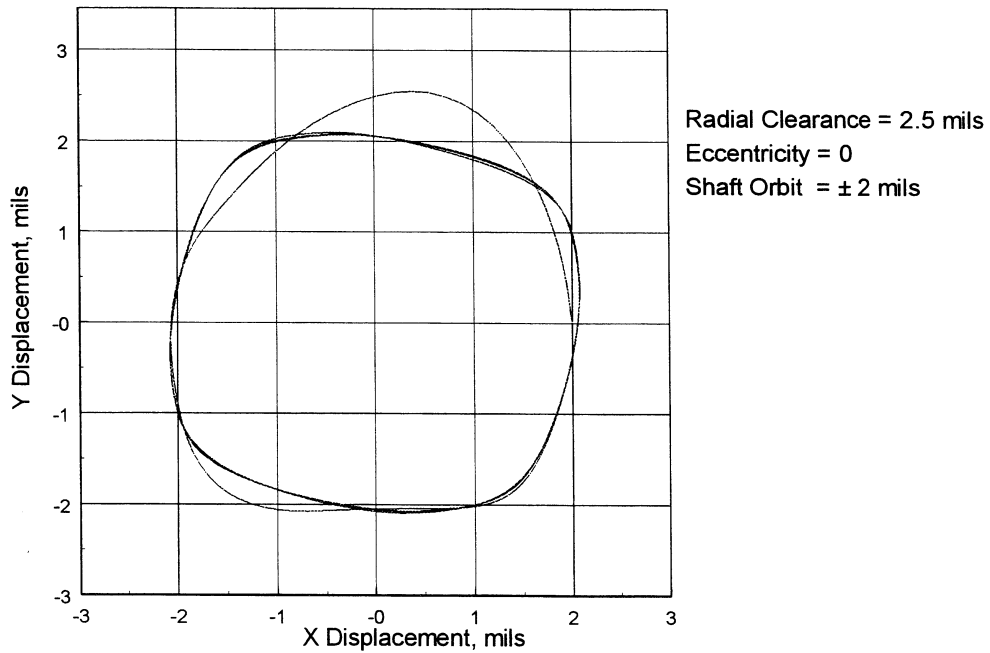

Figure 13 T-seal Dynamic Response

Conclusions

- Predicted performance of the T-seal is excellent
 - Leakage is less than 50 scfm
 - The seal operates at a healthy radial film thickness of 2 to 2.5 mils
 - Thermo-elastic distortions are not significant
 - The seal can readily track rotor excursions
- Phase II will accomplish hardware build and test at Stein Seal Company

Acknowledgements

The work was supported by a NASA contract. The contracting officer is Glen Williams and the COTR is Margaret Proctor from NASA Lewis. Their support and assistance are greatly appreciated. The cooperation of Pratt & Whitney, and in particular P. Pelfrey is recognized.