

ADVANCED SEAL DEVELOPMENT FOR LARGE INDUSTRIAL GAS TURBINES

Raymond E. Chupp
Westinghouse Electric Corporation
Orlando, Florida

ABSTRACT

Efforts are in progress to develop advanced sealing for large utility industrial gas turbine engines (combustion turbines). Such seals have been under developed for some time for aero gas turbines. It is desired to transition this technology to combustion turbines. Brush seals, film riding face and circumferential seals, and other dynamic and static sealing approaches are being incorporated into gas turbines for aero applications by several engine manufacturers. These seals replace labyrinth or other seals with significantly reduced leakage flow rates. For utility industrial gas turbines, leakage reduction with advanced sealing can be even greater with the enormous size of the components. Challenges to transitioning technology include: extremely long operating times between overhauls; infrequent but large radial and axial excursions; difficulty in coating larger components; and maintenance, installation, and durability requirements.

Advanced sealing is part of the Advance Turbine Systems (ATS) engine development being done under a cooperative agreement between Westinghouse and the US Department of Energy, Office of Fossil Energy. Seal development focuses on various types of seals in the 501ATS engine both at dynamic and static locations. Each development includes rig testing of candidate designs and subsequent engine validation testing of prototype seals. This presentation gives an update of the ongoing ATS sealing efforts with special emphasis on brush seals.

What is ATS ?

The Next Generation of Gas Turbine Technology

A university, utility, industry
government partnership

Lowest cost producer of
electricity

Environmentally superior

Key to Americas competitiveness
in the global electrical market

Supported by universities and
vendors throughout the
United States

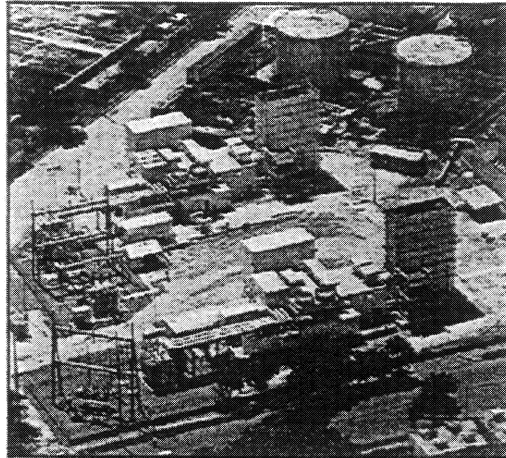

The Department of Energy's (DoE's) ATS program is a major driving force in the U.S. to improve industrial power plants. Over the last few years, large combustion turbines have evolved via integrating advanced technology into their design. Overall plant efficiencies have increased from under 40% to over 60% in the ATS plant being developed. ATS objectives address efficiency, emissions, cost of electricity, fuels, RAM, and date of introduction. They force the development to meet the major needs of the power generation industry.

Advanced Turbine Systems (ATS) Program

- Greater than 60% net plant thermal efficiency
- Less than 10 PPM NOx emissions
- Reduced cost of electricity generation by at least 10%
- Fuel-flexible design operating on natural gas with provisions for future conversion to coal or biomass fuels
- Reliability - availability - maintainability (RAM) equivalent to modern advanced power generation systems
- Commercialization in the year 2000

Combustion Turbine During Assembly

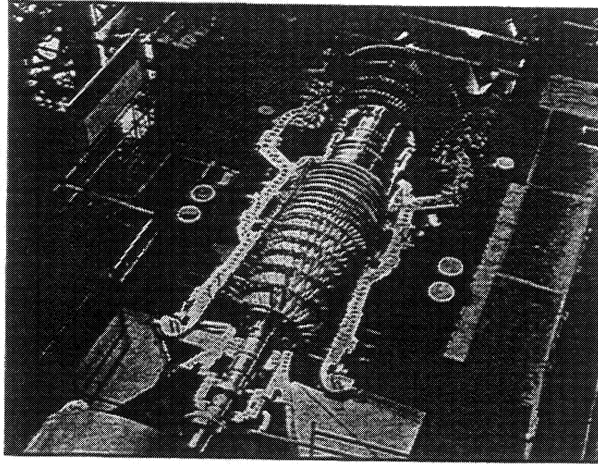

- Horizontal split casing
- Blades and vanes removable with rotor in place

Westinghouse combustion turbines (gas turbines) have several unique design features that will be continued in the 501ATS engine. These features allow maintenance and repairs to be done on site without removing the rotor.

Turbine Horizontal Split Line Blade Ring Construction

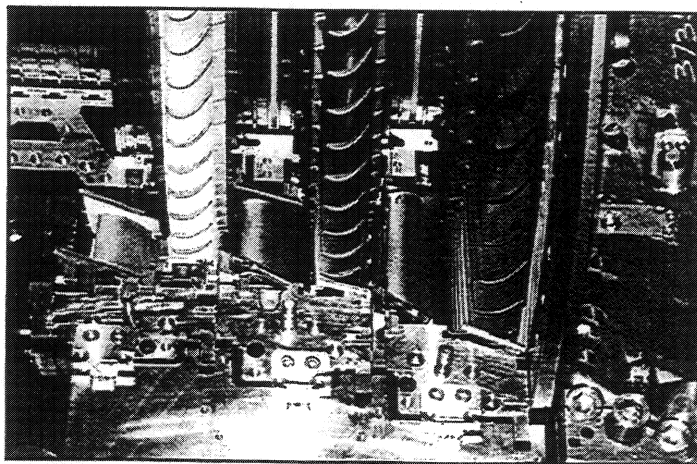

- Turbine hardware removable with rotor in place
- Blade ring assemblies removed in two 180° sections

Advanced Combined Cycle Plant Layout

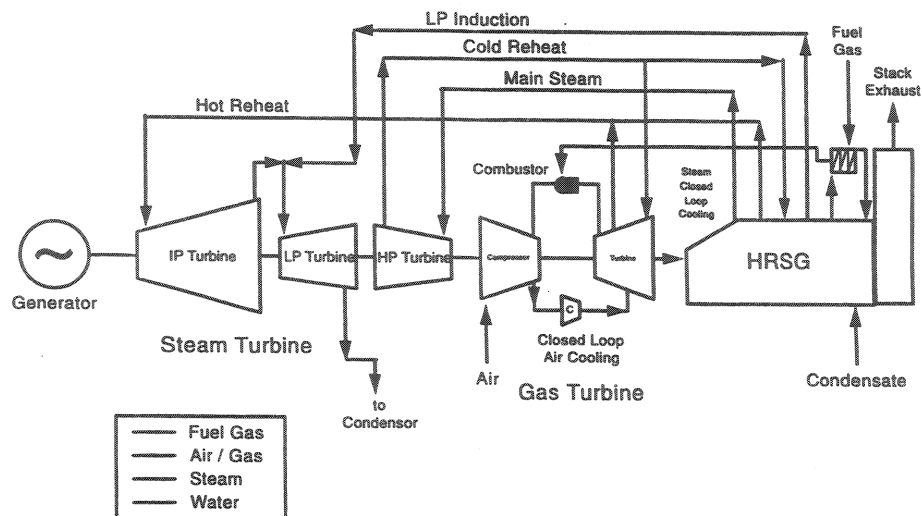

The ATS power plant combines efficient combustion turbine, steam turbine, and generator components to achieve the overall 60% efficiency goal.

Over the last few years, large combustion turbines have evolved via. integrating advanced technologies into their design. Overall plant efficiencies have increased from under 40% to over 60% in the ATS.

Evolution of Large Westinghouse Gas Turbines

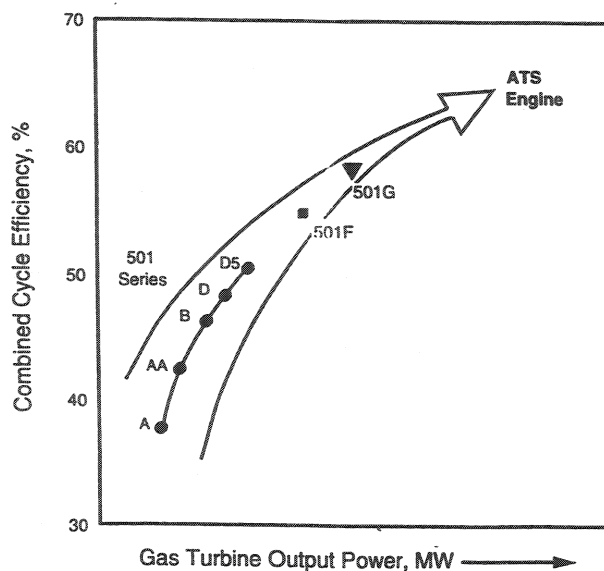

501ATS Sealing Focus Areas

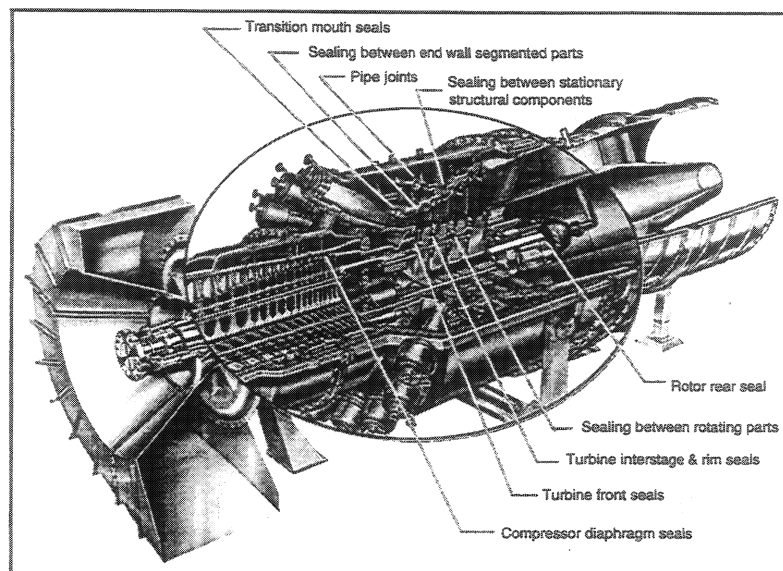

The 501ATS combustion turbine is a derivative of current engines with improved features incorporated. Key sealing areas targeted for improvement include both static (noted in the upper part of the slide above) and dynamic (lower part) locations. Also, improved sealing is being addressed for joints between rotor cooling system circuits.

Sealing Locations

Static:

- Seam / air pipe joints
- Transition mouth
- Between large mating parts (Stein seals used for many years)

Between adjacent rotating parts:

- Joints in rotor cooling system circuits

Dynamic:

- Air sealing locations where labyrinth seals are normally used
- Rotor cooling system inlet and exit
- Shrouded and unshrouded turbine blade tips

ATS Engine Sealing Improvements

Contributes to:

- **Decreased plant heat rate (improved cycle efficiency) and increased power output, e.g., for an achievable 1% decrease in leakage ==>**
 - 25 + BTU/hr/KWH heat rate reduction
 - 1+% power increase
- **Lower NOx emissions (via. improved static sealing at combustor transition mouth, between 1st stage vanes and in front of 1st stage rotor)**
- **Maintained / improved component mechanical integrity (e.g., disk cavities)**

Improved sealing contributes to improve plant heat rate (efficiency) and decreased emissions. The ostensibly small performance gains are worth one to two orders of magnitude more in fuel cost savings and plant power output benefit than the increased hardware costs.

There are several opportunities/advantages in transitioning and developing improved sealing for large combustion turbines. These include: availability of advanced aero engine sealing technology, large size of combustion turbines, and primary operation at one condition.

Transitioning / Developing Improved Sealing

Motivation

- Improved sealing approaches developed for aero engines
- Large size engines - leakage may not scale up with size
- Engines run primarily at constant speed
- Fewer transient closure cycles than aero engines

Transitioning / Developing Improved Sealing

Challenges / Requirements

- Long operating life
- Large radial and axial movements during start-up / shut down
- Operate within available geometry envelope and range of environment conditions
- Moderate to aggressive leakage goals
- Segmented because of horizontal split line
- Minimum treatment of adjacent parts (e.g., coatings for brush seal runners) because of manufacturing complications / costs
- Durable for handling, field installation and operation

There are also challenges associated with applying improved sealing in these engines. These challenges include: long required operating lives, large start-up cycle relative movements, handling durability, etc.

A major challenge to improving **dynamic** sealing is the large radial closures during startup. As the engine starts rotating, the gaps between rotating and stationary parts immediately start closing up due to centrifugal growth of the rotating parts. Then, the temperature of stationary parts increases to open up the gaps. Much later, the rotating parts heat up and close the gaps down to their steady-state clearances. Unfortunately, the steady-state clearances are greater than the minimum values during start up, and this causes significant seal clearances at steady state. Clearances are also increased due to: orbiting of rotating parts as the rotor passes through critical speeds in starting up, and circumferential gap variations caused by the engine's split casing. Similar closure issues are involved with engine shutdowns.

Start-Up Cycle for Turbine Interstage Location

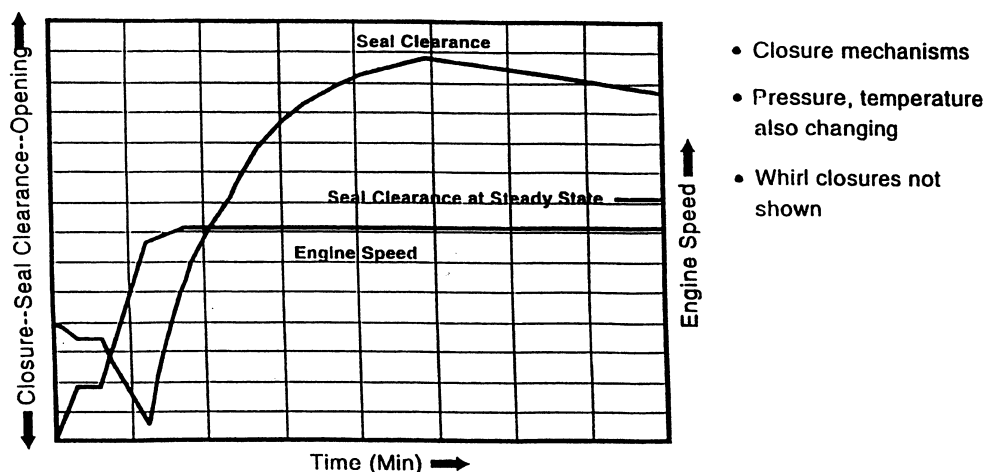

Transitioning / Developing Improved Sealing

Approach

- **Address sealing areas with significant payoff in engine efficiency, emissions, mechanical integrity**
- **For static seals and seals between adjacent rotating components**
 - **Incorporate proven components from current engines**
 - **Adapt improved sealing from aerospace applications**

The ATS program includes a systematic approach to improving sealing for static locations. An example is sealing around the exit mouth of combustor transition liners. Leakage at this location is beneficial for cooling adjacent parts, but significantly increases emissions. To maintain a required rotor inlet temperature, the combustor maximum temperature must be increased by the dilution effect of leakages at the transition mouth and other locations ahead of the first-stage rotor blades. The two photographs below show how sealing is affected in current hardware. The seals in this area are made of heavy metal because of the hostile environment at this location. Also, these parts are robust to allow rugged handling. Some or all of the combustors are periodically removed for combustor and turbine hardware inspections and replacements. Challenges are the: need for robust sealing components, high temperature of gases circulating downstream of the seal, and need to provide cooling of adjacent hardware cooled by the higher leakage flows in current engines. A separate ATS development task has been launched to address improved sealing in this area.

Transition Mouth Sealing



Transition mouths with side labyrinth seals

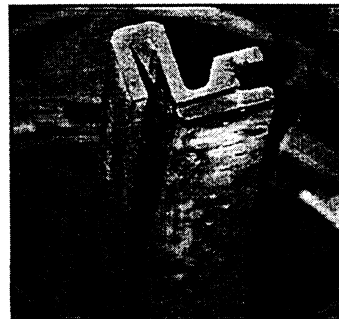

Top / bottom seal between transition mouth and 1st row vane endwalls

- **Advanced transition mouth sealing must:**
 - **Reduce leakage to sustain emission levels, while providing hardware cooling**
 - **Be robust to survive hostile thermal/vibration environment; and field installation and handling (including periodic transition removal for hardware inspections)**

Combustion Turbine with a Transition Being Removed

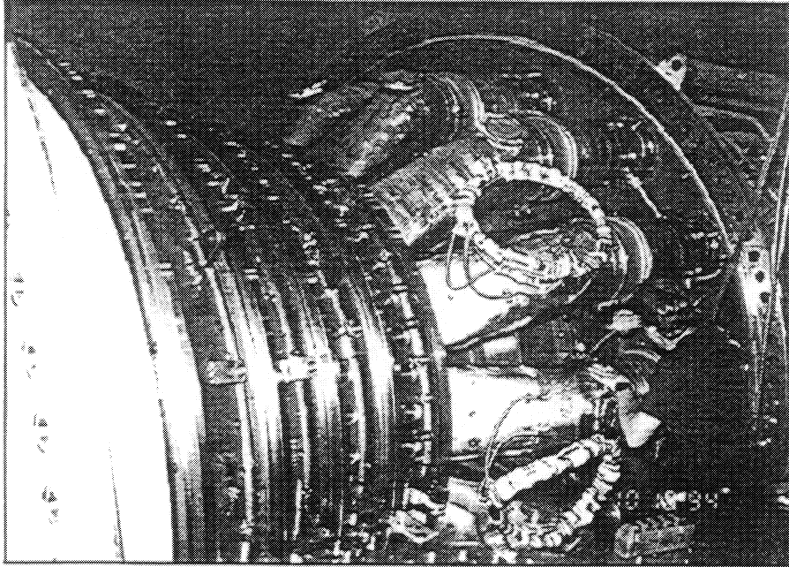

Above shows how transitions are removed. Hardware must be robust to permit on-sight removal.

Various types of dynamic seals in the 501ATS engine. Prime ones include: labyrinth seals; brush seals to replace key labyrinth seals; and a face seal at the rear of the turbine rotor. The latter is needed to meet tight sealing requirements of the closed-loop rotor cooling air system.

Types of Dynamic Seals

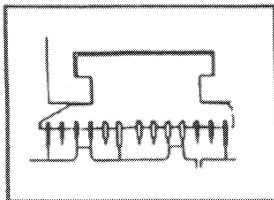

Labyrinth

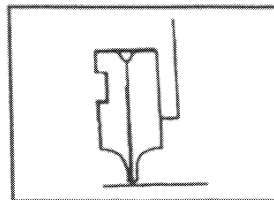

Brush

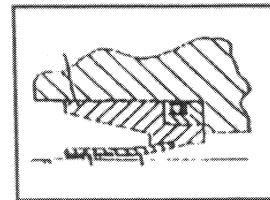

Compliant

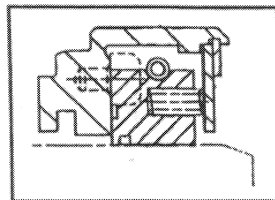

Circumferential

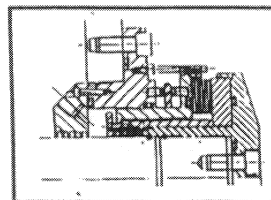

Face

Transitioning / Developing Improved Sealing

Approach

- **Dynamic seals**
 - **Primary focus -- replace labyrinth seals with brush seals**
 - **Apply face seal at ATS rotor rear location**

Brush seals are a primary focus for improving dynamic sealing. Development has followed a systemic approach. It was initiated with a preliminary effort at Cross Manufacturing which demonstrated feasibility. This was followed by a series of subtask development efforts focused on individual sealing locations. EG&G has considerable experience and excellent R&D facilities to carry out the brush seal development work.

Brush Seal Development Program

- **Launched after success of preliminary effort with Cross Manufacturing**
- **Approach:**
 - 1) **Potential seal locations, benefits, and required validation determined**
 - 2) **Focused seal development for selected engine locations**
 - 3) **Validation in a service engine**
- **EG&G chosen for focused efforts**
(They have projects with the U.S. Air Force plus internal funding for aero-engine brush seal and manufacturing process development)

Brush Seal Development/Validation

- ◆ Define Operating Conditions
- ◆ Design Brush Seal to Meet Specific Requirements
- ◆ Rig Testing - Simulated Operating Conditions
- ◆ Design Full Scale Brush Seal Based on Rig Test Results

A four step approach (see above) was taken to develop and validate brush seals for each engine sealing location. The first step was to define the operating conditions and requirements (see below). Based on these data, initial brush seal configurations were determined with several bristle material options. Tribology rig tests were run for simulated engine conditions to determine the best bristle material to run against the rotating surface at the particular engine location.

Operating Conditions and Requirements

- ◆ Steady State and Transient
 - Rotor Speed
 - Environment Temperature
 - Air Pressure
- ◆ Relative Closure Time History
- ◆ Rotor Surface Condition (roughness)
- ◆ Segmented
- ◆ Durable for Handling, Field Installation, Operation

Brush Seal Design

- ◆ Design a seal which will exhibit minimal wear during interference operation, but have enough stiffness to support the required pressure drop.

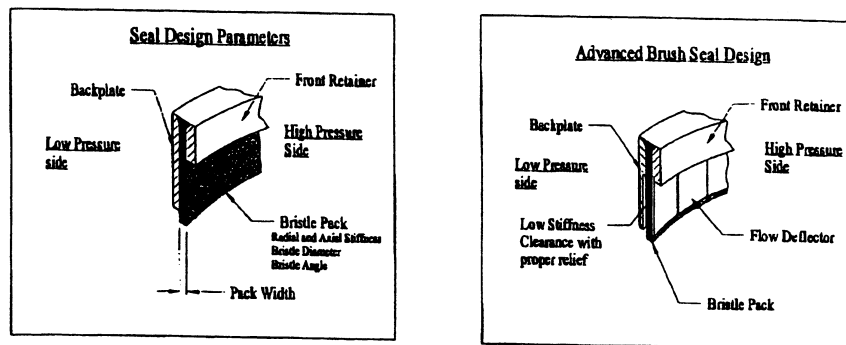

Two basic type brush seal configurations have been considered. One has a standard, generic design similar to brush seals produced by several manufacturers. The other has advanced features developed by EG&G. These features address seal hysteresis and bristle wear. Initial subscale seal testing evaluated the two brush seal configurations for the turbine interstage location. This testing demonstrated feasibility (see chart below) and the advantages of the advanced design. Consequently, only brush seals with advanced features were investigated for the other selected engine locations, i.e., compressor diaphragm, turbine front, and turbine rim.

Sub-scale Seal Testing

- ◆ Previous Testing Showed Feasibility
 - Uncoated Rotor Surface
 - High Radial Interference
 - Acceptable Wear Rates
 - Improved Sealing Performance
- ◆ Three Brush Seal Configurations - Location Specific
 - Standard design and EG&G design - Turbine Interstage
 - EG&G design - Compressor Diaphragm

Static Stiffness

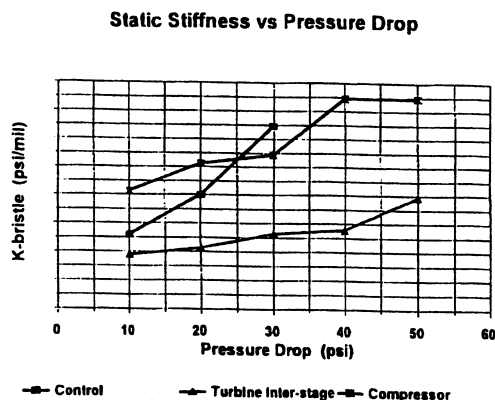

- ◆ During interference larger stiffnesses leads to higher bristle wear rates
- ◆ Seal leakage increases with start cycles

Radial stiffnesses of brush seal designs were measured statically to verify design stiffnesses and to quantify pressure stiffening as a function of pressure drop. Results above show that both advanced seal designs experienced a two-fold increase in stiffness with increasing pressure drop. The standard (control) seal had a 2 ½ times increase in stiffness over a smaller pressure drop change. The increase in stiffness affects seal wear and long term leakage performance.

Static flow data were acquired using a specially design fixture (see below). This fixture allowed seal pressure drop and pressure ratio to be varied independently via. adjusting the rig back pressure. Also, data acquired from the static flow fixture formed a database for leakage quality control of full-size segments for which only static data can practically be obtained.

Static Flow Fixture

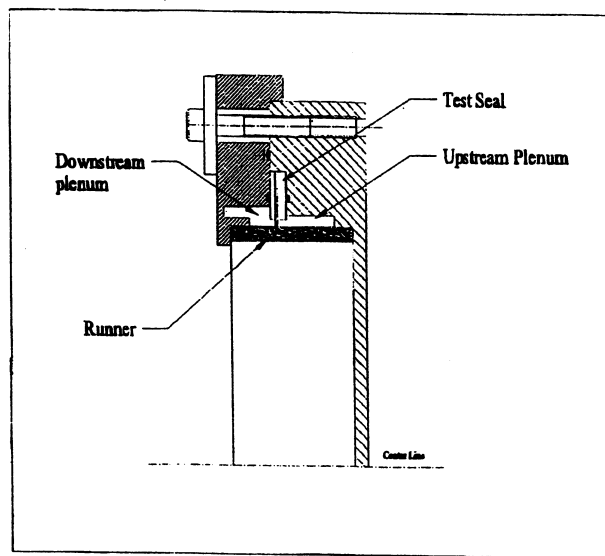

Static Leakage Flow

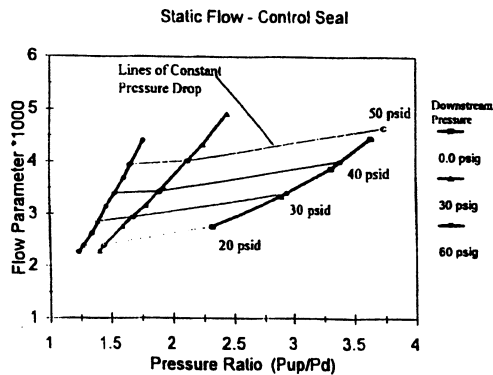

- ◆ Seal effective leakage area increased as the downstream pressure was increased for a given pressure ratio.
- ◆ Leakage flow parameter varies more with pressure drop than pressure ratio.

Representative results from static flow fixture tests (see above) show that pressure drop is a better parameter than pressure ratio to represent brush seal leakage.

Candidate brush seals were evaluated for wear and performance characteristics in EG&G's Aerospace Test Rig (see below). The seals were subscale size with engine pressure drop and rotor speed variations and temperature levels modeled. The rig has been updated to simulate seal closure by providing controlled axial seal movement along a tapered rotor surface.

Aerospace Test Rig

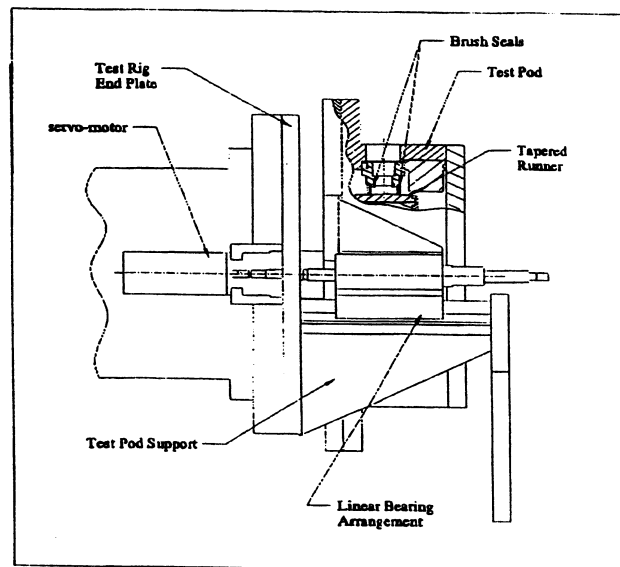

Seal Leakage and Wear

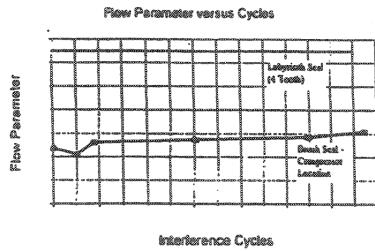

- ◆ Total number of cycles representative of engine cycles between refurbishment
- ◆ Brush seal offers 60% reduction in leakage flow
- ◆ Compressor Diaphragm seal, with EG&G advanced features, exhibited less wear than the control seal

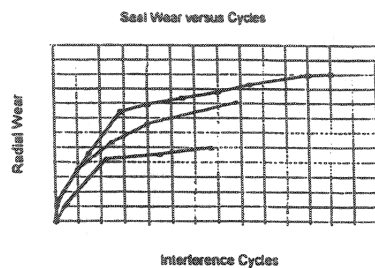

← 17" dia Control Seal ← 8.5" dia Control Seal ← 8.5" dia Compressor Seal

Representative data from subscale brush seal tests on the aerospace rig are shown above. The compressor diaphragm brush seal configuration exhibited superiority over the current labyrinth seal configuration even after many engine start cycles.

Data and lessons learned from fabricating and testing subscale brush seals led directly to defining design criteria for full-scale seals for each engine location. Below shows the 501ATS compressor diaphragm brush seal configuration and a segment being inspected.

Full-Scale Brush Seal Fabrication

- Subscale seal testing leads directly to full-scale design criteria, i.e., stiffness (bristle length, diameter, angle), fence height, advanced feature parameters
- Full-scale seal considerations
 - Segmented
 - Curvature differences
 - Large dimensions, tolerancing, centerless part inspection
 - Knife-edge profiles to minimize rub damage

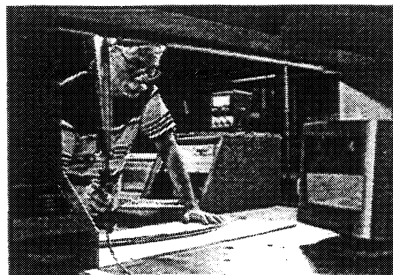
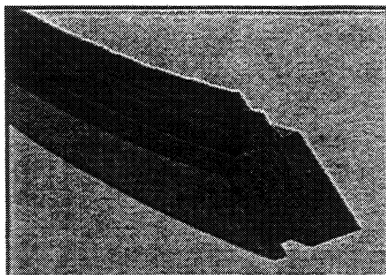

ATS Compressor Diaphragm Brush Seal Installation

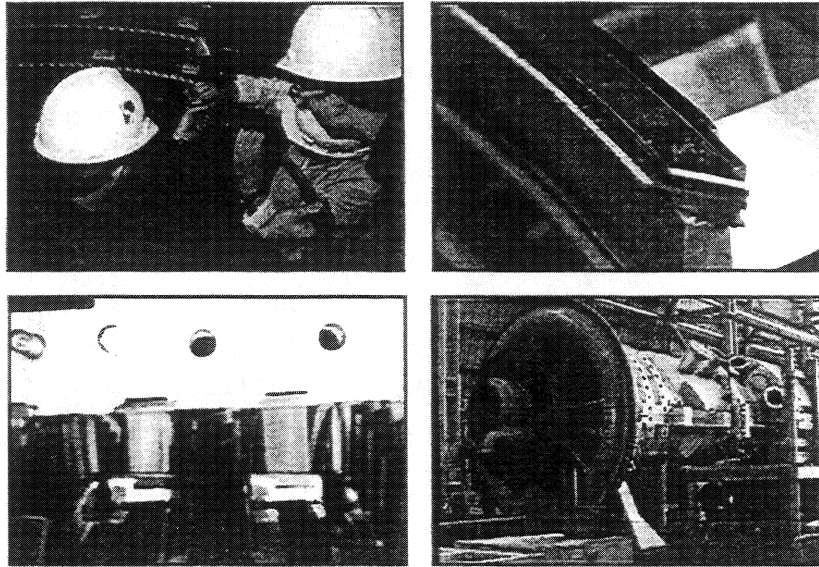

The photos above shows various stages of the brush seal segments being installed into 501ATS compressor diaphragms.

The photos below are views of full-size 501F brush seal segments and their installation. The segments have a bolted-on construction.

501F Turbine Interstage Brush Seal Installation

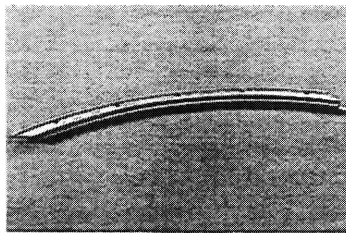

Brush seal segment (6 per row) with bolted on construction

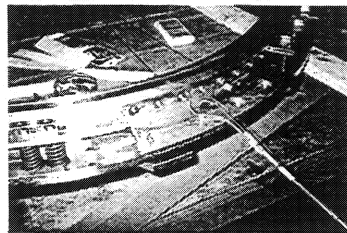

Special instrumentation for 1st 501F unit with brush seals

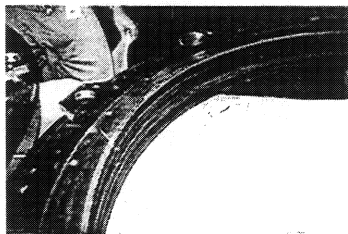

One interstage with brush seal segments installed

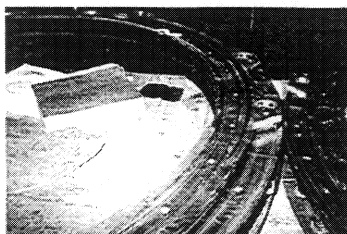

2nd & 3rd interstages side-by-side with brush seal segments partially installed

ATS Rotor Rear Seal Development

Requirements

- Low leakage
- Large axial movement
- High pressure drop
- Robust, long life with part time low speed operation
- Handle particles in leakage air
- Smaller dia., not necessarily segmented

Selection:

- Vendor - John Crane Inc.
- Seal - Non-contacting, dry running gas lubricated end face seal - hydrodynamic type
- Design - based on current Crane Type 28 seals with modifications to meet requirements

Evaluation:

- Long life with part time low speed operation
- Large axial movement
- Proper installation/durability capability
- Handle air contamination

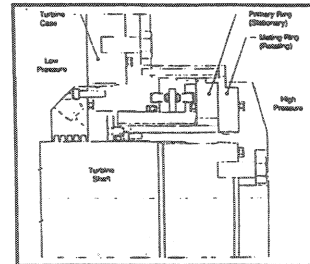

Proposed rotor rear seal

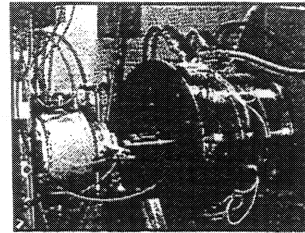

John Crane test rig to simulate engine conditions

A separate development effort focused on providing very low leakage of cooled compressor discharge air (shell air) as it enters the 501ATS rotor at the rear. John Crane Inc.'s spiral groove face seal technology was adapted to this location with larger diameter and axial movement than in previous applications. Rig testing has been done to verify the seal's design and low leakage over a range of engine operating conditions.

In summary, advanced sealing components in the 501ATS combustion turbine are making significant contributions toward the overall ATS power plant goals. Advanced sealing development tasks have proceeded well and resulting sealing components will be validated in the first 501ATS engine.

Summary

- Improved sealing in utility gas turbines has significant payoffs
- ATS advanced sealing projects progressing well
- Focus on static and dynamic sealing locations with significant payoffs in plant: (1) increased efficiency, (2) reduced emissions and/or (3) maintained \ improved component mechanical integrity
- For static seals: (1) maintain/adapt proven concepts, and (2) incorporate improved sealing from aerospace/turbomachinery applications
- For dynamic seals: develop brush seals for the turbine interstages, rims, and front, and compressor diaphragms
- Focused development efforts are nearly complete for the turbine interstage and compressor diaphragm brush seals; full-scale hardware fabricated for engine/component validation testing
- Non-contact, dry-gas, hydrodynamic-lift face seal being developed for the ATS rotor rear