

NUMERICAL METHODOLOGY FOR COUPLED TIME-ACCURATE SIMULATIONS
OF PRIMARY AND SECONDARY FLOWPATHS IN GAS TURBINES

A.J. Przekwas and M.M. Athavale
CFD Research Corporation
Huntsville, Alabama

and

R.C. Hendricks and B.M. Steinetz
NASA Lewis Research Center
Cleveland, Ohio

Detailed information of the flow-fields in the secondary flowpaths and their interaction with the primary flows in gas turbine engines is necessary for successful designs with optimized secondary flow streams. Present work is focused on the development of a simulation methodology for coupled time-accurate solutions of the two flowpaths. The secondary flowstream is treated using SCISEAL, an unstructured adaptive Cartesian grid code developed for secondary flows and seals, while the mainpath flow is solved using TURBO, a density based code with capability of resolving rotor-stator interaction in multi-stage machines. An interface is being tested that links the two codes at the rim seal to allow data exchange between the two codes for parallel, coupled execution. A description of the coupling methodology and the current status of the interface development is presented. Representative steady-state solutions of the secondary flow in the UTRC HP Rig disc cavity are also presented.

OUTLINE

- **Overview and Objectives**
- **Computational Methodology**
- **Interface Development, Status**
- **Demonstration Simulations**
- **Summary**

NEED FOR COUPLED ANALYSIS

- **Typical Gas Turbine Engine**
 - **Multi-Stage Compressor and Turbine Section with Interstage Cavities**
 - **Powerstream/Mainpath/Primary: Flow Above Blade Platforms**
 - **Secondary: Flow Below Blade Platform, Cooling Flow, Cavity Flows**
- **Powerstream and Secondary Flow Interact in Strong, Complex Manner, and Affect**
 - **Engine Power, Efficiency**
 - **Component Life (Mechanical and Thermal Loads)**
- **Drive for Higher Power/Efficiency at Reasonable Component Life**
 - **Details of Primary and Secondary Flows Needed**
 - **At Design, Off Design, and During System Transients**

PRIMARY-SECONDARY COUPLING SCHEMATIC

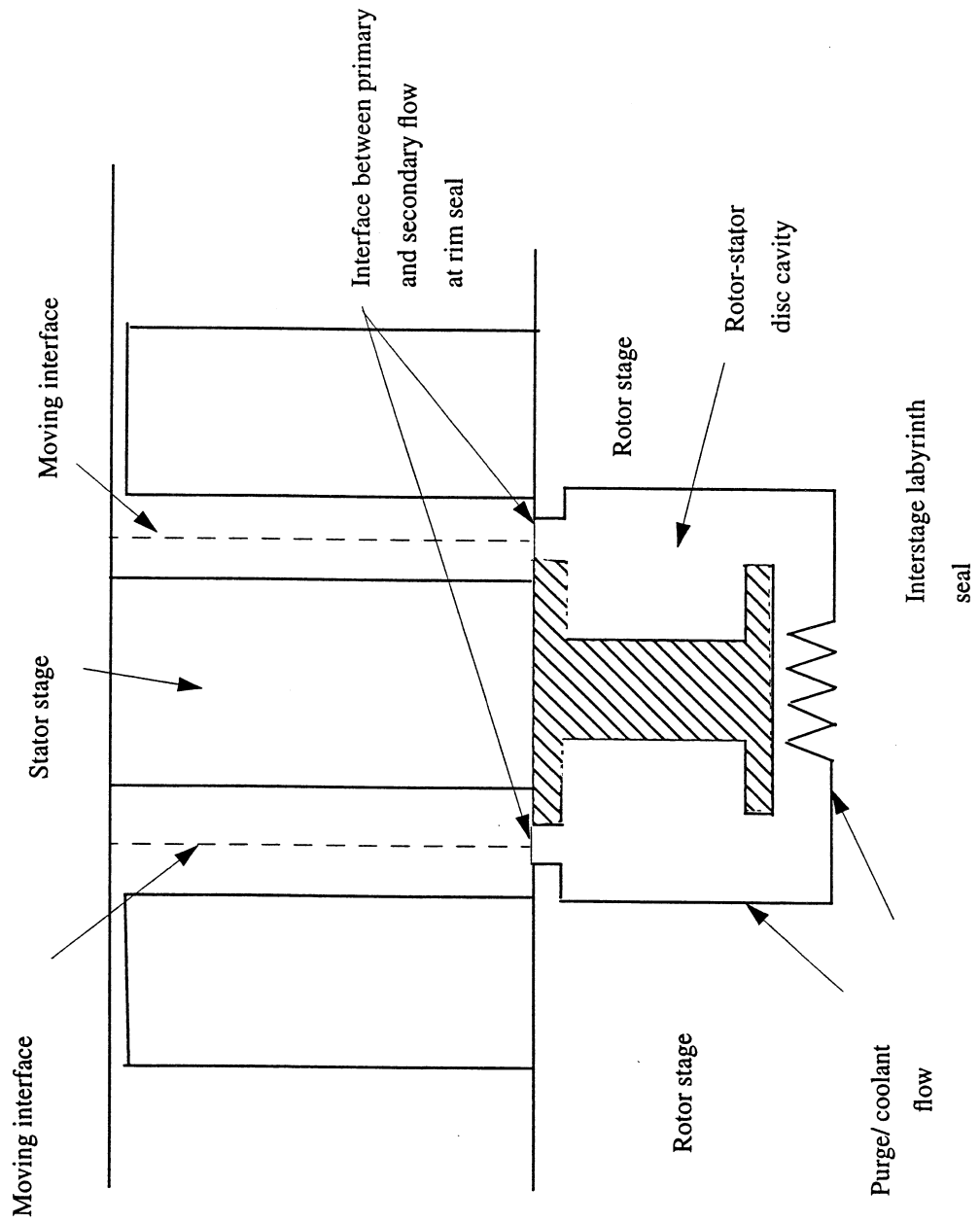

NEED FOR COUPLED ANALYSIS

- **Interaction Has Different Aspects in Different Parts Compressor Section**
 - **Effect of Interstage Cavity Flows on Primary Flow**
 - **Windage Losses**
- **Turbine Side**
 - **Coolant Flow Optimization for Efficiency**
 - **Primary Gas Ingestion in Cavities Must be Prevented at All Times**
 - **Effects of Coolant Flow on Power Stream**

OBJECTIVES AND PROPOSED METHODOLOGY

- **To Develop a Validated Set of Codes for Coupled, Transient Solutions of Primary and Secondary Flows in Multi-Stage Machines**
 - **Use Existing, Validated Codes for Different Streams: SCISEAL for Secondary, MS-TURBO for Primary**
 - **Develop Interfacing Algorithms for Coupling the Codes**
 - **Graphical User Interface for Ease of Use**
- **Use of Separate Codes**
 - **Widely Different Flow Physics in Primary and Secondary Flows**
 - **Validated Codes Available, Specifically Developed for Each Flow Stream**
 - **Capabilities Offered by the Combinations**

COUPLED CODE METHODOLOGY

Power Stream

TURBO: density based, finite volume, structured grids, time-accurate, multiple blade rows, high speed flows

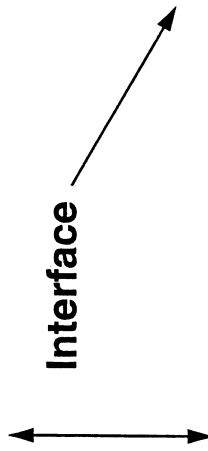

Cavity/Secondary Flow

SCISEAL-U: pressure based, finite volume unstructured, adaptive Cartesian grids, time accurate, conjugate heat transfer, turbulence, low speed flows

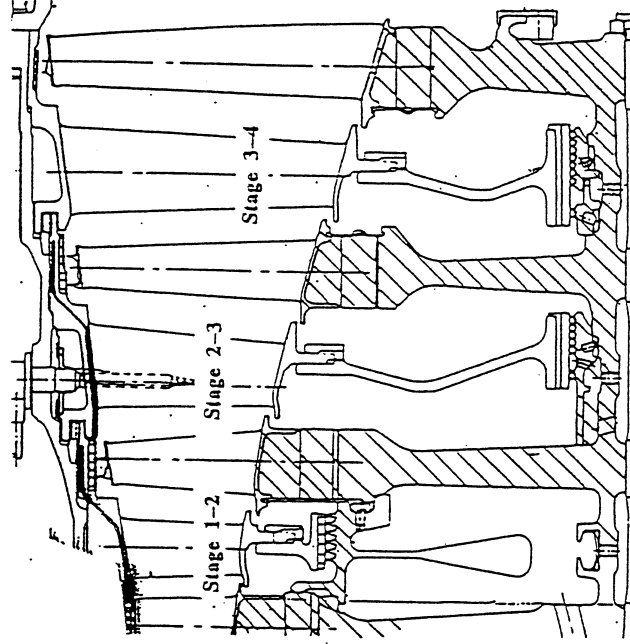

SIMULATION ENVIRONMENT

- Plug-n-Play Modules Attached to DTF

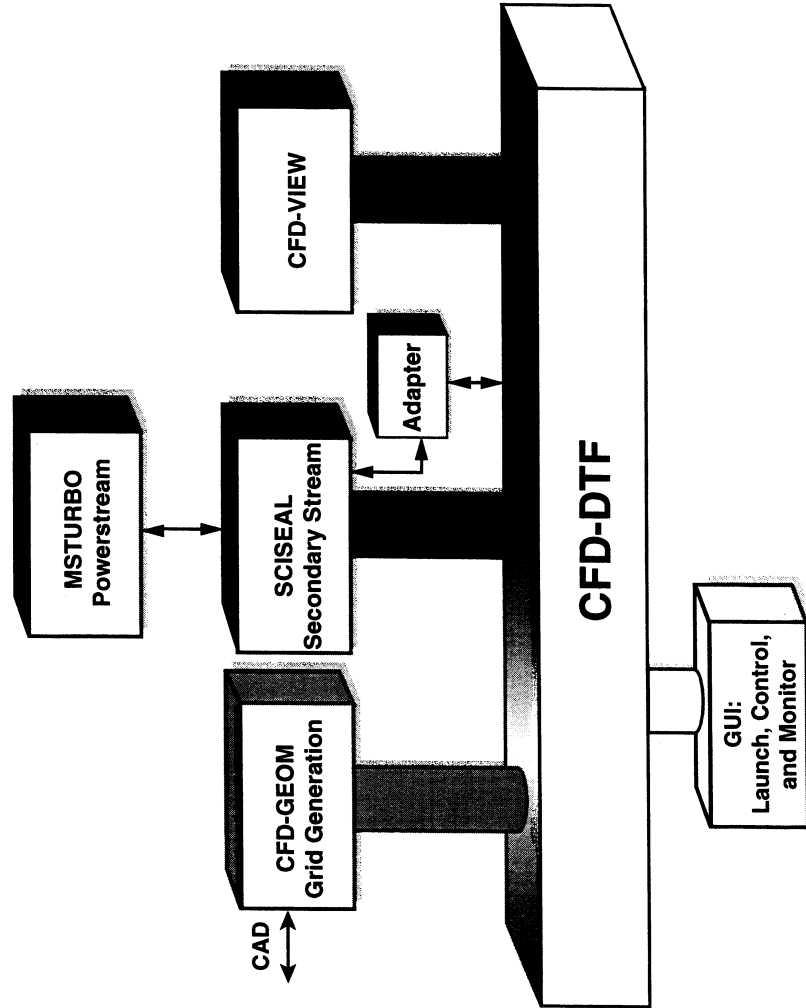

DESCRIPTION OF SCISEAL CODE

Salient Features

- **Unstructured Grid Topology with Mixed Elements**
- **Fully Implicit Pressure-Based, Finite Volume**
- **Cartesian Velocities, Non-Staggered Arrangement**
- **Sequential Solution Procedure with SIMPLEC-M for Velocity-Pressure Coupling**
- **Conjugate Gradient Solvers for Linear Systems**
- **Flow, Conjugate Heat Transfer, Turbulence**
- **Links with Grid Adaptor for Solution-Based Adaptation**

CARTESIAN PRISM/QUAD GRIDS

- **Conventional Unstructured Tetra**
 - **Difficult to Generate Quality Volume Grids**
 - **Difficult to Control Clustering and Aspect Ratio for Viscous Flows Near Walls, Shear Layers, etc.**
 - **Require ~5x Cells than Similar Resolution Hexa**
 - **Non-Trivial Adaptive Remeshing, Moving Grids, etc.**
- **Adaptive Cartesians**
 - **Showed Remarkable Results for 3D Euler Equations Solved for Complex Configurations**
 - **Inefficient for N-S Equations as Very Large Number of Cells is Generated in Boundary Layer Region**
- **Adaptive Cartesians-Prism/Quads**
 - **Most Promising Approach for Fully Automated Simulations of Viscous, Turbulent Flows**

VORTEX GROWTH AND UNSTRUCTURED ADAPTIVE GRID

- Van Dyke (An Album of Fluid Motion) examples of unsteady vortex dynamics (macro and microscales)
- Unstructured, solution-adaptive simulations

Incompressible

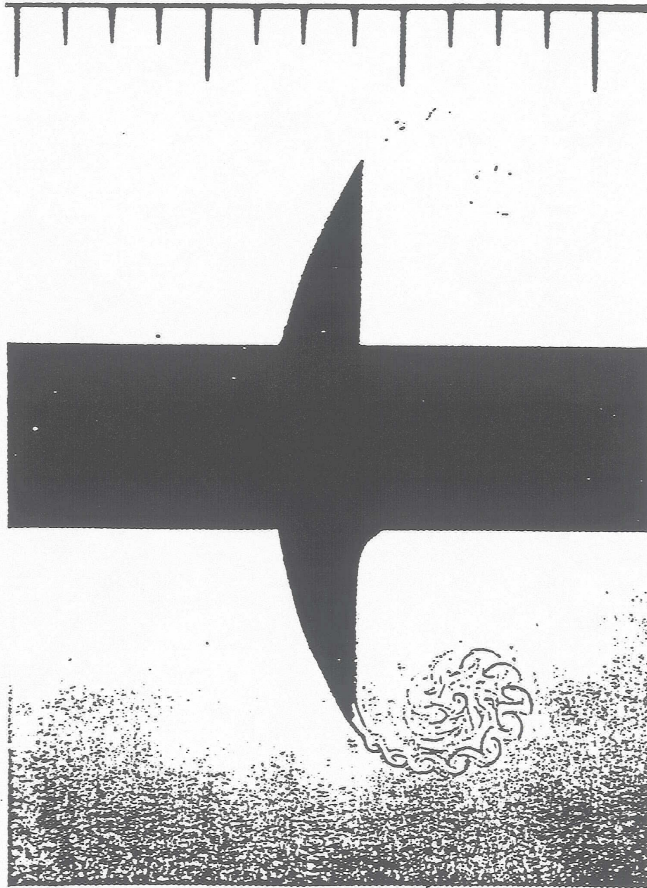

Compressible

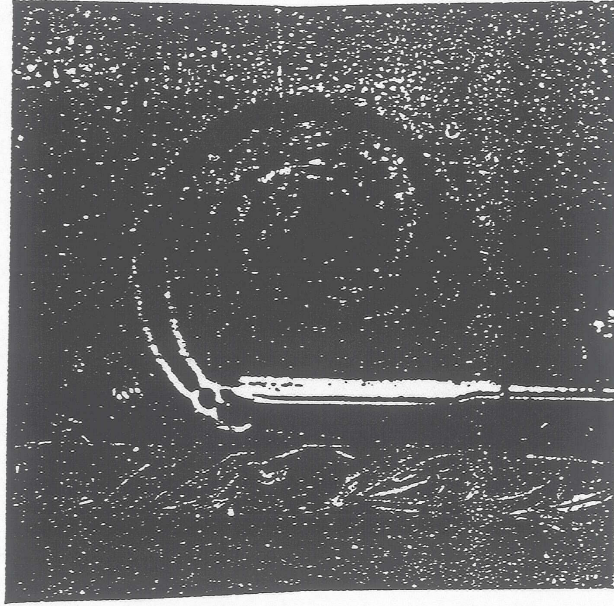

$t = 6.53 \text{ ms}$, $v = 24.0 \text{ ft/s}$

81. Growth of vortices on an accelerated plate.

P-4117-8/4

ADAPTIVE GRIDS

- Unsteady Vortex Shedding from a Flap

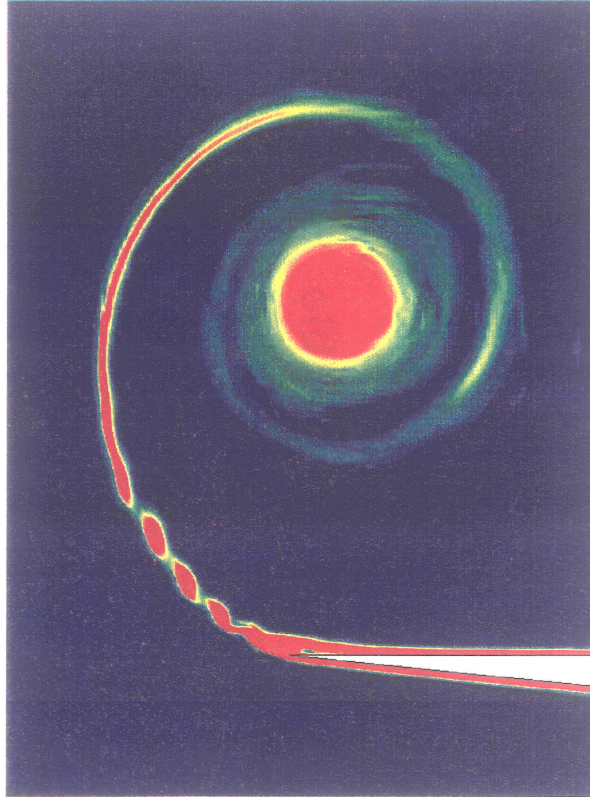
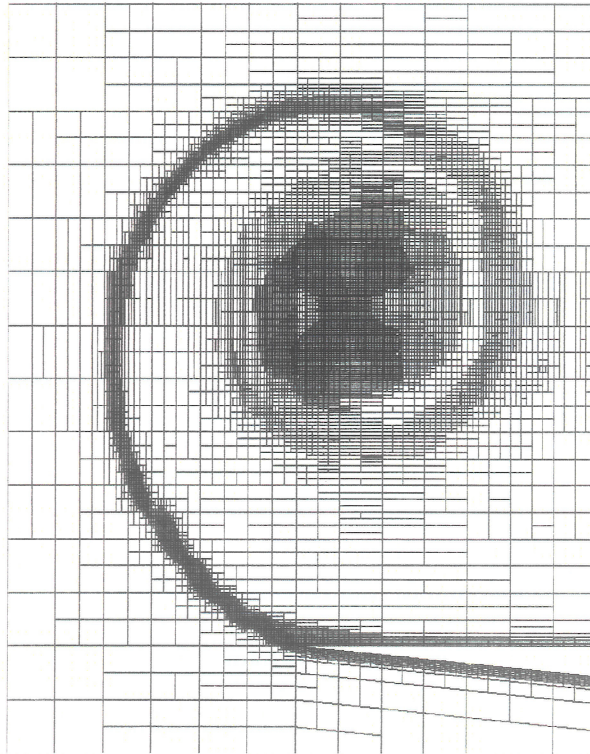

PROBLEM DEFINITION

Stage 1-2 Cavity, T56 Engine Turbine Section

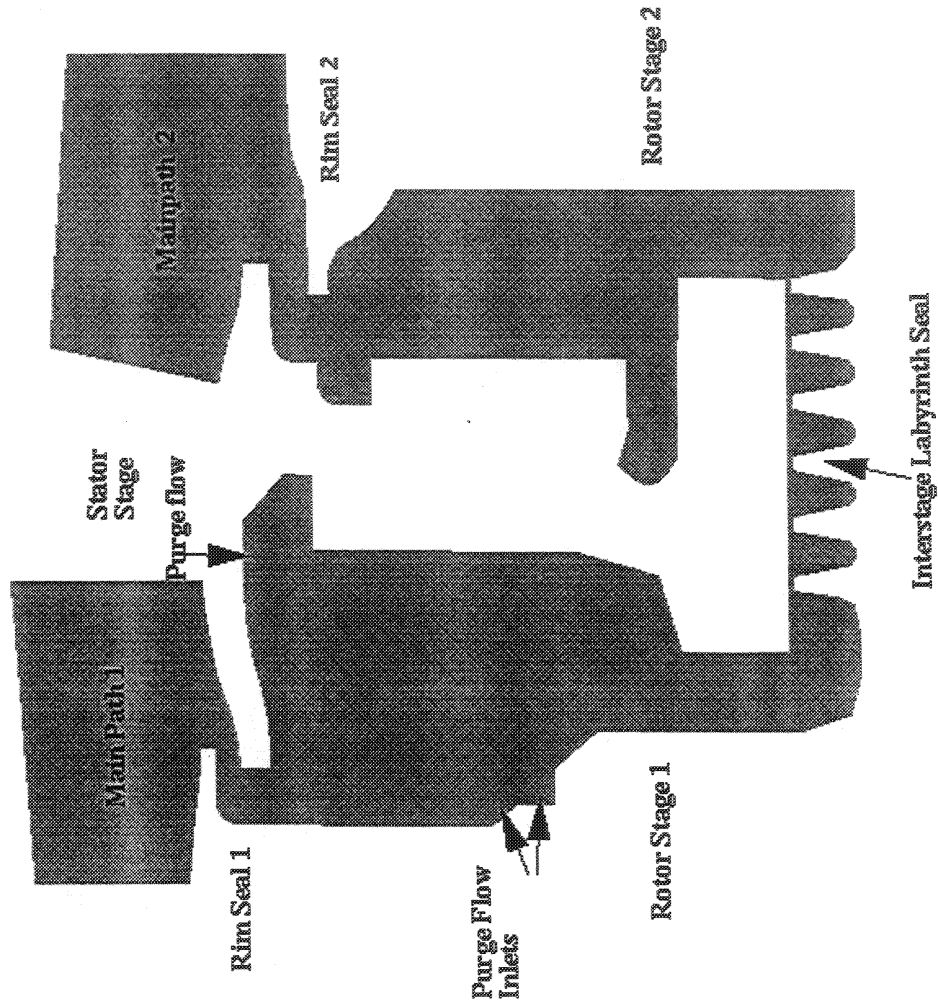

GRID STRUCTURE AT SEVERAL ADAPTATION CYCLES

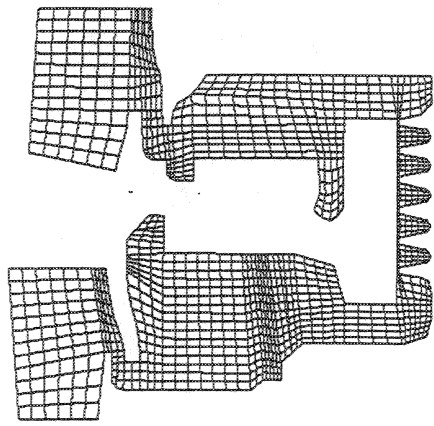

(a) Root Grid, 1180 Cells

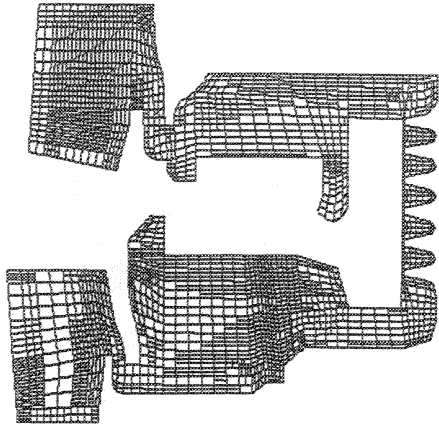

(b) Adapted Grid, 2500 Cells

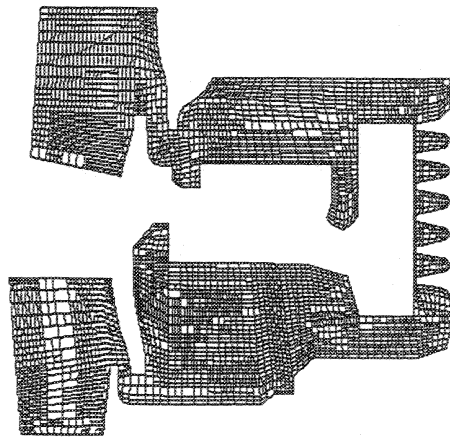

(c) Adapted Grid, 4000 Cells

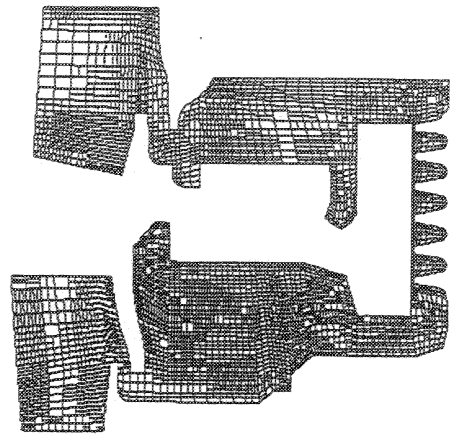

(d) Adapted Grid, 5000 Cells

SOLUTIONS ON FINEST GRID

Stage 1-2 Cavity

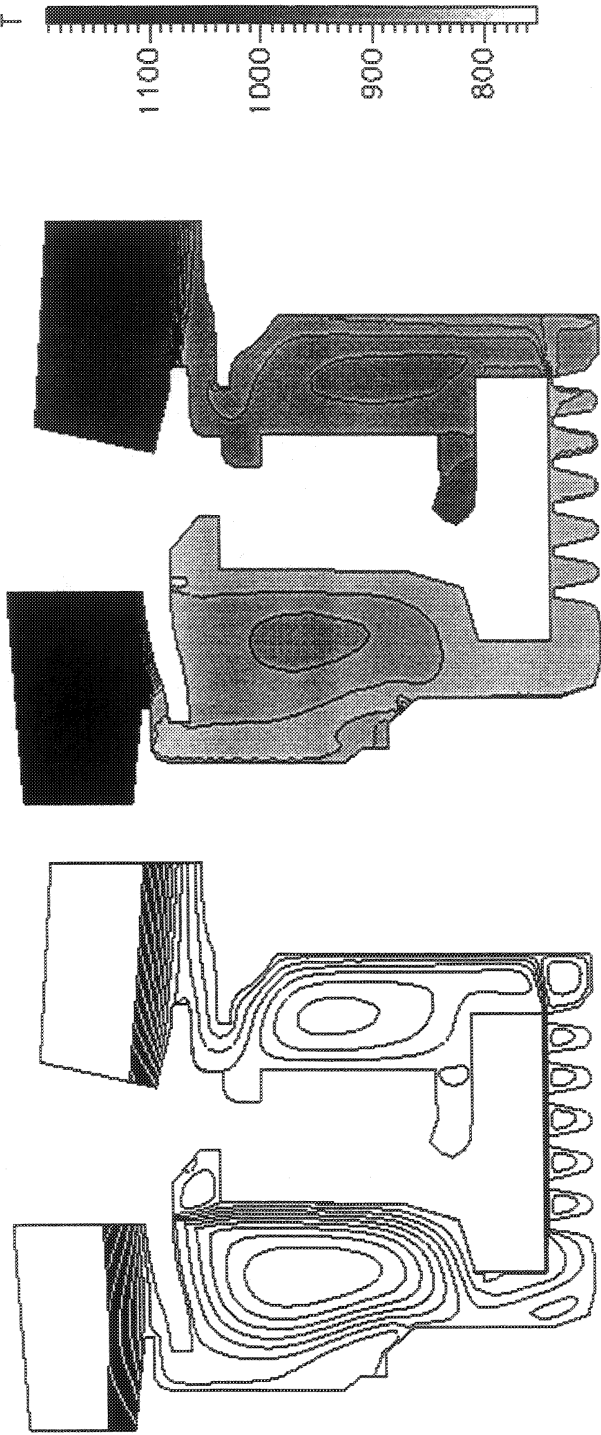

(a) Streamline Plot (Lines in the Main-path Have Been Suppressed). Note Outgoing Flow in Both Rim Seals

(b) Temperature Field in the Cavity

CODE COUPLING/INTERFACE ISSUES

- **Solution Methodology/Codes**
 - **Pressure or Density-Based/Primary Variables**
 - **Flux Calculation Methods**
 - **Boundary Condition Treatment**

- **Coupling Level**
 - **At Subiteration Level**
 - **Equation Level (For Continuity Equation) May be Needed**

- **Interface Placement**
 - **Location Should Minimize Grid Changes**
 - **SCISEAL Grid Fixed, TURBO Grid Time-Varying**

- **Interpolation Routines**
 - **Needed for Data Transfer from One Code to Other**
 - **Conservation of Fluxes**

CURRENT INTERFACE STRATEGY

- **Placement of Interface Along the Rotor Hub Wall**
 - **Intersects Rim Seal Open Area**
 - **Minimizes Grid Interface Distortion**
- **Data Type to be Exchanged**
 - **Fluxes Calculated by TURBO \Rightarrow Used Directly in SCISEAL Boundary Cells**
 - **Variables from SCISEAL \Rightarrow Interpolated and Used in the Ghost Layer at Interface Boundary in TURBO**
 - **Ensures Flux Conservation**

CURRENT STATUS, PLANS

- **Interface Algorithm and Code Modifications are in Place**
 - **Debugging Completed**
- **Will be Used for Time-Accurate Flows in UTRC H.P. Turbine Rig**
 - **Stator and Rotor Plus Disc Cavity Combination**
 - **Experimental Data Used for Validation**
- **Development of a GUI Needed for Ease of Use of Unstructured Code (SCISEAL)**
- **Steady State Preliminary Results for UTRC HP Rig Completed**

SCHEMATIC OF THE H.P. TURBINE RIG

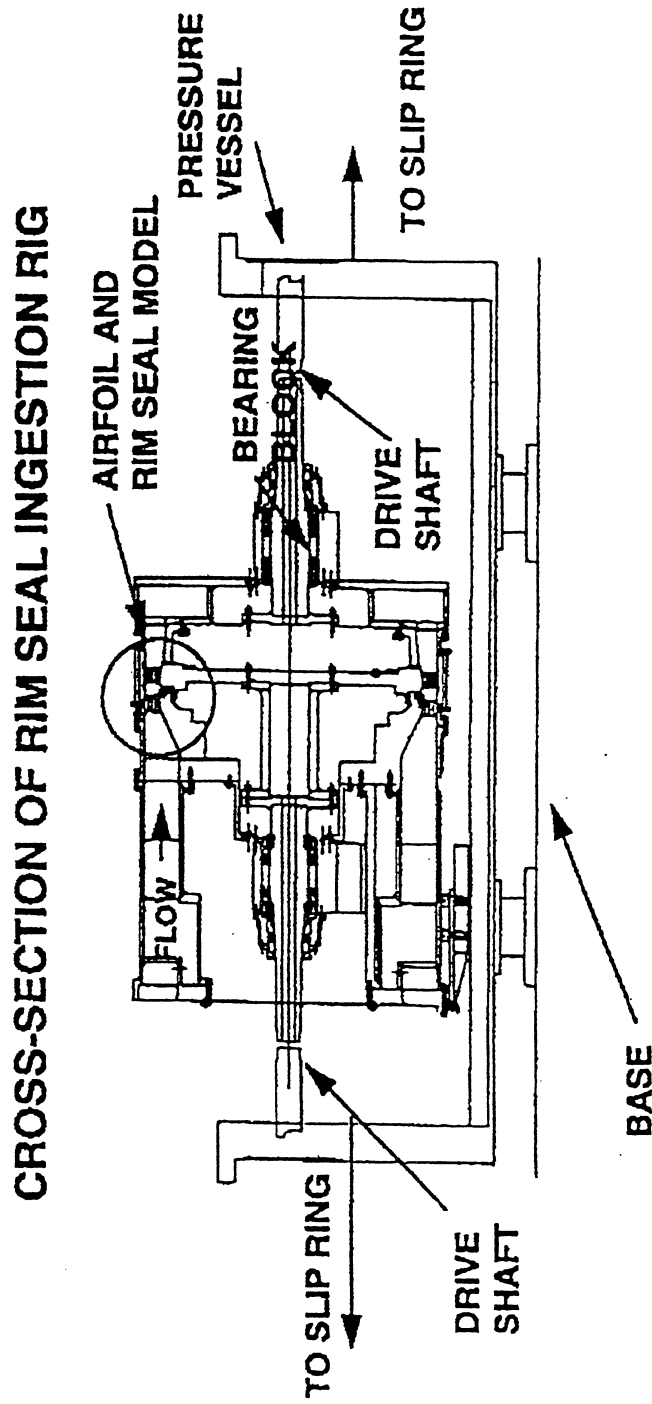

DETAILS OF THE FLOWFIELD IN H.P. RIG

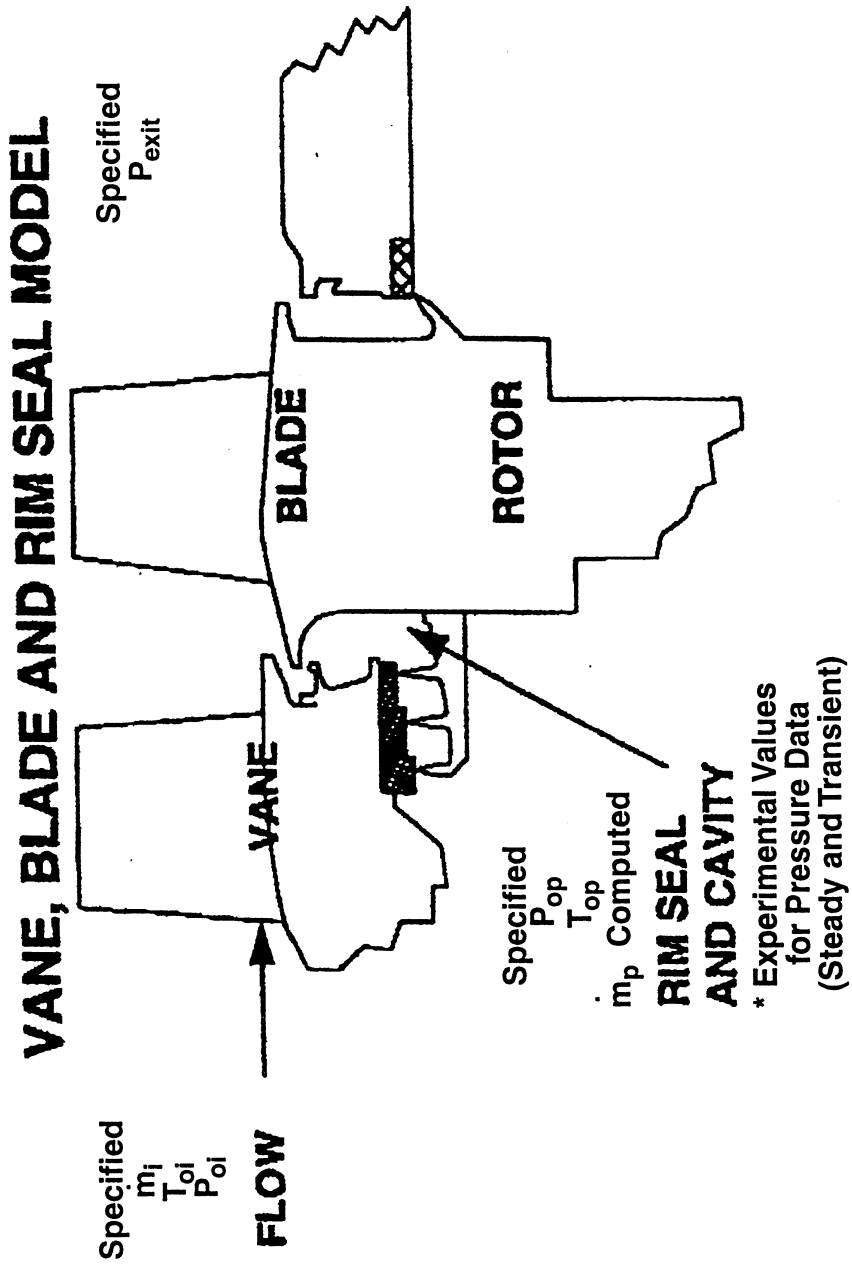

UTRC H.P. Rig

Steady-State Solutions, Static pressures

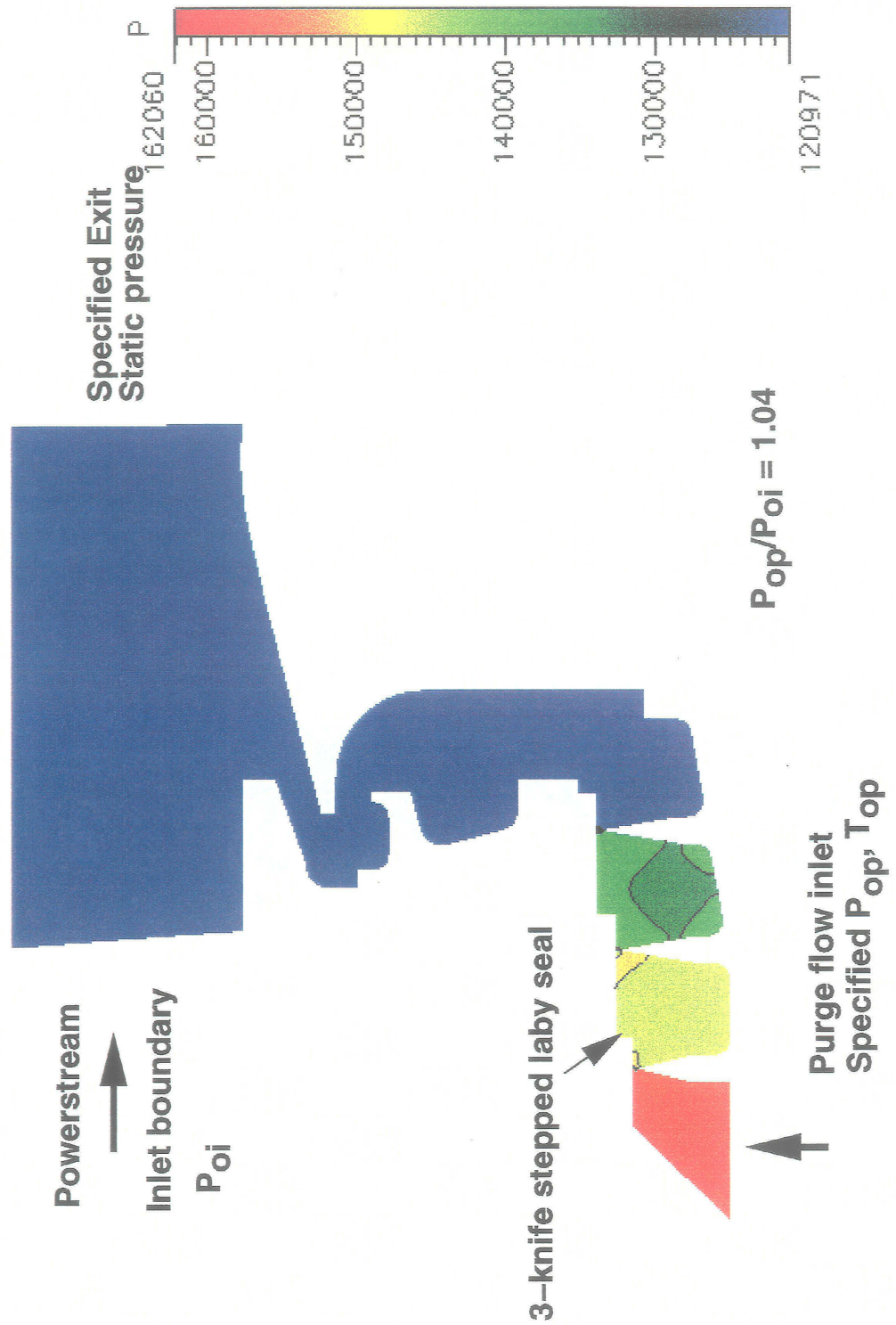

UTRC H.P. RIG

Observations

- Purge Flow \dot{m}_p Measured at Different Pressure Ratios P_{op} / P_{oi}
- Maximum Purge Flow Rate = 1.6% of Powerstream at $P_{op} / P_{oi} = 1.04$
- Minimum (0) Purge Rate $\sim P_{op} / P_{oi} = 0.85$
- 2D, Axisymmetric, Steady State Solutions Obtained
 - Several Different P_{op} / P_{oi} Values
 - Computed Purge Flow $\sim 0.95\%$ of Powerstream at $P_{op} / P_{oi} = 1.04$
 - Cutoff of Purge Flow Seen at P_{op} / P_{oi} Near $P_{op} / P_{oi} = 0.86$

UTRC H.P. Rig

Streamlines at different pressure ratios

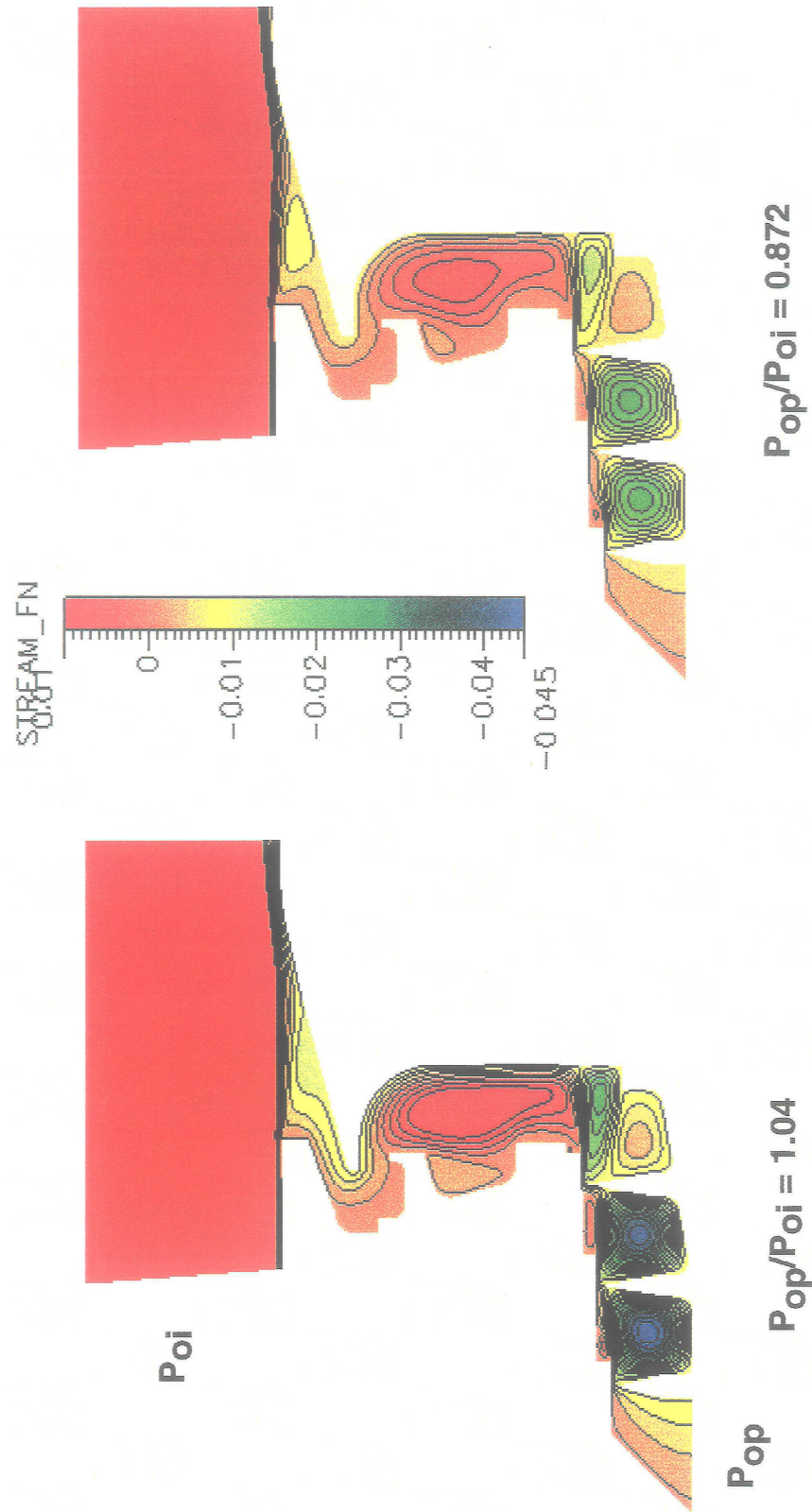

SUMMARY

- **Interaction Between Mainpath and Secondary Flow Important; Need Detailed Information for Design and Performance Predictions**
- **A Numerical Methodology is Being Developed**
 - **Validated Codes for Two Flow Streams: SCISEAL and MS-TURBO**
 - **Interfacing Algorithms/Routines for Coupling**
 - **Validation Against UTRC Data and Other Experiments**
- **Geometries of H.P. Rig Obtained, Steady State Results in Progress**
- **Unsteady Simulations are Being Setup**
- **Plans to Give Software to OEM for Release and Eventual Incorporation in Design Cycle**