

Gamma-ray Large Area Space Telescope – GLAST

Mission Overview

Alexander Moiseev
*(NASA/Goddard Space Flight
Center)*

**on behalf of the GLAST LAT
Collaboration**

GLAST – new gamma-ray observatory, scheduled for the launch near the end of 2007



Updated launch date – January 31, 2008

GLAST Collaboration



United States (NASA and DOE)

- *California State University at Sonoma*
- *Goddard Space Flight Center*
- *Marshall Space Flight Center*
- *Naval Research Laboratory*
- *Ohio State University*
- *Stanford University (HEPL, KIPAC and SLAC)*
- *Texas A&M University – Kingsville*
- *University of Alabama at Huntsville*
- *University of California at Santa Cruz – SCIPP*
- *University of Denver*
- *University of Washington*

France

- *CEA/Saclay*
- *IN2P3*

Italy

- *ASI*
- *INFN (Bari, Padova, Perugia, Pisa, Roma2, Trieste, Udine)*
- *INAF*

Japan

- *Hiroshima University*
- *Institute for Space and Astronautical Science*
- *RIKEN*

Sweden

- *Royal Institute of Technology (KTH)*
- *Stockholm University*

Germany

- *Max Planck Institute*

118 full members

90 affiliated scientists

**38 management, engineering
and technical members**

30 post-doctoral members

55 graduate students

GLAST Observatory



Two instruments onboard:

- **Large Area Telescope LAT** (PI – Peter Michelson, Stanford University; managing organization - SLAC)
 - main instrument, gamma-ray telescope, 20 MeV - >300 GeV
 - scanning (main) mode - 20% of the sky all the time; all parts of sky for ~30 min. every 3 hours
- **GLAST Burst Monitor GBM** (PI – Charles Meegan, NASA/MSFC)
 - 10 KeV – 25 MeV
 - observes whole unocculted sky all the time, searching for gamma-ray bursts

**5-year mission (10-year goal), 565 km circular orbit,
~28° inclination**

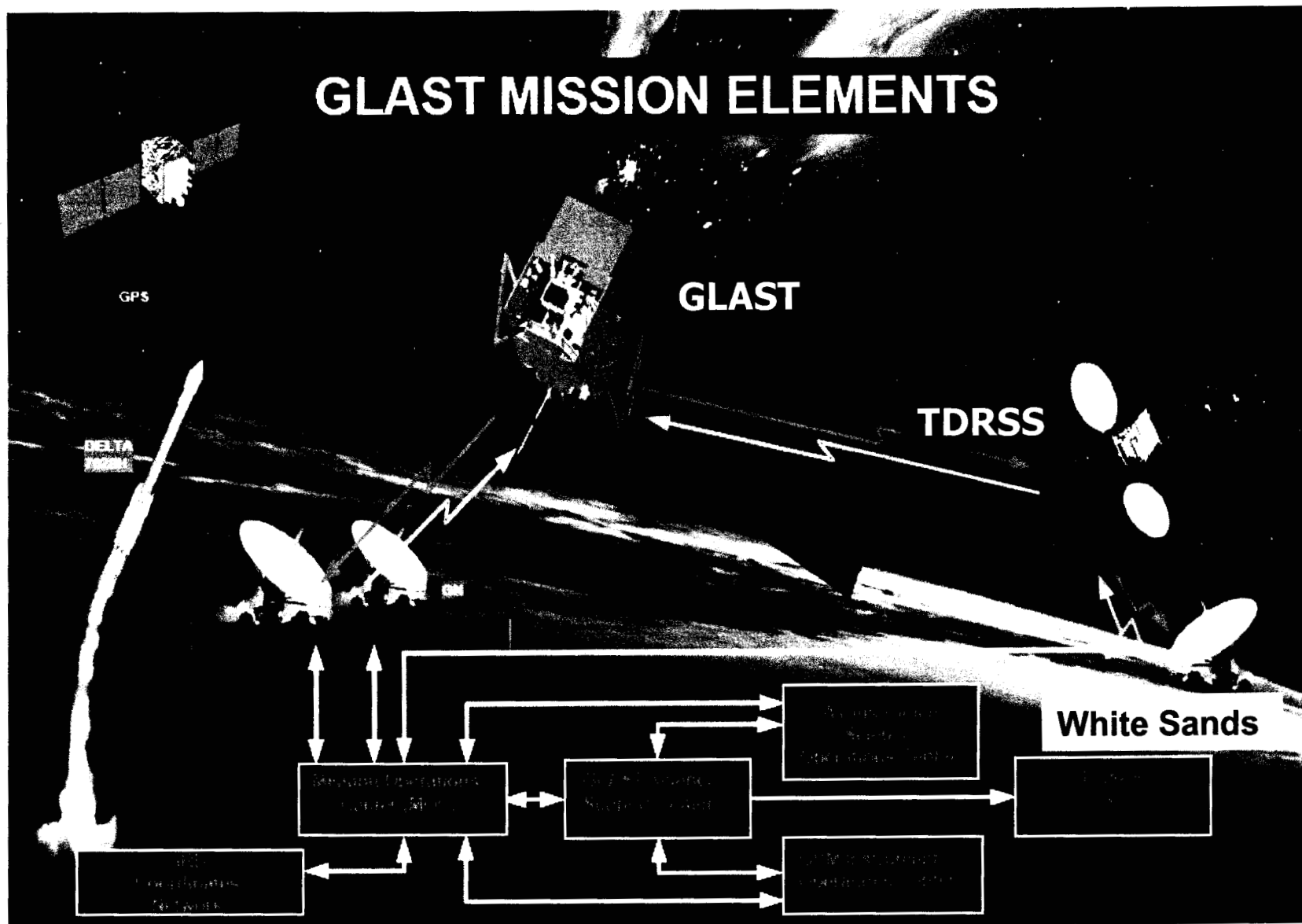

Mission Operation Center @GSFC: Satellite operation
Instrument Science Operation Center @SLAC: Monitoring the LAT, command preparation, etc.

GLAST Science



GLAST science objectives cover probably everything in high energy astrophysics:

- **Active Galactic Nuclei (AGN), including Extragalactic background light (EBL)**
- **Gamma-ray bursts (GRB)**
- **Pulsars**
- **Diffuse gamma-radiation**
- **EGRET unidentified sources**
- **Solar physics**
- **Origin of Cosmic Rays**
- **Dark Matter and New Physics**

Excited to run simultaneous γ -astronomy measurements with AGILE, CANGAROO, HESS, INTEGRAL, MAGIC, MILAGRO, SWIFT, VERITAS!

Large Area Telescope LAT



Heritage from OSO-III, SAS-II, COS-B, and EGRET, but:

- **large field of view (~ 2 sr, 4 times greater than EGRET) and large effective area (~ 1 m²)**
- **large energy range, overlapping with EGRET under 10 GeV and with HESS, MAGIC and VERITAS above 100 GeV, including poorly-explored 10 GeV – 100 GeV range.**
- **High energy (5-10%) and spatial resolution**
 - **Unprecedented PSF for gamma-rays, >3 times better than EGRET for $E > 1$ GeV**
- **Small dead time (< 30 μ s, factor of $\sim 4,000$ better than EGRET) – GRB time structure!**
- **Excellent timing (~ 1 μ s) to study transient sources**
- **No consumables – chance for longer mission!**

LAT Performance Summary



Parameter	SRD Value	Current Best Estimate
Peak Effective Area (in range 1-10 GeV)	>8000 cm ²	~ 9000 cm ²
Energy Resolution 100 MeV on-axis	<10%	~ 10%
Energy Resolution 10 GeV on-axis	<10%	< 6%
Energy Resolution 10-300 GeV on-axis	<20%	< 8%
Energy Resolution 10-300 GeV off-axis (>60°)	<6%	~ 5%
PSF 68% 100 MeV on-axis	<3.5°	< 3.2°
PSF 68% 10 GeV on-axis	<0.15°	< .1
PSF 95/68 ratio	<3	< 3
PSF 55°/normal ratio	<1.7	< 1.5
Field of View	>2sr	> 2 sr
Background rejection (E>100 MeV)	<10% diffuse	<10% (after residual subtraction)
Point Source Sensitivity(>100MeV)	<6x10 ⁻⁹ cm ⁻² s ⁻¹	< 4 x 10 ⁻⁹
Source Location Determination	<0.5 arcmin	< 0.4 arcmin
GRB localization	<10 arcmin	< 5 arcmin
Instrument Time Accuracy	<10 μsec	<< 10 μsec (current 1σ = .7μs)
Dead Time	<100 μsec/evt	26.5 μsec/event nominal
GRB notification time to spacecraft	<5 seconds	

Comparing EGRET and LAT Sky

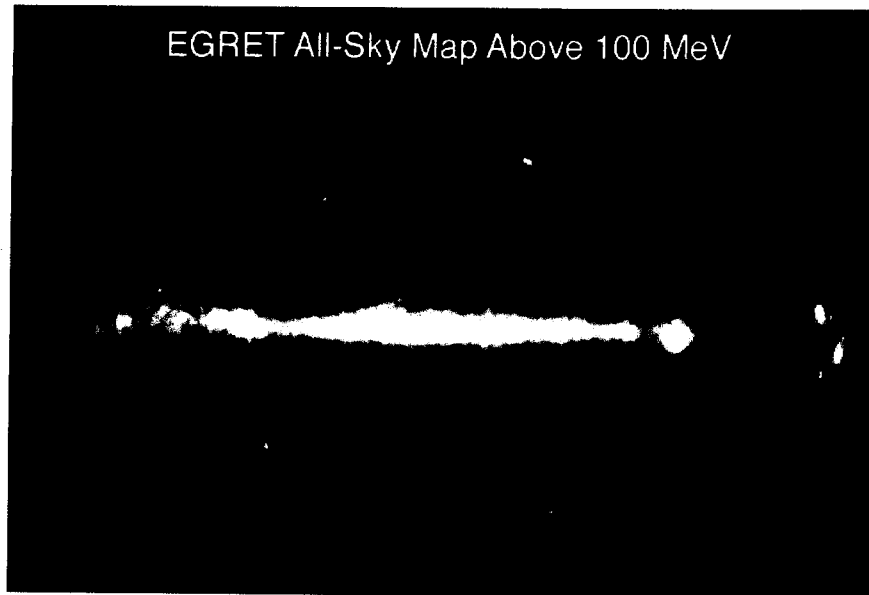

EGRET

***LAT one-year
simulation:*** expect
>3,000 sources comparing
with 271 found by EGRET



LAT calibration approach



- **LAT is a complicated instrument, requiring very good calibration to provide the energy, direction and timing reconstruction**
- **The approach is to avoid a full LAT beam calibration, but rather run the beam tests on the LAT parts and combine the results in the comprehensive whole LAT Monte Carlo simulations (based on Geant 4). This approach requires high confidence in Monte Carlo simulations:**
 - **Separate parts of LAT have been tested on the different beams (SLAC, CERN, DESY, GSE) several times starting in 1997**
 - **Single-tower LAT prototype was flown on a balloon in 2001 to verify the design and data analysis approach and to perform background measurements**
 - **LAT Collaboration ran detailed beam tests at CERN and GSI in the summer of 2006 with 2-tower LAT prototype (Calibration Unit = CU) to verify the simulations. We are still in the process of tuning the MC to agree with the beam test data**

LAT beam test at CERN, Summer 2006



LAT Beam test at CERN (cont.)

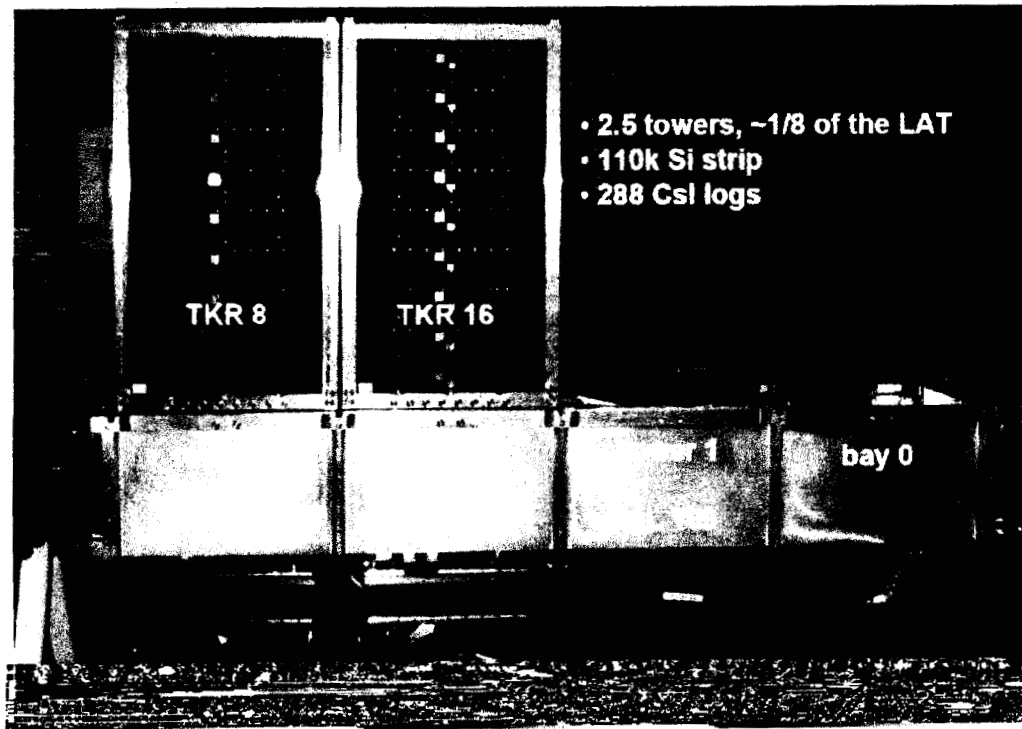

LAT Calibration unit during preparation to CERN beam test

4 weeks at PS/T9 area (26/7-23/8)

- Gammas @ 0-2.5 GeV
- Electrons @ 1,5 GeV
- Positrons @ 1 GeV (through MMS)
- Protons @ 6,10 GeV (w/ & w/o MMS)

11 days at SPS/H4 area (4/9-15/9)

- Electrons @ 10,20,50,100,200,280 GeV
- Protons @ 20,100 GeV
- Pions @ 20 GeV

Data, data, data...

- 1700 runs, 94M processed events
- 330 configurations (particle, energy, angle, impact position)
- Mass simulation

A very dedicated team

- 60 people worked at CERN
- Whole collaboration represented

□-event in full LAT Simulations

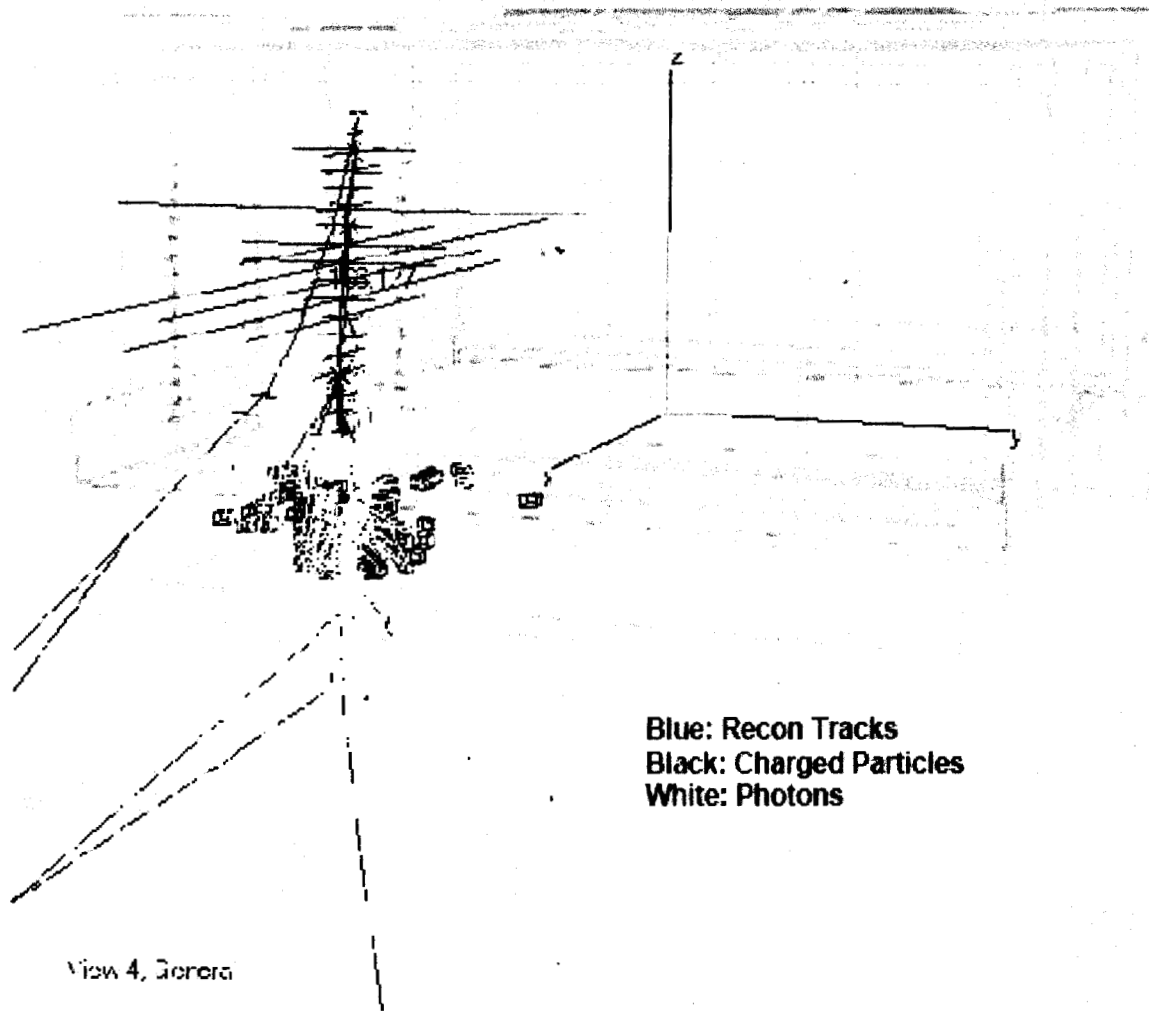

Preparation for science data analysis



Actually this is a subject for a long separate talk

- **We want to be ready to quickly absorb and process the huge amount of raw data to be collected during the mission (~25 Million events a day to be transmitted to the ground)**
- **In order to create the science data from the raw data, we need to:**
 - **Apply all LAT detectors calibration parameters and instrument response function in order to reconstruct the events**
 - **Learn how to recognize and remove the background events (charged particles, albedo photons) – extremely challenging task!**
 - **Apply the LAT-Spacecraft-Sky coordinate conversion**
 - **Etc.**

Preparation to the science data analysis

(cont.)



- **After creating the science data bank, we can start working on LAT science objectives**
 - **In order to be prepared for this crucial step, we run several steps of Data Challenge with huge amount of different simulations, which ended with a “Gamma-ray All-Sky Survey Simulations”**
 - **Astrophysical objects were put in “55-day Gamma-ray All-Sky Survey Simulations” using realistic orbit and altitude profile and detectors responses anonymously by a group of people (kept in secret)**
 - **The users (LAT members) tested the science tools and their skills to find that objects and determine their properties. The “truth” was revealed at the end**
- **In order to improve the communication between LAT scientists, 9 Science Working Groups were established correspond to the GLAST science objectives; team members joined according to their personal interests. These groups are running weekly VRVS (EVO) meetings; each group has a confluence webpage. All publications are subject to group review**

The Contents of the LAT Data Challenge Sky



Bright variable AGN	204	Milky Way itself	1
Faint Steady AGN	900	Pulsars	414
GRB	134 (64 GBM triggers)	Plerions	7
GRB Afterglow	9	SNR	11
PBH	1	XRB	5
Galaxy clusters	4	OB associations	4
Galaxies	5	Small molecular clouds (40)	40
Extragalactic diffuse	1	Dark matter (~2)	~2
		'Other 3EG' (120)	120
		Sun (1 flare)	1 flare
		Moon (1)	1

High Energy Electrons with LAT



We started looking at what LAT can do besides gamma-ray astronomy

Being a γ -ray telescope, LAT intrinsically is an electron spectrometer.
Let's use it!

Here is currently available experimental data on HE electrons

We analyzed LAT capability to detect electrons and separate them from hadron background

LAT will collect $\sim 10^7$ electrons above 20 GeV per year, with 5-20% energy resolution and $< 3\%$ of the residual hadron contamination

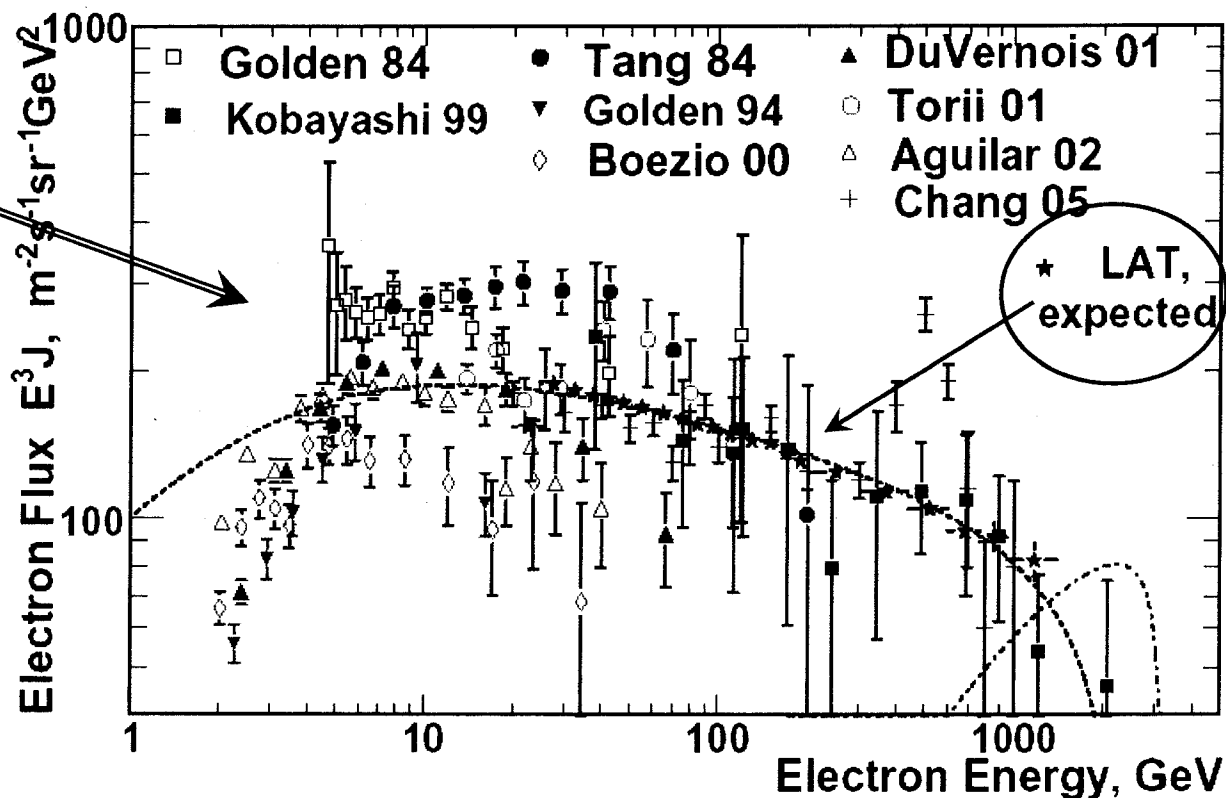

GLAST Burst Monitor Overview

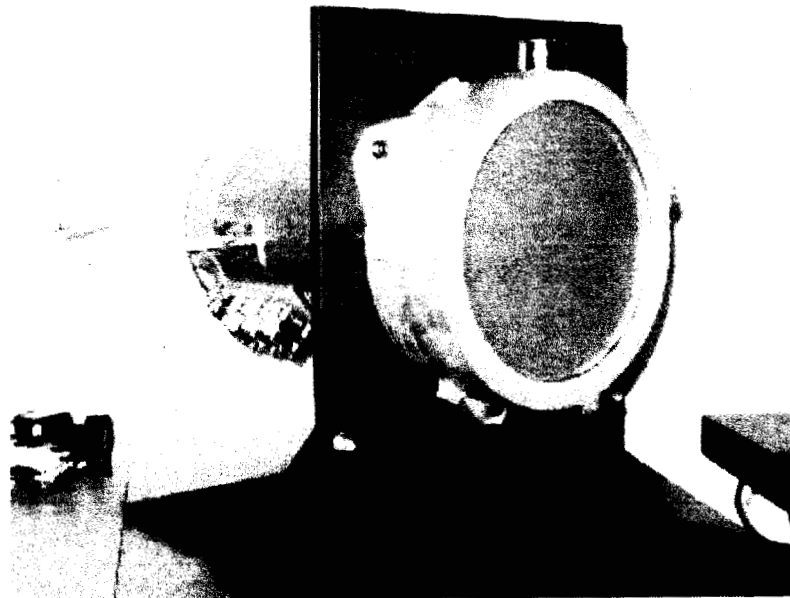

Sodium Iodide (NaI)

12 detectors
5" diameter by 1/2" thick
Cover low energy range
Thin Be window
Determines burst directions

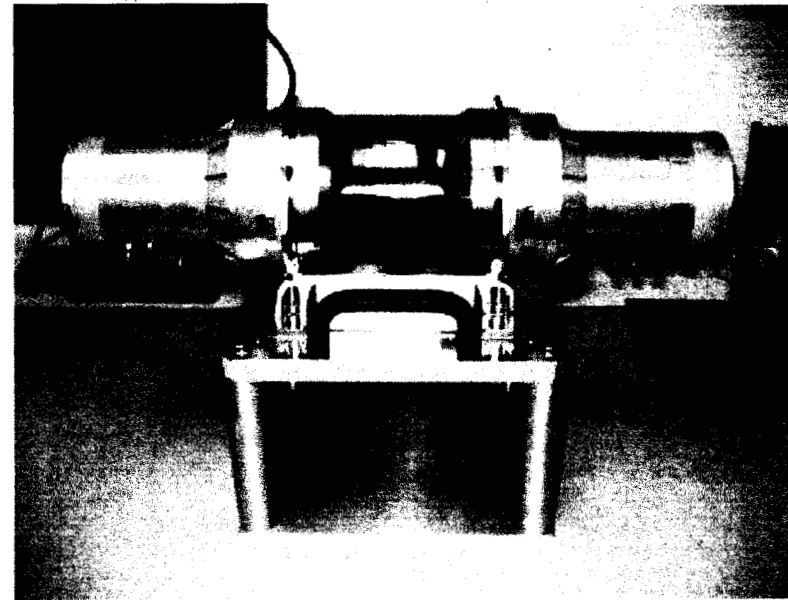

Bismuth Germanate (BGO)

2 detectors
5" diameter by 5" thick
Cover high energy range
Two PMTs for redundancy

The LAT Instrument Overview



Pair-conversion gamma-ray telescope: 16 identical “towers” providing conversion of γ into e^+e^- pair and determination of its arrival direction (Tracker) and energy (Calorimeter). Covered by segmented AntiCoincidence Detector which rejects the charged particles background

Silicon-stripped tracker: 18 double-plane single-side (x and y) interleaved with 3.5% X_0 thick (first 12) and 18% X_0 thick (next 4) tungsten converters. Strips pitch is 228 μm ; total 8.8×10^5 readout channels

Segmented Anticoincidence Detector: 89 plastic scintillator tiles and 8 flexible scintillator ribbons. Segmentation reduces self-veto effect at high energy.

Hodoscopic CsI Calorimeter Array of 1536 CsI(Tl) crystals in 8 layers.

Electronics System Includes flexible, robust hardware trigger and software filters.

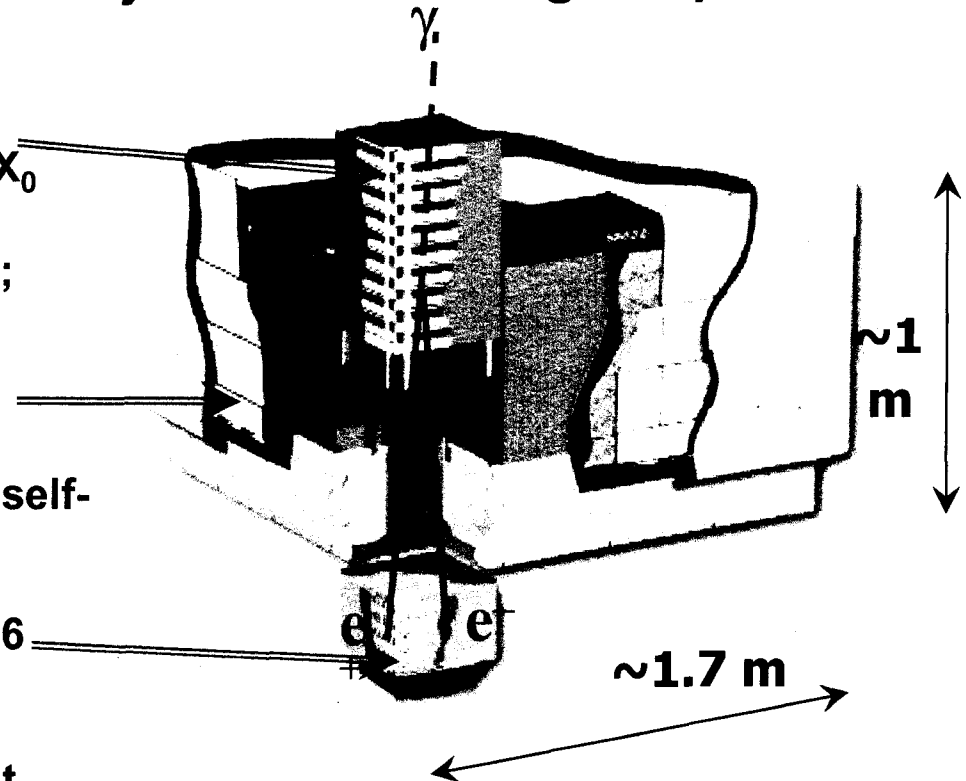

4x 4 wafers
silicon plane

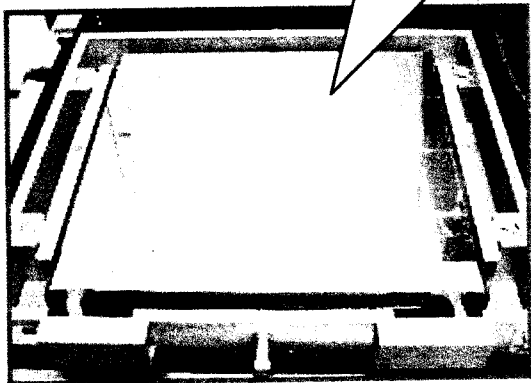

1 "tray" ~ 40cm by 40cm

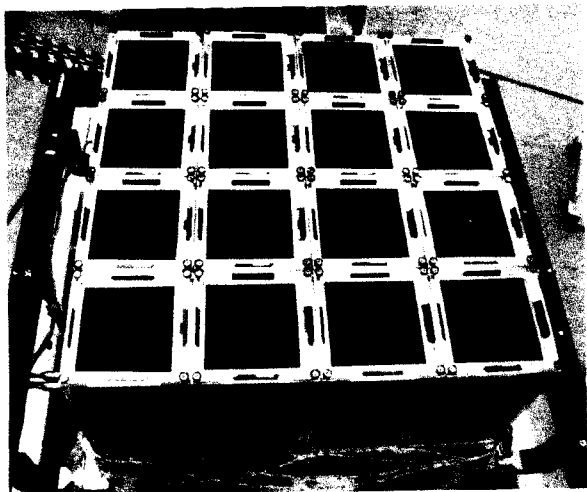

16 "towers" integrated in LAT

Tracker

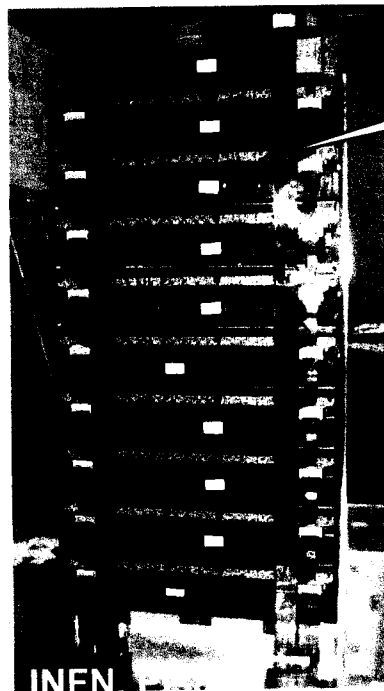

18-plane single
tower, uncovered

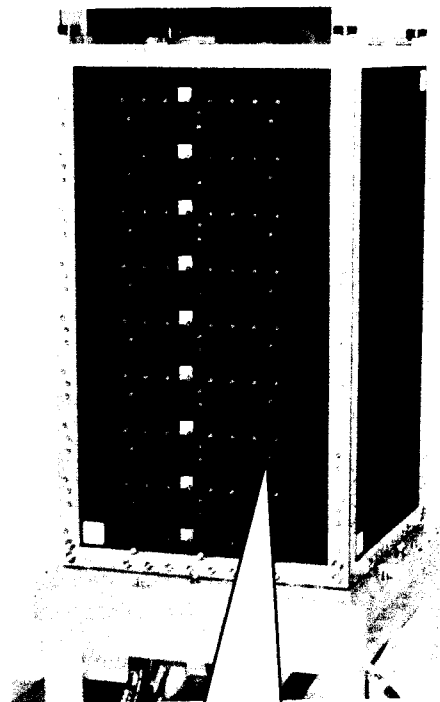

single tower,
covered



Calorimeter



Calorimeter single module structure (goes on the bottom of tracker "tower"):

- 8 layers of 12 CsI(Tl) crystals
- alternating orthogonal layers
- dual PIN photodiode on each end of crystals

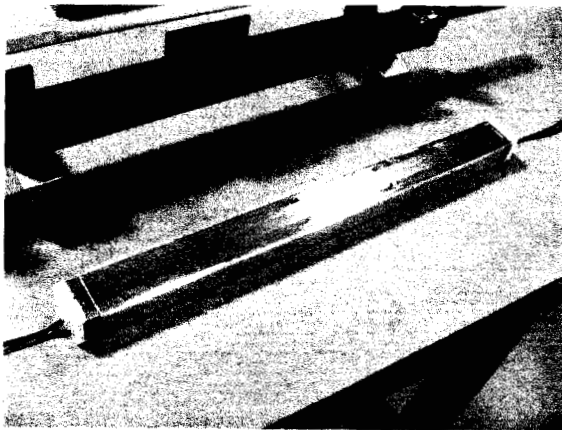
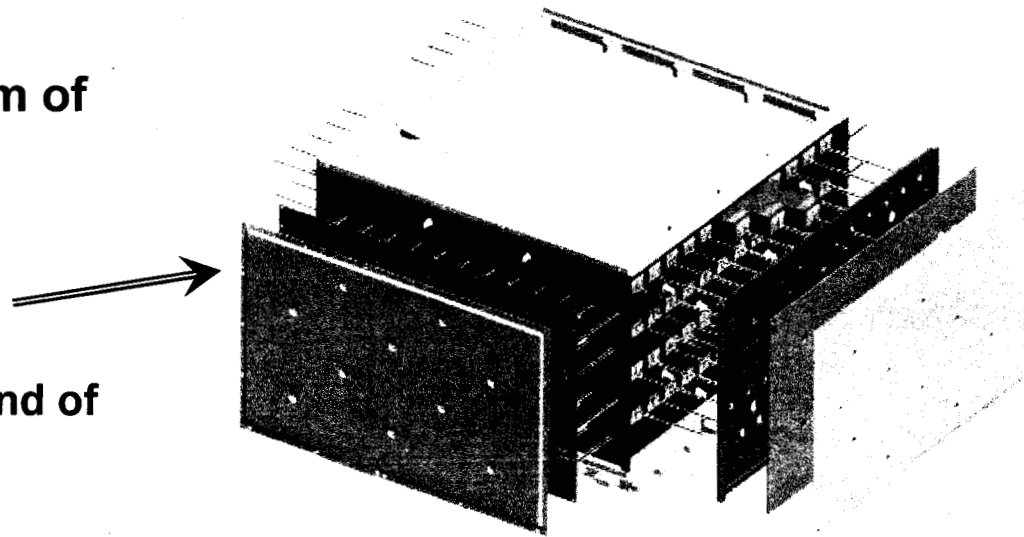

single crystal

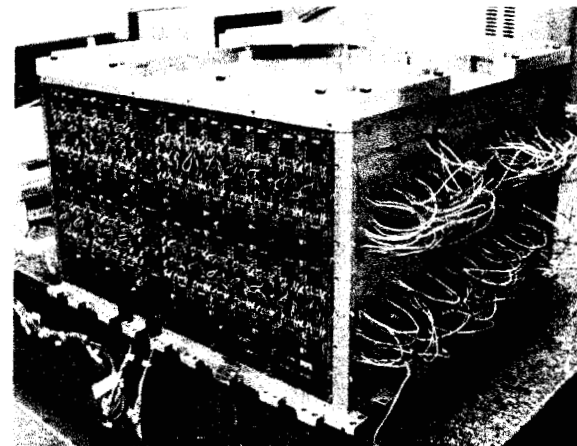

assembled single calorimeter module (1 of 16)

AntiCoincidence Detector



Challenge in the design – meeting two competing requirements in providing high efficiency of charge particle detection, and low sensitivity to backslash-caused signals

Design:

- 89 scintillator tiles with wave-length shifting fibers readout
- to minimize the detector dead area, the tiles overlap in one direction; gaps between tiles in another direction are covered by flexible scintillating ribbons
- provides 0.9997 efficiency of singly charged relativistic particles over entire detector area of $\sim 8.3 \text{ m}^2$

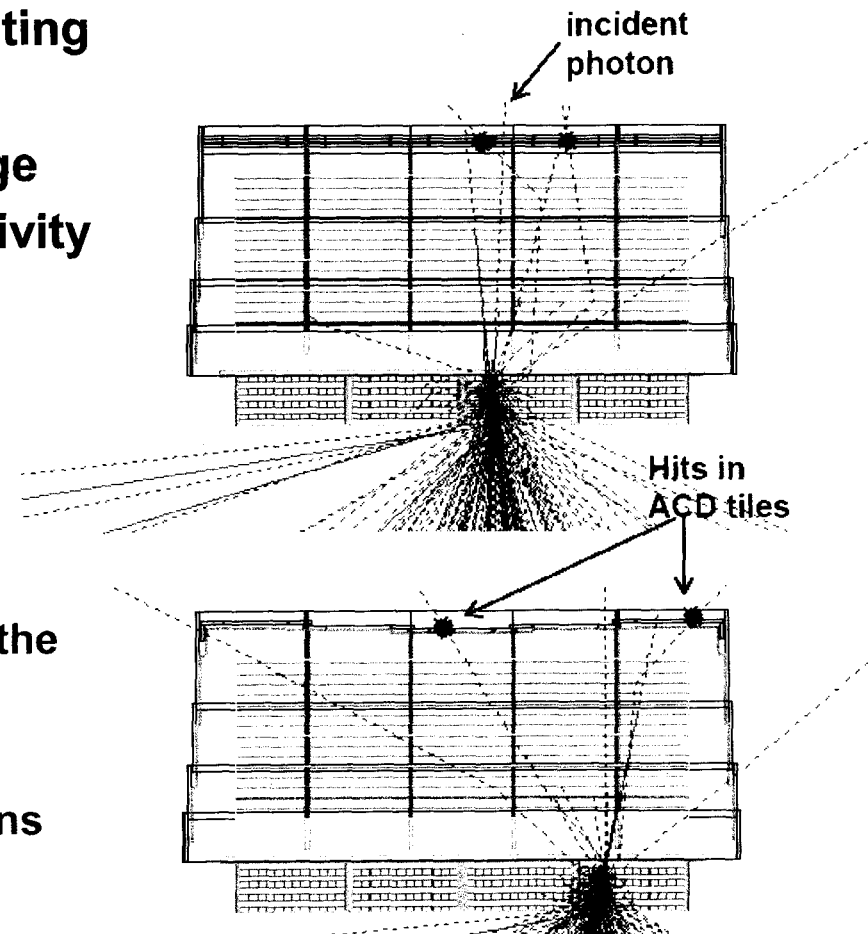

AntiCoincidence Detector (cont.)

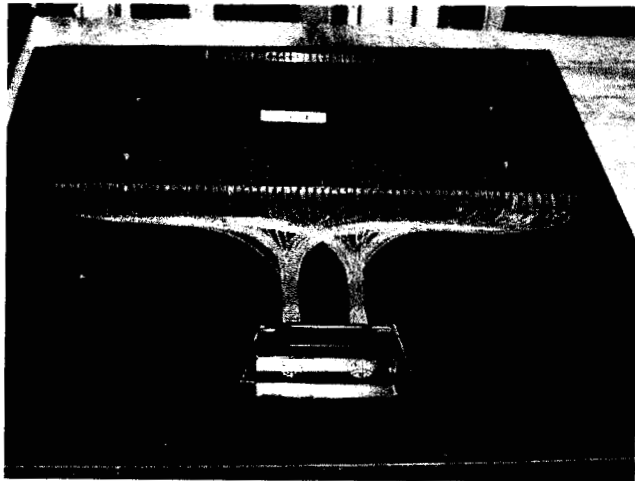

Single ACD tile
(unwrapped)



Integration process



Assembled!

LAT before installation of ACD

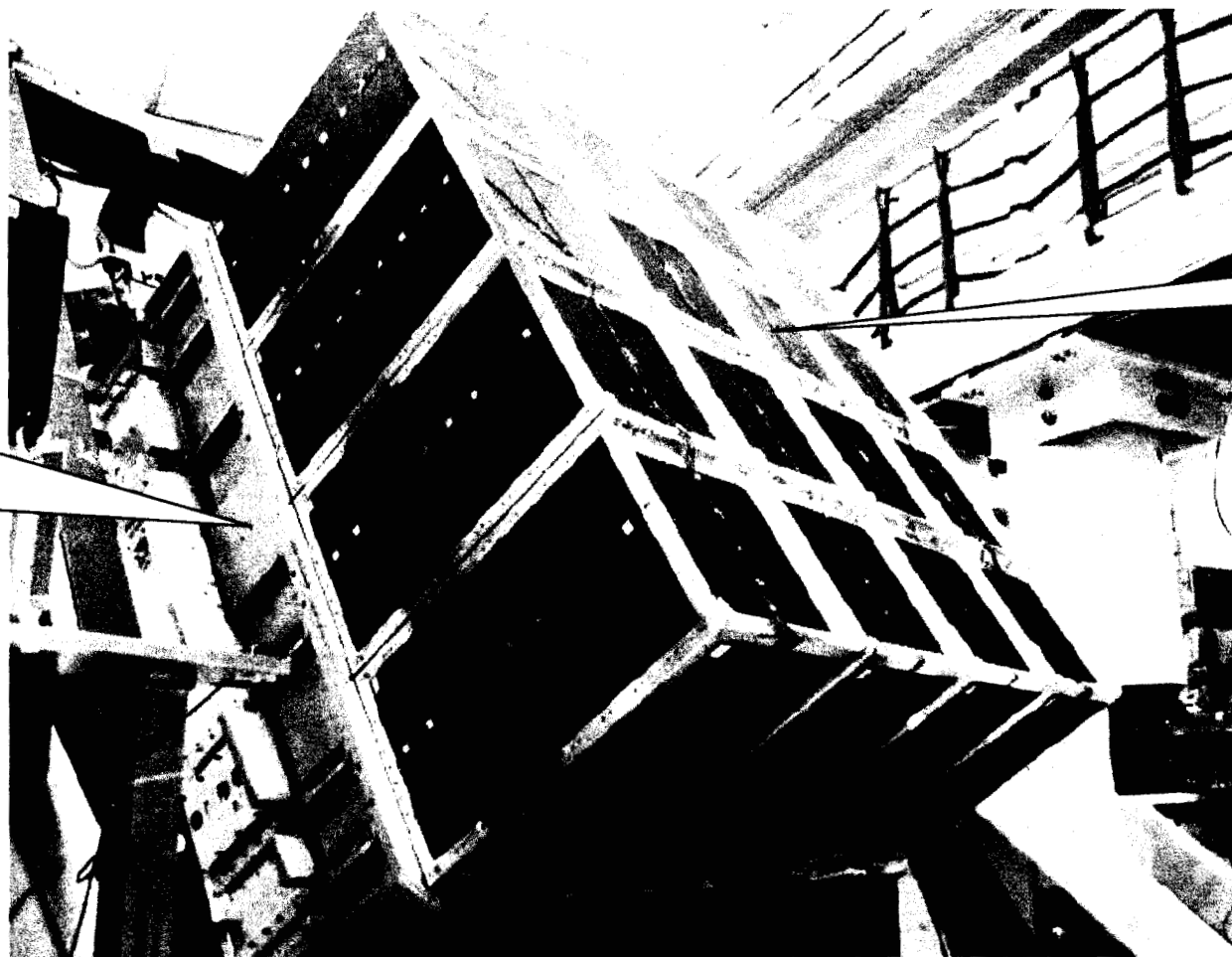

LAT grid,
covering
calorimeter
modules

16 Tracker
towers

ACD installation on LAT



ACD covered by micrometeoroid shield and thermal blanket, is being lowered onto the LAT

16 Tracker towers

Gamma-event in single tower (real!)

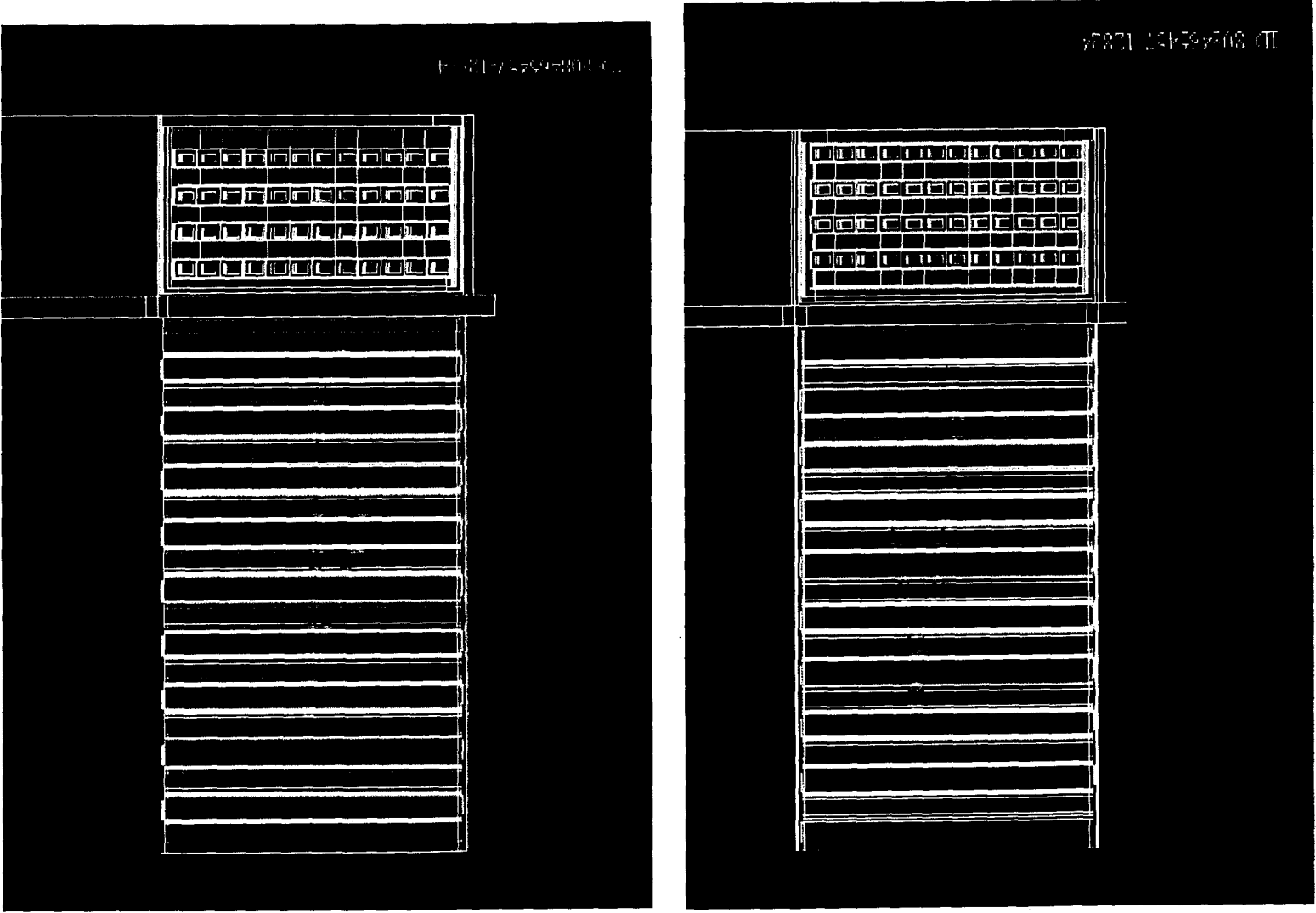

Alexander Moiseev

Science Forum

Moscow, October 3, 2007

Real Muon event in LAT: 6-month long comprehensive tests at SLAC (December 2005 – June 2006)

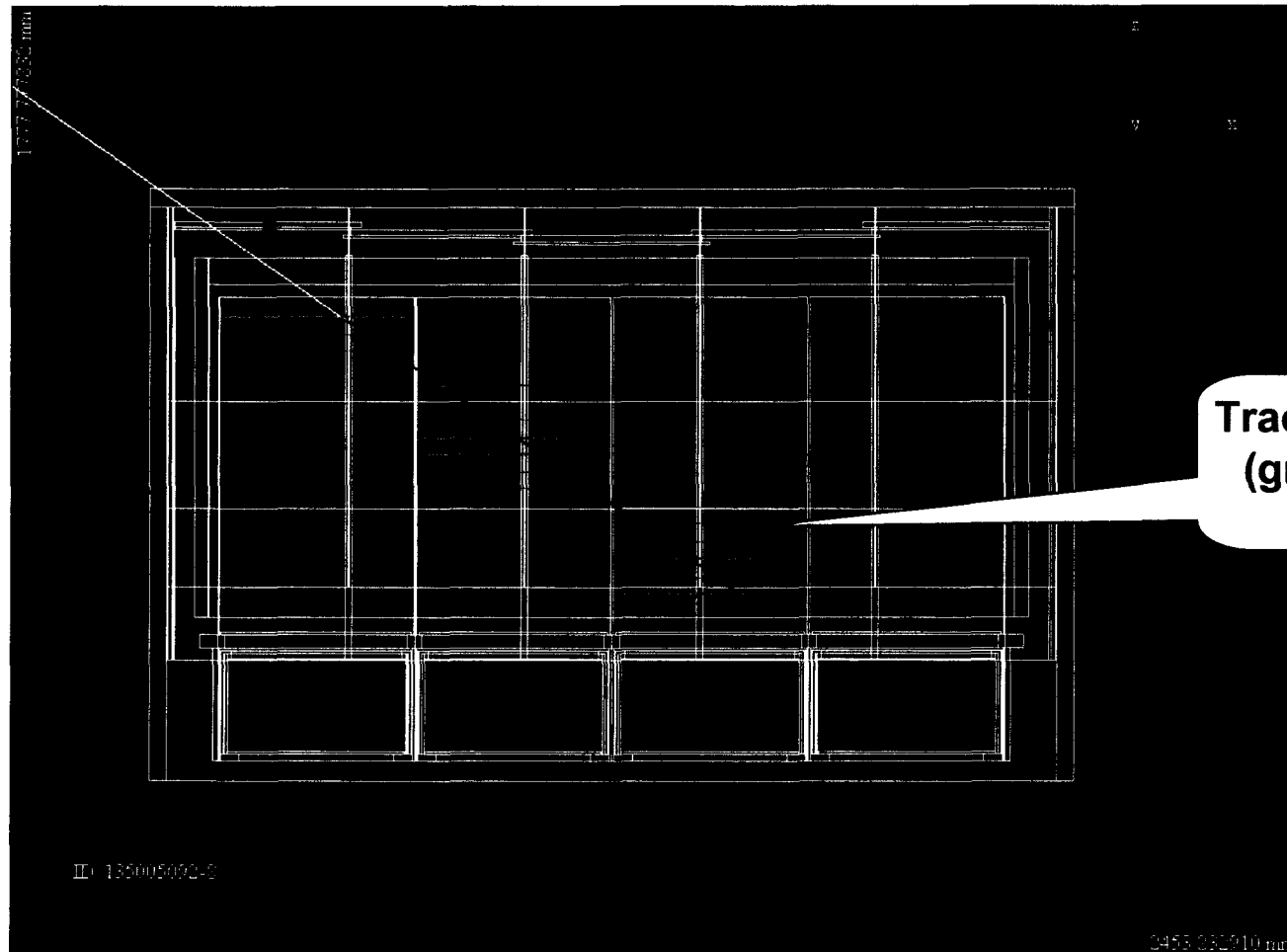

LAT on the Vibration table: 3-month long environmental tests at NRL (Summer 2006)

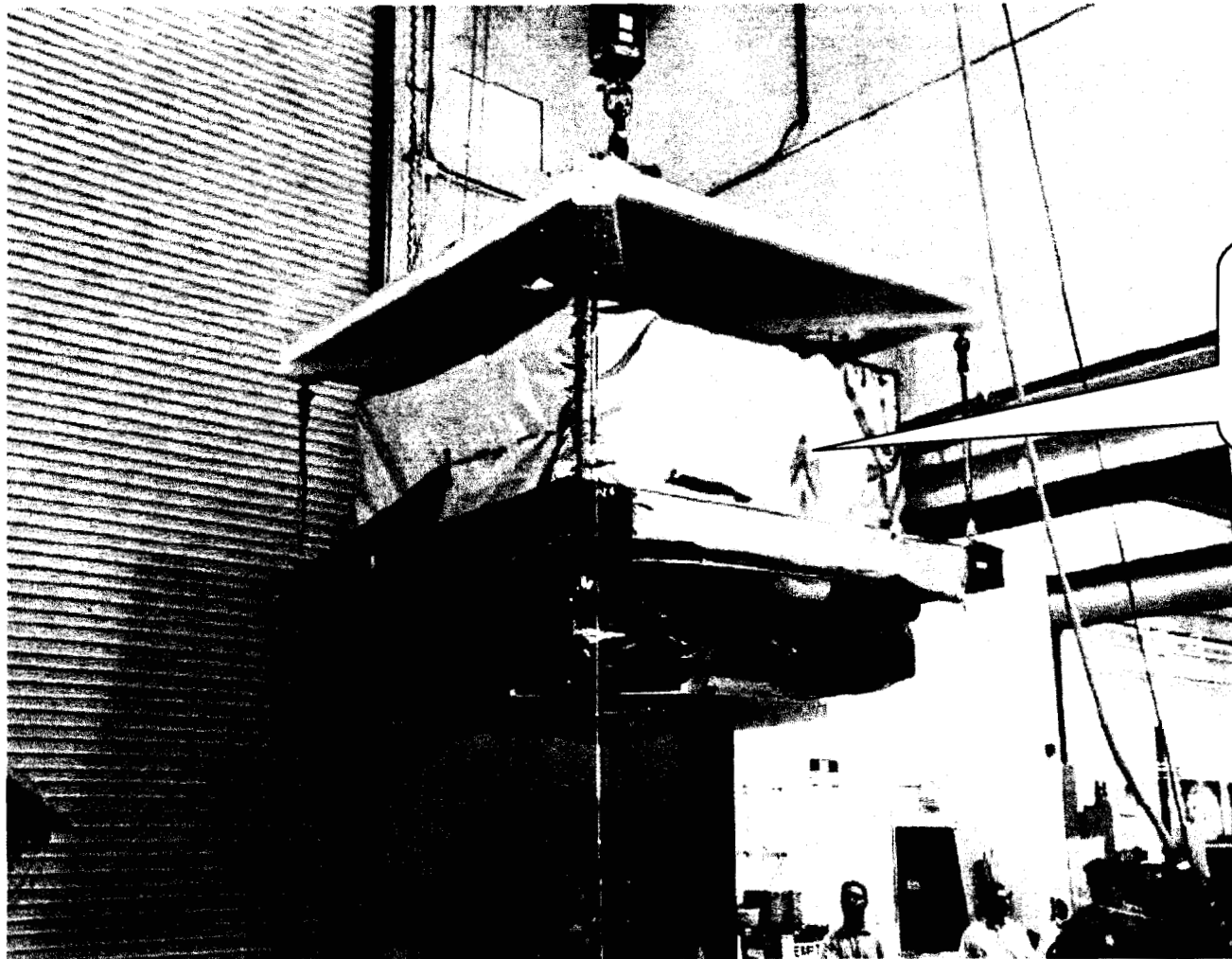

LAT covered by MMS and thermal blanket

LAT In Thermal-Vacuum Chamber

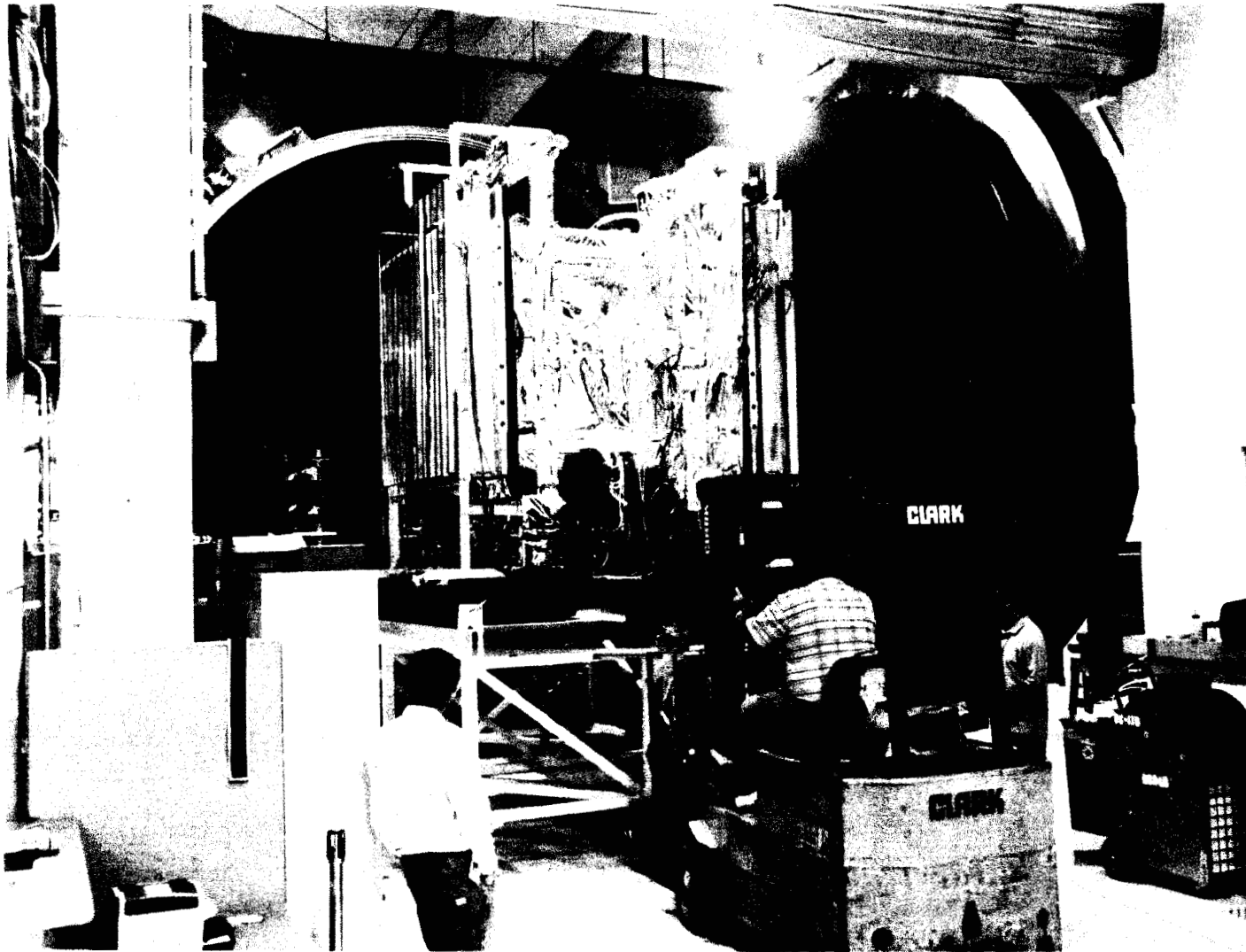

Integration to spacecraft



- ✓ **December 2006 – completed integration to the spacecraft**
- ✓ **April 2007 - Comprehensive tests completed**
- ✓ **Currently ongoing environmental tests**

Data Release Plan and Operations



- **First Year observations**
 - After initial on-orbit checkout (60 days), the first year of observations will be a sky survey.
 - Repoints for bright bursts and extraordinary ToOs will be supported.
- **First Year Data release**
 - All GBM data and LAT data from gamma-ray bursts
 - High level LAT data on ~20 selected sources.
 - High level LAT data on all sources which flare above 2×10^{-6} ph (>100 MeV/cm²s), (rate ~1-4 such objects per month).
- **Year 2 and beyond**
 - Observing plan will be driven by peer-reviewed guest investigator proposals.
 - Default mode will still be sky survey
- **Year 2 and beyond data release**
 - All data (including the first year data) are released as soon as possible through the GLAST Science Support Center
 - There is no proprietary period for data.

Summary



- **GLAST is on its final steps toward the orbit!**
- **1-st GLAST Symposium was held at Stanford last February with ~400 participants and ~70 LAT presentations**
- **Numerous presentations at Conferences (HEAD, AAS, APS, ICRC, etc) and instrument papers in journals**
- **Main publications are ahead!**