

NASA/GE Highly-Loaded Turbine Research Program

Fundamental Aeronautics
Subsonic Fixed Wing Project
Aerothermodynamics Discipline

Dr. Paul W. Giel, ASRC/RTT, NASA Glenn Research Center

Presented at the AIAA Turbine Engine Testing Working Group (TETWoG) Meeting
Ohio Aerospace Institute, Cleveland, Ohio

May 8-9, 2008

An overview of the NASA/GE Highly-Loaded Turbine Research Program at the NASA Glenn Research Center is presented. The program is sponsored by the Subsonic Fixed Wing Project of the Fundamental Aeronautics Program. The goals of the turbine research program are presented along with their relationship to the higher-level program goals. Two turbine research programs are described; the highly-loaded, single-stage high pressure turbine (HPT) and the highly loaded low pressure turbine (LPT).

The HPT program is centered on an extremely high pressure ratio single-stage turbine with an engine stage pressure ratio of 5.5. It was designed with a 33% increase in stage loading. It has shown performance levels 2 points better than current engines operating at the higher work level. Some advantages of the turbine include reduced weight and parts count. Optimization of the blade shape to reduce shock losses is described.

The LPT program utilizes a four-stage low pressure turbine with an integral first stage vane/transition duct strut; counter-rotation; low-solidity blading; fully optimized flowpath including vanes, blades, and endwalls; and a fluidically controlled turbine vane frame/exit guide vane. The implementation of the LPT into GE's and NASA's test facilities is described.

A description of NASA's Single Spool Turbine Facility that is currently under renovation is given. The new, upgraded facility is compared to its predecessor. Renovation design requirements are outlined. Facility limits on pressures, temperatures, flow rates, rotational speeds, and power absorption are described. The current renovation status is given.

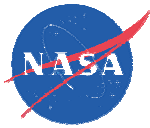

NASA/GE Highly-Loaded Turbine Research Program

**Fundamental Aeronautics
Subsonic Fixed Wing Project
Aerothermodynamics Discipline**

**Dr. Paul W. Giel, ASRC/RTT
NASA Glenn Research Center**

AIAA TETWoG Meeting – May 8-9, 2008

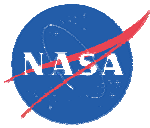

Highly-Loaded Turbine Research Objectives

- **Develop fundamental understanding and enabling technologies required for concepts such as ultra-high bypass engines, high power density cores, and embedded engines for hybrid wing vehicles.**
- **Dramatically improve engine thermal efficiency, reduce fuel burn and emissions, and reduce weight and complexity of turbine systems.**
- **Improve understanding through experimental and analytical aerodynamic studies of:**
 - high pressure turbines
 - low pressure turbines
 - HPT/LPT transition ducts
 - turbine component interactions

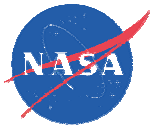

Highly Loaded Turbines; Specific Objectives

- Single stage high pressure ratio turbine (HPT)
 - 5.5 pressure ratio (engine)
 - 33% push in stage loading
 - Performance level 2 points better than current engines operating at the higher work level
 - Reduced stage count decreases weight and parts count.

- High work low pressure turbine (LPT)
 - Stage count reduction
 - Counter-rotation
 - Turbine Vane Frame (combined LPT Vane 1 & strut)
 - Low-solidity blading
 - C3/EWC optimized, highly loaded airfoils
 - Turbine Rear Frame (TRF) with fluidics

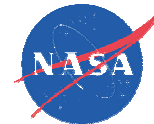

High Work Single Stage HPT Advancement

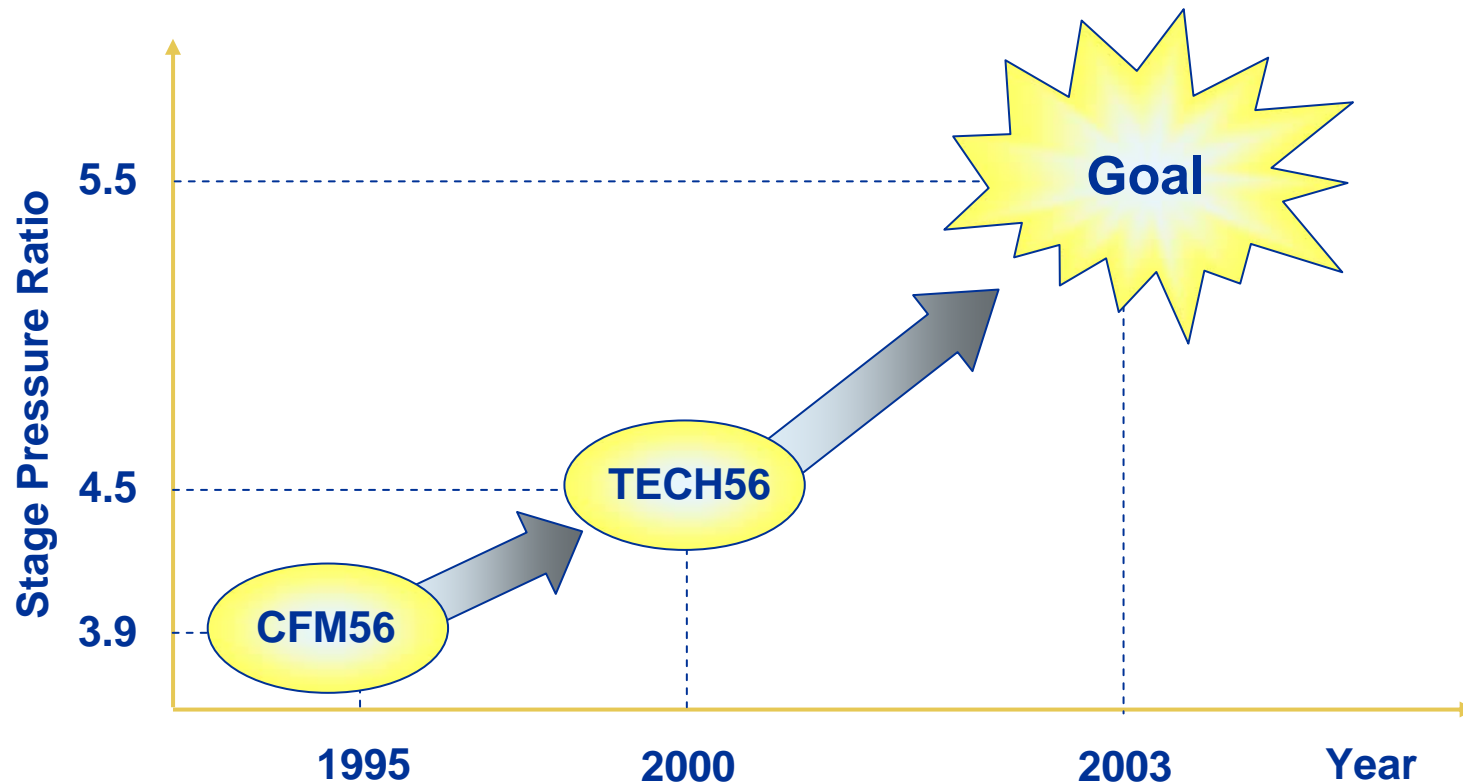

Advanced design concepts and tools enable dramatically higher pressure ratios

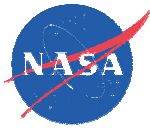

High Work HPT Advancement Strategy

1. Extensive CFD-based design and analysis
2. HPT subcomponent tests (2001)
 - HPT Vane full annular cascade
 - HPT Blade linear cascade
3. HPT stage aerodynamic design (2003)
4. HPT full scale rig design and procurement (2004)
5. Full scale rig test
 - Performance testing and preliminary unsteady at G.E. (2005)
 - Research testing at Glenn (2008)

Physics of Reduced Shock Blading

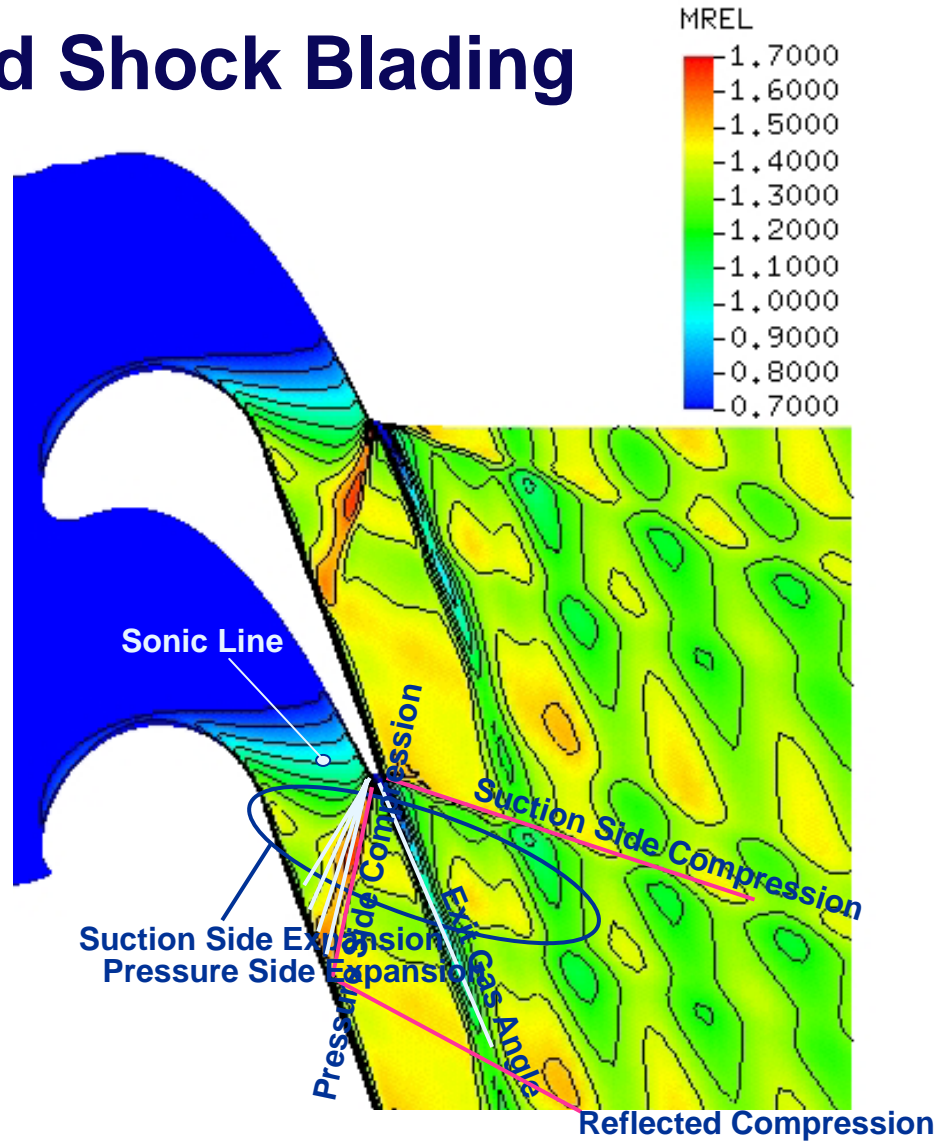

Reduced Shock Blade Design Parameters

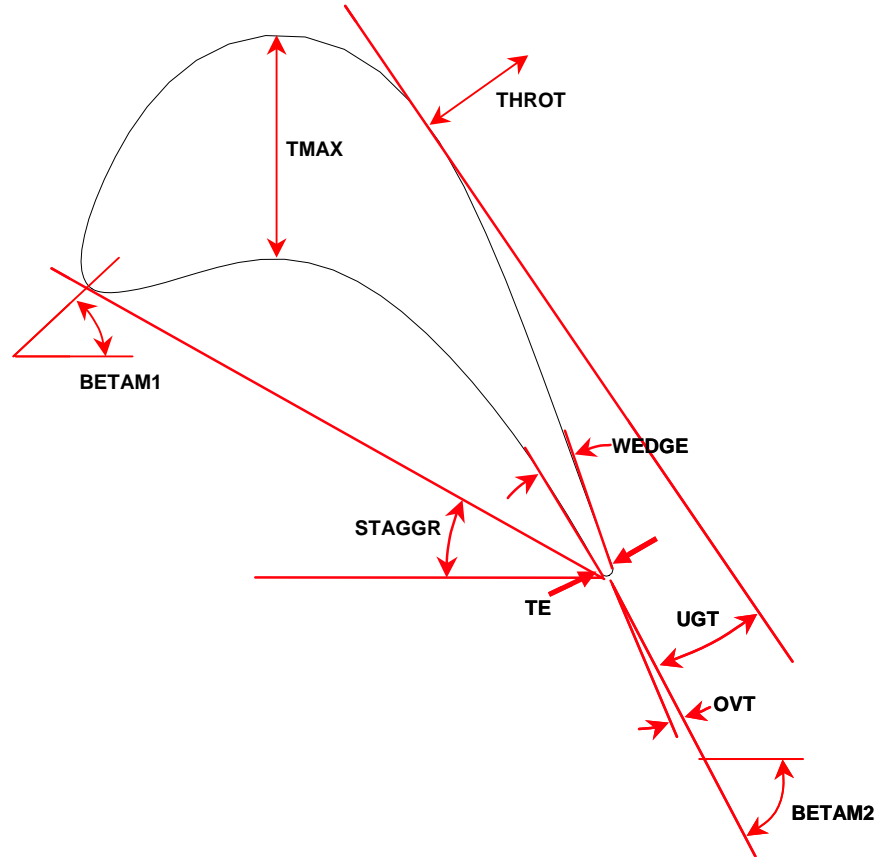

- **DOE: Stagger, UGT, OVT, wedge angle**
- **Convergent-Divergent throat passage**
- **Flat back blade shape with narrow trailing edge**
- **Final design balances aero, cooling, and mechanical reqts**

Reduced Shock Blade Design Results

Static Pressure - Pitchline ($PTR/PS = 3.25$)

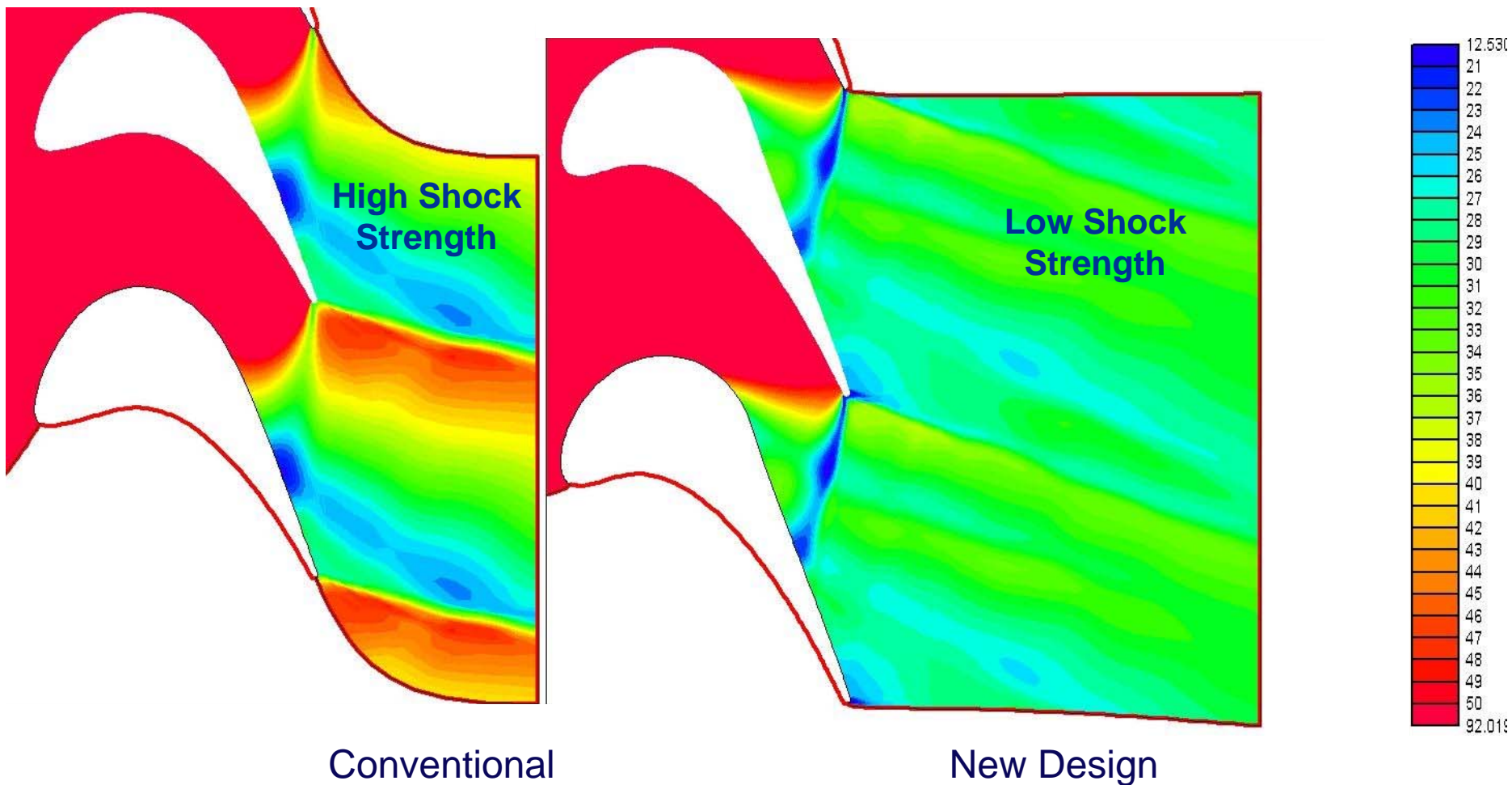

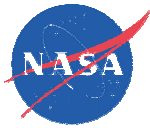

Single Spool Turbine Facility

This facility will provide the following research capabilities:

- **HPT / LPT Interaction losses up to LPT Vane 1**
- **Aggressive transition duct with integral vane/frame**
- **High lift blading**
- **Endwall contouring**
- **LPT with active / passive flow control**
- **Turbine Rear Frame (TRF) with flow control**
- **Reynolds number sensitivity reduction**
- **Ultra highly loaded HPT with 3-D blade design and reduced shock technologies**
- **New Instrumentation**
- **Clearance Control Technologies**
- **Core Noise Reduction; rotor/stator interactions, turbine acoustical transmission loss.**

50 - 80% of the HPT/LPT aero interaction could be captured with this facility

Previous W-6A Warm Core Turbine Facility

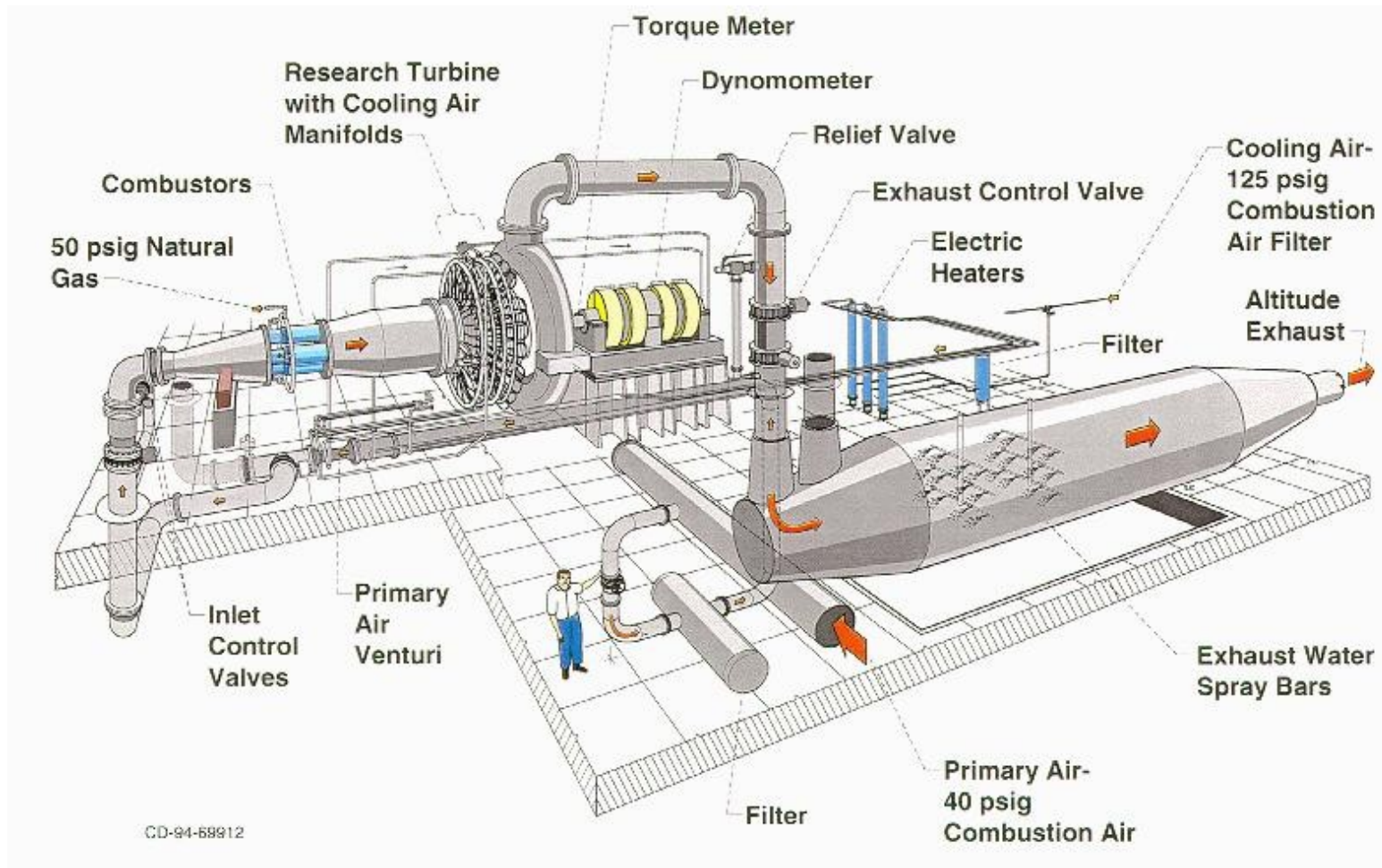

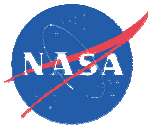

Single Spool Design Requirements

- **Improve the facility's operational reliability and ability to accurately set and measure test conditions:**
 - Replace the existing problematic dynamometer with Synchronous Machine (improve capability and reliability).
 - Provide more accurate flow measurement.
 - Provide more accurate torque measurement.
- **Provide the capability to test as wide a range of test articles/conditions as possible:**
 - Increase inlet flow rate and reduce exhaust pressure.
 - Examine ways to improve inlet air flow quality.
- **Provide the capability to test as wide a range of research topics as possible:**
 - Ensure that the existing capability of installing test articles of differing length is maintained.
 - Study ways to reduce test article change-out and access time.

New Single Spool Turbine Facility Layout

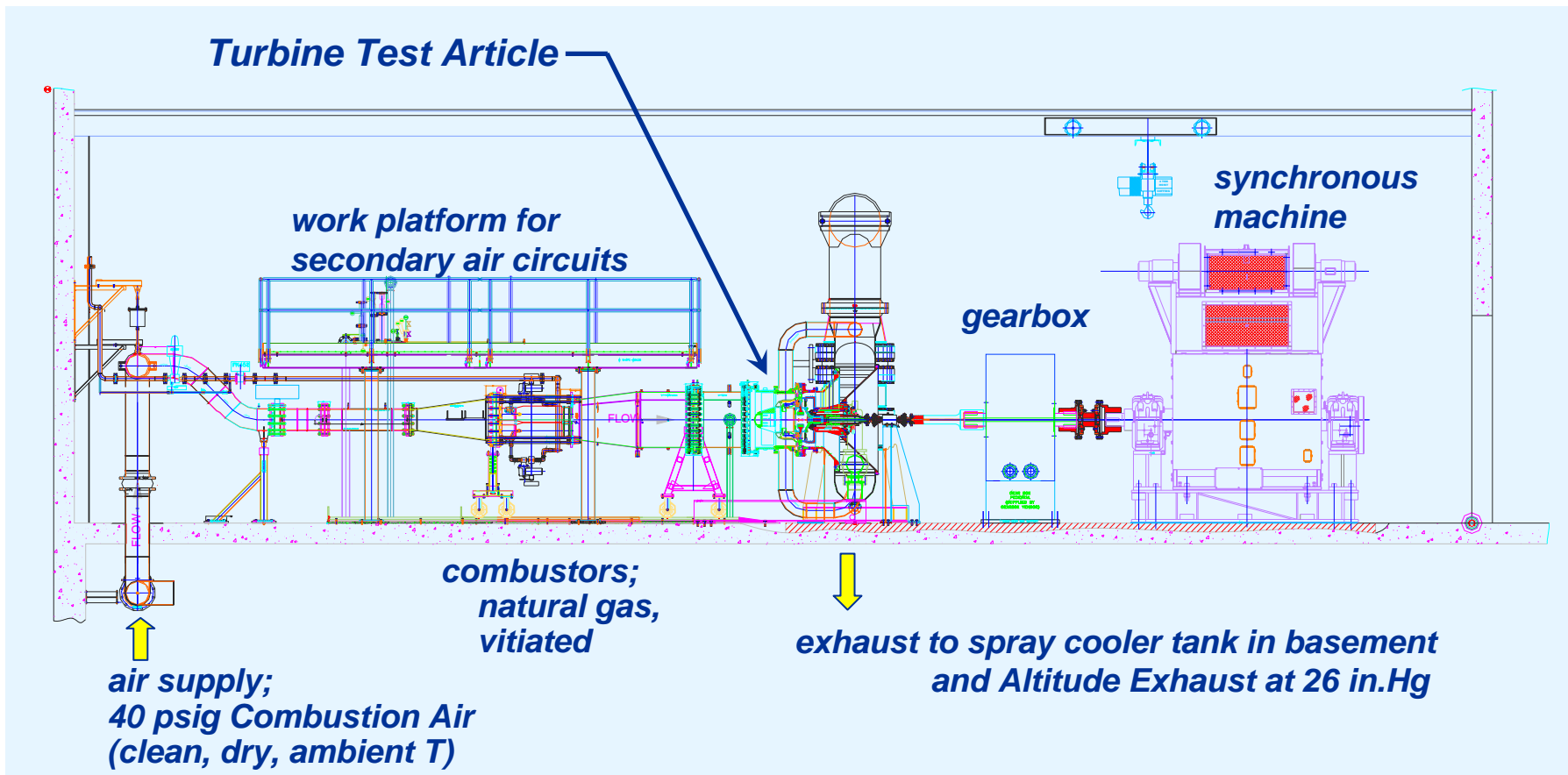

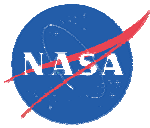

Facility Capabilities

- Maximum Turbine Inlet Air Pressure 50 psia
- Minimum Exhaust Pressure 2 psia
- Maximum Inlet Air Temperature 940°F
- Maximum Main Air Flow rate 27 pps
- Secondary Air (150 psig supply):
 - » 2 Legs – 1.5 pps each at 550°F
 - » 4 Legs – 0.08 to 1.19 pps at 250°F
 - » 6 Legs – at 70°F
- Maximum Turbine Rotational Speed 14,000 rpm
(with maximum Gear Ratio, G.R., of 7.78)
- Maximum Turbine Torque 36,217 ft·lb_f/G.R.
- Maximum Test Article Diameter 52 inch

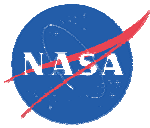

Current and Future Test Articles

- Two-stage E³ HPT.
- GE-UEET single-stage HPT:
 - ultra-high pressure ratio = 5.98 (rig corrected)
 - film-cooled for aero simulation only
 - GE completed performance testing
 - some steady and unsteady surveys
 - NASA owned
- GE-UEET single-stage HPT with t-duct and TVF
 - TVF design and fabrication complete
 - hardware delivered
- GE-UEET four-stage LPT:
 - aerodynamic engine design completed
 - detailed rig design completed
 - de-staged tests only (1+2 or 3+4+TRF)
 - flow control TRF design completed
 - endwall contouring throughout.

GE-UEET Single-Stage HPT

Goal/Purpose:

- To verify that relatively high efficiency can be maintained for a single stage turbine operating at an equivalent two stage work extraction level.
- To validate the reduced shock design concept at high stage pressure ratio.

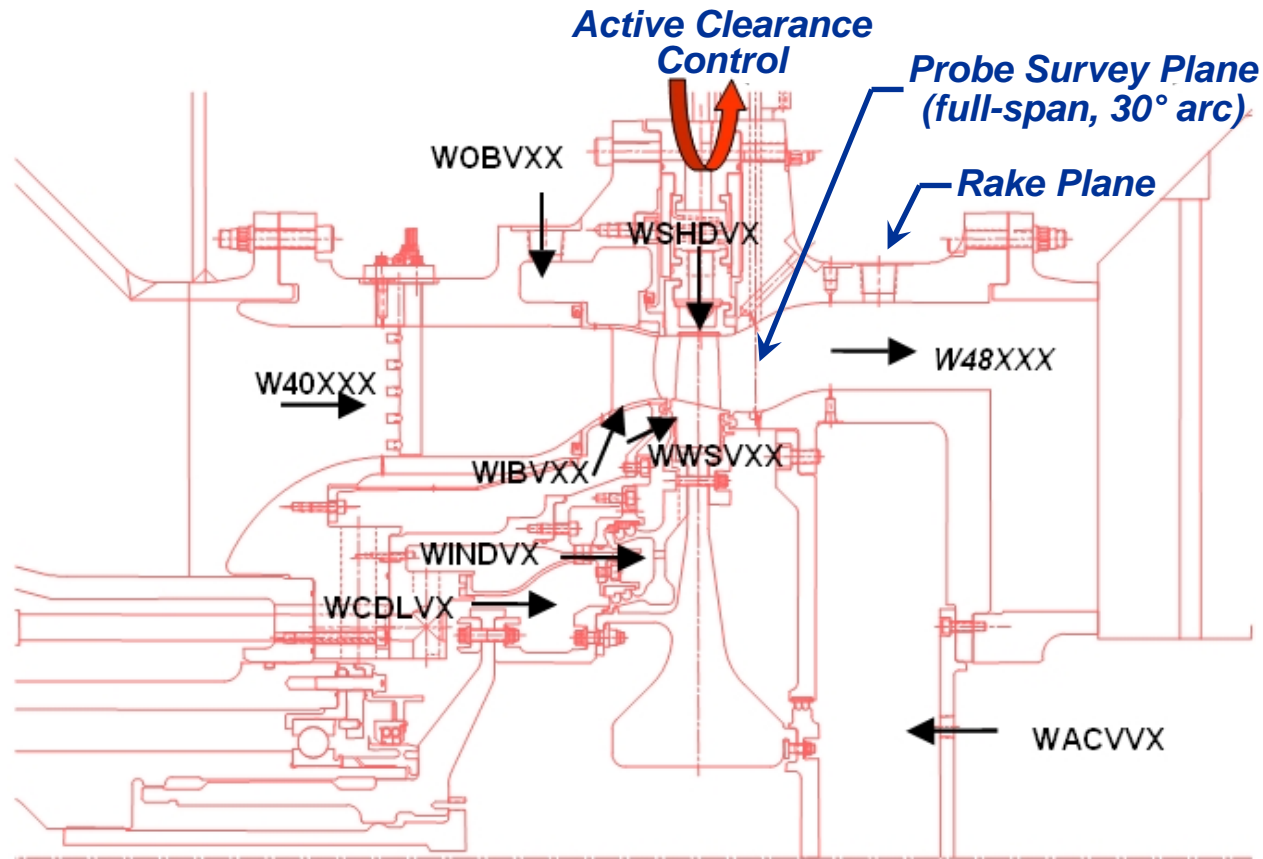

GE-UEET Single-Stage HPT with TVF

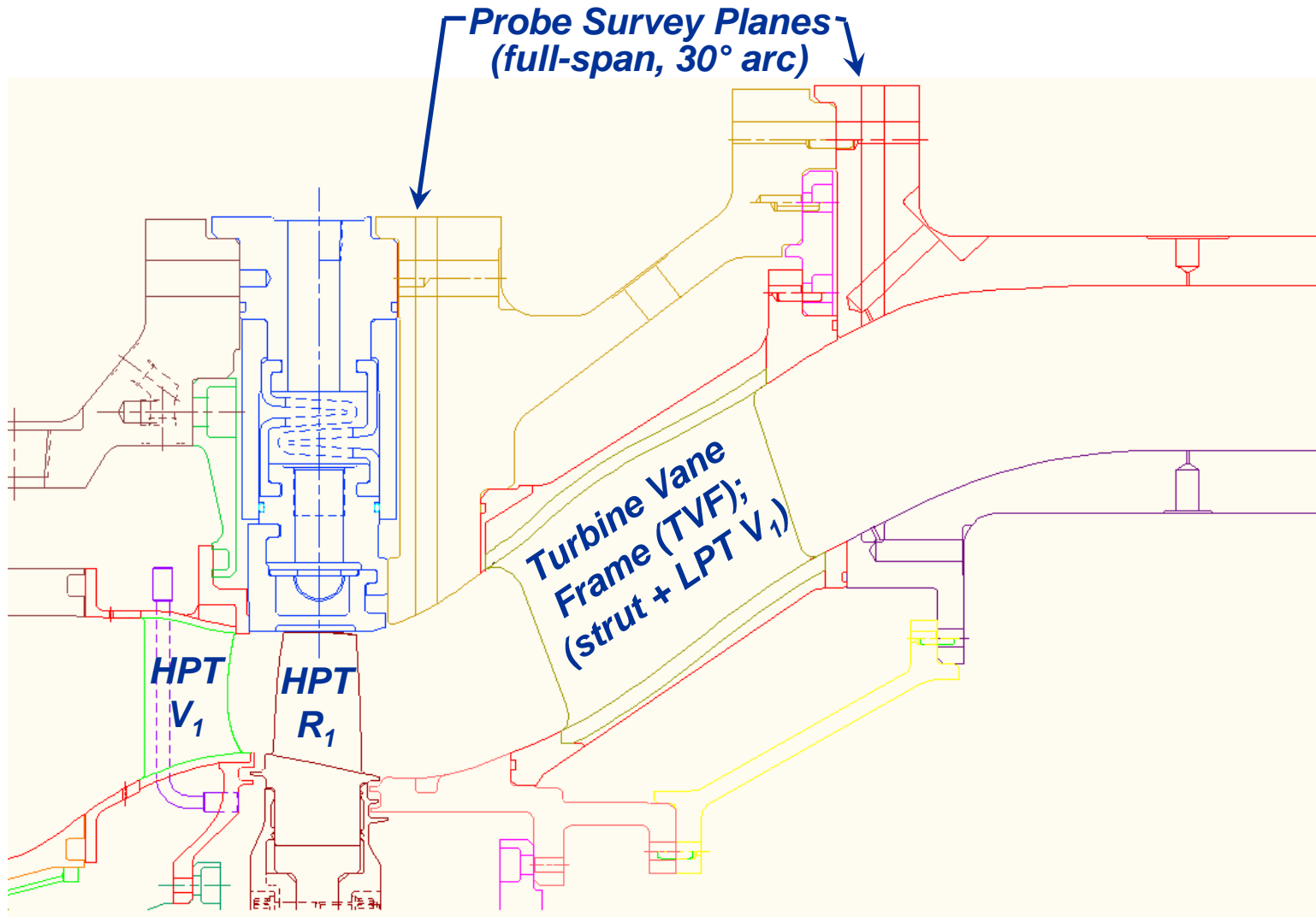

GE-UEET 4-Stage LPT

- Counter-rotation
- TVF (same as HPT)
- Low-solidity blading
- Fully optimized airfoils and passages with EWC
- TRF with fluidics; allows higher loading of aft stages; eliminates 5th stage
- Discrete passive fluidic jets on TRF

TVF with LPT stages 1 & 2; scale = 1.34

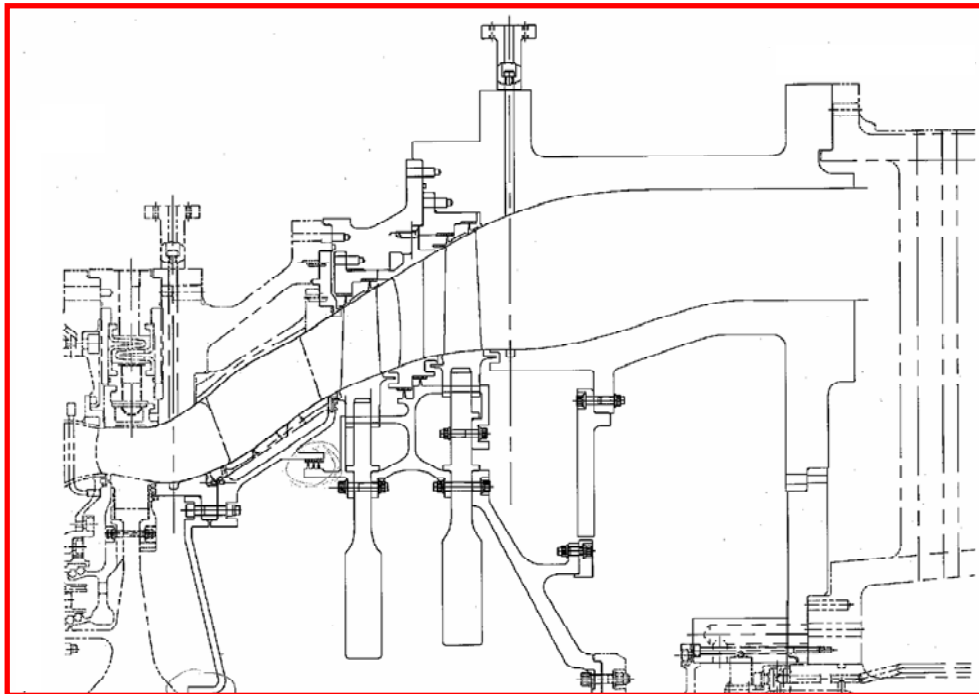

LPT stages 3 & 4 + TRF; scale = 1.00

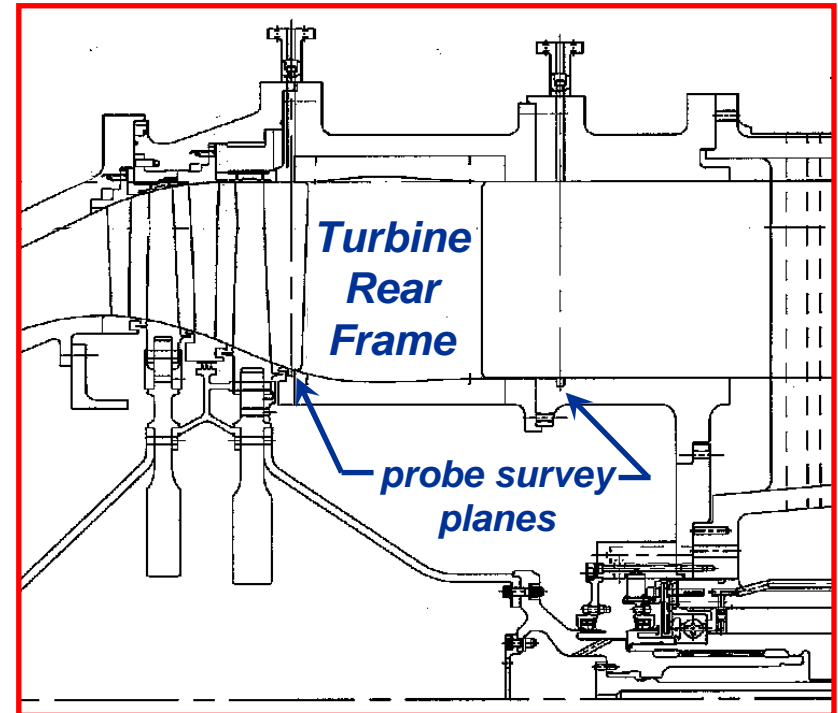

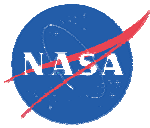

Facility Renovation Status

- Facility Design
 - 30% design review completed; then a one-year hiatus.
 - Work resumed ~April 1, 2006.
 - Much additional work due to pressure system certification requirements. Most recent focus has been on exhaust spray cooler, exhaust manifold, and combustor outlet.
 - Sync machine build underway, gearbox in procurement.
 - 60% design review in June 2008.
 - Checkout testing to start in FY09
- Test Cell Preparation
 - Additional cable/piping demolition completed.
 - Bedplate t-slot grout removed (with mercury remediation)
 - Low Voltage Electrical Panel relocated.
 - AC ducting relocated.
 - Crane rail extended.
 - High Voltage transformer relocated.
 - Spray cooler tank recertified; de-rated from 87.5 psig to 15 psig.