

# Development of a Temperature Sensor for Jet Engine and Space Mission Applications

Richard L. Patterson\*<sup>1</sup>, Ahmad Hammoud<sup>2</sup>, Malik Elbuluk<sup>3</sup>, Dennis Culley<sup>1</sup>

<sup>1</sup>NASA Glenn Research Center  
21000 Brookpark Road  
Cleveland, OH 44135 USA

\*Ph: 216-433-8166; Fax: 216-433-2221  
Email: [Richard.L.Patterson@nasa.gov](mailto:Richard.L.Patterson@nasa.gov)

<sup>2</sup>ASRC Aerospace Corporation  
NASA Glenn Research Center  
Cleveland, OH 44135 USA

<sup>3</sup>University of Akron  
Dept of Electrical & Computer Engineering  
Akron, OH 44325 USA

---

## Abstract

Electronics for Distributed Turbine Engine Control and Space Exploration Missions are expected to encounter extreme temperatures and wide thermal swings. In particular, circuits deployed in a jet engine compartment are likely to be exposed to temperatures well exceeding 150 °C. To meet this requirement, efforts exist at the NASA Glenn Research Center (GRC), in support of the Fundamental Aeronautics Program / Subsonic Fixed Wing Project, to develop temperature sensors geared for use in high temperature environments. The sensor and associated circuitry need to be located in the engine compartment under distributed control architecture to simplify system design, improve reliability, and ease signal multiplexing. Several circuits were designed using commercial-off-the-shelf as well as newly-developed components to perform temperature sensing at high temperatures. The temperature-sensing circuits will be described along with the results pertaining to their performance under extreme temperature.

## Key words

High temperature, temperature sensor, jet engine, space missions

---

## Extreme Temperature Electronics

Advanced electronic systems emphasize compactness, lightweight, increased energy density, reliability, and highly efficient operation. In addition, operation of these systems in hostile environments, where extreme temperatures are encountered, is anticipated in many applications. For example, jet engine distributed control architecture requires sensors and related circuitry to be co-located with actuators and transducers in the engine's hot zone where temperature can easily exceed +150 °C. Deep space probes destined to Venus and Mercury would also encounter high temperatures, and so would the electronics designed for use in the Navy's all-electric boat, and power-wire aircraft. At the other end of the spectrum, extreme

cold temperatures are also anticipated in space as well as aerospace applications. An interplanetary probe launched to explore the rings of Saturn would experience an average temperature of about -183 °C near Saturn, and electronics deployed near Pluto, for instance, would be exposed to temperatures as low as -229 °C. Also, systems designed for use behind the sun shield on the NASA James Webb Space Telescope will require the use of cryogenic detectors to capture weak distant signals. In addition to extreme temperature exposure, electronics in applications such as lunar surface exploration and earth-orbiting satellites are expected to be subjected to repeated thermal cycling covering a wide temperature range. The need for electronics capable of operation in extreme temperatures is not limited only to space ventures or military applications,

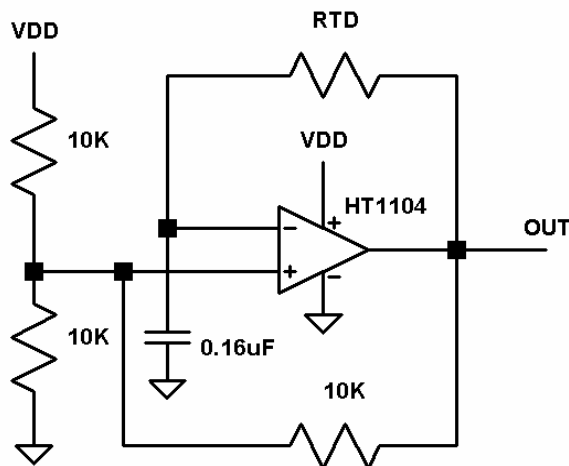
but it also encompasses many terrestrial industries. These include magnetic levitation transportation systems, power generation facilities, down-hole instrumentation for gas and oil exploration, automotive, medical imaging, particle acceleration and confinement, and Arctic and Antarctic exploratory missions. Besides meeting the environment operational conditions, electronics that are able to tolerate and operate efficiently in extreme temperatures will negate the need for the traditional thermal control elements and their associated structures for proper ambient operation. This, in turn, would lead to many other benefits including decreased overall system mass and size, simplified design, and reduced power requirements. In addition, reduced development time and launch costs of space-based systems, as well as extended mission operations for longer exploration time can be achieved. Therefore, it is highly desirable and vital to have electronic systems capable of withstanding and operating reliably in hostile temperature environments.

## Temperature Sensor

Efforts were carried out to develop and evaluate a temperature sensor for the NASA Jet Engine Distributed Control Program. The distributed control architecture requires that sensors and associated electronics be co-located with monitoring and control transducers for engines and actuators in very hot environments. In addition to meeting the operational requirements, placement of the electronics in the harsh engine compartment allows simpler signal multiplexing, improves system performance, and avoids or minimizes signal degradation. The combination of GRC high temperature development work for Jet Engine Distributed Control and GRC low temperature reliability work for the NASA Electronic Parts and Packaging (NEPP) Program has yielded a new technical approach for very wide temperature electronics design and fabrication wherein circuits can operate between -195 °C and +200 °C. In addition, there are technical reasons to believe that operating temperatures may be extended below -195 °C and above +200 °C.

The sensor was designed to sense temperature and to produce a digital output consisting of a stream of rectangular pulses whose frequency is a function of the sensed temperature. The output frequency will be fed into a digital data acquisition system that will give a direct readout of the temperature through the use of a look-up table, a built-in algorithm, or a mathematical model. In order to develop this sensor circuitry, a literature survey was performed to determine the simplest and most efficient circuit configuration that could be utilized as a temperature-to-frequency conversion sensor in extreme temperature applications. A search for commercial-off-the-shelf (COTS) electronic parts that could be utilized at extreme

temperatures was also performed. A relaxation oscillator topology was selected to build the temperature-to-frequency circuit using an RTD (Resistance Temperature Detector) as the temperature-sensing element. A schematic of the circuit is shown in Fig. 1, and the selected COTS parts are listed in Table I.



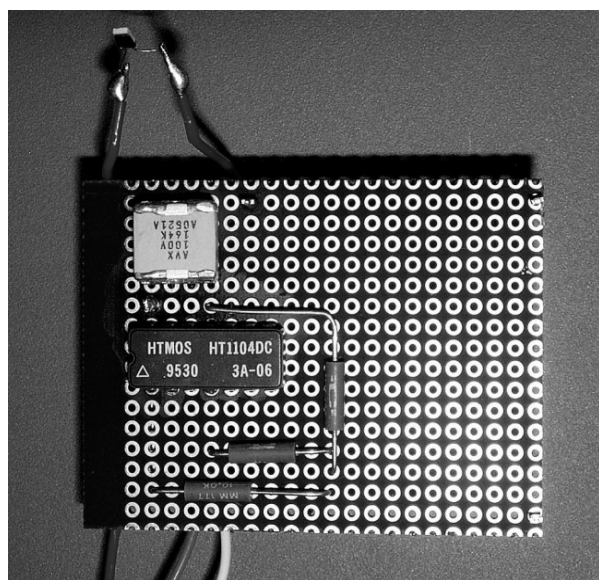
**Fig. 1. Schematic of the temperature-to-frequency relaxation oscillator circuit.**

**Table I.  
Parts used in construction of  
the temperature sensor circuit.**

Part / Company	Specification Temp (°C)	Features
Operational amplifier / Honeywell	-55 to +225	SOI technology, hermetic ceramic DIP package
RTD / U.S. Sensor	-50 to +500	Thin film platinum, ceramic package
Capacitor / AVX	-55 to +125	MLC NPO ceramic
Resistor / Caddock	+275	High temperature precision film resistor

The temperature-to-frequency relaxation oscillator circuit was assembled using a high temperature polyimide board, Teflon-insulated wire interconnects, and high temperature lead-free solder. The circuit employed a Honeywell high temperature Silicon-On-Insulator (SOI) operational amplifier HT1104. This device is fabricated with Honeywell's dielectrically isolated high-temperature linear HTMOS process, is specified for -55 °C to +225°C operation, and is able to perform up to +300 °C[1]. It is a 14-lead, monolithic amplifier in a hermetic ceramic package, and can handle 15 mA output current with a single

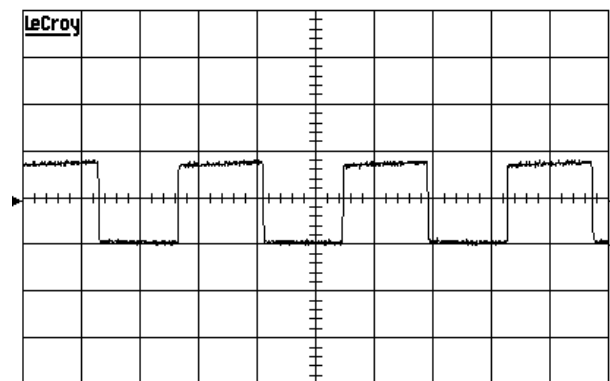
or split supply. A high temperature precision, thin film platinum RTD (Resistance Temperature Detector) [2] was selected as the temperature-sensing element, while the other passive elements consisted of a multi-layer ceramic (MLC) capacitor [3] and three high temperature, precision film resistors [4]. For this work, the sensing RTD and the relaxation oscillator were all grouped together as a unit, and the unit was placed into a temperature controlled chamber. The circuit was evaluated at selected test temperatures between  $-195\text{ }^{\circ}\text{C}$  and  $+200\text{ }^{\circ}\text{C}$ . A temperature rate of change of  $10\text{ }^{\circ}\text{C}/\text{min}$  and a dwell time of 20 minutes at test temperature were used in these investigations. Circuit evaluation was performed by measuring output frequency as a function of temperature, variation in the output signal duty cycle and rise time, and the circuit supply current. The range of the output frequency of the circuit was determined by the values of the passive components used. A photograph of the actual circuit board is shown in Fig. 2.



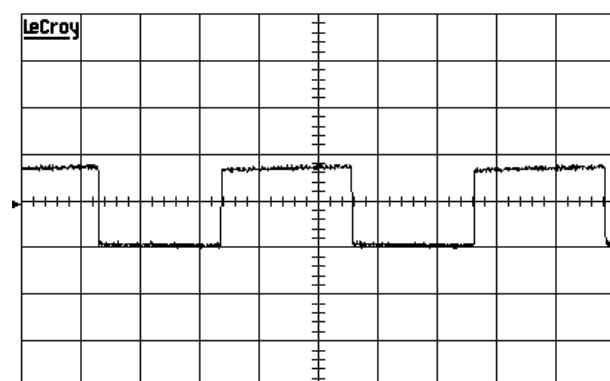
**Fig. 2.** Temperature-to-frequency relaxation oscillator circuit board.

## Results

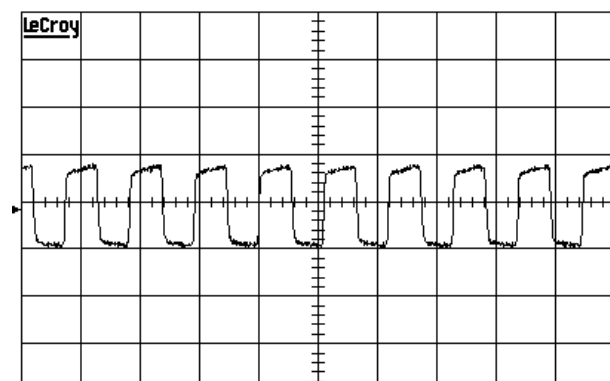
A typical output response of the temperature-to-frequency conversion circuit, which comprised of a digital pulse train, is shown in Fig. 3 at  $25\text{ }^{\circ}\text{C}$ . Those obtained at the high temperature of  $+200\text{ }^{\circ}\text{C}$  and at the cryogenic temperature of  $-195\text{ }^{\circ}\text{C}$  are shown in Fig. 4 and 5, respectively.



**Fig. 3.** Output waveform of temperature-to-frequency circuit at  $25\text{ }^{\circ}\text{C}$ . Vert=5V/div; Horiz=0.1ms/div



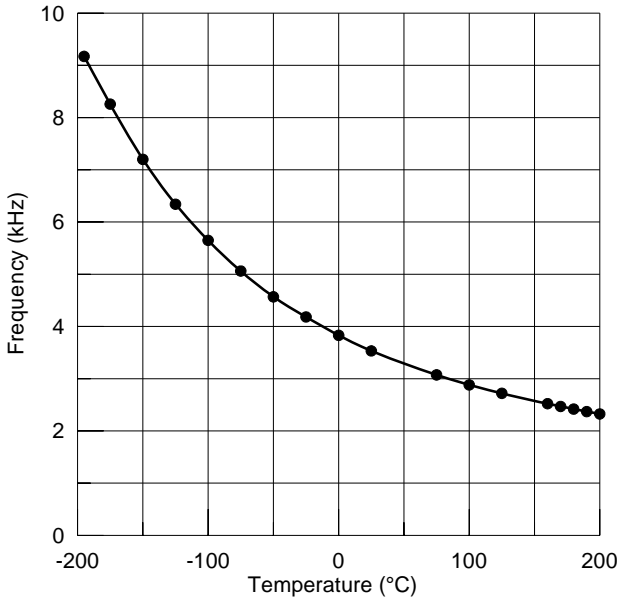
**Fig. 4.** Output waveform of temperature-to-frequency circuit at  $+200\text{ }^{\circ}\text{C}$ . Vert=5V/div; Horiz=0.1ms/div



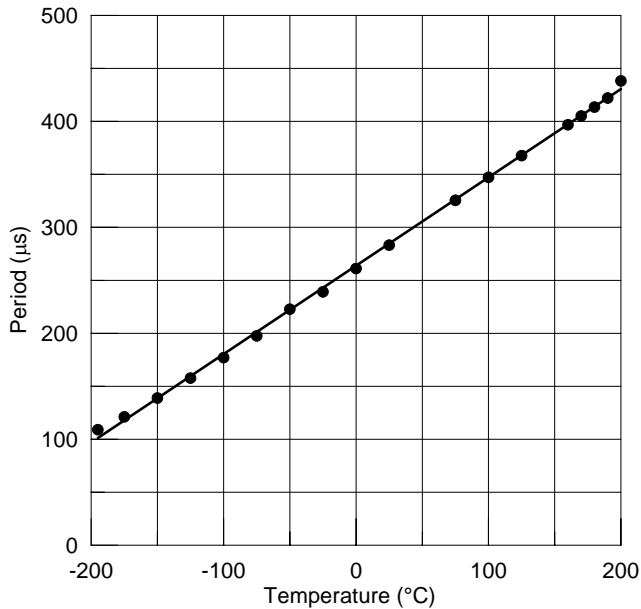
**Fig. 5.** Output waveform of temperature-to-frequency circuit at  $-195\text{ }^{\circ}\text{C}$ . Vert=5V/div; Horiz=0.1ms/div

The circuit performed very well throughout the test temperature range between  $+200\text{ }^{\circ}\text{C}$  and  $-195\text{ }^{\circ}\text{C}$ . As expected, the frequency of the output signal fluctuated with variation in the sensed temperature; with a frequency of about  $9.2\text{ kHz}$  at a test temperature of  $-195\text{ }^{\circ}\text{C}$  and a frequency of  $2.3\text{ kHz}$  at  $+200\text{ }^{\circ}\text{C}$ . This frequency response with temperature is depicted in Fig. 6. The period for the pulse train is shown in Fig. 7. A linear curve-fit has been

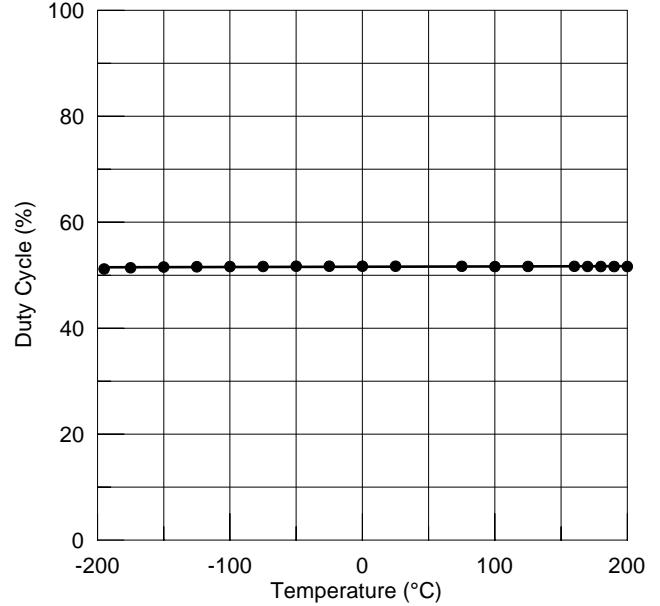
placed over the data points. For the linear curve-fit, the R squared was 0.9994. No major change was experienced by the duty cycle of the output signal as shown in Fig. 8.



**Fig. 6. Output frequency versus temperature.**

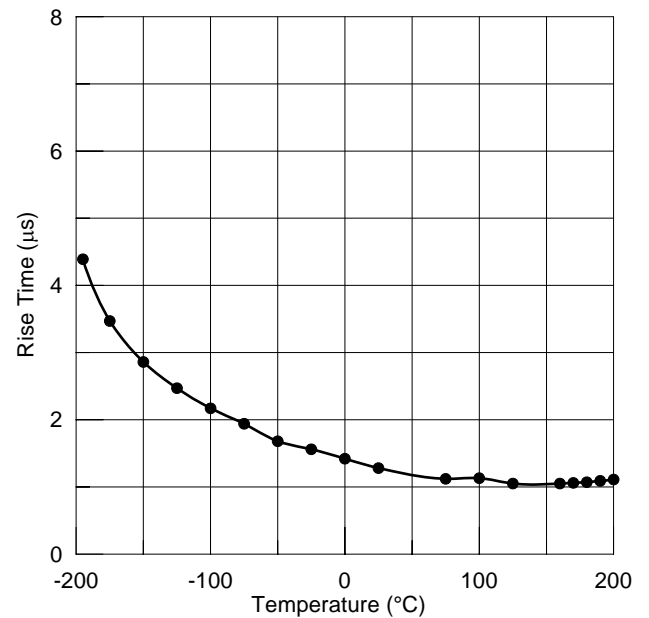


**Fig. 7. Pulse train period versus temperature.**

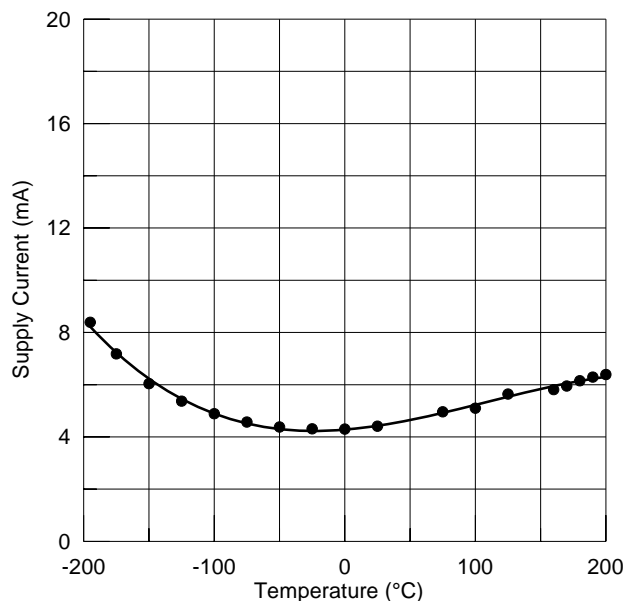


**Fig. 8. Duty cycle of output signal as a function of temperature.**

While the rise time of the output signal held steady value between 25 °C and +200 °C, it did, however, undergo a very slight increase as the temperature was decreased below room temperature, as shown in Fig. 9. The rise time increased from a value of 1.3 µs at 25 °C to a value of 4.2 µs at -195 °C. The supply current of the circuit remained between 4 to 8 mA throughout these tests. Fig. 10 shows supply current as a function of temperature.



**Fig. 9. Rise time of output signal versus temperature.**



**Fig. 10. Circuit supply current as a function of temperature.**

## Conclusions

A temperature-to-frequency relaxation oscillator circuit was constructed using COTS parts for application under extreme temperatures. The circuit employed a high temperature SOI operational amplifier, a thin-film platinum RTD, NPO multi-layer ceramic capacitors, and precision film resistors. Although the circuit was designed mainly for a hot jet engine environment, it was evaluated also for potential use under cryogenic conditions. Performance of the oscillator circuit was investigated in terms of its frequency response, pulse train period, variation in output signal duty cycle and rise time, and supply current under a wide temperature range between -195 °C and +200 °C. The prototype circuit performed well throughout this temperature range in producing a pulse train whose period was proportional to the sensed temperature, and no major

changes were observed in its characteristics, i.e. duty cycle and rise time of the output signal, as a result of change in test temperature. In addition, all of the individual parts exhibited no physical or packaging damage due to the extreme temperature exposure. It can be concluded, therefore, that all the COTS parts used in designing the circuit exhibited good performance under wide temperature swing, and these preliminary results suggest that the circuit has good potential for use in both hot and cold temperature environments. Issues such as long-term exposure to extreme temperatures, thermal cycling, and mechanical vibrations; that are typically encountered in jet engine environs, need to be addressed to establish reliability of the circuit and to better determine its suitability for use in hostile space and aerospace applications. Future work will address development of a sensor for higher temperature measurement in which the sensing RTD can be placed in hotter environments and processing electronics can be placed in cooler environments very near the sensing RTD.

## Acknowledgment

This work was partially performed under the NASA Glenn Research Center, GESS-2 Contract # NNC06BA07B. Support was provided by the NASA Fundamental Aeronautics Program / Subsonic Fixed Wing Project / Distributed Engine Control Task and by the NASA Electronic Parts and Packaging (NEPP) Program.

## References

- [1] Honeywell Company, "High Temperature Quad Operational Amplifier HT1104", Datasheet 900134 Rev. B, 9-03.
- [2] U.S. Sensor, "Thin Film Platinum RTD's", Data Sheet.
- [3] AVX Corp., "SMPS Stacked MLC Capacitors", Data Sheet.
- [4] Caddock Electronics, Inc. "Type MM and ML Precision Film Resistors", Data Sheet 28-IL124.1004.