

Similarity Metrics for Closed Loop Dynamic Systems

Mark S. Whorton
NASA Marshall Space Flight Center
Huntsville, AL 35812

Lee Yang, Naz Bedrossian, and Rob Hall
The Charles Stark Draper Laboratory
Cambridge, MA

Abstract

TBD

1. Introduction

To what extent and in what ways can two closed-loop dynamic systems be said to be “similar?” This question arises in a wide range of dynamic systems modeling and control system design applications. For example, bounds on error models are fundamental to the controller optimization with modern control design methods. Metrics such as the structured singular value are direct measures of the degree to which properties such as stability or performance are maintained in the presence of specified uncertainties or variations in the plant model. Similarly, controls-related areas such as system identification, model reduction, and experimental model validation employ measures of similarity between multiple realizations of a dynamic system. Each area has its tools and approaches, with each tool more or less suited for one application or the other.

Similarity in the context of closed-loop model validation via flight test is subtly different from error measures in the typical controls oriented application. Whereas similarity in a robust control context relates to plant variation and the attendant affect on stability and performance, in this context similarity metrics are sought that assess the relevance of a dynamic system test for the purpose of validating the stability and performance of a “similar” dynamic system. Similarity in the context of system identification is much more relevant than are robust control analogies in that errors between one dynamic system (the test article) and another (the nominal “design” model) are sought for the purpose of bounding the validity of a model for control design and analysis. Yet system identification typically involves open-loop plant models which are independent of the control system (with the exception of limited developments in closed-loop system identification which is nonetheless focused on obtaining open-loop plant models from closed-loop data). Moreover the objectives of system identification are not the same as a flight test and hence system identification error metrics are not directly relevant. In applications such as launch vehicles where the open loop plant is unstable it is similarity of the closed-loop system dynamics of a flight test that are relevant.

The issue at hand differs from standard control system robustness measures in that one is typically concerned with the degree to which properties of a particular control system

(closed-loop stability and performance) are maintained in the presence of uncertainties or variations in the plant. In this context, the question is to what degree and in what ways do a test vehicle and the operational vehicle have to be similar in order to form relevant conclusions for a flight test. In what ways are two closed-loop dynamic systems said to be “similar” such that flight test data from one is relevant for assessing stability and performance of the other? How can we slice the orange to draw inferences about the apple? To address these questions, this study focuses on developing and evaluating similarity metrics for closed-loop model validation, seeking to determine appropriate candidate similarity metrics which can be used to qualitatively assess the degree to which and ways in which two closed-loop dynamic systems can be said to be similar.

A. Respect the Unstable

It should be generally understood that there is a considerable inherent risk in the control of any unstable flight vehicle. This point was very well made by Dr. Gunter Stein in the first Hendrik W. Bode Lecture at the 1989 IEEE Conference on Decision and Control, notably entitled “*Respect the Unstable*” (featured in the IEEE Control Systems Magazine, August 2003, pp. 12-25). His point was that *unstable* is synonymous with *dangerous*, and that 1) unstable systems are fundamentally more difficult to control, 2) controllers are essential to the operation of unstable systems, and 3) closed-loop stability is a local property when the open loop system is unstable. Launch vehicles (especially those without aerodynamic fins) are inherently unstable during atmospheric flight due to the center of pressure being located forward of the center of mass.

Moreover the challenge of flight control system (FCS) design for flexible launch vehicles is compounded by to the potential for interaction between the FCS and structural vibration modes. Early configurations of the NASA Ares I Launch Vehicle (known as the Crew Launch Vehicle, or CLV at that time) indicated a potential for more significant control-structure interaction than had been the experience with previous launch vehicles (cite NESC report here). Analysis of more mature vehicle configurations has shown the potential for control-structure interaction to be considerably less than initial assessments, and while the Ares I ascent FCS design is well within the experience base and family of previous launch vehicle FCS designs, nonetheless the task of controlling the unstable, flexible Ares I launch vehicle remains challenging. The first flight test of the Ares I launch vehicle will be the Ares I-X Flight Test Vehicle, currently scheduled for launch in April 2009.

B. Closed-Loop Flight Control Validation

Ensuring a safe and robust flight control system design entails high fidelity modeling and test validation. For example, wind tunnel testing combined with analytical modeling leads to validated aerodynamic coefficients and models. Likewise vibration testing at the component and system level combined with structural analysis modeling leads to validated structural dynamics models. These test validated models are implemented along with flight control system models in high fidelity integrated vehicle models and simulations for stability and performance analysis.

Being unstable systems, launch vehicle stability and performance must be tested in closed-loop with relevant environments. Motivated by an awareness of the challenges of controlling an unstable, flexible launch vehicle, the number one “Primary Flight Test Objective” (P1) for the Ares I-X Flight Test is to “Demonstrate control of a dynamically similar, integrated CLV/CEV, using CLV ascent control algorithms” (CEV = Crew Exploration Vehicle) (Reference “System Requirements Document for the Ares I-X Flight Test Vehicle”, NASA Document AII-SYS-SRD-VER 3.03, pg. 10, March 14, 2007). This begs the question: exactly how similar do an operational vehicle and a test vehicle (and the associated flight test conditions) have to be in order to validate a flight control system design for the operational vehicle?

Prior to identifying and assessing candidate similarity metrics for dynamic systems in general and launch vehicles in particular, a brief tutorial review of relevant control theory will be presented to provide context and illuminate how similarity can be measured in closed loop systems.

2. Insights from Control Theory Fundamentals

A closed-loop dynamic system can be characterized by five fundamental elements:

1. Vehicle environment (the “plant input” or “forcing functions”, e.g. aerodynamic forces and moments and wind gusts).
2. Vehicle dynamics (the “plant,” e.g. mass properties and structural dynamics)
3. Flight Control System
4. Closed Loop Performance (the “plant output,” e.g. time response and frequency response)
5. Stability Margins (e.g. gain and phase margins or μ measures)

True equivalence between two dynamic systems would require an exact correspondence with regard to each of these five elements. In practice this is seldom if ever achieved.

Ideally a flight test vehicle will be essentially identical to the operational flight vehicle so that the “actual” vehicle dynamics will be tested. In actuality however, schedule demands often require flight test vehicle designs to be fixed before the operational vehicle design has matured and been finalized. The long lead time associated with issues such as fabrication, procurements, and software development for flight tests result in significant discrepancies in the vehicle dynamics of the flight test vehicle and the operational vehicle. Likewise it is often not possible to exactly replicate the operational environment in a flight test. Relevance of a vehicle environment levies flight test requirements on vehicle structural dynamics and mass properties, ascent trajectory, thrust profile, ground winds, gusts, temperatures and numerous other parameters necessary to ensure that the vehicle environment is relevant throughout the flight envelope.

The flight control system affords better opportunities for close correspondence between two closed-loop dynamic systems. Flight control systems are typically comprised of an avionics suite (e.g. sensors, effectors, control electronics), a control system “architecture” (e.g. PID, H_∞), and a particular set of control system parameters and coefficients. A good

argument can be made that a relevant flight test must at a minimum implement a similar avionics suite and architecture, while the control system parameters themselves may be modified to accommodate differences in the vehicle dynamics, flight test objectives, or environment.

Given discrepancies in two dynamic systems, there may be multiple similarity metrics of relevance, each describing a different phenomenon or attribute that is important for control systems validation. Much like similarity in fluid mechanics where Reynolds number describes laminar/turbulent flow, Mach number describes compressibility effects, and Froude number describes gravitational effects on flow, there are many different types of issues that are important to the dynamics of a controlled system. If two systems are very different (e.g. different plant, environment, or controller), it would not be expected that all the metrics will be similar between systems. What is important is to determine the extent of the differences and the associated implications for validation.

How then is one to assess the relevance of a flight test with respect to validating the stability and performance of the operational vehicle flight control system design? Several candidate similarity metrics can be suggested from control theoretic principles by which the validation of the flight control system can be assessed and quantified

A. Component Response of Linear Systems

Control systems are analyzed both in the time domain and the frequency domain, and as illustrated in Figure C, for second order systems there are fundamental relations between the different domains. Time domain analysis typically involves measures such as rise time, settling time, and percent overshoot which can be related to frequency domain measures such as damping ratios, ζ , and natural frequencies ω_n . In the Laplace domain, closed-loop pole locations determine the damping ratios and frequencies, both of which can be used to assess relative stability and time response characteristics.

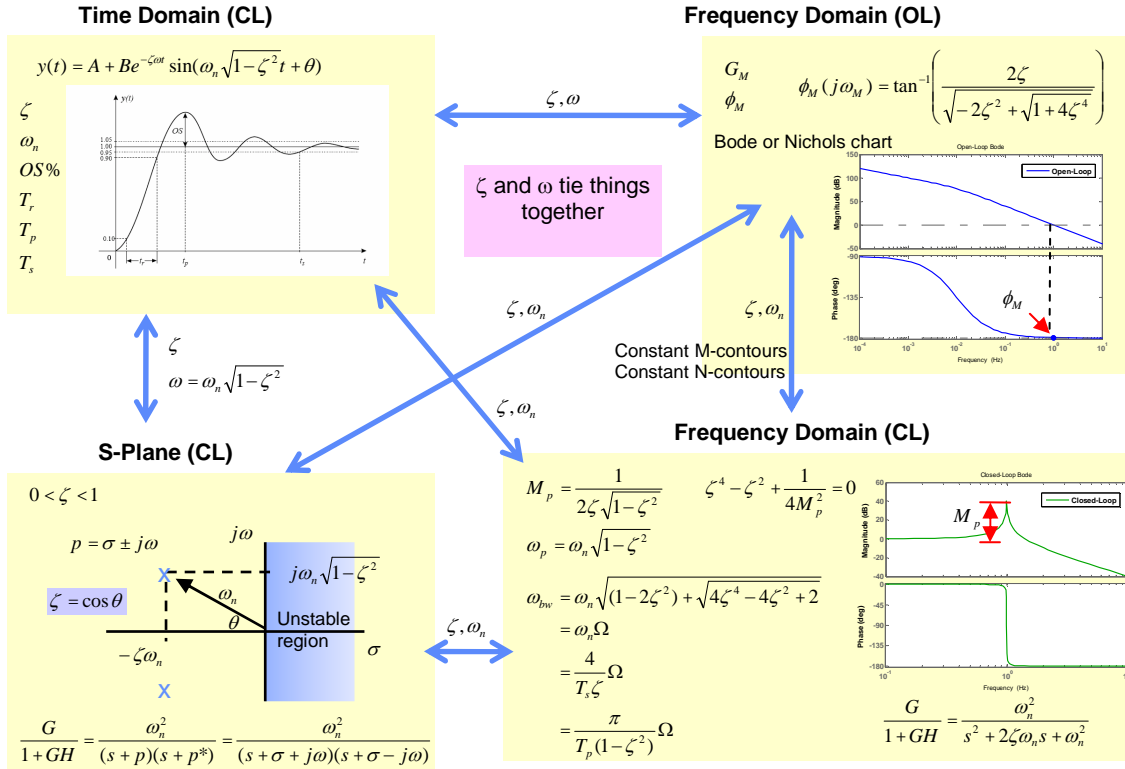

Figure C: Measures of Relative Stability

Damping ratios are particularly insightful measures of a second order system stability since the sign indicates absolute stability or instability and the value determines if the time response behavior is oscillatory or not. A closed loop system will be stable only for $\zeta > 0$ the system will tend toward instability as ζ or $\zeta\omega_n$ approach zero.

Insight into higher order systems can be gleaned from realizing the system as a superposition of first or second order systems. Consider a system where $Y(s)$ is the output response, $P(s)$ is the closed-loop transfer function and $R(s)$ is a step input:

$$\begin{aligned} Y(s) &= P(s)R(s) \\ &= P(s) \cdot \frac{1}{s} \\ &= \frac{1}{s} \cdot \frac{a_m s^m + a_{m-1} s^{m-1} + \dots + a_0}{b_n s^n + b_{n-1} s^{n-1} + \dots + b_0} = \frac{(s+z_1)(s+z_2)\dots(s+z_m)}{s(s+p_1)(s+p_2)\dots(s+p_n)} \end{aligned} \quad (1)$$

The system response can be written as a partial fraction expansion as

$$Y(s) = \frac{1}{s} + \sum_i \frac{C_i}{s + \alpha_i} + \sum_j \frac{D_j s + E_j}{s^2 + 2\zeta_j \omega_j s + \omega_j^2} \quad (2)$$

where the first term is the particular solution or forced response, while the other terms comprise the homogeneous solution or natural response. The second term includes the real poles which indicate either exponential decay ($\alpha_i > 0$) or growth ($\alpha_i < 0$). The third term is a summation of second order “modes” comprised of complex poles with $0 < \zeta < 1$ representing the damped oscillatory response. The closed-loop damping ratio associated with each closed loop pole pair is a measure of relative stability localized near the associated natural frequency and thus is a good metric for assessing similarity of two dynamic systems with respect to particular modes of response that are common to both systems. Using inverse Laplace transformation, the time domain response can be shown as a linear superposition of the individual component responses. This suggests the possibility of using individual similarity metrics for each of the component contributions.

$$y(t) = 1 + \sum_i C_i e^{-\alpha_i t} + \sum_j F_j e^{-\zeta_j \omega_j t} \sin(\omega_j \sqrt{1 - \zeta_j^2} t + \theta_j) \quad (3)$$

The closed loop zeros (and poles) determine the weighting (C_i and F_j) of the individual effects as well as the phase shift (θ_j) for the oscillatory terms. Gain and phase margins provide additional standard metrics for control system analysis with single-input/single-output linear time invariant systems. While closed-loop damping ratios are metrics relative to a particular mode, gain margins are system metrics that generally depend on where the loop is broken. Also as dictated by root locus rules, ζ alone does not dictate the gain necessary to move the associated closed-loop pole to the $j\omega$ -axis. As illustrated in Figure D, that gain margin is dependent on other poles and zeros of the system

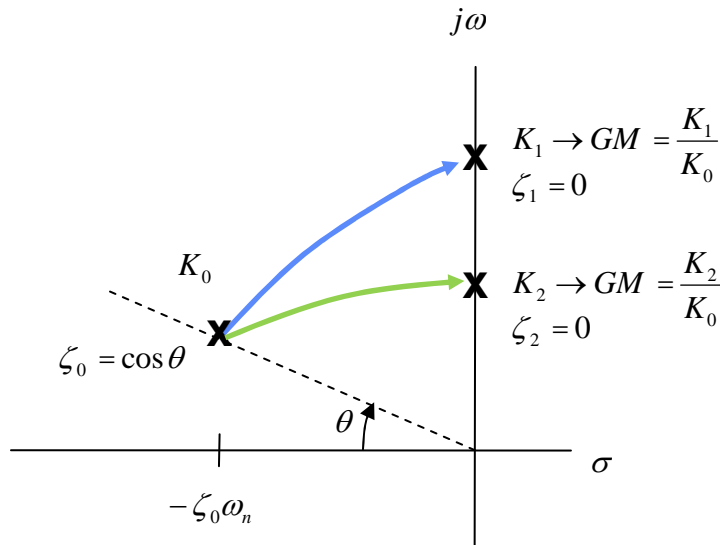

Figure D. Relation between closed-loop damping and gain margin

B. Dynamic Similarity of Two Systems

Consider for example a baseline model for the rotational dynamics of a launch vehicle with one flexible mode, and a PID controller as shown in Figure E

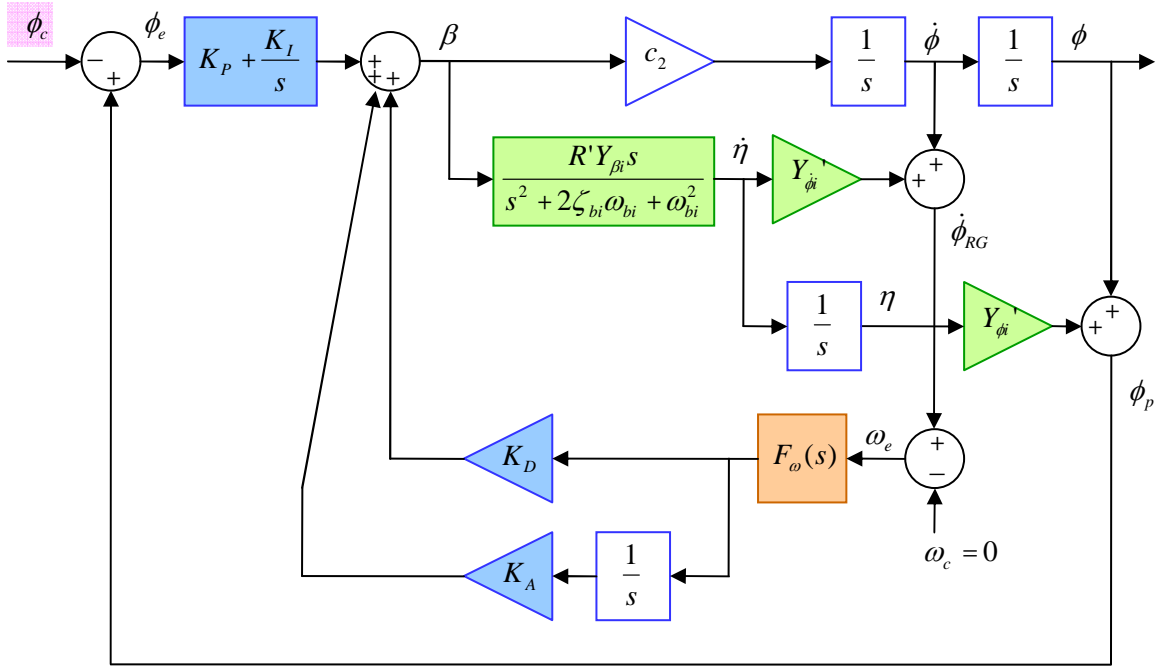

Figure E. Closed Loop Launch Vehicle Model

To provide additional stability robustness for the non-minimum phase flexible mode, an attitude blending channel is added to the PID channels with the gain K_A multiplying the integrated rate measurement from an additional rate gyro. F_ω is a 4th order Butterworth low-pass rate filter with a 1 Hz break frequency which essentially adds 180 degrees of phase to stabilize the flexible mode. Now from this baseline system denoted P_1 , consider a second “related” closed-loop system, denoted P_2 , where the bending mode frequency $\omega_2 = 1.5 * \omega_1$, the integral gain $K_{I,2} = 0.1 * K_{I,1}$, and the filter (denoted C_2 below) break frequency is shifted by a factor of 1.5 to be consistent with the shift in the bending mode frequency. These two related systems are shown in Figure F.

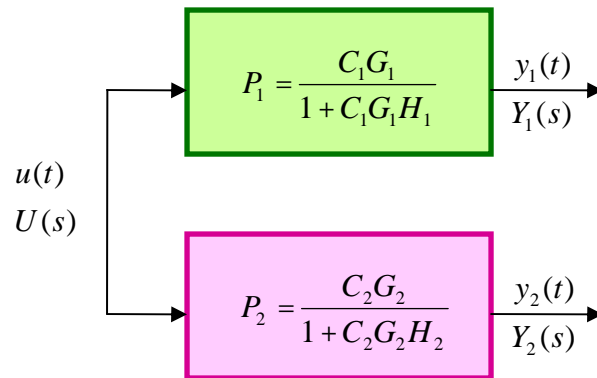

Figure F. Two Related Closed-Loop Dynamic Systems

These two systems can be compared in three frequency ranges of particular significance as shown in the following Figures G, H, and I. From the loop transfer function in Figure G the gain margins and phase margins are obtained as indicated by the green dots (P_1) and red dots (P_2) and tabulated in Table A. Note that similarity in the frequency region corresponding to the aerodynamic instability is primarily indicated by phase margin measures while low frequency gain margin measures are primary indicators in the region of the rigid body response and high frequency gain margins are primary indicators for the first bending mode.

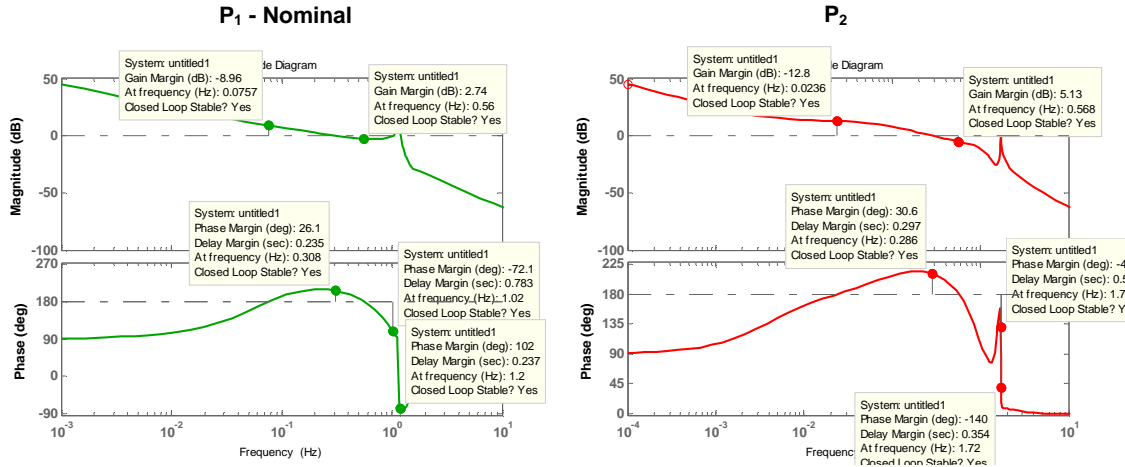

Figure G. Open-Loop Bode Plot Comparison

	P_1	P_2
Aero GM	-8.96 dB	-12.8 dB
RB PM	26.1°	30.6°
RB GM	2.74 dB	5.13 dB
1 st Frontside PM	-72.1°	-49.9°
1 st Backside PM	102°	-140°

Table A. System Characteristic Comparison

Writing the dynamics as a linear superposition such as Equation 2 or 3 suggests the possibility of having distinct metrics corresponding to each of these components (aero, rigid body, flex, etc.). Both dynamic similitude (e.g. damping ratio) and robust similitude (e.g. GM/PM) measures are valid and equally important from the perspective of the flight validation of control systems.

Dissimilarities in these three distinct regions are evident in the closed-loop frequency response where the three mode regions (aerodynamic instability, rigid body response, and first bending mode) are related to the corresponding closed loop pole locations and the associated damping ratio of each mode. The poles in the yellow circle in Figure I represent the exponential decay of the time response at the flexible mode frequency; the poles in the dark blue circle represent the exponential decay at the frequency between the

rigid body gain margin and phase margin frequencies; and the poles in the light blue circle equate to $\zeta = 0.791$ for P_1 and $\zeta > 0$ for P_2 . Accordingly the overdamped time response for P_1 manifests no overshoot whereas the underdamped system P_2 has 1.73% overshoot as shown in Figure H.

These response comparisons suggest that damping ratio is a much better indicator of dynamic similarity with respect to time domain attributes than is gain margin or phase margin. Although the gain and phase margins are different between systems, there is no explicit threshold on them that indicates overshoot. Rather, the substantial difference in time response is indicated by the closed-loop damping ratio associated with the aerodynamic mode (note that the flexible mode response does not significantly affect the time response). Conversely, similarity of the closed-loop step response is not indicative of relative stability associated with the flexible modes as illustrated in Figure H. The dissimilarity in the closed-loop frequency response in the flexible mode region is a much more significant indicator of the way in which the control system interacts with the vehicle bending mode for the two systems. So for this example, time domain based metrics are key indicators for similarity with respect to stabilizing the unstable aerodynamics while damping ratios of the flexible modes are key indicators of similarity with respect to control-structure interaction (recall that damping ratios are preferred over gain margins as individual metrics for a particular mode region because gain margins are system metrics that generally depend on where the loop is broken).

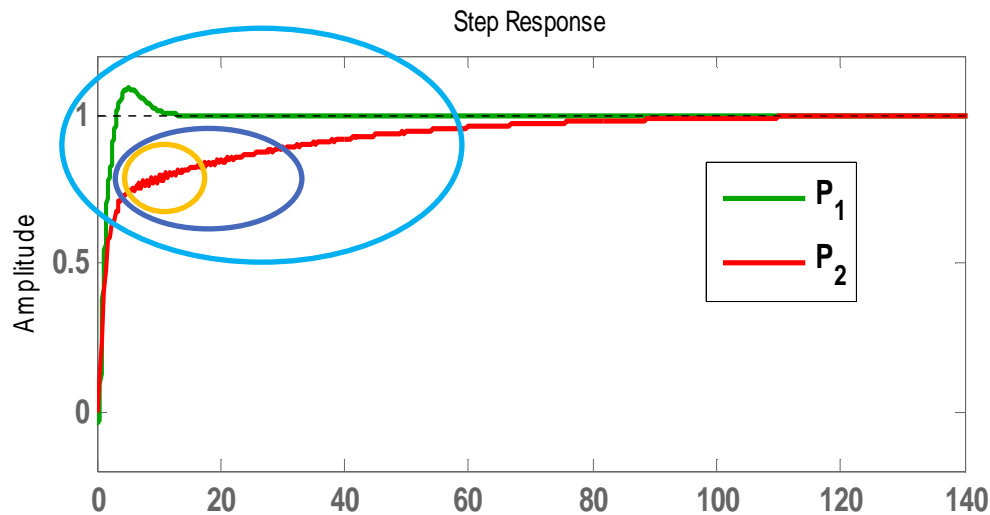

Figure H. Closed-Loop Step Response Comparison

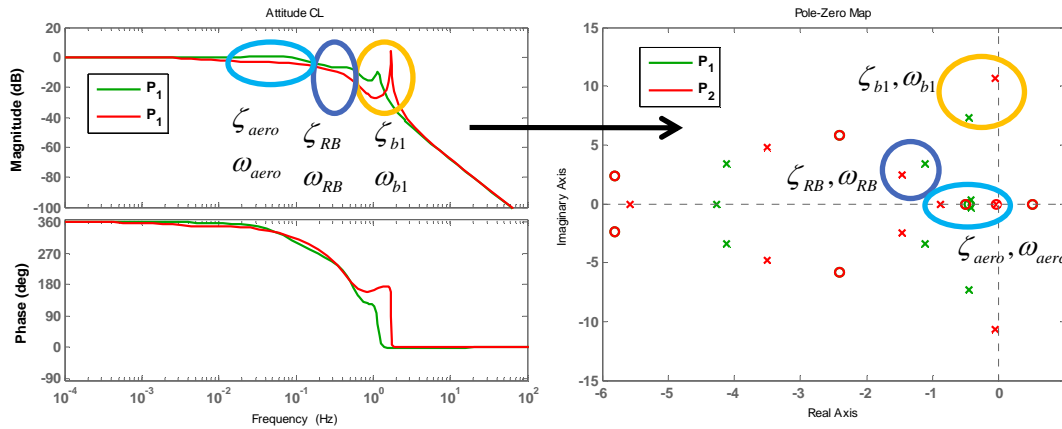

Figure I. Closed-Loop Frequency Domain Comparison

3. Candidate Metrics for Closed-Loop Similarity

In this section we formally define similarity metrics for closed loop systems. As an introduction to this section we will mention other ways similarity is important in other applications such as similarity transforms or sequence comparison such as DNA sequencing....

A. Mode Interaction Ratio Similarity Metric

Vehicle dynamics and control system properties both play a role in the primary flight test objective of demonstrating the stability and performance of the Ares I ascent flight control system via the Ares I-X Flight Test. Of particular emphasis in this test objective is the interaction between the flight control system and the vehicle first bending mode. To satisfy this objective, it is not enough to only have relevant vehicle dynamics OR relevant closed loop performance. What is most pertinent is that the flight control system must interact with the structural dynamics in a relevant fashion. The relevance of this interaction suggests a similarity metric called the “mode interaction ratio” which is defined as the ratio of the first bending mode frequency to the closed loop rigid body frequency (this could equivalently be quantified by the time to double for the aerodynamic instability). Table 2 compares the mode interaction ratio of the Ares I vehicle with other launch vehicles and illustrates that the Ares I flight control is well within the heritage of flight vehicle control from the perspective of control/structure interaction.

An interesting implication of the derived mode interaction similarity metric is that the flight control system bandwidth for the Ares I-X flight is not specified by performance only but rather must be defined by the Ares I mode interaction ratio and the frequency of the first bending mode of the Ares I-X. For example, suppose that the Ares I-X mode interaction ratio must be within 10% of the Ares I mode interaction ratio. Then,

$$0.9 * \left[\frac{f_{m1}}{f_{ctrl}} \right]_{AresI} < \left[\frac{f_{m1}}{f_{ctrl}} \right]_{AresI-1} < 1.1 * \left[\frac{f_{m1}}{f_{ctrl}} \right]_{AresI} \quad (4)$$

Given the Ares I data in the table below, then the rigid body control frequency for Ares I-X must be $0.12 * f_{m1,AresI-1} < f_{ctrl,AresI-1} < 0.15 * f_{m1,AresI-1}$. (These illustrative data for Ares I are from an early configuration) Note that this derived requirement on the flight control bandwidth could potentially impact other disciplines such as aerodynamic or thermal loads if the Ares I-X vehicle dynamics significantly diverges from Ares I vehicle dynamics.

While serving well as a gross indicator of similarity and informing decisions on fidelity of test and analysis requirements, the mode interaction ratio fails to assess similarity in the cases where the first bending mode frequency and/or the control system bandwidth differs. For those cases of dissimilarity other relevant metrics are needed to assess the degree and nature of similarity between systems.

B. Dynamics and Robustness Similitude

To assess the similarity between two dissimilar vehicles/models with respect to the flight control validation objective, the important phenomena from a control systems perspective are

- 1) Flight control system (architecture similitude)
- 2) Closed-loop response (dynamic similitude)
 - a. Is there overshoot?
 - b. How fast is the response?
 - c. How well is the 1st mode being damped?
- 3) Robustness to parameter uncertainty (robust similitude)
 - a. How much uncertainty to OL gain before instability?
 - b. How much phase/delay uncertainty before instability?

(Other metrics such as loads or fuel use are beyond the scope of the question of relevance with respect to the controllability flight test objective).

One would expect then to have similarity metrics pertaining to each of these. As discussed in Section 2, gain and phase margins are appropriate similarity metrics for robust similitude since these margins address variations of specific system parameters at a specific place in the closed loop. Closed-loop damping ratios are the primary metrics for dynamic similitude because damping strongly affects the time response characteristics by indicating the amount of oscillation or whether overshoot is occurring. These metrics are somewhat analogous to Reynolds number and Mach number which are indicative of different flow characteristics although they are dynamically related (e.g. both are proportional to velocity).

C. Normalized Dissimilarity Function Metric

The control systems metrics motivated by SISO control system fundamentals can be generalized to obtain a metric for similarity of SISO or MIMO systems based on the comparison of system norms.

For SISO systems, the similarity in closed-loop damping ratios can be quantified by integrating the difference in magnitude of the loop transfer function in a particular frequency range of significance. Hence the integral of the difference in loop gain magnitude captures the similarity in damping. These integrated signal metrics can be evaluated in terms of various norms.

Consider for example the two systems shown in Figure F. The loop transfer function for these two systems are defined as

$$\begin{aligned} L_1 &= C_1 G_1 H_1 \\ L_2 &= C_2 G_2 H_2 \end{aligned} \quad (5)$$

from which a “normalized dissimilarity” function (where dissimilarity is inversely related to similarity) can be defined as

$$E_L(s) = (L_2(s) - L_1(s))L_1^{-1}(s) \quad (6)$$

Two immediate similarity metric candidates are:

$$\text{2-norm:} \quad \|E_L\|_2 = \sqrt{\frac{1}{2\pi} \int_{j\omega_1}^{j\omega_2} |E_L(j\omega)|^2 d\omega} \quad (7)$$

$$\text{\(\infty\)-norm:} \quad \|E_L\|_\infty = \sup_{\omega_1 < \omega < \omega_2} |E_L(j\omega)| \quad (8)$$

where the 2-norm gives a cumulative measure over a particular frequency range while the ∞ -norm is a measure of the peak difference over the frequency range. In general, the magnitude of $L(s) \gg 1$ for low frequencies and tends to zero for high frequencies. Hence $E_L(s)$ is only defined for finite frequency ranges.

These metrics will be developed and analyzed in the final paper. Bounds on these norms can be obtained from dispersed loop transfer functions in the monte-carlo analysis. Note that this metric can be applied to either SISO or MIMO systems.

4. Similarity Metrics Applied to the Ares Launch Vehicles

In this section of the final paper these metrics will be applied to the Ares I and Ares I-X vehicles to assess similarity. First we will give an overview of the Ares I and I-X launch vehicles. (NOTE TO Reviewer: We will complete the following sections that give an overview on the Ares I and Ares I-X vehicles and flight control systems for the conference draft. This will only be summarized here since a companion paper is being submitted to fully cover this topic.)

A. Ascent Flight Control Design for the Ares I Launch Vehicle

- ii. Overview of the Ares I Launch Vehicle
- iii. Ascent Flight Control Architecture
- iv. Ascent Flight Control Stability and Performance

B. Ares I-X Flight Test Vehicle Description

Future work:

- Other second order systems examples will be shown to illustrate and motivate the dynamic and robust similitude metrics.
- For the final version, we will implement the various candidate metrics with models of Ares I and Ares I-X to assess the utility of each for quantifying similarity with given model discrepancies. This assessment will give insight into which metrics give the best assessment of similarity with respect to different vehicle dynamics attributes.
- Add references

5. Conclusions

- Like in scaled model testing, similitude quantities cannot all be satisfied unless both models are exactly the same and the environment variables are the same (pick the ones that are important to the phenomenon being studied)
- If we are trying to test the applicability of robustly phase stabilizing the 1st mode, then likely GM, PM, ζ , and M_p are sufficient similitude parameters
 - The flex frequency is not really a concern to the issue of stability if the other parameters are not affected
- If we are interested in having the transient response of the rigid body to be more or less the same, then we would likely use M_p , ω_n , ζ (if oscillatory motion or else σ / ω_{BW} if exponentially decaying)
 - GM, PM are likely not necessary if they are sufficiently large and do not affect the other parameters (e.g. neglect Mach no. if it is low enough that compressibility effects do not come into play)