



Propulsion Investigation for Zero and Near-Zero Emissions Aircraft

*Christopher A. Snyder, Jeffrey J. Berton, Gerald V. Brown, James L. Dolce, Narayan V. Dravid, Dennis J. Eichenberg, Joshua E. Freeh, Christopher A. Gallo, Scott M. Jones, Krishna P. Kundu, Cecil J. Marek, Marc G. Millis, Pappu L. Murthy, Timothy M. Roach, Timothy D. Smith, George L. Stefko, Roy M. Sullivan, and Robert T. Tornabene
Glenn Research Center, Cleveland, Ohio*

*Karl A. Geiselhart
Langley Research Center, Hampton, Virginia*

*Albert F. Kascak
U.S. Army Research Laboratory, Glenn Research Center, Cleveland, Ohio*

NASA STI Program . . . in Profile

Since its founding, NASA has been dedicated to the advancement of aeronautics and space science. The NASA Scientific and Technical Information (STI) program plays a key part in helping NASA maintain this important role.

The NASA STI Program operates under the auspices of the Agency Chief Information Officer. It collects, organizes, provides for archiving, and disseminates NASA's STI. The NASA STI program provides access to the NASA Aeronautics and Space Database and its public interface, the NASA Technical Reports Server, thus providing one of the largest collections of aeronautical and space science STI in the world. Results are published in both non-NASA channels and by NASA in the NASA STI Report Series, which includes the following report types:

- **TECHNICAL PUBLICATION.** Reports of completed research or a major significant phase of research that present the results of NASA programs and include extensive data or theoretical analysis. Includes compilations of significant scientific and technical data and information deemed to be of continuing reference value. NASA counterpart of peer-reviewed formal professional papers but has less stringent limitations on manuscript length and extent of graphic presentations.
- **TECHNICAL MEMORANDUM.** Scientific and technical findings that are preliminary or of specialized interest, e.g., quick release reports, working papers, and bibliographies that contain minimal annotation. Does not contain extensive analysis.
- **CONTRACTOR REPORT.** Scientific and technical findings by NASA-sponsored contractors and grantees.
- **CONFERENCE PUBLICATION.** Collected

papers from scientific and technical conferences, symposia, seminars, or other meetings sponsored or cosponsored by NASA.

- **SPECIAL PUBLICATION.** Scientific, technical, or historical information from NASA programs, projects, and missions, often concerned with subjects having substantial public interest.
- **TECHNICAL TRANSLATION.** English-language translations of foreign scientific and technical material pertinent to NASA's mission.

Specialized services also include creating custom thesauri, building customized databases, organizing and publishing research results.

For more information about the NASA STI program, see the following:

- Access the NASA STI program home page at <http://www.sti.nasa.gov>
- E-mail your question via the Internet to help@sti.nasa.gov
- Fax your question to the NASA STI Help Desk at 301-621-0134
- Telephone the NASA STI Help Desk at 301-621-0390
- Write to:
NASA Center for AeroSpace Information (CAST)
7115 Standard Drive
Hanover, MD 21076-1320



Propulsion Investigation for Zero and Near-Zero Emissions Aircraft

*Christopher A. Snyder, Jeffrey J. Berton, Gerald V. Brown, James L. Dolce, Narayan V. Dravid, Dennis J. Eichenberg, Joshua E. Freeh, Christopher A. Gallo, Scott M. Jones, Krishna P. Kundu, Cecil J. Marek, Marc G. Millis, Pappu L. Murthy, Timothy M. Roach, Timothy D. Smith, George L. Stefko, Roy M. Sullivan, and Robert T. Tornabene
Glenn Research Center, Cleveland, Ohio*

*Karl A. Geiselhart
Langley Research Center, Hampton, Virginia*

*Albert F. Kascak
U.S. Army Research Laboratory, Glenn Research Center, Cleveland, Ohio*

National Aeronautics and
Space Administration

Glenn Research Center
Cleveland, Ohio 44135

This report contains preliminary findings,
subject to revision as analysis proceeds.

Trade names and trademarks are used in this report for identification
only. Their usage does not constitute an official endorsement,
either expressed or implied, by the National Aeronautics and
Space Administration.

This work was sponsored by the Fundamental Aeronautics Program
at the NASA Glenn Research Center.

Level of Review: This material has been technically reviewed by technical management.

Available from

NASA Center for Aerospace Information
7115 Standard Drive
Hanover, MD 21076-1320

National Technical Information Service
5285 Port Royal Road
Springfield, VA 22161

Available electronically at <http://gltrs.grc.nasa.gov>

Propulsion Investigation for Zero and Near-Zero Emissions Aircraft

Christopher A. Snyder, Jeffrey J. Berton, Gerald V. Brown, James L. Dolce, Narayan V. Dravid, Dennis J. Eichenberg, Joshua E. Freeh, Christopher A. Gallo, Scott M. Jones, Krishna P. Kundu, Cecil J. Marek, Marc G. Millis, Pappu L. Murthy, Timothy M. Roach, Timothy D. Smith, George L. Stefko, Roy M. Sullivan, and Robert T. Tornabene
National Aeronautics and Space Administration
Glenn Research Center
Cleveland, Ohio 44135

Karl A. Geiselhart
National Aeronautics and Space Administration
Langley Research Center
Hampton, Virginia 23681

Albert F. Kascak
U.S. Army Research Laboratory
Glenn Research Center
Cleveland, Ohio 44135

Summary

As world emissions are further scrutinized to identify areas for improvement, aviation's contribution to the problem can no longer be ignored. Previous studies for zero or near-zero emissions aircraft suggest aircraft and propulsion system sizes for propulsion system and subsystems layout and propellant tankage analyses to verify the weight-scaling relationships. These efforts could be used to identify and guide subsequent work on systems and subsystems to achieve viable aircraft system emissions goals. Previous work quickly focused these efforts on propulsion systems for 70- and 100-passenger aircraft. Propulsion systems modeled included hydrogen-fueled gas turbines and fuel cells; some preliminary estimates combined these two systems. Hydrogen gas-turbine engines, with advanced combustor technology, could realize significant reductions in oxides of nitrogen emissions. Hydrogen fuel cell propulsion systems were further laid out, and more detailed analysis identified systems needed and weight goals for a viable overall system weight. Results show significant, necessary reductions in overall weight, predominantly on the fuel cell stack, and power management and distribution subsystems to achieve reasonable overall aircraft sizes and weights. Preliminary conceptual analyses for a combination of gas-turbine and fuel cell systems were also performed, and further studies were recommended. Using gas-turbine engines combined with fuel cell systems can reduce the fuel cell propulsion system weight, but at higher fuel usage than using the fuel cell only.

Introduction

NASA aeronautics goals include reducing emissions and noise and pioneering new technology. Advancements in electrical power sources, including fuel cells and electromechanical systems such as electric motors, have shown promise in meeting these goals. The automobile and stationary power industries have embraced these technologies as a means to more efficient vehicles and power plants. The resulting research and development effort has created lighter-weight, more compact, and powerful fuel cells and electric motors. Previous system studies for commercial passenger aircraft with propulsion system performance derived from these efforts have identified fuel cell propulsion technology shortfalls. These shortfalls came mainly from the much larger power requirements of modest to large commercial passenger aircraft. Even with the use of advanced airframe structures and shapes, these fuel cell systems had to be

scaled from the order of 10- to 100-kW needed for stationary or ground transportation systems up to 10- to 100-MW systems required for commercial aircraft. With so much up-scaling of the fuel cell propulsion system, it was prudent to perform a more detailed system layout and initial design to further anchor the mass assumptions and requirements for thermal management and power management and distribution (PMAD). After a more detailed analysis, if systems performed as well or better than assumed in the previous work, it would validate the previous analyses, while suggesting more specific areas for additional research and development. If there were performance shortfalls, new system configurations or even further technological breakthroughs might be required for such systems to be viable for commercial applications. Identifying these possible shortfalls was the major focus of the effort of this study.

Concurrently, gas-turbine combustor computational and experimental work suggested significant potential reductions in oxides of nitrogen (NO_x) emissions with advanced technology combustors designed specifically for hydrogen fuel. Therefore, this study also estimated the benefits of gas-turbine engine systems using advanced technology hydrogen combustors.

Overall Approach

As previously stated, the largest effort in this study was to further define the hydrogen fuel cell (HFC) propulsion system components and their performance characteristics. Laying out representative systems helps identify subsystems to analyze, defines individual levels of performance needed for reasonable overall performance, and guides the focus of future analysis and research. This analysis could also serve to anchor the previous, simpler-weight models that were based on scaling up ground-based systems with some weight reductions, assuming aviation-based systems.

To help define the scope of this analysis, several ground rules will limit the study design space, while hopefully not biasing the subsequent results. Conventional “tube-and-wing” airframes were chosen for this study, to help focus on the propulsion system. Although today’s aircraft are kerosene fueled, study aircraft would be liquid hydrogen fueled, as discussed in previous efforts (Refs. 1 to 3). Realizing that aircraft much larger, heavier, or less efficient than today’s vehicles would probably not be considered economically viable, designs were defined in this study as having takeoff gross weights (TOGWs) no greater than 10 to 20 percent above present aircraft (assuming the same passenger, payload, and mission range). Initial efforts reviewed studies on a range of aircraft sizes, but quickly selected a few aircraft classes to focus efforts on more detailed definition and analysis of the overall propulsion and the various subsystems. NO_x emissions were estimated for the various propulsion system options, as well as fuel efficiency.

Previous Studies and Choosing 100-Passenger Aircraft Size

Interest generated by the higher potential efficiency of fuel cell power and propulsion systems over traditional gas-turbine engines for aviation was the impetus for developing analysis capability for performance and sizing of these systems. Previous studies for a two-seater, light airplane (Refs. 4 and 5) identified several performance benefits, while also noting issues with the overall size and weight of the HFC system and hydrogen tankage, assuming near-term technology. NASA Langley and Glenn’s collaborative studies for commercial passenger aircraft systems (Refs. 1 to 3) reinforced the need for reducing the higher system weight versus delivered power of the fuel cell propulsion system. These efforts indicated that smaller aircraft required smaller propulsion systems that could be easier to develop, especially the flight-weight PMAD. However, smaller aircraft are also more sensitive to overall propulsion weight; the layout and packaging for the various subsystems may be more difficult. Large aircraft are less sensitive to propulsion system overall weight and packaging; also, their longer mission profiles can take better advantage of a fuel cell system’s higher overall efficiency. Conversely, these large aircraft also require very high power levels, well beyond state-of-the art for fuel-cell-based flight propulsion systems. Defining realistic PMAD systems could overwhelm other areas requiring effort.

TABLE I.— SPECIFIC POWER AND WEIGHT FOR AVIATION PROPULSION SYSTEMS (FROM REF. 8)

Engine type	Specific power, kW/lbm	Specific weight, lbm/kW
Current hydrogen fuel cell (HFC) technology	0.14	7.1
30-yr HFC projection	0.297	3.4
Aircraft piston engines	0.5	2
Aircraft turboshaft engines	1.5 to 3.0	0.75 to 0.33

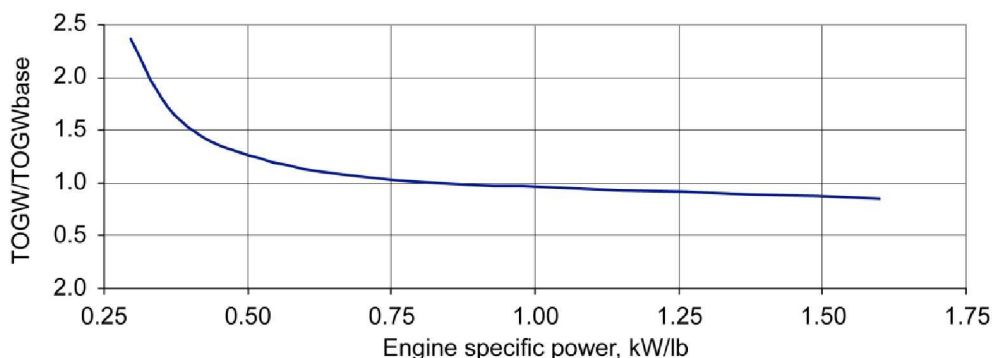

Figure 1.—Effect of engine-specific power on 100-passenger hydrogen fuel cell aircraft takeoff gross weight (TOGW) to the TOGW of the baseline kerosene, gas-turbine aircraft.

The specific power used in the later, collaborative studies for commercial passenger aircraft is given in Table I. The advanced HFC system is roughly 66 percent heavier for the same propulsion power as the comparable power piston engine, and 5 to 10 times heavier than a gas-turbine engine (turboshaft). However, the higher efficiency of the HFC propulsion system (estimated at 20 to 30 percent better cruise-specific fuel consumption than the conventional gas-turbine engine) and the resulting reduced total fuel needed for the mission allows some increase in propulsion system weight before the TOGW of the HFC exceeds the conventional aircraft system. This effect is shown in Figure 1 for the 100-passenger aircraft. The HFC propulsion system specific power only needs to be roughly 0.8 kW delivered power per pound of weight versus the current baseline gas-turbine engine specific power of almost 4 kW per pound. Achieving 0.8 kW power per pound for the HFC is still over 2.5 times better than projected values in the next 30 years (without specific technology advancement on the most critical components and a factor of almost 6 from today's state-of-the-art). It was decided to attack weight from a different direction, that is, to determine the required propulsion system power per weight assuming only 10 or 20 percent growth in TOGW. The required engine specific power (kW/lbm) is given in Figure 2 for seven types of passenger aircraft with varying numbers of passengers and design ranges. As can be seen, the 50-passenger aircraft requires a much higher engine specific power than the larger aircraft (resulting from the combination of aerodynamic penalties from the hydrogen tankage volume and too short a mission range for any fuel savings from higher propulsion efficiency to be realized). Since the other aircraft required similar, lesser amounts of improvements in specific power, the 100-passenger aircraft was selected for subsequent propulsion system design and analysis. It was predicted that the smaller overall power requirement would make the design and scaling of needed systems and subsystems easier, and would simplify subsequent testing and verification of weight reduction designs and technologies.

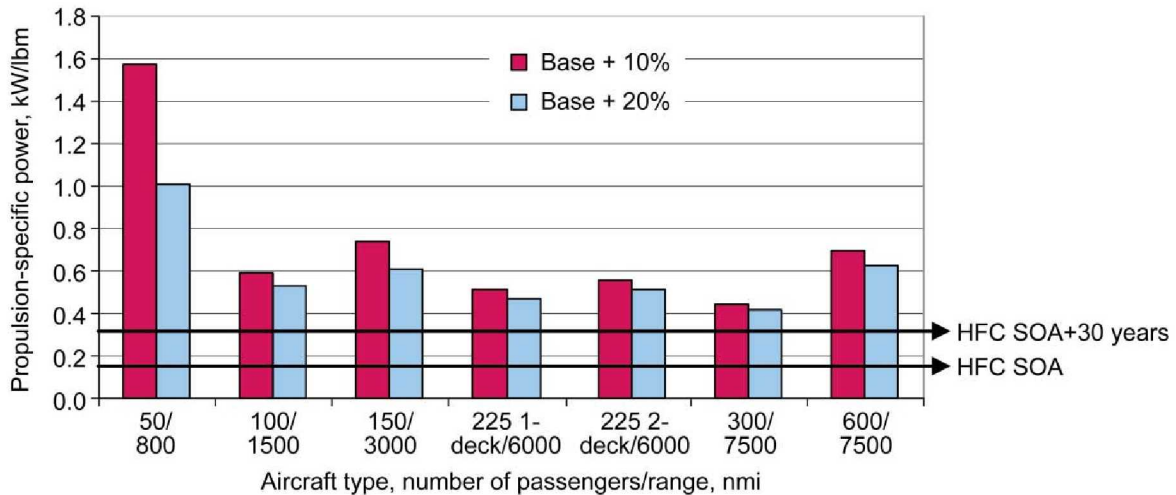

Figure 2.—Required hydrogen fuel cell (HFC) propulsion specific power to meet 10 to 20 percent increase in takeoff gross weight (TOGW) (state of the art (SOA)).

Additional Work

In addition to further refining the HFC propulsion system for a 100-passenger aircraft, subsequent, smaller efforts were included in this study. Recent hydrogen combustor testing and analysis (Ref. 6) have indicated a substantial potential reduction in NO_x emissions; therefore, hydrogen gas-turbine engines could possibly propel a very low emissions aircraft, while technology for the HFC system matures for commercial aviation. Additionally, high interest in the 70-passenger aircraft size directed the team to redo analyses and resize systems from a 100-passenger class to a smaller 70-passenger version. Finally, some preliminary estimates were made for an aircraft using a hybrid, gas-turbine HFC system.

Airframe Description and Modeling Assumptions

Aircraft performance and sizing was performed using the Flight Optimization System (FLOPS) (Ref. 7) program, a multidisciplinary system of computer programs for conceptual and preliminary design and evaluation of advanced aircraft concepts. The FLOPS models for the 100- and 70-passenger aircraft are representative of current state-of-the-art aircraft, modified for the inclusion of liquid hydrogen tankage. The weight for all other fuel system components (e.g., pumps and plumbing) is based on the weight of a kerosene-based system. This weight was then validated during the more detailed hydrogen tankage analysis described later in this report. No additional aircraft volume is included for the HFC system itself because no information on the physical size or shape of the system was available. Although possibly an optimistic assumption for the conventional tube-and-wing airframe, the hydrogen fuel is in the fuselage, and the wing volume is not being used. Additionally, no drag penalties were assessed for HFC system cooling requirements. Preliminary analyses suggested potential designs that could mitigate drag penalties at certain flight conditions (such as cruise) with only a small drag penalty (estimated at less than a 10 percent increase in total drag) during other parts of a standard mission. Since such drag reduction and optimization were beyond the scope of this study (and seemed small), such analyses are left for subsequent efforts. The actual analysis methodology for the hydrogen tankage and aircraft layout, sizing, and mission analysis are discussed below.

Hydrogen Tankage

Although hydrogen fuel has a relatively high energy content per pound, its low energy per volume, even at cryogenic liquid conditions, is problematic for aircraft. Previous studies show that gaseous hydrogen is impractical for this class of aircraft and mission because of the required fuel volume and issues

with tank weight and safety. Even though liquid hydrogen is roughly three times denser than very high pressure, gaseous hydrogen, it still requires four times the volume of the equivalent kerosene fuel. Liquid hydrogen also has to be stored at 20 K (−423.67 °F), requiring insulation to reduce fuel boiloff and condensation on the tank surface. Storing the hydrogen fuel in the wing is impractical. Previous studies suggested that tanks in the main fuselage were an optimum solution in many cases and were again used for this study. The mission and sizing analysis used the same assumptions for tank weight, insulation thickness, and fuel boiloff as previous studies (Refs. 1 to 3). For this study, the following tank assumptions were applied: tank weight is fuel weight \times 0.356, the insulation is 0.20 ft thick, and the boiloff loss (amount of hydrogen loss versus total initial fuel weight) is 10 percent. After initial analyses, a more detailed cryogenic tank analysis was performed to verify these assumptions.

A cryogenic tank modeling tool that was previously developed for an unmanned aeronautic vehicle application (Ref. 8) was modified to perform parametric analysis for the liquid hydrogen tank(s) for this passenger aircraft application. The program performs preliminary structural and thermal analysis on spherical or cylindrical tanks based on the weight of fuel required, tank pressure, number of tanks, ambient temperature, and mission length. For these analyses, a tank pressure of 30 psia was assumed with a 7 percent ullage (unfilled) volume. The tank material chosen for this analysis was 2014-T6 aluminum, with a 1.4 factor of safety used to calculate the vessel wall thickness. Based on the specified fuel requirements and aircraft packaging constraints, trade studies examined the number and shape of the tanks. After several design iterations, the best design option was to utilize two separate tanks, located fore and aft, with an approximate length-to-diameter ratio of 2.

For the thermal analysis of hydrogen boiloff, the environmental temperature was conservatively chosen to be 324.8 K (125 °F), considered to be a worst-case condition, with a 5-hr mission length. Several different cryogenic fuel tank insulating materials were investigated for this application. The liquid hydrogen spreadsheet tool was used to determine increments of insulation thickness and calculate insulation weight and hydrogen boiloff loss, which when added to the tank weight, established an overall tank system weight. When plotted, it could be quickly ascertained which insulation thickness resulted in lowest overall system weight.

The optimum system weight resulted when vacuum-jacketed tanks with multilayer insulation (MLI) were utilized. However, the use of vacuum-jacketed systems in the vibratory environment, experienced in this relatively short-duration aircraft application, caused system complexity and reliability concerns. Based on previous studies of other insulation technologies, spray on foam insulation (SOFI) was used to provide the lowest overall system weight (tank, insulation, and fuel loss to boiloff weights) for this application. Figure 3 shows the total weight of both tanks is a minimum using approximately 2.5 in. of SOFI.

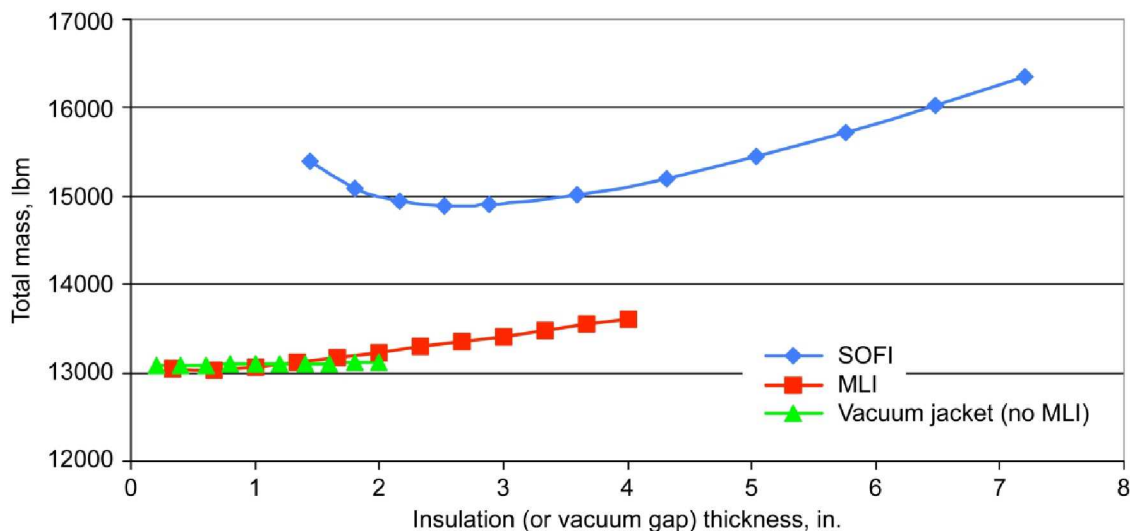

Figure 3.—Total mass of cryogenic, liquid hydrogen fuel tank, structure, insulation, and fuel versus insulation type and insulation thickness or vacuum gap (spray on foam insulation (SOFI) and multilayer (MLI)).

Using less insulation increased fuel weight needed to compensate for increased fuel boiloff, tank size, and weight faster than the reduction in insulation weight. Conversely, increasing insulation thickness from this value increased the insulation weight more than the reduction in fuel allowances for boiloff and tank size and/or weight.

The structural weight of the tank was estimated to be 17.5 percent of the fuel weight. The insulation weight was nearly 10 percent of the fuel weight, which when added to the tank weight compares relatively well with Brewer (Ref. 9). If other structural attachment hardware and tank-flow conditioning and pumping devices are considered, the total tank weight can reach as high as 35 percent of the fuel weight, as has been shown in previous studies and corroborates the assumptions used.

Hydrogen Delivery System

A preliminary hydrogen delivery system schematic is presented in Figure 4. A high-pressure helium source would be regulated and used as a hydrogen tank pressurant. Preliminary results indicated that this subsystem total weight would be small and it was assumed to be included in the tankage and fuel system weights. Autogenous tank pressurization was considered for this system, but it was felt the weight differences between the two system architectures would be negligible for the level of fidelity of this study. The schematic includes essential valving for ground operations, system vent and purge, tank interconnects, primary system instrumentation, and pressure relief devices. The liquid is pumped through a heat exchanger for gasification and delivered to the fuel cell or engine.

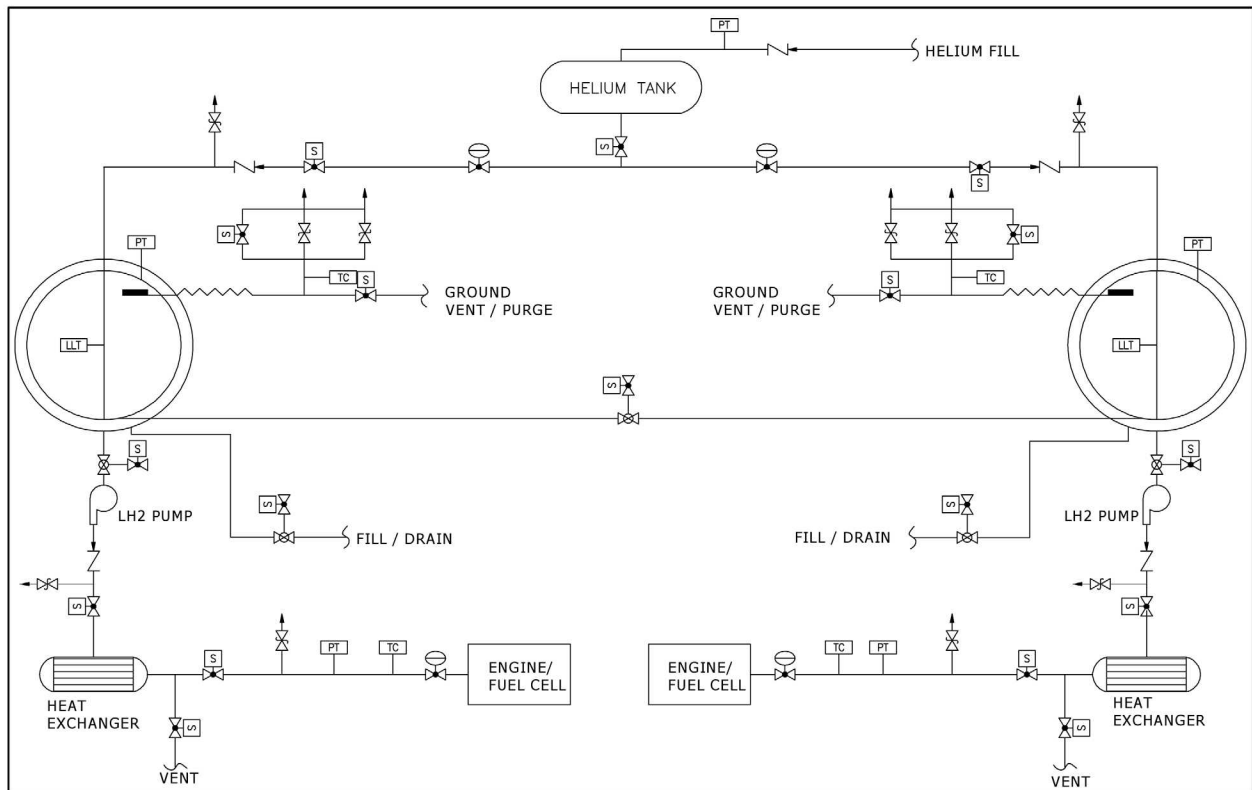

Figure 4.—Hydrogen feed system schematic for a 100-passenger zero emissions aircraft (liquid level transducer (LLT), solenoid (S), pressure transducer (PT), and thermocouple (TC)).

TABLE II.—GASEOUS HYDROGEN SYSTEM LINE DIAMETER (IN.)
AND A MACH NUMBER OF 0.10

Gas temperature		Speed of sound, ft/s	Line pressure, psia							
K	°R		50	100	200	300	400	500	750	1000
55.6	100	1860.6	3.271	2.313	1.635	1.335	1.156	1.034	0.845	0.731
83.3	150	2278.8	3.620	2.560	1.810	1.478	1.280	1.145	0.935	0.809
111.1	200	2631.4	3.890	2.750	1.945	1.588	1.375	1.230	1.004	0.870
138.9	250	2941.9	4.113	2.908	2.056	1.679	1.454	1.301	1.062	0.920
166.7	300	3222.7	4.305	3.044	2.152	1.757	1.522	1.361	1.111	0.963
194.4	350	3481.0	4.474	3.164	2.237	1.826	1.582	1.415	1.155	1.000
222.2	400	3721.3	4.626	3.271	2.313	1.888	1.635	1.463	1.194	1.034
250.0	450	3947.0	4.764	3.369	2.382	1.945	1.684	1.506	1.230	1.065
277.7	500	4160.5	4.891	3.459	2.446	1.997	1.729	1.547	1.263	1.094

Preliminary trade studies were performed to determine the effect of hydrogen fuel pressure on gas delivery line size. The piping was sized based on the maximum fuel flow (climb) condition over the temperature range experienced by the hydrogen fuel. For liquid hydrogen conditions, it was found that 0.5-in. line diameters would be sufficient. For gaseous conditions, a low Mach number (0.1), was assumed to reduce pipe friction losses. In order to maintain small piping diameters (and resultant pipe weights), line pressures of 300 to 500 psi would be required to utilize transfer piping in the practical size range of 1 to 2-in. diameter at the assumed low Mach number. Table II shows the effect of gaseous hydrogen delivery pressure on the pipeline size over the assumed hydrogen fuel temperature expected during system operation.

Aircraft Layout, Mission Analysis, and Sizing

To convert from kerosene to a liquid-hydrogen-fueled aircraft, the fuselage diameter was increased and passenger layout modified to generate the usable volume required for fore and aft hydrogen fuel tanks. Just lengthening the fuselage to handle the increased fuel volume was impractical because of structural and tail scrape and rotation issues. Increasing fuselage diameter permitted additional seating abreast, freeing up fuselage length for the hydrogen tankage. A NASA program, vehicle sketch pad (VSP), was used to lay out the initial tank and aircraft geometry used in the FLOPS mission and sizing program (Fig. 5). FLOPS and VSP were incorporated into a commercially available framework that allows a variety of programs running on different platforms to communicate. For this analysis, VSP is used to calculate available fuel volume based on the tank lengths. From this volume and the boiloff, the mission available fuel weight is computed. FLOPS updates the vehicle aerodynamic characteristics based on the geometry, flies the mission, and calculates the required fuel, the TOGW, and many other performance parameters. An external optimizer was used to vary propulsion system size and wing area in FLOPS and the tank lengths in VSP to minimize the TOGW subject to the following constraints: takeoff and landing field lengths, approach velocity, and an excess fuel requirement for alternate airport diversion. The fuselage weight in FLOPS is based on its length. For this analysis, the hydrogen tanks are integrated with the fuselage, so the tank weight was reduced as appropriate. Each case was not deemed converged unless the excess fuel volume was very near zero. This required several variations of the optimizer settings and/or the initial guesses of the design variables.

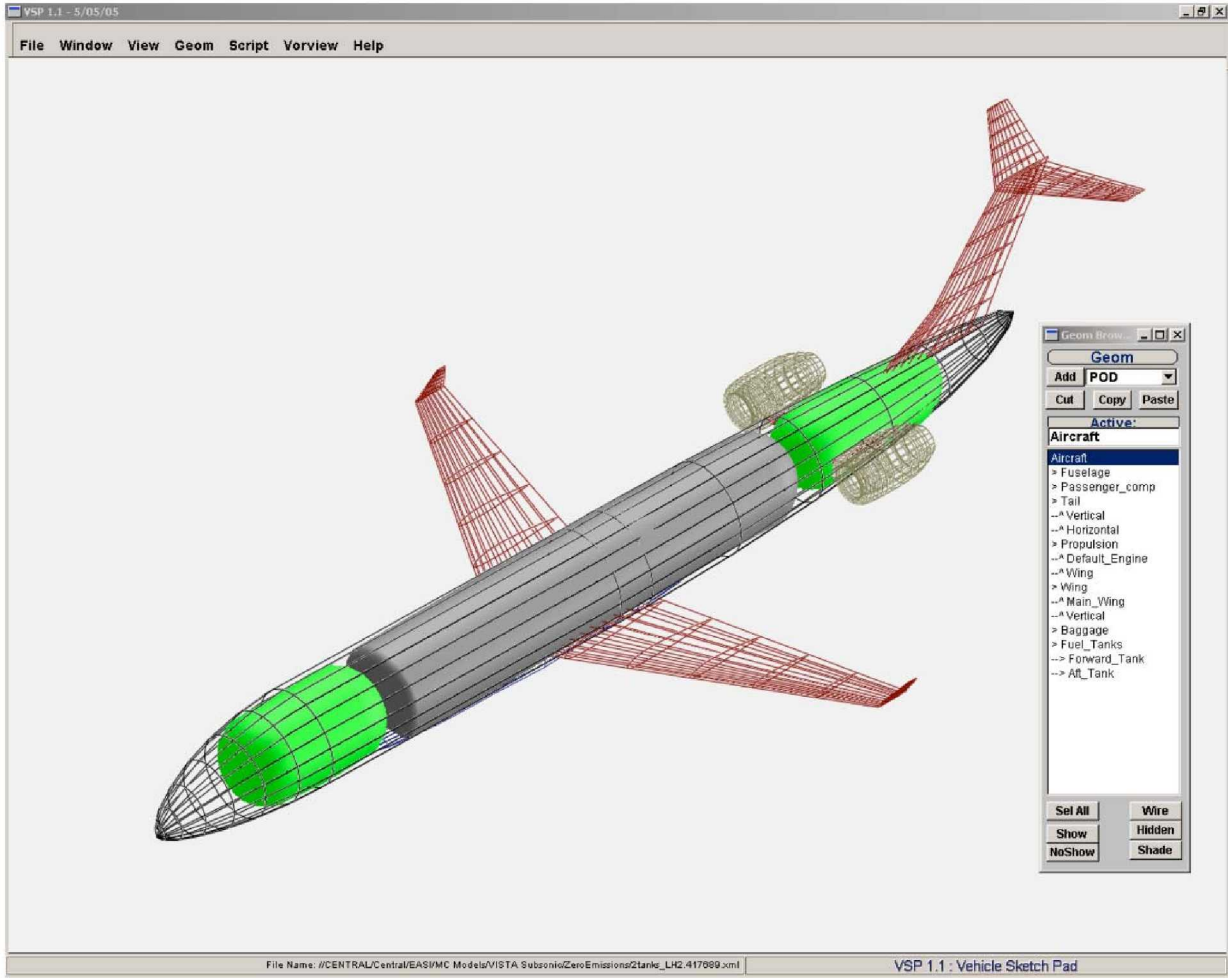

Figure 5.—Initial layout of hydrogen-fueled configuration showing fuel tankage (in green) and passenger compartment (in gray).

Propulsion System Definition and Modeling

The capability to analyze various systems is generally dependent on technology maturity and experience in the desired environment. Gas-turbine systems assumed in this study are fairly similar to existing systems; therefore, there is high confidence in their calculated system performance and weight. HFC systems analysis capability is still being developed and verified for many different applications and in many different system configurations. Requirements for performance, size, and weight in aviation systems can be much different than those in stationary or automotive power systems. Although the fuel cell stacks could be similar, system layout and aviation-unique ancillary systems could make scaling from existing stationary or automotive systems questionable. Therefore, additional effort was applied to define the actual HFC system and subsystems requirements and their operating environment. With this information, systems and subsystem characteristics could be more reliably determined. With overall performance goals from the initial studies, effort was then focused on areas most likely to meet those goals.

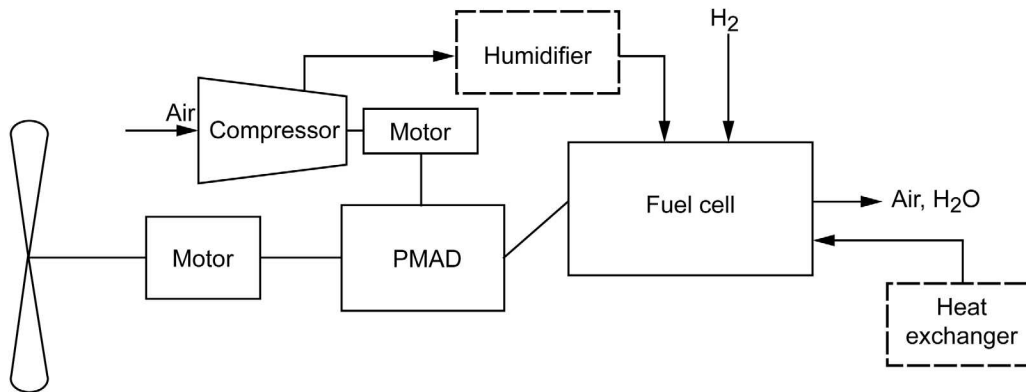

Figure 6.—Fuel cell propulsion and power system (power management and distribution (PMAD)).

For the HFC systems, detailed work was performed assuming proton exchange membrane (PEM) fuel cells and their ancillary systems. A schematic of the fuel cell propulsion system for this study is shown in Figure 6. As envisioned, the PEM HFC supplies electric power to operate an electric motor driving a ducted fan for propulsion thrust (as discussed in Refs. 1 to 3). Preliminary performance using solid-oxide fuel cells (SOFCs) in a similar arrangement was also estimated. Hybrid systems, blending the strengths of HFC and gas-turbine systems, were also conceptualized and some initial estimates were made for performance. They will be described later in this report. Related information about a more detailed tool for design and analysis of a SOFC hybrid configuration for aviation auxiliary power can be found in References 10 and 11.

Hydrogen Gas-Turbine Engine

The gas-turbine cycle has many characteristics that make it well suited for commercial aviation: simplicity and low maintenance, compactness and lightweight, as well as better noise and vibration characteristics than the piston engines it replaced. Its operational characteristics also make it difficult to totally eliminate NO_x emissions. Combustor research during the High-Speed Research (HSR) program and the Ultra-Efficient Engine Technology (UEET) program explored different methods to reduce NO_x and found reductions of up to 90 percent in cruise NO_x formation from the baseline configurations may be possible, but that might not be enough. More recent work (Ref. 6) has suggested that by using hydrogen with the right combustor design, NO_x emissions could be further reduced by over 90 percent. Although not zero, it could be a viable, very low emissions system until zero-emissions solutions could be developed. Using current technology combustors with hydrogen fuel would not be effective for low NO_x production; the high flame speed of hydrogen combustion effectively increases hot gas residence time and NO_x formation. Additionally, the use of hydrogen fuel would totally eliminate all soot and particle emissions, which are also contributors to air pollution and other health issues.

For the 100- and 70-passenger aircraft, generic gas-turbine simulations were put together using the Numerical Propulsion System Simulation (NPSS) (Ref. 12). The thermodynamic models included real gas effects, representative maps of compressor and turbine performance, and engine parameters representative for present, regional, and jet aircraft. Correlations from Reference 6 were used to estimate NO_x emissions. These models were “flown” over the flight envelope to produce engine performance tables for the mission analysis. Engine weight was estimated using an in-house tool, weight analysis of turbine engines (WATE) (Ref. 13), assuming the advanced hydrogen combustor design weight would be similar to an advanced kerosene version. Since combustor weight is generally less than 5 percent of total engine weight, it was a reasonable assumption for this study.

Hydrogen Fuel Cell

A fuel cell is an electrochemical device that converts the chemical energy of a reaction directly to electricity, similar to a battery. However, its performance does not decline like a battery because reactants are supplied from an external source. A fuel cell can theoretically continue to supply electricity as long as it is supplied reactants. Using a propulsion system based on H₂ fuel cells has two primary potential advantages over burning hydrogen in gas-turbine engines. Because the fuel cell process is at a much lower temperature than combustion with air, NO_x emissions can be eliminated. When using pure hydrogen as the fuel, water is the only emission from a fuel cell propulsion system. The second benefit is the potential for increased fuel efficiency. Conventional aircraft propulsion systems are heat engines. The chemical energy of a reaction is released as heat, and the heat is then converted to mechanical work. The operating temperature of a heat engine limits the maximum efficiency that can be achieved. A fuel cell is not a heat engine and is not subject to this fundamental efficiency limit, giving the potential for higher efficiency. Fuel cells operate more efficiently at lower power densities, but aircraft weight and volume limits require reducing weight by operating the fuel cell stacks at higher power densities, sacrificing some efficiency. Additional losses are incurred during flight from compressing ambient air to the pressure needed for the fuel cell stack. Finally, the electrical output of the fuel cell has to be converted to thrust. One way this can be accomplished is by powering an electric motor which turns a propeller or ducted fan. These necessary electricity-to-thrust conversion steps are likely to have significantly higher aggregated efficiency than the fuel cell system itself, but they still will have some impact on the overall efficiency of the HFC propulsion system and are required for a fair comparison with the gas-turbine system.

The different types of fuel cells are generally categorized by the electrolyte used. This study focused mainly on the PEM fuel cell with some effort on the SOFC. In recent years, a significant amount of automotive research has focused on the PEM fuel cell because of its high power density and its short startup time. Interest in the SOFC has also been increasing recently. The high-temperature operation of the SOFC has the potential for increased system efficiency through cogeneration (generating useful heat in addition to electricity) or a bottoming cycle (waste heat used to generate additional electricity).

Fuel Cell Propulsion System Analysis

A thermodynamic performance model for the fuel cell system was developed using NPSS. The model development, input, and assumptions are discussed in more detail in Reference 1. Not only does the model produce an “engine deck” output (i.e., thrust and fuel flow versus Mach number, altitude, and power level) that is needed for mission analysis, but it also calculates conditions that can be used for further analysis and sizing of the various components and subsystems.

Weight Models

Knowing the desired size of the various study aircraft, the system model gave sizing information and an overall weight target. Next, the various systems and subsystems were laid out, and weights were determined and checked against the overall target weights. The initial breakdown of component and overall system-specific weights are given in Table III, also shown as a pie chart in Figure 7. The fuel cell system and power controls and/or electronics are the major contributors to overall weight. The next step was identifying possible weight reductions through either improved technology and/or different configurations.

Fuel cell.—The weight for PEM fuel cell stacks was scaled from data published by General Motors, representing an industry “best-built” stack, but also was adjusted for expected further improvements in technology. Estimates for SOFC weights were based on the work of References 10 and 11, in which a semi-empirical cell-based model is used. The number of cells is calculated from the performance requirements, and the stack weight is built from the single cell weight, along with an estimate of the nonrepeating hardware such as the endplates.

TABLE III.—INITIAL COMPONENT AND SUBSYSTEM BREAKDOWN
[kW/lbm is total delivered power divided by component or subsystem weight.]

System	kW/lbm	Percent total
Fuel cell system	1.23	24.1
Propulsion motor	3.73	8.0
Propulsion inverter and controller	5.95	5.0
Compressor motor, inverter, and controller	47.6	0.6
Power controls and/or electronics	0.98	30.2
Power delivery (cable, buses, etc.)	2.05	14.5
Fuel delivery	2.46	12.1
Fan/nacelle	5.32	5.6
Overall propulsion system	0.297	100.0

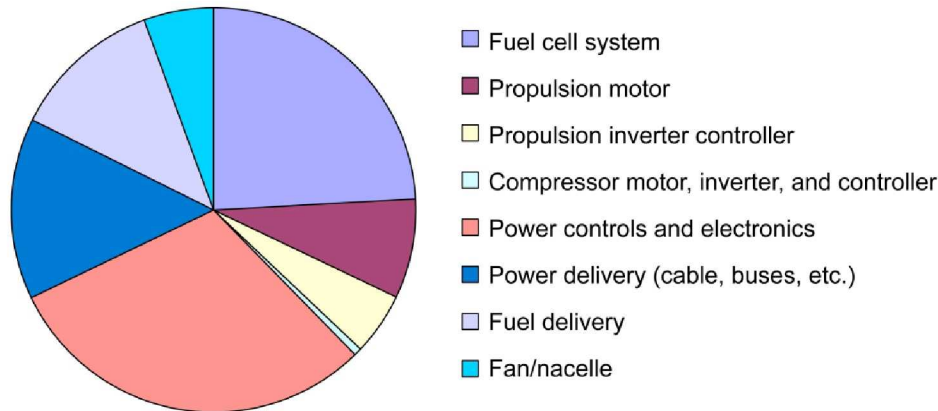

Figure 7.—Initial relative masses of hydrogen fuel cell propulsion system components.

TABLE IV.—UPDATED HYDROGEN FUEL CELL PROPULSION SYSTEM
BREAKDOWN

[kW/lbm is total delivered power divided by component or subsystem weight.]

System	kW/lbm	Percent total
Fuel cell system	1.23	31.2
Water-cooled radiator (new item, sized for cruise heat requirements with 55 percent of sea-level static value)	2.77	13.8
Propulsion motor, inverter, and controller	9.26	4.1
Compressor motor, inverter, and controller	47.6	0.8
Power management and distribution	0.983	39.0
Fuel delivery	10.0	3.8
Fan/nacelle	5.32	7.2
Overall propulsion system	0.383	100.0

Balance of plant.—Various ancillary systems are needed to support the PEM or SOFC systems. For aviation, Mach and altitude effects require compressors, heat exchangers, and potentially humidifiers for air handling and preparation before they enter the fuel cell stack. These systems are in addition to other thermal and power management, and air conditioning and distribution systems required for ground-based systems. Previous studies combined these weight estimates together in one factor for balance of plant. To reduce potential scaling errors in this effort and update the estimates for new knowledge, the weights for PMAD, electric motors, and thrust production systems were removed from the original balance-of-plant estimates and calculated separately. Calculating components separately and with new weight relationships resulted in a weight reduction for some components. The system weight breakdown was then updated with these new scaling parameters and is included in Table IV.

Radiators.—It was estimated that the PEM fuel cell stack would produce roughly as much low-grade heat as electrical power for propulsion. This amount of heat was too high to be removed using the liquid-hydrogen fuel or put into the entrance air or exhaust streams. Ideally, these streams could only remove about 15 percent of the low-quality waste heat generated. Therefore, additional heat exchangers are needed to remove heat from the PEM fuel cell stack itself.

Water cooling is typically used for PEM fuel cells because the water not only removes the low-grade heat, but also provides the necessary hydration of the fuel cell stack. A closed-loop water system is required for the fuel cell heat removal. The heat is then removed from the water using radiators, conceptually mounted under the wings for this application.

Parametric studies were performed to determine the radiator size and shape as well as to assess the radiator weight and volume. Although frontal drag loss was calculated for a radiator system, the actual design of the air-side inlet and nozzle, as well as vehicle integration, could greatly mitigate drag losses over some regions of the flight profile. Since such drag reduction and optimization iterations were beyond the scope of this study (and such losses were estimated to be small), such analyses are for subsequent efforts and are not included in this mission analysis and sizing.

The trade studies examined the effects of fuel-cell cooling water exit temperatures ranging from 353.15 to 473.15 K (80 to 200 °C) for a range of heat exchanger effectiveness, and also determined the overall impact on radiator weight. Using a lower water flow rate and allowing a higher fuel cell water-exit temperature significantly reduced radiator volume and weight. However, the upper limit for the water exit temperature was held at 473.15 K (200 °C), which is the maximum recommended operating temperature for PEM fuel cells. The fuel cells were assumed to be pressurized such to maintain water as liquid at 473.15 K (200 °C).

For this preliminary study, several simplifying assumptions were used to determine the radiator weight and geometry. The radiator was modeled as a multiple-finned tube heat exchanger with an overall heat transfer coefficient of 25 W/(m²-K) and an area-to-volume ratio of 270 ft²/ft³. These typical values are based on heat transfer recommendations for preliminary finned tube heat exchanger analysis. An automated routine was developed within the spreadsheet to converge on the solution. The routine method assumed an initial heat exchange effectiveness, calculated the airflow rate (based on air temperature) required to remove the heat, then determined the water flow rate required based on the water exit temperature and airflow rate. The required water flow and correlations from number of transfer units (NTU)-effective curves (Ref. 14) were used to determine the required heat exchanger area and resultant volume and weight. Figure 8 shows the effect of fuel-cell exit-water temperature on radiator weight for a range of heat exchanger effectiveness.

Electric motors and thrust production.—The electricity from the fuel cell still needs to generate thrust. It was assumed that electric motors would drive ducted fans. Conventional electric motors would be too heavy, but significant progress has been made on superconducting motors that have not only high efficiency (>99 percent), but also very reasonable sizes and weights for an aviation system. The electric motor size and weights used are given in Figures 9 and 10. They are based on a combination of actually demonstrated superconducting electric machine technology and advanced designs (Refs. 15 and 16). Assuming a conversion efficiency for hydrogen fuel into electrical energy for the HFC system, which determines the required fuel flow, one can estimate whether there is sufficient cryogenic liquid hydrogen flow available to cool the motors. This evaluation is based upon the enthalpy difference between liquid hydrogen entering and gaseous hydrogen leaving the motors at various exit temperatures and upon an assumed motor efficiency. The minimum required motor efficiency that permits coolant flow to be less than or equal to fuel flow is shown in Figure 11. Assuming that 99-percent-efficient electric motors would be available and the overall conversion efficiency for the HFC system is around 50 percent, it can be seen in Figure 11 that there would be enough cryogenic hydrogen available to cool the normally conducting stators of the motors (where most of the losses occur) to below approximately 40 K. The high-temperature superconductor (HTS) on the rotors (where only hundreds of watts per motor need to be absorbed) could be easily cooled to near 20 K by a separate parallel stream of liquid hydrogen, giving excellent HTS

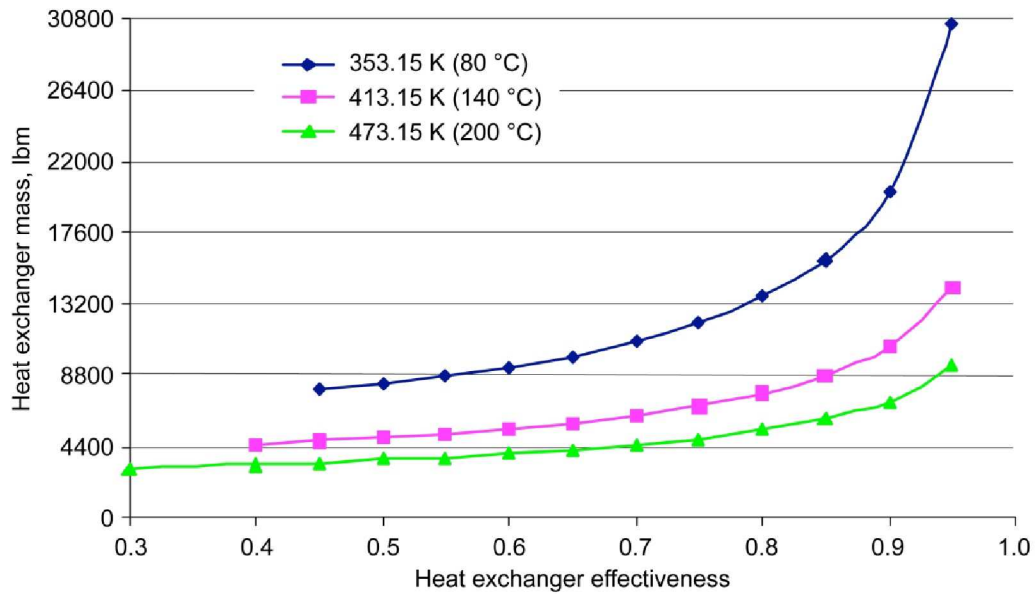

Figure 8.—Effect of water exit temperature and heat exchanger effectiveness on heat exchanger mass, with assumed constant overall heat transfer coefficient of 25 W/(m²-K).

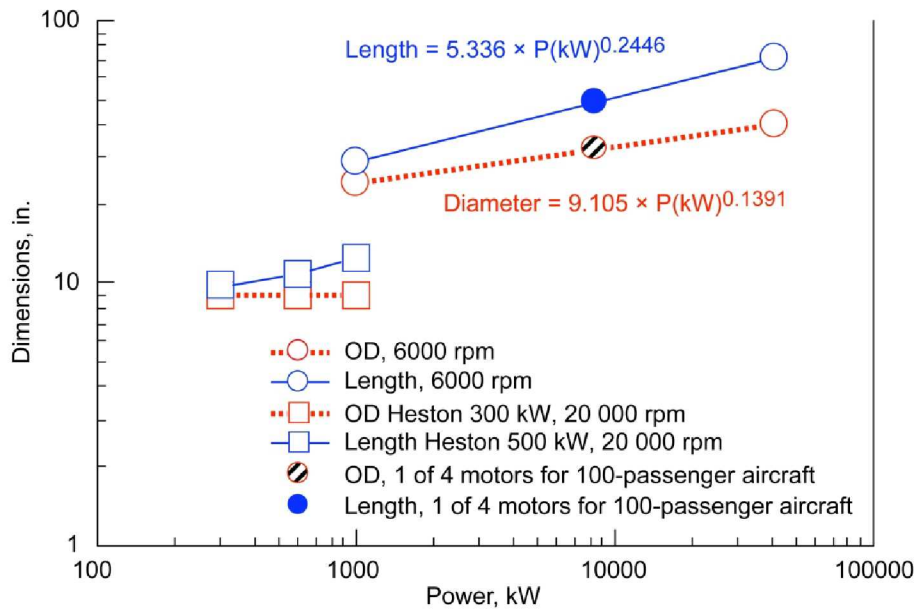

Figure 9.—Electric motor length and outer diameter (OD) versus power.

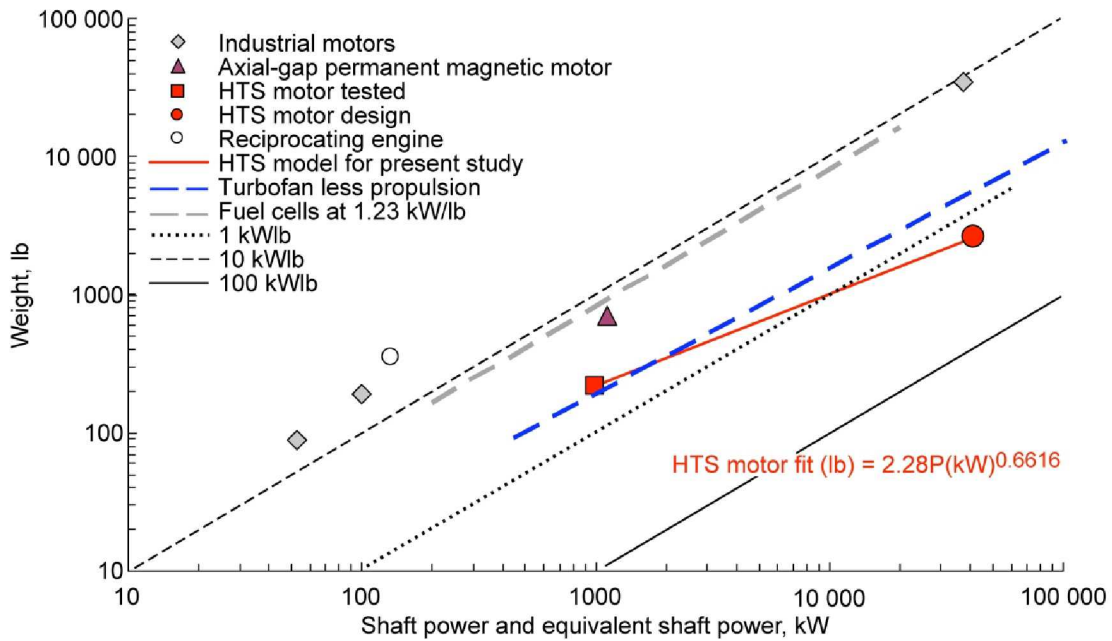

Figure 10.—Electric motor weight versus power (high-temperature superconductor (HTS)).

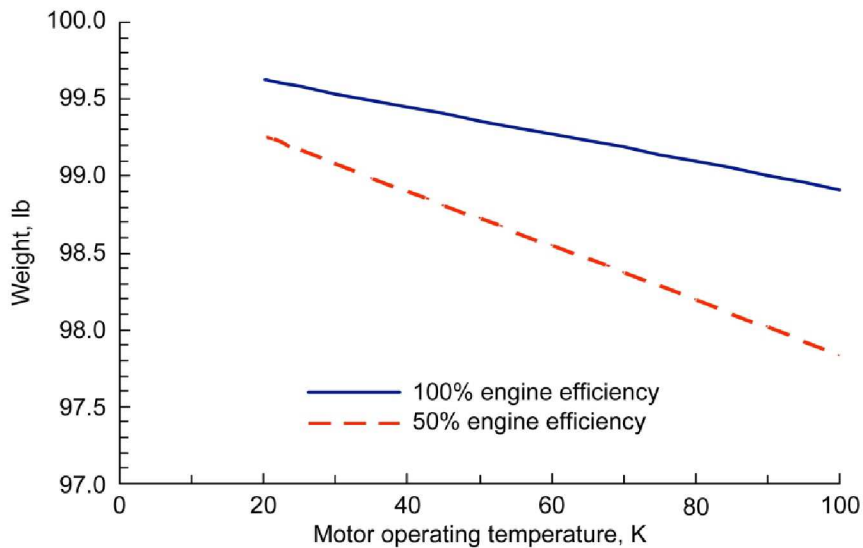

Figure 11.—Electric motor cooling requirements versus motor efficiency.

performance with either first-generation bismuth strontium calcium copper oxide (BSCCO) HTS conductor or second-generation yttrium barium calcium copper oxide (YBCCO) superconductor.

Power Management and Distribution.—PMAD is an important part of the fuel cell propulsion system. The raw electric power from the fuel cell must be conditioned and sent to the various electric motors to develop thrust. PMAD was sized based on achieving the overall system weight goal; a schematic for PMAD based on a fairly conservative layout is given in Figure 12, and its weight breakdown is given in Table V. Based on the overall HFC system-specific weight required for a viable system and the projected weight of the conservative layout, a truly revolutionary design would be required to meet weight goals. An

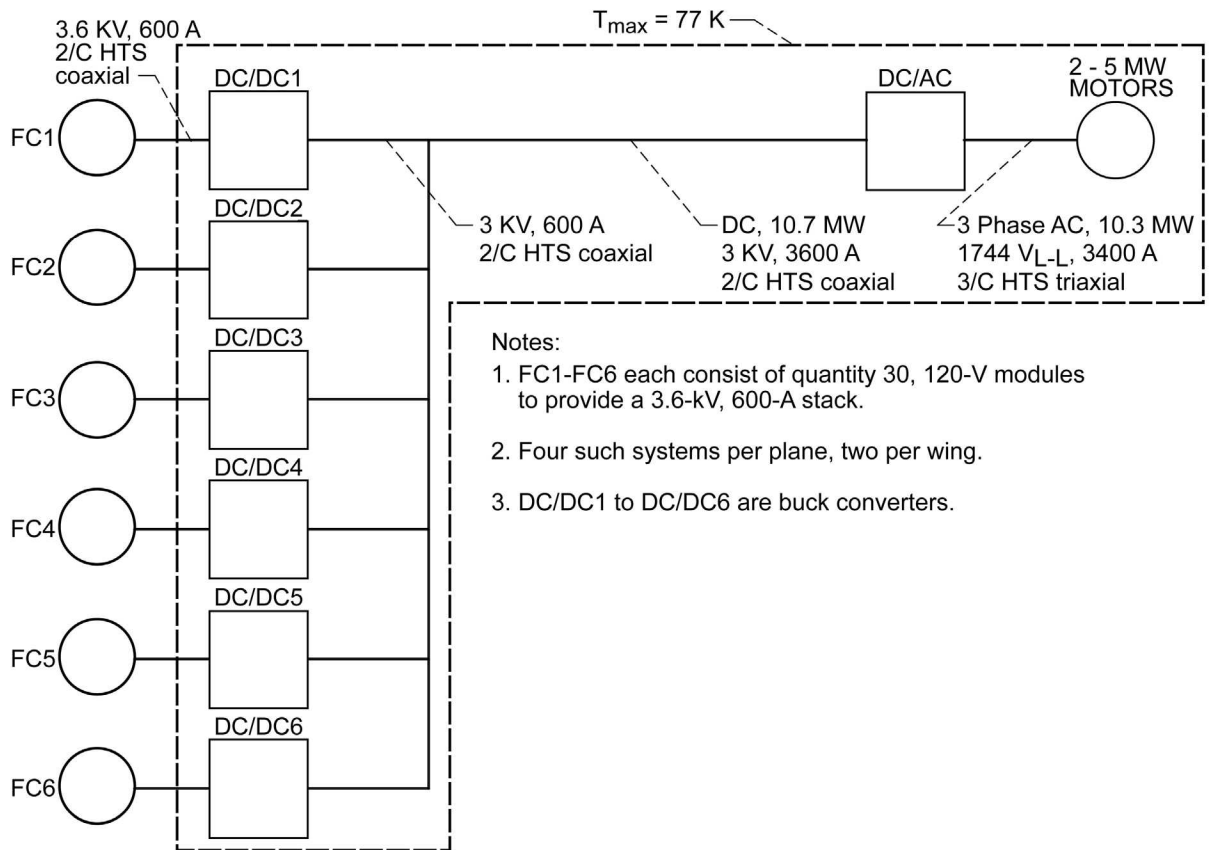

Figure 12.—Initial power management and distribution schematic for 100-passenger aircraft (one of four systems required to meet total power required) (high-temperature superconductor (HTS)).

TABLE V.—CONSERVATIVE POWER MANAGEMENT AND DISTRIBUTION SYSTEM COMPONENTS AND WEIGHTS

Description	Weight/unit	Quantity and/or length	Total, lbm
High-temperature superconductor (HTS) DC/DC converter	8800 lbm	6	52 800
HTS DC/AC converter	6120 lbm	1	6 120
Triaxial HTS cable	0.5 lbm/ft	4 ft	2
Coaxial HTS cable	0.14 lbm/ft	50 ft	7
HTS transitions	4.4	6	26
Total system, 10 MW delivered, 0.1696 kW/lbm			58 955

advanced, conceptual PMAD design that could approximately meet the weight goal is shown in Figure 13, with its weight breakdown given in Table VI. Research would be required to determine if such a system would be sufficient to properly condition the power between the fuel cells generating the electricity and the electric motors using it, as well as verifying if the weight estimates would be maintained from initial concept to actual final design. Other work on PMAD components have developed significantly better power-to-weight performance than some components assumed in this study that would meet and exceed the needed overall power-to-weight goals. However, questions about scaling those components up to the power levels required for this effort while maintaining high performance could not be addressed. These and other promising technologies need to be addressed in subsequent studies. Detailed analysis of PMAD thermal management was not performed. Estimates of available refrigeration from the cryogenic fuel (after it has

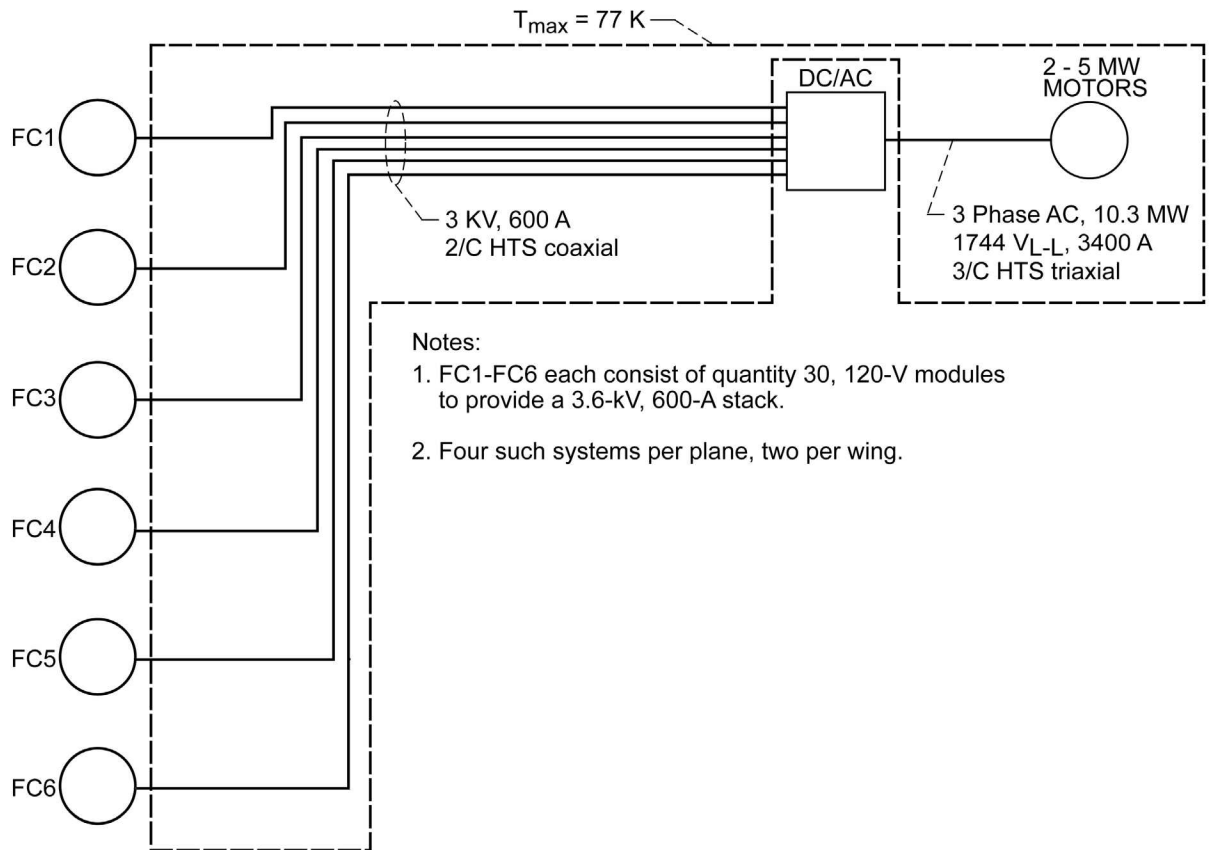

Figure 13.—Advanced, conceptual power management and distribution schematic for 100-passenger aircraft (one of four systems required to meet total power required) (high-temperature superconductor (HTS)).

TABLE VI.—ADVANCED, CONCEPTUAL POWER MANAGEMENT AND DISTRIBUTION SYSTEM COMPONENTS AND WEIGHTS

Description	Weight/unit	Quantity and/or length	Total, lbm
DC/AC converter	6133 lbm	1	6133
Triaxial high-temperature superconductor (HTS) cable	0.5 lbm/ft	4 ft	2
Coaxial HTS cable	0.14 lbm/ft	155 ft	22
HTS transitions	4.4	13	57
Total system, 10 MW delivered 1.609 kW/lbm			6214

cooled the propulsion motors) would be sufficient for PMAD cooling needs. Depending on system design, it is believed that further cooling of the inverters and electrical buses to low temperatures could significantly reduce PMAD weight, as well as raise its efficiency, but that would require verification and validation. Note that the weights in Tables V and VI are for one PMAD system, sized in power output such that four of these systems are required per 100-passenger-class aircraft that has a TOGW no more than 20 percent above the traditional kerosene-fueled, gas-turbine aircraft.

TABLE VII.—STUDY FINAL HYDROGEN FUEL CELL PROPULSION SYSTEM BREAKDOWN

[kW/lbm is total delivered power divided by component or subsystem weight.]

System	kW/lbm	Percent total
Fuel cell system	1.23	36.7
Water-cooled radiator (new item, sized for cruise heat requirements, 55 percent of sea-level static value)	2.77	16.3
Propulsion motor, inverter, and controller	9.26	4.9
Compressor motor, inverter, and controller	47.6	1.1
Power management and distribution	1.609	28.1
Fuel delivery	10.0	4.5
Fan/nacelle	5.32	8.5
Overall propulsion system	0.452	100.0

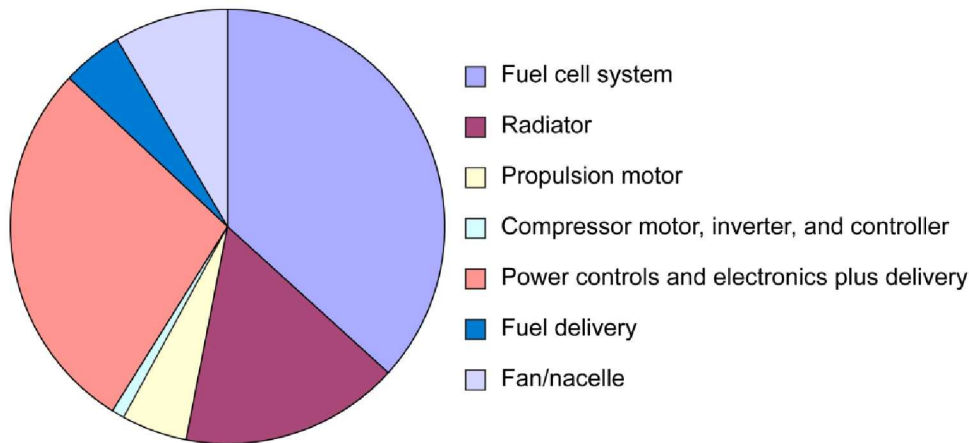

Figure 14.—Final relative masses of hydrogen fuel cell propulsion system components.

Summary of PEM Weight Performance

Based on the individual components, a final specific weight is given in Table VII, with the relative weights shown in Figure 14. Even with aggressive weight reductions in the ancillary systems, the PEM HFC propulsion system does not meet the desired specific weights needed for a viable aircraft (0.452 versus 0.526 kW/lbm required for only 20 percent growth in TOGW). Much more effort is needed to assess the design and layout of the fuel cell system (cell stacks, manifolds, propellant distribution, etc.) and PMAD to identify further potential weight reductions and focus further efforts.

Gas-Turbine Engine Assist of HFC System

Reviewing the flight profile for the 70- and 100-passenger aircraft, the following observations were made: cruise power is roughly half of the required takeoff power, a significant portion of the fuel is burned during cruise, and gas-turbine engines are presently much lighter for a given thrust than the HFC propulsion systems. If the HFC propulsion system could be sized for the cruise propulsion requirement and use gas-turbine engines to assist for the higher thrust takeoff and climb modes, propulsion system total weight could be reduced. The engine decks from the hydrogen gas turbine and HFC propulsion system were compared to develop multiplication factors for fuel consumption for the combined system as well as rough estimates for the overall propulsion system weight. These multiplication factors (input to the mission

TABLE VIII.—SEVENTY-PASSENGER AIRCRAFT PROPULSION SCALING FACTORS AND PROPULSION-SPECIFIC POWER AND THRUST

System	Scale factor, SFC ^a /SFC _{base}	Specific weight, lbm/kW	Specific power, kW/lbm	Specific thrust, lbf, thrust/lbm
Liquid hydrogen gas-turbine engine (baseline)	1.0	0.478	2.1	3.75
Liquid hydrogen proton exchange membrane (PEM) high-temperature superconductor (HFC)	0.615	2.212	0.45	0.805
Liquid hydrogen solid-oxide fuel cell (SOFC)	0.495	3.676	0.272	0.490
Fuel cell gas-turbine hybrid				
PEM fuel cell (assist)	0.792	1.345	0.74	1.338
SOFC (assist)	0.722	2.237	0.45	0.805

^aSpecific fuel consumption (SFC).

analysis as scale factors), would be applied to the baseline tables for engine weight and specific fuel consumption (SFC) to represent the performance of the hybrid propulsion system. Although these scaling factors were not as rigorous as the work for the gas-turbine cycles, it should give appropriate trends for overall propulsion system weight, fuel burn, and TOGW.

The weight and SFC scale factors applied to the hydrogen gas-turbine engine input to the mission analysis are given in Table VIII. Thrust was found to be similar for both gas-turbine engines and the HFC propulsion systems; therefore, the scale factor on thrust was 1. The PEM fuel cell generating electric power to drive a ducted fan would use less fuel than the hydrogen gas-turbine baseline, but weigh over four times as much (for the same thrust output), assuming the advanced concepts and designs with the HFC specific weight of 0.452 kW/lbm as previously discussed. A similar arrangement using SOFC would weigh over seven times as much, casting doubt on the analysis converging, much less for a viable aircraft. For the PEM fuel cell gas-turbine hybrid, using the gas turbine significantly increased the SFC versus PEM alone, but SFC was still better than the gas turbine alone. The hybrid system also significantly reduced overall specific weight versus PEM alone. For the SOFC gas-turbine hybrid, the fuel cell operates at such a high temperature, the gas-turbine components could also be used as a bottoming cycle to generate additional energy and thrust (enabling very low fuel consumption and high efficiency), but at a penalty in additional system weight and complexity. Specific weight was estimated assuming takeoff thrust was split between 55 percent SOFC and 45 percent gas turbine.

Aircraft Comparisons: Hydrogen, Kerosene, and HFC

Baseline Kerosene Versus Hydrogen Gas Turbine With Advanced Combustor

In the 100-passenger-class aircraft, the baseline kerosene versus hydrogen gas turbine is shown in Figure 15. As discussed previously, the rearranged passenger compartment provided liquid hydrogen storage in the fuselage, with relatively minor overall changes to fuselage length and diameter and TOGW. The use of hydrogen fuel totally eliminated carbon dioxide emissions from the aircraft, while suggesting an almost 95 percent reduction in total mission NOx emissions from the advanced kerosene baseline. This reduction is in addition to the 70 percent reduction in NOx emissions projected for the advanced kerosene combustor versus present state-of-the-art designs in the 100-passenger-class aircraft.

Similar results for the 70-passenger class are shown in Figure 16. The advanced hydrogen combustor was also predicted to reduce total mission NOx emissions by 95 percent from the advanced kerosene design. There was also a slightly greater decrease in TOGW than the 100-passenger class.

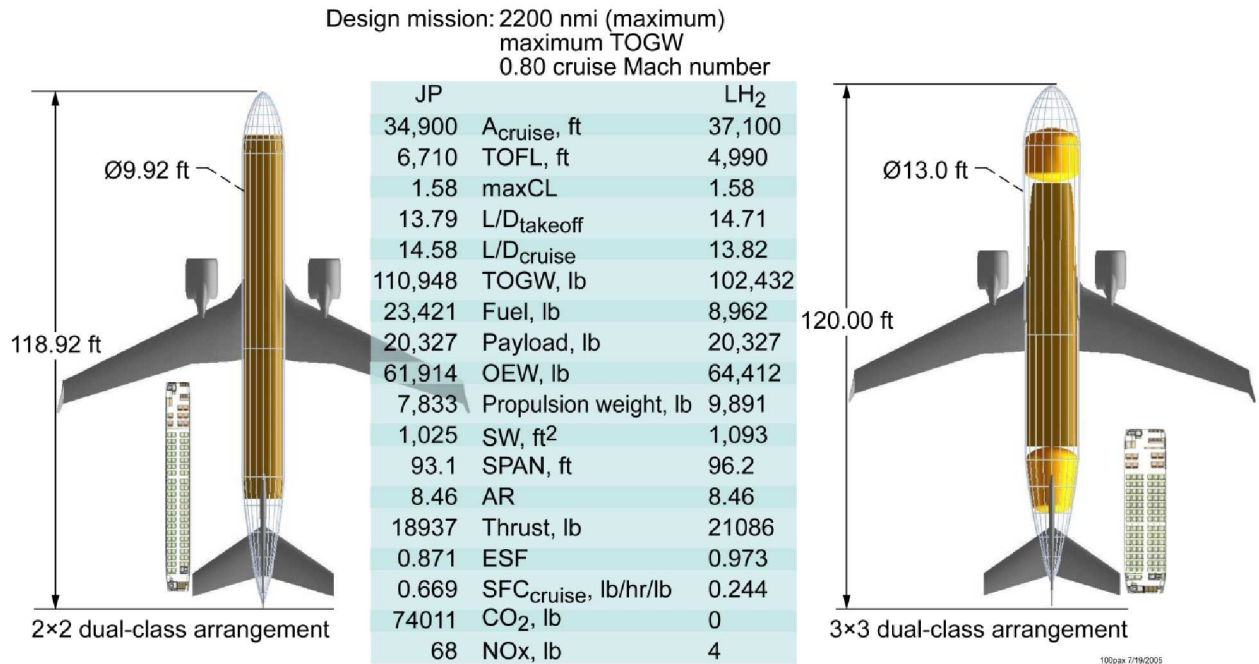

Figure 15.—Baseline kerosene (JP) versus liquid hydrogen (LH₂) gas-turbine size and overall parameters for 100-passenger aircraft (takeoff gross weight (TOGW), takeoff field length (TOFL), coefficient of lift (CL), lift over drag (L/D), operating empty weight (OEW), reference wing area (SW), altitude ratio (AR), engine scale factor (ESF), specific fuel consumption (SFC)).

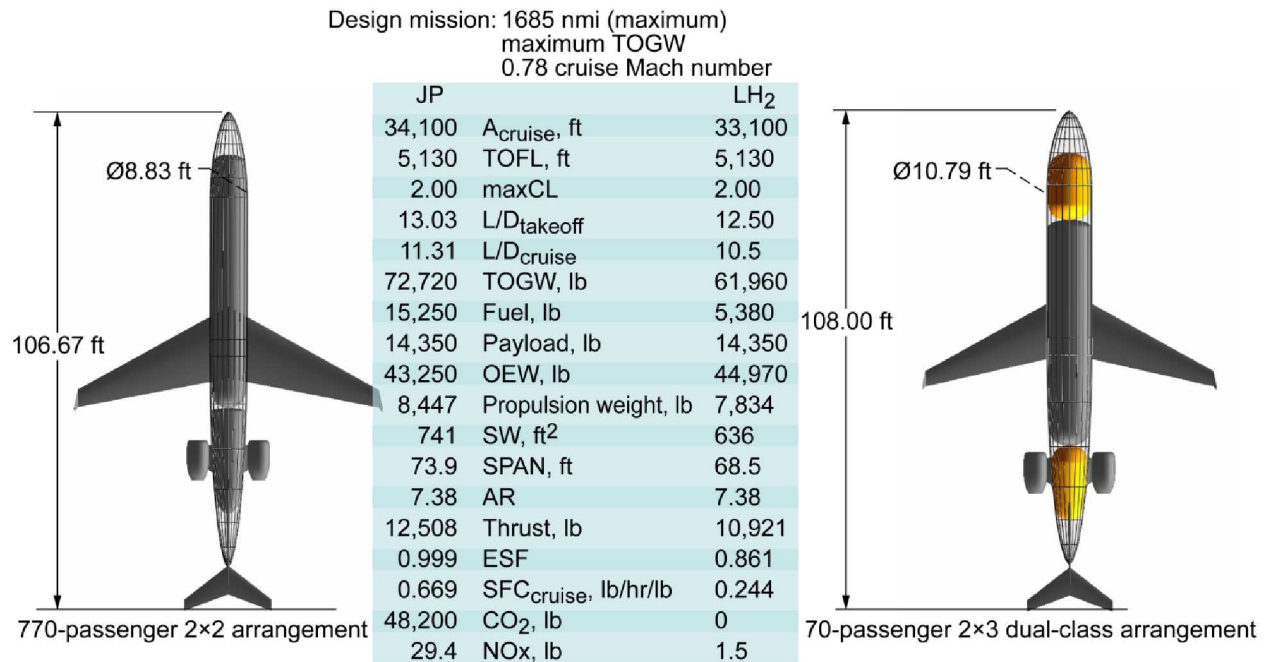

Figure 16.—Baseline kerosene (JP) versus liquid hydrogen (LH₂) gas-turbine size and overall parameters for 70-passenger aircraft (takeoff gross weight (TOGW), takeoff field length (TOFL), coefficient of lift (CL), lift over drag (L/D), operating empty weight (OEW), reference wing area (SW), altitude ratio (AR), engine scale factor (ESF), specific fuel consumption (SFC)).

TABLE IX.—PRELIMINARY MISSION AND AIRCRAFT SIZING RESULTS FOR 70-PASSENGER AIRCRAFT
 [Assuming the scaling factors for specific fuel consumption (SFC) and propulsion system specific power and thrust from Table VIII.]

Parameter	Propulsion type					
	Gas turbine, kerosene fuel	Gas turbine, liquid hydrogen fuel	Proton-exchange membrane (PEM) hydrogen fuel cell (HFC) ^a	PEM hydrogen fuel cell with gas-turbine assist	Solid-oxide fuel cell (SOFC) ^a	SOFC with gas-turbine assist ^a
Takeoff gross weight, lbm	72 500	62 300	102 000	79 500	164 000	103 000
Block fuel, lbm	19 400	6 830	6 680	6 795	8 530	7 740
Operating empty weight, lbm	43 100	45 500	85 300	62 600	146 000	85 400
Propulsion system weight, lbm	6 680	5 870	37 800	19 800	87 400	38 200
Cruise SFC lbm/hr-lbf	0.667	0.216	0.134	0.171	0.108	0.157

^aThese vehicle cases failed to meet takeoff field length, landing field length, and/or approach velocity constraints.

Preliminary Results of Gas-Turbine Assist

Using scale factors for SFC and specific weights from Table VIII for a notional 70-passenger-class aircraft propulsion system, some preliminary mission analyses were calculated; results are given in Table IX. For this aircraft size and mission, propulsion system weight was more important than SFC. Fuel cells, with their higher efficiency, can significantly reduce SFC, but at a significant increase in propulsion system and total vehicle weight relative to using only gas-turbine engines. The high specific weight for the PEM HFC alone and SOFC systems with or without gas-turbine assist increased propulsion and vehicle weight such that a valid, converged case could not be found that met takeoff field length, landing field length, and/or approach velocity constraints (these cases are noted in the table). With gas-turbine assist, the PEM HFC achieved a valid solution, meeting all constraints, but the improved SFC was penalized by a propulsion system weight increase of over 200 percent (from the baseline gas turbine). This resulted in almost no change in total fuel usage over the typical mission. Unless the HFC propulsion system weights can be improved, beyond the benefit of gas-turbine assist, they will not result in viable aircraft configurations.

Conclusions and Recommendations

Building on previous studies assuming hydrogen fuel cell propulsion systems for zero and near-zero emissions aircraft, additional analyses were performed assuming a conventional tube-and-wing airframe sized for 70 and 100 passengers with the major effort focused on the propulsion system. The study approach was to further define propulsion system components and configurations, identify shortfalls in present technology, and estimate required overall performance (mainly system weight per thrust) for a viable aircraft, and estimate the potential benefits incorporating various alternative and/or advanced technologies. Additionally, hydrogen gas turbines using advanced technology combustors, and hybrid systems, combining the hydrogen fuel cell with gas turbines, were investigated.

The results make a strong case for switching to a hydrogen-fueled, gas-turbine aircraft as a viable, near-term solution for major reductions in aircraft oxides of nitrogen (NO_x) emissions (especially if one assumes the transition to the hydrogen economy). To totally eliminate NO_x emissions, it would then be a more evolutionary transition to hydrogen fuel cell (HFC) technology for commercial aviation applications as it matures. The hybrid, gas-turbine HFC system does reduce propulsion weight from a HFC-only system, but still requires most of the HFC technology weight reductions identified, suggesting the hybrid system would not be a viable stepping point between gas turbine and HFC. Areas needing further design, analysis, and verification are noted; the fuel cell stacks and power management and distribution are areas requiring more effort, but potentially yielding some of the largest benefits.

Appendix—Acronyms

AR	altitude ratio
BSCCO	bismuth strontium calcium copper oxide
CL	coefficient of lift
ESF	engine scale factor
FLOPS	Flight Optimization System
HFC	hydrogen fuel cell
HSR	High-Speed Research
HTS	high-temperature superconductor
JP	kerosene
L/D	lift over drag
LLT	liquid level transducer
MLI	multilayer insulation
NO _x	oxides of nitrogen
NPSS	Numerical Propulsion System Simulation
OD	outer diameter
OEW	operating empty weight
PEM	proton exchange membrane
PMAD	power management and distribution
PT	pressure transducer
S	solenoid
SFC	specific fuel consumption
SOA	state of the art
SOFI	spray on foam insulation
SOFC	solid-oxide fuel cell
SW	reference wing area
TC	thermocouple
TOFL	takeoff field length
TOGW	takeoff gross weight
UEET	Ultra-Efficient Engine Technology
VSP	vehicle sketch pad
WATE	weight analysis of turbine engines
YBCCO	yttrium barium calcium copper oxide

References

1. Guynn, Mark D.; Freeh, Joshua E.; and Olson, Erik D.: Evaluation of a Hydrogen Fuel Cell Powered Blended-Wing-Body Aircraft Concept for Reduced Noise and Emissions. NASA/TM—2004-212989, 2004.
2. Guynn, Mark D.; and Olson, Erik D.: Evaluation of an Aircraft Concept With Over-Wing, Hydrogen-Fueled Engines for Reduced Noise and Emissions. NASA/TM—2002-211926, 2002.
3. Mazurkiewicz, Andrew; and Guynn, Mark D.: Feasibility Study of Fuel Cell Propulsion for Commercial Transport, Aerospace Systems Concepts and Analysis Competency. Unpublished NASA Langley intern research report, 2003.
4. Berton, Jeffrey J.; Freeh, Joshua E.; and Wickenheiser, Timothy J.: An Analytical Performance Assessment of a Fuel Cell-Powered, Small Electric Airplane. NASA/TM—2003-212393, 2003. <http://gltrs.grc.nasa.gov> Accessed Mar. 4, 2009.
5. Freeh, Joshua E., et al.: Electrical Systems Analysis at NASA Glenn Research Center: Status and Prospects. NASA/TM—2003-212520, 2003. <http://gltrs.grc.nasa.gov> Accessed Mar. 4, 2009.
6. Marek, Cecil; Smith, Timothy; and Kundu, Krishna: Low Emission Hydrogen Combustors for Gas Turbines Using Lean Direct Injection. AIAA—2005—3776, 2005.
7. McCullers, L.A.: Aircraft Configuration Optimization Including Optimized Flight Profiles. Proceedings of a Symposium on Recent Experiences in Multidisciplinary Analysis and Optimization, Part 1, NASA CP—2327, 1984, pp. 395–412.
8. Sullivan, Roy M., et al.: Engineering Analysis Studies for Preliminary Design of Lightweight Cryogenic Hydrogen Tanks in UAV Applications. NASA/TP—2006-214094, 2006. <http://gltrs.grc.nasa.gov> Accessed Mar. 4, 2009.
9. Brewer, G. Daniel: Hydrogen Aircraft Technology. CRC Press, Boca Raton, FL, 1991.
10. Tornabene, Robert, et al.: Development of Parametric Mass and Volume Models for an Aerospace SOFC/Gas Turbine Hybrid System. NASA/TM—2005-213819 (ASME GT2005—68334), 2005. <http://gltrs.grc.nasa.gov> Accessed Mar. 4, 2009.
11. Steffen, Christopher J., Jr.; Freeh, Joshua E.; and Larosiliere, Louis M.: Solid Oxide Fuel Cell/Gas Turbine Hybrid Cycle Technology for Auxiliary Aerospace Power. NASA/TM—2005-213586 (ASME GT2005—68619), 2005. <http://gltrs.grc.nasa.gov> Accessed Mar. 4, 2009.
12. Jones, Scott M.: An Introduction to Thermodynamic Performance Analysis of Aircraft Gas Turbine Engine Cycles Using the Numerical Propulsion System Simulation Code. NASA/TM—2007-214690, 2007. <http://gltrs.grc.nasa.gov> Accessed Mar. 4, 2009.
13. Onat, E.; and Klees, G.W.: A Method to Estimate Weight and Dimensions of Large and Small Gas Turbine Engines; Final Report. NASA CR—159481, 1979.
14. Holman, Jack Philip: Heat Transfer. 4th ed., McGraw-Hill, New York, NY, 1976.
15. Brown, Gerald V., et al.: NASA Glenn Research Center Program in High Power Density Motors for Aeropropulsion. NASA/TM—2005-213800 (ARL—MR—0628), 2005. <http://gltrs.grc.nasa.gov> Accessed Mar. 4, 2009.
16. Kascak, Albert; and Pham, Kimlan: Design of Lightweight High Power Motors and Generators for Electric Aircraft Propulsion. NAS3—02112, 2002.

REPORT DOCUMENTATION PAGE			Form Approved OMB No. 0704-0188		
<p>The public reporting burden for this collection of information is estimated to average 1 hour per response, including the time for reviewing instructions, searching existing data sources, gathering and maintaining the data needed, and completing and reviewing the collection of information. Send comments regarding this burden estimate or any other aspect of this collection of information, including suggestions for reducing this burden, to Department of Defense, Washington Headquarters Services, Directorate for Information Operations and Reports (0704-0188), 1215 Jefferson Davis Highway, Suite 1204, Arlington, VA 22202-4302. Respondents should be aware that notwithstanding any other provision of law, no person shall be subject to any penalty for failing to comply with a collection of information if it does not display a currently valid OMB control number.</p> <p>PLEASE DO NOT RETURN YOUR FORM TO THE ABOVE ADDRESS.</p>					
1. REPORT DATE (DD-MM-YYYY) 01-05-2009		2. REPORT TYPE Technical Memorandum		3. DATES COVERED (From - To)	
4. TITLE AND SUBTITLE Propulsion Investigation for Zero and Near-Zero Emissions Aircraft			5a. CONTRACT NUMBER		
			5b. GRANT NUMBER		
			5c. PROGRAM ELEMENT NUMBER		
6. AUTHOR(S) Snyder, Christopher, A.; Berton, Jeffrey, J.; Brown, Gerald, V.; Dolce, James, L.; Dravid, Narayan, V.; Eichenberg, Dennis, J.; Freeh, Joshua, E.; Gallo, Christopher, A.; Jones, Scott, M.; Kundu, Krishna, P.; Marek, Cecil, J.; Millis, Marc, G.; Murthy, Pappu, L.; Roach, Timothy, M.; Smith, Timothy, D.; Stefko, George, L.; Sullivan, Roy, M.; Tornabene, Robert, T.; Geiselhart, Karl, A.; Kascak, Albert, F.			5d. PROJECT NUMBER		
			5e. TASK NUMBER		
			5f. WORK UNIT NUMBER WBS 561581.02.08.03.13.03		
7. PERFORMING ORGANIZATION NAME(S) AND ADDRESS(ES) National Aeronautics and Space Administration John H. Glenn Research Center at Lewis Field Cleveland, Ohio 44135-3191			8. PERFORMING ORGANIZATION REPORT NUMBER E-16693		
9. SPONSORING/MONITORING AGENCY NAME(S) AND ADDRESS(ES) National Aeronautics and Space Administration Washington, DC 20546-0001			10. SPONSORING/MONITORS ACRONYM(S) NASA		
			11. SPONSORING/MONITORING REPORT NUMBER NASA/TM-2009-215487		
12. DISTRIBUTION/AVAILABILITY STATEMENT Unclassified-Unlimited Subject Categories: 01 and 07 Available electronically at http://gltrs.grc.nasa.gov This publication is available from the NASA Center for AeroSpace Information, 301-621-0390					
13. SUPPLEMENTARY NOTES					
14. ABSTRACT As world emissions are further scrutinized to identify areas for improvement, aviation's contribution to the problem can no longer be ignored. Previous studies for zero or near-zero emissions aircraft suggest aircraft and propulsion system sizes that would perform propulsion system and subsystems layout and propellant tankage analyses to verify the weight-scaling relationships. These efforts could be used to identify and guide subsequent work on systems and subsystems to achieve viable aircraft system emissions goals. Previous work quickly focused these efforts on propulsion systems for 70- and 100-passenger aircraft. Propulsion systems modeled included hydrogen-fueled gas turbines and fuel cells; some preliminary estimates combined these two systems. Hydrogen gas-turbine engines, with advanced combustor technology, could realize significant reductions in nitrogen emissions. Hydrogen fuel cell propulsion systems were further laid out, and more detailed analysis identified systems needed and weight goals for a viable overall system weight. Results show significant, necessary reductions in overall weight, predominantly on the fuel cell stack, and power management and distribution subsystems to achieve reasonable overall aircraft sizes and weights. Preliminary conceptual analyses for a combination of gas-turbine and fuel cell systems were also performed, and further studies were recommended. Using gas-turbine engines combined with fuel cell systems can reduce the fuel cell propulsion system weight, but at higher fuel usage than using the fuel cell only.					
15. SUBJECT TERMS Aircraft emissions; Aircraft engines; Gas turbine engines; Propulsion system; Fuel cell; Systems analysis; Propulsion modeling					
16. SECURITY CLASSIFICATION OF:			17. LIMITATION OF ABSTRACT	18. NUMBER OF PAGES 27	19a. NAME OF RESPONSIBLE PERSON STI Help Desk (email:help@sti.nasa.gov)
a. REPORT U	b. ABSTRACT U	c. THIS PAGE U			19b. TELEPHONE NUMBER (include area code) 301-621-0390

