

NASA Composite Materials Development: Lessons Learned and Future Challenges

Dr. Darrel R. Tenney
AS&M Senior Engineer (Retired NASA Engineer)
Analytical Services & Materials, Inc. 107 Research Drive, Hampton, Virginia 23666-1340
dtenney@asm-usa.com

Dr. John G. Davis, Jr.
AS&M Senior Scientist (Retired NASA Engineer)
Analytical Services & Materials, Inc. 107 Research Drive, Hampton, Virginia 23666-1340
jdavis@asm-usa.com

Dr. R. Byron Pipes
John L. Bray Distinguished Professor of Engineering
Purdue University, West Lafayette, IN 47907
bpipes@purdue.edu

Dr. Norman Johnston
Technical Consultant (Retired NASA Scientist)
30046 Creek Run, Buena Vista, CO 81211
normjohnston@realwest.com

NATO Research and Technology Agency (RTA)
AVT 164 - Support of composite systems
Fall 2009 – Bonn

Abstract

Composite materials have emerged as the materials of choice for increasing the performance and reducing the weight and cost of military, general aviation, and transport aircraft and space launch vehicles. Major advancements have been made in the ability to design, fabricate, and analyze large complex aerospace structures. The recent efforts by Boeing and Airbus to incorporate composite into primary load carrying structures of large commercial transports and to certify the airworthiness of these structures is evidence of the significant advancements made in understanding and use of these materials in real world aircraft. NASA has been engaged in research on composites since the late 1960's and has worked to address many development issues with these materials in an effort to ensure safety, improve performance, and improve affordability of air travel for the public good. This research has ranged from synthesis of advanced resin chemistries to development of mathematical analyses tools to reliably predict the response of built-up structures under combined load conditions. The lessons learned from this research are highlighted with specific examples to illustrate the problems encountered and solutions to these problems. Examples include specific technologies related to environmental effects, processing science, fabrication technologies, nondestructive inspection, damage tolerance, micromechanics, structural mechanics, and residual life prediction. The current state of the technology is reviewed and key issues requiring additional research identified. Also, grand challenges to be solved for expanded use of composites in aero structures are identified.

Introduction

Composite materials have emerged as the materials of choice for increasing the performance and reducing the weight and cost of military aircraft, general aviation aircraft, transport aircraft and space launch vehicles, Figure 1 (**Application of Composites on Flight Vehicles**). Major advancements have been made in the ability to design, fabricate, and analyze large complex aerospace structures. The recent efforts by Boeing and Airbus to incorporate composite into primary load carrying structures of large commercial transports and to certify the airworthiness of these structures is evidence of the significant advancements made in the understanding and use of these materials in real world aircraft. The weight fraction of the structure made with composites is 50% for the new Boeing 787— 100 percent composite on the “wet” or outer windswept surface, Figure 2 (**Composites in Commercial Transport Aircraft**). Airbus plans to market a medium-capacity, long-range A350 XWB (Xtra Wide Body) that is reported to have a significant amount of composites in the primary structure. Spirit AeroSystems Inc. (Wichita, Kan.) announced on May 14, 2008 that it has signed a contract with Airbus to design and produce the Section 15 center fuselage frame section, a composite structure that will be approximately 65 ft long by 20 ft wide (19.8m by 6.1m) and weigh nearly 9,000 lb/4,082 kg.

A high percentage of general aviation aircraft now feature composite airframes, such as the Cirrus Design (Duluth, Minn.) SR22 G3. Bombardier’s (Montreal, Quebec, Canada) new C Series family of 100- to 149-seat, single-aisle aircraft, re-launched in July 2008 at the Farnborough Air Show, is approximately 20 percent composite, including the center and rear fuselage, tail cone, empennage and wings. In Asia, a new 70- to 90-seat regional jet is under development by Mitsubishi Aircraft Corp., part of Mitsubishi Heavy Industries Ltd. (MHI, Tokyo, Japan). Launched in early 2008, the Mitsubishi Regional Jet (MRJ) is the first regional jet to adopt composite materials for its wings and vertical fins on a significant scale. Bombardier announced a new all-composite Learjet 85 in late 2007, with composite components slated to be fabricated in Mexico. Composites are the materials of choice for UAV airframes, regardless of the size. UAV wingspans range from commercial airliner-sized down to palm-sized micro flyers that support intelligence, surveillance and reconnaissance (ISR). High strength-to-weight, limited radar signature and signal transparency are the main drivers for selecting composites for UAV’s.

The application of high performance composite materials to military aircraft started with the use of boron/epoxy skins in the empennages of the F-14 (US Navy) and F-15 (US Air Force) fighters. Initial applications of composite materials to aircraft structures were in secondary structures such as fairings, small doors and control surfaces. As the technology matured, the use of composite materials for primary structures such as wings and fuselages has increased. The material usage in selected US military aircraft is shown in Figure 3 (**Composites in US Fighter Aircraft**). Composite materials are used not only to reduce weight, but also because these materials are corrosion and fatigue resistant and can be tailored to reduce radar cross-section. The modern military aircraft, such as the F-22, use composites for at least a third of their structures, and future military aircraft are likely to be more than two-thirds composite materials. Military aircraft use substantially greater percentages of composite materials than commercial passenger aircraft primarily because of more stringent performance requirements and operational issues. The limiting factor in the widespread application of these materials has been the high cost of fabricated structures compared to conventional metals.

For aircraft such as the B-2 stealth bomber minimization of the radar cross-section was the primary reason for the extensive use of carbon fiber composites. For helicopters where weight is a critical design criteria, composites have been extensively used for several decades. The V-22 uses composites for the wings, fuselage skins, empennage, side body fairings, doors, and nacelles. Approximately 50% of the airframe weight of a V-22 is composites. For the V-22, automated fiber placement technology was used to fabricate the aft fuselage skin in one piece resulting in a substantial cost savings over assembly of different skin panels proposed in early design studies.

Historical Background

The development of high performance composites has been a primary research activity of many different organizations world wide for more than 4 decades. In the United States the first research on high performance composites was conducted at the Air force Research Laboratory in Dayton, Ohio for military aircraft. NASA initiated work in composites in the late 1960's, but the effort was at a low level until Dr. Lovelace left the Department of Defense and joined NASA in September 1974 to become the Associate Administrator of the NASA Office of Aeronautics and Space Technology. He was instrumental in focusing a significant amount of the structures and materials base R&D to work on composites for commercial aviation and space launch vehicles. Since that time NASA has worked in collaboration with industry and universities to develop enabling technologies needed to make aircraft safer and more affordable, extend their lifetime, improve their reliability, better understand their behavior, and reduce their weight. To support these efforts, both base and focused R&D programs were conducted at the NASA Langley Research Center. The Base Research and Technology (R&T) program was focused on fundamental research that included: (1) synthesis of advanced polymers for matrices, adhesives, high performance polymer films, processing, and fabrication technology, (2) durability, damage tolerance, and reliability that focused on studying damage initiation and propagation in composites, development of damage models and analyses, test method development, fatigue behavior, progressive failure methodology, and durability testing of composite under simulated service conditions, (3) structural mechanics which focused on development of advanced light-weight structural concepts, development and verification of the underlying mechanics and design technologies for advanced aerospace structures, measurement of structural behavior under combined loads, damage tolerance methodologies, buckling and post buckling behavior, advanced analysis methods and design, analyses validation by tests of subcomponents and large-scale structures, and (4) non-destructive analyses (NDE) that focused on physics of measurement science, sensor and detectors development, new technique development, inspection methodologies, modifying the technology for specific applications and testing and validating, standards development, and application of inspection techniques to composite coupons and built-up structural elements.

Focused technology programs that supported composite research and development included: Composite Flight Service, Supersonic Cruise Research (SCR), Aircraft Energy Efficiency (ACEE), Composite for Advanced Space Transportation Systems (CASTS), Advanced Composite Technology (ACT), Graphite Fiber Risk Analyses, High Speed Research (HSR), Advanced General Aviation Transport Experiments (AGATE), Next Generation Launch

Technology (NGLT), Access to Space (X-33), Advanced Launch System (ALS), National Launch System (NLS), National AeroSpace Plane (NASP), Single Stage To Orbit (SSTO) Delta Clipper Experimental (DC-XA), Ares V, Ares I, and the NESC (NASA Engineering and Safety Center) Composite Crew Module. The technical accomplishments and lessons learned in these programs will be discussed in the following sections.

Each program contained specific focused R&D efforts that generally included: (a) selection of most promising material system and processing approach; (b) experimentation and analysis of small samples to characterize the system and quantify behavior in the presence of defects like damage and imperfections; (c) testing structural sub elements to examine buckling behavior, combined loadings, and built-up structures; and (d) testing complicated subcomponents leading up to tests of full scale or nearly full scale components. Detailed analysis, including tool development, was performed to prove that the behavior of these structures was well-understood and predictable. This approach for developing technology became known as the “building-block” approach and was used successfully in programs such as the Advanced Composites Technology Program (ACT) and the High Speed Research Program (HSR). Analysis techniques included closed-form solutions where possible, finite elements modeling, and a host of specialized codes developed to model processing or damage growth under cyclic loading conditions. The intent was to validate analysis predictions with experiments to insure that damage initiation, propagation and failure modes were adequately understood.

NASA Aeronautical Research Programs

Flight and Ground-Based Exposure of Composite Materials [Figure 4]

The influence of operational environment on the long-term durability of advanced composite materials and aircraft components fabricated from them is an ongoing concern of aircraft manufacturers and airline operators. Some of the uncertainties include the effects of moisture absorption, ultraviolet radiation, aircraft fuels and fluids, long-term sustained stress, fatigue loading and lightning strike. In the early 1970s the NASA Langley Research Center initiated base and focused research programs to establish the effects of flight environments and ground based exposure on several composite material systems. This was in response to one of the major recommendations from Project RECAST deliberations, that the government agencies should sponsor “fly and try” programs on primary and secondary composite structural components. Residual strength and stiffness as a function of exposure time were determined after 10 years of worldwide outdoor exposure. Service performance, maintenance characteristics, and residual strength of numerous composite components installed on commercial and military aircraft and helicopters were determined as a function of flight hours and years in service. Excellent in-service performance was demonstrated by data obtained over a 15 year evaluation period.

Overall, the composite components have performed better than conventional metallic structures because of reduced corrosion and fatigue problems. The effectiveness of the fiberglass isolation pads to prevent galvanic corrosion between graphite and metal parts was

demonstrated. Only modest decrease in compression and short beam shear strength was measured. Moisture absorption leveled out after about 3 years for the materials tested. Reduction in strengths due to hot/wet conditioning was observed. The magnitude of the reduction was significant and it was necessary to account for this reduction in the design process. Some operational maintenance concerns surfaced with the composite components during the 15 year service evaluation. Lightning strike damage was sustained on a DC-10 graphite/epoxy rudder and four B727 graphite/epoxy elevators indicating that more attention in future designs and installation of lightning protection schemes is warranted.

Good performance correlations between ground exposed material coupons and flight service components indicate that ground-based exposure data should be sufficient to predict long-term behavior of composite aircraft structures. It is important to note that at the coupon level, nothing new was learned from exposing materials on the aircraft that could not be learned from ground-based exposure.

Lessons Learned

1. Service experience of composite structures is better than conventional metallic structures.
2. Fewer corrosion and fatigue problems relative to conventional metallic structures can be expected.
3. Special attention is warranted in design and installation of lightning protection schemes.

Reference:

1. Dexter, H. B.; and Baker, Donald J.: Flight Service Environmental Effects on Composite Materials and Structures. AGARD Report 785, Oct. 1991.

ACEE Developed Composite Components Placed in Flight Service [Figure 5]

Components designed, developed, subjected to verification tests and certified to FAA requirements under the NASA ACEE program included:

- Ten graphite/epoxy B727 elevators.
- Ten B737 graphite/epoxy horizontal stabilizers
- Lockheed L-1011 composite aileron
- Fifteen graphite/epoxy DC-10 upper aft rudders
- One graphite/epoxy DC-10 vertical stabilizer

Lessons Learned:

1. A building block approach was essential for understanding structural performance and developing the database required to support FAA certification.
2. Experience gained in R&D programs does not readily transfer to production unless the people with the R&D experience participate actively in the production development.
3. Concerns over potential damage from hail and run way debris identified “damage tolerance” and “barely visible damage” as major problems to be addressed.

Reference:

1. Dow, Marvin B.: The ACEE Program and Basic Composites Research at Langley Research Center (1975 to 1986). NASA PR 1177, October 1987.
2. Vosteen, Louis F.: and Hadcock, Richard N.: Composite Chronicles: A Study of the Lessons Learned in the Development, Production, and Service of Composite Structures. NASA CR 4620, Nov. 1994.

NASA Composite Structures Flight Service Summary [Figure 6]

Four types of transport aircraft are flying composite components in the NASA Langley service evaluation program. Eighteen Kevlar-49/epoxy fairings have been in service on Lockheed L-1011 aircraft since 1973. In 1982, eight graphite/epoxy ailerons were installed on four L-1011 aircraft for service evaluation. One hundred and eight B737 graphite/epoxy spoilers have been in service on seven different commercial airlines in worldwide service since 1973. Ten B737 graphite/epoxy horizontal stabilizers have been installed on five aircraft for commercial service. Fifteen graphite/epoxy DC-10 upper aft rudders have been in service on twelve commercial airlines and three boron/aluminum aft pylon skin panels were installed on DC-10 aircraft in 1975. One graphite/epoxy vertical stabilizer was installed on a DC-10 aircraft in 1987. Ten graphite/epoxy elevators have been in service on B727 aircraft since 1980. In addition to the commercial aircraft components, two boron/epoxy reinforced aluminum center-wing boxes have been in service on U.S. Air Force C-130 transport aircraft since 1974. More than two dozen transport airlines/operators participated in the NASA Langley flight service program.

Three types of helicopters are flying composite components in the NASA Langley/U.S. Army service evaluation program. Forty shipsets of Kevlar-49/epoxy doors and fairings and graphite/epoxy vertical fins have been installed on Bell 206L commercial helicopters for 10 years of service evaluation. Ten graphite/epoxy tail rotors and four hybrid Kevlar-49-graphite/epoxy horizontal stabilizers were removed periodically from Sikorsky S-76 production helicopters to determine the effects of realistic operational service environments. A Kevlar-49/epoxy cargo ramp skin was installed on a U.S. Marine Corps CH-53D helicopter for service evaluation. Fifteen airlines and operators participated in evaluation of the helicopter composite components.

A total of 350 composite components were placed in service. As of June 1991, 139 components were still in service; more than 5.3 million component flight hours had been accumulated, with the high-time aircraft having more than 58,000 flight hours. Some components were removed from service for residual-strength testing, and others were retired due to damage or other service-related problems. (Update from table, one of the B737 horizontal stabilizers had accumulated 31,306 hours and 30,806 landings by May 1995.) For the first several years of the flight service evaluation program, the composite components were tracked and inspected by aircraft manufacturer engineering personnel. Later in the program, maintenance and repair data were obtained from the airline maintenance personnel. Repair procedures that were approved by the FAA were developed and utilized.

Overall, the composite components have performed better than conventional metallic structures because of reduced corrosion and fatigue problems.

Lessons Learned:

1. Properly designed and manufactured composite structures can withstand long term airline operations.
2. Reduction in mechanical properties of coupons cut from flight components was less than the reduction measured on ground exposed coupons.
3. Both short term metallic and longer term (composite or metallic) repairs are needed to accommodate a wide range of accidents and site locations.

Reference:

1. Dexter, H. B. and Baker, Donald J.: Flight Service Environmental Effects on Composite Materials and Structures. AGARD Report 785, Oct. 1991.

Advancements in Epoxy Composites Over Four Decades [Figure 7]

The two decades starting with 1960 can be labeled as the age of brittle epoxy matrix resins and composites. The following two decades led to many advances in composites toughening technologies that were critical to improving the impact damage tolerance of high performance composites to the point where they could be employed in primary load carrying structures. Figure 7 shows a general time line of some of the major advancements. NASA LaRC was a partner in many of the advances and selected highlights of that work are described below.

Major Problem: Damage Tolerance [Figure 8] and Tests for Interlaminar Fracture Toughness of Composite Laminates [Figure 9]

The major eye-opener that the polymer matrix composites of the 1960s and 1970s (especially the commercial epoxy matrix composites) had major damage tolerant problems came from the work of Williams, Starnes, and Rhodes at NASA LaRC on the effect of projectile impact on compression strength. [1- 5] An example is given in Figure 8 where compression strain is plotted against impact energy. Even with low impact energies where the damage is not visible, the drop in compression strain is significant. A photograph of the edge of an impacted brittle epoxy (5208) composite shows ply delamination like a deck of cards, Figure 8, right. A closer view of this delamination is also shown, left photo, while matrix cracking can be seen through out all the plies in the right photo. A photograph of the edge of an impacted toughened model epoxy (BP907) composite is also shown, bottom right, where a different failure mode, transverse delamination, is observed.

It became obvious that delamination-resistant toughened composites were needed in the commercial aeronautics community. The question was: how could they be developed? One approach was to create inserts such as stitches that would hold the plies together under impact even if the matrix resin would crack. This approach, developed in-depth by LaRC, is discussed below. NASA LaRC's work on textile composites is also discussed below. Another insert approach, placing tough plastic layers between selected plies in a laminate, was not successful. However, the selective insertion of rubber particles provided an approach still in use today and is discussed below.

Another approach examined was to develop toughened crack-resistant matrices. The chemistry was available and so were methods to measure fracture energy in neat resin blocks, including

Charpy and Izod impact procedures as well as a compact tension test that was by far the most reliable and gave (G_{Ic}) values [6]. Tables of resin (G_{Ic}) values can be found in the literature. [e.g., 7, 9, 10] The need was to develop composite interlaminar fracture tests in tension (G_{Ic} and K_{Ic}) and shear (G_{IIc} and K_{IIc}). Four were developed and are shown in Figure 9. The more complex compression after impact, open hole tension, and open hole compression tests were added as part of the ACEE program at LaRC [8].

The double cantilever beam tension test for G_{Ic} values using a unidirectional laminate was perfected by Dr. Donald Hunston at NIST [9, 10]. The mixed tension/shear mode that yielded G_{Ic} values from a $30^\circ/90^\circ$ layup was developed by Dr. T. Kevin O'Brien at LaRC [11-17]. The cracked lap shear unidirectional specimen was also a mixed tension/shear test which was not popular. The end-notched flexure test on a unidirectional specimen gave a pure shear value.

The next step was to develop relationships between polymer structure and neat resin fracture toughness. This relationship was then extended to neat resin versus composite fracture toughness. Thus, an efficient screening mechanism was established whereby one could identify tough matrices without fabricating laminates, the latter a procedure often complicated by serious processing difficulties, depending on other key properties of the resin to be evaluated. The fracture energy of the resin, (G_{Ic}), versus the tensile fracture energy of the composite, (G_{Ic}), was measured for a series of brittle epoxies used in commercial programs (5208, 3501-6, 3502), some model epoxies (HX-205 and F155), selected thermoplastics such as Udel P1700 polysulfone, Torlon polyamideimide, Ultem polyetherimide, and Lexan polycarbonate followed by F185, an experimental toughened epoxy [10, 11, 18]. It was found that the fracture energy values for neat resins did not translate directly into composite values.

The next screening relationship established was compression strain after impact versus composite G_{Ic} and G_{IIc} . Results of the work are reported in references [19, 20]. The standard or desired strain value after impact was set by the structures group at 0.006 (approximately 50 ksi strength) so the goal for new resin development was set by the polymer group at 4 in-lb/in² (700 J/m²). This was the guideline proposed to the composites community for the commercial development of new toughened composites.

Of all the methods developed for toughening thermoset matrices such as epoxies, the addition of a second phase coupled with controlling the length between cross-links was most popular. Studies on model toughened epoxies were undertaken to understand the mechanism(s) of polymer toughening and help guide the synthesis of new systems. Micrographs of fracture surfaces of a second phase toughened F185 [21], showed tiny rubber particles on the surface and rubber particles and micro-voids or micro-cavities in the bulk. An untoughened HX205 displayed neither, as expected.

Several mechanisms were proposed for energy absorption [22-24]. Some of the second phase rubber particles in the resin were exposed during fracture; some dilate and then cavitate to form voids or cavities lined with rubber. The main phase material between the voids shear yields and a large plastic zone is created. The crack propagates through this zone. Essentially, the rubber nucleates voids, concentrates stresses, blunts the crack tip, and causes shear deformation and plastic flow.

The LaRC guidelines for resin and composite G_{Ic} values cited above and some limited understanding of toughening mechanisms ultimately led the polymer chemists to develop three commercial materials: Toray 3900-2/T800H, ICI 977/IM7, and Hercules 8551-7/IM7. Two are the major 350°F composites still in use today: the Toray and ICI (now Cytec) materials. They are based on the two toughening approaches discussed above: second phase addition and selective insertion of rubber particles. The ICI/Cytec 977 composite (matured to the 977-2 and 977-3 derivatives available today) uses a co-continuous second phase for toughening. The compression after impact (CAI) and G_{Ic} values given in the table indicate that the ICI chemists [25] were aware of the LaRC guidelines.

The Hercules 8551-7 composite drew heavily on the LaRC CAI work and the mechanism of delamination failure in brittle composites [26]. Rubber or plastic particles larger than the diameter of the carbon fiber reinforcement were inserted at the ply-ply interfaces during prepreg fabrication and subsequent lay-up and bagging of the uncured billet. They tended to blunt the crack tip at the ply interfaces and discourage delamination. While the CAI values were high, the G_{Ic} values were lower simply because crack propagation in the double cantilever beam specimen would not always travel continuously at the ply interface but would wander into the resin which was only partially toughened by a small amount of a second soluble component such as a thermoplastic.

Lessons Learned:

1. Basic R&D at LaRC on the effect of impact on compression properties of composites and on understanding the relationship between CAI and resin and composite fracture toughness supported the commercial development of the toughened composites in use today.
2. This high risk, basic R&D was managed and supported because it met critical application needs down the road and was utilized by the commercial aerospace community even when composites were not considered as serious replacements for primary structure. It was critical that the structures and materials research scientists were given the freedom to pursue risky solutions to problems of serious importance even though the application of those solutions could be in the far future.
3. The use of professional society meetings such as the Society for the Advancement of Materials and Process Engineering (SAMPE) via professional talks, printed papers (refereed or not) and informal discussions helped to spread the word about the LaRC guidelines and research on toughening resins. Use of NASA personnel as consultants was a very useful tool for implanting and promoting our research into commercial labs.
4. Developing goals, guidelines (e.g., specific numbers), and measuring devices for making those guidelines are part of the research process.
5. Patents for the research developed at LaRC in this area would have been counterproductive to the development of toughened composites.

Future Directions

1. More requirements will be placed on toughened composites as new applications emerge such as cryo fuel tanks, large aerospace structures, space orbiting components, and lunar habitats. Many of these are enabling if composite materials are going to be utilized to the fullest. These requirements include:

- microcrack resistance from cryo to elevate temperature
- non-autoclave processing
- resistance to space radiation, both galactic and solar
- operations at temperatures higher than are now in use

Most likely, at the same time, toughness must be maintained!

2. Other approaches to composite toughening should be explored including insertion of pins, rods, fibers, and nanostitching that would prevent or discourage delamination.

3. Develop self-healing technology to the point that it can be applied to real-world composite applications.

4. Develop Computational Chemistry technology to the point where an understanding exists between fracture energy and molecular polymer chemistry. This would be the ultimate screening tool; the polymer structure of a toughened resin can be predicted without the need to synthesize that polymer. Conversely, the fracture energy of a theoretical polymer structure could be predicted. These computational skills should also be extended to predict other more classical polymer properties.

References:

1. Rhodes, M. D., Williams, J. G., and Starnes, J. H., Jr., "Effect of Low-Velocity Impact Damage On the Compressive Strength of Graphite-Epoxy Hat-Stiffened Panels," NASA Technical Note, NASA TN D-8411, April 1977.
2. Rhodes, M. D., Williams, J. G., and Starnes, J. H. Jr., "Low-Velocity Impact Damage in Graphite-Fiber Reinforced Epoxy Laminates," Reinforcing the Future; 34th Annual Conference, New Orleans, LA, Jan. 30-Feb 2, 1979; SPI, New York, 1979, pp. 20D1-20D10.
- 3a. Rhodes, M. D. and Williams, J. G., "Concepts for Improving the Damage Tolerance of Composite Compression Panels," Fifth Conference of Fibrous Composites in Structural Design, New Orleans, LA, Jan. 27-29, 1981; NASA TM 85748, February 1984.
- 3b. Williams, J. G. and Rhodes, M. D., "Effect of Resin on Impact Damage Tolerance of Graphite/Epoxy Laminates," Composite Materials: Testing and Design (Sixth Conf.), ASTM STP 787. I. M. Daniel, Ed. American Society for Testing and Material, 1982, pp. 450-480.
4. Starnes, J. H. Jr. and Williams, J. G., "Failure Characteristics of Graphite-Epoxy Structural Components Loaded in Compression," Mechanics of Composite Materials: Recent Advances, Proceedings of the Symposium, Blacksburg, VA, August 16-19, 1982; New York and Oxford, Pergamon Press, 1983, pp. 283-306.

5. Sohi, O. M., Hahn, H. T., and Williams, J. G., "The Effect of Resin Toughness and Modulus on Compressive Failure Modes of Quasi-Isotropic Graphite/Epoxy Laminates," NASA TM-87604, March 1986. Also in ASTM, Philadelphia, PA, 1987, pp. 37-60
6. Hinkley, J. A., "Small Compact Tension Specimens For Polymer Toughness Screening," J. Appl. Polym. Sci., 32, 1986, pp. 5653-5655.
7. Johnston, N. J.; Towell, T. W. and Hergenrother, P. M.: Physical and Mechanical Properties of High-Performance Thermoplastic Polymers and Their Composites, Thermoplastic Composite Materials, Carlsson, L. A., ed., Elsevier Scientific Publishing Co., 1991, pp. 27-71.
8. Anon, "Standard Tests for Toughened Resin Composites, Revised Edition," NASA Reference Publication 1092, July 1983.
9. Hunston, D. L., "Composite Interlaminar Fracture: Effect of Matrix Fracture Energy," Composites Technology Review, 6, no. 4, 1984, pp.176-180.
10. Hunston, D. L., Moulton, R. J., Johnston, N. J. and Bascom, W. D., "Matrix Resin Effects in Composite Delamination: Mode I Fracture Aspects." ASTM STP 937, 74-94 (1987).
11. O'Brien, T. K., Johnston, N. J., Morris, D. H. and Simonds, R. A., "A Simple Test for the Interlaminar Fracture Toughness of Graphite-Epoxy Laminates," 27th National SAMPE Symposium and Exhibition; Science of Advanced Materials and Process Engineering Series, 28, 401-415 (1982). Symposium best paper award. SAMPE Journal, 18 (4), 8-15 (1982).
12. Johnston, N. J.; O'Brien, T. K.; Morris, D. H. and Simonds, R. A.: Interlaminar Fracture Toughness and Fracture Toughness of Composites II. Refinement of the Edge Delamination Test and Application to Thermoplastics. 28th National SAMPE Symposium and Exhibition; Science of Advanced Materials and Process Engineering Series, 28, 502-517 (1983).
13. O'Brien, T. K.; Johnston, N. J.; Morris, D. H. and Simonds, R. A.: Determination of Interlaminar Fracture Toughness and Fracture Mode Dependence of Composites Using the Edge Delamination Test. International Conference on Testing, Evaluation, and Quality Control of Composites, University of Surrey, Guildford, England, Sept. 1983; Proceedings, T. Feest, ed., Butterworth Scientific Ltd., Kent, England, 222-232; NASA TM857-28 (November 1983).
14. O'Brien, T. K.; Johnston, N. J.; Raju, I. S.; Morris, D. H.; and Simonds, R. A.: Comparisons of Various Configurations of the Edge Delamination Test for Interlaminar Fracture Toughness. ASTM Symposium on Toughened Composites, Houston, TX, March 13-15, 1985, NASA TM 86433 (July 1985); USAAVSCOM TM 85-B-3.
15. O'Brien, T. K.; Johnston, N. J.; Raju, I. S.; Morris, D. H. and Simonds, R. A.: Comparisons of Various Configurations of the Edge Delamination Test for Interlaminar Fracture Toughness. ASTM STP 937, 199-221 (1987).
16. Hinkley, J. A.; Johnston, N. J.; and O'Brien, T. K.: Interlaminar Fracture Toughness of Thermoplastic Composites. Presented at ASTM Symposium on Advances in Thermoplastics Matrix Composite Materials, Bel Harbour, Florida, October 18-20, 1987, NASA TM 100532, AVSCOM TM 88-B-002.
17. Hinkley, J. A.; Johnston, N. J., and O'Brien, T. K.: Interlaminar Fracture Toughness of Thermoplastic Composites. Advances in Thermoplastic Matrix Composite Materials, ASTM STP 1044, 251-263 (1989).

18. Johnston, N. J.: Synthesis and Toughness Properties of Resins and Composites. Selected NASA Research in Composite Materials and Structures, ACEE Composite Structures Technology Conference, Seattle, Washington, August 13-16, 1984; NASA CP-2321, 75-95 (1984).
19. Unpublished results: Williams, J. A., O'Brien, T, K., and Johnston, N. J., NASA Langley Research Center, 1984.
20. Johnston, N. J. and Hergenrother, P. M.: High Performance Thermoplastics: A Review of Neat Resin and Composite Properties. International SAMPE Symposium and Exhibition. Science of Advanced Materials and Process Engineering Series, 32, 1400-1412 (1987). Symposium best paper award; NASA TM-89104, February 1987.
21. Unpublished results: Johnston, N. J., NASA Langley Research Center, 1984.
22. Yee, A. F. and Pearson, R. A., "Toughening Mechanisms in Elastomer-Modified Epoxy Resins-Part 1 Mechanical Studies," NASA CR-3718, August 1983; J. Mat. Sci., 21 (1986) 2462-2474
23. Pearson, R. A., and Yee, A. F., "Toughening Mechanisms in Elastomer-Modified Epoxy Resins-Part 2 Microscopy Studies," J. Mat. Sci., 21 (1986) 2475-2488.
24. Pearson, R. A. and Yee, A. F., "The Effect of Cross-link Density on the Toughening Mechanism of Elastomer-Modified Epoxies," Polymer Materials Science and Engineering, 19, 1983, p. 316; Pearson, R. A., and Yee, A. F., "Toughening Mechanisms in Elastomer-Modified Epoxy Resins-Part 3 The Effect of Cross-Link Density," J. Mat. Sci., 21 (1986) 2571-2580.
25. Unpublished discussions with P. T. McGrail, ICI Laboratories, Wilton, England, 1987; MacKinnon, A. J., Jenkins, S. D., McGrail, P. T., and Pethrick, R. A., "A Dielectric, Mechanical, Rheological, and Electron Microscopy Study of Cure and Properties of a Thermoplastic-Modified Epoxy Resin," Macromolecules, 25, 1992, pp. 3492-3499.
26. Unpublished discussions with Hercules' chemists, NASA Langley Research Center, Hampton, VA, 1987.

Aero Structural Composites Fabrication Technology [Figure 10]

In the 1970's, the research focus at NASA Langley was on hand lay-up fabrication processes, structural performance and flight demonstrations of secondary composite structures for transport aircraft. In the 1980's, the research focus changed to damage tolerant design concepts, toughened-epoxy and thermoplastic resin development, advanced tape placement machines, and the further development of secondary composite structures for transport aircraft. In the 1990's, the research focus changed to cost effective and damage-tolerant primary composite structures for transport aircraft. This change led to the development of automated fiber placement machines, damage-tolerant textile material forms and liquid molding processes, such as the resin transfer molding (RTM), resin film infusion (RFI), and vacuum-assisted resin transfer molding (VARTM) processes. In addition, high-speed automated and robotic material-placement processes and low-cost out-of-autoclave tooling and processing concepts were explored to address future economic challenges. Structural analysis and design methods were also developed that reliably predicted the response and failure characteristics of the composite structures fabricated by these advanced low-cost fabrication processes [1].

Liquid molding processes were also studied at NASA Langley because these processes offered the opportunity to use resins and fibers in their lowest-cost state by eliminating the pre impregnation (prepreg) step in the fabrication process and by minimizing material scrap. Liquid molding processes have been used extensively in the boat building industry [2], but until recently these processes have been highly labor intensive. The development of near-net-shape damage-tolerant textile preforms during the last decade, and the development of innovative resin transfer tooling concepts, has led to an interest in textile-reinforced composite structures for transport aircraft applications.

NASA Langley has evaluated several textile material forms including those made by weaving, tri-axial braiding, knitting, and stitching procedures. The use of through-the thickness stitching of graphite preforms and the RFI process (stitched/RFI) were found to provide cost-effective increases in structural damage tolerance. This process was selected in 1995 to fabricate a 12.8-m-long full-scale composite wing box that was tested at NASA Langley [3-4]. This test is discussed later in this paper in the section dealing with the ACT Program.

Automated robotic placement processes for tow, ribbon, and tape forms of composite materials were studied and developed at NASA Langley because these processes have emerged as promising low-cost fabrication processes for high performance fiber-reinforced composite structures. Production-ready computer controlled equipment has been used by industry to manufacture major portions of the Boeing 777 empennage, the F/A-18E/F stabilator and inlet ducts, and several V22 parts, among others. NASA investigated the use of these cost-effective fiber-placement processes by using representative small-scale, experimental equipment that simulates the expected performance of larger manufacturing facilities. Such equipment was used to study, screen, and develop composite fabrication processes using new resins, new fibers, new intermediate materials forms, new in-situ curing mechanisms, and net-shape material placement procedures. A research laboratory was developed at NASA Langley to study automated fabrication processes and to provide a means to address some of the research issues associated with these processes. Heated-head automated tape placement (ATP) of thermoplastic prepreg materials and e-beam cure-on-the-fly ATP of epoxy prepreg materials were examined [5-6]. This prototype research laboratory was used to study and perfect non-autoclave and in-situ ATP fabrication processes that had the potential of being scaled up to fabricate full-scale structures. Once these processes were perfected, these processes are transferred to larger ATP equipment for the fabrication of full-scale structures. These fabrication processes can be used for the in-situ fabrication of large, high-quality composite structures, such as cryogenic fuel tanks with diameters of the order of nine meters and lengths over 18 meters. Autoclave processing of such structures would be prohibitively expensive due to the need for appropriately sized autoclaves and related fabrication tooling.

Lessons Learned:

1. Processing science needs to be an integral part of polymer chemistry development and must be integrated with structures to guide fabrication studies of real engineering components.
2. Automated processes are required to reduce the cost of composite structures.
3. Scale-up studies are required to establish processing limits and quality control factors.

References:

1. James H. Starnes, Jr., H. Benson Dexter, Norman J. Johnston, Damodar R. Ambur and Roberto J. Cano, "Composite Structures and Materials Research at NASA Langley Research Center", Presented at the NATO Research and Technology Agency Applied Vehicle Technical Panel Specialists' Meeting on Low Cost Composite Structures, Loen, Norway, May 7-8, 2001.
2. Critchfield, M. O., et al., "Low-Cost Fabrication Of Composite Ship Structures Using Vacuum-Assisted Resin Transfer Molding," Proceedings of the Composites in Marine Applications Symposium, Seattle, WA, November 1992.
3. Karal, M., "AST Composite Wing Program - Executive Summary," NASA/CR-2001-210650, March 2001.
4. Jegley, D. C., Bush, H. G., and Lovejoy, A. E., "Structural Response and Failure of a Full-Scale Stitched Graphite-Epoxy Wing," AIAA Paper No. 2001-1334-CP, April 2001.
5. Johnston, N. J., Belvin, H. L., Cano, R. J., Marchello, J. M., and Hulcher, A. B., "A Prototype Research Laboratory For Automated Fabrication Of High Performance Composites," Twelfth International Conference On Composite Materials, Preprints, Vol. 12, Paper No. 748, 1999.
6. Cano, R. J., Belvin, H. L., Johnston, N. J., Hulcher, A. B., Marchello, J. M., and Grenoble, R. W., "A Prototype Research Laboratory For Automated Fiber Placement Technology," Science of Advanced Materials and Process Engineering Series, Vol. 46, 2001.

Evolution of Composites NDE/I Technology - Figure 11

The use of composite structures for aerospace applications calls for identification and elimination of structural vulnerabilities of composites during manufacture and maintenance phases. NDE is relatively a mature field with excellent capabilities to detect flaws in flat plate and skin stiffened laminates and flat honeycombs. However, the accurate identification of flaws in complex curvature parts, joints, fasteners and adhesive bonds are more difficult and challenging. Composite structures for aerospace applications are now built using automated processes on a scale and complexity not achieved before requiring further developments in NDE. NDE is not only critical to check for flaws during manufacturing and handling, but also to check for any deterioration in properties that may develop during service. Quantitative NDE is a valuable tool for life and reliability prediction of composite components in flight service.

NDE of composites is a continuing story of advancement in techniques and understanding starting from 1970s, as illustrated in the figure 11 [1]. The figure also shows four areas of current and future emphasis by NASA ranging from developing quantitative NDE for bond strength to NDE simulation in design. Among the different techniques, radiography, shearography, thermography, and ultrasound are currently well established for NDE of composites. Radiography is well suited for NDE of sandwich panels, honeycomb core and bushing. Shearography or thermography can be used to evaluate face sheets, flat laminates and sandwich panels. In addition, Thermography can be used to evaluate beam to beam joints and bonded joints. Ultrasound is the most versatile technique that can be used on all the above listed configurations.

NASA's contributions to NDE of composites came out of the need to ensure structural integrity and reliability of lightweight composite structures in aerospace vehicles. NASA has been a leader in providing significant R&D support for aerospace applications of composites

since 1970s. NASA worked with Industry and the FAA to identify the appropriate NDE techniques to establish air and crash worthiness of aircraft composite components. In the base research program, NASA developed fundamental understanding of ultra sound propagation, signal detection and analysis, imaging and acoustic emission for different composite materials and structural configurations. NASA established a microfocus X-ray CT system with 12.5 μ m pixel resolution for imaging and quantifying porosity, stitching materials, inclusion, debonding, material loss and other microscopic flaws. In ultrasonics, NASA worked on methods to image material properties like stiffness and coupled the images to FEM codes to predict local stress and strain responses. NASA also developed ultrasonic phased array test bed system with hundred independent channels to inject and extract signals to improve over the conventional transducers. The laser based ultrasound technique was made safer to operate in an open environment by confining the laser light to fiber optics. In the field of Acoustic Emission (AE), better methods for locating and identifying damages was developed based on the fact that several plate modes can be generated during an AE event. Thermal NDE technique was developed to evaluate low velocity impacts and the measurement speed of thermal NDE was increased using a thermal line scanner. NASA also pioneered in the development of physics based modeling to enable predictive capability of NDE technologies in the fields of radiography, ultrasonics, thermography, electromagnetics and optics [2].

In addition to the techniques, NASA is working on the development of Directed Design of Experiments (DOE) for determining Probability of Detection (POD) to provide real-time guidance methodology to determine the capability of the NDE inspection systems [3]. Other notable contributions are the development of process control NDE standards and NDE Wave & Image Processor Software application to allow advanced visualization, processing and analysis of NDE and Health monitoring waveform and image based data. NASA's current NDE research activities are summarized in reference 4.

Two recent NDE programs on Composite Overwrapped Pressure Vessels (COPV) [5] and Composite Crew Module [6] have advanced the applicability and reliability of NDE techniques for critical space composite parts. Radiography, ultrasound, thermography and shearography were used for the NDE inspection of Composite Crew Module. As part of the NDE examination of COPVs, documented inspection criteria was developed consistent with material, analysis, and design assumptions. For future Spacecraft applications, work is underway to integrate NDE into the design and fabrication stages of space craft development. This approach will create a new safety paradigm to effectively think through the need for NDE as an integral part of the original specification and production planning process.

Structural Health Management (SHM) has emerged as an important area of research at NASA over the past several years. Long duration missions to the Moon, Mars and beyond cannot be accomplished with the current paradigm of periodic, ground based structural integrity inspections. As evidenced by the Columbia tragedy, this approach is also inadequate for the current Shuttle fleet, thus leading to its initial implementation of on-board SHM sensing for impact detection as part of the return to flight effort. However, future space systems, including both vehicles and habitation modules, will require an integrated array of onboard in-situ sensing systems.

Hence in recent years, NASA has conducted research aimed at advancing the state-of-the-art in sensing technologies and signal analysis. The goal was to acquire accurate structural response information and to infer the state of structural deformation and potential damage and defects

over large areas. Sensor technologies under development in NASA span a wide range including fiber-optic sensing, active and passive acoustic sensors, electromagnetic sensors, wireless sensing systems, MEMS and nano sensors [7]. But, much of this research has been in the area of fiber Bragg grating (FBG) optical sensors. When bonded to or imbedded in load-carrying structures, FBG sensors may provide high-quality multi-point strain measurements. A key step in analyzing strain data is to infer or reconstruct an accurate representation of the deformed structural shape. FBG optical sensors provide lightweight distributed capabilities for performing shape sensing computations which are essential in facilitating digital control of aerodynamic surfaces during flight. This is particularly relevant to flexible-wing vehicles, such as a Helios class of aircraft requiring automated procedures to control wing dihedral in flight [8]. Unmanned Aerial Vehicles (UAV) may derive substantial performance benefits using real-time wing surface control systems. For large space structures, including solar sails and membrane antennas, knowing the current three-dimensional shape of the structure may maximize spacecraft performance.

Extremely large numbers of a variety of sensor types will be necessary to provide real time, on-board structural integrity assessment for aerospace vehicles. In addition to the sensors, advanced data systems architectures will be necessary to communicate, store and process massive amounts of SHM data from large numbers of diverse sensors. Development of wireless sensors and sensor networks to reduce the mass of SHM systems is another priority area for NASA. Further, improved structural analysis and design algorithms will be necessary to incorporate SHM sensing into the design and construction of aerospace structures, as well as to fully utilize these sensing systems to provide both diagnosis and prognosis of structural integrity. Ultimately, structural integrity information will feed into an Integrated Vehicle Health Management (IVHM) system that will provide real-time knowledge of structural, propulsion, thermal protection and other critical systems for optimal vehicle management and mission control [10].

Lessons Learned:

1. Different NDE techniques need to be used as they differ in detectability limits and in probability of detection of different damages
2. Automated processes covering large areas will help to reduce time and cost of QC
3. As-built composite hardware can be significantly different from NDE defect standards and test articles
4. Determine and understand the effect of defects on part performance. This calls for integrating disciplines of NDE with Damage tolerance. For example, the major issue in NDE/SHM of COPVs is linking NDE to stress rupture and creep rupture failures
5. Need Defect standards of large specimens with well characterized and realistic defects representative of large structures to be inspected
6. Need Certification standards based on NDE data
7. Critical need to integrate NDE considerations into design process, which involves access for inspection, defining inspection criteria like critical defect type, size, etc
8. To achieve the above, requires team effort between NDE, materials, and structures disciplines

9. Need NDE methods to monitor in real time the structural integrity with embedded sensors
10. Need for in-situ NDE and SHM in both short and long term space missions
11. IVHM system for aerospace vehicles will require extremely large number sensors to measure a multitude of parameters like strain, load, pressure, temperature, vibration, and local chemistry
12. Need embedded sensors with long term reliability and signal stability for SHM
13. Need small light weight sensor networks that are compatible with composite material which do not cause damage initiation under load and thermal cycles
14. Need wireless sensors that are small enough, smart enough, and with enough multifunctionality to be acceptable to designers
15. Need flight testing of full-scale IVHM systems to detect multisite damage
16. Need artificial intelligence to automatically assess structural integrity from sensor responses and implement damage mitigation protocols.

References:

1. Charles E. Harris et al, “Overview of the History and State-of-the-Art of Large Composite Structures in Aerospace Vehicles”, The NASA-Virginia Tech Composites Program, May 2008, http://www.esm.vt.edu/ESM100_Presentations/ESM100_Harris.pdf
2. Eric Madaras, “Highlights of NASA’s Role in Developing State-of-the-Art Nondestructive Evaluation for Composites”, NASA Document ID 20050050900, 2001.
3. Ed Generazio, “Directed Design of Experiments(DOE) for Determining Probability of Detection (POD) Capability of NDE Systems”, paper presented in Review of Progress in Quantitative NDE, Colorado School of Mines, Golden, CO, July 2007).
4. NASA Nondestructive Evaluation Working Group (NNWG) – Current and Completed Tasks <http://nnwg.org/index.html>
5. Regor Saulsberry et al, “Nondestructive Methods and Special Instrumentation Supporting NASA Composite Overwrapped Pressure Vessel Assessments”, NASA Document ID 20070010588, AIAA-2007-2324, 48th AIAA/ASME/AHS/ASC Structures, Structural Dynamics and Materials Conference.
6. NASA - Team Gains Experience as it Builds Innovative Composite Spacecraft, http://www.nasa.gov/offices/nesc/home/Feature_6_090908.html
7. Prosser, W.H. et al, “Structural Health Monitoring Sensor Development at NASA Langley Research Center”, NASA ID 20040085739, 2002.
8. Alexander Tessler, “Structural Analysis Methods for Structural Health Management of Future Aerospace Vehicles”, NASA/TM-2007-214871, April 2007.
9. Prosser, W.H. et al, “Structural Health Management for Future Aerospace Vehicles”, NASA ID 20040200975, 2004.

NASA Research – Textile Composites - Figure 12

The cost and damage tolerance barriers of conventional laminated composites led NASA to focus on new concepts in composites which would incorporate the automated manufacturing methods of the textiles industry and through the thickness reinforcements. Multiaxial warp knitting, triaxial braiding and through the thickness stitching were the three textile processes that surfaced as the most promising for further development. Braided fuselage frames and window-belt reinforcements, woven/stitched lower fuselage side panels, stitched multiaxial warp knit wing skins, and braided wing stiffeners were fabricated. Two-dimensional and three-dimensional braids were used to create stiffeners, frames and beams with complex cross-sections. In addition, low-cost processing concepts such as resin transfer molding (RTM), resin film infusion (RFI), and vacuum-assisted resin transfer molding (VARTM) were investigated. Processing models to predict resin flow and cure in textile preforms were developed.

In addition to improved damage tolerance, textile reinforced composites offer the following: reduced material and assembly labor costs through automated fabrication of multilayer multidirectional preforms; reduced machining and material scrap through use of near net shape preforms; elimination of cold storage requirements and limits on shelf life for prepreg; reduced tooling costs for vacuum assisted resin transfer molding compared to conventional autoclave processes; and improved damage tolerance and out-of-plane strength as a result of through-the-thickness stitching.

Stitching and debulking methods have been developed to achieve preforms that are near net shape with little or no further compaction required during processing. Advancements in 3-D finite element modeling of resin infusion were made. An experiment for a two-stringer stitched panel indicated the predicted temperature distribution was within 6-percent of the measured temperature and the predicted resin wet-out times were within 4 to 12-percent of measured times.

Lessons Learned

1. Multiaxial warp knitting proved to be the best process for large area multiaxial multilayer broadgoods, but structural shapes had to be achieved through postforming and stitching.
2. To eliminate trial and error processes, additional analytical models are required to predict resin flow into textile preforms.
3. Methods to reinfuse resin starved areas and repair concepts to restore damaged structure to original strength must be developed.
4. Compaction and permeability behavior are different for each fiber architecture and preform configuration requiring development of empirical relationships for input to analytical models.
5. Tooling concepts that can accommodate variability in dry preform bulk and permeability must be developed to achieve uniform resin flow and fiber wet-out.
6. Dimensional tolerances on tooling are critical to avoid racetracking or short circuiting of resin during the infusion process.

References:

1. Dow, Marvin B.; and Dexter, H. Benson: Development of Stitched, Braided and Woven Composite Structures in ACT Program and at Langley Research Center. NASA TP-97-206234.
2. Reeder, James R.: Comparison of the Compressive Strength for Stitched and Toughened Composite Systems. NASA TM-109108, April 1994.
3. Dexter, H. Benson: Development of Textile Reinforced Composites for Aircraft Structures. Presented at 4th International Symposium for Textile Composites, 12-14 Oct. 1998, Kyoto, Japan.

ACT Program Developed Advanced Wing Stitching Facility [Figure 13]

In 1988, NASA launched its Advanced Composites Technology (ACT) Program, a major new program for composite wing and fuselage primary structures. The defined goal was to reduce the structural weight of a commercial transport aircraft by 30 to 50 % while also reducing manufacturing costs by 20 to 25% and ensuring that the resulting structures behaved in a predictable manner, would meet FAA requirements for certification including the area of damage tolerance, and be repairable in a way that the airlines would find acceptable. The objective of the ACT Program was to develop an integrated “affordable” composites technology data base that will provide the impetus for a more rapid and timely transition of this technology into production aircraft. McDonnell Douglas (subsequently acquired by Boeing) focused its work on development of a stitched/resin film infused process wing for an MD-90 size aircraft. The wing cover design consisted of a stitched cover, with stitched stiffeners and intercostals that were also stitched to the cover. This concept was an outgrowth of NASA’s research on solutions to improve damage tolerance and stiffener pull-off.

Important achievements were made in: textile preforms and resin film infusion, an automated stitching machine (ASM) for fabricating an integral wing skin and stiffener concept, structural mechanics of stitched composites, damage containment, effects of impact on built-up components and ultimate failure of large composite components.

The ASM features high speed stitching capability with advanced automation allowing it to stitch large, thick, complex wing structures without manual intervention. Equipped with four stitching heads, this massive machine is able to stitch one-piece aircraft wing cover panels 40-foot long, 8-foot wide and 1.5-inches thick at a rate of 3,200 stitches per minute. The stitching heads also offer machine tool precision, stitching at 8 stitches per inch with row spacing of .2 inches. To achieve this rate, a pivoting or walking needle mechanism and needle cooling system had to be developed. These improvements prevented excessive needle bending and associated temperature build-up in the needle. In addition, to maintain desired stitching speeds, an automated thread gripper and cutting mechanism was developed.

The ASM has computers controlling 38 axes of motion. The computers are also used to simulate and confirm the stitching pattern on the 50-foot bed of the ASM. A laser projection system is used to precisely locate the wing skin on the lift table surface before stitching begins. The same aerospace precision is used to locate secondary materials, like the stiffeners, for stitching. The movements of the stitching heads are synchronized with each of the fifty lift tables it takes to control stitching over the contoured shapes of the wing panels. The lift tables

are used to support the dry fabric preforms as they are stitched. The ASM is capable of stitching wing cover panels in one, two-shift operation saving days over conventional composite manufacturing processes. Cost analyses indicate that a reduction of 20 percent in cost can be achieved over equivalent wings built from aluminum and the weight savings goal was achieved. Probably the most important was the development of tests and analyses databases to support FAA certification of transport composite wing structure.

Lessons Learned:

1. Future programs such as the ACT Program are essential to develop multidisciplinary research teams for advancing new composite technology.
2. Automated processing and inspection methods, reduced part count and larger assemblies are necessary to meet cost savings goals.
3. Focused efforts enhanced interaction with DOD and FAA and provided a forum for technology exchange.

References:

1. Dow, Marvin B.; and Dexter, H. Benson.: Development of Stitched, Braided and Woven Composite Structures in the ACT Program and at Langley Research Center (1985 to 1997). NASA TP-97-206234.
2. Jegley, Dawn C.; Bush, Harold G. and Lovejoy, Andrew E.: Structural Response and Failure of a Full-Scale Stitched Graphite–Epoxy Wing. JOURNAL OF AIRCRAFT Vol. 40, No. 6, November–December 2003.
3. Rouse, Marshall; et al.: Utilization Of The Building-Block-Approach In Structural Mechanics Research. 46th AIAA/ASME/ASCE/AHS/ASC Structures, Structural Dynamics & Materials Conference, 18 - 21 April 2005, Austin, Texas. (Available as AIAA Paper 2005-1874.)
4. Karal, Michael: AST Composite Wing Program – Executive Summary. NASA CR-2001-210650.
5. <http://www.nasa.gov/centers/langley/news/factsheets/ASM.html>

ACT Program Stitched-RFI Wing Subjected to 95% Design Ultimate Load - Figure 14

The Stitched-RFI Composite Wing Program was successfully completed with ground testing of a 42-ft-long wing box. The box was tested in the Langley Structures and Materials Laboratory in 2000, and the box failed at 97 percent of Design Ultimate Load (DUL), 145-percent of Design Limit Load (DLL). Prior to the final tests an extensive building block approach was utilized. Numerous materials coupons, sub-elements, elements and a wing stub box were tested. Pre- and post analyses were performed on each test article in order to understand failure modes and validate analyses methods.

The wing structure was subjected to eight tests with three load conditions as listed:

(1) 50% DLL brake roll (2) 100% DLL brake roll (3) 50% DLL -1G (4) 50% DLL +2.5G (5) 100% DLL -1G (6) 100% DLL +2.5G (7) 70% DLL +2.5G (8) Failure/150% DLL +2.5G. In the test, the wing tip was pulled down to simulate a –1G flight maneuver and pushed up to simulate a 2.5G flight maneuver. After successful completion of the first six tests, discrete

source damage was inflicted on the upper and lower cover panels of the wing. The wing was then loaded to 70% DLL in the 2.5G upbending condition and unloaded. Next, the discrete source damage was repaired, six nonvisible impacts were inflicted, and the wing was loaded to failure in the 2.5G upbending load condition.

Discrete source damage in the wing was seven-inch-long sawcuts to the upper and lower cover panels. Each sawcut ran through two stinger bays and cut through a stringer. Metal patch repairs were used to restore the wing to full load-carrying capability. The damaged region was removed prior to implementing the repair. The repairs consisted of a metal plate which conformed to the wing surface on the outer surface of the cover panels and internally spliced stringers. All parts of the repair were attached to the wing with mechanical fasteners.

A weight of 25 lbs with a 1-inch-diameter tup was dropped vertically from 4 feet, resulting in barely visible damage. The depth of the resulting damage ranged from 0.01 to 0.05 inches. An air-propelled steel projectile was used to inflict three impacts with an energy level of 83-84 ft-lbs to the lower cover panel. A steel sphere with a 0.5-inch diameter was accelerated to a speed of approximately 545 ft/sec, resulting in clearly visible damage with dent depths up to 0.135 inches.

A total of 466 strain gages were used to record strains all over the test article. Strain gages were located on the edge of critical access holes at the midplane, not on the cover panel surface. All other gages were placed on the skin or stringer blade surfaces. The test article supported 97% of DUL prior to failure through a lower cover access hole which resulted in the loss of the entire lower cover panel. In addition to the high strains at the lower cover panel access holes, strain gage results indicated that local nonlinear deformations occurred in the upper cover panel in an unsupported region behind the rear spar. Larger local displacements and strains occurred in the test than were predicted by the nonlinear finite element analysis. Further refinements to the finite element model might provide a better agreement of the analytical results with the test data.

Experimental and analytical results are in good agreement for global behavior. This further validates the importance of using the building block approach to develop and understand the behavior of composite structures that fail in a brittle manner or experience delamination or stiffener pull-off.

Lessons Learned

1. A building block approach based on tests and analyses of materials coupons, sub elements and components that makeup the structure reduces risk and provides data and analyses to support FAA Certification.
2. Fastener holes, access openings, stiffener run-out, and discrete damage – both visible and barely visible and potential for delamination warrant special attention.
3. All of the ACEE and ACT composite structures failed in quasi-brittle mode. Out-of-plane loads often ignored in metal structure must be taken into account.
4. Issues identified in design, analyses, fabrication and tests of built-up structure formed the bases for identifying important thrust for the Base R&T program. Also, insight into the potential pay off of new technology development was provided.

5. University participation in focused R&D projects provided new perspectives on technology development and accelerated development of new analyses codes and understanding of failure criteria

Reference:

1. Jegley, Dawn C.; Bush, Harold G.; and Lovejoy, Andrew E.: Structural Response and Failure of a Full-Scale Stitched Graphite–Epoxy Wing. JOURNAL OF AIRCRAFT, Vol. 40, No. 6, November–December 2003.

Recent Advancement in Stitched Composites [Figure 15]

After the completion of comprehensive research in the NASA Advanced Composite Technology Wing Program during the 1990s', many years passed before the first stitched production part flew. In 2003, the lightly-loaded C-17 LAIRCM fairing went into production but did little to demonstrate the structural advantages of stitching. Nonetheless, it was an important step in establishing the manufacturing benefits of resin infusion technology. From there, more challenging components were selected to demonstrate the complex integration that was possible using dry fabrics and stitching. This led to the development of more innovative one piece multi-rib-stiffened box structures, like the C-17 landing gear doors. In the gear door application, complex performs were stitched together and then infused and cured at atmospheric pressures in an oven. To suppress the out-of-plane delaminations that were common on the bonded production doors it replaced, all the rib caps and perimeter lands were reinforced with through–thickness stitching. This allowed the door to operate further into the post-buckled regime than was possible with the bonded design. The first stitched composite production main gear door flew on the C-17 in mid 2007. In 2003 Airbus selected preformed dry reinforcements RFI to manufacture the A380 aft pressure bulkhead.

Two recent major advancements are: (1) One-sided Robotic Stitching and (2) the PRSEUS Structural Concept. The advent of Altin's (now KSL) one-sided stitching technology enabled the use of stitching for joining, fastening, and stabilizing dry fabrics while accessing the material from only one side. The end effector consists of two needles, one for inserting the thread, and one for catching the loop of thread formed by the other needle. Using a single thread, the two needle system forms a modified chain stitch. An industrial robot arm gives the end effector six degrees of freedom for stitching in 3-D space. One-sided robotic stitching of large complex structures is possible at one fourth the capital investment of a conventional two-sided process.

Using this approach, complex stitched preform assemblies were built without the need for exacting tolerances, and then accurately net-molded in a single oven-cure operation using high precision outer moldline (OML) tooling. Because all the materials in the stitched assembly were dry, there were no out-time or autoclave requirements as in prepreg systems, which can often limit the panel size and level of integration possible. Resin infusion is accomplished using a soft-tooled fabrication method where the bagging film conforms to the inner moldline (IML) surface of the preform geometry and seals against a rigid OML tool. This eliminates costly internal tooling that would normally be required to form net-molded details.

The Pultruded Rod Stitched Efficient Unitized Structure (PRSEUS) is a highly integrated stitched concept. The arrangement of dry warp-knit fabric, pre-cured rods, and foam core materials are assembled and then stitched together to create the optimal structural geometry for fuselage loading. Load path continuity at the stringer-frame intersection is maintained in both directions. The 0-degree fiber dominated pultruded rod increases local strength/stability of the stringer section while it also shifts the neutral axis away from the skin to further enhance the overall panel buckling capability. Frame elements are placed directly on the IML skin surface and are designed to take advantage of carbon fiber tailoring by placing bending and shear-conductive lay-ups where they are most effective. In its entirety, this integral panel design is intended to first exploit the orthotropic nature of carbon fibers, and then to suppress the out-of-plane failure modes with through-the-thickness stitching. Taken together, these two features enable the application of a new damage-arrest design approach for composite structures.

The first large panels were fabricated and tested in 2006 under an Air Force research contract. A recent investigation indicates that the PRSEUS concept would be 10.3% lighter weight than honeycomb sandwich construction in the pressure cabin of a large Blended Body Wing aircraft.

Lessons Learned:

1. Dry stitched fiber reinforced RFI or VARTM manufacturing applications are increasing.
2. Development and/or application of advanced stitching equipment will continue to reduce costs and expand the structural shapes that can be fabricated.

References:

1. Air Vehicle Technology Integration Program (AVTIP), Delivery Order 0059: Multi-role Bomber Structural Analysis, AFRL-VA-WP-TR-2006-3067, Krishna Hoffman, MAY 2006, Final Report for 14 December 2004 – 08, May 2006, AFRL-VA-WP-TR-2006-3067.
2. Velicki, Alex; and Thrash, Patrick: Advanced Structural Concept Development Using Stitched Composites. 49th AIAA/ASME/ASCE/AHS/ASC Structures, Structural Dynamics, and Materials Conference
16t, 7 – 10 April 2008, Schaumburg, IL.
3. Li1, Victor; and Velicki, Alex: Advanced PRSEUS Structural Concept Design and Optimization. 12th AIAA/ISSMO Multidisciplinary Analysis and Optimization Conference, 10 – 12 September 2008, Victoria, British Columbia, Canada
4. <http://www.compositesworld.com/articles/an-elegant-solution-for-a-big-composite-part.aspx>

ACT Program Fuselage Development - Figure 16

The primary objective of the ACT fuselage program was to develop composite primary structure for commercial airplanes with 20-25% less cost and 30-50% less weight than equivalent metallic structure. In order to develop advanced structural concepts for aircraft fuselage, a pressurized aft fuselage section of a wide body generic wide body airplane with a diameter of 244 inches (B777 size) was chosen as the area of study for development of composite fuselage structural concepts. Boeing chose this section since it contained most of the structural details and critical manufacturing issues present in fuselage structures. The fuselage section was divided into four circumferential quadrants, the crown, the left and right sides, and keel.

A multidisciplinary team representing all structural design, manufacturing, operational requirements and cost analyses was formed. Cost Optimization Software for Transport Aircraft Design Evaluation (COSTADE) was developed to assess influence of design, manufacturing tolerances, maintenance and other requirements on cost. A three step approach was used to identify and evaluate structural concepts for each quadrant of the fuselage section. First, the baseline concept selection was determined to have the greatest potential for cost and weight savings with considerations for acceptable risk. Second, a global evaluation was conducted to develop preliminary designs in sufficient detail such that cost and weight differences between the baseline concept and other low-cost/low-weight concepts could be developed. The final step involved selecting the concepts with the largest weight-saving potential for local optimization. This step involved optimizing the design elements while considering the impact of any design changes on overall cost. This approach resulted in a skin/stringer configuration for the crown quadrant and sandwich construction for the keel and side quadrants that have the potential to meet both costs and weight savings goals. All designs were based on use of automated tape laying equipment.

Lessons Learned:

1. Successful composite applications begin with multidisciplinary teams. (Especially when cost is the driver, weight savings is a bonus and “real world issues must be addressed)
2. Successful development of complex structural components is essential for maturing new processes and analyses methods
3. A formal method of predicting and tracking costs such as COSTADE is extremely valuable.

References:

1. Ilcewicz, L.B.; et. Al.: Advanced Technology Composite Fuselage –Program Overview. NASA Contractor Report 4734, April 1997.

ACT Program Tape Laid Crown Panel [Figure 17]

A series of benchmark crown panels were formulated to gain understanding of the structural performance of thin gage fuselage structures fabricated from composite materials. Five curved stiffened panels representative of fuselage crown design concepts were fabricated to provide test specimens for a pressure-box test fixture for frame/skin bondline strength evaluations. These panels also provided the opportunity to investigate alternate design concepts in addition to alternate damage scenarios such as circumferentially-oriented notches and barely visible impact damage.

One curved stiffened graphite-epoxy fuselage crown panel was tested in a pressure-box test machine to study its response characteristics when subjected to internal pressure and biaxial tension. The panel had a 122-in. radius, a 72-in. length, and a 63-in. arc width. The panel skin was tow-placed using a fiberglass-graphite-epoxy hybrid material system to improve the damage tolerance characteristics of the panel. The panel frames were made of triaxially braided graphite fiber preform impregnated with an epoxy resin and cured using a Resin Transfer Molding process. The stringers passed through cutouts machined into the frames, and no clips were used to attach the stringers to the frames. This design reduced the structural part count and the cost associated with panel fabrication.

Nonlinear structural analyses of a cylindrical shell with internal pressure as well as the pressure-box test fixture with a curved panel subjected to internal pressure were performed using the STAGS finite element code. The analysis of the cylindrical shell ensured that the load state that was applied to the pressure-box panel was representative of that in a full cylinder. A quarter model of the pressure-box test fixture with a curved panel was developed for analysis using shell, rod, and beam elements.

The experimental hoop strain results are compared in Figure 17 with analysis results for a fuselage panel subjected to internal pressure conditions of 5 psig and 18.2 psig in the pressure box test fixture. The correlation between the results is excellent. This comparison suggests that the finite element model represents the test well. After the undamaged panel tests were completed, a notch was cut into the panel skin to study the damage tolerance characteristics of the panel. Damage growth initiated at the notch tips when the internal pressure reached 6.3 psi and grew along a curved trajectory at approximately 11.2 psi. The panel exceeded its design requirements for the burst pressure condition in the undamaged condition and satisfied the design limit load with damage.

Lessons Learned:

1. A building block approach based on tests and analyses of materials coupons, sub elements and components that makeup the structure reduces risk and provides data and analyses to support FAA Certification.
2. A pressure box test machine can be used to simulate the shell stress state in panels in a relatively inexpensive manner.

References:

1. Rouse, Marshall; Jegley, Dawn C.; McGowan, David M.; and Bush, Harold G.: Utilization Of The Building-Block Approach In Structural Mechanics Research.
2. 46th AIAA/ASME/ASCE/AHS/ASC Structures, Structural Dynamics & Materials Conference, 18 - 21 April 2005, Austin, Texas.
3. Ambur, Damador R.; and Rouse, Marshall: Design and Evaluation of Composite Fuselage Panels Subjected to Combined Loading Conditions. AIAA-97-1303.

High Speed Transport Aircraft Program [Figure 18] and High Temperature PETI-5/IM7 Skin Stringer Panel (6'x10') [Figure 19]

In the mid 1990's, feasibility studies indicated that a High Speed Civil Transport (HSCT) with the capability to fly between Mach 2.0 and 2.5, with a capacity of 200 to 250 passengers and a range of 5,000 nautical miles might be economically feasible. These studies indicated that to be economically viable, the HSCT would have to provide a return on investment that was competitive with subsonic transport aircraft. Advancements in the current state of technologies were shown to be necessary to meet the manufacturing, maintenance, and operational cost requirement for a HSCT aircraft. In 1994, NASA initiated the High Speed Research (HSR) program to address these challenges, see figure 18. The goal of the HSR program was to develop the technologies needed to build a commercial transport aircraft capable of flying at Mach 2.4 for 5000 nautical miles at an altitude of 60,000 ft. The target vehicle was to be capable of carrying 300 passengers from California to the Pacific Rim in half the time and at

only 1.2 times the cost of conventional subsonic vehicles. The vehicle weight goal was a 30% reduction as compared to the Concorde supersonic transport. In 1994, Phase I of the HSR program, trade studies were conducted to develop a configuration for a vehicle to meet the market requirements. In 1995, Phase II was initiated to develop the technology necessary for a HSCT vehicle [1-3]. One area of technology development pursued was Material and Structures. The Material and Structures Technology Development was further divided into tasks which consisted of: Metallic Materials; Composite Materials; Materials Durability; Wing Structures; Fuselage Structures; Aeroelasticity; Acoustics; and Design Integration Trade Studies. These tasks were integrated together to develop the material processes, structural concepts and airplane configuration that met the design criteria and environmental constraints. Candidate structural concepts, design, test methods-both real and accelerated time, and analyses database on a Technology Concept Aircraft (TCA) were investigated. Potential structural concepts included honeycomb sandwich, skin/stiffened panels, frames and beams.

Polymer matrix composite was a candidate for application in fuselage, forward strake, inboard wing box, wing tip box, wing trailing edge and empennage. However, none of the existing high temperature resin matrix composites exhibited all the properties required to meet HSR requirements. To meet this challenge chemist at NASA Langley studied a series of low molecular weight lightly cross-linked polyimides. One of the approaches taken in this effort was to mix different monomers to obtain a short chain polymer that was then endcapped with phenylethynyl phthalic anhydride to form a phenylethynyl-terminated short chain thermoplastic polyimide, LaRC™-PETI-8. The same reaction sequence was used to make LaRC™-PETI-5 which had a higher molecular weight. LaRC™-PETI-5 was designed for autoclave processing [4-6]. A solution of the precursor polyamide acid was used to make IM-7 carbon fiber prepreg that was stacked, vacuum bagged, and autoclave-cured at 350°C/100 psi for 3 hours. The result was a void-free, tough, high modulus, high temperature laminate with a lightly cross-linked, polyimide matrix. It should be pointed out that hundreds of polymer compositions were screened during the High Speed Research (HSR) program before this particular combination of monomers was selected for scale-up. Thermal exposure tests indicated that PETI-5/IM7 had the capability to meet the temperature and time (350F and 60,000 hours) service requirements for the TCA. Over 1000 pounds of prepreg was commercially made during the HSR activity and led to the fabrication of 6-foot by 10-foot skin-stringer and sandwich panels. A photograph of the former, fabricated at Boeing St. Louis, is shown in Figure 19.

A large PETI-5/IM7 fuselage panel was built and subjected to combined loads testing using the D-box test fixture in the Combined Loads Tests System (COLTS) located at NASA Langley, figure 18. A curved sandwich fuselage panel with a centrally located circumferential sawcut through the facesheet and honeycomb core of the panel was subjected to internal pressure, shear and axial loading using the. The sandwich facesheets were fabricated from IM7/PETI-5 uni-directional tape with longitudinal tear straps, and the core was a titanium honeycomb. A 12-inch-long notch was machined through the longitudinal tear strap at the center of the panel to simulate discrete-source damage in the panel prior to testing. Mechanical and internal pressure loads were applied to the test panel. The panel was initially loaded to 7.2 psi internal pressure followed by axial and shear loading. The damage initiated at the tip of the notch and

propagated at a 40° path toward the adjacent tear straps. The damage progressed beyond the doublers at an applied 7.2 psi internal pressure, 3,900 lb/in. axial load, and 888 lb/in. shear load.

Lessons Learned:

1. Polymer synthesis to meet a serious challenge such as making a new matrix resin for composites used on future high speed civil transport was a very difficult job. Composite properties must be established that meet structural needs and this requires the whole-hearted cooperation of both materials and structures personnel. Once composite properties are established, the chemist needs to develop relationships between composite properties and polymer properties. Developing a fundamental understanding of the relationships between polymer properties and polymer molecular structure is essential.
2. Fabrication of composites by whatever process must yield void-free laminates to achieve useful engineering properties.
3. Results achieved indicated that high quality structure could be fabricated with high temperature resins. Comparisons between mechanical test results and analysis predictions were good.
4. COLTS can be used to simulate the internal pressure, bending and shear loads in curved fuselage panels in a relatively inexpensive manner.

References:

1. Rouse, Marshall; Jegley, Dawn C.; McGowan, David M.; and Bush, Harold G.: Utilization Of The Building-Block Approach In Structural Mechanics Research.46th AIAA/ASME/ASCE/AHS/ASC Structures, Structural Dynamics & Materials Conference, 18 – 21 April 2005, Austin, Texas.
2. Kerr, James R.; and Haskins, James F.: Time-Temperature-Stress Capabilities of Composite Materials for Advanced Supersonic Technology Application. NASA-CR-178272, May 1, 1987.
3. <http://www.sti.nasa.gov/tto/spinoff2001/ip9.html>
4. Bryant, R. G., Jensen, B. J., and Hergenrother, P. M., “Synthesis and Properties of Phenylethynyl-Terminated Polyamides,” Polymer Preprints, 34 (1), 566 (1993).
5. Havens, S. J., Bryant, R. g., Jensen, B. J. and Hergenrother, P. M., Phenylethynyl-Terminated Imide Oligomers and Polymers Therefrom,” Polymer Preprints, 35 (1) 000 (1994).
6. Hergenrother, P. M., Bryant, R. B., Jensen, B. J., Smith, J. G. and Wilkinson, S. P., “Chemistry and Properties of Phenylethynyl-Terminated Imide Oligomers and Their Cured Polymers,” Science of Advanced Materials and Process Engineering Series, 39, 961 (1994).

Future Activities:

1. One of the toughest challenges faced in high temperature vacuum-assisted resin transfer molding (HT-VARTM) is the reduction of void content to 2% or less required for aerospace applications. To date, it has not been possible for polyimide resins by conventional HT-VARTM. About 3% void content has been achieved. The current research must focus on in-depth studies to determine the volatile source and when volatile evolution occurs followed by appropriate modification of the process cycle. High temperature degradation studies under VARTM-simulated conditions of all the monomers used in the process must be done.

2. Implementation of higher fidelity temperature and pressure controls for the HT-VARTM process must be done followed by additional processing trials.
3. Evaluation of the structural mechanical properties of the HT-VARTM polyimide composites is needed, especially at elevated temperature.
4. Resistance to microcracking of the new HT-VARTM materials under thermal cycling from cryo (LN₂, LH₂) to elevated temperature should be evaluated.
5. Extend the HT-VARTM process to other classes of high temperature polymers.

NASA and FAA Cooperative Research [Figure 20]

NASA and the Federal Aviation Administration (FAA) have a long history of cooperation. As part of this cooperation the FAA maintains a Field Office at NASA Langley Research Center. Over the last 30 plus years the FAA National Composites Resource Specialist has been closely associated with NASA research and development in composites structures. During the NASA ACT Program, Joe Soderquist the FAA National Composites Resource Specialist was a key member of the ACT Advisory Board. This insured that FAA concerns about the future certification of composite primary structures would be investigated.

Specific thrust areas that have been cooperatively pursued include: (1) development of material control, standardization and shared databases (recently supported by NASA AGATE program) (2) Damage tolerance and maintenance practices (3) Structural substantiation (4) Bonded joints and processing issues (5) Advanced material forms and processes and (6) Flammability and crashworthiness. NASA has made significant contributions in each area. Specific examples include: effect of barely visible and discrete damage, damage growth, failure modes, crashworthiness, Composites Material Handbook 17 (CMH 17), and AGATE initiated shared database process.

Lessons Learned

1. Continuing interface between FAA, aircraft manufacturers, aircraft operators and NASA researcher is essential to identify and solve “the real world issues” of utilizing composite materials in aircraft primary structures.

References:

1. Anon: Ninth DOD/NASA/FAA Conference on Fibrous Composites in Structural Design. Vol. 2, NASA-CR-198722, Sept. 1, 1992.
2. <http://www.compositesworld.com/columns/shared-material-databases-the-next-chapter.aspx>

AGATE - Advanced General Aviation Technology Experiments [Figure 21]

A major component of the AGATE program was research on crashworthiness. Since the first full-scale crash test was performed in February 1974, the Impact Dynamics Research Facility (IDRF) was used to conduct: 41 full-scale crash tests of General Aviation (GA) aircraft including landmark studies to establish baseline crash performance data for metallic and composite GA aircraft; and 11 full-scale crash tests of helicopters including crash qualification tests of the Bell and Sikorsky Advanced Composite Airframe Program (ACAP) prototypes. For some of these tests, nonlinear transient dynamic codes were utilized to simulate the impact

response of the airframe. These simulations were performed to evaluate the capabilities of the analytical tools, as well as to validate the models through test-analysis correlation.

Energy absorption is the critical structural characteristic for meeting crashworthiness requirements. Metal structures typically buckle, wrinkle, and undergo plastic deformation as their energy absorption mechanism. However, composites are brittle and absorb energy by a crushing type of behavior involving matrix cracking, matrix delamination, and fiber breakage. This requires that the composite crush and/or have designed failure modes that cause buckling/wrinkling/delamination etc. followed by crushing to absorb energy.

A composite general aviation airframe was crash tested at the NASA Langley Research Center Impact Dynamics Research Facility to demonstrate the efficacy of employing a systems approach to crashworthy design for general aviation aircraft. The impact conditions of this test represented a much higher velocity change and possessed more than five times the impact energy compared to the current FAA requirements for dynamically certified seats and restraint systems. The demonstration was successful since a survivable cabin volume was retained and occupants survived the test.

The structural design methodology developed during this research represents an additional 50-G crash load condition, not currently required by the FAA, which can be largely addressed using traditional airframe design techniques. The improvements in crashworthiness performance were achieved without significant cost or weight penalties.

The crashworthy technologies employed in this design included an energy absorbing engine mount, a reinforced cowl, a non-scooping ramp at the bottom of the firewall, a reinforced fuselage, and an energy absorbing subfloor.

Lessons Learned:

1. Energy management through application of the impulse/momentum equation might be a better strategy than energy absorption for general aviation designs that possess only limited space in which to locate energy absorbing technologies.

References:

1. Jackson, Karen E.; Boitnott, Richard L.; and Fasanella, Edwin L.; Jones, Lisa E.; and Lyle, Karen H.: A History of Full-Scale Aircraft and Rotorcraft Crash Testing and Simulation at NASA Langley Research Center. Presented at 4th Triennial International Aircraft and Cabin Safety Research Conference, 15-18 Nov. 2004, Lisbon, Portugal. (Document ID: 20040191337.)
2. Farley, Gary L.; and Jones, Robert M.: Energy-Absorption Capability of Composite Tubes and Beams. NASA TM-101634, Sept. 1989.
3. Henderson, Marilyn, Hooper, Steven J. and Lyle, Karen: AGATE Composite Airframe Impact Test Results. AGATE-WP3.4-034026-088, Rev. A, Work Package Title: WBS3.0 Integrated Design and Manufacturing, Date of General Release: March 1, 2002.

NASA Space Vehicle Composite Research

USAF DC-A and NASA DC-XA Experimental Flight Vehicles [Figure 22]

State-Of-The-Art USAF DC-X and NASA Contributions With the DC-XA

From 1992 through 1996, two unmanned experimental aircraft, the USAF DC-X and the subsequent NASA DC-XA, were developed to demonstrate the viability of building a single-stage-to-orbit spacecraft. [1, 2, 3] In essence, their purpose was to implement and successfully demonstrate important advanced enabling technologies for building a reusable launch vehicle or RLV. The DC-X/DC-XA vehicle is shown in figure 22 along with 6 technologies the DC-X successfully demonstrated in 7 flights. After NASA assumed responsibility for the DC-X program, from the USAF, it installed more advanced technologies that were successfully demonstrated in the next 4 flights. Two of these, a composite LH₂ cryotank and a composite shell intertank, are shown in figure 22. The intertank was comprised of two semi-cylindrical half shells joined by aluminum attachment rings. [1] The shells were made from 4-ply fabric carbon fiber/bismaleimide face sheets bonded to an aluminum flex-core. The cryotank was constructed in two cylindrical shell pieces joined together by a “belly wrap” bonded splice joint. [1] The shell was a 24-ply graphite/toughened epoxy laminate attached to an internal 3-D reinforced urethane foam. The DC-XA was the first successful demonstration of a leak-free composite LH₂ cryotank. The program ended when one of the landing struts failed during decent and the vehicle crashed.

NASA Technology Development Structural Tests Related to Use of Composites on a Future RLV

A full-scale segment of a RLV prototype wing was fabricated and successfully tested at LaRC. [2, 3, 4] It demonstrated the integration of TPS with large components, validated fabrication, design, and analysis methods, and proved that composite structures technology could be used for primary RLV structure.

A full-scale segment of a composite RLV intertank was fabricated and tested at LaRC. [2, 3, 5] The test article failed prematurely by skin buckling due to poor adhesive bond between the hat stiffeners and the skin. It showed the need to have manufacturing development tests when building a large structural component.

Two prototypes composite LH₂ tanks, approximately ¼-scale, one built by Boeing [6], the other by Northrop Grumman [7], were successfully tested under LH₂ fill conditions at the NASA Marshall Flight Research Center. Viability for a composite cryotank on a future RLV was indicated.

X-33 Advanced Technology Demonstrator [Figure 23]

The NASA X-33 Vehicle and Composite Cryotanks

On July 2, 1996, NASA selected Lockheed Martin to design, build, and fly the X-33 Advanced Technology Demonstrator test vehicle. [3, 8] The X-33 was designed to be a quarter-scale

unpiloted prototype of a potential future single-stage-to-orbit (SSTO) RLV, dubbed the VentureStar, which Lockheed Martin planned to develop early this century. The X-33 was to take off vertically, reach altitudes of up to 50 miles at hypersonic speeds (up to Mach 13), and land horizontally. X-33 was intended to demonstrate 4 new technologies needed for a successful RLV:

- Aerospike engines
- Composite liquid hydrogen (LH₂) cryotanks
- Metallic thermal protection system
- Flight operations (launch preparations and landing)

We will concentrate on the development of the composite LH₂ cryotanks. The two load-bearing composite LH₂ cryotanks were located at the aft end of the craft, as shown in Figure 23, with the lithium-aluminum LOX tank located forward. In operation, the LH₂ tanks are pressurized internally (burst loads) and are under compressive forces externally (engine and LOX tank thrust loads). Each of the two tanks built were 28.5 ft long, 20.0 ft wide, 14.0 ft high and had a volume of 3836.8 ft³. Their tapered shape, large size, and load-bearing capability presented huge design and manufacturing issues, especially having to conform to the shape of the wedge-shaped lifting body with all parts being bonded, not welded or riveted. Each tank was a complicated four-lobe (quadrant) conical shell with a noncircular cross-section and a non-spherical two-lobe end cap as shown in Figure 23 (lobes are colored red on outside faces and blue inside). Each lobe was fabricated separately with IM7/977-2 graphite/epoxy inner and outer face sheets bonded to a Korex honeycomb core, then adhesively bonded to composite longerons, long strips running longitudinally through the tank, green color. A vertical composite septum and a horizontal composite septum reinforced the internal strength of the tank (Figure 23). Over 20 steps were involved in the fabrication process.

Technical Issues That Contributed to the Tank Failure [Figure 24]

Failure of the Composite Cryotank: Microcracking and Other Causes

In the fall of 1999 at Marshall Space Flight Center in Huntsville, AL, two LN₂ pressure proof tests were held, followed by a third LH₂ protoflight test during which the tank failed. [8] The test was conducted using 100 fill LH₂ where the internal pressure reached 42 psig, 105% of limit load. This pressure was dropped to 5 psig and external compression loads applied with hydraulic jacks while the tank was still full of LH₂. No leakage was observed. The tank was drained and left to heat up. When the tank temperature reached about -100°F, a cataclysmic event occurred in Lobe 1: partial separation of the outer face-sheet and core from the inner face-sheet in the forward (upper) right edge where Lobes 1 and 4 met. This was followed by other large and small cracks in Lobe 1.

A detailed investigation found that all three factors shown in Figure 24 contributed to the incident. First, a 3-in. piece of PTFE tape had been left on the inner face sheet creating a critical disbond area (a void predisposed to spread). Second, microcracking was found in all plies of all four inner face sheets. They formed as a result of cycling from room to cryogenic temperatures during the three proof tests. Consequently, cryopumping occurred in the honeycomb core cells. LH₂ was sucked into the cells through the inner face sheet; outside safety blanket nitrogen came into the cells through the outer face sheet and various poorly

bonded joints throughout the lobe. The cells then contained more liquefied gases than were originally present as gas at the start of the fill. So when the cryotank began to warm, the trapped LN₂ and LH₂ in the cells began to turn to gas; this expansion put pressure on both the inner and outer face sheets. At about -100°F, the pressure was sufficient to debond the inner face sheet from the core and attached outer face sheet. Where did this debonding occur? At or near where the Teflon™ tape had created a critical debond point. Third, the viscosity of the adhesive used to bond face sheets to core was too high, partly because of poor out-time. Almost no filleting occurred (see Figure 24, upper left photos) so the core/face sheet bond strengths were much lower than expected (a pre-test recognized condition). The bond strength values were just sufficient to resist the real-life pressures in a filled cryotank. Ten technology issues that contributed to tank failure were identified by The X-33 Composite LH₂ Cryotank Failure Board and are summarized in Figure 24.

Lessons Learned:

1. Early fabrication and evaluation of small-scale, subcomponent composite structures in the lobes and supporting skeleton may have revealed many potential problems in large-scale manufacturing such as fit-up, microcracking, poor core-face sheet bonding, NDE inspection for FOD, etc. But a building-block approach had not and should have been followed.

The following paragraph from reference 3 is appropriate to this lesson learned. “The building-block approach relies on tests of coupons, elements, and subcomponents to establish the effects of local details and internal load paths on structural behavior. By testing at each hierarchical level of detail, the interactions between the local elements are accurately represented in the structural design. These development tests can only be omitted if a design-by-analysis philosophy is supported by reliable, verified, high-fidelity design tools or by adopting a conservative design philosophy with large factors of safety. Since over-designed (heavier than necessary) structural components are not desirable and design tools are still under development, the building-block approach must be used to avoid high-risk structural designs.”

2. The cryotank design was highly innovative, pushed the limits of technology, combined many unproved technology elements, and was designed and built on an accelerated schedule. Best practices in design and engineering must be used including a vigorous technology development program with adequate factors of safety [8].

3. Well thought-out design/development planning must integrate materials, structures, and manufacturing technologies in a timely manner [8].

4. Failure modes must be addressed in depth, e.g., FEMA [8].

5. High levels of communication are required both internal and external to the involved organizations. In-depth technical penetration at all levels is needed [8].

6. A risk management plan must be used [8].

7. An in-depth review and inspection plan must be in place to preempt errors [8].

Future Directions:

1. Develop microcrack-resistant matrix resins and their structural composites that do not microcrack when cycled between cryo-temperatures and use temperature. They should also be microcrack-resistant to levels of impact resulting from fork-lift trucks and falling tools.
2. Increase the level of NDE inspection capability. Kissing debonds, very thin foreign objects, and microcracks and porosity of various sizes and widths must be detectable.
3. Improve our understanding of residual cure stresses that lead to warping in large composite structure is needed. Bad fit-ups require large external forces on warped composites to match bonding surfaces, especially large surfaces. This leads to severe external stresses that should not be present in large composite assemblies.
4. Non-autoclave curing will be required for structures larger than 30 feet in diameter. For Ares 1 and 5, matrices and cure cycles that do not require autoclaves are needed for potential weight savings. Cure stresses and fabrication times will also be reduced with non-autoclave curing.
5. NASA planning teams have evaluated various technologies that are enabling for an RLV. They indicate that “extensive development of structures and materials technologies will be required to enable an RLV that will replace the Space Shuttle.” [3]

6. Development activities are needed to improve the quality, reproducibility, and quality assurance of composites to the point where safety factors imposed on composites are no more than those imposed on metals. The severe penalty currently being leveled on composites takes away all the weight savings. To increase confidence to the point where safety factors for composites are no more than for metals, the knowledge gaps need to be filled. At an upcoming WSTF 2009 Composite Pressure Vessel and Structure Summit, some of the following questions will be considered. [9] They are worth contemplating for RLV cryotanks.
 - a. Should long-term strength testing (e.g., stress rupture testing) be considered in composite design methodology?
 - b. Should we establish a meaningful life factor on cyclic life or damage tolerance life? Do we know enough about the mechanical properties of composites to do this?
 - c. Should we consider damage tolerance and fracture toughness in the design criteria to establish safe life?
 - d. Do we know enough about the potential failure mechanisms and coupling effects in composites for various ground and flight environments?
 - e. Should there be different design requirements for constructing resin-based composite tanks when different fluids are used, (i.e., gas vs. liquid) in order to determine long-term stress or pressure rating?
 - f. Who should be responsible for modifying or developing standards that do not exist for this new technology?

References:

1. Schweikle, D., "DC-XA Incident Investigation Summary," Briefing to the NASA DC-XA Mishap Investigation Board, August 5, 1996.
2. Sawyer, J. W., "Graphite-Composite Primary Structure for Reusable Launch Vehicles," Paper Number AIAA-96-4268, presented at the 1996 AIAA Space Programs and Technologies Conference, American Institute of Aeronautics and Astronautics, 1801 Alexander Bell Drive, Suite 500, Reston, VA 22091, September 24-26, 1996.
3. An Assessment of the State-of-the-ART in the Design and Manufacturing of Large Composite Structures for Aerospace Vehicles, Harris, C. E., Starnes, J. H., Jr., and Shuart, M. J., NASA TM-2001-210844, NASA Langley Research Center, Hampton, VA 23681-2199, April 2001.
- 4a. Sawyer, J. W., Bush, H., and Sutter, T. R., "Experimental Investigation of a Graphite-Composite Wing-Box section for a Reusable Launch Vehicle," Proceeding of The Space Technology and Applications International Forum, CONF-970115, El-Genk, M. S., Ed., American Institute of Physics, New York, AIP Conference Proceedings No. 387, vol. 1, No. 3, January 26-30, 1997, pp. 1245-1258.
- 4b. Palm, T., Mahler, M., Shah, C., Rouse, M., Bush, H., Wu, C., and Small, W. J., BMI Sandwich Wing Box Analysis and Test, 4th Structures, Structural Dynamics and Materials Conf., AIAA, Atlanta, GA, April 1-6, 2000, Paper 1342.
5. Sawyer, J. W., and Bush, H., "Experimental Investigation of a Graphite-Composite Intertank Section for a Reusable Launch Vehicle," Proceedings of the Space Technology and Applications International Forum, 3rd Conference on Next Generation Launch Systems, CONF-980103, El-Genk, M. S., Ed., American Institute of Physics, New York, AIP Conference Proceedings January 25-29, 1998, pp. 1007-1019.
6. Anon, "Reusable Composite Hydrogen Tank System (RCHTS) TA-1 Final Tank Design Report," Boeing Internal Report, Huntington Beach, CA, June 20, 1997.
7. Meredith, B., Palm, T., and Deo, R. "Low Cost Manufacturing of Composite Cryotanks," Aerospace Manufacturing Technology Conference and Exhibition, Hartford, CT, June 3-7, 2002.
8. Anon, "Final Report of the X-33 Liquid Hydrogen Tank Test Investigation Team," National Aeronautics and Space Administration, George C. Marshall Space Flight Center, Huntsville, Alabama 35812, May 2000.
9. Central questions to be addressed, WSTF 2009 Composite Pressure Vessel and Structure Summit, NASA White Sands Test Facility, Las Cruces, NM, September 22-24, 2009. (Google: nasa space structures composites safety factors).

ARES I and ARES V Launch Vehicles [Figure 25]

NASA is developing a new launch vehicle fleet to fulfill the national goals of completing the International Space Station, retiring the space shuttle, and developing the launch capability to not only retain human access to low Earth orbit (LEO), but also to continue exploration of the Moon as a stepping stone to destinations beyond the Moon. Architecture studies and subsequent design activities were focused on safe, reliable operationally efficient vehicles that could support a sustainable exploration program. The architecture that best met those needs consisted of two vehicles, the Ares I and Ares V, (Figure 25). Derived from proven

technologies from the Saturn, Shuttle, and contemporary launch vehicle programs, they will be the first new launch vehicles developed by NASA for human exploration purposes in more than 30 years.

Continuing progress has been made toward design, component testing, and early flight testing. The Ares I Crew Launch Vehicle will be capable of carrying 6 crew to ISS and 4 to the Moon. First flight test is scheduled in 2010 and initial operational capability is planned for 2015. The Ares V Cargo Launch Vehicle is being designed to launch the Earth Departure Stage (EDS), Altair and Orion to Low Earth Orbit for lunar missions. The ARES V is the largest launch vehicle ever designed. Concept design work is ongoing. Detailed development work is scheduled to start in 2011. First flight testing is planned for 2018. An Ares V Cargo Launch Vehicle version is also being designed to provide a heavy lift capability for Science and Exploration missions. It is designed for routine crew and cargo transportation to the Moon (EDS + Altair to LEO) and (EDS + Altair + Orion to TLI). This system will be capable of transporting more than 71 metric tons to the Moon.

Composites are being studied for the Payload Shroud, the intertank structure in the Earth Departure Stage (EDS) and for the intertank structure of the Core Stage. Research is also being conducted on technologies to enable composite cryotanks. This work is addressing key issues like the need for microcrack resistant resins, development of non-autoclave cure resins, structural concepts, NDE methodology for complex structural elements, and refinement of buckling factors for compression loaded cylinders.

Lesson Learned:

Although major technology advancements have been realized for aircraft structures there are specific design requirements for an optimized large space launch system that require additional technology advancements.

References:

<http://spaceflight systems.grc.nasa.gov/LaunchSystems/AresV/>

ARES V Technology Needs [Figure 26]

In a recent presentation entitled “Lunar Program Industry Briefing: Ares V Overview” by Steve Cook, Manager Ares Projects Office, he outlined the Ares V Technology needs, shown on Figure 26 [1]. Composites were identified as one of the 6 key technology areas and 8 of the 15 top priority activities deal with composites. One of the challenges has to do with the size of the cryogenic tank which poses a challenge for fabrication of very large components. There are no existing autoclaves large enough to cure a full size barrel section of the 33 ft. diameter cryogenic tanks. High performance non-autoclave curing resins are needed if full barrel sections are to be fabricated without longitudinal joints. These resins must exhibit high damage tolerance and should not microcrack at cryogenic temperatures after repeated tank filling cycles. Also joining technology is required that will be reliable at cryogenic temperatures and can sustain high loads. Inspection methodologies or IVHM techniques are needed to insure flight readiness of the structure. Another issue is detailed understanding of buckling factors for the cylindrical composite structures under high compression launch loads for cases where there may be imperfect cylindrical composite shells.

Lessons Learned:

One of the major findings from the studies to date is the need for non-autoclave cure resins for building very large (33 ft. diameter for ARESV Cryotank) damage tolerant flight worthy aerospace structures.

References:

1. http://www.nasa.gov/pdf/278840main_7603_Cook-AresV_Lunar_Ind_Day_Charts_9-25_Final_rev2.pdf

NASA Composite Crew Module (CCM) [Figure 27]

NASA has begun a major initiative to reduce costs and lighten payloads through increased use of composites in future space structures. Composite Crew Module (CCM), which forms the inner crew cabin or pressure vessel of the ARES I launch vehicle, is based on the architecture of NASA's Orion crew module. The module is designed to transport astronauts to the International Space Station, as well as into lunar orbit in NASA's next lunar landing mission. Both the Orion crew module and the CCM demonstrator will be similar in shape to the earlier Apollo spacecraft but significantly larger, with more than 2.5 times the interior volume of the Apollo capsule.

In 2006, the NASA Engineering and Safety Center (NESC) studied the feasibility of a composite crew module (CCM) for the Constellation Program Crew Exploration Vehicle. The overall finding indicated a composite crew module was feasible, but a detailed design would be necessary to quantify technical characteristics, particularly in the areas of mass and manufacturability. Subsequently the NESC was chartered to design, build, and test a composite crew module structural test article with the goal of developing a network of Agency engineers with hands on experience using structural composites on complex spacecraft design. The NESC Composite Crew Module (CCM) Project was chartered in January of 2007, with a goal of delivering a full-scale test article for structural testing 18 months after project initiation. The project team was a partnership between NASA and industry, which included design, manufacturing, and tooling expertise.

Structural Features of Composite Crew Module (CCM) [Figure 28]

One unique feature of the composite crew module design is the structural integration of the packaging backbone with the floor and pressure shell walls. This provides a load path that accommodates load sharing with the heat shield, especially for water landing load cases. Another unique feature of the composite design is the use of lobes between the webs of the backbone. This feature puts the floor into a membrane type loading resulting in a lower mass solution. Connecting the floor to the backbone and placing lobes into the floor resulted in mass savings of approximately 150 pounds to the overall primary structural design [2].

A summary of the structural analyses and composite material analyses performed for design of the full scale CCM are presented in [3]. During the progression of design and analysis maturity, three major classifications of analyses were carried out: (1) analysis for sizing optimization which included architectural trade studies, optimum honeycomb sandwich design and optimum composite lay-ups, (2) analysis for failure margins-of-safety for acreage areas which included panel buckling, composite strength failure and damage tolerance and sandwich specific face

sheet wrinkling and core shear and 93) analysis for fabrication/manufacturing features which included cutouts, sandwich ramp downs, laminate ply drops, fabric ply overlap regions, and fiber angle alignment.

The CCM is constructed in two major components: an upper and lower pressure shell. The two halves are joined in a process external to the autoclave to enable subsystem packaging of large or complex subsystems. Building block tests of critical design and technology areas were conducted to validate critical assumptions and design allowables. Full-scale fabrication of the upper and lower pressure shells began in 2008. Successful testing of CCM was carried out in July 2009. Mike Kirsch has presented a review on CCM project [3].

Lessons Learned:

1. Non-autoclave splice allows concurrent fabrication, assembly, and integration of major structural components and subsystems and provides lower cost cure tooling option
2. Membrane lobed floor integrated with backbone subsystem packaging feature offer weight savings (~ 150lbs) through complex shapes enabled by composites
3. State of the art Pi-preforms offer robust orthogonal composite joints
4. Inner mold line tooling offers opportunity to optimize or change design through tailoring of layups or core density, as loads and environments change with program maturation
5. Composite solutions offer lower part count resulting in a lower drawing count (~47) which helps reduce overall life cycle costs
6. Numerous (>15) analytical models using various modeling techniques with overlaps to verify results
7. Element testing confirmed failure mode and failure load predictions
8. Thermal and dynamic differences from aluminum being investigated; preliminary estimates do not indicate that composite create any system level issues
9. Mature commercially available inspection equipment; IR thermography, ultrasound, and X-ray was judged to be satisfactory.

References:

1. Craig Collier et al. "Analysis Methods used on the MASA Composite Crew Module (CCM), AIAA, 2008, <http://hypersizer.com/pdf/AIAApaperCollierCCM107727.pdf>
2. NASA Engineering & Safety Center (NESC), 2008 Technical Update http://www.nasa.gov/pdf/346545main_NESC08TechUp_web.pdf
3. Mike Kirch, "Broad Based Teams, Case Study # 1 – Composite Crew Module", presented in Project Management Challenge 2009, Daytona Beach, Florida, Feb 2009 [Teamshttp://pmchallenge.gsfc.nasa.gov/docs/2009/presentations/Kirsch.Mike.pdf](http://pmchallenge.gsfc.nasa.gov/docs/2009/presentations/Kirsch.Mike.pdf)
4. "Team Gains Experience as it Builds Innovative Composite Spacecraft", http://www.nasa.gov/offices/nesc/home/Feature_6_090908.html

Multi-Scale Modeling [Figure 29]

This may well be the dawn of the “quantum age” in engineering analysis because we now have the computational power sufficient to link atomistic and macroscopic behavior of materials and structures. Heisenberg published his first paper on quantum mechanics in 1925 (*Z. Phys.*, 1925, 33, 879) to begin the quantum age, but its power in providing for the modeling of molecules of interest had to wait for the advent and development of modern high speed computing. The significant confluence of advances in the scientific and engineering competencies has brought significant benefit to developing the next generation of ultra-high fidelity failure initiation predictions for composite materials and structures. At the base is computational power where computational rate in 1970 was 1 calculation per second per \$1000 and by 2010 it will exceed 10,000,000,000. This revolution allowed for simultaneous development of molecular modeling and finite element methods wherein millions of degrees of freedom are common place. The next vital step that has achieved a level of maturity is multi-scale modeling wherein the results at one scale can be handed off to the next without loss in fidelity.

NASA Langley’s pioneering efforts in this area were led by J.A. Hinkley and T. S. Gates. Under their leadership and in collaboration with other Langley scientists and engineers, the two forged a program with the objective of linking molecular phenomena to macroscopic behavior of polymer composites. Molecular modeling, based in quantum physics, was the starting point of the work, but new, coarse grained analytical methods were developed by K. E. Wise and G.M. Odegard at Langley (*Composites Science and Technology*, Vol. 62, no. 14, pp. 1869-1880 (2002), *Composites Science and Technology*, Vol. 63, no. 11, pp. 1671-1687 (2003) and *AIAA Journal*, Vol. 43, no. 8, pp. 1828-1835 (2005)). Developing a suitable periodic configuration for a typical composite matrix material, an amorphous polymeric system, requires considerations that ensure configurations in which backbone bond conformer populations are representative of those which would be found with significant probability in the material being studied. Once the molecular model of the polymer is constructed, it is possible to interrogate the polymer deformation characteristics with the goal of determining their character and assessing multiple phenomena important at the nano, meso and macro scales.

The Hinkley-Gates approach is illustrated in Figure 29 where molecular assembly is modeled with molecular fragments, bond angles and force fields which are used to assemble complex molecular structures. Molecular dynamics simulations are limited in size and atom count and therefore, an infinite network is not feasible for modeling. Salient microstructural features that control macroscopic behavior are the focus of predictive simulation. At the micro level phenomena such as surface interactions, phase orientation, crystalline structure, molecular weight and free volume of the molecular structure are important in predictions behavior. Finally, the effective properties at each scale are delivered to the next greater scale to provide a continuous analytical pathway between quantum and macro levels.

The results developed at the nano scale are handed off to models at the micro scale where the fiber matrix heterogeneity are considered. These homogenization steps capture the essential features of the lower scale to provide the properties of the individual phases at the greater scale. Fiber, matrix and interphase properties are combined in micromechanical analyses to yield composite behavior. Finally, the advances in macroscopic structural analysis based on finite element analyses provide the macroscopic models for prediction of composite structural response.

The Hinkle-Gates approach provides an extraordinary opportunity to develop ultra-high fidelity failure initiation predictions for composite structures and can provide for increases in the level of optimization of composite structure not possible with today's methods of analysis.

Grand Challenges in Multi-Scale Modeling

The extraordinary opportunity to develop ultra-high fidelity failure initiation predictions for composite structures can provide for increases in the level of optimization of composite structure not possible with today's methods of analysis. These methods can provide the foundation for failure propagation under cyclical loading and probabilistic characteristics of materials, geometry and loadings. Since the actual physical chemistry of the polymeric phase can be related directly to structural performance, these methods can be used to develop new classes of polymers and nano-reinforced polymers to meet more advanced airframe requirements of the future. Finally, these methods can be a first step to certification of composite structure by analysis wherein the scale of experimental testing can be substantially reduced.

Challenge 1: To develop molecular models of aerospace polymers that predict the mechanisms of irreversible behavior and long term response.

Challenge 2: To connect molecular models to meso models to micro models to macro models without interruption so that molecular phenomena can be connected to macroscopic behavior of composite structure.

Challenge 3: To develop high fidelity models for damage propagation in multi-axial composite laminates that track multiple damage paths simultaneously.

Challenge 4: To gain acceptance for the use of multi-scale analysis to reduce the costs of experimental testing associated with flight certification of composite structure.

Challenge 5: To develop, with multi-scale analysis, new polymer matrices that provide enhanced composite structural performance.

Future Challenges [Figure 30]

Economical, environmental, and safety requirements for tomorrow's air vehicles will dictate bold new designs. The continued evolution of computational capabilities will enable revolutionary new vehicles to be designed analytically. Rapid multidisciplinary design of future vehicles will be enabled by multi-scale modeling of integrated vehicle design requirements down to the molecular level where the resin chemistry will be optimized for expected loads, processing requirements, environmental service factors, and long-term durability. Composites for these new designs will likely be multifunctional with built-in sensors and actuators. The damage tolerance of these integrated composites must exceed that of current generation materials. Some of the major research challenges are listed below.

1. Certification by Analyses
 - a. Multi-Scale Modeling
 - b. High Fidelity Structural Analyses
 - c. Validated Materials and Processes
 - d. Verifiable Composite Integrity
2. Computational Design of Polymer Chemistry and Processing
 - a. Validated Structure/Property Relationships

- b. Processing Science Mathematics
 - c. Validated Algorithms
- 3. High Performance Non-Autoclave Curing Resins
- 4. NDE Technology for Quantative Assessment of Adhesive Bond Strength
- 5. Self Healing Composites
- 6. Self Diagnostic Structures
- 7. Reliability Based Design
 - a. Materials, Processing, Inspection
 - b. Loads and Environment
- 8. Achieving near Theoretical Properties for Nanocomposites
- 9. Eliminating the need for Regularly Scheduled Teardown Inspections of Composite Airframes
- 10. Morphing Structures Optimized for Different Flight Regimes
- 11. Tool less Manufacturing
- 12. Academic Training for Future Composite Engineers (Chemist, Designer, Analyst, Fabricator, Certifier)

Concluding Remarks

Composite technologies have matured over the past 40 years to the point where high performance composites are being used to enhance the performance of nearly every new flight vehicle. Primary load carrying structures on both military and commercial aircraft have proven to be environmentally durable and to perform well in real world service environments. Standard test methods have been established for test and evaluation of composites made from many different material combination forms and by a host of different fabrication approaches. Fabrication technology has evolved from hand layup to automated processes capable of producing large complex integral stiffened structures. Damage tolerant designs have evolved and progressive damage analyses codes are being used to reasonably well predict failure loads in parts with substantial damage.

NASA has played a significant role in advancing composite technologies for aircraft and launch vehicles. The work at NASA provided important contributions to the foundational technologies underpinning the design, analyses and certification of airworthy flight composite structures. Major elements of those contributions can be found in the open literature on almost any topic or area that involves composites. From this research, lessons have been learned and many of these are noted in this paper. Some additional more global observations from the NASA research are included here for future guidance to the next generation of composite engineers who will have even more opportunities to advance the science of flight by designing and building ever more capable flying machines.

Overall Lessons Learned from NASA R&D

1. There are no single discipline problems; there are only multidiscipline problems. The intersection of disciplines is a fertile ground for new breakthroughs. Many seemingly

- “discipline issues” have their genesis in a neighboring discipline and understanding the requirements in all neighboring disciplines is essential to solving real world problems.
2. Bounds of problems are defined by Laws of Physics, Economics, and Time. All must be considered when searching for solutions.
 3. Processing, fabrication, and manufacturing considerations need to be part of early design process.
 4. Processing studies needs to be an integral part of all new materials development research from the start. It does no good to synthesize a new polymer that can not be processed into useful engineering shapes and product forms. Resin formulations have commonly been based on optimization of mechanical and physical properties. Changes to enable fabrication of large structural components have typically led to compromises in early properties data bases. (Examples are found in the CAST and HSR Programs)
 5. “Building Block” approach proved to be invaluable for fundamental understanding of failure mechanisms and accurate prediction of failure loads in complex built-up structure and will continue to be useful as more complex hybrid composite structures are designed for revolutionary new concept vehicles.
 6. Similar R&D in different sectors can be a rich area for cross fertilization (A good example is the transport of algorithms from the Pharmaceutical Industry into the field of high performance polymers for molecular level modeling.
 7. Over the past 3 decades, composite materials have enabled a new S curve for flight weight structures. We did not know how to: Process, Characterize, Predict Properties, Predict Cost, Evaluate environmental durability, Analyze joints, Predict load transfers in built-up structure, Predict structural failure, or Certify airworthiness of flight vehicle structures. Many of these barriers have been overcome. However, the degree of variability and uncertainty in composite structural properties still result in safety factors larger than acceptable values for metallic structures. Increasing reliability of composites by reducing uncertainty factors and variability in properties can result in additional weight savings in flight weight structures.
 8. Multifunctional composites, that sense, compute and react represent a new and emerging S curve for structural materials. With built-in sensing, computing, and actuating there are emerging new frontiers for structures that self tailor their properties for changing flight conditions. Imbedded devices that carry loads and do not weaken the structure by serving as incubation sites for damage initiation is one of the major challenges to be overcome.
 9. Highly productive R&D organizations have a well understood set of Research Principles and Values that are known and followed. These include:
 - a) Shared commitment: to excellence, to good scientific principles, to integrity, to search for the truth
 - b) Peer interaction to insure relevance and excellence
 - c) Systematic and sustained interface with neighboring disciplines
 - d) Highly skilled and trained staff
 - e) Cutting edge facilities and equipment
 - f) State-of-the art computational capability
 - g) Selection of the “right problems” to work
 - h) Versatility and ability to change rapidly
 - i) Teaming (within the discipline and across disciplines).
 10. Organizational principles that promote excellence include but are not limited to:

- a) Interdisciplinary research
 - b) Cross-sector interactions
 - c) Career growth assignments
 - d) Rewards system that encourages completion and documentation of results
11. NASA research has focused on technologies for public good (To insure safety, improve efficiency, & enhance capability of air travel and space missions (launch, space science, communications, etc.)
12. In the future, NASA must continue to conduct potentially high risk/high payoff R&D to enable new concepts and exploitation of new technologies that have potential to provide public good.

Application of Composites on Flight Vehicles



- Structural Components**
 Fuselage
 Wings
 Elevators
 Vertical Stabilizers
 Rudders
 Ailerons
 Doors
 Rotors
 Tank Structure

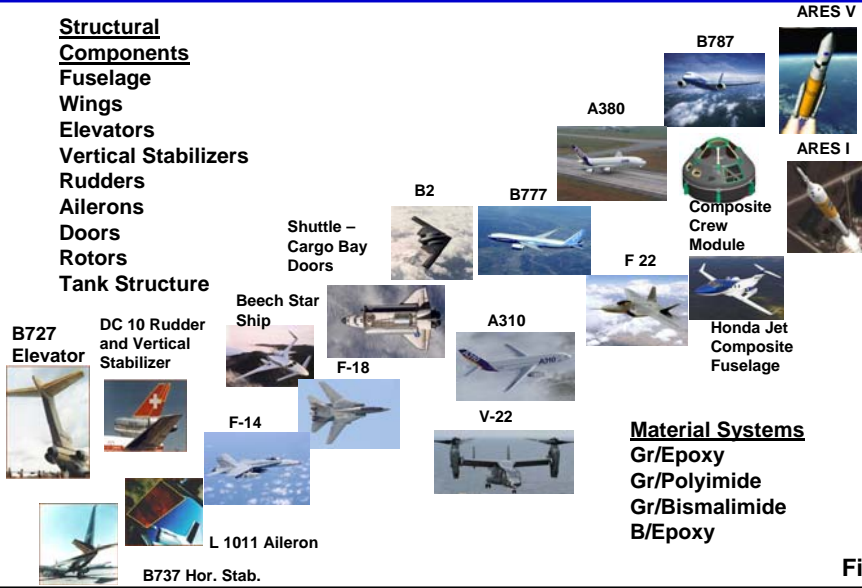

- Material Systems**
 Gr/Epoxy
 Gr/Polyimide
 Gr/Bismalimide
 B/Epoxy

Figure 1

Composites in Commercial Transport Aircraft

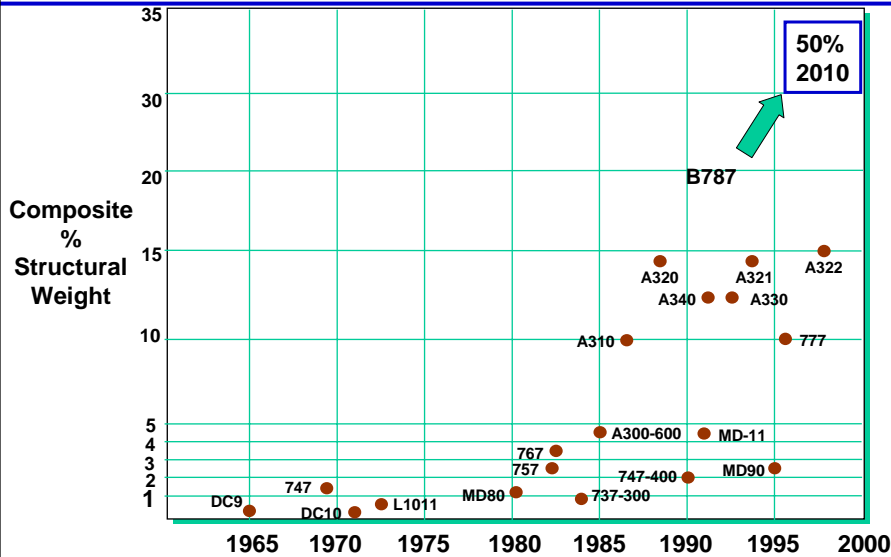

Figure 2

Composites in US Fighter Aircraft

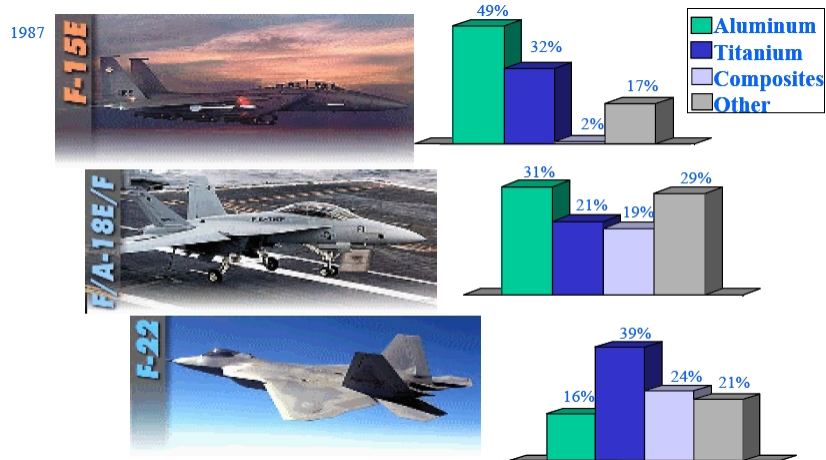

Figure 3

Flight and Ground-Based Exposure of Composite Materials

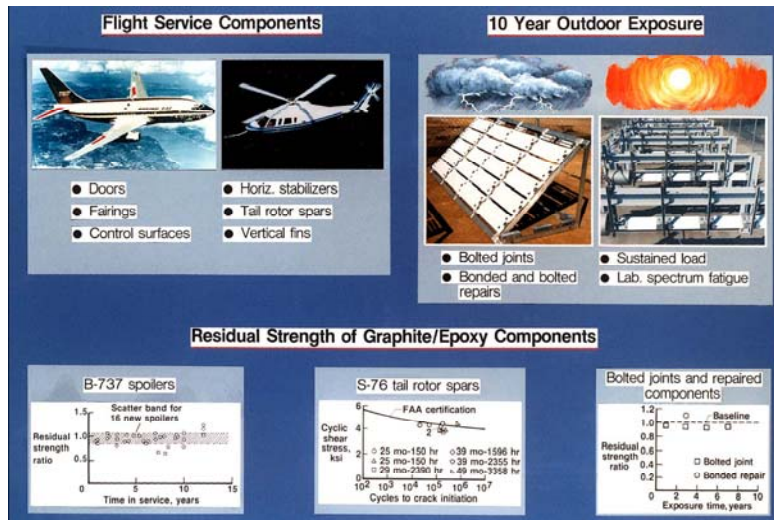

Figure 4

ACEE Developed Composite Components Placed in Flight Service



Figure 5

NASA Composite Structures Flight Service Summary



Aircraft Component	Total Components	Start of Flight Service	Cumulative Flight Hours	
			High Time Aircraft	Total Component
L-1011 Fairing panels	18 (15)	January 1973	52,610	742,630
737 Spoiler	108 (33)	July 1973	45,260	2,747,760
C-130 Center wing box	2 (2)	October 1974	10,920	21,520
DC-10 Aft pylon skin	3 (2)	August 1975	45,640	107,840
DC-10 Upper aft rudder	15 (10)	April 1976	58,340	519,430
727 Elevator	10 (8)	March 1980	40,930	336,610
L-1011 Aileron	8 (8)	March 1982	31,720	249,480
737 Horizontal stabilizer	10 (8)	March 1984	19,620	189,800
DC-10 Vertical stabilizer	1 (1)	January 1987	17,580	17,580
S-76 Tail rotors and horizontal stabilizer	14 (0)	February 1979	5,860	53,150
206L Fairing, doors, and vertical fin	160 (51)	March 1981	11,325	440,000
CH-53 Cargo ramp skin	1 (1)	May 1981	5,000	5,000
Grand total	350 (139)			5,377,650

() Still in service

June 1991

Figure 6

Advancements in Epoxy Composites Over Four Decades

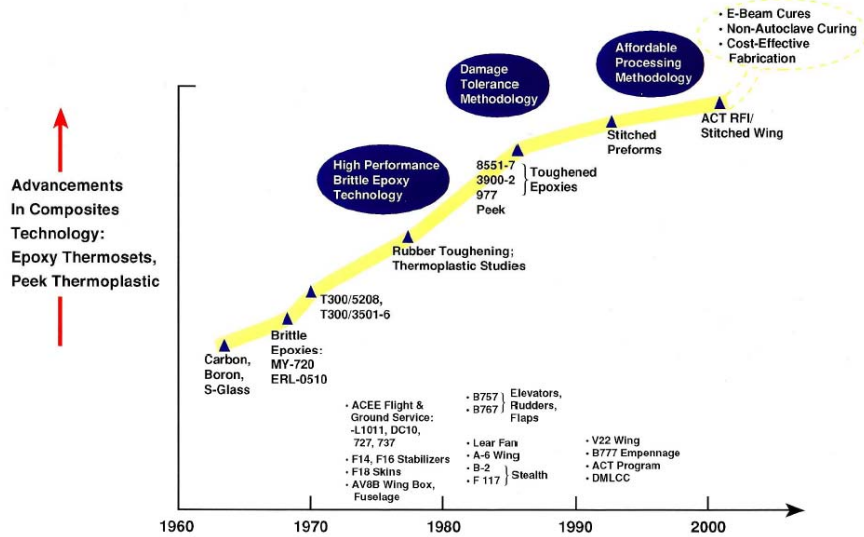
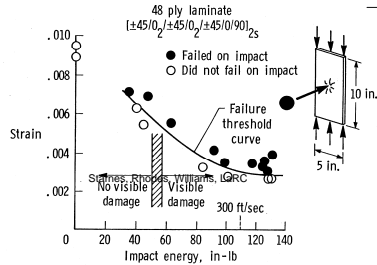

Figure 7

Major Problem: Damage Tolerance



EFFECT OF PROJECTILE IMPACT ON COMPRESSION STRENGTH



- Solution: Toughened Composites**
1. Develop crack-resistant matrices
 2. Create inserts that prevent delamination

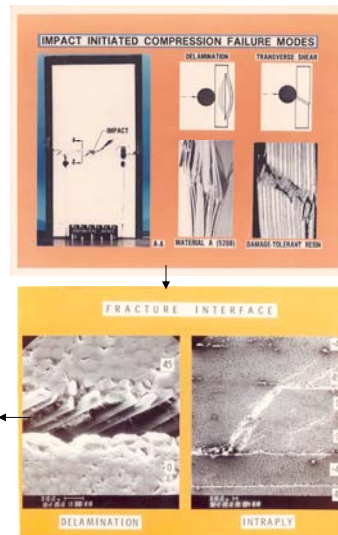

Figure 8

Tests for Interlaminar Fracture Toughness of Composite Laminates



- Double cantilever beam flexure test (tension)

Hunston, NIST

- Edge delamination tensile test (mixed tension/shear)

O'Brien, LaRC

- Cracked lap shear test (mixed tension/shear)

- End-notched flexure test (shear)

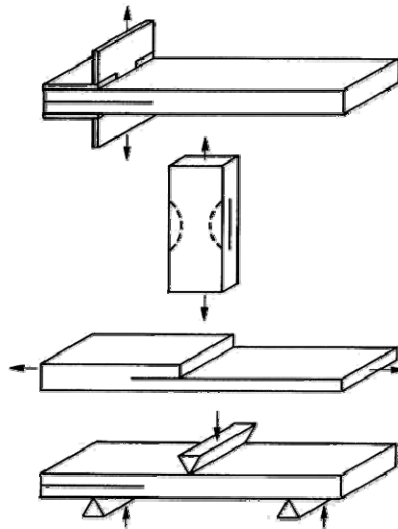

Figure 9

Aero Structural Composites Fabrication Technology - Carbon Fiber Reinforced/Polymer Matrices -

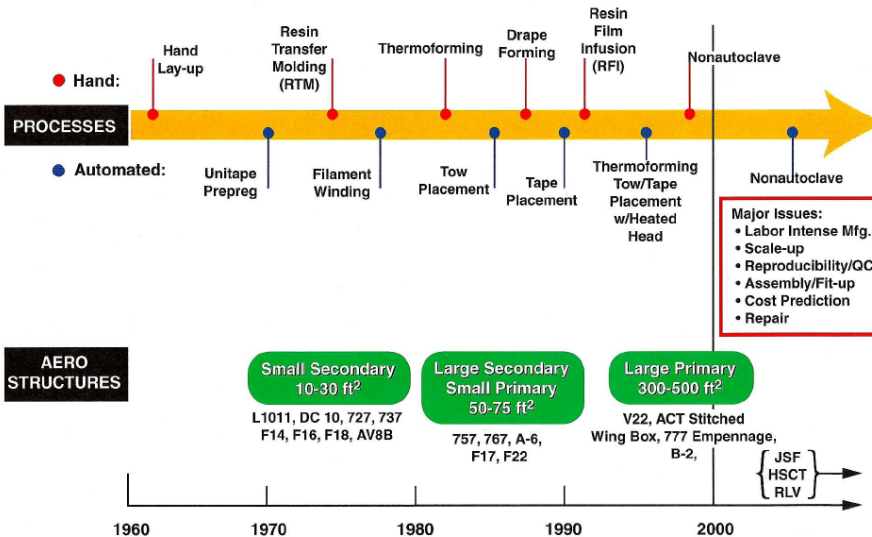
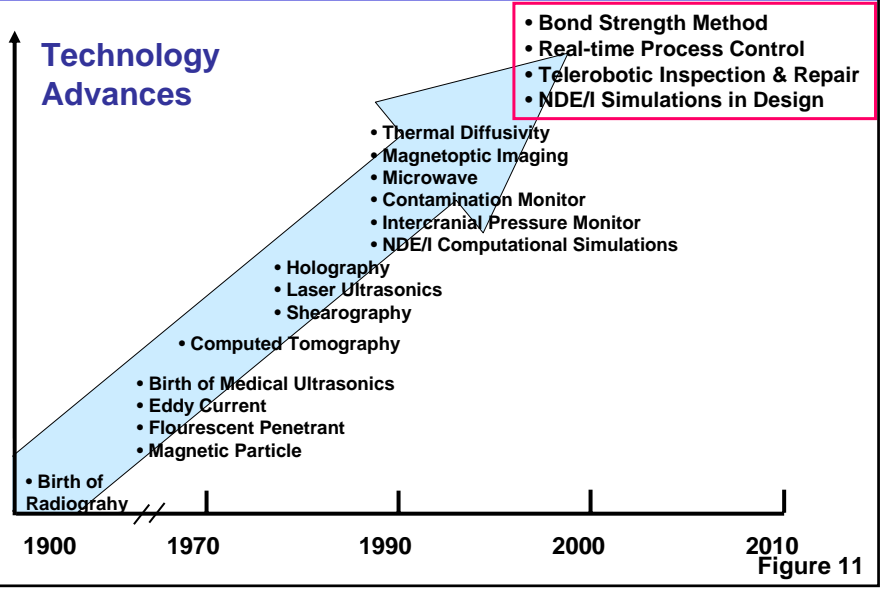

Figure 10

Evolution of NDE/I Technology for Composites



NASA Research – Textile Composites

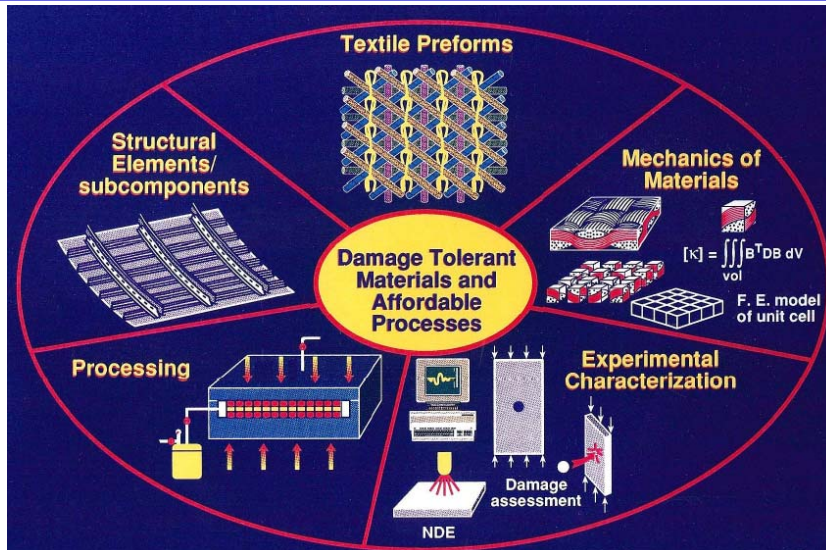
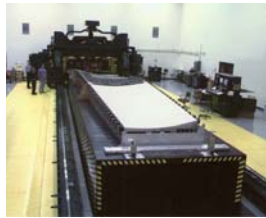

Figure 12

ACT Program Developed Advanced Wing Stitching Facility



Stitched-RFI Offers Break Through in Cost Reduction



MDXX Cost Parameters (CY96 M\$)	Aluminum Wing Box Cost	S/RFI Wing Box Goal Cost	S/RFI Cost	Program Performance Goal vs. Actual	Program Performance Actual
Structural Wing Box (Cum. Avg., 300 Ships)	\$3.181	\$2.544	\$2.557	-20.0%	-19.6%
Structural Wing Cover (Cum. Avg., 300 Ships)	\$1.516	\$1.147	\$1.160	-24.3%	-23.5%
Wing Substructure (Cum. Avg., 300 Ships)	\$0.461	\$0.429	\$0.429	-6.9%	-6.9%
Wing Assembly (Cum. Avg., 300 Ships)	\$1.204	\$0.968	\$0.968	-19.6%	-19.6%

Figure 13

ACT Program Stitched-RFI Wing Subjected to 95% Design Ultimate Load

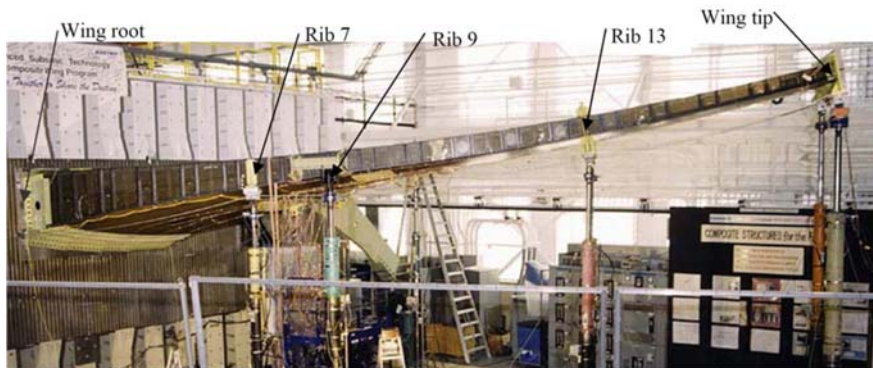
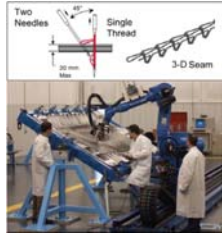

Figure 14

Recent Advancement in Stitched Composites



One-sided Stitching



PRSEUS (Pultruded Rod Stitched Efficient Unitized Structure)

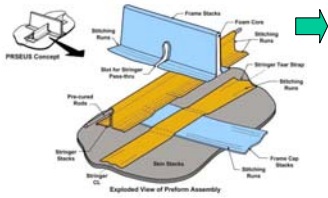

Figure 15

ACT Program Fuselage Development



Multidisciplinary Team Essential to Meet Costs Goal

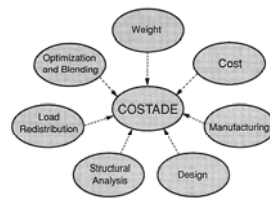
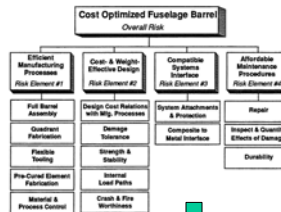
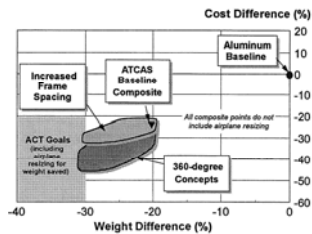
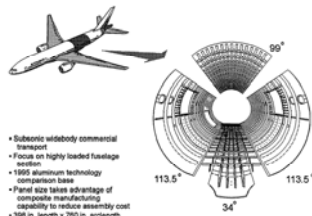

Figure 16

ACT Program Tape Laid Crown Panel



Test/Analysis Comparison for Internal Pressure Tests

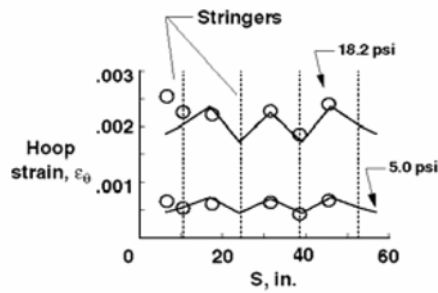
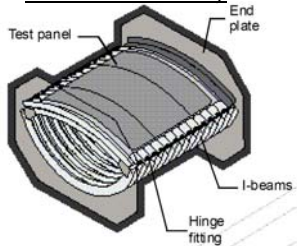

Figure 17

High Speed Transport Aircraft Program



D-Box Test Facility



Time-Temp.-Stress-Test

Materials Reliability Simulation Test (MaRST) Laboratory

- Temperature/Load simulated mission profile
- Static, Fatigue, Creep (Coupon - Element - Large Panel)
- Hydrothermal
- Temperature Range: +450°F to -320°F
- Cyclic temperature with and with out load

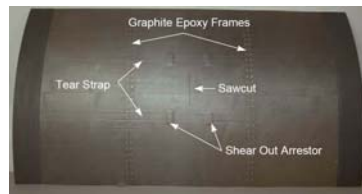

Fuselage Panel

Figure 18

High Temperature PETI-5/IM7 Skin Stringer Panel (6'x10')



Figure 19

NASA and FAA Cooperative Research



Technical Thrust Areas

Advancements depend on close integration between areas

Material Control, Standardization and Shared Databases

Structural Substantiation

- Advances in analysis & test building blocks
- Statistical significance
- Environmental effects
- Manufacturing integration

Bonded Joint Processing Issues

FAA and NASA R&D is currently active in most of these areas



Advanced Material Forms and Processes

Damage Tolerance and Maintenance Practices

- Critical defects (impact & mfg.)
- Bonded structure & repair issues
- Fatigue & damage considerations
- Life assessment (tests & analyses)
- Accelerated testing
- NDI damage metrics/service POD
- Equivalent levels of safety
- Training standards

Flammability & Crashworthiness

Support from cabin safety research groups

Figure 20

AGATE - Advanced General Aviation Technology Experiments



Crushed Tubes

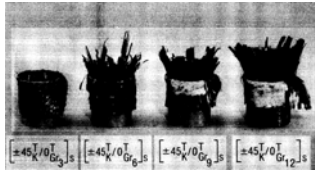

Honeycomb



Crushed Honeycomb



IDRF



Crash tests of Modified Lancair



Figure 21

USAF DC-A and NASA DC-XA Experimental Flight Vehicles



USAF DC-X Demonstrated:

- Vertical Take-off, Vertical Landing (VTVL)
- Aircraft-like Turnaround Times
- Single-Stage-To-Orbit Potential
- Reusable Launch Potential
- VTVL Autonomous Flight Operations
- Operability & Supportability
- 7 Successful Flights With Metallics



Composite LH₂ Cryotank

NASA DC-XA Demonstrated All of Above Plus Advanced Enabling Technologies:

- 44% Lighter Weight Composite Shell Intertank
- 34% Lighter Weight Composite LH₂ Cryotank
- Lightweight Al-Li LOX Cryotank
- LH₂-To-GH₂ Aux. Propulsion System
- Enhanced Avionics
- In-Situ Health Monitoring System
- Rapid Prototyping For Design & Fab.
- 4 Successful Flight Tests



Composite Shell Intertank

Figure 22

X-33 Advanced Technology Demonstrator



LH₂/LO₂ Tanks

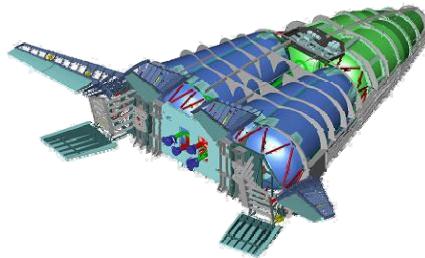

LH₂ Cryotank Assembly

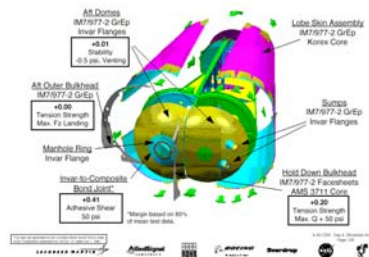

- Dimensions: 28.5' long, 20.0' wide, 14.0' high, 3836.8 ft³
- Loads: burst (internal), thrust (external)
- All-bonded 4- lobe conical shell; non-circular cross-section; sandwich
- Each lobe fabricated separately from 2 face sheets and Korex honeycomb
- Lobes bonded to 4 longerons running longitudinally through the tank
- Vertical and horizontal septums reinforce internal strength.
- To manufacture each lobe: over 20 steps; tank assembly: 9 curing/bonding steps

Figure 23

Technical Issues that Contributed to X-33 Tank Failure



Weak Core-Face Sheet Bond

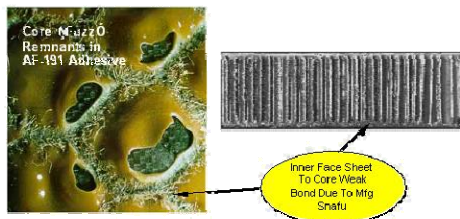

Teflon Tape in Core



10 Technology Issues

1. Microcracks (UF₂ Infiltration)
2. Cryopumping
3. Core-Facesheet Bond (Adhesive Out-Time)
4. NDE Inspection for PTFE Tape
5. Longeron Porosity
6. Upper and Lower C-Ring Close-Out Seals
7. Assembly Fit-Up (Residual Curing Stresses)
8. Sealing the Thrust Ducter Fittings (Design Issue)
9. TPS Attachment Loads and Temperature
10. Large Scale manufacturing and Process Scale-up

Inner Skin Microcracking

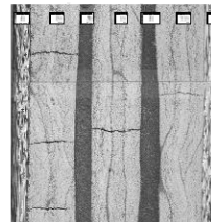

Figure 24

ARES I and ARES V Launch Vehicles



Figure 25

ARES V Technology Needs

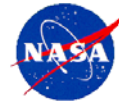

Nose Cone/Forward Skirt

Loaded Motor

Ares Value Stream

Key Technology Areas
Composites
Cryo Fluid Management
Solids
Automation
Liquid Propulsion
Control/Separation

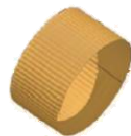

Core Stage All Skirt



Point of Departure Shroud (Biconic)

ETDP Technology Prioritization Process (TPP)

Ares V Technology Priorities

1. Large Composite Manufacturing
2. HTPB Propellant
3. Long Term CFM
4. Composite Damage Tolerance/Detection
5. EDS State Determination & Abort
6. Composite Joining Technology
7. Liquid Level Measurement
8. Multi Layer Insulation
9. Leak Detection
10. Non Autoclave Composites
11. SRM Composite Metal Technology
12. Composite Dry Structure Development
13. Composite Damage Failure Detection for Abort
14. Nozzle Sensitivity to Pocketing (High Heat Flux from HTPB)
15. LH2 Tank Micro Cracking

Figure 26

NASA Composite Crew Module (CCM)

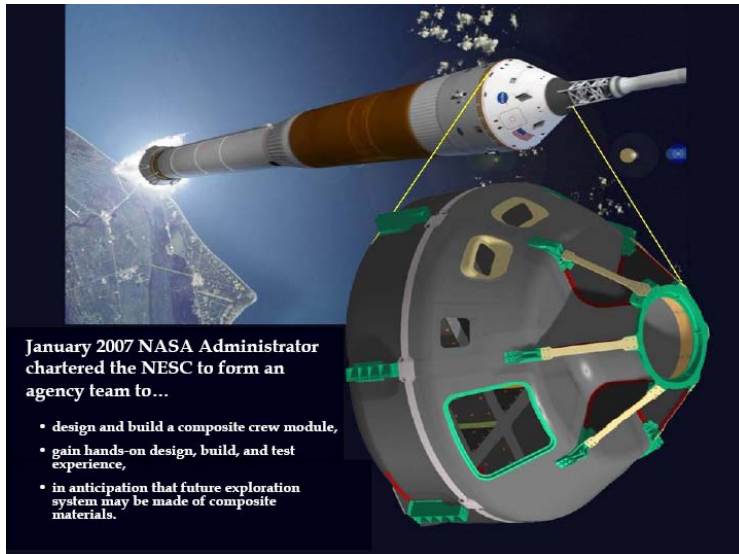

January 2007 NASA Administrator chartered the NESC to form an agency team to...

- design and build a composite crew module,
- gain hands-on design, build, and test experience,
- in anticipation that future exploration system may be made of composite materials.

Figure 27

Structural Features of Composite Crew Module (CCM)



Sandwich Acreeage

- Facesheet wrinkling and dimpling
- Core crushing and crimping

Laminate Acreeage

- Ply based analysis
- Damage tolerance
- CF allowables

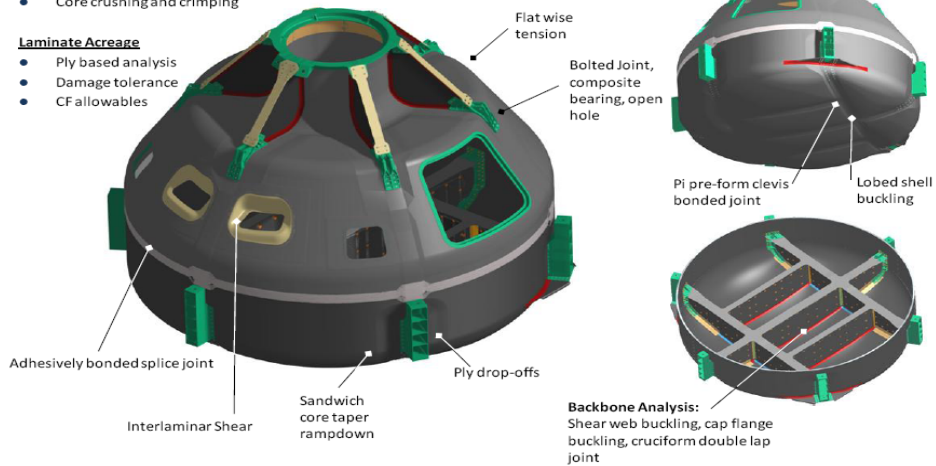

Figure 28

Multi-Scale Modeling



Computational Chemistry

Computational Materials

Computational Mechanics

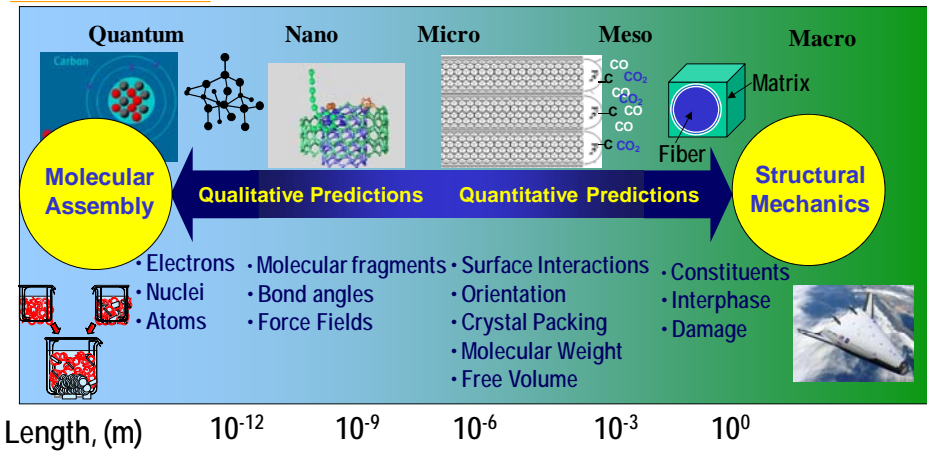

Figure 29

Future Challenges



Revolutionary Airframe Configurations



Low-Cost Composites Manufacturing

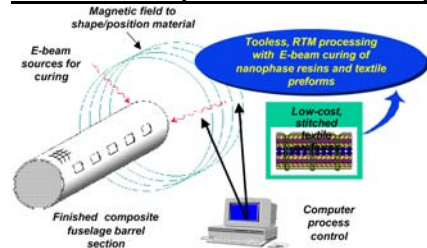

More Analyses-Fewer Tests

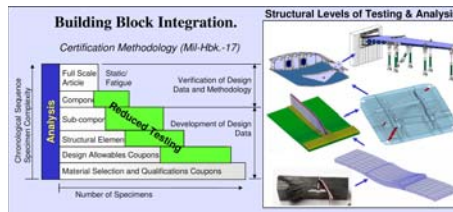

Figure 30

Concluding Remarks



- Composites have been and will continue to be a primary focus for NASA's structures and materials research for aerospace vehicles
- NASA has made major contributions to the fundamental technology required to build and certify composites primary structures for aerospace vehicles
- Major barriers have been overcome for application of composites on all classes of flight vehicles
- Composites are the materials of choice for reducing weight and cost of aerospace vehicles
- The emergence of hybrid structures with built in sensors and actuators will pose additional challenges for analyses and prediction of residual life
- Future grand challenges such as design by analyses will require significant improvements in understanding of damage initiation and propagation in complex structural elements

Figure 31