

# **Deliberate Satellite Fragmentations and their Effects on the Long-Term Space Environment**

Nicholas L. Johnson  
Chief Scientist for Orbital Debris  
NASA Johnson Space Center

38<sup>th</sup> COSPAR Scientific Assembly  
Bremen, Germany  
18-25 July 2010

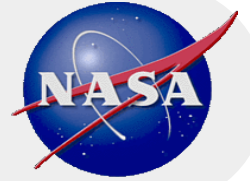

## Study Background

- **Since 1961, at least 205 satellites (spacecraft, launch vehicle orbital stages, or parts thereof) have been involved in breakups, as determined by the U.S. Space Surveillance Network (SSN).**
- **Of these, 58 have been assessed as having been deliberate in nature.**
  - USSR / Russian Federation: 52
  - United States 5
  - People's Republic of China 1
- **The objective of this study was to determine the nature, frequency, and long-term environmental effects of these deliberate satellite breakups.**

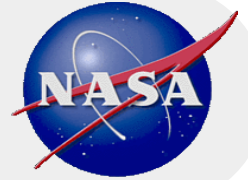

# Malfunctioning Recoverable Spacecraft

- **Soviet/Russian low altitude Earth observation spacecraft were designed to carry an explosive charge to destroy the recovery vehicle in the event of a malfunction which might lead to a landing outside of the intended region.**
- **1964-1993: 14 spacecraft exploded**
- **Maximum cataloged debris for one event: 248**  
**Maximum tracked debris for one event: 846**  
**Debris remaining in orbit 1 June 2010: 0**
- **Most breakups occurred below 300 km; highest breakup altitude was 390 km. Many debris reentered immediately, and the remaining debris normally reentered within a few weeks, hindering the debris cataloging process.**



Zenit 2



Yantar 4

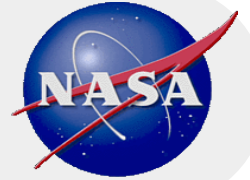

## Manned Spacecraft Precursor

- **Cosmos 57 was an engineering test vehicle for the Voskhod 2 manned mission with the first planned space walk. A ground signals error led to loss of control of the spacecraft, which was then destroyed by explosive charge to prevent errant landing of the command capsule.**
- **1965: 1 spacecraft exploded**
- **Maximum cataloged debris: 167**  
**Debris remaining in orbit 1 June 2010: 0**
- **The breakup event occurred at an altitude of 380 km, preventing the cataloging of all large debris. All cataloged debris reentered within six weeks.**

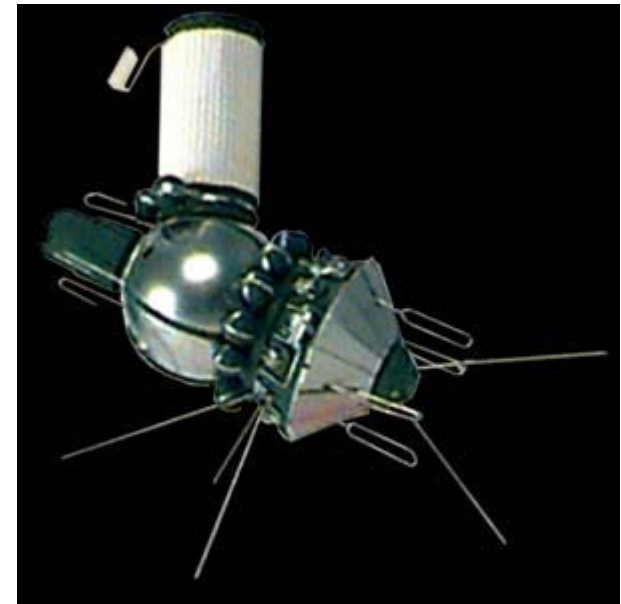

Cosmos 57

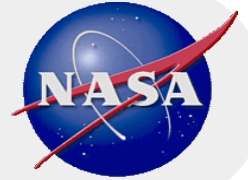

## Orbital Stage Engineering Test

- The unmanned Apollo-Saturn 203 mission was an early test of the Saturn IB launch vehicle and, in particular, of the Saturn IVB upper stage which would be used on the Saturn V launch vehicle for Apollo manned lunar missions. Following successful orbital insertion and testing, the propellant tanks were intentionally over-pressurized to failure to verify design margins.
- 1966: 1 orbital stage fragmented
- Maximum cataloged debris: 35  
**Debris remaining in orbit 1 June 2010: 0**
- The breakup event occurred at an altitude of 205 km, preventing the cataloging of all large debris. All cataloged debris reentered within three weeks.



Saturn IVB Stage

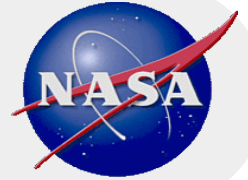

# Fractional Orbit Bombardment System (FOBS)

- The Soviet FOBS was designed to place a nuclear warhead into a low Earth orbit and to then execute a controlled reentry and impact on an enemy location before completing an entire revolution about the Earth. The first two tests of FOBS (without nuclear payloads) failed when the warheads were placed into higher than planned initial orbits. Both payloads were destroyed by on-board explosives.
- 1966: 2 payloads exploded
- Maximum cataloged debris for one event: 52  
**Debris remaining in orbit 1 June 2010: 0**
- The breakup events occurred at an altitude of 300 km or less, preventing the cataloging of all large debris. All but one cataloged debris reentered within six months.



FOBS Payload and Final Stage

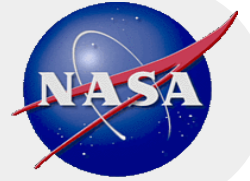

## Soviet Co-Orbital Antisatellite Tests

- A total of 20 tests of a Soviet co-orbital ASAT system were conducted from 1968 to 1982. In each test the weapon was discharged, fragmenting the interceptor. Only nine interceptors produced orbital debris; in the other 11 cases all debris were sub-orbital. During one test, four debris were released by the target satellite.
- 1968-1980: 9 interceptors and 1 target fragmented
- Maximum cataloged debris for one event: 139  
Total cataloged debris for all events: 736  
**Debris remaining in orbit 1 June 2010: 296**
- During the second phase of testing (1976-1982), only three orbital debris clouds were created out of 13 tests, and in each case the intercept was a failure.



Co-Orbital ASAT

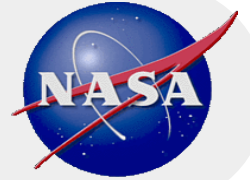

## Soviet Early Warning Satellites

- **Deployment of Soviet operational Oko satellites, designed to detect the launch of enemy ballistic missiles, began in 1976. Spacecraft launched before 1984 were equipped with explosive charges on their sensor focal planes. In the event of unplanned loss of spacecraft control, the charges were programmed to detonate. In all, at least 17 Oko satellites fragmented.**
- **1976-1986: 17 known fragmentations**
- **Maximum cataloged debris for one event: 25**  
**Total cataloged debris for all events: 167**  
**Debris remaining in orbit 1 June 2010: 151**
- **The nature of Oko highly elliptical orbits (initially 600 km by 40,000 km) hindered the detection and cataloging of debris.**

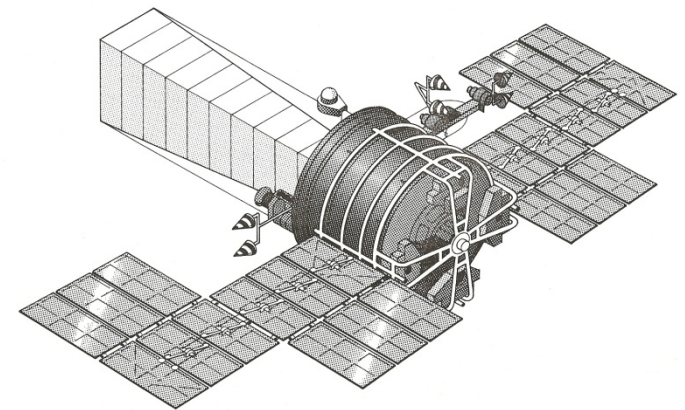

Oko



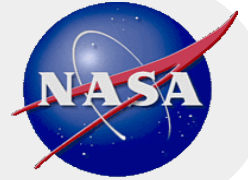

## Designed End-of-Mission Breakup

- Russian Orlets-1 low-altitude Earth observation satellites were designed for intentional fragmentation over the Russian Federation at end-of-mission.
- 1989-2006: 8 spacecraft fragmented
- Maximum cataloged debris for one event: 31  
Maximum tracked debris for one event: 179  
**Debris remaining in orbit 1 June 2010: 0**
- The breakup events occurred at an altitude of 270 km or less, preventing the cataloging of all large debris. All cataloged debris reentered within five weeks.

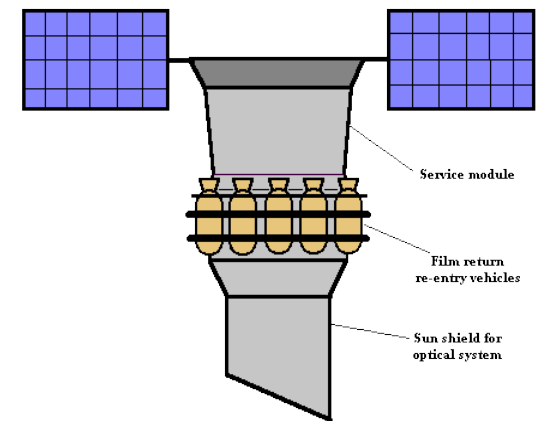

Notional Orlets-1

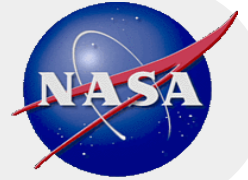

## U.S. Antisatellite Test

- The U.S. has conducted only one test of a proposed ASAT system which resulted in the creation of an orbital debris cloud. The Solwind (aka P-78) spacecraft was struck by an air-launched weapon at an altitude of ~525 km.
- 1985: 1 spacecraft struck by sub-orbital device
- Maximum cataloged debris: 285  
**Debris remaining in orbit 1 June 2010: 0**
- Although 95% of orbital debris reentered within six years, this event led to new Department of Defense, NASA, and U.S. government restrictions on the deliberate creation of orbital debris. The ASAT program which was the subject of this test was terminated and the system was never deployed.

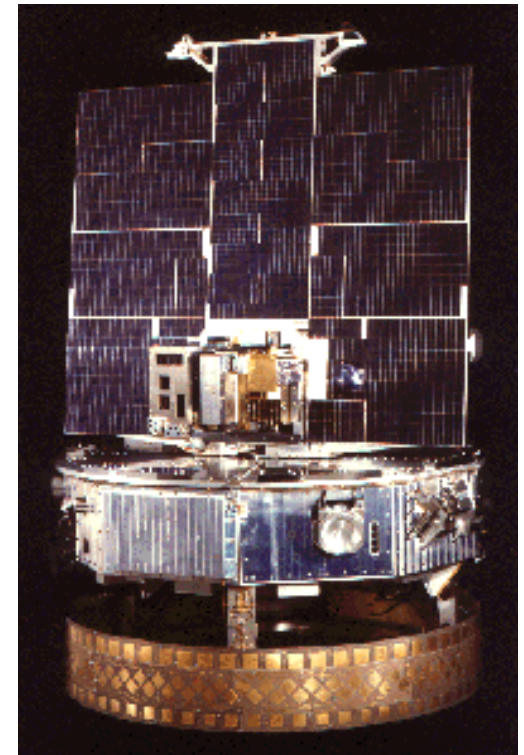

Solwind (aka P-78)

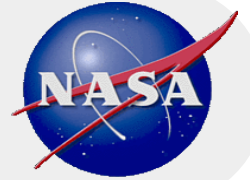

## U.S. Technology Test

- Under the U.S. Strategic Defense Initiative program, a one-of-a-kind test was conducted to determine the ability of a sensor to detect, to track, and to close-in on a thrusting space vehicle.
- 1986: Hypervelocity collision of a payload and its launch vehicle orbital stage
- Maximum cataloged debris: 18  
Maximum tracked debris: 381  
**Debris remaining in orbit 1 June 2010: 0**
- The breakup occurred at an altitude of 220 km, preventing the cataloging of all large debris. All cataloged debris reentered within seven months.



USA-19 and the upper portion of its Delta 2 second stage

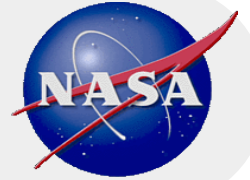

## Negation of Reentry Risk Hazard

- Following a complete loss of control shortly after its launch, USA-193 posed a threat to people on Earth from a large quantity of hydrazine which was expected to survive reentry. A sea-based missile negated the threat by destroying the spacecraft shortly before its anticipated reentry.
- 2008: 1 spacecraft struck by sub-orbital device
- Maximum cataloged debris: 175  
Maximum tracked debris: >1600  
**Debris remaining in orbit 1 June 2010: 0**
- The breakup occurred at an altitude of 250 km, preventing the cataloging of all large debris. 95% of cataloged debris reentered within three months.



Destruction of  
USA-193

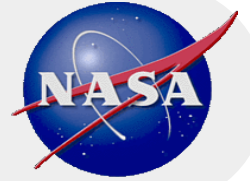

## Chinese Antisatellite Test

- The Fengyun-1C weather satellite was destroyed in the testing of a ground-based ASAT system.
- 2007: 1 spacecraft struck by sub-orbital device
- Maximum cataloged debris: 2841  
Maximum tracked debris: >3200  
**Cataloged debris remaining in orbit 1 June 2010: 2754**
- The high altitude (860 km) of the breakup created large quantities of long-lived debris.

Fengyun-1C

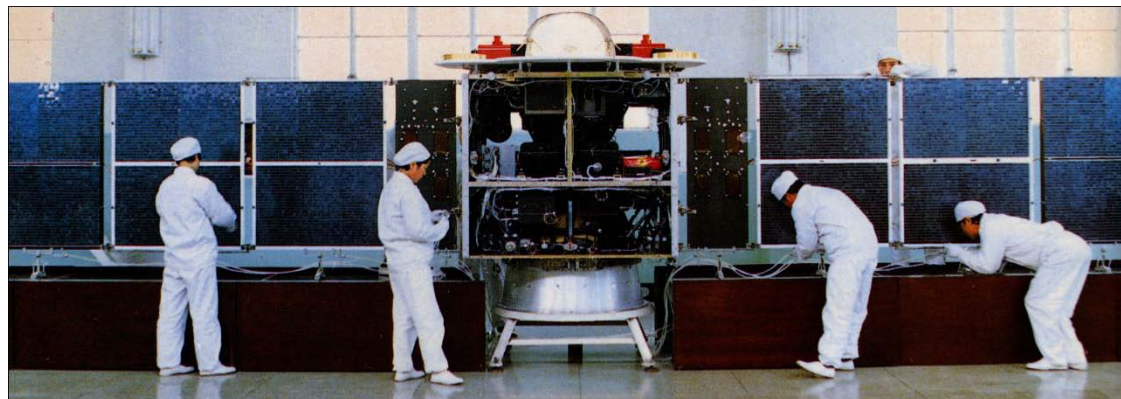



# Summary of Deliberate Satellite Breakups

**Number of Events**                      **Total Number of Cataloged Debris**                      **Number of Cataloged Debris in orbit on 1 June 2010**

## Russian Federation

- Malfunction of Recoverable Vehicle	15	1045	0
- FOBS	2	93	0
- Co-Orbital ASAT	9	736	296
- Early Warning Satellites	17	167	151
- Designed End-of-Mission	8	81	0

## United States

- Engineering Test	1	35	0
- Air-launched ASAT	1	285	0
- Technology Test	1	18	0
- Reentry Risk Mitigation	1	175	0

## China

- Ground-launched ASAT	1	2841	2754
------------------------	---	------	------

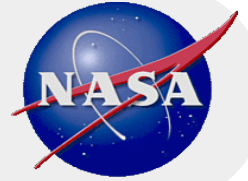

# Frequency of Deliberate Satellite Breakups

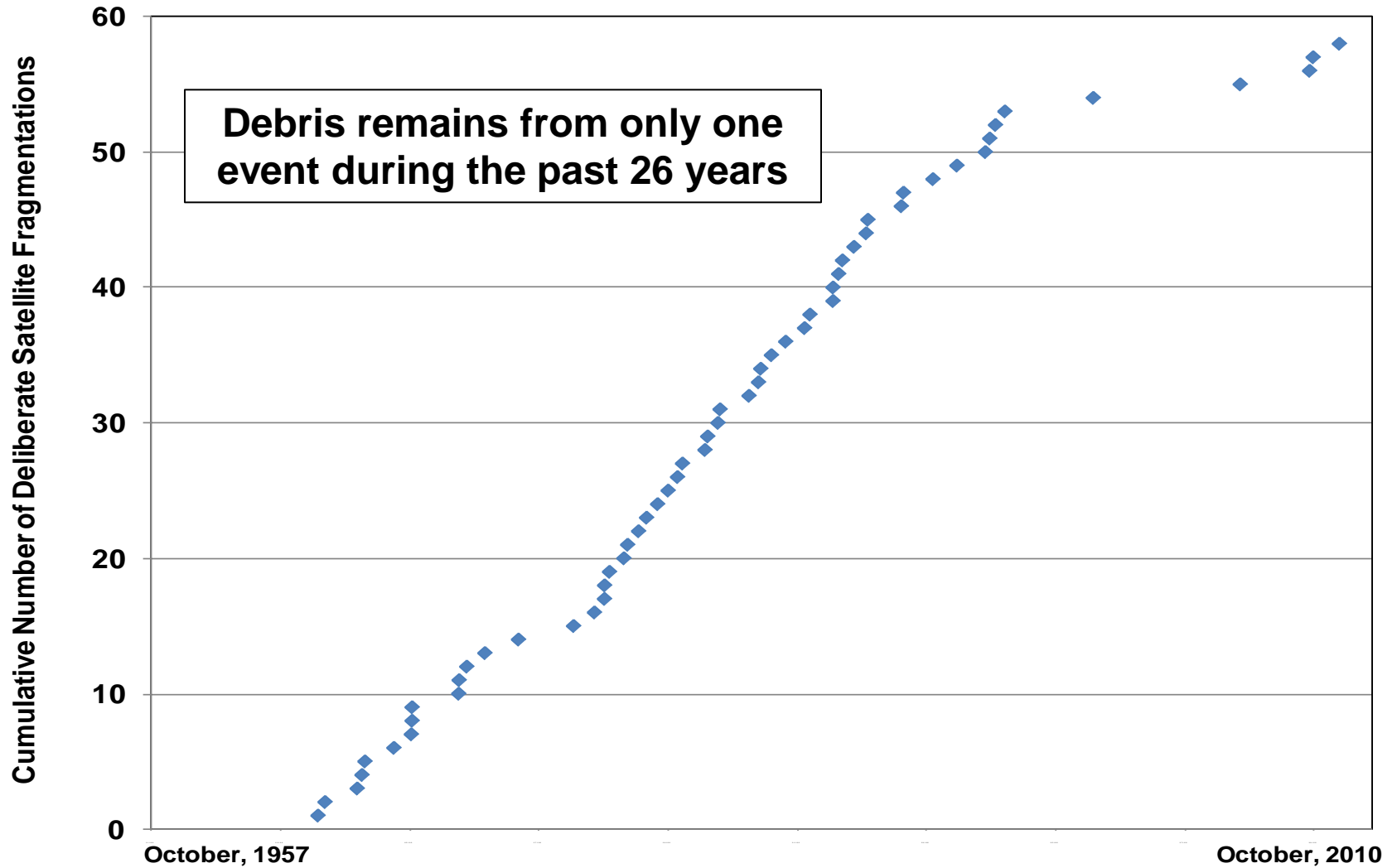

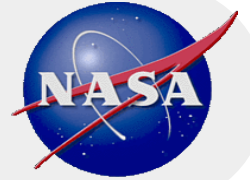

## Study Findings

- **Of the 58 deliberate satellite fragmentations identified to date, debris remain in orbit from only 24 events.**
  - Only debris from Chinese and Russian ASAT tests and from Russian early warning satellites remain in orbit.
- **With the exception of debris from Fengyun-1C, the debris from all the other deliberate fragmentations amount to less than 3% of all cataloged space objects now in Earth orbit.**
  - Fengyun-1C debris account for 18% of all cataloged space objects now in orbit.
- **Since the vast majority of deliberate satellite fragmentation events occurred at very low altitudes, in most cases the total number of large debris (> 10 cm) cataloged was significantly less than the number actually created.**



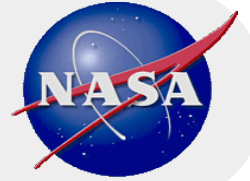

# NASA Provision for Intentional Breakups

- **NASA Standard 8719.14 permits the intentional breakup of a space vehicle under special conditions, if necessary.**

4.4.2.2.1 Requirement 4.4-3. Limiting the long-term risk to other space systems from planned breakups: Planned explosions or intentional collisions shall:

a) Be conducted at an altitude such that for orbital debris fragments larger than 10 cm the object-time product does not exceed 100 object-years (Requirement 56453). For example, if the debris fragments greater than 10 cm decay in the maximum allowed 1 year, a maximum of 100 such fragments can be generated by the breakup.

b) Not generate debris larger than 1 mm that shall remain in Earth orbit longer than one year (Requirement 56454).

4.4.2.2.2 Requirement 4.4-4: Limiting the short-term risk to other space systems from planned breakups: Immediately before a planned explosion or intentional collision, the probability of debris, orbital or ballistic, larger than 1 mm colliding with any operating spacecraft within 24 hours of the breakup shall be verified to not exceed  $10^{-6}$  (Requirement 56455).

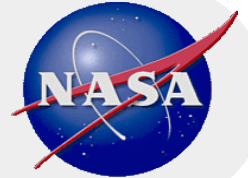

# IADC Guideline for Intentional Satellite Destructions

## 5.2.3 Avoidance of intentional destruction and other harmful activities

Intentional destruction of a space system, (self-destruction, intentional collision, etc.), and other harmful activities that may significantly increase collision risks to other systems should be avoided. For instance, intentional break-ups should be conducted at sufficiently low altitudes so that orbital fragments are short lived.

### **Purpose:**

Intentional destructions have been conducted for the purpose of engineering tests, experiments, or security assurance (data and technology security) for on-board information. Such activities should be avoided whenever possible.

In the past, deliberate activities detrimental to the space environment have taken place. Large numbers of needles were scattered in-orbit for a communications experiment in the 1960's.

When conducted, intentional destruction or potentially harmful activities should be assessed for possible damage to other spacecraft.

### **Tailoring Guide:**

In rare cases, destruction may be planned to reduce the risk to people on Earth from re-entering debris objects, but this should be conducted at low altitude, e.g., lower than 90 km. However, keeping the destruct devices in-orbit during mission operation could increase the risk of an on-orbit explosion, even if the mission duration is short. Also, to control the destruction in low altitude may not be easy because of difficulty in attitude control, protection from aero-heating, and the maintenance of command lines.

***Support to the IADC Space Debris Mitigation Guidelines, 2004***

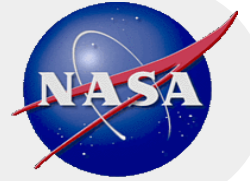

# UN Guideline for Intentional Satellite Destructions

## **“Guideline 4: Avoid intentional destruction and other harmful activities**

**Recognizing that an increased risk of collision could pose a threat to space operations, the intentional destruction of any on-orbit spacecraft and launch vehicle orbital stages or other harmful activities that generate long-lived debris should be avoided. When intentional break-ups are necessary, they should be conducted at sufficiently low altitudes to limit the orbital lifetime of resulting fragments.”**

***Space Debris Mitigation Guidelines of the United Nations  
Committee on the Peaceful Uses of Outer Space, 2007***

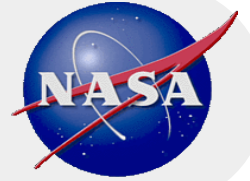

## Concluding Remarks

- **NASA, IADC, and UN orbital debris mitigation guidelines strongly restrict or discourage the intentional fragmentation of a satellite in Earth orbit.**
  - Fengyun-1C was not compliant with any of these recommendations.
  - Fengyun-1C is only deliberate fragmentation in past 26 years with debris still in orbit.
- **If necessary, a deliberate satellite fragmentation should occur at a low altitude to limit the orbital lifetimes of all debris (large and small).**
  - Large debris can normally serve as a proxy for the entire debris ensemble; smaller debris can be injected into higher orbits, but they decay more rapidly due to on average higher area-to-mass ratios.
- **NASA orbital debris mitigation requirements limit the longevity of all orbital debris greater than 1 mm to one year.**
  - This constraint greatly limits significant increases in spatial density (i.e., risk to operational space systems) to very short periods, i.e., typically a few weeks.