

NASA Tech Briefs

THE DIGEST OF NEW TECHNOLOGY

Official Publication of the
National Aeronautics and
Space Administration
March 1994 Vol.18 No.3

Transferring Engineering
Technology to Over 200,000
Qualified Readers Throughout
Industry and Government

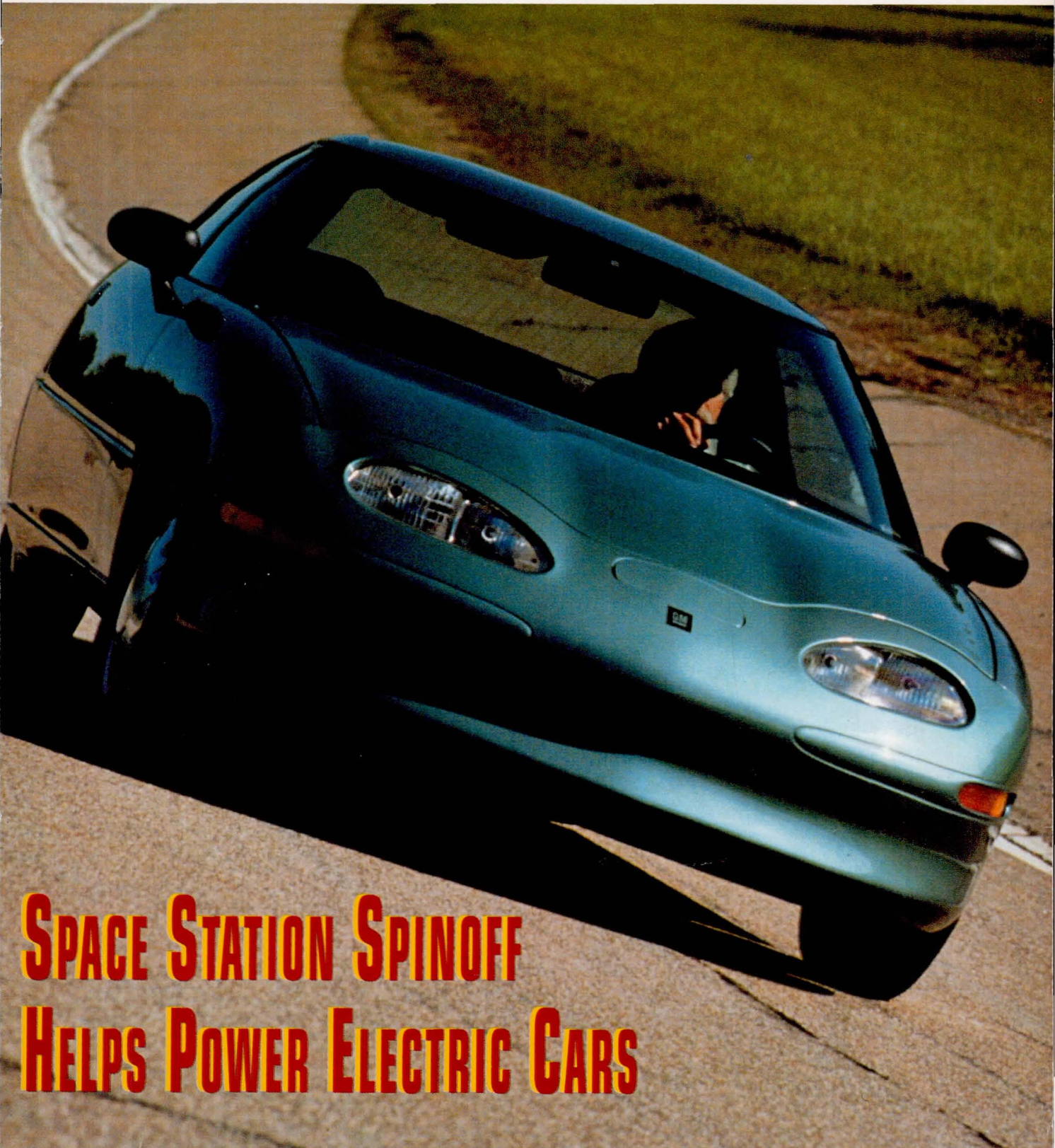

**SPACE STATION SPINOFF
HELPS POWER ELECTRIC CARS**

More than Just Ease of Use ...

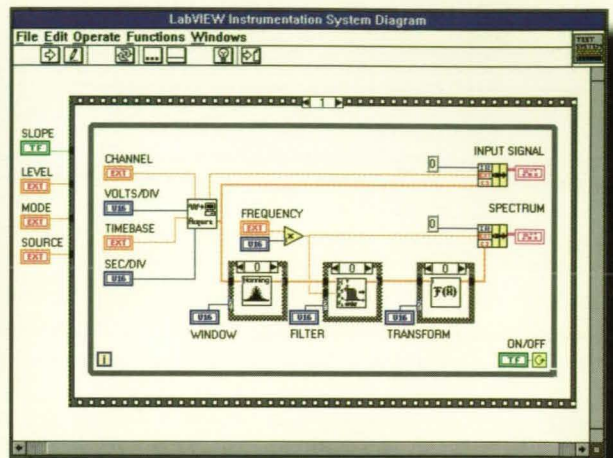
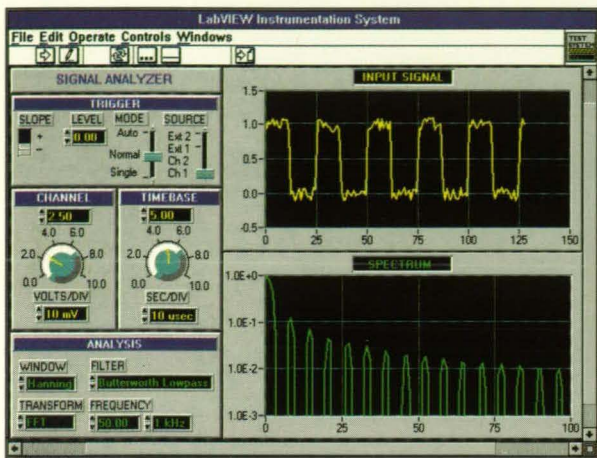

True Productivity.

Sure, graphical programming offers ease of use, but the true measure of your success is productivity. For seven years, LabVIEW® has championed graphical programming for instrumentation. And for the thousands of real-world applications like yours, LabVIEW has delivered flexibility, power, and performance to ensure productivity.

Flexibility. LabVIEW is a complete language, so you won't spend time working around limitations. You can easily add custom controls to front panels. You can build diagrams with icons for GPIB, VXI, and RS-232 instruments, and plug-in data acquisition boards. You can analyze your data using simple statistics or real-time digital signal processing. And you can even link in compiled C code.

Power. LabVIEW pays big dividends as your programs become more sophisticated. Our patented programming struc-

tures keep diagrams manageable. You can modularize, test, and reuse each of your software components. And with the LabVIEW debugging tools, you'll drastically reduce your development time.

Performance. With the compiled performance of LabVIEW, you won't waste time optimizing your program. You'll increase productivity while lowering system cost and raising system throughput.

LabVIEW is not just a pretty user interface and a bunch of icons. LabVIEW delivers the true productivity of an easy-to-use, yet flexible, high-performance graphical programming system.



Call for FREE LabVIEW
demo software
(800) 433-3488
(U.S. and Canada)



6504 Bridge Point Parkway • Austin, TX 78730-5039 • Tel: (512) 794-0100 • 95 (800) 010 0793 (Mexico) • Fax: (512) 794-8411
Branch Offices: Australia 03 879 9422 • Austria 0662 435986 • Belgium 02 757 00 20 • Canada 519 622 9310 • Denmark 45 76 26 00 • Finland 90 527 2321 • France 1 48 65 33 70 • Germany 089 714 50 93
Italy 02 48301892 • Japan 03 3788 1921 • Netherlands 01720 45761 • Norway 32 848400 • Spain 91 640 0085 • Sweden 08 730 49 70 • Switzerland 056 27 00 20 • U.K. 0635 523545

© Copyright 1993 National Instruments Corporation. All rights reserved. Product and company names listed are trademarks or trade names of their respective companies.

For More Information Write In No. 550

SIMULINK Highlights

Modeling Tools

- Block Library with 200+ blocks
- Custom blocks and libraries
- Custom icon editor
- Differential equations
- Linear and nonlinear
- Discrete-time, continuous-time, and hybrid
- Multi-input-multi-output
- Hierarchical modeling
- Write equations in Fortran, C or MATLAB

Simulation and Analysis

- 7 integration methods for fixed, variable-step and stiff systems
- Interactive simulations with live displays
- Batch simulations from MATLAB command line
- Monte Carlo simulations
- Access to MATLAB's extensive toolboxes
- Trimming: determine stable equilibrium points
- Linearization

SIMULINK is available on most popular computers, including Unix workstations, MS-Windows-based personal computers, and the Macintosh.

Call 508/653-1415 for a complete brochure.

New SIMULINK Prices
Starting at \$1,995 in the U.S.

The
MATH
WORKS
Inc.

24 Prime Park Way/Natick, MA 01760
Tel: 508/653-1415 Fax: 508/653-6284
Email info@mathworks.com

Australia: +61-2-922-6311	Japan: +81-3-3982-4641
Brazil: +55-11-816-3144	Portugal: +34-3-415-49-04
France: +33-1-45-34-23-91	Scandinavia: +46-8-15-30-22
Germany: +49-89-995-9010	Spain: +34-3-415-49-04
India: +91-80-2-260-260	South Korea: +82-2-517-1257
Israel: +972-3-561-5151	Switzerland: +41-31-998-44-11
Italy: +39-11-24-85-332	Taiwan: +886-2-501-8787

For Belgium, Luxembourg, The Netherlands, United Kingdom and Republic of Ireland call Cambridge Control, Ltd. +44-223-423-200 or Rapid Data, Ltd. +44-903-821-266

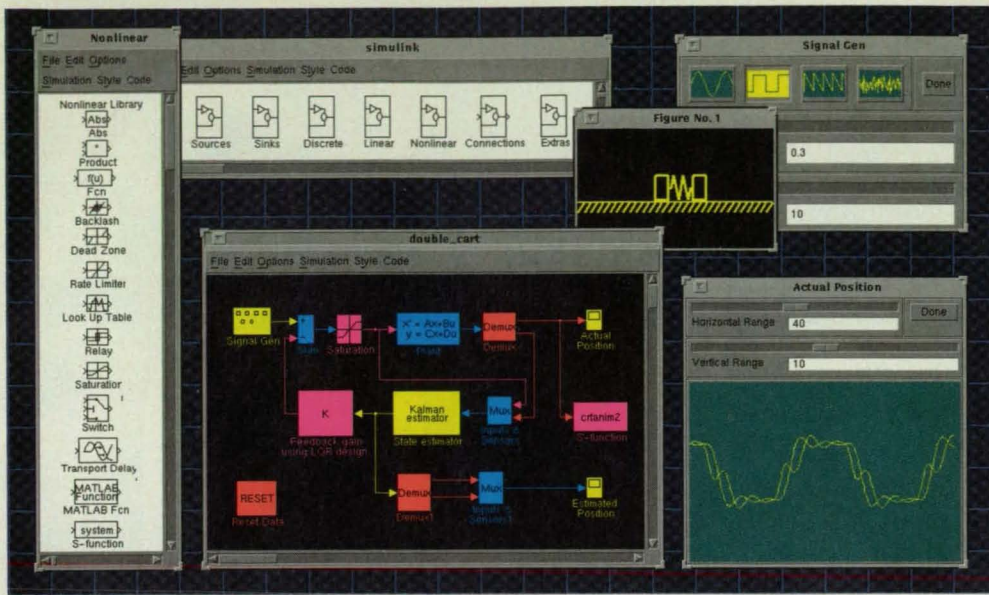

Simulating a system with SIMULINK: Scope block and MATLAB animation window show results while the simulation is running. You can change parameters during a simulation to do "what if" analyses.

It's time to go nonlinear with SIMULINK®.

SIMULINK gives you a powerful interactive workbench to model, analyze, and simulate physical and mathematical systems. SIMULINK allows you to rapidly model the behavior of complex systems like regional power grids, satellite controllers, aircraft, robotic systems and biochemical processes.

Create models graphically

With SIMULINK you can model a dynamic system quickly and easily. Just drag and drop icons into block diagrams — there's no need to write a single line of code. SIMULINK provides over 200 built-in block types from which to build your models. You can also design your own blocks, complete with custom icons. Plus, blocks can be grouped to create a model hierarchy.

Extensive model types

To model a complete range of system behaviors, you can combine linear and nonlinear elements defined in discrete-time, continuous-time or as a hybrid system.

Interactive simulation

SIMULINK makes it easy to run simulations and monitor results interactively. Just attach signal source blocks to generate input signals and

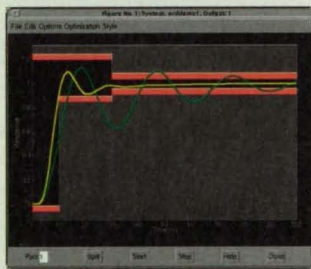

Graphically tune parameters in a nonlinear system with the Nonlinear Control Design Toolbox.

oscilloscope blocks to monitor outputs. For "what if" analyses, change parameter settings while the simulation is running; you see the changed outputs immediately.

An open architecture

Because SIMULINK is based on the open and extensible architecture of MATLAB®, you can easily create blocks, customize existing blocks, build custom block libraries, and use MATLAB's toolboxes including:

- Signal Processing
- System Identification
- Control System Design
- Robust Control
- μ -Analysis and Synthesis
- Neural Network
- Optimization
- Nonlinear Control Design

New toolboxes for nonlinear optimization and real-time code

The new Nonlinear Control Design Toolbox automatically optimizes controller parameters using nonlinear simulation results.. SIMULINK's new C Code Generator lets you automatically generate real-time code from models, for embedded control, rapid prototyping, and standalone simulations on your target hardware or on DSP hardware.



STOP COMPROMISING.

NOW YOU CAN AFFORD MSC/NASTRAN... JUST \$35,000*

Now, for the first time,
the world's most powerful

FEA tool suite is within reach of everyone. Even small work groups with big designs on the future can now afford MSC/NASTRAN and MSC/ARIES.

Forget limitations and compromises. Workstation MSC/NASTRAN is a fully integrated Predictive Engineering™ system, including: Solid Modeling, Parametric Design Modification, Mass Properties, Material Management, Equation Solver, FEA Pre- and Postprocessing, and Linear Static, Normal Mode, Heat Transfer, Dynamic and Nonlinear Analyses.

Simply **P**owerful.™

And all for just \$35,000 through June 30. For our brochure call 800-642-7437, ext. 500. Workstation MSC/NASTRAN...the more powerful alternative.



The
MacNeal-Schwendler
Corporation

RECORDING AT UP TO 32 Mb/SEC ISN'T ITS MOST ATTRACTIVE FEATURE.



THE METRUM BUFFERED VLDS DIGITAL DATA RECORDER

A data rate of up to 32 megabits per second is nothing to sneeze at. It can let you do a lot of things. And do them very well.

But it can cost you an arm and a leg.

Unless you use your head. And get yourself a Metrum BVLDS digital data recorder.

This full-featured cassette machine costs about half of what you'd expect to pay for such impressive specifications.

Plus, the new Metrum BVLDS is virtually

maintenance-free. Needs no calibration or head cleaning. Takes only seven inches of rack space. And uses compact, economical ST-120 cassettes, which can save you a lot in storage hassles and media costs.

The BVLDS also comes with a parallel, serial or SCSI interface.

All things considered, it's hard to say what this unique machine's best feature is.

But its low price is a great place to start.

M E T R U M

FOR TECHNICAL LITERATURE ON THE METRUM BUFFERED VLDS, CALL 1-800-METRUM-2.

For literature write in 559
For a product demo write in 560

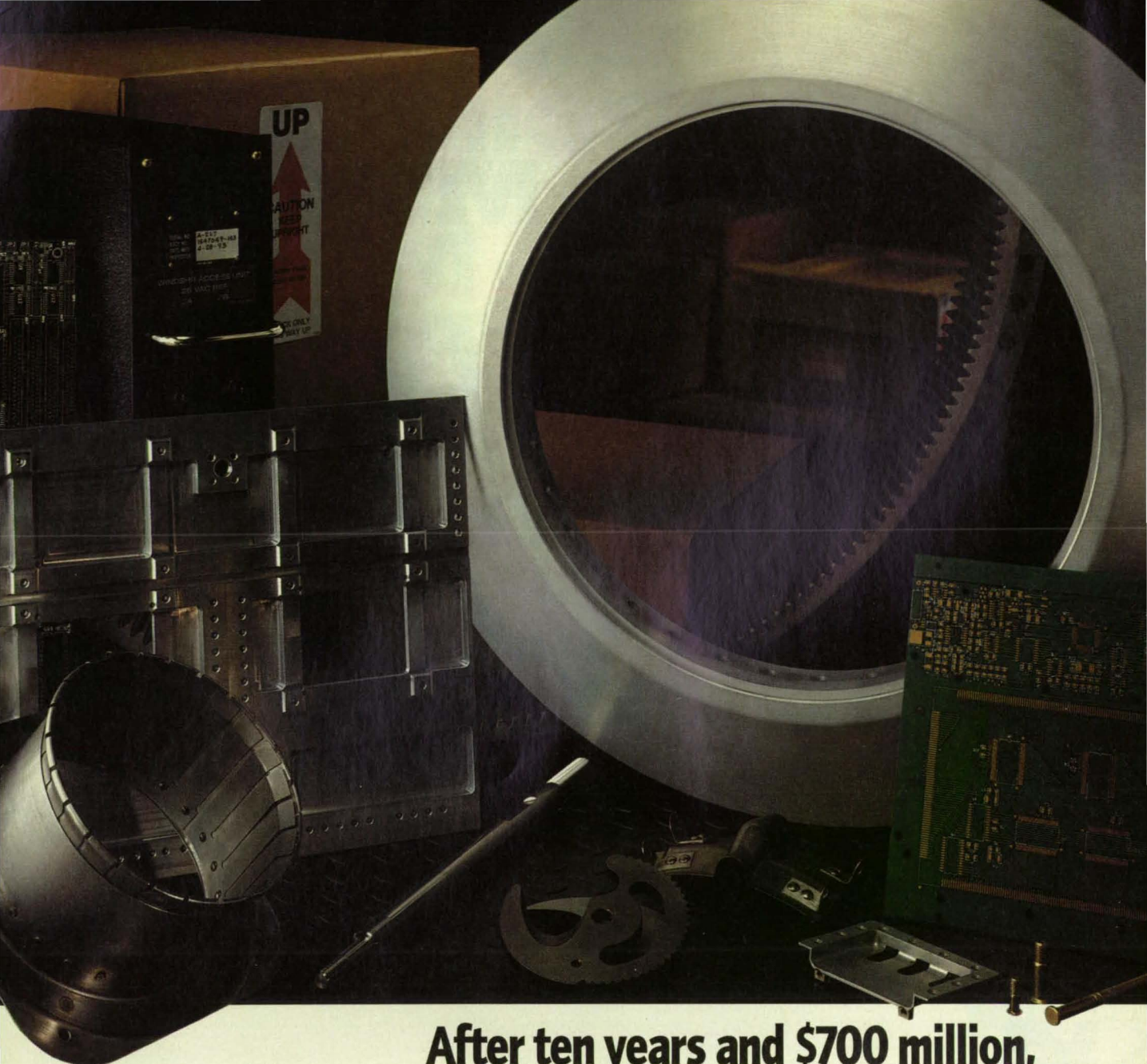

After ten years and \$700 million, you could say we've made a big investment in small businesses.

In 1992 nearly 2,500 small disadvantaged firms showed Lockheed the right stuff in winning more than 48,000 subcontracts. We awarded more than \$114 million in work last year alone; and \$700 million over the last ten years.

Today, we're continuing the search for minority firms to bid competitively for contracts. We're particularly interested in companies who can provide goods or services in high-technology areas such as advanced electronics, aeronautics or space systems.

If your minority-owned company qualifies as a small disadvantaged business and offers a product or service we need at a competitive price, we want to hear from you. Please write to Chuck Lileikis, Lockheed Corporation, NTB, 4500 Park Granada Blvd., Calabasas, CA 91399.

Lockheed leads.

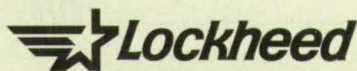

Watch NOVA on PBS, Tuesdays at 8 p.m.

For More Information Write In No. 628

YOU DEMAND SERVICE. AT DIGI-KEY YOU GET IT!



OVERALL PERFORMANCE

Engineering & Distribution Survey
Electronic Engineering Times 1993

1. DIGI-KEY	90%
2. Marshall	53%
3. Wyle	51%
4. Pioneer	50%
5. Arrow	48%
6. Hamilton/Hallmark.....	44%
7. Newark.....	43%

In a recent "Engineering & Distribution Survey" conducted by *Electronic Engineering Times*, respondents were asked to evaluate distributors with whom they have done business or were most familiar. The table above reflects the percentage of respondents who rated these distributors as excellent (6&5 responses) on a 6 point scale where 6=excellent and 1=poor in terms of OVERALL PERFORMANCE!

DIGI-KEY is a registered trademark of Digi-Key Corporation and is in no way affiliated with the other distributors evaluated in the survey or listed above.

Look for YOUR FREE Catalog Soon!

Digi-Key[®]

CORPORATION

Quality Electronic Components, Superior Service

701 Brooks Ave., South, Thief River Falls, MN 56701
Toll Free: 1-800-344-4539, Fax: 218-681-3380

For More Information Write In No. 515

Contents

NASA Tech Briefs

Transferring Engineering Technology to
Over 200,000 Qualified Readers
Throughout Industry and Government

FEATURES

14 Mission Accomplished

TECHNICAL SECTION

22 Special Focus: Computer-Aided Design and Engineering



- 22 Program Trains NASTRAN Users
- 22 Analyzing Seals With Two-Phase Flows
- 24 Program Helps Design Composite Panels
- 26 Preprocessor Program for Use With PASCO
- 26 Integrated Composite Analyzer (ICAN/PC)
- 30 Program Aids Analysis and Optimization of Design

32 Electronic Components and Circuits



- 32 Optically Addressable, Ferroelectric Memory With NDRO
- 36 Current-Collecting Grids for AMTEC Electrodes
- 38 Double-Square-Loop Triband Frequency-Selective Microwave Reflector
- 41 Triband Circular-Loop Frequency-Selective Microwave Reflector
- 42 Nonvolatile GaAs Random-Access Memory

44 Electronic Systems



- 44 Evaluating Multi-Input/Multi-Output Digital Control Systems
- 46 Stationary Camera Aims and Zooms Electronically
- 49 Optical Pattern Recognition With Self-Amplification
- 50 Computer-Aided Remote Driving

64 Physical Sciences



- 64 Noncontact Electromagnetic Vibration Source
- 68 Temperature-Control Apparatus for Hydrogen Maser
- 68 Two-Zone Bridgman Furnace With Sharp Thermal Gradient

72 Materials



- 72 Lightweight Electrode for Nickel/Hydrogen Cell
- 72 Spherical Perfluoropolyethers
- 74 Low-Toxicity PMR Polyimide
- 76 Acetylene- and Phenylacetylene-Terminated Poly(Arylene Ether Benzimidazole)s (PAEBI's)
- 77 Bimaterial Thermal Strip With Increased Fixing
- 78 Thin CVD Coating Protects Titanium Aluminide Alloys
- 80 Synthesis of Perfluoro Orthocarbonates

82 Computer Programs



- 82 General-Purpose Plotting Software
- 83 Raster Metafile and Raster Metafile Translator Programs
- 84 Resupply Scheduler Program Using Integer Optimization
- 85 Computer Program Helps Enhance Images
- 86 MATH77, Version 4.0
- 88 Analyzing Thermal Conditions in Rocket Engines
- 89 Computing Flows of Coolants in Turbomachines
- 90 Analyzing Flows in Rocket Nuclear Reactors
- 90 Software for Calibration of Polarimetric SAR Data

92 Mechanics



- 92 Retractable Rotary-Bit Tool
- 94 Retractable Rotary Tool With Simplified Latch
- 97 Improved All-Terrain Suspension System
- 97 Latching Solenoid-Operated Ball Valve
- 100 Deflection and Stress in Preloaded Rectangular Membrane
- 101 Versatile Support for Electromagnetic-Test Model

104 Machinery



- 104 Three-Stage Regenerative Sorption Cooler Reaches 65 K
- 106 Simpler Three-Stage Regenerative Sorption Cooler
- 108 Floating-Pinion Torque Splitter

To Backup 50 GB, Two Heads Are Better Than One.

Single:

Drives can operate independently.

Cascade:

Data automatically writes to the second tape when the first tape is full.

Mirroring:

Writes the same data to both tapes simultaneously.

Striping:

Writes data to two tapes at once, in alternate blocks, doubling capacity and speed.



Introducing the dual drive CY-8505 with the Advanced SCSI Processor.

Working independently, each drive can store up to 25 GB, at speeds of up to 90 MB per minute. So it's perfect for unattended backup.

But performance *really* hits the ceiling when the drives *work together*.

Four selectable recording modes, plus **offline copy and verify**, give you the flexibility to write 50 GB of data any way you need to.

Consider it a data storage management tool, a solution that will solve the problems you encounter every day. The need for higher capacity and speed; the need to make duplicate tapes for off-site storage and data exchange; the need for real-time status information—and the need to save resources and boost productivity *on every level*.

Each tape drive offers the most advanced in data recording technology. Our *hardware data compression*

option is the fastest available. And it's switch-selectable, so you can read and write uncompressed data for compatibility with other sites. Add *accelerated file access* to locate a single file in an average of 85 seconds. And we even offer a *data encryption* option that lets you control access to sensitive data.

All this, and the *proven* reliability and price performance of 8mm helical scan tape storage.

We back this turnkey solution with a *two year warranty* that includes responsive service and technical support from our in-house engineering group.

If you need a data storage solution that *means business*, call today for more information at:

(804) 873-9000

CONTEMPORARY
CYBERNETICS

TRUE COMPATIBILITY WITH

Alliant	Convergent	DEC Unibus	IBM S/38	NeXT	Pertec	STC
Alpha Micro	DataGeneral	Gould/Encore	ICL	Novell	PICK	Stratus
Altos	DEC SCSI	HP	Intergraph	OS/2	Plexus	Sun
Apollo	DEC BI-Bus	IBM AS/400	Macintosh	PS/2	Prime	Texas
Arix	DEC DSSI	IBM Mainframe	McDonnell	Parallel Port	Pyramid	Instruments
AT&T	DEC HSC	IBM RISC/	Douglas	PC 386/ix	Sequent	Unisys
Basic-4	DEC Q-Bus	6000	Motorola	PC MS-DOS	Silicon	Ultimate
Concurrent	DEC TU/TA81	IBM RT	NCR	PC Xenix/Unix	Graphics	Wang—and more

Designing Electrical Comp Edge Is Easy If You're

Help!

Looking for help with a special application? Plug into DuPont's technical expertise.

RYNITE® FR530 was chosen to encapsulate this transformer because it has a UL 94-V0 flammability rating and has UL 1446 Class B (130°C) insulation system recognition. Encapsulation provides molded-in terminals for easy plug-in installation.

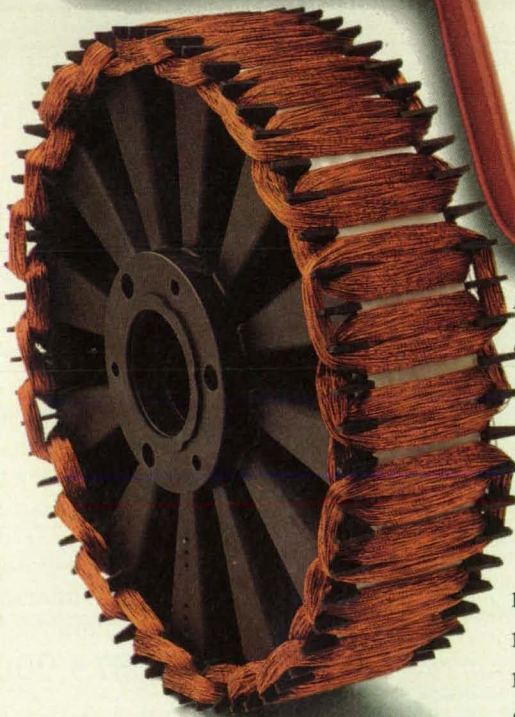
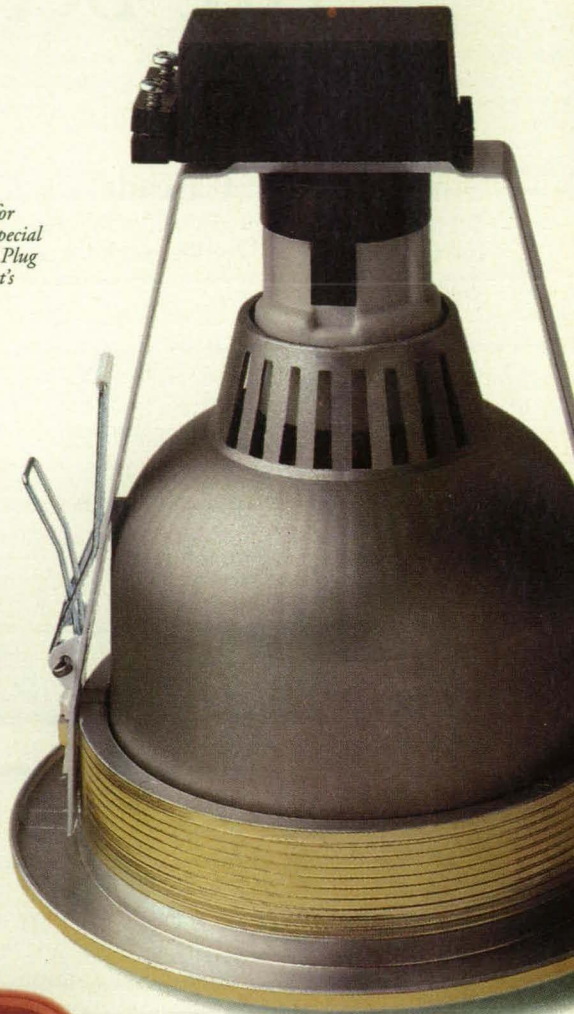

RYNITE® FR530 is ideal for this unique motor stator because it's strong and stiff, is compatible with bondable wire processes, and offers UL 1446 Class F recognition. NOMEX® aramid insulation is used between the coils and core metal to meet high temperature requirements.

This down light's vacuum-metallized reflector and bezel of color-stable, high-temperature RYNITE® resists discoloration at high temperatures. The retainer and terminal housing are made of durable ZYTEL® for snap-fit resiliency.

Whether you're redesigning electrical parts or creating new ones, plug into DuPont Engineering Polymers. Our wide range of high-quality materials will meet virtually any electrical materials challenge, from high temperature and dimensional stability, to better performance and durability, to simplified assembly, parts consolidation and reduced costs.

Components With A Competitive Plugged Into Du Pont.



This ballast case uses RYNITE® FR515 thermoplastic polyester resin because it offers a UL 94-5V rating and a 140°C RTI along with exceptional impact and tensile strength. With RYNITE® potting isn't needed.

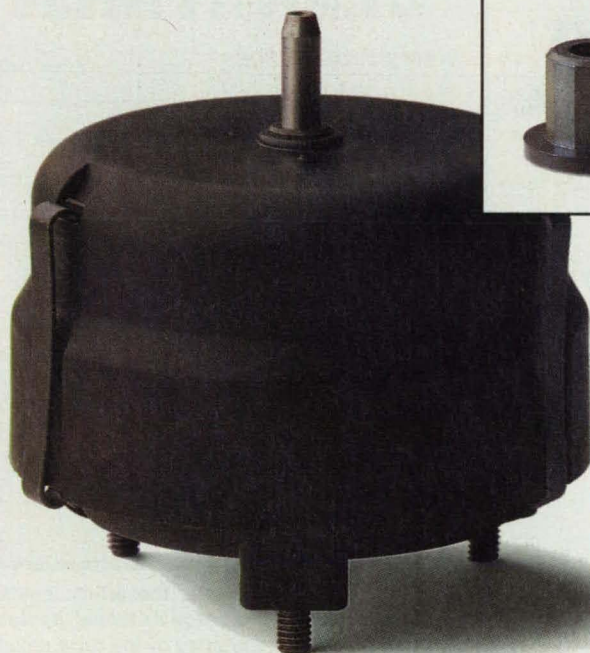

This fan motor for supermarket freezers features lubrication-free VESPEL® polyimide bearings in housings molded from new heat-dissipating RYNITE® CR (conductive resin). The stator is insulated with UL-recognized ZYTEL® nylon resin.

This plug uses crush- and chemical-resistant ZYTEL® to meet UL flammability and hospital requirements.

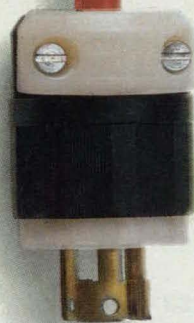

IF YOU WANT TO GET TECHNICAL

For product information and an application profile instantly by fax, call our PolyFax™ Instant-Response Polymer Information Service.

Call 1-800-225-5387

At the prompt dial:
2001 Freezer Fan Motor
2101 Hospital-Grade Plug
2201 Lighting Fixture
2301 Fluorescent Ballast
2401 Power Supply Transformer
2501 Brushless DC Motor



DuPont Engineering
Polymers

You can also call on DuPont for design and production assistance as well as pre-approved UL system recognitions that can save you time and money by eliminating testing. See how DuPont Engineering Polymers gave the electrical components shown here a competitive edge. Then call and let DuPont spark a few ideas.

Contents *(continued)*

111 Fabrication Technology



- 111 Robotic Processing of Rocket-Engine Nozzles
- 111 Robotic Booking of Coolant Tubes
- 112 Bolted Structural Joint Sustains Reversing Shear Load
- 114 Balloon Catheter Prevents Contamination
- 114 Preventing Clogging in a Vacuum Plasma Spray Gun
- 115 Wire-Guide Manipulator for Automated Welding

119 Mathematics and



Information Sciences

- 119 Optimal Processing of GPS Data
- 120 Frequency Analysis of Data on Telerobotic Tasks

121 Life Sciences



- 121 Continuous-Flow Gas-Phase Bioreactors

122 Books and Reports

- 122 GPS Measurements Show Subdaily Changes in Earth Rotation
- 122 Dynamics of Two Ions in a Time-Varying Potential
- 122 Anticipated Improvements in Gravitational-Field Data
- 123 Heating and Positioning in a Microwave Cavity
- 123 High-Temperature Rocket Engine
- 123 Integrated Booster-Rocket Propulsion Module
- 124 Studies of Vibrations in Gearboxes
- 124 More About Thin-Membrane Biosensor
- 125 Bioregenerative Life-Support System for Long Missions
- 125 Applications of Modern Systems Analysis
- 126 Performance of a Doppler-Corrected MDPSK Detector



Researchers at Jet Propulsion Laboratory have created a system to remotely control robotic land vehicles that requires only a small radio communication bandwidth. Twin cameras on the vehicle send occasional stereoscopic terrain images to an operator, who can plot a path by use of a cursor on the frozen image. The vehicle can be controlled despite transmission delay and intermittent availability of the communication bandwidth, conditions encountered during planetary exploration, military surveillance, firefighting, and hazardous waste removal. See the tech brief on page 50.

Photo courtesy Jet Propulsion Laboratory

DEPARTMENTS

New Product Ideas	18
NASA TU Services	20
New on the Market	127
New Literature	130
Advertisers Index	134

On the cover:

High-power direct current contactors originally developed for the space station's electrical power system play a key role in the propulsion system of the Impact, General Motors' new electric car. The contactors, manufactured by Kilovac Corp., Santa Barbara, CA, enable the zero-emission Impact to travel safely at speeds up to 80 mph, with a 0-60 mph acceleration of 8.5 seconds. Turn to Mission Accomplished, page 14.

Photo courtesy General Motors Corporation

Errata: In the February issue, the article entitled "Measuring Frequency Instability of a Large Antenna" contained the following errors: in the first sentence of the third column on page 46, 2×10^{-5} should have read 2×10^{-15} ; and in the first sentence of the second paragraph on page 48, 1.1×10^{-6} should have read 1.1×10^{-16} .

This document was prepared under the sponsorship of the National Aeronautics and Space Administration. Neither Associated Business Publications Co., Ltd. nor anyone acting on behalf of Associated Business Publications Co., Ltd. nor the United States Government nor any person acting on behalf of the United States Government assumes any liability resulting from the use of the information contained in this document, or warrants that such use will be free from privately owned rights. The U.S. Government does not endorse any commercial product, process, or activity identified in this publication.

Permissions: Authorization to photocopy items for internal or personal use, or the internal or personal use of specific clients, is granted by Associated Business Publications, provided that the flat fee of \$3.00 per copy is paid directly to the Copyright Clearance Center (21 Congress St., Salem, MA 01970). For those organizations that have been granted a photocopy license by CCC, a separate system of payment has been arranged. The fee code for users of the Transactional Reporting Service is: ISSN 0145-319X/94 \$3.00+.00

NASA Tech Briefs, ISSN 0145-319X, USPS 750-070, copyright © 1994 in U.S., is published monthly by Associated Business Publications Co., Ltd., 41 E. 42nd St., New York, NY 10017-5391. The copyrighted information does not include the (U. S. rights to) individual tech briefs which are supplied by NASA. Editorial, sales, production and circulation offices at 41 East 42nd Street, New York, NY 10017-5391. Subscription for non-qualified subscribers in the U.S., Panama Canal Zone, and Puerto Rico, \$75.00 for 1 year; \$125.00 for 2 years; \$200.00 for 3 years. Single copies \$10.00. Foreign subscriptions one-year U.S. Funds \$150.00. Remit by check, draft, postal, express orders or VISA, MasterCard, and American Express. Other remittances at sender's risk. Address all communications for subscriptions or circulation to NASA Tech Briefs, 41 East 42nd Street, New York, NY 10017-5391. Second-class postage paid at New York, NY and additional mailing offices.

POSTMASTER: please send address changes to NASA Tech Briefs, 41 E. 42nd Street, Suite 921, New York, NY 10017-5391.

Advanced Land Remote Sensing System's concept definition studies will address a broad spectrum of remote sensing approaches into the next century. For nearly thirty years imaging sensors built by Hughes Aircraft Company have observed Earth from space, collecting more than three million images. Hughes' decades of experience in space-based remote sensing, communications, ground processing, and data exploitation for the national security, civil and commercial markets will continue to benefit the remote sensing and geographic information systems communities. Space-based remote sensors have proven to be an invaluable tool in monitoring day-to-day weather, environmental trends and global change research; management of water and agricultural resources; and land use planning. Hughes sensors have provided detailed imagery and data on natural and man-made disasters, including the recent flooding in the Midwest, deforestation of the rain forests, the nuclear accident at Chernobyl, the oil spill in the Persian Gulf, and the oil well fires in Kuwait. Today, national security, civil, scientific, and commercial mission requirements are being synergistically met with Hughes' broad operational expertise.

Hughes has developed a steam injection technology that can uniquely treat diesel fuel, jet fuel, kerosene, and other heavy hydrocarbons in place. At the right temperatures and pressures, it forces hydrocarbons to migrate to extraction wells, where they are safely extracted for treatment. This in-place method of removing and treating hydrocarbons without excavating the soil is nonobtrusive, and saves both time and money.

A new magnetic sensor developed by Hughes will help improve the performance of General Motors cars. This crankshaft positioned detector device provides precise ignition firing timing, resulting in fuel savings, better mileage, and reduced emissions. Initially, the sensor will be used in 1995 GM truck engines, with production expected to reach two million units per year by 1996. Hughes has become committed to automotive electronics, supplying both sensors and integrated circuits for engine control and dashboard instrumentation. They are also applying their advanced sensor technology to anti-lock brakes, brushless motor commutation sensors, and transmission speed sensors.

Thailand will have its first domestic communications satellite system in 1993. Hughes will provide Bangkok's Shinawatra Computer Company with two HS 376 spin-stabilized satellites, as well as ground equipment and training support. These new spacecraft will be smaller, lighter-weight versions of the standard HS 376. Hughes' spacecraft have helped many countries establish commercial communications services, beginning with Canada in 1972.

The first in a new generation of cable television satellites, Hughes' Galaxy V is providing video transmission services for leading cable networks, including CNN, HBO, ESPN, and The Disney Channel. This Hughes-built satellite, which is positioned 22,300 miles above the equator, is the most advanced cable-dedicated satellite in orbit today. With higher power and longer life than its predecessors, Galaxy V will provide service to the cable TV industry well into the 21st century.

For more information write to: P.O. Box 80032, Los Angeles, CA 90080-0032

HUGHES



MAGNIFIES AND SPLITS HIGH RESOLUTION COMPUTER IMAGES ACROSS MULTIPLE MONITORS OR PROJECTORS

Control room, C², simulation
and multimedia applications

Automatically synchronizes
to raster-scan input signals
from 31.5-80 kHz

Inputs any workstation
or PC imagery up to
1280x1024 pixels

Displays text, graphics,
animation and full-motion
video

Full 24-bit color

Real-time operation

Compatible with all software

Functions perfectly under
high ambient light

Made in the USA



SPECTRUM®

950 Marina Village Parkway Alameda, CA 94501
Tel: (510) 814-7000 Fax: (510) 814-7026

For More Information Write In No. 678

NASA Tech Briefs

Published by	Associated Business Publications
President/Chief Executive Officer	Bill Schnirring
Publisher/Editor	Joseph T. Pramberger
Executive Editor	Sarah L. Gall
Contributing Editor	Robert Clark
Assistant Editor	Gregg McQueen
Technical Advisor	Dr. Robert E. Waterman
Director of Manufacturing	Gregg Weatherby
Traffic Manager	James E. Cobb
Art Director	Pierre Granier
Advertising Coordinator	Margery Koen
Marketing Director	Wayne Pierce
Telecommunications Specialist	Evelyn Mars
Reader Service Manager	Scott Floman
Research Analyst	Anita Gillespie
Circulation Director	Martin J. Horan
Assistant Circulation Manager	Damiana Garcia

BRIEFS & SUPPORTING LITERATURE:

Provided to National Aeronautics and Space Administration by

International Computers & Telecommunications, Inc., NY, NY

Technical/Managing Editor	Ted Selinsky
Art Manager	Pamela Baynham
Administrator	Elizabeth Texeira
Chief Copy Editor	Lorne Bullen
Staff Writers/Editors	Dr. Larry Grunberger, Dr. Theron Cole, Jordan Randjelovich, George Watson, Oden Browne

Graphics	Zinaida Gimpeleva, Susan Kyu Oh, Charles Sammartano
Editorial & Production	Bill Little, Ivonne Valdes, Susan Kyu Oh, Frank Ponce

NASA:

NASA Tech Briefs are provided by the National Aeronautics and Space
Administration, Technology Transfer Division, Washington, DC:

Administrator	Daniel S. Goldin
Deputy Assistant Administrator (Programs)	Frank E. Penaranda
Deputy Director Technology Transfer Division (Publications Manager)	Leonard A. Ault
Manager, Technology Transfer Office, NASA Center For AeroSpace Information	Walter M. Heiland

ASSOCIATED BUSINESS PUBLICATIONS

41 East 42nd Street, Suite 921, New York, NY 10017-5391
(212) 490-3999 FAX (212) 986-7864

President/Chief Executive Officer	Bill Schnirring
Executive Vice President/Chief Operating Officer	Domenic A. Mucchetti
Treasurer	Joseph T. Pramberger
Controller	Athena Thomas
Credit/Collection	Felecia Lahey
Trade Show Director	Wendy S. Janiel
Trade Show Coordinator	Danielle Krasny
Human Resources Manager	Lourdes Del Valle
MIS Manager	Ted Morawski
Accounting	Sylvia Valentin
Mailroom Manager	Thomas C. Snyder

ADVERTISING: New York Office: (212) 490-3999 FAX (212) 986-7864

ACCOUNT EXECUTIVES:

NY, NJ	Brian Clerkin at (201) 366-2751
PA, DE, NJ (Area Code 609), VA, DC, MD, WV, NC	Tara Morie at (215) 640-3118
Eastern MA, NH, ME, RI	Paul Gillespie at (508) 429-9807; Bill Doucette at (508) 429-9861
Western MA, CT, VT	George Watts at (802) 875-3310
Southeast, Southwest	Douglas Shaller at (212) 490-3999
OH, MI, IN, KY	Scott Burrows at (216) 928-1888
Northern IL, WI	Paul Leshner, CBC at (312) 296-2040
Southern IL, MO, IA, MN, ND, SD, NE, KS	Melinda Mead at (312) 296-2040
Northwest—WA, OR, ID, MT, WY	Bill Hague at (206) 858-7575
West Coast—CA, AZ, NV, NM, UT	Stillman Group at (310) 372-2744
	for Area Codes 310/213/818/805/801: Tom Stillman for 505/602/619/702/714: Stan Roach for 408/415/510/707/916: Robert Hubbard at (510) 846-6816
Japan	Akio Saijo at 03 (3555) 0106

The Apple Report On PowerPC

NUMBER 2 – RISC PERFORMANCE AND CROSS-PLATFORM COMPATIBILITY

Many of the most popular applications have been or are being optimized to take advantage of the high-performance PowerPC processor.

PowerPC chips are faster and less expensive than Pentium chips – so are the personal computers they will run.

A complete Macintosh system with PowerPC will cost well under \$2,500, but will offer better performance than higher-priced Pentium-based systems.

With SoftWindows, Macintosh with PowerPC will have the ability to run DOS and Windows applications, unmodified.

For more information about Macintosh with PowerPC, call 1-800-732-3131, ext. 150, in the U.S. We'll send you a copy of our informative, free booklet, *PowerPC Technology: The Power Behind the Next Generation of Macintosh Systems*. In Canada, call 1-800-665-2775, ext. 910.

In the first half of 1994, Apple will introduce a new family of computers that already has the entire computer industry standing on end.

They will offer better performance than computers based on the X86 microprocessors. They will be extremely competitive on a price basis. And they will be compatible with Windows and DOS applications, by using SoftWindows software.

They will be based on the revolutionary new PowerPC™ microprocessor, created jointly by Apple, IBM and Motorola.

For the first time, desktop personal computers will take advantage of RISC chip architecture previously found only in high-performance workstations. This advance will make possible quantum improvements in the way we manage and work with information.

RISC vs. CISC.

Tremendous advances have been made in CISC architecture over the years. However, the physical limitations of the new, high-performance CISC design mean that CISC chips must be significantly bigger and more complex, and must run at hotter temperatures to perform the same tasks as comparable RISC chips. Consequently, the newer generation of CISC chips, like the Pentium, are much more expensive to manufacture. Which means that personal computers powered by PowerPC chips can offer a significant advantage in price as well as in performance.

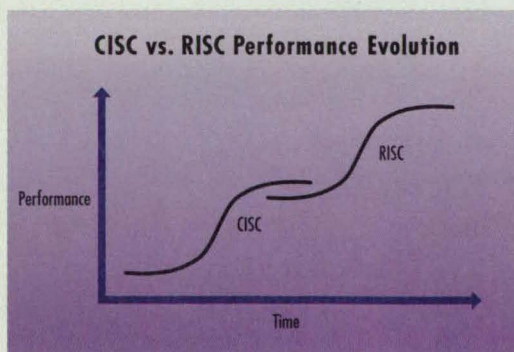

As you can see on the chart, RISC microprocessors offer dramatically greater potential for growth, leading us well into the next century and increasing the practicality of features like voice recognition, videoconferencing, object-oriented software and multimedia capabilities – functions that will be integral to doing business in the 21st century.

More compatible personal computers.

Apple's new generation of Macintosh® personal computers built around the PowerPC chip offer the ability to run MS-DOS and Windows applications, as well as Macintosh software. Moving from one environment to the next will be seamless and, even more importantly, it will be effortless.



PC users who move to Macintosh with PowerPC will gain access to the large number of new applications which take advantage of the incredible performance of the new PowerPC chip.

Higher-performance optimized applications.

When PowerPC microprocessor-equipped Macintosh computers begin shipping, software developers including Microsoft, WordPerfect, Adobe, Aldus and Claris will begin shipping new versions of their most popular software, specifically rewritten to take full advantage of the new processor's capabilities.

These optimized, sometimes called "native," applications will offer significantly faster performance than their MS-DOS, Windows or current Macintosh counterparts.

Unprecedented value.

Because RISC-based personal computers cost less to manufacture than equivalent systems based on CISC chips, we will be able to make this technology available for well under \$2,500 for a complete mainstream desktop system.* Competitive with a lower-performance, Pentium-based PC.** Watch for Apple Report #3, coming soon.



Through the technology transfer process, many of the systems, methods, and products pioneered by NASA are reapplied in the private sector, obviating duplicate research and making a broad range of new products and services available to the public.

Mission **A**ccomplished

The drive to create consumer-friendly electric vehicles (EVs) depends upon battery technology, which must offer not only emission-free but efficient, safe, and far-reaching propulsion. A key component of many of the leading-edge battery systems powering today's most promising EVs is a contactor from Kilovac Corp., Santa Barbara, CA, originally developed to provide the main electrical power switch on NASA's space station.

The impetus behind the contactor's development came in 1989 when Rocketdyne began designing the space station's electrical power system, scheduled to be assembled in space beginning in 1997. Because the system will have to operate at very high power levels, Rocketdyne needed small, lightweight contactors that could reliably switch and interrupt high current at high voltages.

"The main thing that enabled us to win the Rocketdyne contract was our ability to demonstrate capability at high power levels in a small relay—other people can switch power like we can, but their devices are a lot bigger," said Stephen Perreira, senior engineer at Kilovac. "We were able to make leaps forward in size reduction because we use a nonconventional actuator mechanism; the whole moving mecha-

The cutaway at right illustrates a direct current contactor originally developed for the space station's electrical power system that now serves in today's most advanced electric vehicles.

Below: the two-seater Impact, General Motors' new electric car, which offers a city/highway range of 70/90 miles, 0-60 mph acceleration of 8.5 seconds, and a top speed of 80 mph. A two-year field test beginning this spring will afford 1000 customers nationwide the opportunity to test drive the Impact.





THE NEXT BREAKTHROUGH IS YOURS.

Some people called McDonnell Douglas Aerospace's mission "unthinkable": develop a prototype reusable single-stage rocket vehicle in less than two years. And do it on a budget that was unthinkable tight.



But only eighteen months later and under budget, McDonnell Douglas' Guidance Navigation and Control Group delivered flight control software for the Delta Clipper Experimental rocket. On its first flight on August 18, 1993, the autonomously controlled DC-X performed flawlessly, taking off and landing vertically, right on target.

That's a breakthrough. And that's the kind of results we at Integrated Systems, Inc. hear consistently from users of our MATRIX_x® Product Family tools. In fact, a recent survey showed that MATRIX_x users cut development cost and

time-to-market by up to 67%. These are the gains that McDonnell Douglas and others have learned to expect from the industry's only complete mathematical analysis, modeling, simulation, code generation and hardware-in-the-loop prototyping environment.

"The MATRIX_x design tools made it possible to meet the ambitious schedule, budget and technical goals for the DC-X," declared Matt Maras, GN&C Software Program Manager, McDonnell Douglas Aerospace.

If we can help McDonnell Douglas perform the "unthinkable," imagine what Integrated Systems and our MATRIX_x Product Family can do for you.



(800) 932-6284

e-mail info@isi.com.

nism is within the vacuum switch assembly, which results in very high reliability and long electrical life."

The resulting product became known as the Czonka contactor, a 270 VDC vacuum contactor with a 150 A continuous carry and 500 A overload rating. Based on the success of the Czonka, Kilovac was awarded another space station contract for what eventually would become the Bubba contactor. It can make and break 350 A and carry 500 A with an overload rating of 1500 A at 320 VDC.

Switching high-voltage DC loads is one of a contactor's toughest jobs. The contactor has two parts: one that opens and closes the contacts and a means to control the arc that occurs between the contacts when power is switched. Kilovac developed techniques to control and manage these arcs, ensuring that unbreakable welds don't form, that contact erosion is limited, and that even at high overload ratings the arc always is extinguished.

"The basic form of the Bubba relay was the big breakthrough that drove our technology into commercial viability," said Perreira. "The first Rocketdyne contract allowed us to develop a highly reliable internal moving mechanism, then with Bubba we were able to develop an improved arc control mechanism."

Electric vehicle manufacturers took notice. The same characteristics that qualify the contactors for space application make them useful in EVs: small size, light weight, low power consumption, high overload capability, bi-directional switching, and a sealed switching chamber.

By 1990, the push was on to create commercial-grade electric vehicles to meet California's new Zero Emission Vehicle initiative. The law requires that starting in late 1997 (model year 1998), two percent of all cars sold in California must be zero emission vehicles. To date, 11 other states have adopted the initiative.

The Delco Remy Division of General Motors (GM) selected the Czonka for use in the 312 V, 16.8 kW-hour battery pack that powers the Impact, GM's new electric car. The contactor serves as a disconnect that automatically isolates the batteries in the event of an electrical problem.

The Impact's battery pack employs

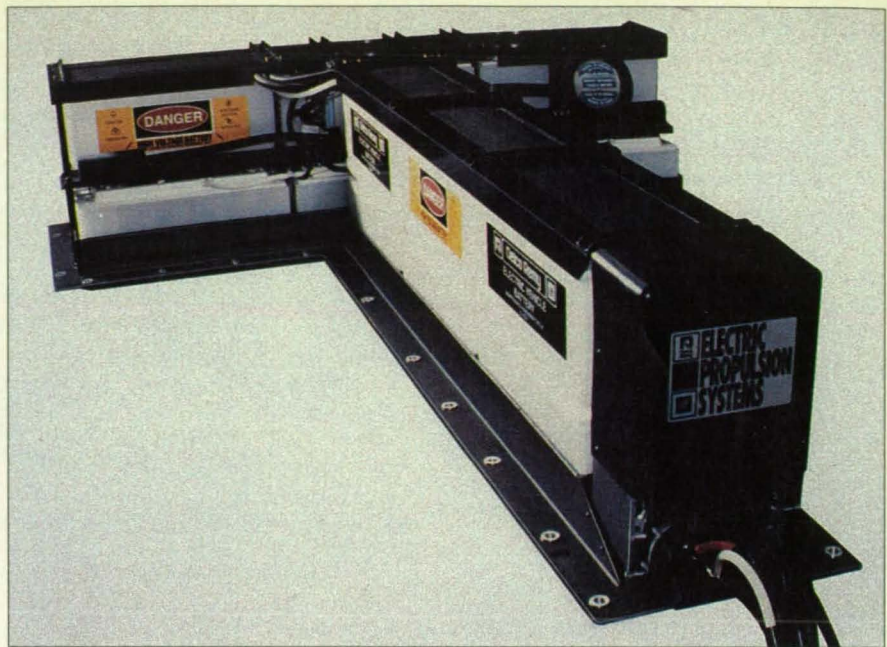

The Delco Remy Division of General Motors developed this T-shaped battery pack for the Impact, incorporating 26 serially-connected 12 V gas recombinant lead-acid battery cells to power the car's 137-horsepower AC induction electric motor. The pack employs Kilovac's Czonka contactors as automatic safety disconnects.

27 valve-regulated 12 V gas recombinant lead-acid battery cells arranged both longitudinally down the center of the car and laterally behind the wheels. This layout conserves interior space while making the battery pack a structural component of the car. Twenty-six of the cells supply power to its front-drive 137-horsepower (102 kW), liquid-cooled AC induction electric motor, enabling the two-seater Impact to travel from 0 to 60 mph in 8.5 seconds with a top speed of 80 mph. The remaining cell powers onboard accessories including steering, braking, heating and air conditioning, and displays.

To make the Impact practical for consumers, a charge port built into the car's nose accepts a magnetic inductive coupler, which eliminates exposed contacts and connects to a home's 220 V electrical system or 110 V household outlet. Fully charged in two to three hours, the battery pack provides the energy equivalent of 1.5 gallons of gasoline for a range of 70-90 miles. Charging will cost consumers approximately one penny per mile.

Starting in April, GM, in partnership with a number of electric utilities, will provide 1000 households in 12 cities nationwide the opportunity to test drive one of 50 limited-production Impacts. The planned two-year "PrEView" is intended to encourage development of the service and charging infrastructure needed to support EVs, demonstrate EV technology, and obtain feedback from potential customers about

the car's performance.

The Kilovac contactors have found application in other electric vehicles including buses and boats. The Czonka contactors are part of the battery module used by US Electricar, Sebastopol, CA, to convert Geo Prizms and Chevrolet S-10 pickup trucks into EVs, 200 of which are currently on the road.

Ed Rannburg of Fontana, CA, is counting on three Bubba contactors to help him set a new world EV land speed record this summer. His vehicle, called the Lightning Rod, is expected to exceed 200 mph, well over the current record of 175 mph set in 1974.

Additionally, the contactors can be applied in a wide range of industrial applications, including backplane power for computers, utility and factory control power, light rail transit, distributed power systems, circuit protection, and transfer switching.

Incorporating technology developed during the Rocketdyne contract for the Bubba contactor, Kilovac recently introduced the Czonka II, which can make and break 250 A with a 1500 A overload rating. Currently serving as the main generator contact on the F22 fighter aircraft, the Czonka II is designed for use in the next generation of electric cars. □

For more information about the technology discussed above, contact Pat McPherson, Vice President of Sales and Marketing, Kilovac Corp., P.O. Box 4422, Santa Barbara, CA 93140. Tel: 805-684-4560; Fax: 805-684-9679.

Two Money Saving Deals For Algor Customers Only*

Deals may vary each month, so phone Algor right away for details!

#1: Power Booster Pak

Includes Everything Shown Here:

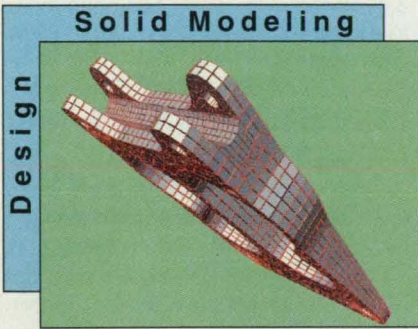

Model courtesy of Mercurier Stern Drives and Inboards, Stillwater, OK, U.S.A.



Model courtesy of Italmagnésio Sao Paulo, Brazil.

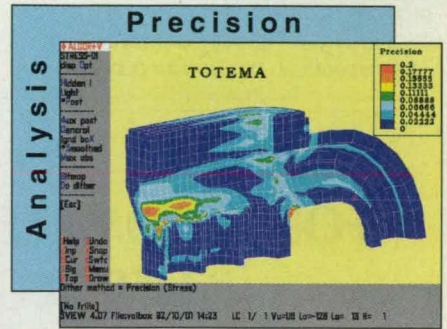

Model courtesy of Totema Sofia, Bulgaria.



Hexagen Automatic 3-D, 8-Node "Brick" Solid Mesh Generator. The world's first fully-automatic, 8-node "brick" solid mesh generator. Works from a surface mesh for total control of mesh density and model accuracy. Develop solid models faster and perform more design iterations in less time.

Supergen Automatic 2-D Mesh Generator. Create triangular, quadrilateral, or mixed meshes with the touch of a button. You have complete control of the mesh density in all parts of your model.

Supersurf NURBS Surface and Solid Modeler. Quickly build solid or surface models. Supersurf automatically generates sophisticated 3-D NURBS surfaces and, with Hexagen, develops 8-node "brick" meshes for solid models.

Beam Design Editor. Faster, easier creation of models that include beams and trusses. Perfect for modeling towers, bridges and other specialized designs.

#2: Master Booster Pak

Includes Everything Shown in Package Number 1, PLUS:

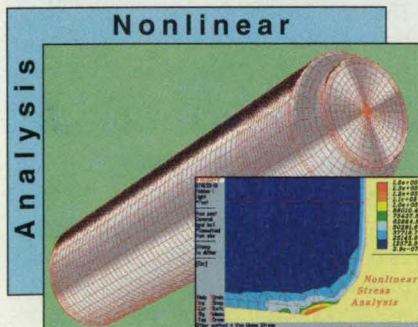

Model courtesy of West Valley Nuclear Services Co., West Valley, NY, U.S.A.

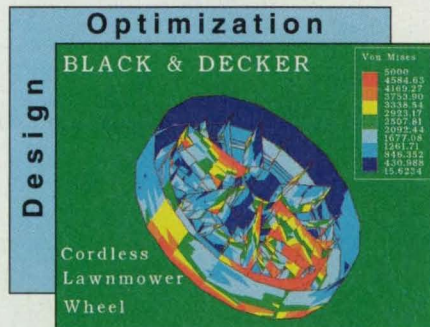

Model courtesy of Black & Decker Canada, Inc., Brockville, Ontario, Canada.

Accupak Nonlinear Stress and Vibration Analysis. Adds nonlinear material and large deformation analyses.

EAGLE Design Optimization Control System. Algor's unique and powerful engineering software control environment. Adds sensitivity analysis, design optimization and complete concurrent engineering capabilities. Also includes the **Concurrent Engineering Handbook**. The "must-have" EAGLE companion for concurrent engineering and design optimization. Provides real-world examples in written form and on disk.

* If you are not yet an Algor customer, we have special deals for you, too. Call today and ask for your account manager.

Add-Ons

Analysis

- Steady-state and transient heat transfer
- Nonlinear heat transfer
- Steady-state and transient fluid flow
- Composite materials
- Electrostatics
- ASME, CAD-based piping analysis with code checking
- Kinematics and rigid-body dynamics



When the Engineering Has to be Right™

Chosen by more than 10,000 engineers in over 60 countries.

For DOS, UNIX and Windows NT

150 Beta Drive
Pittsburgh, PA 15238-2932 USA
Phone: (412) 967-2700
Fax: (412) 967-2781
California: (714) 564-2541
Europe (UK): +44 (784) 442 246
Tokyo: +81 03-3589-6148

Copyright © 1993 Algor, Inc. TM Trademark of Algor, Inc.



New Product Ideas

New Product Ideas are just a few of the many innovations described in this issue of *NASA Tech Briefs* and having promising commercial applications. Each is discussed further on the referenced page in the

appropriate section in this issue. If you are interested in developing a product from these or other NASA innovations, you can receive further technical information by requesting the TSP referenced

at the end of the full-length article or by writing the Technology Utilization Office of the sponsoring NASA center (see page 20). NASA's patent-licensing program to encourage commercial development is described on page 20.

Stationary Camera Aims and Zooms Electronically

A video camera pans, tilts, zooms, and provides rotations of images of objects of its field of view, all without moving parts. The camera can be used for surveillance,

for closeup tracking of multiple objects in the field of view, or to break an image into sectors for simultaneous viewing, thereby replacing several cameras. (See page 46.)

Low-Toxicity PMR Polyimide

A new, low-toxicity PMR system has been developed. This system incorporates 3,4'-oxydianiline, which has been found to exhibit no detectable mutagenicity. (See page 74.)

Lightweight Electrode for Nickel/Hydrogen Cell

An improved substrate for a nickel electrode increases the specific energy a nickel/hydrogen cell. The substrate consists of 50 percent by weight nickel fiber, 35 percent nickel powder, and 15 percent cobalt powder. (See page 72.)

Synthesis of Perfluoro Orthocarbonates

They might be useful as heat-exchange fluids, lubricants, and/or vapor-phase soldering fluids. (See page 80.)

Acetylene- and Phenylacetylene-Terminated Poly(Arylene Ether Benzimidazole)s (PAEBI's)

These polymers exhibit excellent adhesion to copper foil and polyimide film. The materials are potentially useful as adhesives, coatings, composite matrices, fibers, films, membranes, and moldings. (See page 76.)

Latching Solenoid-Operated Ball Valve

A proposed ball valve would latch in its open or closed position until it is energized to change position. The valve would consume energy only during the switching interval, which would last no more than 40 ms. (See page 97.)

Improved All-Terrain Suspension System

A new suspension system for an all-terrain vehicle exhibits enhanced ability to negotiate sand and rocks. The suspension has potential application in off-road vehicles and toys. (See page 97.)

FOR AUTOMATED VISION OEMs, LIFE BEGINS AT ...

40 MHz



Series 150/40

"the industry's *fastest* vision processor"

- Modular 40 MHz pipeline processors
- Plug-on 40 MHz DSPs for high-speed image analysis
- Expandable parallel pipelines defined by software
- Real-time, true-color processing
- Extensive vision application software tools
- Unrestricted choice of image sensors
- VMEbus, ISA/EISA, and S-bus compatible
- In OEM quantities, single-board configurations start at less than \$7,500

**IMAGING
IMAGING
IMAGING
IMAGING
IMAGING**
Technology Inc.

Call (800) 333-3035
for additional details!



The NVIS-Sunlight Readable Interactive Switch System.

The VIVISUN 5000 interactive switch system incorporates LED lighting that is both NVIS compatible and sunlight readable per MIL-L-85762A. This fully programmable system also provides rugged reliability and meets the environmental extremes that military programs demand.

The VIVISUN 5000 LED dot-matrix display switch has a 1000:1 dimming ratio which achieves NVIS compatibility and sunlight readability (10,000 foot-candles). System features include: Total Legend Flexibility • Serial Data Line via RS-232C or RS-422

• Interactive Tactile Response • Uniform Lighting in Low Level/Sheltered Environments • NDI Immediate Integration.

The VIVISUN 5000 interactive switch system is the solution for your ruggedized military design requirements.

Contact us today.



AEROSPACE OPTICS INC.

3201 Sandy Lane, Fort Worth, Texas 76112
Phone (817) 451-1141 • Fax (817) 654-3405

*VIVISUN 5000 interactive switch system.
The day-night all weather lighting solution.*



SERIES

VIVISUN 5000™



HOW YOU CAN BENEFIT FROM NASA'S TECHNOLOGY UTILIZATION SERVICES

If you're a regular reader of TECH BRIEFS, then you're already making use of one of the low-and no-cost services provided by NASA's Technology Transfer Program. But a TECH BRIEFS subscription represents only a fraction of the technical information and applications/engineering services offered by this Program. In fact, when all of the components of NASA's Technology Transfer Network are considered, TECH BRIEFS represents the proverbial tip of the iceberg.

We've outlined below NASA's Technology Transfer Network—named the participants, described their services, and listed the individuals you can contact for more information relating to your specific needs. We encourage you to make use of the information, access, and applications services offered.

How You Can Access Technology Transfer Services At NASA Field Centers:

Technology Utilization Officers & Patent Counsels—Each NASA Field Center has a Technology Utilization Officer (TUO) and a Patent Counsel to facilitate technology transfer between NASA and the private sector.

If you need further information about new technologies presented in *NASA Tech Briefs*, request the Technical Support Package (TSP). If a TSP is not available, you can contact the Technology Utilization Officer at the NASA Field Center that sponsored the research. He can arrange for assistance in applying the technology by putting you in touch with the people who developed it. If you want information about the patent status of a technology or are interested in licensing a NASA invention, contact the Patent Counsel at the NASA Field Center that sponsored the research. Refer to the NASA reference number at the end of the Tech Brief.

Ames Research Ctr.

Technology Utilization
Officer: Geoffrey S. Lee
Mail Code 223-3
Moffett Field, CA 94035
(415) 604-4044
Patent Counsel:
Darrell G. Brekke
Mail Code 200-11
Moffett Field, CA 94035
(415) 604-5104

Lewis Research Center

Technology Utilization
Officer: Anthony F.
Ratajczak
Mail Stop 7-3
21000 Brookpark Road
Cleveland, OH 44135
(216) 433-5568
Patent Counsel:
Gene E. Shook
Mail Code LE-LAW
21000 Brookpark Road
Cleveland, OH 44135
(216) 433-5753

John C. Stennis

Space Center
Acting Technology
Utilization Officer:
Richard A. Galle
Code HA-30
Stennis Space Center,
MS 39529
(601) 688-1929

John F. Kennedy

Space Center
Technology Utilization
Officer: James A.
Aliberti
Mail Stop DE-PAT
Kennedy Space
Center, FL 32899
(407) 867-3017
Patent Counsel:
Bill Sheehan
Mail Code DE-PAT
Kennedy Space
Center, FL 32899
(407) 867-2544

Langley Research Ctr.

Technology Utilization
Officer: Joseph J.
Mathis, Jr.
Head, TU & AO Office
Mail Stop 200
Hampton, VA 23681-0001
(804) 864-2484
Patent Counsel:
Dr. George F. Helfrich
Mail Stop 143
Hampton, VA 23681-0001
(804) 864-3221

Goddard Space Flight

Center
Technology Utilization
Officer: Dr. George Alcorn
Mail Code 702
Greenbelt, MD 20771
(301) 286-5810
Patent Counsel:
R. Dennis Marchant
Mail Code 204
Greenbelt, MD 20771
(301) 286-7351

Jet Propulsion Lab.

NASA Resident Office
Technology Utilization
Officer: Arif Husain
Mail Stop 180-801D
4800 Oak Grove Drive
Pasadena, CA 91109
(818) 354-4862
Patent Counsel:
Thomas H. Jones
Mail Code 180-801G
4800 Oak Grove Drive
Pasadena, CA 91109
(818) 354-5179

Technology Utilization

Mgr. for JPL:
Wayne Schober
Mail Stop 122-116
4800 Oak Grove Drive
Pasadena, CA 91109
(818) 354-2240

Technical Information/

Inquiries:
1-(800) 832-4575

George C. Marshall

Space Flight Center
Technology Utilization
Officer: Ismail Akbay
Code AT01
Marshall Space Flight
Center,
AL 35812
(205) 544-2223
(800) 437-5186
Patent Counsel:
Robert L. Broad, Jr.
Mail Code CC01
Marshall Space Flight
Center,
AL 35812
(205) 544-0021

Lyndon B. Johnson

Technology Utilization
Officer: Richard B.
Ramsell
Mail Code IC-4
Building 4 South

Houston, TX 77058

(713) 483-3809
Patent Counsel:
Edward K. Fein
Mail Code AL3
Houston, TX 77058
(713) 483-4871

NASA Headquarters

Technology Utilization
Officer: Leonard A. Ault
Code CU
Washington, DC 20546
(202) 358-0721
Associate General
Counsel for Intellectual
Property: Jack Mannix
Code GP
Washington, DC 20546
(202) 453-2424

How You Can Utilize NASA's Regional Technology Transfer Centers (RTTCs)— A nationwide network offering a broad range of technology transfer and commercialization services.

You can contact NASA's network of RTTCs for assistance in solving a specific technical problem or locating technology or markets that match your interests. The RTTCs are experienced in working with industry to define technology needs and acquire and commercialize applicable technology. User fees are charged for most services. **For more information, call 1-800-472-6785** and you will be connected to the RTTC in your geographical region (or you may call or write directly to the RTTC in your region).

REGIONAL TECHNOLOGY TRANSFER CENTERS (RTTCs)

RTTC Directors

NORTHEAST

Dr. William Gasko
Center for Technology
Commercialization
Massachusetts Technology Park
100 North Drive
Westborough, MA 01581
(508) 870-0042

MID-ATLANTIC

Ms. Lani S. Hummel
University of Pittsburgh
823 William Pitt Union
Pittsburgh, PA 15260
(412) 648-7000
(800) 257-2725 (toll-free US)

SOUTHEAST

Mr. J. Ronald Thornton
Southern Technology Application
Center
University of Florida
College of Eng.
Box 24
One Progress Boulevard
Alachua, FL 32615
(904) 462-3913
(800) 225-0308 (outside FL)

MID-CONTINENT

Mr. Gary Sera
Texas Engineering Experiment Station
Texas A&M University System
237 WERC
College Station, Texas 77843-3401
409-845-8762

MID-WEST

Dr. Joseph W. Ray
Great Lakes Industrial Technology Center
25000 Great Northern Corporate Center
Suite 260
Cleveland, OH 44070-5310
(216) 734-0094

FAR-WEST

Mr. Robert Stark
Technology Transfer Center
University of Southern California
3716 South Hope Street,
Suite 200
Los Angeles, CA 90007-4344
(213) 743-6132
(800) 642-2872 (CA only)
(800) 872-7477 (toll-free US)

If you are interested in information, applications, research, training, and services relating to satellite and aerial data for Earth resources, contact NASA's transfer point for earth observing technology: **Earth Data Analysis Center, University of New Mexico, 2500 Yale Blvd. S.E., Suite 100, Albuquerque, NM 87131-6031; Dr. Stan Morain, Director (505) 277-3622.**

If you represent a public sector organization with a particular need, you can contact NASA's Application Team for technology matching and problem solving assistance. Staffed by professional engineers from a variety of disciplines, the Application Team works with public sector organizations to identify and solve critical problems with existing NASA technology. **Technology Application Team, Research Triangle Institute, P.O. Box 12194, Research Triangle Park, NC 27709; Dr. Doris Rouse, Director, (919) 541-6980**

A Shortcut To Software: COSMIC—For software developed with NASA funding, contact COSMIC, NASA's Computer Software Management and Information Center. New and updated programs are announced in the Computer Programs section. COSMIC publishes an annual software catalog. For more information call or write: **COSMIC**, 382 East Broad Street, Athens, GA 30602 *John A. Gibson, Director, (706) 542-3265; FAX (706) 542-4807.*

If You Have a Question..NASA Center For AeroSpace Information can answer questions about NASA's Technology Transfer Network and its services and documents. The CASI staff supplies documents and provides referrals. Call, write or use the feedback card in this issue to contact: **NASA Center For AeroSpace Information, Technology Transfer Office, 800 Elkridge Rd, Linthicum Heights, MD 21090-2934. Walter M. Heiland, Manager, (410) 859-5300, Ext. 245.**

HIGH ACCURACY

LOW COST

ALL OF THE ABOVE

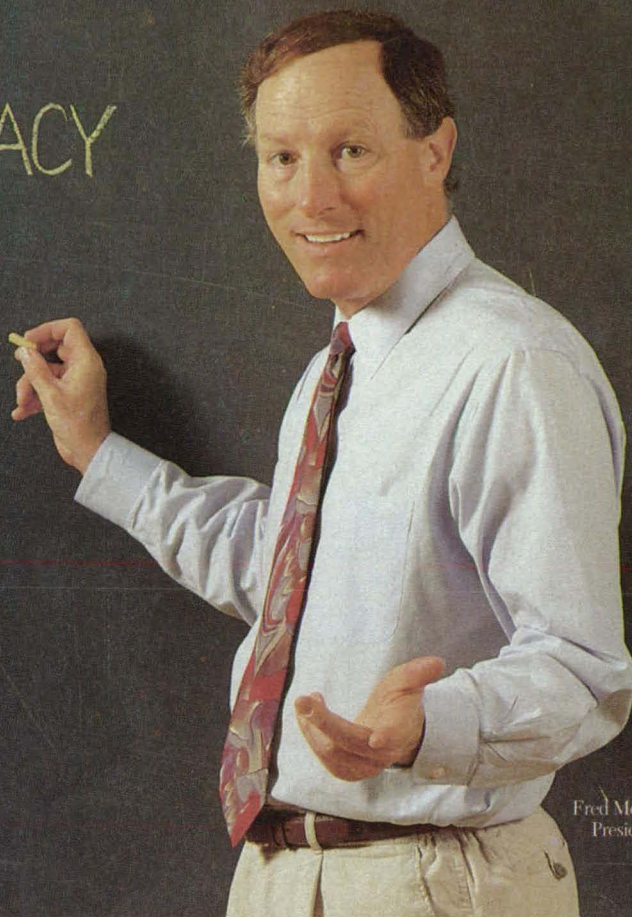

Fred Molina
President

With Our New Frame Grabbers, It's No Longer a Trade-Off.

High-accuracy frame grabbers mean better data, sharper edges, less noise, and more precise measurements. But they don't have to mean higher price tags. Our two new frame grabbers give you the high accuracy you need—at **unbeatable prices**.

Both boards are supported by our award-winning GLOBAL LAB® *Image* software, which allows you to perform sophisticated image analysis in minutes. They also ship with FREE software for Microsoft® Windows™. So call Data Translation today and get high-accuracy imaging at low cost. You don't have to settle for less.

HIGH ACCURACY	LOW COST
Fidelity 100 <ul style="list-style-type: none">• \$1,495• Unsurpassed accuracy• For standard, nonstandard, high resolution video inputs• 32-bit EISA interface.	Vision-EZ <ul style="list-style-type: none">• \$995• Low cost imaging solution• High accuracy acquisition of standard video inputs• 16-bit ISA interface.

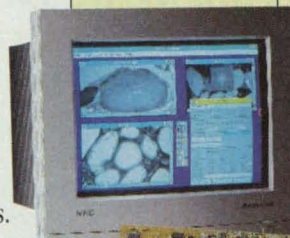

**IN THE USA AND
CANADA CALL
1-800-525-8528,
EXT. 390**



DATA TRANSLATION

World Headquarters: (508) 481-3700, UK Headquarters: (0734) 793838, Germany Headquarters: (07142) 95 31-0, France Headquarters: 69.29.98.88, Italy Headquarters: (030) 2425696.
Sales Offices: Argentina (541) 631-1212, (541) 244-4668; Australia 2699-8300; Austria: (222) 367660; Belgium (02) 466.81.99; Brazil 11564-6024; Canada (508) 481-3700, (800) 525-8528; China 86 1 8499586/87; Denmark (45) 42 27 45 11; Finland (0) 3511800; Greece (1) 361-4300; Hong Kong (852) 515-0018; India (22) 23-1040; Israel 9-545685; Japan (33) 502-5550, (33) 5379-1971; Korea (2) 718-9521; Malaysia (3) 248-6786; Mexico 575-6091, 575-6098; Netherlands (70) 399-6360; New Zealand (9) 415-8362; Norway (22) 43 41 50; Portugal (1) 7934834, (1) 7934934; Singapore 773 4300; South Africa (12) 803-7680/93; Spain (1) 555-8112; Sweden 08-765 02 80; Switzerland (1) 386-8686; Taiwan (2) 3039836; Thailand (02) 281-9596, (02) 282-4834, (02) 282-4797; Turkey (212) 288-6213/15, (212) 274 9097

8.27.93

For More Information Write In No. 463



Special Focus: Computer-Aided Design and Engineering

Σ Program Trains NASTRAN Users

RENT enables each user to learn at his or her own pace.

The Rockwell Environment and NASTRAN Trainer (RENT) computer program has been developed to assist new and current users of the NASTRAN finite-element computer code. NASTRAN is best learned by using it. Previous methods have been to learn on the job or possibly from university course work. Often the work is not broad enough in scope to cover the many features of finite-element mathematical modeling. The RENT program exposes the user to many facets of finite-element modeling at a pace set solely by the user. This provides for rapid learning of NASTRAN in comparison with learning by conventional methods.

RENT provides an organized, systematic collection of IBM features that consist of panels, clists, skeletons, and messages, along with FORTRAN and Pascal programs and example NASTRAN data files. A primary goal of RENT is to provide a user-friendly computing environment in which handling of files and operating-system considerations can be hidden from view of the average NASTRAN user. The NASTRAN user can build and run their own finite-element model without

concern for file allocations, procedures, and job-control languages. The environment is used for training as well as production level work.

The training module RENT is provided to instruct new users on many aspects of finite-element modeling by use of NASTRAN. This includes 18 problems (10 static, 8 dynamic) with classical solutions tailored to the sizes, properties, and loads chosen by the user. This enables individuals to learn at their own paces and to verify the accuracies of the models they build. A special feature of RENT is the extensive on-line COSMIC NASTRAN documentation available. This on-line manual provides instant information on the NASTRAN executive, case and bulk data cards, rigid formats, Direct Matrix Abstraction Program (DMAP) listings, and error messages. Also included is a NASTRAN dictionary.

RENT is written in VS/FORTRAN, VS/Pascal, and IBM job-control language for an IBM computer system running MVS/ESA SP 4.1.0 using TSO/E 2.1.0. Executable code is included. The VS/FORTRAN and VS/Pascal compilers are required to produce new executable code. RENT

has job setups to execute COSMIC/NASTRAN and MSC/NASTRAN on an IBM computer or MSC/NASTRAN on the CRAY computer running UNICOS 6.1. At least one of these versions of NASTRAN is required to run RENT as intended. RENT includes over 80,000 lines of online NASTRAN documentation. The standard distribution medium for this program is a 1,600-bit/in. (630-bit/cm), 9-track magnetic tape in IEBCOPY format. A 5.25-in. (13.34-cm), 360K diskette in MS-DOS format containing installation files is also included. A 36-page System Manual accompanies this software. The Rockwell Environment and NASTRAN Trainer was released in 1991.

IBM is a registered trademark of International Business Machines Corp. CRAY and UNICOS are registered trademarks of Cray Research, Inc.

This program was written by H. R. Grooms, P. J. Hinz, M. A. Collier, Kim D. Cox, Warren J. Merriman, and Gerry Commerford of Rockwell International Corp., for Johnson Space Center. For further information, write in 47 on the TSP Request Card.
MSC-22092

⊙ Analyzing Seals With Two-Phase Flows

Performances of face and annular seals are computed from idealized mathematical models.

When liquid is sealed at a temperature higher than its saturation temperature at the outlet pressure, it flashes inside the seal because of the pressure drop and/or the viscous dissipation of heat. Typical examples of fluids and situations in which such two-phase flow may be encountered include light hydrocarbons in petroleum refineries, hot water in boiler-feed and reactor-coolant pumps, and cryogenic fluids like liquid oxygen and hydrogen in rocket turbopumps. The SEAL computer program analyzes the

steady-state performance of a face seal with two-phase leakage flow operating under both low-leakage laminar and high-leakage turbulent flows. The mathematical models used in the analysis are the quasi-isothermal model when the leakage flow is small and laminar, and the adiabatic turbulent model when the leakage is large and turbulent.

SEAL calculates the general trends of performance of face seals under both low- and high-leakage conditions and, by extrapolation, behavior in the interme-

diated region. Parameters that can be investigated include subcooling, coning of seal faces, speeds of rotation, conductivities of seal materials, and widths of seal faces. The program incorporates idealized mathematical models, and is based on a finite-difference approach.

SEAL is written in FORTRAN 77 for IBM PC-series computers and compatibles running MS-DOS. The executable code included on the SEAL diskette was created by use of Microsoft FORTRAN v.3.3.1. Hardware requirements include an 80286 or 80386 processor

Yes,
 you can do Windows™
 and walls and doors and
 floors, ceilings, whole 's,
 's, trains, boats, 's,
 chains, 's, diamond rings, 's
 and things, 's, power plants, topo maps,
 's, helicopters, roads
 and bridges, circuit boards, 's
 power lines, 's, airports, furniture,
 digital terrain models, 's, skateboards, the
 's, chemical plants, 's, golf courses,
 anything you can think of ... even the kitchen



MicroStation.
 CAD software for Windows
 and Windows NT

Open yourself to a world of design possibilities with MicroStation CAD software. From 2D drafting to advanced 3D surface modeling, MicroStation Version 5 is the ultimate design tool for the Windows environment. And the most complete, with photorealistic rendering and animation. All in one package!

Join the many designers who have made the move to the CAD tool for the '90s.

Call 800-345-4856 for a free demo disk and brochure on MicroStation.

 **MicroStation**
 CAD for the '90s

INTERGRAPH

and a math coprocessor. The main memory required for execution is 137K. Sample input, output, and instructions on execution are included with this software package. The standard distribution medium for this package is a 5.25-

in. (13.34-cm), 360K MS-DOS diskette. SEAL was developed in 1989.

MS-DOS is a registered trademark of Microsoft Corp. IBM PC is a registered trademark of International Business Machines Corp.

This program was written by S. Lau, P. A. Beatty, and William F. Hughes of Carnegie-Mellon University for Lewis Research Center. For further information, write in 19 on the TSP Request Card. LEW-15156

Program Helps Design Composite Panels

PASCO assists in buckling and vibration analysis and in low-mass design.

The Panel Analysis and Sizing Code (PASCO) computer program was developed for the buckling and vibration analysis and sizing of prismatic structures that have arbitrary cross sections. PASCO is primarily intended for analyzing and sizing stiffened panels made of laminated orthotropic materials, and is of particular value in analyzing and sizing filamentary composite structures.

When used in the analysis mode, PASCO calculates stiffnesses of lamina and stresses and strains (including the effects of temperature and panel bending) in lamina, buckling loads, vibration frequencies, and overall stiffnesses of panels. When used in the sizing mode, PASCO adjusts sizing variables to provide a low-mass design for a panel that can carry a set of specified loads without exceeding buckling or other material-strength allowances and that meets such other design requirements as upper and lower bounds on sizing variables, upper and lower bounds on overall bending, extensional and shear stiffnesses, and lower bounds on vibration frequencies.

Although emphasis in PASCO is placed on flat panels that contain several identical bays, the only restriction on configuration modeling is that the structure is assumed to be prismatic. In addition, it is assumed that loads and temperatures do not vary along the length of a panel. PASCO is designed to handle readily the analysis and sizing of the stiffened panels that are used widely in aerospace structures. The cross section of a panel can be composed of an arbitrary assemblage of thin, flat, rectangular plate elements that are connected together along their longitudinal edges. Each plate element consists of a balanced symmetric laminate of any number of layers of orthotropic material. Any group of element widths, layer thicknesses, and layer-orientation angles can be selected as sizing variables. Substructuring is available to increase the efficiency of the analysis and to simplify the modeling of complicated structures.

The Macintosh version of PASCO includes an interactive, graphic preprocessor called MACPASCO. The main objective of MACPASCO is to make the use of PASCO faster, simpler, and less error-prone. By including a graphical user interface (GUI), MACPASCO simplifies the specification of panel geometry and reduces the incidence of user's input errors, thus making the modeling and analysis of panel designs more efficient. The user draws the initial structural geometry on the computer screen, then uses a combination of graphic and text inputs to refine the structural geometry, specify information needed for analysis (for example, panel load conditions), and define design variables and constraints for minimum-mass optimization. Design of composite panels is an ideal application because the graphical user interface can serve as a visual aid, eliminate the tedious aspects of text-based input, and eliminate many sources of input errors. The current version of MACPASCO does not implement all the modeling features of PASCO but has been found to be sufficient for many users.

Because MACPASCO includes a GUI, many difficulties common to text-based inputs are avoided. First, the graphical displays eliminate syntax errors, like misplaced commas and incorrect command names, because there is no text-based syntax. Second, graphical displays enable the user to see the geometry as it is created, thereby assisting the user in immediately detecting and correcting any errors. Third, the drawing software tools in MACPASCO have been designed to avoid modeling errors. Fourth, the graphical displays make revisions to existing structural designs much easier and less error-prone by eliminating the need for the user to conceptualize the text input as geometry: the user can work directly with the geometry displayed on the screen. Finally, MACPASCO automatically generates the correct PASCO input file from the

geometry displayed on the screen. This input file can be used with any machine version of PASCO to perform the analysis and sizing and to display or transfer the results.

The DEC VAX and CDC CYBER versions of PASCO are written in FORTRAN IV for batch execution and have been implemented on a DEC VAX and a CDC CYBER 170-series computer. The CYBER version requires a problem-dependent central memory of 120K (octal) of 60 bit words. The Macintosh version of PASCO was developed for Macintosh II-series computers with at least 2 Mb of random-access memory running MPW Pascal 3.0 and Language Systems FORTRAN 2.0 under the MPW programming environment. It includes MPW-compatible makefiles for compiling the source code. The Macintosh version uses input files compatible with versions of PASCO that run on different computers. MACPASCO is written in Macintosh Programmers Workbench 3.0, MPW Pascal 3.0, and MacAPP 2.0. The Pascal source code is included on the distribution diskette. MacAPP is a development library of software that is not included. MACPASCO requires a Mac Plus, SE/30, or MacII, IIx, IIcx, IIci, or IIfx computer running System 6.0 or greater. MACPASCO is compatible with System 7.0. A minimum of 2 Mb of random-access memory is needed for execution.

The Macintosh version of PASCO is distributed on four 3.5-in. (8.89-cm), 800K Macintosh-format diskettes. The CDC and DEC VAX versions are distributed on 9-track, 1,600-bit/in. (630-bit/cm) magnetic tape. The PASCO program was developed in 1981, adapted to the DEC VAX in 1983, and to the Macintosh in 1991. MACPASCO was released in 1992.

This program was written by Stephen H. Lucas of Analytical Services and Materials, Inc., and Randall C. Davis of Langley Research Center. For further information, write in 54 on the TSP Request Card. LAR-14799



PV-WAVE

Your Decisions Are Only as Good as Your Analysis

Gathering data isn't so hard these days. Real-time information services, data acquisition systems, satellites, MRI scanners, and many other sources of information abound. All capable of generating more data than can be meaningfully interpreted.

Now available for Windows® and Windows-NT®

That's where PV-WAVE can help. PV-WAVE is designed to interactively manage, analyze, and display large and complex data sets. PV-WAVE is built around a powerful and flexible 4GL designed specifically for interactively analyzing data and building custom data analysis environments. PV-WAVE'S concise language can reduce your coding by up to 80%, so you can generate results quickly.

To do this, the PV-WAVE product family provides integrated mathematics and statistics, advanced graphing and plotting, custom GUI (Graphical User Interface) tools, real-time data monitoring, direct interfaces to SQL databases, connectivity to your existing application software, and even symbolic math capabilities. PV-WAVE readily accepts almost any data format, from rich HDF files, to raw ASCII data, to TIFF or bit-mapped data, and even custom data formats.

Making it a snap to turn even the most complicated data sets into practical knowledge.

So call us today, and learn how technical and financial customers the world over are using PV-WAVE to improve the speed and accuracy of their analyses and decision making.

Turn massive amounts of multi-variable data into easily interpreted images

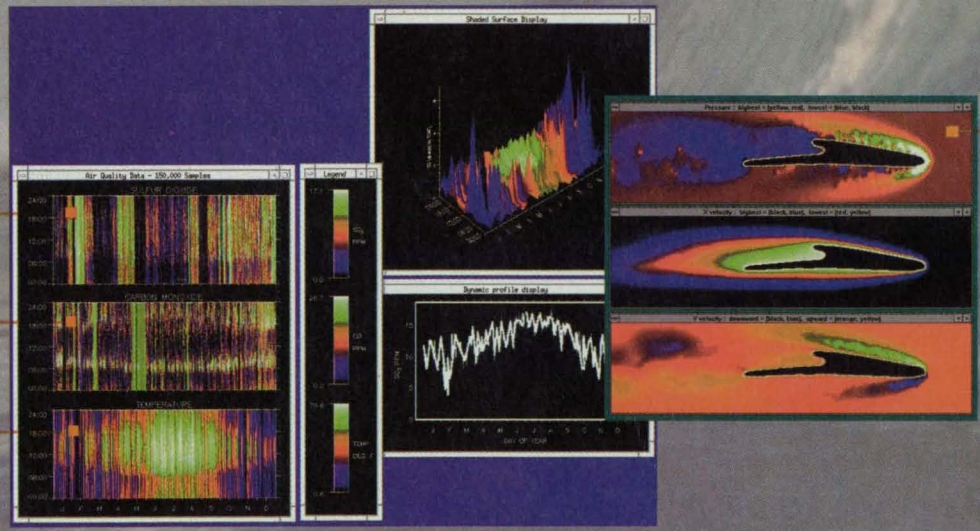

Perform analysis and display of multiple real-time data sources, such as data acquisition systems

For additional information and a product demo, call:

I-800-447-7147

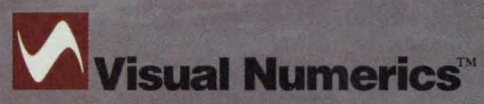

PV-WAVE Products
6230 Lookout Rd. • Boulder, Colorado 80301 USA
Tel: 303-530-9000 • FAX: 303-530-9329

Corporate Headquarters
9990 Richmond Avenue, Suite 400 • Houston, Texas 77042-4548 USA
Tel: 713-784-3131 • FAX: 713-781-9260



Preprocessor Program for Use With PASCO

MACPASCO makes the specification of panel geometry easier and less error-prone.

MACPASCO is an interactive, graphical preprocessor program designed to make the use of the Panel Analysis and Sizing Code, PASCO, (COSMIC program numbers LAR-13004, LAR-13164, and LAR-14799) faster, simpler, and less error-prone. PASCO is primarily intended for use in analyzing and sizing stiffened panels made of laminated orthotropic materials and is of particular value in analyzing and sizing filamentary composite structures. MACPASCO is a Macintosh-based preprocessor program that includes a graphical user interface (GUI) program to simplify the specification of panel geometry, thus making the modeling and analysis of panel designs more efficient and reducing the potential for user input errors. Although MACPASCO runs only on a Macintosh computer, output from MACPASCO can be used as input for any machine version of PASCO. For this reason, COSMIC offers MACPASCO (LAR-14908) as a separate package in addition to including it in the Macintosh version of PASCO (LAR-14799).

When one uses MACPASCO, one draws the initial structural geometry on the computer screen, then uses a combination of graphical and textual inputs

to refine the structural geometry, specify information needed for analysis (for example, panel load conditions), and define design variables and constraints for minimum-mass optimization. Design of composite panels is an ideal application because the graphical user interface can serve as a visual aid, eliminate the tedious aspects of text-based input, and eliminate many sources of input errors. The current version of MACPASCO does not implement all the modeling features of PASCO but has been found to be sufficient for many users.

Because MACPASCO includes a GUI, many difficulties common to text-based inputs are avoided. First, the graphical displays eliminate syntax errors, like misplaced commas and incorrect command names, because there is no text-based syntax. Second, graphical displays enable the user to see the geometry as it is created, thereby assisting the user in immediately detecting and correcting any errors. Third, the drawing software tools in MACPASCO have been designed to avoid modeling errors. Fourth, the graphical display makes revisions to existing structural designs much easier and less error-prone by eliminating the need for the user to conceptualize the text in-

put as geometry; the user can work directly with the geometry displayed on the screen. Finally, MACPASCO automatically generates the correct PASCO input file from the geometry displayed on the screen. This input file can be used with any machine version of PASCO to perform the analysis and sizing and to display or transfer the results.

MACPASCO is written in Macintosh Programmers Workbench 3.0, MPW Pascal 3.0, and MacAPP 2.0. A sample executable code is included on the distribution diskette. MacAPP is a development library of software that is not included. MACPASCO requires a Mac Plus, SE/30, or MacII, IIx, IIcx, IIci, or IIfx computer running System 6.0 or greater. MACPASCO is compatible with System 7.0. A minimum of 2 Mb of random-access memory is needed for execution. The standard distribution medium for MACPASCO is a set of two 3.5-in. (8.89-cm), 800K Macintosh-format diskettes. MACPASCO was released in 1992.

This program was written by Stephen H. Lucas of Analytical Services and Materials, Inc., and Randall C. Davis of Langley Research Center. For further information, write in 30 on the TSP Request Card. LAR-14908



Integrated Composite Analyzer (ICAN/PC)

Hygral, thermal, and mechanical responses can be analyzed for multilayered fiber composites.

The Integrated Composite Analyzer (ICAN/PC) is a computer program designed to carry out a comprehensive linear analysis of multilayered continuous-fiber polymer matrix composites. The analysis contains the essential features required for the effective design of structural components made from fiber composites. ICAN/PC includes the micromechanical design features of the Intraply Hybrid Composite Design (INHYD) program to predict hygral, thermal, and mechanical properties at the ply level. The laminate-analysis features of the Multilayered Filamentary Composite Analysis (MFCA) program are included to account for interply-layer effects. ICAN/PC integrates these and additional features to provide a comprehensive capability for analysis of composite structures.

Additional features unique to ICAN/PC include the following: (1) influence coefficients for stresses and strains in

plies; (2) microstresses and microstrain influence coefficients; (3) stress concentration factors for material around a circular hole; (4) calculation of probable delamination locations around a circular hole; (5) details of Poisson's-ratio mismatch near a straight edge; (6) free-edge stresses; (7) material card input for finite-element analysis using NASTRAN (available separately from COSMIC) or MARC; (8) failure loads based on a maximum-stress criterion and laminate failure stresses based on first-ply failures and fiber-breakage criteria; (9) transverse shear, normal, and interlaminar stresses; and (10) durability/fatigue-type analyses for thermal as well as mechanical cyclic loads. The code can currently assess degradation due to mechanical and thermal cyclic loads with or without a defect. ICAN/PC includes a dedicated data bank of properties of constituent materials and enables the user to build a data base of

properties of commonly used fiber and matrix materials so the user need only specify code names for constituents.

Input to ICAN/PC includes properties of constituent materials (or code names), factors that reflect the fabrication process, and geometry of the composite. ICAN/PC performs micromechanics, macromechanics, and laminate analyses, taking account of the hygrothermal responses of fiber composites. The output of ICAN/PC includes the various properties of plies and composite and results of stress analyses of composite, with details of failures. Output can be tailored to specific needs by choosing the appropriate options.

ICAN/PC is written in FORTRAN 77 for use on IBM or compatible personal computers running MS-DOS. The source code has been compiled by using Microsoft FORTRAN version 5.1. A sample executable code, along with sample

These won't save you time or money...

$$\nabla \times \mathbf{H} = \mathbf{J} + \epsilon \frac{\partial \mathbf{E}}{\partial t} \quad \nabla \times \mathbf{E} = -\mu \frac{\partial \mathbf{H}}{\partial t} \quad \nabla \cdot \mathbf{E} = \frac{\rho}{\epsilon} \quad \nabla \cdot \mathbf{H} = 0$$

THESE WILL.



A CAE package that provides immediate productivity and saves prototyping dollars is very hard to find. With our line of fully integrated BEM electromagnetic simulation software, we can help.

Each of our packages is designed around three basic principles: advanced technology, productivity and exceptional customer service.

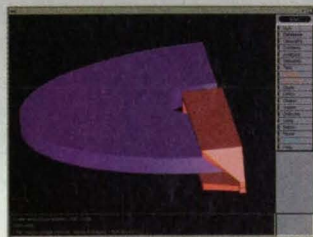

Solutions are obtained 4x faster using symmetry conditions.

element refinement, relative error detection, 3D symmetry conditions and a complete database manager give you the most advanced programs available anywhere.

immediate productivity, where there is a significant learning curve involved in all FEM packages."

Advanced Technology

"I have analyzed literally hundreds of linear and non-linear electromechanical devices with IES software. It has become an invaluable tool to me, as it's so much easier to work with than FEM software. Unlike FEM, BEM software does not necessitate any re-gridding of the problem when one medium is being rotated or translated with respect to another, which results in a significant time saving."

Dr. Kent Davey

Georgia Institute of Technology

Progressive features like our automatic/adaptive boundary

Visit us at NDES '94 - Booth #2284

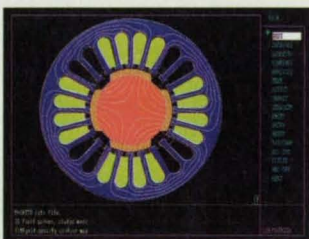

Torque vs. position curves for optimal motor design are readily calculated.

Productivity

"IES BEM programs have consistently outperformed the seven FEM packages I have evaluated in the past few years. The operator interface of IES programs allows for

Nicholas F. Campagna

Consultant

We have set up sample problems for you to work through along with databases of solved problems comparable to conventional industry-specific needs. Shorten the steps to your solution with IGES geometry translators and parametric definitions.

Customer Service

"IES has consistently impressed us with their speed of response and strong commitment to work with us on unique problems."

Jim Aydelotte

Magnetic Instrumentation

On-line help, full technical support and two complete program enhancements each year keep you on the cutting edge of CAE design and analysis.

Load a single diskette or tape onto your PC or workstation. Within one day you will begin working on your own problems. In just a week, even the most sophisticated 3D design solutions are yours. We give you our word. And so have our customers.

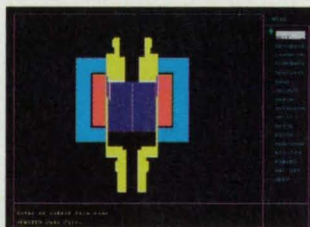

Use BEM to solve non-linear eddy current problems.

Call today for your 30-day no-charge software evaluation.



I N T E G R A T E D
E N G I N E E R I N G S O F T W A R E

TEL: (204) 632-5636 FAX: (204) 633-7780

e-mail: info@integrated.mb.ca

For More Information Write In No. 467

OUR NETWORK SOLUTIONS HELP YOU AVOID SOLITARY CONFINEMENT.

You may have a great desktop system and the latest software. You most certainly have very high hopes for bringing a network of PCs and workstations together



**Banyan VINES
Unlimited \$5,043**

Use Banyan's Enterprise Networking Services—like the StreetTalk Global Directory—to build the world's largest, yet easiest to use and manage enterprise-wide networks. (#513-352-3)

without an expensive mainframe. But unless you have the right connections, your client/server networking plans will go nowhere. You'll be all alone in the computing world, your data stranded on your desktop.

Fortunately, there's no need to stay in seclusion. Because the networking experts at



**Hewlett-Packard NetServer
LM 5160 \$6,976**

Designed for high-performance networks, it is easy to manage and maximizes uptime. Plus, it features a 60MHz Pentium processor, 8KB internal/256KB external cache, 16MB RAM and 1GB hard disk. (#866-1345)

spring you and your workgroup from solitary confinement—fast.

AN EXPERT LINK TO NETWORK SOLUTIONS

GTISI knows exactly how to get a network up and running effectively. Plus, we have all the tools to design and install a system that will dramatically increase workgroup productivity without sacrificing your budget.

GTISI will build your network around a powerful, dependable server. We'll make sure you have reliable workstations, transparent network access and all the speed you need. If your users require cross-platform compatibility, GTISI can help there, too.

With over 36,000 products available from nearly 350 manufacturers,



**Hewlett-Packard LaserJet
4Si MX Printer \$4,245**

HP's 17ppm, 600dpi LaserJet 4Si MX printer takes the complexity out of network printing with built-in support for multi-protocol Ethernet, parallel and LocalTalk ports. (#866-1034)

GTISI can accomplish all of these goals and more. And, with such well-known industry leaders as IBM, 3Com, Hewlett-Packard, and Banyan at work, your network will never have a weak link.

GET A SYSTEM RIGHT FROM THE START

Before recommending any new hardware or software, GTISI engineers will evaluate the current work demands and priorities of your agency.

Then, GTISI will custom-design a system just for you, providing the full range of products you need at a competitive price along with the convenience of GSA Schedule. Plus, GTISI will install your net-

work and trouble-shoot potential problems, helping you avoid costly downtime.

Later, when your computing needs expand beyond the abilities of your present system, GTISI will be just as valuable an ally. GTISI will help you

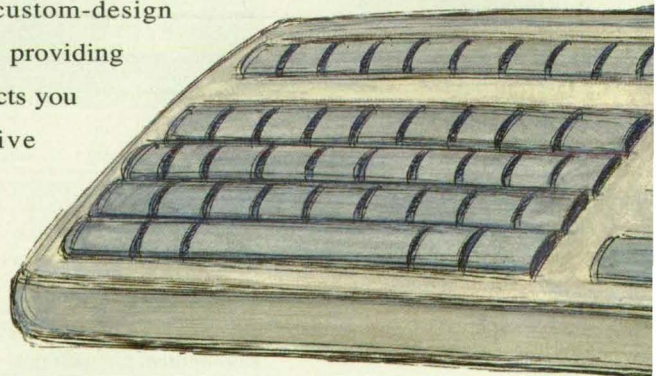

identify ways to improve the productivity of your existing system, while enabling you to plan for the future.

When you are ready to expand, GTSI will provide the guidance you need to make all the right choices.



Banyan ENS for NetWare Server \$2,371

Make Novell NetWare networks easier to use and manage, while enabling NetWare 2.x, 3.x and 4.x to interoperate as one enterprise network. (#513-283-3)

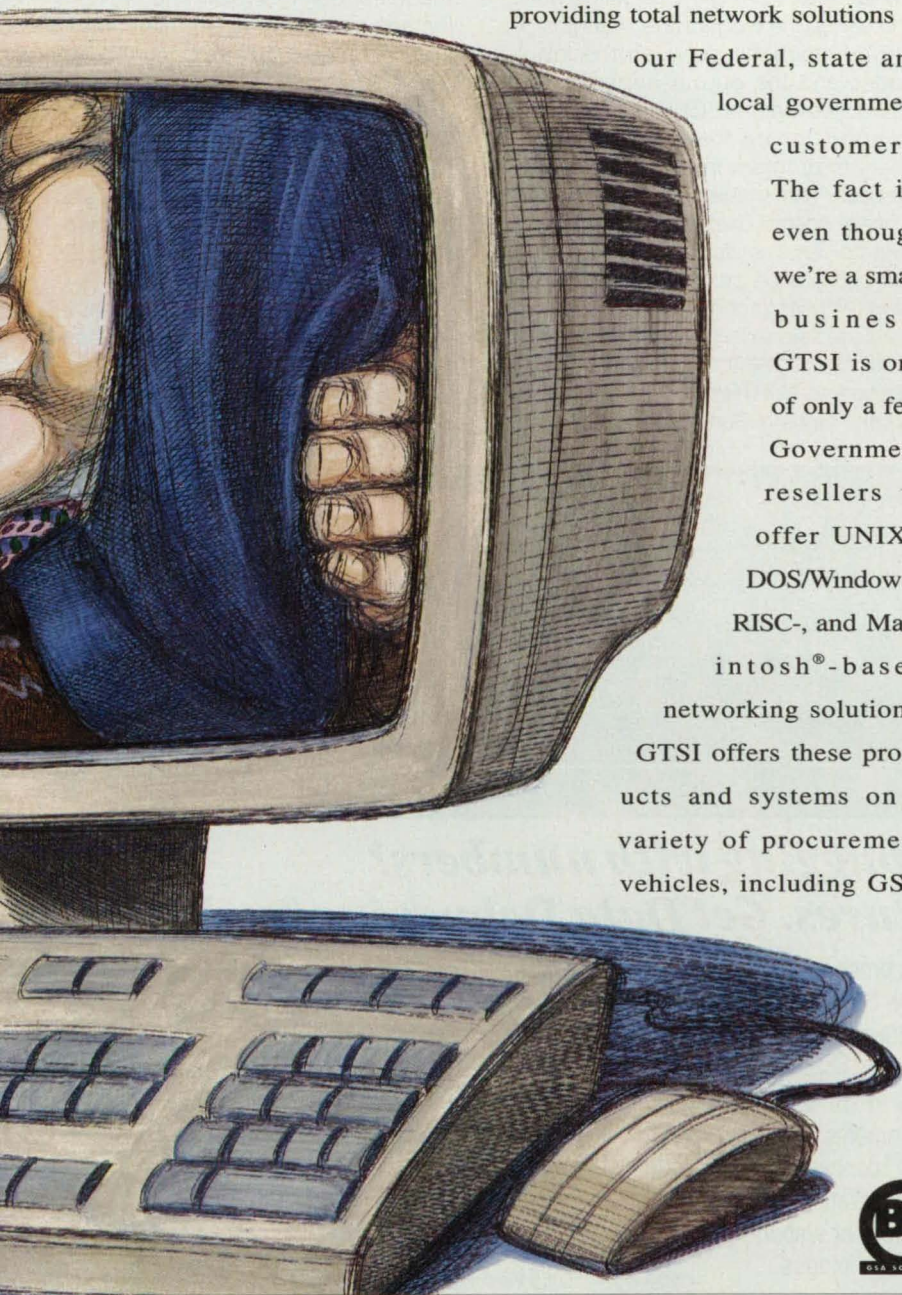

YOU'RE NOT ALONE IN THE WORLD

GTSI is the leading reseller of microcomputer and UNIX workstation products to the Federal



3Com NETBuilder II

*This leading-edge bridge/router offers advanced technology for high-speed, standards-based bridging and routing on FDDI, Ethernet and Token Ring LANS and WANS. (#888-476)**

Government. We're also experts at providing total network solutions to our Federal, state and local government

customers. The fact is, even though we're a small business, GTSI is one of only a few Government resellers to offer UNIX-, DOS/Windows-, RISC-, and Macintosh®-based networking solutions.

GTSI offers these products and systems on a variety of procurement vehicles, including GSA

Schedules A and B/C, NASA SEWP, Navy Companion, and Desktop IV.

Which means whether you are setting up, fixing up, expanding, or upgrading, GTSI will be there with more options, more support and more leading-edge networking products.



IBM Server 295

The 295 offers advanced multiprocessing with dual 50MHz 486DX processors, 64-bit 200MB/second Interprocessor bus and dual MCA buses. 33MHz DX and 50MHz DX configurations available. (#799-1075)

So, for the best advice, products, and prices—just call GTSI—the most vital

connection you'll need when building your communications network. Because, with GTSI, you'll never have to go it alone.

GSA INFORMATION ON-LINE
For on-line access to the most up-to-date GSA pricing and product information, consult the GTSI listing on the Netmark bulletin board at 703-759-6555, or via INTERNET {telnet netmark.com}

703-631-3333 x6464

1-800-999-GTSI x6464

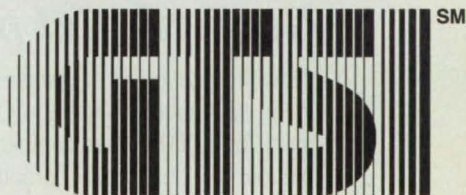

UNITING GOVERNMENT

WITH TECHNOLOGY.



GSA B/C #GS00K93AGS6407

not all cases, these designations are claimed as trademarks, registered trademarks, service marks or registered service marks by their respective owners. © GTSI, 1994—All rights reserved.

For More Information Write In No. 642

input and output data, is included on the distribution medium. The use of a math coprocessor is highly recommended for 286 and 386 series personal computers; otherwise, the source code has to be recompiled by the user when a math coprocessor is not available. The distribu-

tion medium is one 5.25-in. (13.34-cm) 360K diskette in MS-DOS format. The contents of the diskette are compressed by use of the PKWARE archiving software tools. The utility program to unarchive the files, PKUNZIP.EXE, is included. Another machine version of ICAN for

mainframe computers running under VM systems will be available soon.

This program was written by P. L. N. Murthy of **Lewis Research Center** and S. K. Mital of **University of Toledo**. For further information, **write in 90** on the TSP Request Card. LEW-15592

Program Aids Analysis and Optimization of Design

NETS/PROSSS provides for combination of a neural-network application program with an optimization program.

Expensive analysis computer programs are often combined with optimization programs to solve engineering problems. Typically, an optimal solution requires numerous iterations between an analysis program and an optimization program. This often becomes prohibitive because of cost and the amount of computer time needed to converge to an optimal solution. The NETS/PROSSS (NETS Coupled With Programming System for Structural Synthesis) computer program was developed to provide a system for combining NETS (MSC-21588), a neural-network application program developed at NASA's Johnson Space Center, and CONMIN (Constrained Function Mini-

mization, ARC-10836), an optimization program developed at Ames Research Center. After training the neural network and saving the weights (the strengths of the connections between the input nodes and the output nodes in the neural network), NETS can be applied to approximate the results from an analysis program in the optimization process. This enables the user to reach a nearly optimal design. This design can then be used as starting point in a normal optimization process, possibly enabling the user to converge to an optimal solution in significantly fewer iterations.

NETS/PROSSS is written in C language and FORTRAN 77 for Sun computers running SunOS. The required

CONMIN and NETS v3.0 files are included in this package. The documentation for CONMIN and NETS is included with the documentation of NETS/PROSSS. The program requires 342K of random-access memory for execution. The standard distribution medium for this program is a 0.25-in. (6.35-mm) streaming-magnetic-tape cartridge in UNIX tar format. It is also available on a 3.5-in. (8.89-cm) diskette in UNIX tar format. NETS/PROSSS was developed in 1991.

This program was written by James L. Rogers, Jr., of **Langley Research Center** and William J. LaMarsh II of **Unisys Corp.** For further information, **write in 20** on the TSP Request Card. LAR-14818

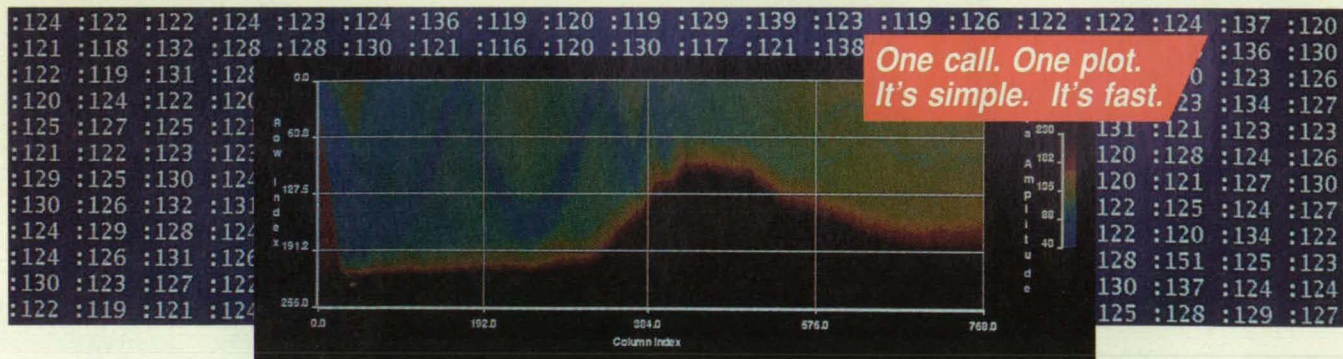

Still debugging with numbers? Get real. Get pictures. Get Data Debugging Tools!

Now the debugging of complex data processing code manipulations is easy. Our new Data Debugging Tool (DDT) instantly makes pictures of your data at any point in your program.

DDT installs in 5 minutes, mastery in 15. It works across networks and multiple environments and runs from any point that has TCP/IP™ connectivity to a SPARC® UNIX® X11 host. And other platforms will be ported soon!* It can be used directly or embedded in libraries and creates X11 graphic images from all data types. DDT works with source level debuggers like dbxtool™ and can be fully interactive

to help you probe your program graphically. It's an excellent tool for debugging data processing code in multi-processing, multi-tasking systems.

So don't insert print statements and thumb through pages of numbers or lines of C code. Don't waste your time writing graphics code. Stop debugging code by the numbers; at only \$499 a copy, just use your eyes.



CST Images

5055 Viewridge Ave., San Diego, CA 92123
619-277-7833 • Fax: 619-576-0859
Email: cstimage@netcom.com

All trademarks and/or registered trademarks are property of their respective companies.
*Contact CST Images for details and availability.

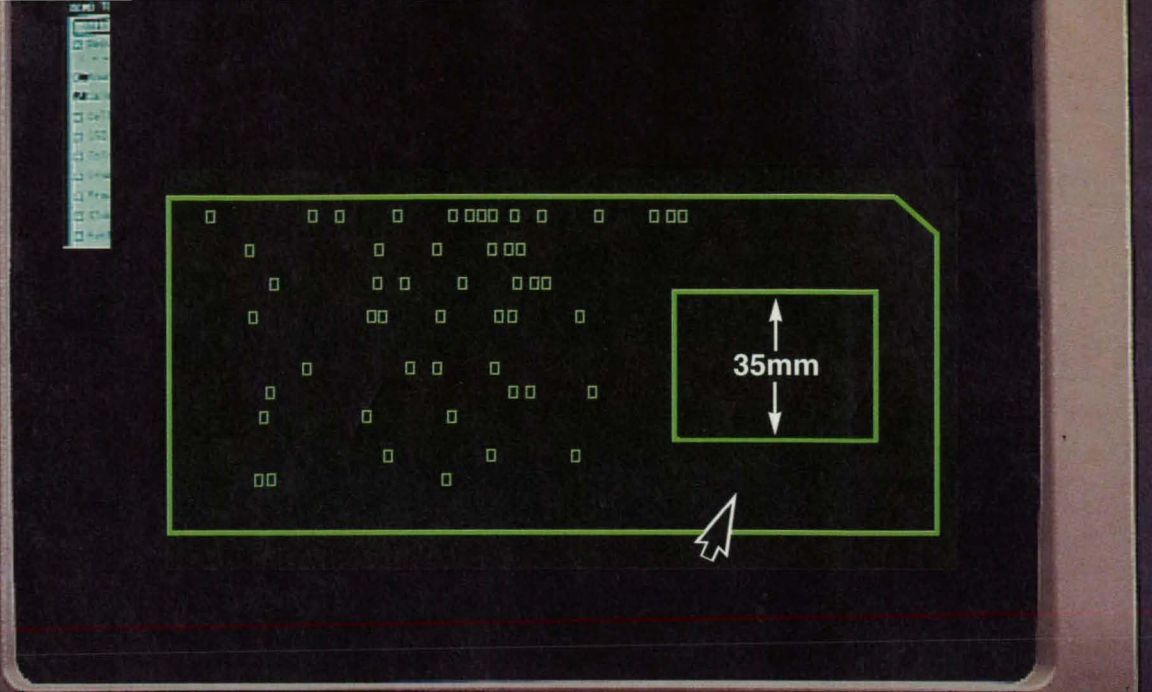

Ask your CAD System to design its own perfect file format and this is what it would create.

3M 35mm Microfilm - the ideal format for storing CAD drawings.

CAD is an immensely powerful tool for the designer and the engineer. But the drawings it originates need to be accessed, read and circulated efficiently and inexpensively. And that means hard copy of some sort.

That's why modern design and engineering companies run both digital and 35mm card-based systems in parallel — and that's why your CAD system, if you asked it, would come up with 3M's universally respected 35mm Microfilm System as the perfect format for archiving and distributing your drawings.

Make no mistake, microfilm has a big part to play in your company's future — especially as most of your existing and potential suppliers are standardized on the system. 3M 35mm Microfilm is proven in practically every design and engineering application. It has undergone a continuous process of refinement to reach its present high standards of accuracy, dependability and sheer ease of use.

There's a wide range of advanced 3M equipment available to bridge the interface between CAD origination and microfilm:

Film plotters that produce high-resolution 35mm Microfilm originals from electronic data at the touch of a button. Multi-function printers that can output A/A4 to E/A0 prints from both microfilm and paper. Sophisticated, user-friendly high speed Reader Printers.



To find out more about how cost-effectively you can integrate the latest generation of 3M Microfilm hardware with your CAD systems, call 3M Engineering Document Systems, 1-800-247-8516.



Electronic Components and Circuits

Optically Addressable, Ferroelectric Memory With NDRO

For readout, memory cells would be addressed via on-chip semiconductor lasers.

NASA's Jet Propulsion Laboratory, Pasadena, California

A proposed thin-film ferroelectric memory device would feature nonvolatile storage, optically addressable, nondestructive readout (NDRO) with fast access, and low vulnerability to damage by ionizing radiation. The contents of present ferroelectric memories are read out by sensing displacement currents during polarization switching, which destroys the contents. Polarization switching also fatigues the ferroelectric material; this effect limits the operating life to about 10^{10} recording-/readout cycles. In the proposed memory device, polarization would still have to be switched during recording and erasure, but not during readout. As a result, readout would not destroy the contents of the memory, and the operating life in specific "read-intensive" applications could be increased up to an estimated 10^{16} cycles.

In principle, both electronic as well as thermal mechanisms could be triggered by photon exposure of ferroelectric thin films. The electronic photogenerated carrier effects may include photovoltaic/photoconductive effects, localized electronic transitions, and/or space charge transients. Thermally triggered mechanisms on the other hand would include pyroelectric effects (associated with temperature change of PZT) and/or piezoelectric effects (due to propagation through PZT of an acoustic deformation wave, initiated by sudden thermal expansion of the platinum top electrode in response to a short energetic photon pulse). Comparison of readout signals from devices with semi-transparent and opaque top electrodes, respectively, suggests that the observed nondestructive readout (NDRO) signal component is primarily due to thermally triggered mechanisms. The readout process would therefore exploit these thermally triggered effects. The ferroelectric memory pixel would be illuminated with a high-speed (≤ 10 ns), intense-heating (≥ 10 μ J) laser pulse at a wavelength substantially less energetic than the bandgap (3.5 eV) of the ferroelectric memory film, to yield a polarization-direction-dependent photoresponse from the memory. Such readout has been observed to repeat over a million times, with no detectable degradation in the photoresponse or the remanent polarization,

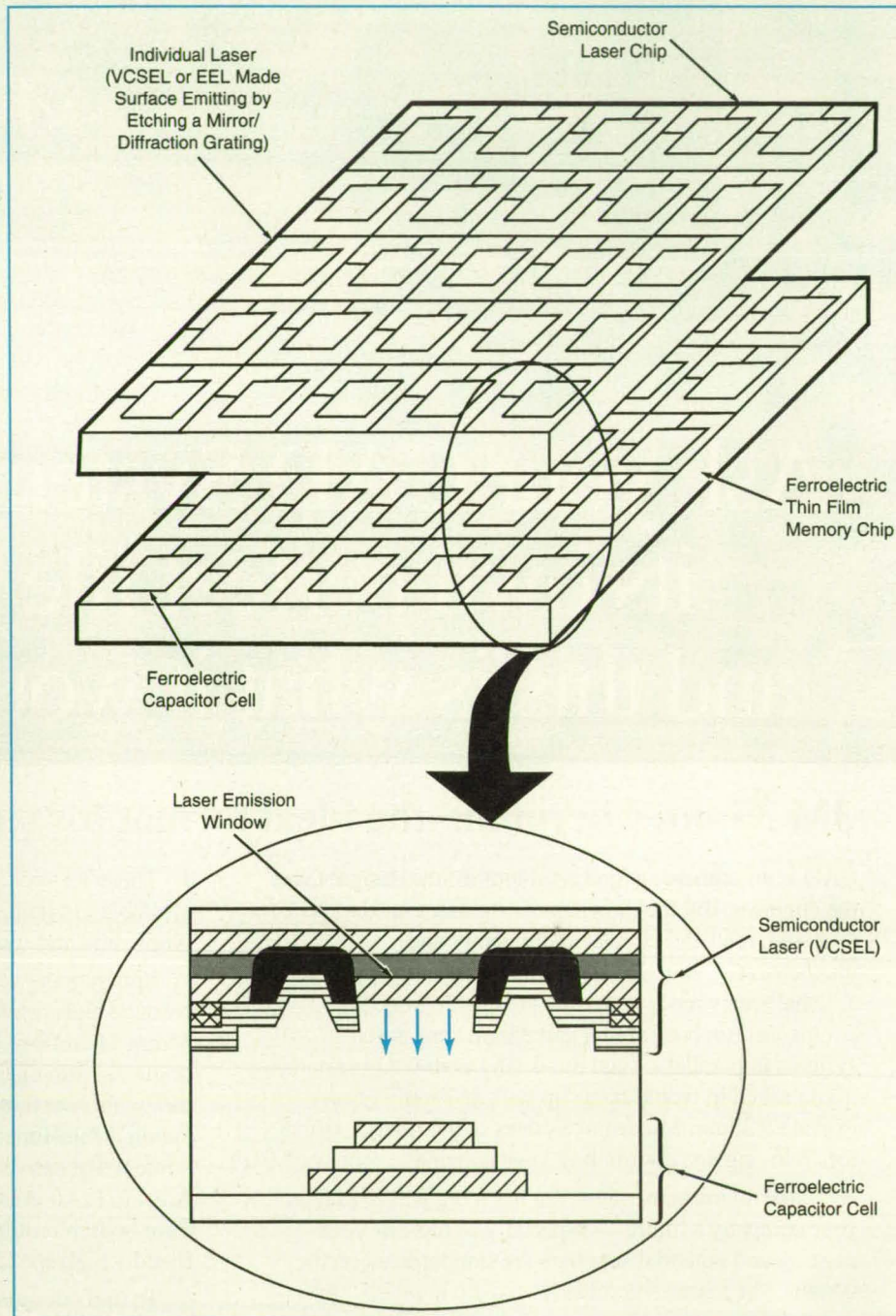

This is a **Conceptual Design** of an optically addressable ferroelectric memory-chip pack.

MAKE THE SPARCSTATION™ YOU ALREADY HAVE AS FAST AS THE SPARCSTATION YOU'D LIKE TO HAVE.



\$1,500

This is all it costs to make your present workstations as fast as the SPARCstation 10.



If you're looking for an economical and efficient way to boost the speed of your present workstations, look no further.

For just \$1,500, WEITEK will get everyone running considerably faster in practically no time at all.

The 80 MHz WEITEK SPARC POWER™ μP CPU upgrade can improve the performance of your SPARCstation 2™ or IPX™ systems to match



that of the SPARCstation 10™ Model 30.

And SPARC POWER μP is easy

enough to install yourself  **SunService**
A Sun Microsystems, Inc. Business
in minutes. It's 100% pin-for-pin and binary-compatible with existing systems and software.

And it's backed by all the benefits of SunService's SunSpectrum™ maintenance.

For more information, call us or return the accompanying reply card via mail or fax.

Join the thousands of SPARCstation 2 and IPX users who already

enjoy the performance of  **WEITEK**
the WEITEK SPARC POWER μP.

TO ORDER YOUR SPARC POWER μP, CALL 1-800-758-7000, Oper.15.

©1994 WEITEK Corporation. All rights reserved. Sun, the Sun logo, Sun Microsystems, SunService, the SunService logo, SunSpectrum, the SunSpectrum logo and IPX are trademarks, registered trademarks or service marks of Sun Microsystems, Inc. All SPARC trademarks, including the SCD Compliant logo, are trademarks or registered trademarks of SPARC International, Inc. SPARCstation is licensed exclusively to Sun Microsystems, Inc. SPARC POWER is used under license by WEITEK Corporation. Products bearing SPARC trademarks are based upon an architecture developed by Sun Microsystems, Inc. All other product or service names mentioned herein are trademarks of their respective companies.

For More Information Write In No. 614

Multiple Pages Intentionally Left
Blank

suggesting its potential as an NDRO of the nonvolatile polarization state in thin-film ferroelectric memories.

Shown in the figure is a conceptual architecture of an optically addressable ferroelectric memory in a dual-chip configuration where a semiconductor laser chip is flip-bonded onto the ferroelectric memory chip. Semiconductor laser arrays utilizing vertical-cavity surface-emitting

laser (VCSEL) technology, or edge-emitting lasers (EEL's) with their output converted to surface emitting by etching a diffraction grating or a 45° mirror could be utilized for this purpose. Such semiconductor lasers delivering power in excess of a watt over an aperture of 5 mm x 5 µm at wavelengths of about 0.8 µm are now available. The architecture could be configured to allow readout of

several bits (say 32 bits, one word at a time) using one such laser, thus keeping the wall-plug power requirement to less than a few watts, as would be desirable for a practical implementation.

This work was done by Sarita Thakoor of Caltech for NASA's Jet Propulsion Laboratory. For further information, write in 40 on the TSP Request Card. NPO-18573

Current-Collecting Grids for AMTEC Electrodes

Peak power was up to 50 percent greater than in equivalent electrodes without grids.

NASA's Jet Propulsion Laboratory, Pasadena, California

Photodeposition or sputter deposition of a refractory metal in a grid pattern on the solid electrolyte of an alkali-metal thermoelectric converter (AMTEC) prior to deposition of an electrode decreases the electronic resistance and increases the current and peak power of the converter significantly. This concept may also be applicable to other devices that include electrically conductive, porous electrodes; for example, solid-state fuel cells and solid-state electrolysis cells.

AMTEC's are capable of near-Carnot efficiencies. An AMTEC operated at the Jet Propulsion Laboratory includes a β"-alumina solid electrolyte ceramic tube, which separates a region that contains liquid sodium at a temperature of 900 to 1,300 K from a low-pressure region that contains a condenser at 400 to 700 K. The electrolyte is a conductor of sodium ions, which are produced by the oxidation of sodium metal at the interface between the liquid sodium and the solid electrolyte. The sodium ions travel through the solid electrolyte to the low-pressure side.

The electrons produced upon oxidation travel through an external circuit and recombine with the sodium ions at a porous, thin-film metal electrode that has been sputter-deposited onto the outside of the electrolyte tube. The sodium atoms then travel through the porous metal electrode, are desorbed as vapor on the low-pressure side, and condense as a liquid film on the condenser. The electrical resistance of the electrode, as measured in terms of sheet resistance and contact resistance, is high because the thickness of the electrode must be restricted to only 1 to 2 µm to maintain the porous character necessary to allow the passage of sodium.

An electrode can be thickened in selected regions (that is, a grid can be deposited) to decrease electrical resistance in those regions while maintaining

porosity in the nonthickened regions. A grid for an AMTEC electrode can be photodeposited from organometallic vapor on a masked solid electrolyte as shown schematically in the figure, or alternatively, on a solid electrolyte on which the light is imaged in the desired pattern. A grid can also be deposited by sputtering a refractory metal like molybdenum or tungsten through a mask. An AMTEC electrode can then be deposited on the grid. Putting the grid under rather than over the electrode protects the grid against flaking or cracking during operation at a temperature ≥ 1,000 K.

Electrodes that include sputter-deposited underlying grids were tested in two configurations, each for more than 700 h. In all measures of performance (series resistance, exchange current, and peak power), electrodes with grids proved to be superior to those without. Mechan-

ical tests of sputter-deposited grids showed them to be insufficiently adherent for long-term AMTEC operation, although subsequent treatments might be developed to improve their mechanical properties. Photodeposited grids were found to be more adherent and not easily lifted or scraped off the ceramic. Microscopic examination has shown photodeposited lines to be continuous and dense. Because of their greater adherence, photodeposited grids are expected to outperform sputter-deposited grids.

This work was done by Margaret A. Ryan, Roger M. Williams, Barbara Jeffries-Nakamura, Mark L. Underwood, Dennis O'Connor, and Stanley J. Kikkert of Caltech for NASA's Jet Propulsion Laboratory. For further information, write in 62 on the TSP Request Card. NPO-18540

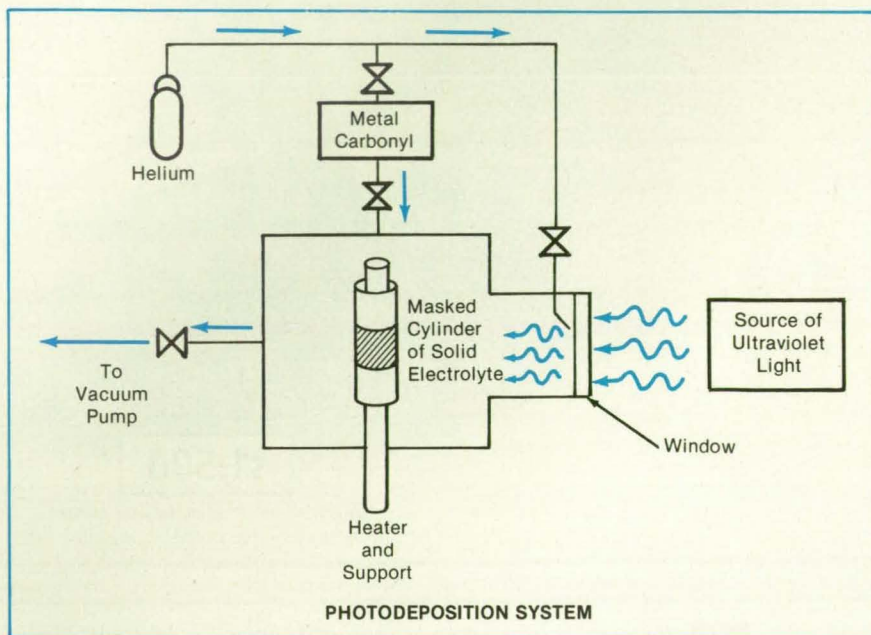

Photolysis of a Metal Carbonyl can be used to deposit a grid of refractory metal on a solid electrolyte before depositing the outer electrode. The grid reduces electronic resistance while maintaining the porosity of the electrode.

NEW FROM ASTRO-MED!

**30 Channels!
Brilliant Monitor!
Huge Memory!
Laser Resolution Chart!**

TRUE FIELD RECORDER®

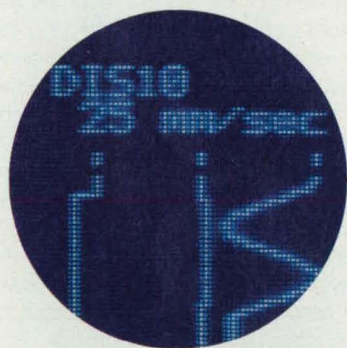

- Bright, High Response Monitor
- 10, 20 or 30 Waveform Channels
- Laser Quality (300 dpi) Chart Resolution
- Huge 512 KSample Memory per Channel for Data Capture and Analysis
- True Portability: Internal Battery and AC
- Record up to 500 V Peak (Isolated) at 25 kHz Response
- Analyze Data with FFT, etc.
- On-Board Floppy Drive for Setup and Memory Transfer
- Wide Format 11-Inch Chart

The all-new Dash 10 lets you receive up to 30 waveform channels (DC to 25 kHz), see the data in real time on the bright high-speed vacuum fluorescent monitor, record with laser quality fidelity, and *at the same time* capture the data for playback and analysis. Now you can do all this on a truly portable package powered by internal battery or AC. The Dash 10 comes with a powerful software package, has a floppy disk for updates and data archiving, plus RS-432, RS-232 and GPIB.

Phone, fax or write for details!

 **Astro-Med, Inc.**

Astro-Med Industrial Park, West Warwick, Rhode Island 02893
Phone: (401) 828-4000 • Toll-Free (800) 343-4039 • Fax: (401) 822-2430
In Canada Telephone 1-800-565-2216

For More Information Write In No. 662



Sales and Service Centers throughout the U.S. and Canada
Astro-Med is system certified to ISO 9001

Double-Square-Loop Triband Frequency-Selective Microwave Reflector

Double-square-loop antenna elements are arrayed on a dielectric panel.

NASA's Jet Propulsion Laboratory, Pasadena, California

Figure 1 illustrates a dichroic microwave reflector that consists of a planar square array of double-square-loop copper elements on a thin sheet of Kapton (or equivalent) polyimide supported by a Kevlar (or equivalent) aromatic polyamid

honeycomb sandwich panel. The array and panel are designed to reflect most of the incident electromagnetic radiation at frequencies between 7.2 and 8.4 GHz (in the X band) and to transmit most of that at 2.3 GHz (in the S band)

and 13.8 GHz (in the K_u band).

The double-square-loop element is selected because its first resonant frequency is very stable with respect to the change of incident angle. The wavelength of this resonant frequency is proportional to the circumference of the outer square loop for the case of a free-standing grid.

The initial dimensions and spacings for the design of this reflector were obtained by computing the effect of the dielectric support on the resonant (reflection) frequency, then modifying the prior dimensions accordingly so as to obtain the desired frequency-selective characteristics in the presence of the honeycomb panel. Measurements of performance and further computations showed the need to modify the dimensions further because the effective dielectric constant of the skin of the honeycomb panel was apparently lower than assumed in the initial computations (2.35 effective, 3.5 assumed). The

Elmo—the KING of Micro Picture Quality



Any broadcast pro will tell you Elmo micro cameras deliver the best picture quality. That's why Elmo micro cameras are used in network television events.

Now, we've made them even better! Elmo micros are also extensively used in medical equipment, aircraft, high tech surveillance, covert operations and many more applications.

1. Model MN-401X (color)

Features electronic shutter speed up to 1/50,000th second, over 460 lines (H) resolution, 5 lux illumination for excellent color rendition, the first micro with 3 video outputs (analog RGB, S-VHS, NTSC) and accepts macro lenses that can enlarge up to 178 times.

2. ME-401E (B&W)

A 570 lines (H) high resolution model, 1.8 lux, both electronic and manual shutter speed control and random trigger for machine vision, quality control and other applications.

Elmo also offers another very special ingredient, the best customer service and support. You can immediately reach a highly qualified person to quickly answer your technical or service questions.

For more information, call Vince Giovinco toll free at 1-800-947-ELMO or write:



ELMO Mfg. Corp.

70 New Hyde Park Road, New Hyde Park, NY 11040 Phone: 1-800-947-ELMO
44 West Drive, Brampton, Ontario, Canada L6T 3T6 Phone: 416-453-7880

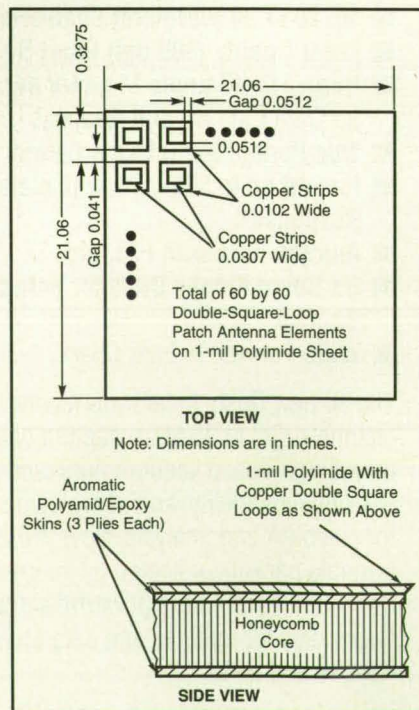

Figure 1. This Frequency-Selective Microwave Reflector is highly reflective at 8.4 GHz (X band) and highly transmissive at 2.3 GHz (S band) and 13.8 GHz (Ku band).

SOLID STATE RELAYS IS OUR BUSINESS

Solid Soldiers With A Military History

QPL and DRAWING SSRs

In addition to years of uninterrupted solid state relay experience in military applications Teledyne Electronic Technologies also has the most comprehensive list of QPL and DESC Drawing solid state relays to MIL-R-28750 available. Our first QPL solid state relay product was available in 1982 and our most recent DESC Drawing product is our popular CD Series which incorporates short circuit protection and control status. Your SSR military applications ranging from low level to 25 Arms are sure to be covered by one of the 7 products on the QPL or the 28 other products appearing on DESC drawings.

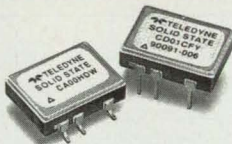

NEW TECHNOLOGIES — NEW PRODUCTS

Our technology supports our customer's requirements from the F-111 to the 777 and from submarines to spacecrafts. Our broad product line includes optically isolated and transformer isolated solid state relays capable of controlling AC, Bi-directional and DC loads up to 25 amps. New products range from 1 to 25 amps at 250 Vac and include features such as thermal protection and trip status in thermally efficient packages. If packaging is critical to your design, we offer surface mount leads, THT, leadless chip carriers as well as solder hook terminals.

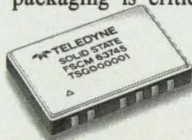

SOLID STATE POWER CONTROLLERS

Teledyne Electronic Technologies offers both 28 and 270 Vdc power controllers. Teledyne

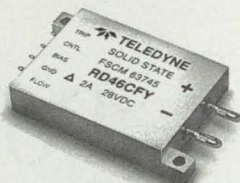

was the first to manufacture standard 270 Vdc power controllers incorporating modified Pt wire protection. Add to that standard features such as LSTTL control, optical isolation, and Trip and Flow status and you have a powerful, patented, and proven pair of solid state power controllers from Teledyne Electronic Technologies ready for your application.

If your requirements calls out best commercial practice, we have been manufacturing high quality commercial/industrial solid state relays since 1969. Call or write for commercial/industrial performance information.

Or if you want more specific data about our solid state relays with a military history JUST CALL 1-800-568-8711, and we will send you our new MIL product data book.

**TELEDYNE
ELECTRONIC TECHNOLOGIES**

TELEDYNE SOLID STATE

SOLID STATE RELAYS

Home Office, 12964 Panama Street, Los Angeles, CA 90066 • Telephone: 310-577-3825 • FAX 310-574-2015
OVERSEAS: GERMANY: (0611) 7636-143; ENGLAND: (081) 571-9596; BELGIUM: (02) 673-99-88; JAPAN: (03) 3797-6956.

For More Information Write In No. 664

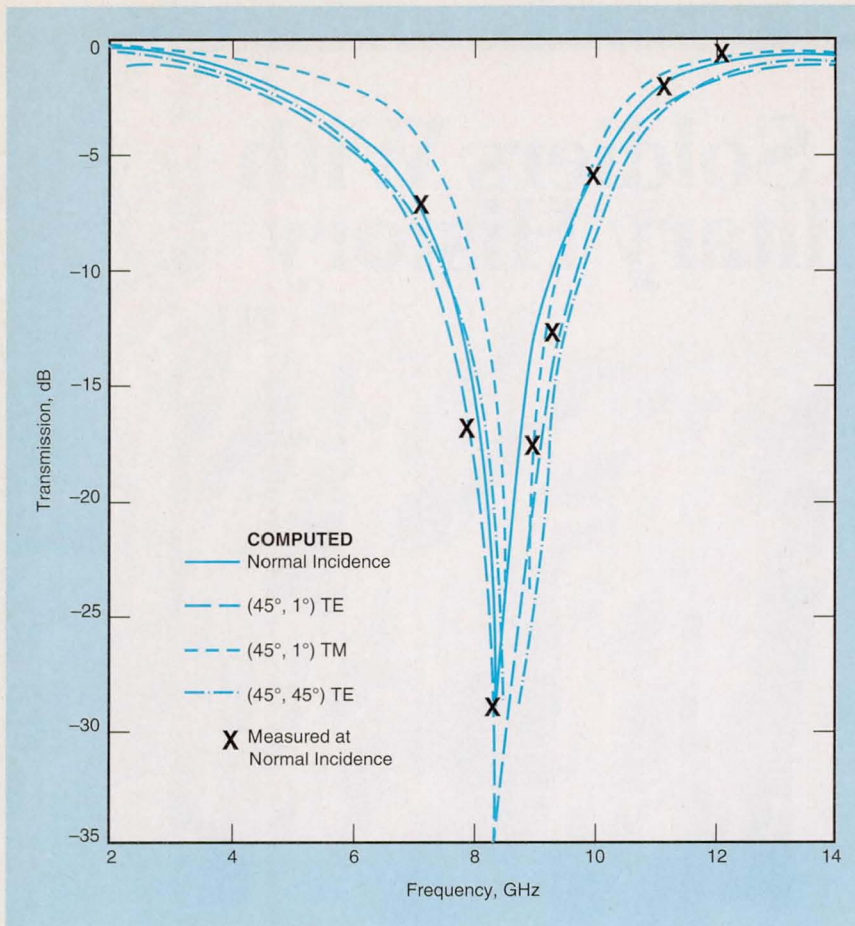

dimensions shown in the figure are those of this most recent design iteration. Figure 2 illustrates the computed transmission performance for several angles of incidence in transverse magnetic (TM) and transverse electric (TE) polarizations, as well as the measured performance at normal incidence.

This work was done by Te-Kao Wu of Caltech for NASA's Jet Propulsion Laboratory. For further information, write in 88 on the TSP Request Card. NPO-18676

Figure 2. The Measured Performance at Normal Incidence agrees well with the computed performance at normal incidence. The computed performance at other angles of incidence is also shown to illustrate the wide angular range within which the desired frequency-selective characteristics can be obtained.

Power.

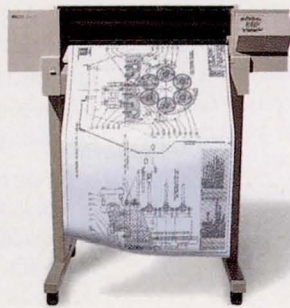

5 minute plots

The new HP DesignJet 200 monochrome inkjet plotter makes fast plotting affordable for everyone.

It's true. For about the price of the average pen plotter, the HP DesignJet 200 gives you crisp, 300-dpi, D-size plots in under five minutes.

Of course, HP's proven inkjet technology means more than just fast plotting. It means no more pen-related problems. No more skipped lines. No more pen clogging. And our smooth, quiet writing

Triband Circular-Loop Frequency-Selective Microwave Reflector

Circular-loop antenna elements are embedded in a dielectric laminate.

NASA's Jet Propulsion Laboratory, Pasadena, California

Figure 1 illustrates a triband frequency-selective microwave reflector that consists of a planar square array of circular-loop conductive antenna elements sandwiched between dielectric sheets. The array reflects strongly at a frequency of about 8.4 GHz and transmits with little attenuation at frequencies of 2.3 and 13.8 GHz, at all angles of incidence within about 45° of normal.

This triband frequency-selective reflector is improved from the previous published design, "Triband FSS with Circular Ring Elements," *Int. IEEE AP-S Symposium Digest*, June 1991, pp. 204-207. Like the others, this dichroic reflector is designed for use in multiplexing signals at several frequencies in a microwave antenna system.

The outstanding feature of the present triband frequency-selective reflector is the simplicity of its design and fabrication. The previously reported design consists of two planar arrays of circular ring elements supported by non-space-

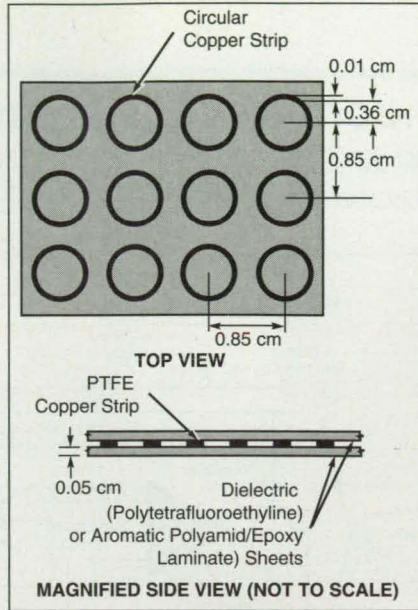

qualified Duroid 6010.5 panels and separated by a foam spacer; the loop elements and arrays must be aligned with

Figure 1. This Dichroic Microwave Reflector has the desired frequency-selective reflection/transmission characteristics over a range of angles of incidence, and can be fabricated rela-

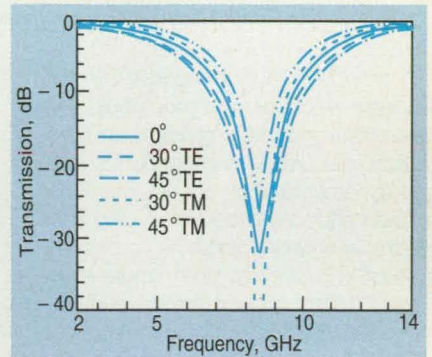
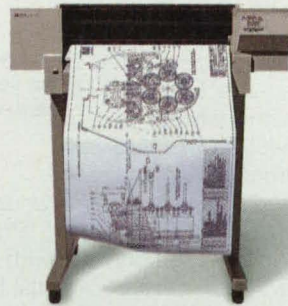

Figure 2. The Transmission as a Function of Frequency was calculated at normal incidence and in transverse magnetic (TM) and transverse electric (TE) polarizations at various other angles of incidence.

To the people.



\$3,695*

system makes the HP DesignJet 200 ideal for any office environment. And with the addition of legs, the DesignJet 200 converts from a desktop to a free-standing plotter.

So get the plotter that saves you as much time as it does money. Call 1-800-851-1170, Ext. 7720 for the location of your local HP demo dealer.†

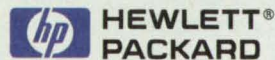

©1993 Hewlett-Packard Company *E-size model priced at just \$4,695. Suggested U.S. list prices. Price does not include optional legs and bin. Plot images courtesy of Autodesk, Inc. †In Canada, call 1-800-387-3867, Ext. 7720. PE12316

each other. The high dielectric constant ($\epsilon = 11$) Duroid 6010.5 panels were required to avoid the forming of grating lobes at the Ku-band for the old design. However, the new design avoids the grating lobe by loading both sides of the grid

array with lower dielectric constant ($\epsilon = 3.5$) and space-qualified Kevlar/epoxy laminates. Figure 2 shows the computed performance of the present reflector in two polarizations, at various angles of incidence.

This work was done by Te-Kao Wu of Caltech for NASA's Jet Propulsion Laboratory. For further information, write in 32 on the TSP Request Card. NPO-18714

Nonvolatile GaAs Random-Access Memory

Bits would be stored magnetically and read out with Hall-effect sensors.

NASA's Jet Propulsion Laboratory, Pasadena, California

A proposed random-access integrated-circuit electronic memory would offer nonvolatile magnetic storage. In comparison with present semiconductor static and dynamic random-access memories it would offer advantages, including short reading and writing times and a high degree of immunity to both single-event upsets (temporary bit errors) and permanent damage by ionizing radiation.

Each datum bit, represented by the state of magnetization of the magnetic storage material, would be sensed by a Hall-effect magnetic-field sensor operating in conjunction with an associated transistor and other read-out circuitry. Both the magnetic-field sensors and the transistors would be made of high-charge-carrier-mobility and radiation-tolerant gallium arsenide. The high mobilities (in comparison with those in silicon-based devices) should result in writing and reading times ≤ 0.1 ns. The use of the same basic material for both transistors and sensors would simplify the fabrication process, with consequent benefits in increased yield and reduced cost.

The figure shows a four-cell version to illustrate the principal of operation. The write-select or read-select transistor would switch on the writing or reading current, respectively. During writing, the current from the writing source would be directed to a conductor that passes over the magnetic storage element in the selected memory cell, by turning on row- and column-selecting transistors for the row and column that intersect at that cell. The magnetic field generated by this current would magnetize the storage material, thereby recording a datum. During readout, reading current would be applied in series to all of the Hall-effect sensors in the column that contains the selected cell, while a row-selecting readout transistors would be turned on to pass the output of the sensing amplifier, to which all the Hall-effect sensors in the selected row

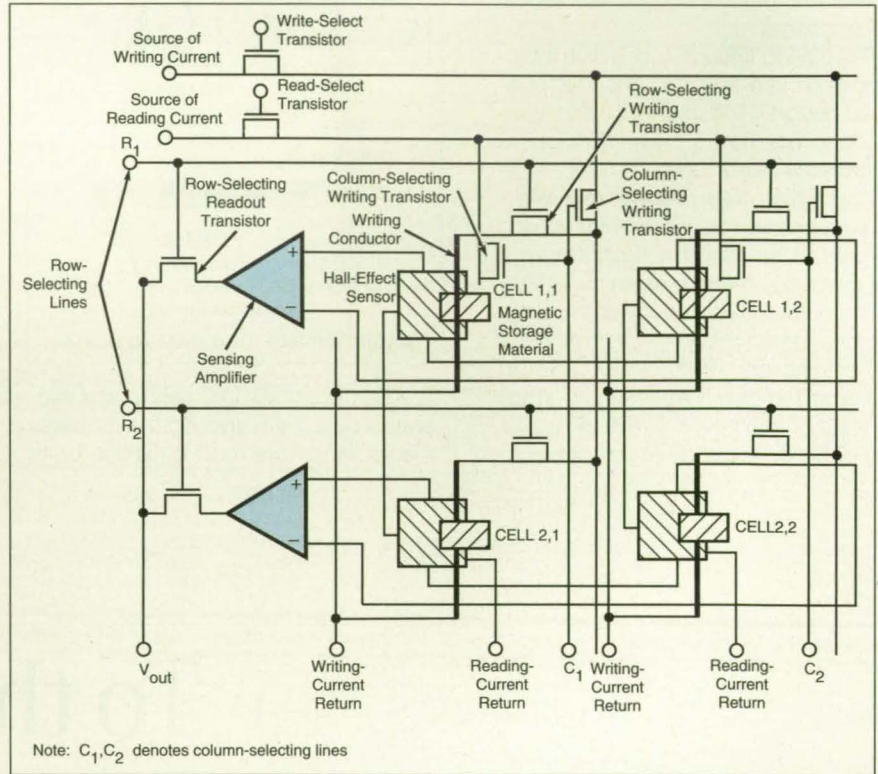

The Nonvolatile Memory would contain magnetic storage elements and Hall-effect read-out sensors. A practical version would consist of many more than the four cells shown here: versions as large as megabits on standard-size integrated-circuit chips are envisioned.

would be connected in series.

Preliminary calculations show that with extremely conservative design rules, one cell of the memory would occupy a square of $30 \lambda \times 30 \lambda$, where λ is the minimum circuit-feature size characteristic of the fabrication process. If $\lambda = 1 \mu\text{m}$, then such a design could fit a 64-kb memory onto an integrated-circuit chip of standard size. By reducing λ and optimizing the design, it should be possible to raise the capacity of a standard-size memory chip to 1 Mb or more.

This work was done by Romney R. Katti, Henry L. Stadler, and Jiin-Chuan Wu of Caltech for NASA's Jet Pro-

pulsion Laboratory. For further information, write in 82 on the TSP Request Card.

In accordance with Public Law 96-517, the contractor has elected to retain title to this invention. Inquiries concerning rights for its commercial use should be addressed to

William T. Callaghan, Manager
Technology Commercialization
Jet Propulsion Laboratory
(M/S 301-350)
4800 Oak Grove Drive
Pasadena, CA 91109

Refer to NPO-18529, volume and number of this NASA Tech Briefs issue, and the page number.



The VCCD512 High Frame Rate Camera consists of a camera head containing a 16-port split frame transfer 512X512

High Frame Rate Camera for spectral response from 350 to 1000 nm

CCD imager, an A/D Processor and a power supply. It operates from up to 200 frames per second at full resolution and up to 400 frames per second with 4 pixel binning. Optional 800 fps also available. The standard camera head provides 16 parallel analog video output channels. The A/D processor provides 16 parallel digital channels at 12 bit resolution per channel. The integration time is commandable with a fixed pixel readout rate. Four pixel binning capability is standard with other binning systems optionally available. The 512X512 array is back illuminated for a 100% optical fill factor. This approach provides high quantum efficiency with low aliasing and smooth spectral response from 350 to 1000nm.

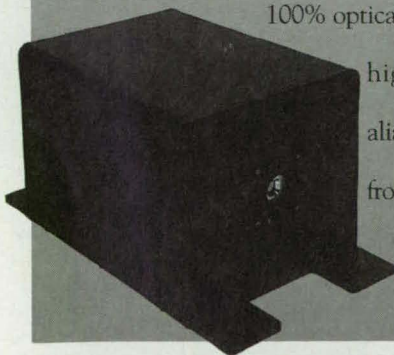

Sarnoff

Contact Information:

David Sarnoff Research Center CN 5300 • 201 Washington Road • Princeton, NJ 08540-5300 • 609/734/2553 voice • 609/734/2443 fax

For More Information Write In No. 538



Evaluating Multi-Input/Multi-Output Digital Control Systems

Controller-performance-evaluation methodology was validated on an aeroelastic wind-tunnel model.

Langley Research Center, Hampton, Virginia

Active controls are becoming an increasingly important means to enhance the performances of aircraft. Because the process of designing multi-input/multi-output (MIMO) digital control laws involves the use of relatively untested theoretical methods, it is necessary to validate the design methodology through experimentation. Accordingly, a controller-performance-evaluation (CPE) methodology for MIMO digital control systems was developed. The CPE procedures identify potentially destabilizing controllers and confirm the satisfactory performance of stabilizing ones.

A simplified block diagram of the basic closed-loop control problem is shown in the top part of Figure 1. The plant to be controlled is represented mathematically by a frequency-domain transfer matrix, G , with outputs y and inputs e . The controller is represented mathematically by a transfer matrix, H , with inputs y and outputs x . External excitation u is used to excite the system in a specified fashion. This excitation is used to derive transfer functions between outputs and inputs in either open- or closed-loop versions of the system. In the open-loop version of the system, the control-law outputs are not fed back into the system; i.e., the switch depicted in the lower part of Figure 1 is open.

The CPE computations involve the generation of frequency-domain transfer functions of plant outputs, y , and control-law commands, x , that are generated in response to an excitation, u . Fast-Fourier-transform (FFT) techniques can be used to calculate these functions. The controller, H , and the return-difference matrices, $I + GH$ and $I + HG$, and their singular values are then calculated by use of matrix operations. Figure 2 outlines the CPE procedures.

This methodology was used and validated during the wind-tunnel testing of an aeroelastic model equipped with a digital flutter-suppression controller. The methodology is generic and can be used in many types of multi-loop digital-controller applications, including digital flight-control systems, digitally controlled spacecraft structures, and actively con-

trolled wind-tunnel models. It may also be applicable to other complex, highly dynamic digital controllers, such as those in high-performance robot systems.

This work was done by Anthony S. Pototzky of Lockheed Engineering & Sciences Co. and Carol D. Wieseman, Sherwood T. Hoadley, and Vivek Mukhopadhyay of Langley Research Center. For further information, write in 91 on the TSP Request Card. LAR-14635

Figure 1. Both Open- and Closed-Loop Systems are accommodated in the CPE methodology.

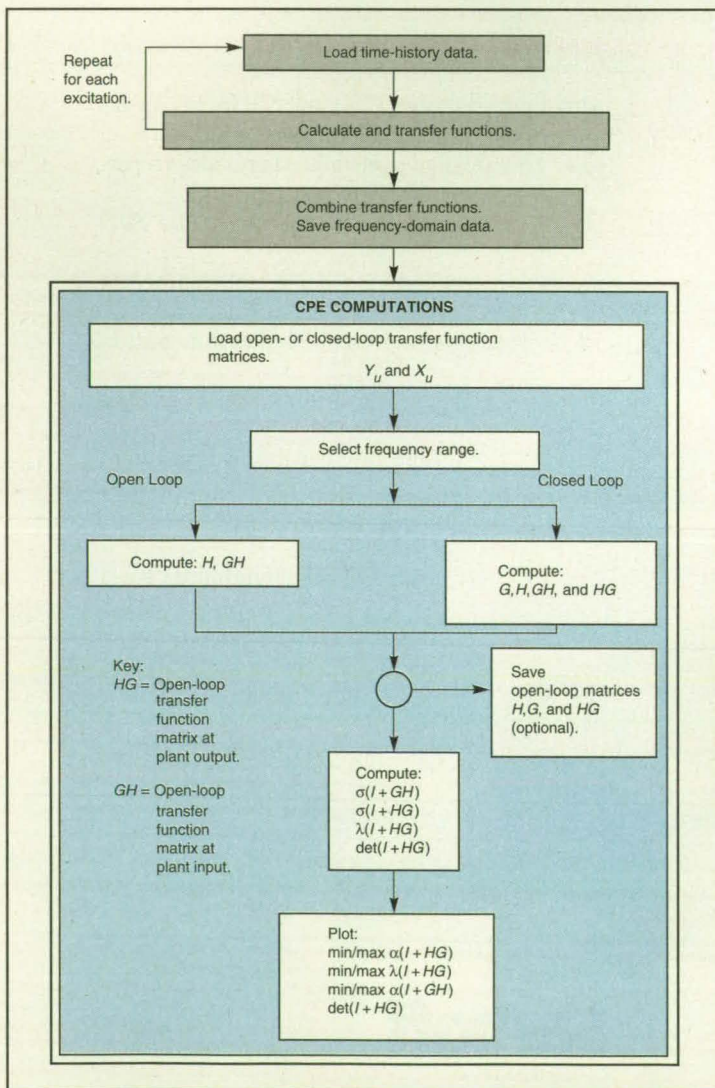
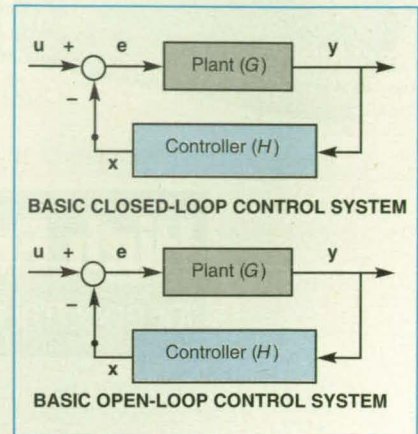

Figure 2. This Flow Chart illustrates the application of the CPE methodology to a multi-variable digital control system.



Loral Makes a Replacement for the Versatec V80™ That Uses No Liquid Chemicals.

NEW FROM LORAL

The Loral 9080 is a plug-compatible, exact replacement for the Versatec V80. It gives you everything you want and need in a high speed printer/plotter. With the 9080, you get clean, crisp copies every time using an environmentally-friendly dry process. No chemical inks or toners.

EASY TO INSTALL AND USE

Installation couldn't be easier. Simply unplug the V80 and plug in the 9080. The 9080 is designed to work with all existing Versatec V80 software and hardware interfaces.

Powered by the Astro-Med Print Engine, the 9080 prints high-resolution documents at 200 dpi on fanfold or roll paper. Print Speed is 15 pages per minute. Plot speed is one inch per second. Price is under \$12,000.

To order the Model 9080, call (813) 378-6984. For more information write: Loral Data Systems, P.O. Box 3041 M/S41, Sarasota, FL 34230 or call our hotline (813) 377-5590.

LORAL
Data Systems

Versatec and V80 are trademarks of Versatec, Inc.

For More Information Write In No. 530

Stationary Camera Aims and Zooms Electronically

Microprocessors select, correct, and orient portions of a hemispherical field of view.

Langley Research Center, Hampton, Virginia

A video camera pans, tilts, zooms, and provides rotations of images of objects of its field of view, all without

moving parts. The camera can be used for surveillance in areas where movement of the camera would be con-

spicuous or constrained by obstructions. It can also be used for closeup tracking of multiple objects in the field

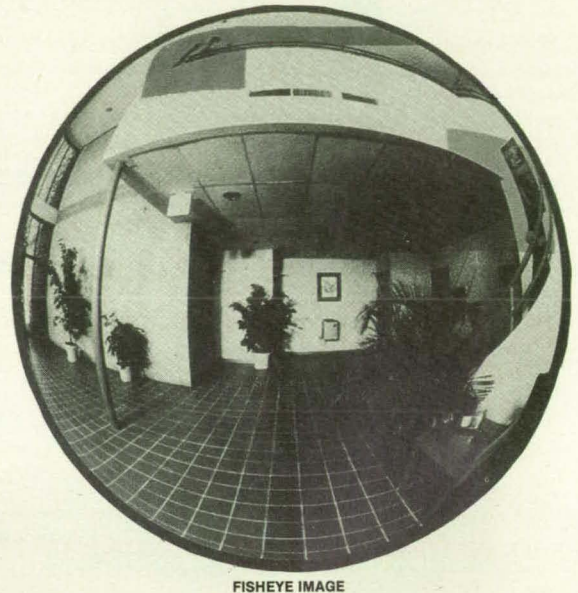
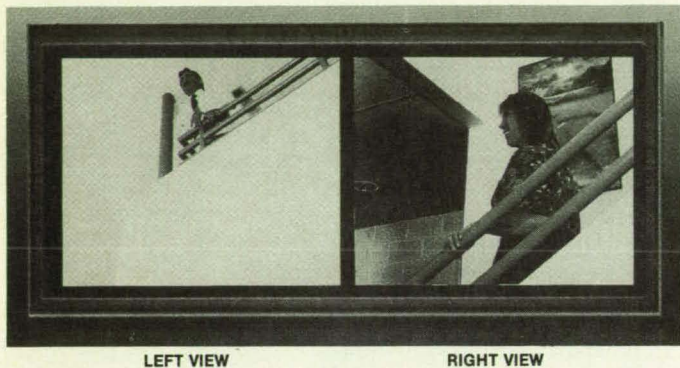

Figure 1. The Full Hemispherical Fisheye Image, with barrel distortion, is separated into smaller, distortion-free images. Two images can be displayed simultaneously, side by side.

COMPUTER TIMING MODULES

Microsecond resolution data time tagging, event time capture, and programmable pulse/interrupt strobes.

Featuring

- Real Time Clocks
- GPS Satellite Receivers
- IRIG Time Code Translation/Generation

Platforms

- PC
- VME
- VXI
- STD
- SBX
- Qbus

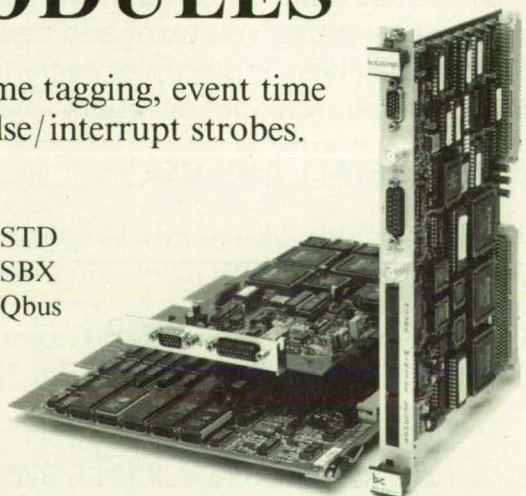

bc **BANCOMM**
Division of Datum Inc.
1-800-348-0648

MASTERS OF TIME
since 1972

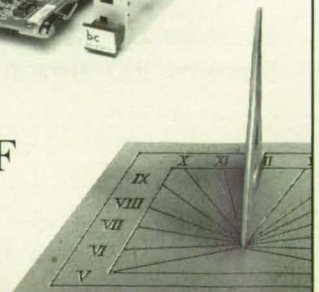

IF FANCY GRAPHICS ARE YOUR TOP PRIORITY, YOU MAY BE MISSING THE BIG PICTURE.



NIGHT HAWK® COMPUTERS FEATURE ADVANCED GRAPHIC CAPABILITIES PLUS REAL-TIME PROCESSING POWER

Fancy graphics and impressive CPU speeds are not enough to ensure the success of your time-critical applications. To consistently meet computational deadlines and achieve appropriate responses to external events, you need the guaranteed determinism and performance of a Night Hawk computer.



Night Hawks give you the big picture. Designed for efficient development and streamlined real-time execution, they deliver a 16 μ sec interrupt response and 35 μ sec context switching. Our family of real-time, multiprocessing computers is complemented by unrivaled real-time development tools and a robust Ada environment.

Night Hawks deliver fancy graphics, too. They support economical, VME-based graphics solutions, including the X-CELL™ board from International Software Corporation which exceeds one million 2-D vectors per second, as well as high-performance products for advanced 3-D graphics and modeling applications, such as the Freedom Series® from Evans & Sutherland. In the HERITAGE™ series, Night Hawks are integrated into Evans & Sutherland's state-of-the-art ESIG-2000 and -3000 image generators to provide unsurpassed out-the-window visuals and computing power in a single cabinet.

Built around industrial and international

open system standards with support for real-time and multilevel secure UNIX® operating systems, Night Hawk computers are readily integrated into a multi-vendor, multi-component environment. Modular and scalable, they are easily enhanced to keep pace with your changing needs. Our unique Pre-Planned Product Improvement philosophy preserves your hardware and software investment, making technology refreshment as painless as a board exchange.

If you have already developed software for another system, Harris migration assistance and porting expertise will assure an easy and economical transition to a Night Hawk real-time multiprocessing system.

Today, the Harris name represents over a quarter century of experience in real-time computing, a global sales and support network, and a full complement of products and services designed to meet and exceed your needs.

NASA and other federal agencies can get the big picture fast. Night Hawk real-time computers and an extensive array of related equipment and services are available from Harris — the only approved real-time systems vendor — through the Scientific Engineering Workstation Procurement (SEWP) Contract.

For more information, call the Harris SEWP Program Office at 1.305.973.5041.



HARRIS
COMPUTER SYSTEMS

HARRIS CORPORATION • COMPUTER SYSTEMS DIVISION • 2101 WEST CYPRESS CREEK ROAD • FORT LAUDERDALE • FL • 33309 • U.S.A.

NIGHT HAWK IS A REGISTERED TRADEMARK OF HARRIS CORPORATION. X-CELL IS A TRADEMARK OF INTERNATIONAL SOFTWARE CORPORATION. FREEDOM SERIES AND ESIG ARE REGISTERED TRADEMARKS OF EVANS & SUTHERLAND COMPUTER CORPORATION. ESIG-2000 HERITAGE AND ESIG-3000 HERITAGE ARE TRADEMARKS OF EVANS & SUTHERLAND COMPUTER CORPORATION AND HARRIS CORPORATION. UNIX IS A REGISTERED TRADEMARK OF UNIX SYSTEMS LABORATORIES, INC. IN THE U.S. AND OTHER COUNTRIES. © 12/93 HARRIS CORPORATION NHRT294/03/AP

For More Information Write In No. 656

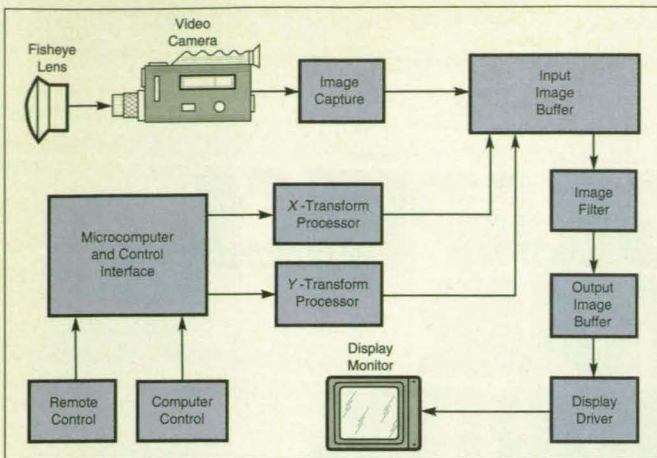

Figure 2. The **Microcontroller Does Preliminary Calculations** for transform processors in addition to providing an interface for remote control and computer control signals. The transform processors correct distortion and orient the selected portion of the image as if the camera pointed straight toward it, regardless of the position of that portion in the view of the fish-eye lens.

of view or to break an image into sectors for simultaneous viewing, thereby replacing several cameras.

The camera includes a fisheye lens, which creates a circular image of a hemispherical field of view (see Figure 1) on a charge-coupled device (CCD). The image data are stored briefly in an input image buffer for processing (see Figure 2). High-speed x- and y-transform digital processors correct the barrel distortion introduced by the fisheye lens and thereby enable the reconstruction of undistorted views of portions of the scene, as directed by a microprocessor. A human operator programs the microprocessor through a control panel, choosing the magnification, viewing direction, and offset of the selected portion of the image.

The associated electronic circuitry includes a 32-bit microprocessor with 80-bit floating-point arithmetic support for parametric calculations. It performs control interface functions and calculates the coefficients for the x- and y-transform processors, which are independent arithmetic devices. The prototype system produces as many as 22 frames per second. An improved version is expected to produce 30 frames per second.

This work was done by Steven D. Zimmermann of TeleRobotics International, Inc., for Langley Research Center. No further information is available.

In accordance with Public Law 96-517, the contractor has elected to retain title to this invention. Inquiries concerning rights for its commercial use should be addressed to

*Dr. H. Lee Martin, President
TeleRobotics International, Inc.
7325 Oak Ridge Highway,
Suite 104
Knoxville, TN 37931*

Refer to LAR-14764, volume and number of this NASA Tech Briefs issue, and the page number.

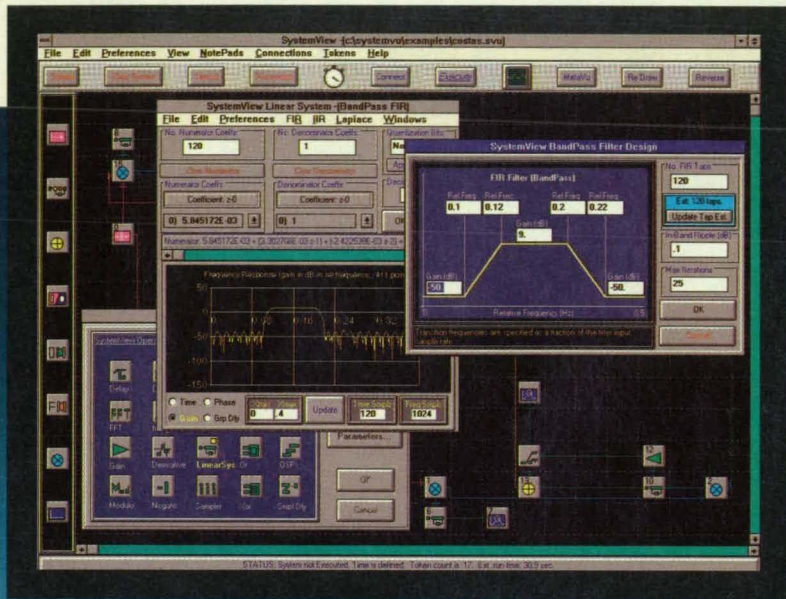

Workstation power on your PC. Performs in the familiar Microsoft Windows environment.

SystemView

BY ELANIX

**PERSONAL DYNAMIC SYSTEM SIMULATOR:
Powerful. Intuitive. And instantly productive.**

Introducing workstation-level design, simulation and analysis tools for your PC. Intuitive, powerful and dynamic, SystemView thinks like you do. And there's no code to learn! It provides application development tools for DSPs, signal processing, communication and control system applications, plus mathematical system modeling. For more information or to place an order, call ELANIX now.

FREE
SystemView
evaluation
disk.
Call for
yours today.

\$985
Quantity discounts available

1-800-535-2649

5655 Lindero Canyon Rd., Suite 304 • Westlake Village, CA 91362 • (818) 597-1414 • Fax (818) 597-1427
© ELANIX, Inc. 1993. SystemView by ELANIX is a registered trademark of ELANIX, Inc.

FREE Advertisement in NASA'S Report SPINOFF

If you have successfully transferred/applied NASA technology to the development of a commercially available product/service, we can present your story in a future issue of the annual report SPINOFF. For more information **write in #475**

Optical Pattern Recognition With Self-Amplification

The intensity of the recognition signal is orders of magnitude greater than in other optical correlators.

NASA's Jet Propulsion Laboratory, Pasadena, California

An experimental optical pattern-recognition apparatus features self-amplification of the output light beam in a photorefractive crystal. As in other optical correlators, the intensity of the output light beam is a measure of the correlation between an input image (which one seeks to recognize) and a prerecorded reference image. In this apparatus, the intensity of the pattern recognition signal is about 10^9 times as strong as in other optical correlators that lack the self-amplification feature.

This apparatus can be regarded as a real-time or quasi-real-time optical pattern recognizer with memory and reprogrammability. The reference image is recorded immediately prior to addressing (readout). During recording, a polarized, collimated laser beam is split into an object and a reference beam. The object beam passes through a transparency of the reference image and is then focused by a Fourier-transform lens onto the facing surface of the photorefractive crystal. The reference beam is directed toward the photorefractive crystal at an angle with the object beam. The two beams interfere in the crystal, forming a volume hologram via the photorefractive effect.

During addressing, the reference beam is blocked, and the transparency of the reference image is replaced by a transparency of the input image that one seeks to recognize using the reference image. The output beam is produced by diffraction of the object beam (which now bears the input image) in the volume hologram. The output beam travels along the path of the reference beam that was used in recording the reference image. A lens that has been aligned previously with the reference beam focuses the output beam onto a photodetector, the electrical output of which is taken as the pattern recognition signal.

As used here "self-amplification" denotes a complex of effects that result from the particular optical configuration and the photorefractive effect. Among other things, it involves coupling between the reference or diffracted plane wave and the spherical wave produced by the Fourier-transform lens. One of the benefits of this self-amplification is that the pattern recognition signal contains less noise than does a correlation signal in a conventional optical correlator that is electronically post-amplified to the same level.

The same photorefractive effect that is exploited to record the image also causes the image to fade during addressing.

rate of fading increases with the intensity of the addressing beam; characteristic times for fading range from seconds to minutes, depending on the level of illumination. This effect can be exploited to erase the reference image, possibly in preparation for recording a new one.

In the self-amplified optical pattern-

recognition system, three important functions — i.e., recognition, noise filtering, and amplification — can be accomplished all at once in a tiny crystal. Though the architecture and procedure are very similar to those of the well-known Vander Lugt matched-filter correlator because of the unique characteristics of the non-

3-D RAPID PROTOTYPING • REVERSE ENGINEERING • MODELING • ANIMATION

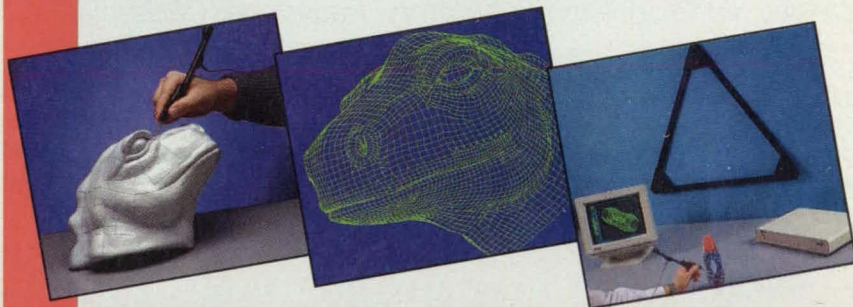

WITH

SAC's New GP-12 3-D DIGITIZER

The most versatile, easy-to-use 3-D digitizer available. Capture 3-D data in real time from any solid object within an active volume of up to 8 ft. x 8 ft. x 8 ft. (512 cubic feet). It's easy to use, just unpack — plug it in — and type "install". Place the probe on the point(s) to be entered and you're capturing X, Y, Z Cartesian coordinates.

SOFTWARE-HARDWARE COMPATIBILITY • The GP-12 works with all popular CAD/CAM packages and PC platforms, and comes equipped with its own TSR (Terminate and Stay Resident) driver. Special packages are available for modeling/animation with HyperSpace™ software from Mira Imaging and CAM programs from Cutting Edge™. These packages provide complete turnkey solutions to increase your productivity.

THE MOST FLEXIBLE 3-D DIGITIZER AVAILABLE • It's portable, works in any environment, digitizes any material, and has easy RS-232 interface. Ideal for reverse engineering . . . acquiring 3-D data from prototypes . . . defining tool paths . . . generating data for 3-D graphics, plus applications only limited by your imagination.

SEE HOW THE GP-12 CAN PUT YOU INTO THE WORLD OF 3-D. CALL TODAY.

SAC SCIENCE
ACCESSORIES
CORPORATION

200 Watson Boulevard, P.O. Box 587
Stratford, CT 06497
(203) 386-9978 Fax (203) 381-9270

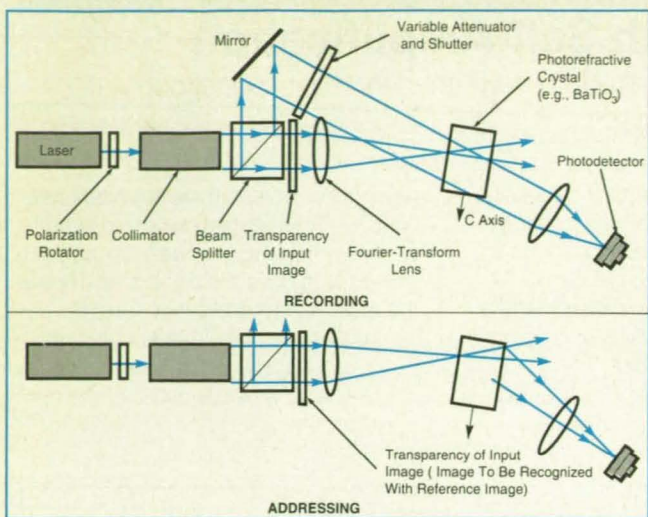

In the **Optical Pattern Recognition System With Self-Amplification**, no reference beam is used in addressing mode. The polarization of the laser beam and the orientation of the photorefractive crystal (as indicated with reference to its *c* axis) are chosen to maximize the photorefractive effect.

linear photorefractive material, the results and applications are quite different. For example, extremely weak signals in a cluttered background can be recognized in the new system.

This work was done by Dr. Hua-Kuang Liu of Caltech for **NASA's Jet Propulsion Laboratory**. For further information, **write in 76** on the TSP Request Card. NPO-18648

Computer-Aided Remote Driving

Stereoscopic still video images are used to designate paths.

NASA's Jet Propulsion Laboratory, Pasadena, California

A system for remote control of a robotic land vehicle requires only a small radio-communication bandwidth — only a fraction of the many-megahertz bandwidth that is necessary for direct teleoperation.

In direct teleoperation, the vehicle would transmit video images of the terrain as it traversed a path, while a human operator at a remote control station would send detailed steering and speed commands

to guide the vehicle around or over obstacles. Communication would have to be nearly instantaneous; transmission delay should be no more than milliseconds. However, in this system, the vehicle

NONLINEAR SIMULATION AND CONTROL WITH VisSim™

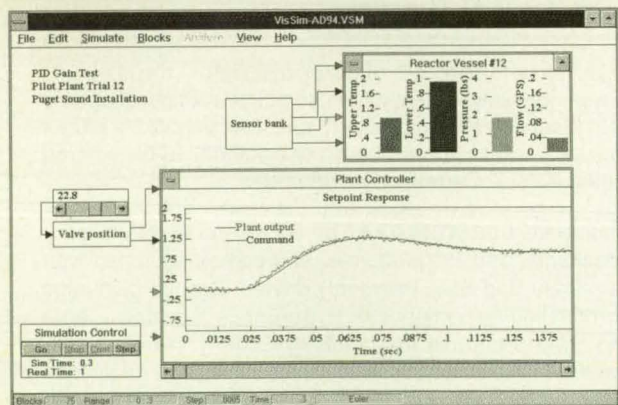

Change parameter values while the simulation runs and see the results instantly.

VisSim provides a complete, visual environment to design, simulate, and perform real-time verification of complex, dynamic systems. VisSim is used worldwide for modeling the behavior of servo systems, drive systems, digital communication systems, power systems, and biomedical processes.

Companion software

- VisSim/Analyze
- VisSim/C-Code
- VisSim/Neural-Net
- VisSim/RT

VisSim runs on MS/Windows, MS/Windows-NT, and Unix/X operating systems.

Call 508/392-0100
for a free working demo

"VisSim is the best software for the design and simulation of nonlinearities in control systems today."

Art Wroble
Senior Control Engineer
Cadillac Gage Textron

Features

- Visually programmed diagram language
- Hierarchical design
- 80+ built-in block functions
- Integrate custom blocks in C or Fortran
- Extensible toolbox libraries
- Nonlinear and linear
- Parameter optimization
- Hybrid, continuous, and discrete multi-rate
- 7 integration methods for fixed step, adaptive step, and stiff systems
- Multi-input/multi-output state-space
- Multi-channel 20mA/10V real-time (opt.)
- DDE and ASCII file import/export
- Linearization, zero & pole finder, and root locus & Bode plots (opt.)
- Implicit system solver
- Dynamic meters and bar graphs
- Time history, FFT, XY plots, strip charts

Visual Solutions 487 Groton Road
Westford, MA 01886
INCORPORATED 508/392-0100
508/692-3102 FAX

VisSim, VisSim/Analyze, VisSim/C-Code, VisSim/Neural-Net, VisSim/RT, and the Visual Solutions logo are trademarks of Visual Solutions, Inc. All other product names are trademarks of their producers.

1:46 AM Thursday.
The #6 disk drive wouldn't boot.
I grabbed my ScopeMeter® test tool and headed
for the computer room.

The **ScopeMeter** test tool is a handheld oscilloscope, digital multimeter and frequency counter. And its compact size is great for troubleshooting electronics, computer hard drives and power supplies.

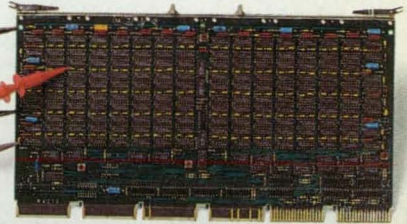

Small enough to fit into your briefcase, ScopeMeter is designed to be on the go. The sealed ruggedized case protects it from moisture and damage. The back-lit screen is easy to read in bright light and low light situations. And the large keypad makes it easy to operate.

For electronics, the 50 MHz dual channel digital scope delivers the waveforms you need. With 25 Megasamples per second, you can catch glitches as short as 40 ns. Plus, it lets you store waveforms and set-ups for future reference.

For electrical applications, the digital multimeter measures true-rms voltage, frequency, duty cycle and more. And the precision MIN/MAX/AVG records and time stamps fluctuations.

So get the test tool that works wherever you work. Call **1-800-44-FLUKE** for more information.

ScopeMeter test tool.
It works wherever you work.

©1994, Fluke Corporation, P.O. Box 9090, M/S 250E, Everett, WA USA 98206-9090. U.S. (206) 356-5400. Canada (905) 890-7600. Europe (31 40) 644200. Other countries (206) 356-5500. All rights reserved. ScopeMeter is a registered trademark of Fluke Corporation. Ad No. 00526

For More Information Write In No. 516

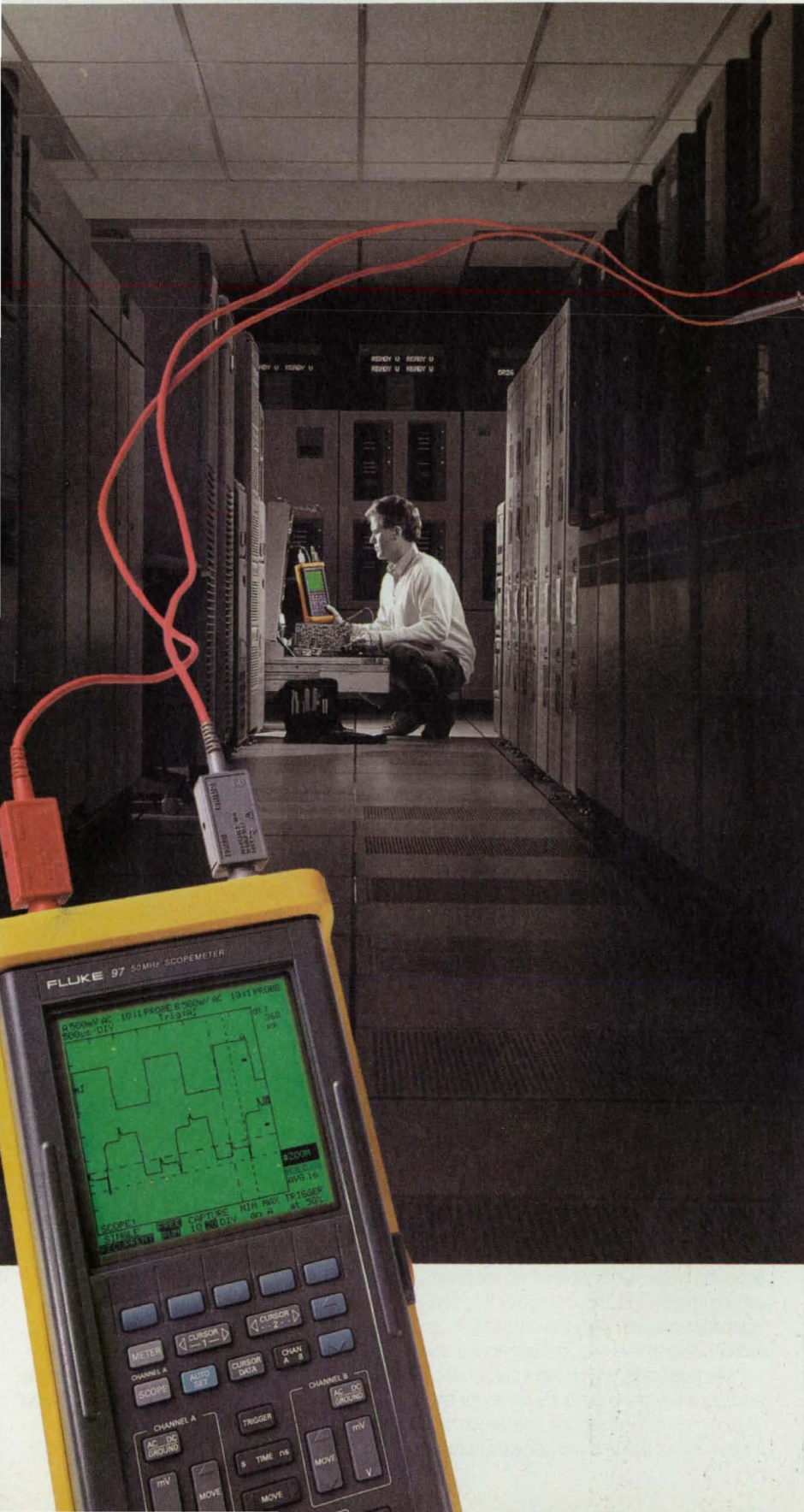

FLUKE®

SL-GMS

...for unprecedented performance
Build precision, animated screens for visual display and interactive control of real-time applications.

Since 1984 SL has offered true object-oriented graphics development tools and software components-- the most advanced available--to help build state-of-the art, high performance dynamic graphical applications. They dramatically simplify the work needed to create interface screens of any complexity and animate them with your data.

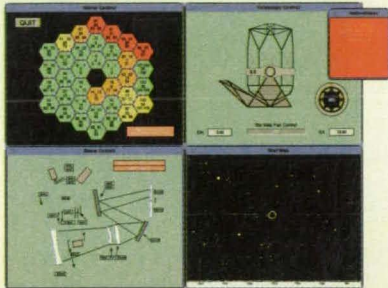

■ Telescope mirror alignment and control system

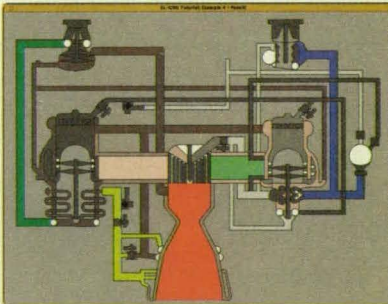

■ Space shuttle main engine

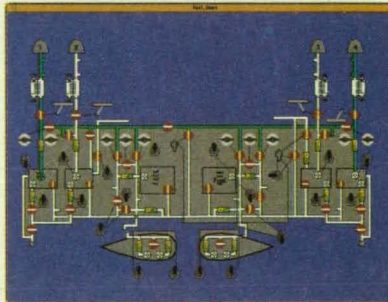

■ On board flight fuel line monitoring and control

Supported systems:

nearly all varieties of UNIX on SUN, HP, IBM, MIPS, DEC (VAX/Alpha, OpenVMS/OSF-1), also X Window, Intel: Windows NT, OS/2. For SGI SL generates display pipe-line code to reach real-time native speeds.

Call: 415/927-1724

SL

Sherill-Lubinski

SL Corporation
Suite 110 Hunt Plaza
240 Tamal Vista Boulevard
Corte Madera, CA 94925
© 1994 Sherill-Lubinski Corporation

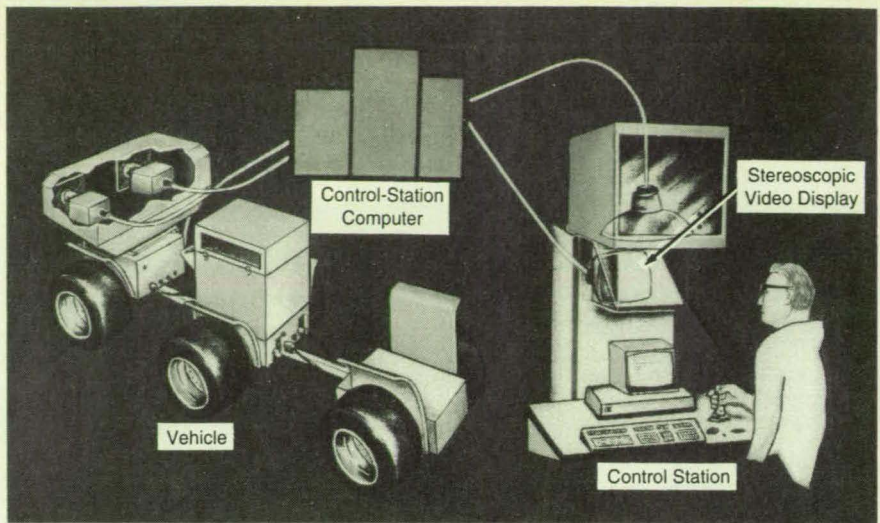

Twin Video Cameras on the vehicle create stereoscopic images. The operator views cross-polarized images on two cathode-ray tubes through correspondingly polarized spectacles.

sends only an occasional pair of images — a stereoscopic snapshot of the terrain — as it prepares to set out on a path. By use of a cursor on the frozen image, the remote operator designates a path. The vehicle proceeds to follow the path, by use of a limited degree of autonomous control to cope with unexpected conditions (e.g., small obstacles). In this system, the vehicle can be controlled not only with a small communication bandwidth but also under conditions of intermittent availability of the communication channel and significant transmission delay. The system concept, called "computer-aided remote driving" (CARD), is potentially useful where such conditions prevail: exploration of other planets, military surveillance, firefighting, and clean-up of hazardous materials, for example.

The snapshot of the terrain is displayed stereoscopically to the operator; that is, the operator's left and right eyes see images from the left and right cameras, respectively, of the vehicle (see figure). Stereoscopic imaging is essential to the CARD concept in that it takes advantage of (1) the human operator's ability to perceive depth and other aspects of the relative geometry of the terrain and the vehicle and (2) the ability of the control computer to extract the position of the cursor and the coordinates of the designated path in the coordinate frame of the vehicle.

The operator uses a hand controller (joystick, trackball, or spaceball, for example) to maneuver the cursor in the stereoscopic images. With the cursor, the operator designates a sequence of acceptable vehicle positions, which are interconnected into a planned path by an algorithm that takes into account the kinematic limitations of the vehicle; for example, its

minimum turning radius.

The planned path is encoded and transmitted to the vehicle along with additional information the operator may want to supply; for example, the desired speed and expected pitch and roll values. The computer aboard the vehicle expands the coded information into continuous speed and steering commands as the vehicle travels the designated path. If an unforeseen obstacle appears, the vehicle circumvents it if possible; otherwise, it stops.

A key feature of the CARD system is that it does not need an expensive and accurate inertial navigation subsystem. It suffices to equip the vehicle with an odometer and with a flux-gate magnetic compass, which serves as heading-reference unit that is stable over a single cycle of planning and traversal of a path. The computed position and orientation of the vehicle with respect to the terrain data base can be recalibrated by occasional sightings of landmarks.

The CARD concept has been demonstrated in a test vehicle over a course about 40 meters long. With further improvements, distances up to 200 meters could be traversed before the vehicle would need a new planned trajectory designated by the operator.

Of course, a fully autonomous vehicle would offer a better solution to problems of remote control, but technology is not yet equal to that challenge. In the meantime, the CARD concept promises to meet the need for control with limited bandwidth.

This work was done by Brian H. Wilcox of Caltech for NASA's Jet Propulsion Laboratory. For further information, write in 101 on the TSP Request Card. NPO-18732

Multiple Pages Intentionally Left
Blank

DESIGN ENGINEERING PRODUCT SHOWCASE

For more information, write in the corresponding number on
the Reader Action Request Form (page 117)

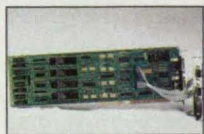

ISOLATED TWO/FOUR SERIAL PORT I/O WITH EX- TENDED AT INTERRUPTS

Omega's new OMEGA-ISO-COMM boards have two or four isolated RS-422/485/232 ports with extended AT interrupts for DOS and Windows software. Based on the 16550 UART, these boards provide two or four serial ports each with 500 V of electrical isolation. Isolation is important where equipment connected to the PC is far from the PC or on a different power transformer circuit. For more information, request OMEGAfaxSM Document #6292 by calling 1-800-848-4271.

OMEGA Engineering, Inc.

For More Information Write In No. 300



NONCONTACT INFRARED TEMPERA- TURE CONTROLLER

OMEGA introduces the new OS5100 series—noncontact infrared temperature controllers that measure and control up to two independent PID loops. The key benefit of this series is the ability to measure and control the temperature of products that may be moving, soft, delicate, sticky, or that are too hot or inaccessible for conventional measurement with contact sensors. For more information, contact OMEGA Engineering at 1-800-TC-OMEGA or request OMEGAfaxSM Document #1469 by calling 1-800-848-4271.

OMEGA Engineering, Inc.

For More Information Write In No. 301



NEW RECORDER IS EASY TO OP- ERATE WITH 4, 6, OR 8 INPUTS

OMEGA announces the RD200 Series of recorders in 4-, 6-, or 8-pen versions. These versatile recorders accept thermocouples, RTDs, mV, mA, ac/dc and frequency in all inputs. The RD200 supports a discrete mode which allows registration of the correct waveform without the imperfection of an analog servo system. The base model 4-pen recorder is priced at \$6500. For more information contact OMEGA Engineering, Inc., or request OMEGAfaxSM Document #8028 by calling 1-800-848-4271.

OMEGA Engineering, Inc.

For More Information Write In No. 302



MULTI- FUNCTIONAL DIGITAL MULTIMETERS WITH 5½-DIGIT DISPLAY

The OM7550 Series of digital multimeters from OMEGA offers very high performance for a variety of applications, from benchtop to R&D use. These desktop models, OM7551 and OM7552, use feedback-pulse width modulation to provide excellent stability, noise immunity and linearity. Even very small changes in signals may be detected. RS232 or GPIB communication interface is standard. Contact OMEGA Engineering, Inc. Tel: 203-359-1660; Fax: 203-359-7700.

OMEGA Engineering, Inc.

For More Information Write In No. 303



NEW, HIGH- SPEED DATA ACQUISITION SYSTEM FOR PCs

The OMB-DAQBOOK-100 plug attaches directly to the parallel port on notebook and desktop PCs. The unit provides the following features:

- 16 analog inputs, expandable up to 256
- 2 analog outputs
- 24 general-purpose I/O channels, expandable to 192
- 16 high-speed digital inputs
- 5 frequency/pulse I/O channels

For more information, contact OMEGA Engineering, Inc. or request OMEGAfaxSM Document #6256 by calling 1-800-848-4271.

OMEGA Engineering, Inc.

For More Information Write In No. 304

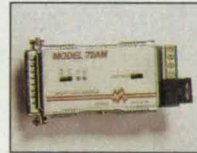

SHORT HAUL MODEMS FOR EXTENDING RS232 AND RS422 SIGNALS

The new CAT Series short haul modems from OMEGA extend the transmission distance of serial communication links. With OMEGA's short haul modems, these distances can be easily extended to several miles. These short haul modems connect into the transmission line and provide transparent operation to the system. No special software is required. For more information, contact OMEGA Engineering, Inc. or request OMEGAfaxSM Document #6271 by calling 1-800-848-4271.

OMEGA Engineering, Inc.

For More Information Write In No. 305



OMEGA announces the new RD90 Series single-pen and dual-pen chart recorders. These recorders offer economical solutions to the need for reliable, high-precision registration of one or two parameters

against time. X-Y versions are also available. The RD90 Series operates with options of RS-232 or IEEE interface. Base model is priced at just \$2500. Contact OMEGA Engineering, Inc. or request OMEGAfaxSM Document #8027 by calling 1-800-848-4271.

OMEGA Engineering, Inc.

For More Information Write In No. 306



NEW ULTRA- HIGH PERFORM- ANCE DATA ACQUISITION BOARD

OMEGA's new WIN-30D board is an ultra-high performance multifunction analog and digital input/output board designed for PC-AT compatible computers. For more information, contact OMEGA Engineering, Inc. or request OMEGA-faxSM Document #6299 by calling 1-800-848-4271.

OMEGA Engineering, Inc.

For More Information Write In No. 307



PAPERLESS RECORDING SYSTEM WITH FULL GRAPHIC LCD DISPLAY

Newport Electronics, a leader in digital instrumentation, introduces the new RD820 series paperless recorder which provides single or dual channel real time graphic display, recording and digital display of your measurements in engineering units. Optional memory cards are available that provide up to 1 MB of data storage. The extensive selection of plug-in modules allows measurements from thermocouples, RTDs, voltages and currents, both AC and DC. For more information, call 1-800-NEWPORT.

Newport Electronics, Inc.

For More Information Write In No. 308

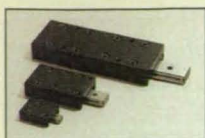

LOW PROFILE CROSSED ROLLER SLIDES

By utilizing a single double sided V-grooved rail as the base member. Del-Tron has developed a low profile series of "LPT" crossed roller slide tables. An aluminum carriage with inch type threaded mounting holes makes this a light weight and compact slide table, ideal for high loads and fast reciprocating motion applications. "LPT" slides are available in twenty one sizes with profiles of 0.315" through 0.630". For a free forty page product guide including process, specs, and technical information, please call 1-800-245-5013; Fax: 203-778-2721.

Del-Tron Precision Inc.

For More Information Write In No. 310



MEASURE- MENT AND CONTROL MADE EASY

"Insta-trend Real Time Graphics" features Dianachart Insta-Trend data acquisition and control software in a 4-page color leaflet. Insta-Trend is designed for ease of use,

together with great flexibility. It interfaces data acquisition, controllers and PLCs from many vendors to PCs. A free demo disk is also available.

Dianachart Inc.

101 Round Hill Drive, Rockaway, NJ 07866
Tel: 201-625-2299; Fax: 201-625-2449

For More Information Write In No. 311

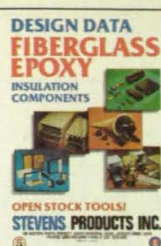

FIBERGLASS LAMINATED EPOXY 155 °C

Design Data pamphlet featured materials, properties, and tolerances for glass epoxy components. It shows designers how to specify from open stock tools, for potting forms, bobbins, coil forms, structurals, and circuit board manufacturing aids. Stevens Products, Inc., 128 N. Park St., E. Orange, NJ 07019. Tel: 201-672-2140.

Stevens Products, Inc.

For More Information Write In No. 312



AUTOMATIC VIDEO TRACKERS

Octec's line of advanced, real time, video image automatic tracking systems can be integrated into TV/IR camera platforms and fixed position cameras where single or multiple object position data are provided for subsequent analysis. Octec systems serve the Surveillance, Behavior Research, Outside Broadcast, Process Control and Defense fields. Contact Gordon Cain, Octec Ltd., Western Road, Bracknell, Berks, RG12 1RW, England, Tel: +44 344 861051. Fax: +44 344 860983.

Octec Limited

For More Information Write In No. 313



FINE WIRE AND RIBBON PRODUCTS

Molecu Wire Corporation specializes in the manufacturing of precision fine wire and ribbon products used in a wide variety of applications including computer peripherals, medical devices, consumer electronics and telecommunications. Molecu's in-house enamelling and gold-plating capabilities assure customers a precision product that meets the most demanding specifications. Molecu is proud of the rigorous quality testing procedures and equipment we have pioneered to meet the our customer's diverse needs.

For More Information Write In No. 314



INSTRUMENT TECHNOLOGY INC.

Instrument Technology, Inc. specializes in the design, development and manufacture of Standard Product and Custom Remote Viewing Instruments and Systems for the industrial market. To satisfy requirements, ITI produces high quality Borescopes, Fiberscopes, Videoscopes, Telescopes, Periscopes, and Systems. For more information, contact: ITI, P.O. Box 381, Westfield, MA 01086. Tel: 413-562-3606. Fax: 413-568-9809.

ITI

For More Information Write In No. 315



HUNTER MINI- PLATING PENS

Low-cost disposable applicators permit instantaneous selection from a variety of plating possibilities without preparation of solutions. Specially formulated plating compounds can be used anywhere: prototype development work, electronic instrument repair, contact repair, etc. Pens available: copper, tin, zinc, nickel, black nickel, silver, chrome-color, rhodium, palladium and gold (24, 18, and 14K). Tel: 908-526-8440; Fax: 908-526-8348.

Hunter Products, Inc.

For More Information Write In No. 316



CLAMPS

The World of Clamping Catalog 492 describes and illustrates toggle and special clamps with vertical and horizontal hold-down, straight-line, latch and squeeze action. Spacing products, hydraulic devices, and CAD database are covered along with applications. De-Sta-Co, Troy, MI. Tel: 313-589-2008.

De-Sta-Co

For More Information Write In No. 317

FLEXIBLE IMAGE PROCESSING BOARD

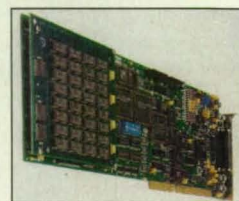

The 4MEG VIDEO MODEL 12 provides image acquisition, processing, and display on PC/AT compatible computers, and offers up to 64 Mbytes of image memory, sampling/display rates up to 50 MHz, and a 12 MIPS on-board processor. The board interfaces to almost any video source. Tel: 708-465-1818; Fax: 708-465-1919.

EPIX, Inc.

For More Information Write In No. 318

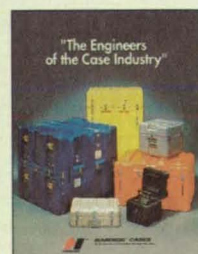

Hardigg Cases offers over 225 standard rotationally molded transit cases, including a full line of 19" EIA rack mount cases, deck cases, and flange-mount cases. Hardigg's expert engineering, manufacturing, and test facilities provide start to finish custom design capability. A complete list of standard cases allows for rapid delivery...as few as three working days! Take advantage of over thirty years of experience...design a Hardigg case into your next project!

Hardigg Cases

Tel: 1-800-JHARDIGG; Fax: 413-665-8061
For More Information Write In No. 319

ASTM MATERIAL SPECIFICATION GUIDE

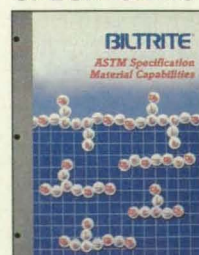

A handy, four-page guide to the qualities, capabilities of sheet rubber materials, as specified by the ASTM is now available from the Specialty Products Division of the Bilrite Corp. Featuring a two-page, full-color specification table of sheet rubber materials, this brochure makes it easy to order sheet rubber products for a given application. The Bilrite Corp., Specialty Products Division, Two University Office Park, 51 Sawyer Road, PO Box 9045, Waltham, MA 02254-9045. Tel: 1-800-877-8775.

For More Information Write In No. 320



BLIND FASTENING SOLUTIONS

The blind rivet nut, an internally threaded tubular rivet, provides a practical method of fastening a wide variety of threaded products from only one side of the work. Use in any machinery or equipment where a strong, internally threaded, easy-to-install blind fastener is required. Metric and American unified threads available.

Sherex Industries

1400 Commerce Parkway, Lancaster, NY 14086
Tel: 716-681-6250 Fax: 716-681-0270
For More Information Write In No. 321

SUNNEX Halogen Task Lamps



Over 436 standard configurations plus customized versions.

1-800-445-7869

For More Information Write In No. 322

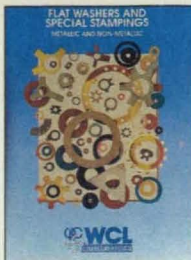

METALLIC AND NON-METALLIC FLAT WASHERS TO MIL SPEC

Our informative new catalog lists AN, MS and NAS flat washers, providing dimensions, materials and availability. Many commercial parts also shown. Test

requirements and available certifications are described. Specialists in army, navy and aerospace fastener requirements. WCL - West Coast Lockwasher, 16730 East Johnson Drive, P.O. Box 3588, City of Industry, CA 91744. Phone: 1-800-331-3816. Fax: 818-369-9805.

For More Information Write In No. 323



LINEAR MOTION IN RESPONSE TO THERMAL STIMULUS!

Actronics' valve operators can control your demanding fluid control requirements and our actuators can be your muscle in the toughest environments,

responding at temperatures you specify. We have been putting the quality in first for over thirty years.

Actronics Incorporated

For More Information Write In No. 324

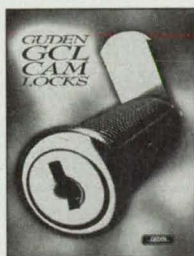

GCL CAM AND DRAW LOCKS

New catalog presents Guden's complete line of GCL Cam and Drawer Locks to complement their hinge, latch, clasp, handle, lid support and gas spring products. Full variety of stock items plus customized locks. Personal service and instant shipments

on even the smallest orders. Easy-Order part number system. Ask for the GCL Catalog. H.A. Guden Co., Inc., 99 Raynor Ave., Ronkonkoma, NY 11779. Tel: 1-800-344-6437 or 516-737-2900; Fax: 516-737-2933.

H.A. Guden Co., Inc.

For More Information Write In No. 325



ESTIMATING WITH CAD

The COSTIMATOR® system now allows cost estimating of new products using most CAD systems. Estimates are reported to be within 5% of actual costs with this new mouse-driven system. DFM compatible. Easy to use. Fast payback.

Manufacturers Technologies, Inc.

59 Interstate Drive,
West Springfield, MA 01089
Tel: 413-733-1972.

For More Information Write In No. 326



TIG TORCH SELECTOR

Versa-Tig™ Systems allow multiple torches to share one power source. Use with any tig torch & power source. Perfect when a variety of materials, thicknesses, joint geometries and combinations of welds or setups require multiple torch options. Uses: manual

& fixtured torches, wire-feed Tig torches, seam/lathe-welders, turntables, welding chambers & orbital tube welders. Systems allow operators to "dial in" the desired torch or setup in "2 seconds" without tools!

Stainless Design, Inc.,

For More Information Write In No. 327



NEW MOTION CONTROL PRODUCT GUIDE

Aerotech's new 248-page Motion Control Product Guide provides in-depth technical data and design information for our linear and rotary positioning stages; microstepping motors and translators,

servo motors and drivers (both DC and brushless); position transducers; and motion controllers (from one to 16 axes). Aerotech, Inc. 101 Zeta Drive, Pittsburgh, PA 15328. Tel: 412-963-7470; Fax: 412-963-7459.

Aerotech

For More Information Write In No. 328



LOW-COST DIGITAL VIBRATION CONTROLLERS

Easy to use VTS Expansion Card & Software convert your 386/486 personal computer to powerful Digital Sine or Random Vibration Controller.

Frequency ranges—Random 500, 1000, or 2000 Hz. Sine to 6250 Hz. Many other unique features. Free Demo Disk available (learn to operate Controller in less than one hour). Coming Soon—Accelerometer Calibrator & Shock Controller.

Vibration Test Systems

For More Information Write In No. 329



ULTRASONIC TESTING EQUIPMENT

StressTel Corporation offers a complete portable line of ultrasonic thickness gauges, bolt stress measurement devices, ultrasonic transducers and software. Thickness gauges range from our simple-to-use T-Mike EZ to sophisticated

T-Scope DL. The Bolt Mike SMII bolt monitoring system ensures accurate bolt tensioning in any application.

StressTel Corporation

For More Information Write In No. 330

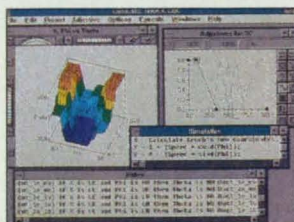

FUZZY LOGIC TOOLS

Apply fuzzy logic interactively with CubiCalc's built-in simulation language, plots, file I/O and other features. Or use CubiCard's integrated data acquisition board and drive external hardware directly.

HyperLogic Corporation

Tel: 619-746-2765; Fax: 619-746-4089.

For More Information Write In No. 331

The Intelligent Solution for Data Acquisition

A Data Acquisition Processor™ board, like the 486-based DAP 3200e™ shown here, has its own on-board multitasking real-time operating system, DAPL™, that does the time-critical work in an application.

DAPwindows™, running on the PC under Windows, can issue commands to DAPL to acquire data or control processes in real time through the Data Acquisition Processor.

DAPL, optimized for data acquisition and control applications, recognizes over 100 standard commands. A typical application is completely defined with DAPwindows in just a few minutes.

The Data Acquisition Processor frees the application from delays imposed by Windows that are unacceptable in real-time work. Special on-board hardware bypasses DMA to drive the bus at maximum speed.

2265 116th Avenue N.E., Bellevue, WA 98004

Call us: 206-453-2345 / FAX 206-453-3199



MICROSTAR LABORATORIES™

For More Information Write In No. 333

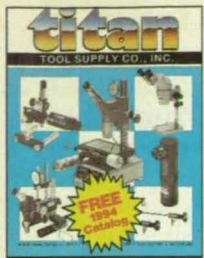

OPTICS FOR METROLOGY

New 1994 Catalog contains 120 pages of information and prices on tool-maker's microscopes, stereo microscopes, alignment microscopes, monocular zoom microscopes, microscopes, pocket microscopes, borescopes, micro video lenses, and fiber optic

and miniature illumination systems. Also described are centering microscopes, optical cutting tool geometry analyzers, X-Y tables, and micro-finishing equipment.

Titan Tool Supply Co., Inc.

Tel: 716-873-9907; Fax: 716-873-9993.

For More Information Write In No. 334

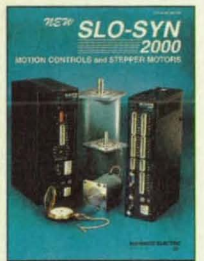

STEPPER MOTOR CONTROLS

Catalog SS2 792 describes new SLO-SYN® 2000 Motion Controls. Bipolar chopper drive has switch-selectable current settings from 1 to 6 A, 10 switchable motor microstepping resolutions from 200 to 50,000 pulses/rev. Programmable motion control permits 2 axes of control (non-simultaneous) for price of one, 16 inputs and 8 outputs fully protected. Call 1-800-447-7171.

Superior Electric

1994 Design Show Booth # 2657

For More Information Write In No. 337

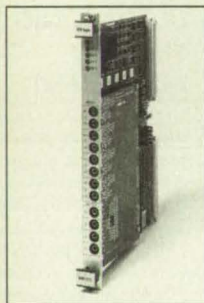

MMI-4211 VME AUDIO SIGNAL PROCESSOR

- Four independent DSP56001 Digital Signal Processors
- 4 MByte Multi-port RAM
- Four Channels of hi-fi quality digital audio processing

- Programmable sample rates from 8 kHz to 48 kHz
 - DiSPATCH provides real-time digital mixing of 25 audio streams and 12 independent tones per DSP
- FOR MORE INFORMATION CALL 619-597-7080.

Vigra

For More Information Write In No. 340



MEMBRANE SWITCHES ELASTOMERIC KEYPADS

TADCO has been an innovator in the membrane switch and printed circuit field since 1978. We also manufacture elastomeric keypads, assemblies, graphic panels, overlays and labels. TADCO's

engineering team has over 30 years of combined experience in design of our products.

Tadco

For More Information Write In No. 343

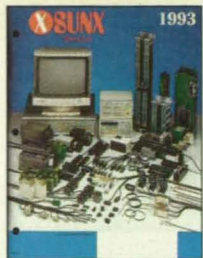

SUNX SENSORS

NEW 34 page brochure featuring photo-electric, fiber optic, proximity, miniature, micro-photo, pressure/vacuum, area, linear array, color discrimination, analog output, and ultrasonic sensors. Also, rotary shaft encoders, optical identification systems,

ultraviolet beam sensors, light curtain-area sensors, laser beam and wafer address sensors. 1207 Maple Street, West Des Moines, IA 50265. Tel: 1-800-280-6933; Fax: 515-225-0063.

SUNX Sensors/ Ramco Electric Co.

For More Information Write In No. 335

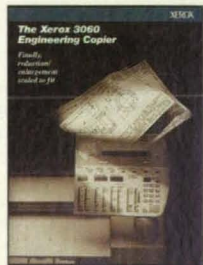

XEROX 3060 ENGINEERING COPIER

A full-color brochure details how the Xerox 3060 Engineering Copier saves time and money through reduced-format reproduction and easy-to-use features. It reduces or enlarges documents by 45 to 200 percent and pumps out A-

E-size prints with up to 15 copies from a single feed. Throughput is as fast as eight prints a minute. Get the inside story on plain-paper performance, Xerox quality and the unmatched Total Satisfaction Guarantee. Call 1-800-XES TALK, ext. 8223.

Xerox Engineering Systems

For More Information Write In No. 338



NEW SEAL SELECTION GUIDE

American Variseal announces their new Seal Selection Guide for high performance spring-energized seals. This unique eight-page color manual describes Variseal's wide range of products for static, reciprocating and rotary

service. Engineering charts include seal performance ratings at various pressures, temperatures and speeds. Also included are data on seal materials, gland design, surface finish, standard sizes, custom designs, and technical support. Call 1-800-466-1727.

American Variseal

For More Information Write In No. 341



COLOR WORKSTATION FOR DATA ACQUISITION AND ANALYSIS

The HT600 combines internal math algorithms with high speed, high resolution digitizing of analog signals. A built-in VGA color graphics interface with touch panel, mouse or keyboard entry increases ease of use. It boasts sampling rates from 1 sample/sec. to 200 Megsamples/sec. with memory sizes 2k to 32 Meg and digitizers from 8 bits to 16 bits. From \$15,500, depending on digitizers & memory length. Delivery: 30-45 days ARO. Contact: Garry Williams, 1-800-248-1633.

Hi-Techniques, Inc.

For More Information Write In No. 344

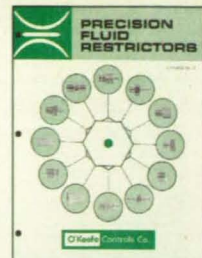

PRECISION ORIFICES

A new and expanded catalog is now available with more than 1500 sizes and styles of Precision Orifices. Sizes range from .001" to .250" with material choices of sapphire, brass, or stainless steel. Provides specifications and complete dimension data; lists suggested applications for gases and liquids.

O'Keefe Controls Company

P.O. Box Q, Trumbull, CT 06611

Tel: 203-261-6711 or 800-533-3285;

Fax: 203-261-8331.

For More Information Write In No. 336



PROTO-TYPING, TEST INTER-CONNECT

Call for a complete range of Interconnect Solutions including hundreds of prototyping adapters, test probe adapters for PLCC and Quad Flat Pack, Surface Mountable Test Adapters, and other interconnect devices. QUICK TURN CUSTOM DESIGN SERVICE....

Ironwood Electronics

Tel: 612-431-7025

For More Information Write In No. 339



VERSATILE CAM RUNS WITH ANY CAD

Guaranteed CAD/CAM data translators, including IGES Version 5.1 with trimmed NURBS surfaces. Fast and accurate 3D surface design, model, NC programming and machining. Powerful DOS and 32-bit Windows version.

Call 800-488-3615 or 818-361-5605; Fax 818-361-1919.

Surfware, Inc.

For More Information Write In No. 342



STATIC SAFE IC STORAGE ALBUMS

Organize and protect all your ICs in our ESD safe (MIL-Spec), crush-proof, dust-tight, snap-closed albums. They are the perfect, inexpensive solution for storing, archiving and transporting your expensive library of IC Masters, MODS, REVS, Samples and Spares—unzapped, unbent, uncrushed, uncracked and clean.

ITOI ENTERPRISES

P.O. Box 59, Newton Highlands, MA 02161.

Tel: 617-332-1010; Fax: 617-332-2173.

For More Information Write In No. 345

8.5" THROUGH 29" CUSTOM MONITORS



Modgraph, Inc. offers custom configured monitors ranging in size from 8.5" to 29". Touch Screens, 12/24/48 Volt DC power, industrial enclosures, open frame models and rackmounts are available for most display sizes. **Modgraph** can be reached at 1-800-327-9962. **Modgraph, Inc.**, 6 Gill Street, Woburn, MA 01801. Tel: 617-938-4488; Fax: 617-938-4455.

For More Information Write In No. 346



LOW-COST PC-COMPATIBLE DATA LOGGER

Puts eight thermo couple channels on monitor, printer, or disk for \$279 complete. Specifically for laboratory and industrial temperature monitoring. Avoids complex set-up or installation and is functioning within minutes. RS-232 interface powers converter and eliminates sensor wires at computer. Quick-Basic®MS source code and compiled program provided. 16-channel and linear sensor options.

DCC Corporation

DCC Corporation

For More Information Write In No. 347

IMPROVE RELIABILITY OF YOUR ELECTRONIC DESIGN/ EQUIPMENT

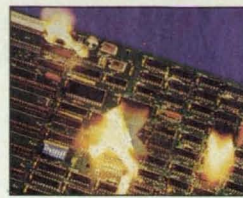

Prevent this with our Contract R&D, Consulting, Software Development and Screen Testing Services.

FOR ALL YOUR ELECTRONICS PACKAGING AND CONCURRENT ENGINEERING NEEDS.

CETAR, A Phillips Electronics North America Company
Fax: 301-698-0624

For More Information Write In No. 348

GO WHERE YOUR DREAMS TAKE YOU ME/NASTRAN



We have always been dreamers. But how do we know our designs will work? If NASTRAN had been available to Leonardo da Vinci where would we be today? In the past, NASTRAN was out of reach of most small businesses.

ME/NASTRAN changes all that. With the power of the personal computer, it is available to the Da Vincis of today. Imagine the power of FEA on your PC, solving design problems in the early stages. It can be used to analyze everything from the "nuts and bolts" to the complete assembly. ME/NASTRAN is limited only by your imagination. Just imagine the possibilities if such a powerful tool had been available to the great minds of the past.

MACRO Engineering, (205) 461-7090

For More Information Write In No. 349



Engineered Coatings For Industries

570 W. Gore Rd.
Morris, IL 60450

1-800-248-4221
Mill Spec. - D.O.D. Approved

For More Information Write In No. 350

CATALOG OF ENGINEERING FINDINGS



find•ings (fin'dingz), *n.*
small tools and materials used by an artisan.

320 pages of component parts, select materials, and precision tools.

For your free copy of our 1994 catalog. . .

SMALL PARTS, INC.

P.O. Box 4650 Miami Lakes, FL 33014-0650
305-558-1255 or Fax at 1-800-423-9009

For More Information Write In No. 351

FEA FOR WINDOWS



The INERTIA Engineering System is an integrated analysis and simulation system. Type of analysis available are: stress, structural, steady state and transient heat transfer, dynamics, kinematics and non-linear. Windows, UNIX, Mac and network versions available.

MCAE, Inc.

8425 Woodfield Crossing Blvd. #221,
Indianapolis, IN 46240
Tel: 800-444-6223; Fax: 317-469-4130.

For More Information Write In No. 352



NEW PRECISION BELLOWS ASSEMBLIES

Precision electron beam welding techniques are now being used by Servometer Corp. to join

thin-walled, electrodeposited nickel bellows to machined end fittings. This minimizes risk of damage to bellows and yields assemblies that are leak tight to 10-9 cc/sec. A variety of pressure, stroke, and stiffness combinations are possible through control of wall thickness and number of bellows plies. Contact: Peter Thompson, Servometer Corp., 501 Little Falls Rd., Cedar Grove, NJ 07009. Tel: 201-785-4630. Fax: 201-785-0756.

Servometer Corporation

For More Information Write In No. 353

High Pressure Hose



*The strength of steel.
The flexibility of hose.*

Polyflex steel reinforced thermoplastic hoses are available with working pressures from 4,000 psi to 60,000 psi, with bore sizes from 1/8" up to 1". The hoses are available in very long continuous lengths, as well as multi-hose bundles

and umbilical assemblies. The tested, certified and traceable assemblies provide good fatigue resistance, light weight, flexibility, and chemical and environmental resistance.

Rogan and Shanley, Inc.
(800) 446-5236

For More Information Write In No. 354

FIRESTONE END EFFECTORS



AirPickers® and AirGrippers™ offer an alternative to multi-figured claws and vacuum cups. The pick-and-place end effectors use pressure control and rubber to handle objects (weighing a few ounces to 50+ pounds) firmly, yet gently. See us at NDES, booth 1659, or call 1-800-888-0650.

Firestone Industrial Products
701 Congressional Blvd., Carmel, IN 46032

For More Information Write In No. 355

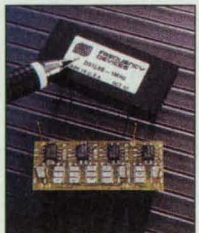

LINEAR-ACTIVE FILTERS TO 1MHz

New D68 filter is compact and low profile offering <80dB harmonic distortion with a signal-to-noise ratio to better than 12-bit resolution. A self contained solution with high input impedance and low output

impedance that provides isolation and ease of coupling is available in several transfer functions from 50 kHz to 1 MHz. Price: \$74.00 to \$116.00 for 1000+.

Frequency Devices, Inc.

25 Locust St., Haverhill, MA 01830;
Tel: 508-374-0761; Fax: 508-521-1839.
For More Information Write In No. 356

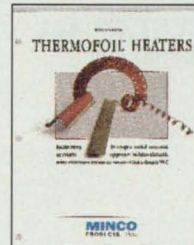

THERMOFOIL™ HEATERS

Bulletin HS-201 lists over 200 sizes and resistances of etched-foil heating elements. Included are Kapton, silicone rubber, and mica insulated models for aerospace, medical, and industrial devices. The 32-page catalog offers complete technical specifications, custom design information and application ideas to help the reader solve unique heating problems using Thermofoil technology.

Minco Products, Inc.

For More Information Write In No. 357



TEMPERATURE SENSORS AND TRANSMITTERS

108-page catalog lists resistance temperature detectors (RTDs), thermocouples, and transmitters for precision sensing in process control, machinery protection, and scientific applications. Included are flexible Thermal-Ribbon™ RTDs, laboratory standards, and new precision RTD probes rated to 850 °C. Hundreds of items are available from stock for immediate shipment.

Minco Products, Inc.

For More Information Write In No. 358



FLEX-CIRCUITS

Bulletin FC-301 describes precision single-layer, double-layer, multilayer, and rigid-flex circuits for aerospace, military, and medical electronics. Minco circuits are certified to MIL-P-50884C for critical applications. The 8-page bulletin includes design options, quality provisions, capabilities, and flex-circuit benefits.

Minco Products, Inc.

For More Information Write In No. 359



FULLY INTEGRATED AIR BEARING SYSTEMS

NEAT now offers complete "turnkey" air bearing systems to suit a variety of high precision applications. Pictured is a five axis inspection system that utilizes both air bearing and mechanical stages along with rotary and linear brushless servo motors. This custom integrated air bearing based system is one example of the many conformations NEAT is prepared to design and manufacture for fully automatic positioning applications.

New England Affiliated Technologies

See us at NDES Booth No. 2551

Tel: 1-800-277-1066.

For More Information Write In No. 360



The Advanced Aircraft Analysis software is a powerful, user-friendly tool for use in the airplane preliminary design process. Features include weight sizing, drag estimation, stability and control, trim, control systems design and cost estimation. AAA operates in either British or metric units and is available on X Window System based workstations.

Design, Analysis and Research Corporation

For More Information Write In No. 397

UTILITIES FOR COMPUTER VISION



Two Program Libraries for CADD5-4X and CADD5. One has 1000s of fasteners and other parts for 3D models, plus AUTOMATIC BILL OF MATERIALS GENERATION. The other has 18 programs, integrated with layer lists. Full DEMO programs are available.

Design Solutions Software Co.

20 Concord Creek Rd., Glen Mills, PA 19342

Tel: 215-358-4054

For More Information Write In No. 361



AMCO'S NEW MONITORING SYSTEMS

Consoles come in single or multiple bay configurations and are for monitoring type applications. Engineered to accept the company's standard accessories. Models include those with low silhouette bases, sloped front frames & vertical frames, wedge sections & turrets.

AMCO Engineering Company

For More Information Write In No. 362



Stanyl 46 nylon offers outstanding property characteristics in demanding automotive, electrical/electronic and mechanical applications. This high-heat material offers cost-effective solutions with faster molding cycles. For a 20-page brochure, please contact DSM Engineering Plastics, Stanyl Marketing Center, 501 Crescent Avenue, Reading, PA 19612. Tel: 800-366-6923.

DSM Engineering Plastics

For More Information Write In No. 363

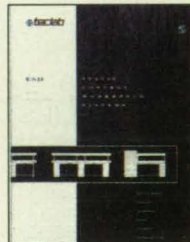

TECLAB ESD WORKSTATION CATALOG

Kalamazoo Technical Furniture's 8-page 4/color brochure details the Teclab line of static protective workbenches, workstation systems, and ESD controlled workstation accessories. Included are color options, product specifications, and various levels of ESD protection available. Teclab also offers a Free Planning and Design Service. Teclab, the "professional's bench." Tel: 1-800-832-5227. Fax: 616-372-6116.

Kalamazoo Technical Furniture

For More Information Write In No. 364



NEW FEASIBLE DESIGN AND ANALYSIS SOFTWARE

WeCan 5.0 is an integrated engineering design analysis package running on PCs and workstations. It is a full-featured, 3-D package developed by Westinghouse Electric Corporation over a 20 year period and used to simulate and visualize a wide range of static, dynamic and thermal design problems. FREE INFORMATION KIT; FULL WORKING DEMO AVAILABLE. CALL 412-826-3470.

Aegis Software Corporation

For More Information Write In No. 365



BEST OF ALL WORLDS...

in Ruggedized Video Cameras
Under \$3,000

- Ruggedized & Qualified
- 7 G's RMS Vibration
- 470 TV Lines Res.
- Color (NTSC or Y/C)
- Miniature, Less than 6 oz. Only 1" x 1" x 5"
- Low Light 4.5 LUX
- Right Angle, Straight or Remote Head Versions

Sekai International

14535-H Valley View Avenue

Santa Fe Springs, CA 90670-5234

Tel: 310-921-7775; Fax: 310-921-7875

For More Information Write In No. 366

Real-Time... Guaranteed



Introducing the Concept 810 - An Affordable "Real"-Time RAID Storage System.

For guaranteed capture and retrieval of data at 16 MB/s.

The Concept 810 is a high performance disk storage subsystem. Using RAID (Redundant Array of Independent Disks) architecture and advanced SCSI disk drives, the Concept 810 makes real-time storage affordable.

10 to 16 MB/s sustained data transfers for interactive and real-time operations
2 to 18 GB storage capacity
Companion Host Adapters and Software Drivers available



Call Now For Information
1-800-525-9217

For More Information Write In No. 367



POWDER INJECTION MOLDING

Arburg, Inc. offers complete systems, including all pre- and post-molding operations, for molding metal or ceramic powders into complex, high-density parts. Ideal for hard-to-machine materials and complex shapes with undercuts and internal geometry. Call 203-667-6500.

Arburg, Inc.

For More Information Write In No. 368



E-Z TUBE BOLTLESS CONSTRUCTION

The E-Z Tube Boltless Construction System is the cost effective solution for custom frameworks such as machine guarding, workstations and sound enclosures. A series of ABS encapsulated steel joints

are readily assembled with extruded aluminum or polished stainless square tubing. International Designs Ltd., 70 Commerce Drive, Ivyland, PA 18974. Tel: 800-833-2522, 215-672-4876; Fax: 215-672-0508.

International Designs Ltd.

For More Information Write In No. 369



BIG SAVINGS ON SUPPLIES

When it comes to professional CAD, drafting and design supplies, SAGA is your mail-order source for name-brand products. Plotters, plotter supplies, media, furniture, and more. Guaranteed value with discount prices and quick, efficient service. For FREE catalog and discount

coupon, call 1-800-328-0727, ext. 490. SAGA CAD & Drafting Supply, 400 Highway 169 South, Minneapolis, MN 55426-1199. Fax: 612-593-2345.

SAGA CAD & Drafting Supply

For More Information Write In No. 370



NEVER CREATE ANYTHING TWICE

Save hours of design time by using Stikybak™ for repetitive artwork, charts, graphs, title blocks or architectural renderings. Print your original design onto Stikybak™ (in your copier or laser printer), remove the backing and

"stick-it-on" to originals, copies or prints! SAGA CAD & Drafting Supply, 400 Highway 169 South, Minneapolis, MN 55426-1199. Fax: 612-593-2345.

SAGA CAD & Drafting Supply

For More Information Write In No. 371

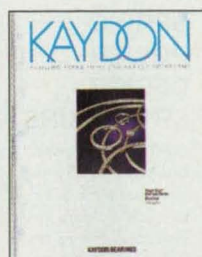

THIN-SECTION BEARINGS

Save weight and space with Reali-Slim® thin-section bearings. Ideal for design work in aerospace, robotics, medical, scientific and communications equipment. 64-page catalog details over 200 in-stock sizes from the industry leader—Kaydon. Request

Cat. No. 300. Kaydon Corp., 2860 McCracken St., Muskegon, MI 49443. Tel: 616-755-3741.

Kaydon Corporation

For More Information Write In No. 372

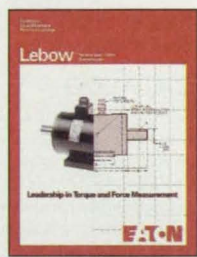

Eaton Corporation, Lebow Products is an industry leader in the manufacture of high quality, high precision, rotary inline and reaction torque sensors as well as fatigue resistant and general purpose load cells. We have over 35 years experience in torque and force measurement. Tel: 1-800-338-8099, ext. 2040; Fax: 810-642-0259.

Eaton Corp., Lebow Products

For More Information Write In No. 373

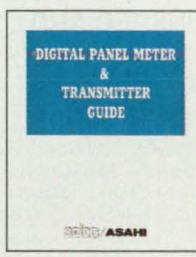

DIGITAL PANEL METER & TRANSMITTER GUIDE

New 8-page product guide summarizes Selco/Asahi's digital instrument line: DC and AC voltmeters and ammeters, process monitors, setpoint comparators, counters, tachometers, frequency meters, strain gauge meters, thermometers, remote monitors, transmitters, modular DPM and DC power supplies. Over 80 models with information on size, number of digits, and measurement setups. Tel: 714-521-8673, 800-229-2332; Fax: 714-739-1507.

Selco/Asahi

For More Information Write In No. 374



Today's demanding manufacturing environment requires test solutions that rapidly adapt to changing products. Low cost, high flexibility, long service life and a minimum of special skills requirements set the FTMS™ VXI/GPIB test system apart from all other test solutions. It's the easiest ATE operating environment you'll ever use. Westinghouse-Flexible

Test & Measurement Systems Group, 18901 Euclid Ave., Cleveland, OH 44117. Tel: 216-692-5179.

Westinghouse-Flexible Test & Measurement Systems Group

For More Information Write In No. 375

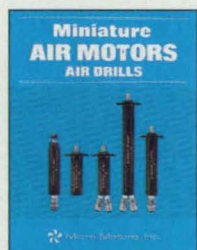

MINIATURE AIR MOTORS

Brochure lists size and performance options to help you select the smallest, most efficient Air Motor to meet your needs. Stainless, rotary vane designs produce stall torques from 3.5 in-ozs to 9 ft-lbs and free speeds of 50,000 RPM to 1 RPM.

Micro Motors Inc.

For More Information Write In No. 376



HEIDENHAIN'S 52 page General Catalog features mechanical and technical information on Linear and Rotary Encoders, Digital Readouts, Numerical Controls and Digital Height Gages for measurement and inspection applications. Metal-cutting and metal-forming machines, inspection equipment, general automation and

the electronics industry are just a few of the various types of applications that require measurement systems for position and speed control feedback.

Heidenhain Corporation

For More Information Write In No. 377



INFLATABLE RUBBER SEALS

Brochure shows configurations of custom-built inflatable rubber seals. When inflated, a positive seal is formed between two surfaces. It's the solution for sealing out weather, water, noise, heat, cold, light, dark, pressure, vacuum,

radiation, dust and contaminants. Design assistance available. Tel: 216-673-8410; Fax: 216-673-8242.

Seal Master Corporation

For More Information Write In No. 378



SHAFT HUB LOCKING DEVICES

32 page catalog details our line of keyless, frictional locking devices for securing any rotating component to shafts from 1/4"–40". Catalog contains technical data & dimensions, selection guides and application information. Westwood,

NJ office—Tel: 800-245-2580; Fax: 201-664-6053. Los Angeles office—Tel: 714-581-3644; Fax: 714-581-5956.

Ring Feder Corp.

For More Information Write In No. 379

WINDOWS MOTION CONTROL SOFTWARE



State-of-the-art tools for Graphical Motion Programming. Create powerful Windows solutions in Visual Basic, LabVIEW, C or QuickBasic. Complete motion DLLs and VI libraries with 100's of integrated functions. Compatible with nuLogic's multi-axis Servo & Stepper Boards for PC/AT ISA & Mac/NuBus.

nuLogic Inc.

475 Hillside Avenue, Needham, MA 02194
Tel: 617-444-7680; Fax: 617-444-2803

For More Information Write In No. 380

COMPLETE MOTION CONTROL SOLUTIONS



High Performance Servo & Stepper Controllers for PC/AT ISA Bus and Macintosh computers. 1-4 axes of control with Power Amplifier and Interface Units. Easy-to-use software including pcRunner Windows *Double-Click* application, DLLs, LabVIEW Motion VIs, Visual Basic, QuickBasic and C drivers.

nuLogic Inc.

475 Hillside Avenue, Needham, MA 02194
Tel: 617-444-7680; Fax: 617-444-2803
For More Information Write In No. 381

DYNAMIC SIGNAL ANALYZER

Using DSP boards, the DP420 converts your PC into a precision instrument for measurements such as:



TRANSIENT CAPTURE
SYNCHRONOUS AVERAGE
RUNUP AND COASTDOWN WATERFALLS
ORDER TRACKING
TRANSFER FUNCTION and COHERENCE
REALTIME ZOOM
CORRELATION
ACOUSTIC INTENSITY
REALTIME 1/3 OCTAVE ANALYSIS
SHOCK RESPONSE SPECTRUM

DATA PHYSICS CORPORATION

1190 S. Bascom Ave, Suite 220, San Jose, CA 95128
Tel: 408-977-0800; Fax: 408-977-0801
For More Information Write In No. 382

DIGITAL SHAKER CONTROLLER

DP540 Vibration Controllers use DSP boards in your PC for high performance at low cost.



RANDOM
SINE
SHOCK
SRS
SINE on RANDOM
RANDOM on RANDOM
FFT MEASUREMENTS

DATA PHYSICS CORPORATION

1190 S. Bascom Ave, Suite 220, San Jose, CA 95128
Tel: 408-977-0800; Fax: 408-977-0801
For More Information Write In No. 383

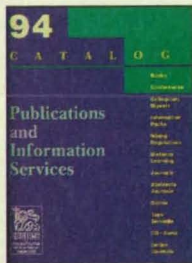

INSPEC AND THE IEE COMBINE CATALOG

INSPEC Publications and Services, Abstracts Journals, Online Database, Tape Services, CD-ROM, IEEE/IEE Periodicals Ondisc (IPO) are featured along with the Books, Conference Proceedings, Professional Journals and Distance Learning (Video and CBT) materials of the Institution of Electrical Engineers (IEE). Tel: 908-562-5553; Fax: 908-981-0027.

IEE/INSPEC

For More Information Write In No. 384

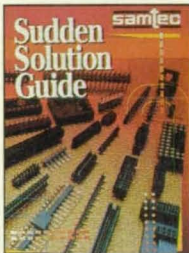

FULL LINE SAMTEC CATALOG

Samtec's new Full Line Catalog F-193 includes complete ordering information and specifications on many new interconnects. Micro, surface, board-to-board, IDC cable assemblies and custom design capabilities are shown. A

new sixteen page full color interconnect applications section is included. Samtec, Inc. P.O. Box 1147, New Albany, IN 47151-1147. Tel: 800-SAMTEC-9 (800-726-8329) Fax: 812-948-5047.

Samtec, Inc.

For More Information Write In No. 385



SPRING POWER DESIGN LITERATURE

Ametek Hunter Spring Bulletin FS-201 provides complete descriptive and technical data for broad line of stock and custom spring powered devices. Product information covers SPIR'ATOR prestressed spiral springs, NEG'ATOR constant force extension springs and spring motors, as well as other power spring packages and stock mechanical reels. Tel: 215-257-6531; Fax: 215-257-4711.

AMETEK U.S. Gauge Division

For More Information Write In No. 386

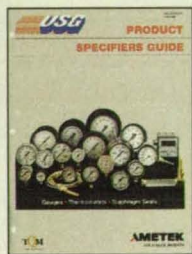

PRECISION INSTRUMENTS

AMETEK U.S. Gauge Division offers a complete line of process gauges for the CPL...critically accurate test gauges for lab calibration...liquid filled gauges for corrosion and vibration resistance...LVDT pressure transducers...and digital electronic temperature

instrumentation. U.S. Gauge is a global TQM manufacturer with products supported by a worldwide network of stocking distributors. AMETEK U.S. Gauge Division, Sellersville, PA 18960. Tel: 215-257-6531; Fax: 215-257-4711.

AMETEK U.S. Gauge Division

For More Information Write In No. 387



BRUSHLESS DC MOTORS

This new, standard line is developed around 2.0" and 3.2" diameter lamination sizes. Motors are available in different stack lengths to meet a wide performance range. This line features minimal tooling, Hall Effect switches, and a variety of motor lengths and torque ranges. The eight-pole/12-slot motors accept 12-40 VDC input power. Applications include medical devices, business machines, and computer peripherals. AMETEK Technical Motor Division, 627 Lake Street, Kent, OH 44240. Tel: 216-673-3452; Fax: 216-678-8227.

AMETEK Technical Motor Division

For More Information Write In No. 388

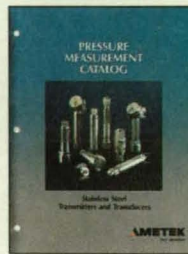

STAINLESS STEEL TRANSMITTERS AND TRANSDUCERS

AMETEK PMT Products Group offers a full line of transmitters and transducers to provide pressure measurement solutions to a variety of industries and applications. These products combine complete stainless steel construction with solid state sensor technology resulting in reliable, cost effective performance. AMETEK, PMT Products Group, 820 Pennsylvania Blvd. Feasterville, PA 19053. Tel: 215-355-6900; Fax: 215-355-2937.

AMETEK, PMT Products Group

For More Information Write In No. 389



MAXIMUM FLEXIBILITY IN RESIDUAL GAS ANALYSIS

Dycor™ System 1000 quadrupole mass spectrometer features an intuitive graphical interface, providing maximum versatility in an RGA. The system provides a variety of operating modes, plus a custom mode, with-out the need for programming. 150 Freepoint Road, Pittsburgh, PA 15238. Tel: 412-828-9040. Fax: 412-826-0399.

AMETEK, Process & Analytical Instruments Division

For More Information Write In No. 390

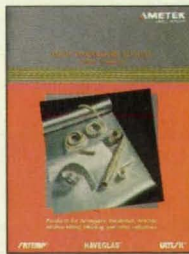

HIGH TEMPERATURE SILICA TEXTILES

Haveg high temperature textiles are available in fabric rolls, sleeving, rope, tape, and mat configurations. Many applications in aerospace, shipbuilding, foundry, power generation, and other industries. Free brochure provides complete data. 900 Greenbank Road, Wilmington, DE 19808. Tel: 302-995-0400. Fax: 302-995-0491.

AMETEK, Haveg Division

For More Information Write In No. 391

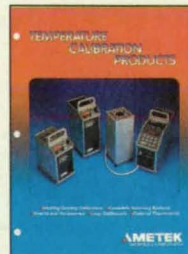

CALIBRATE TEMPERATURE ACCURATELY

FREE bulletin spotlights complete line of dry block temperature calibrators (ranges from -58 °F to 253 °F through 392 °F to 2200 °F), loop calibrators, calibration systems and accessories; also lists applications, product specifications/dimensions. 8600 Somerset Drive, Largo, FL 34643. Tel: 813-536-7831. Fax: 813-539-6882.

AMETEK, Mansfield & Green Division

For More Information Write In No. 392

Linear Motion Systems

New 100-page guide features complete product and engineering information for selection, ordering and installation of pre-engineered, pre-assembled Thomson systems. Covered are precision, ready-to-install systems available with single or parallel shafts, with or without table tops, or with shafts aligned in parallel. Data describes Powerslide® slide-drive-control systems, Superslide® ball screw-actuated systems, and Twin Shaft® slide systems.

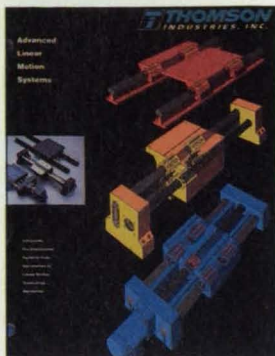

Thomson Industries,
Port Washington, NY 11050.
(1-800-554-8466)

For More Information Write In No. 520

Linear Bearings and Components

Complete catalog of Thomson linear bearing systems features Ball Bushing® bearings; XR® extra-rigid Ball Bushing bearings; Roundway® linear roller bearings; 60 Case® hardened and ground LinearRace® shafting; instrument and metric bearings; pillow blocks; shaft supports; seals; and bearing accessories. Sections cover travel life, load capacities, shaft mounting and alignment, clearance, installation and lubrication.



Thomson Industries,
Port Washington, NY 11050.
(1-800-554-8466)

For More Information Write In No. 527

Ball Screws

This 44-page guide is a complete source of information on Thomson Saginaw® ball screw actuators including rolled thread assemblies, precision ground thread assemblies, electromechanical linear actuators and ball splines. It includes product descriptions, applications, specifications, design and selection criteria and mounting instructions.



Thomson Saginaw Ball Screw Co.,
628 N. Hamilton, Saginaw,
MI 48602.
(517-776-5111)

For More Information Write In No. 522

Engineered Polymer Bearings

Designer's guide includes new technical data to make it easy to select, specify and apply Thomson Nyliner® bearings. It includes Nyliner bearing descriptions, application examples, dimensional drawings, specifications and test data, and installation and operating information. Guide also contains section on new Nyliner Plus® family of bearings made of advanced thermoplastics.



Thomson Industries,
Port Washington, NY 11050.
(1-800-554-8466)

For More Information Write In No. 525

Steel Shafting

Complete specifications help readers select and apply 60 Case® hardened and ground LinearRace® shafting from 3/16 - 4 in. diameter. Shafting covered provides straightness, hardness and smoothness needed for optimum Thomson system performance. Specifications include Rockwell 60-65C hardness, straightness 0.001-0.002 in./ft., and 10-16 in. rms finish. Included are machining standards, applications, mounting, and installation.



Thomson Industries,
Port Washington, NY 11050.
(1-800-554-8466)

For More Information Write In No. 524

NEW AccuGlide/AccuMax

AccuGlide® Ball Bearing Systems provide high load capacities in all directions. Applications include lathes, milling machines and machining centers. For wafer processing equipment, optical insertion equipment and electronic instrumentation, consider AccuGlide Miniature Systems. AccuMax® Roller Bearing Systems offer up to twice the load capacity of equal-sized ball bearing systems for dramatic improvement in system life, and reduction in maintenance.



Thomson Industries,
Port Washington, NY 11050.
(1-800-554-8466)

For More Information Write In No. 523

NEW Metric Ball Screws

New Engineering design and selection guide for Thomson Saginaw® metric precision ball screw assemblies. Provides complete information on Precision and Precision Plus® metric ball screws, including product specifications, design and selection criteria, mounting instructions, and applications. Catalog also describes related products and services such as Performance Pak® Actuators, end machining, and repair/reconditioning services.

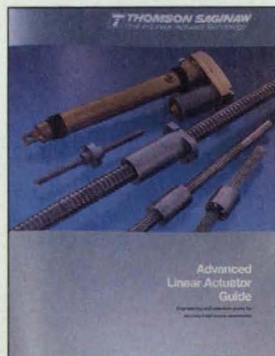

Thomson Saginaw Ball Screw Co., 628 N. Hamilton, Saginaw,
MI 48602. (517-776-5111)

For More Information Write In No. 526

Metric Components

This catalog provides design and ordering information on Thomson Industries' full range of metric linear motion components. Products include Super Plus® Ball Bushing® bearings and pillow blocks, Roundway® II bearings, 60 Case® hardened and ground LinearRace® shafting, and accessories. Complete engineering support information is included.

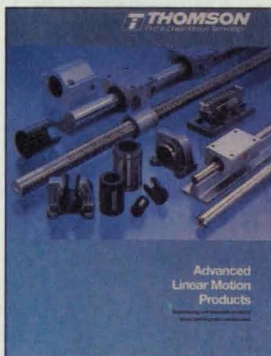

Thomson Industries,
Port Washington, NY 11050.
(1-800-554-8466)

For More Information Write In No. 521

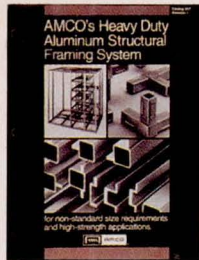

HEAVY DUTY ALUMINUM STRUCTURAL SYSTEM

AMCO offers Heavy Duty Aluminum Structural System for complex design applications. Easy to assemble, welding not required. The system includes high-strength extruded tubing with different integral flange configurations. 3 types of accessory mounting channels; 8 joining and corner castings and more.

AMCO Engineering Company

For More Information Write In No. 405

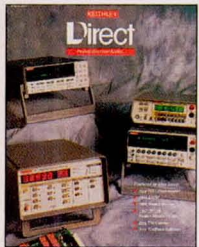

NEW KEITHLEY-DIRECT CATALOG

Keithley Instruments is offering its new direct marketing catalog of selected test instruments and accessories. Many of the company's DMMs, switches, source-measure units and

accessories are included. One of the featured products in this issue is a new electrometer. Call 1-800-552-1115 for your free copy. Keithley Instruments, Inc. 28775 Aurora Rd., Solon, OH 44139

Keithley Instruments, Inc.

For More Information Write In No. 408

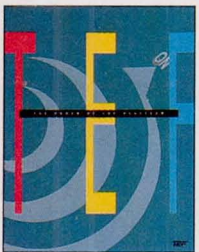

DSP-EQUIPPED ANALYZERS

Color brochure provides detailed overview of DSP-equipped acoustical analyzers with information on how to obtain a free demo disk and specific application information. The TEF20 platform combines specialized software with a PC to perform accurate electroacoustical tests.

Techron—TEF Products

1718 West Mishawaka Road, Elkhart, IN 46517

Tel: 219-294-8295.

For More Information Write In No. 411

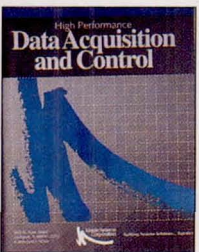

HIGH PERFORMANCE DATA ACQUISITION

FREE 100+ page book from experts in test and measurement field. Topics include: What bus structure do you really need (VXI, VME, CAMAC...)?; Data quality: how good is good enough?; Antialias filtering: what are the trade-

offs?; All 16-bit systems are not created equal; Software wars—test plans in 5 minutes?

KineticSystems Corporation

Tel: 800-DATA-NOW; Fax: 815-838-4424

For More Information Write In No. 414



Physical Sciences

Noncontact Electromagnetic Vibration Source

Metal aircraft skins can be scanned rapidly in vibration tests.

Langley Research Center, Hampton, Virginia

A relatively simple combination of permanent magnets and an electromagnet serves as a noncontact vibration source for nondestructive testing of metal aircraft skins. In a nondestructive test of this kind, the source excites vibrations, and the vibration waveforms are measured, then analyzed for changes in resonances that signify cracks and other flaws. Unlike older contact electromagnetic vibration sources that included permanent magnets attached to the skins under test, this noncontact source can be scanned rapidly across the skins.

As shown in the top part of the figure, the source includes an electromagnet coil wound on an inverted U-shaped ferrite core. Permanent magnets (e.g., cobalt/samarium) are attached to the core to produce a static magnetic field. The faces of the permanent magnets are made convex to spread out the static magnetic fields so that when the source is brought close to a metal skin, the static magnetic field lines have substantial

components in the surface plane of the skin that radiate outward from the surface spots that face the magnetic poles. The ends of the ferrite core are made concave to keep the electromagnetic field lines that enter the surface as nearly perpendicular as possible to the surface.

The electromagnet coil is excited with a sinusoidal or other suitable waveform to generate an alternating electromagnetic field, which induces eddy currents in the metal skin. In the magnetic-field configuration described above, the eddy currents flow approximately circularly, in and near the surface plane, around the spots that face the poles, as shown in the middle part of the figure. The eddy currents interact with the outward-radiating components of the static magnetic fields, the resulting Lorentz force being perpendicular to the surface plane of the skin. This force causes the desired vibration.

The direction of the force (into or out of the skin) exerted by each pole

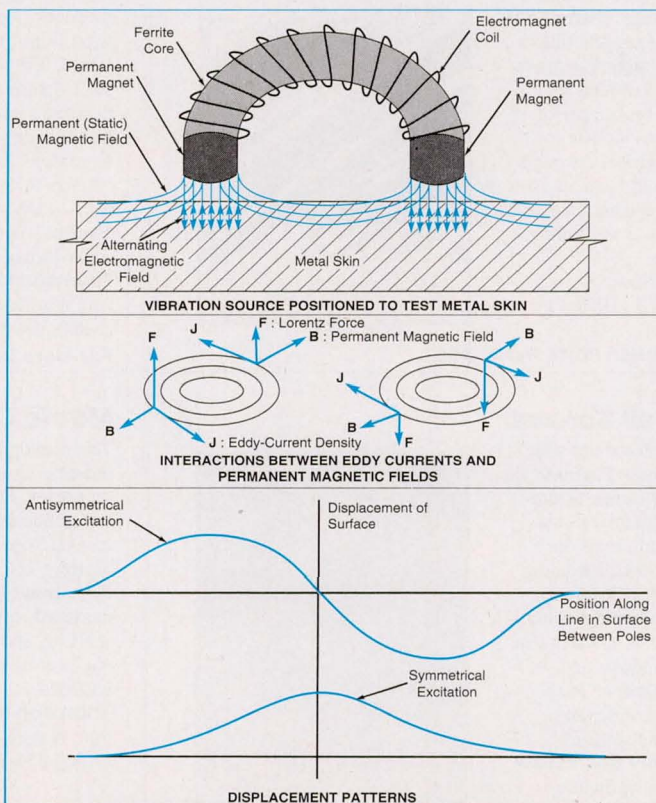

The Electromagnet Induces Eddy Currents that interact with the permanent magnetic field to produce forces perpendicular to the surface of the metal skin. By choice of the relative polarities of the permanent magnets, the forces can be made parallel (for symmetrical excitation) or antiparallel (for antisymmetrical excitation).

SIXTH SENSE

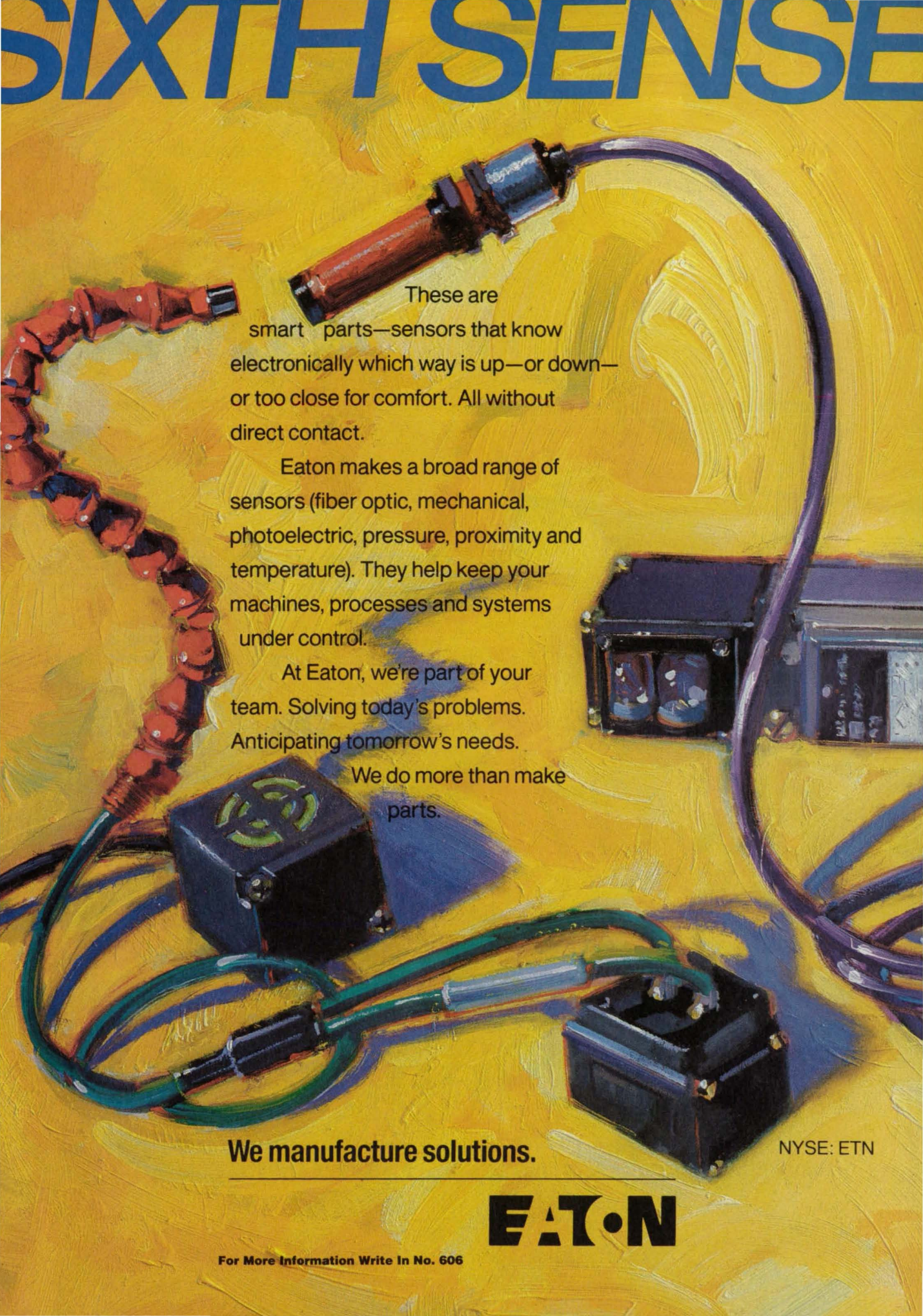

These are smart parts—sensors that know electronically which way is up—or down—or too close for comfort. All without direct contact.

Eaton makes a broad range of sensors (fiber optic, mechanical, photoelectric, pressure, proximity and temperature). They help keep your machines, processes and systems under control.

At Eaton, we're part of your team. Solving today's problems. Anticipating tomorrow's needs.

We do more than make parts.

We manufacture solutions.

NYSE: ETN

EATON

For More Information Write In No. 606

More than any other manufacturer, Eurocopter offers operators the widest range of



Everything from the powerful new AS 350BA Ecureuil, to the remarkably versatile BK 117,



Ecureuil AS 355

technologies and aircraft configurations across our entire product line. That means the

BK 117



mission requirements. And the confidence instilled by the largest worldwide network of



Super Puma

flying Eurocopter, please contact our Civil Marketing Department.

advanced technology helicopters to carry out their civil and public service assignments.

Ecureuil AS 350

to the heavy-lift 10-ton Super Puma L2. Closer inspection will reveal important new



BO 105

opportunity to choose a helicopter that meets, and surpasses, your most challenging

Dauphin



maintenance and customer support centers. To learn more about the advantages of

**Freedom of choice for commercial and
public service operators worldwide.
By Eurocopter.**



Eurocopter International - 10, av. Marcel-Cachin - BP 107 - 93123 La Courneuve Cedex - France
Tel.: 33 (1) 49 34 44 78 - Fax: 33 (1) 49 34 41 04

For More Information Write In No. 654

depends on the relative directions of the eddy currents and the static magnetic fields. Thus, by suitable choice of the polarities of the permanent magnets, both poles can be made to push or pull simultaneously to produce a symmetrical excitation, or else one can be made

to push while the other pulls to produce an antisymmetrical excitation, as shown in the bottom part of the figure.

This work was done by Min Namkung of **Langley Research Center** and James P. Fulton and Buzz A. Wincheski of *Analytical Services and Materials, Inc.*

For further information, **write in 104** on the TSP Request Card.

Inquiries concerning rights for the commercial use of this invention should be addressed to the Patent Counsel, Langley Research Center [see page 20]. Refer to LAR-14914.

Temperature-Control Apparatus for Hydrogen Maser

A maser can be operated in air with acceptable thermal stability.

Marshall Space Flight Center, Alabama

A thermal-control apparatus maintains a hydrogen maser at nearly constant temperature (typically, 20 or 25°C) during a long-term operational test. More specifically, the apparatus is designed to maintain, in a small cylindrical vacuum tank that contains the maser, a nearly isothermal condition (at the chosen operating temperature) when the test is conducted in air. The apparatus provides an approximation of the more nearly isothermal condition (within $\pm 10\text{--}3^\circ\text{C}$) that is expected to be maintained in the intended application, in which the maser would be operated in a vacuum environment and losses of heat would be reduced further by multilayer reflective insulation.

The apparatus (see figure) includes three heaters mounted on the vacuum tank: one on each end and one on the side. Two outer end and two outer side heaters surround the vacuum tank and its heaters, forming an outer oven. A thermistor measures the temperature of each heated surface and thereby provides temperature feedback. Thus, there are seven heaters and the associated thermistors, which define seven thermal-control zones.

The heaters are connected mechani-

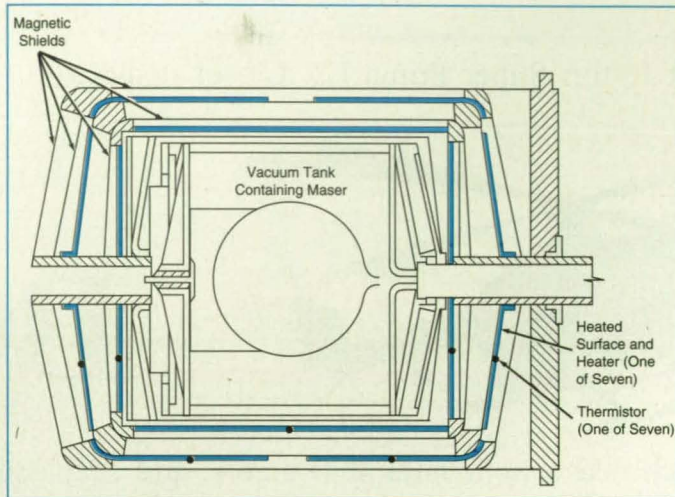

The **Temperature-Control Apparatus**, shown here in simplified form, is integrated with the maser structure. Two layers containing heaters and thermistors are interleaved with magnetic shields and with reflective multilayer insulation, which is omitted for clarity.

cally to supports for magnetic shields, and the heaters and magnetic shields are arranged in interleaved layers. The spaces between the layers are filled with multilayer reflective insulation. In air, the multilayer insulation is much less effective than it is in vacuum, and the flow of heat through this insulation in air is comparable to that through the other parts of the maser structure. The outer heaters make up for the heat thus lost, thereby helping to stabilize the temperature.

This work was done by R. F. C. Vesot and E. M. Mattison of the *Smithsonian Astrophysical Observatory* for **Marshall Space Flight Center**. For further information, **write in 81** on the TSP Request Card.

Inquiries concerning rights for the commercial use of this invention should be addressed to the Patent Counsel, Marshall Space Flight Center [see page 20]. Refer to MFS-26222.

Two-Zone Bridgman Furnace With Sharp Thermal Gradient

Temperature gradients up to 125 °C/cm can be achieved in the crystal-growth region.

NASA's Jet Propulsion Laboratory, Pasadena, California

A two-zone vertical directional-solidification furnace has been designed and built to grow crystals from stoichiometric and nonstoichiometric melts and from solutions. The furnace includes a conventional wire heater in the lower zone, a tubular silicon carbide heating element in the upper zone, and a thermal baffle between the zones (see figure).

The furnace provides a sharp vertical gradient of temperature between the two zones: a gradient of 42°C/cm has been achieved, and gradients of as much as 125°C/cm are anticipated. Crystals grow in this temperature-gradient region, and a sharper gradient enables both faster growth and better separation between solid and liquid.

The furnace can be used in a laboratory or industrial setting for growth of crystals from congruently melting materials as well as for growth of compounds formed by peritectic reactions.

The silicon carbide and wire heaters are both relatively inexpensive, readily available commercial items. The maximum temperatures that can be achieved

The Finest Quality Microminiature Color Camera!



Toshiba's engineers have created the industry's most advanced microminiature color camera which uses the latest ultrasensitive CCD imager and provides twice the light sensitivity for the highest resolution available.

Our new IK-M41A camera uses *breakthrough microlens technology* to give you crisp, clear images even in very low light, and in very small spaces. The IK-M41A has minimum illumination of only 5 lux (F1.6) and more than 470-line horizontal resolution, at 48dB signal-to-noise ratio. And, its compact profile (1 1/2" long, 5/8" diameter) lets you use it almost anywhere, up to 100 feet from the CCU.

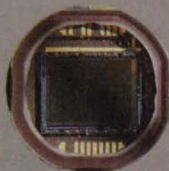

The IK-M41A's newly developed electronic light control enables it to automatically adjust for light intensity. It offers both a selectable electronic shutter (1/60 to 1/10,000 second) and a full *Auto-shutter to 1/50,000 second*, controlled by a new exclusive TOSHIBA ASIC. And in addition to composite and S-video, *RGB output* provides enhanced color fidelity and purity.



For details on Toshiba's IK-M41A, call 1-(800)253-5429 ext. 397.

In Touch with Tomorrow
TOSHIBA

TOSHIBA AMERICA C. P., INC., IIT Group, 1010 Johnson Drive, Buffalo Grove, Illinois 60089-6900

For More Information Write In No. 640

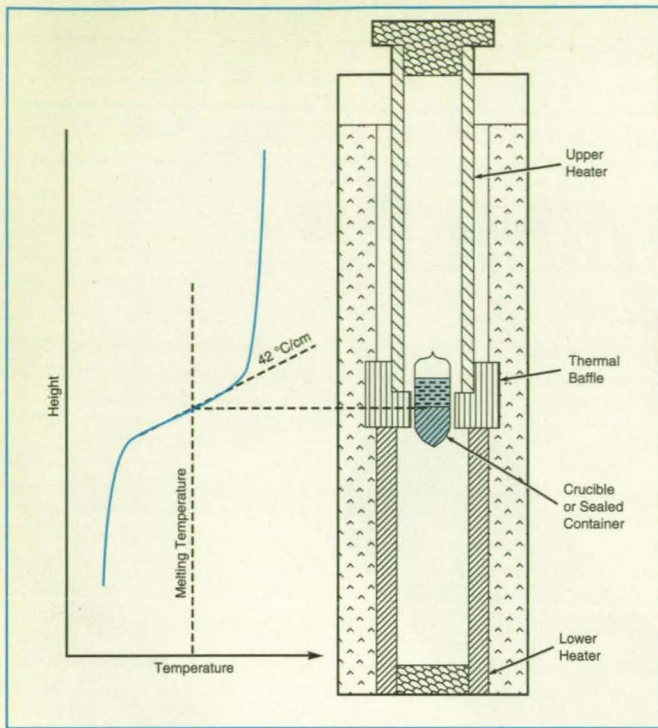

This **Two-Zone Bridgman Furnace** provides a sharp gradient of temperature for faster directional solidification and better separation between solid and liquid.

tial experiments had diameters no greater than 12 mm, and the heights of the melts in the containers ranged from 30 to 40 mm.

During crystallization, the container remains stationary while the temperatures in the two zones are decreased by a temperature-control circuit with feedback from a differential thermocouple. The controller decreases the temperatures with time in such a way as to maintain the gradient of temperature constant during the crystal-growth process. The typical temperature profile shown in the figure was measured by placing a monitoring thermocouple in the middle of a mockup of a crucible during calibration of the furnace.

The furnace has been used to grow very unusual peritectically formed compounds from melt solutions. Because of the sharp gradients of temperature, the separation from solution of single crystals of such grown materials as $\text{Cr}_{11}\text{Ge}_{19}$ and RuSb_2 was perfect.

This work was done by Alex Borshchevsky, Thierry Caillat, and Jean-Pierre Fleurial of Caltech for NASA's Jet Propulsion Laboratory. For further information, write in 74 on the TSP Request Card. NPO-18813

are $1,400^{\circ}\text{C}$ in the upper zone and $1,000^{\circ}\text{C}$ in the lower zone. An axial orifice in the thermal baffle accommodates a crucible or sealed container that contains the material to be grown. The baf-

file helps to prevent intensive convection of air (or other gas) between the upper and lower zones; such convection can uncontrollably change the gradient of temperature. The containers used in ini-

ATTENTION GOVERNMENT, INDUSTRY, AND UNIVERSITY TECHNOLOGY LEADERS:

You are invited to answer this

CALL FOR PAPERS

Over 8000 corporate executives, project leaders, design engineers, and technology acquisition managers are expected to attend Technology 2004, the world's largest tech transfer conference and exposition, to discover technology advances they can use in developing products or improving their manufacturing/production processes.

Who Should Present Papers

Researchers from federal agencies/laboratories and their contractors who have produced important new technologies that are available for commercial use.

Paper Categories

Papers should describe innovations developed by or for a government agency/laboratory in one of the following categories: Advanced Manufacturing, Artificial Intelligence, Biotechnology, Computer Hardware, Computer Software, CAD/CAE/CASE, Environmental Technology, Electronics, Life Sciences, Materials Science, Medical Techn-

TECHNOLOGY 2004

November 8-10, 1994
Washington, DC Convention Center

ology, Simulation/Virtual Reality, Video/Imaging, Power & Energy, Robotics, Test & Measurement.

Deadline For Submission

Paper abstracts must be submitted to the Program Chairman no later than April 29, 1994. They should be 1 to 1-1/2 pages long and must describe the technology's novelty and commercial potential (see abstract format). All submitters will be notified by June 30, 1994. Mail or fax abstracts to:

Leonard A. Ault, Program Chairman
Technology 2004
Code CU, NASA Headquarters
300 E St. SW, Washington, DC 20546
FAX: (202) 358-3938

PLEASE FOLLOW THIS FORMAT:

Technology 2004
Paper Abstract

Name: (if multiple authors, please provide the name of main contact to whom correspondence should be addressed)

Position/Title:

Affiliation:

Address:

Phone Number:

Fax Number:

Govt. Agency/Lab The Subject Technology Was Developed By/For:

(if contractor-developed, please include contract #)

Paper Title:

Category:

Description:

Questions? Call Leonard Ault at (202) 358-0721 or Michael Hackett at (202) 728-2080.

WE'VE EXAGGERATED HOW MUCH CALCULATING POWER IS IN NEW MATHCAD PLUS 5.0. BUT ONLY SLIGHTLY.

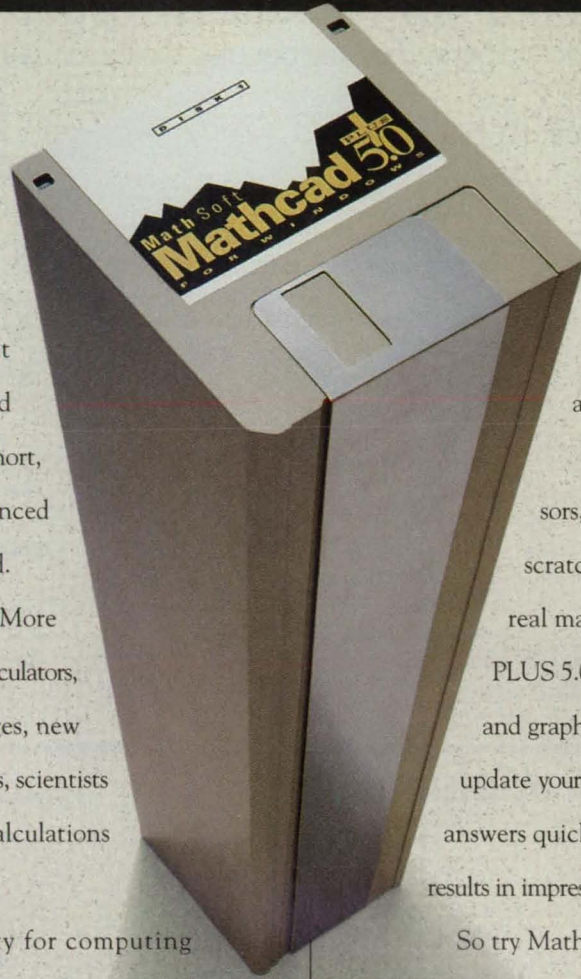

It gives you more advanced math capability than ever before. It lets you tackle harder problems and solve even tougher equations. In short, it's the most powerful, most advanced version of Mathcad® ever released.

And that's no exaggeration. More powerful than spreadsheets or calculators, easier than programming languages, new Mathcad PLUS 5.0 gives engineers, scientists and educators more tools to do calculations with greater speed and ease.

You get more functionality for computing derivatives and integrals, differential equations, advanced vector and matrix operations, statistical functions, curve fitting, and fast Fourier and wavelet transforms. You can choose from a wider range of symbolic capabilities, and

graph in 2-D and 3-D polar, contour and parametric plots. MathSoft's Electronic Books, based on the most popular reference books, let you

instantly cut and paste hundreds of formulas into your work. And with Mathcad PLUS Function Packs you can add even more remarkable

calculating power in specific disciplines like signal processing, data analysis, statistics and graphics.

Plus, like its Mathcad predecessors, it's as easy and intuitive as using a scratchpad. Simply enter equations in real math notation anywhere on Mathcad PLUS 5.0's on-screen worksheet. Add text and graphics. Change variables and instantly update your work. Mathcad PLUS 5.0 calculates answers quickly and accurately, then prints your results in impressive, presentation-quality documents.

So try Mathcad PLUS 5.0 today, and tomorrow you'll be ten times more productive. Well, maybe we're exaggerating again. But only slightly. Mathcad PLUS 5.0 is priced at just \$299²⁵. To order, or to receive even more information, call [1-800-967-5075](tel:1-800-967-5075). Or mail or fax the coupon below (Fax: 716-873-0906).

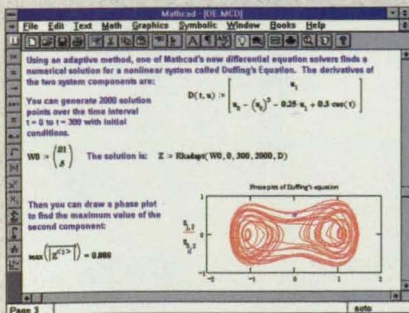

Mathcad PLUS 5.0's on-screen worksheet lets you easily combine equations, text and graphics.

Mathcad PLUS 5.0's on-screen worksheet lets you easily combine equations, text and graphics.

FREE MATHCAD PLUS 5.0 INFORMATION KIT

For more information on Mathcad PLUS 5.0, mail or fax this coupon.

Name	Title	45a2
Company		
Address		
City		
State	Zip	
Country	Phone	

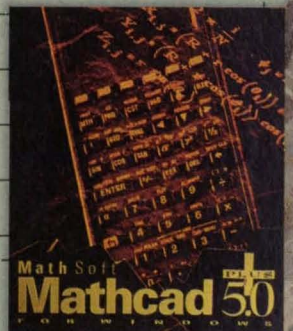

MathSoft, Inc. P.O. Box 1018, Cambridge, MA 02142-1519 USA • Phone: 1-800-967-5075 • Fax: 716-873-0906 • MathSoft Europe, P.O. Box 58, Livingston, UK EH54 7AE
Phone: +44.506.460373 • Fax: +44.506.460374 © 1994 MathSoft, Inc. TM and ® signify manufacturer's trademark or registered trademark respectively. *Dealer price may vary.

For More Information Write In No. 650



Lightweight Electrode for Nickel/Hydrogen Cell

A nickel/hydrogen cell using nickel-fiber electrodes doubles the specific energy per unit weight of the state-of-the-art cell.

Lewis Research Center, Cleveland, Ohio

An improved substrate for a nickel electrode increases the specific energy of a nickel/hydrogen cell. The substrate consists of 50 percent by weight nickel fiber, 35 percent nickel powder, and 15 percent cobalt powder. Porosity and thickness of nickel electrodes affect the specific energy, initial performance, and cycle life of the nickel/hydrogen cell. One advantage of the nickel-fiber substrate over the state-of-the-art (SOA) nickel substrate it replaces is that the new nickel-fiber substrate can be easily manufactured with much larger porosities than those of the heavy-sintered SOA nickel substrate. The nickel fiber structures are commercially available in porosities up to 98 percent, while SOA nickel

substrates are available in porosities of 80 to 86 percent.

An electrode made with the improved substrate can be discharged deeply (by 40 percent or more of the electrode capacity). It weighs less than does the heavy-sintered SOA nickel substrate, which is the heaviest component in a nickel/hydrogen cell. As a result, a cell built around the lightweight substrate has a specific energy 2.0 times that of a cell built around the heavy-sintered SOA nickel substrate.

The improved substrate is electrochemically impregnated with the nickel hydroxide active material in an aqueous solution of nickel nitrate, cobalt nitrate, and sodium nitrite. The electrode thus

formed is conditioned by seven charge/discharge cycles in a 26-percent solution of potassium hydroxide. The electrode acquires a nickel hydroxide load of at least 1.6 grams per cubic centimeter of its void volume.

Initial performance and cycle life testing of a boilerplate nickel/hydrogen cell, at a 40-percent depth-of-discharge, using a nickel fiber electrode, is very promising. The nickel electrode was made from a thick [80 mil (2.0 mm)] and highly porous (90-percent) nickel-fiber substrate.

This work was done by Doris L. Britton of Lewis Research Center. For further information, write in 77 on the TSP Request Card. LEW-15053

Spherical Perfluoropolyethers

These "molecular ball bearings" may offer high thermal stability and lubrication properties.

Lewis Research Center, Cleveland, Ohio

Four fluorocarbon compounds of the generic class C(CF₂OR)₄ [where R = CF₃, C(CF₃)₃, CF₂CF₃, or CF₂CF₂CF₃] (see figure) have been synthesized by direct fluorination of the corresponding hydrocarbons. The molecules of these compounds are approximately spherical and may act as "molecular ball bearings." In addition to their potential utility as lubricants, these compounds are expected to be thermally stable and useful as heat-transfer fluids or even vapor-phase-soldering fluids.

This work was done by Richard J. Lagow of the University of Texas at Austin for **Lewis Research Center**. For further information, **write in 85** on the TSP Request Card. LEW-15151

These **Four Perfluorinated Ethers** may have potential as lubricants, heat-transfer fluids, and/or vapor-phase-soldering fluids.

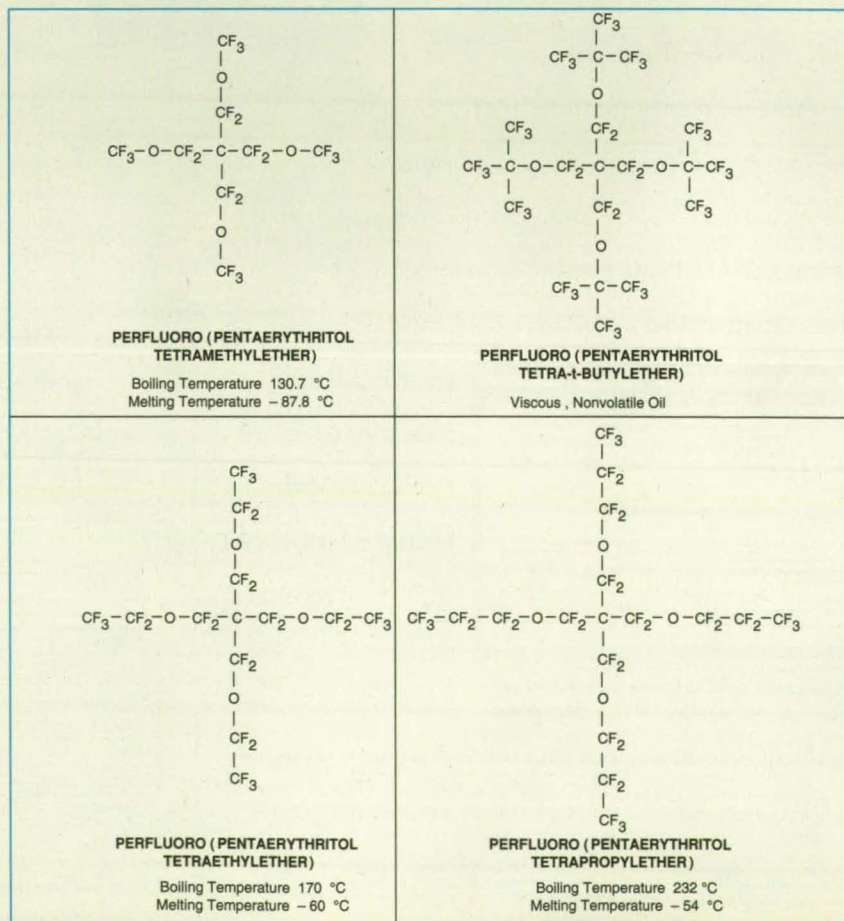

HERE'S A BIG IDEA THAT'S ONLY ONE MICRON THICK!



Novamet HCA-1 Conductive Nickel Flake

Novamet HCA-1 Conductive Nickel Flake is Novamet's biggest selling conductive pigment. And for a very good reason. It is so conductive. Usually 0.1 ohm surface resistivity in dried acrylic surface coatings. Want a big idea for your resin...try Novamet HCA-1 Conductive Nickel Flake. For a free sample and data sheet, write to Novamet today.



Novamet Specialty Products Corporation
10 Lawlins Park, Wyckoff, NJ 07481
(201) 891-7976, Fax (201) 891-9467

For More Information Write In No. 652

Low-Toxicity PMR Polyimide

This readily processed, high-performance resin is made with a less toxic diamine.

Langley Research Center, Hampton, Virginia

PMR-type polyimides formed by in situ polymerization of monomer reactants constitute an important class of ultra-high-performance composite matrix resins. Composite materials made of these resins reinforced by graphite fibers are being used increasingly in various aircraft engine components, which operate at temperatures that range from 232 to

371°C for long times. PMR-15 (15 stands for a formulated molecular weight of 1500 between cross-links) is the best-known and most-widely-used PMR polyimide. Its attributes include relatively easy processing, substantially lower costs, and excellent retention of properties at elevated temperatures. This material is prepared from an alcohol solution of three

monomers: the monomethyl ester of 5-norbornene-2,3-dicarboxylic acid (NE), 4,4'-methylenedianiline (MDA), and the dimethyl ester of 3,3',4,4'-benzophenonetetracarboxylic acid (BTDE).

However, in recent years, the health and safety problems posed by MDA and polymers derived from this diamine have become of great concern. On the basis of extensive test data, the National Institute of Occupational Safety and Health recommends that MDA be considered a potential occupational carcinogen, making PMR-15 less acceptable. Attempts have been made to replace the MDA in PMR-15 with a less toxic diamine. However, none of the resulting products demonstrates the desired combination of characteristics, such as ease of processing and high retention of mechanical properties at elevated temperatures.

A new, low-toxicity PMR system has been developed at NASA Langley Research Center and designated LaRC-RP46. This system incorporates 3,4'-oxydianiline (3,4'-ODA), which has been found to exhibit no detectable mutagenicity. LaRC-RP46 is a substantially improved high-temperature PMR system that exhibits better processability, toughness, and thermo-oxidative stability than does PMR-15, and has a low toxicity. LaRC-RP46 is prepared by reacting NE, 3,4'-ODA, and BTDE (see figure). Besides being potentially less toxic than MDA, 3,4'-ODA contains an ether linkage coupled with a meta isometric amine group, which causes it to be extremely flexible. When this flexible diamine is incorporated into the backbone of the PMR polyimide, the resin exhibits good flow properties, which, in turn, improve processability. This polyimide is extremely stable, and its flexibility imparts toughness.

This polyimide is relatively inexpensive and readily processed into a high-quality graphite-fiber-reinforced composite. The composite material retains excellent mechanical properties at 316°C, even after service for several hundred hours, and at 371°C. This new material can be used as a high-performance, high-temperature-resistant adhesive, molding, composite, film, and coating material where low toxicity is a desired characteristic. It should significantly extend the applications of PMR-type polyimides.

This work was done by Ruth H. Pater, Robert M. Ely, Clarence E. Stanfield, George E. Dickerson, and John J. Snoha of **Langley Research Center**; Krishna

PROBLEM?

SOLDERING

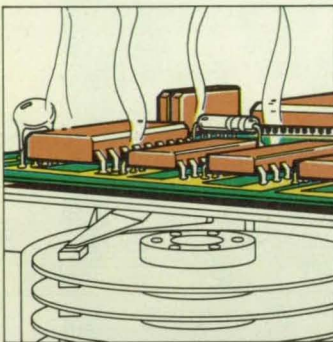

SEALING

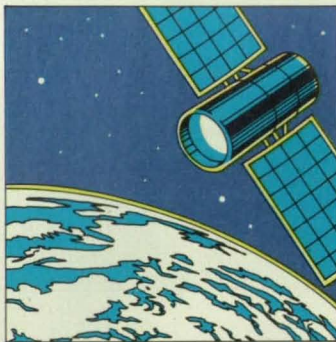

SEMICONDUCTING

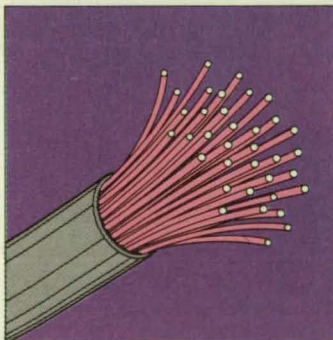

COATING

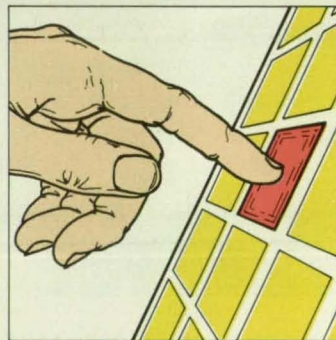

SOLUTION...

In 114.82
49 Indium, the low-melting temperature metal, could be the solution to your R&D problem.

If you're involved with any of the above applications, you can find a use for indium, the shiny, semi-precious, non-ferrous metal that can be supplied at 99.99999%+ purity as indium salts, oxides, chemical, and indium-based alloys.

For more technical information, call or write to us at 400 Harris Ave., Providence, RI 02909, Phone: 401-456-0800, Toll free: 800-343-0282, Fax: 401-421-2419.

ARCONIUM
YOUR INDIUM RESOURCE.

For More Information Write In No. 451

COLE-PARMER
INSTRUMENT COMPANY

1993 - 1994



**The 1993-94 Cole-Parmer
Catalog is yours...**

FREE!

To order your free catalog,
just fax back the coupon below.

(708) 647-9660

This 1536-page
resource offers more
than 35,000 products
for your research,
industrial, and
educational needs.

To place an order,
obtain technical assistance,
or learn more about our
NEW products, dial (800) 323-4340.



INSTRUMENTS
FOR RESEARCH,
INDUSTRY,
AND EDUCATION

CALL TOLL-FREE:
(800) 323-4340

If coupon is missing,
circle 0000.



Cole Parmer® Instrument Company
7425 N. Oak Park Ave. ❖ Niles, IL 60714



Send us the "FAX" to get your FREE Cole-Parmer Catalog!

Name: _____ Title: _____

Company: _____

Address: _____

City: _____ State: _____ Zip: _____

Telephone: _____ Fax: _____

FAX: (708) 647-9660



Cole Parmer® Instrument Company
7425 N. Oak Park Ave. ❖ Niles, IL 60714

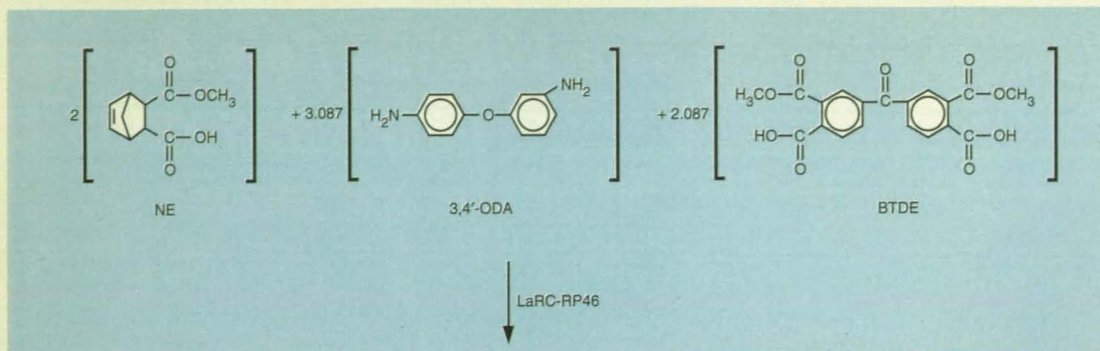

The **High-Performance Polyimide LaRC-RP46** is made with 3,4'-ODA, which is less toxic than was the MDA used to make PMR-15 polyimide.

Srinivasan of Old Dominion University; and Tan Hou of Lockheed Engineering & Sciences Co. For further information, **write in 39** on the TSP Request Card.

This invention has been patented by NASA (U.S. Patent No. 5,171,822). Inquiries concerning nonexclusive or exclusive license for its commercial devel-

opment should be addressed to the Patent Counsel, Langley Research Center [see page 20]. Refer to LAR-14639.

Acetylene- and Phenylacetylene-Terminated Poly(Arylene Ether Benzimidazole)s (PAEBI's)

These polymers have properties superior to those of many other high temperature polymers including other PAEBI's.

Langley Research Center, Hampton, Virginia

Acetylene(ethynyl)- and phenylacetylene(phenylethynyl)-terminated arylene ether benzimidazole polymers can be prepared by first synthesizing polymers terminated with hydroxy groups, then reacting them with either 4-ethynylbenzoyl chloride or 4-fluoro-4'-phenylethynylbenzophenone (see figure). The endcapped polymers are subsequently thermally cured to yield materials with an attractive combination of properties. In comparison with analogous PAEBI's of high molecular weight and other high-temperature polymers, the cured acetylene- and phenylacetylene-terminated PAEBI's exhibit higher glass-transition temperatures and accordingly better retention of mechanical properties at high temperatures. The cured acetylene- and phenylacetylene-terminated polymers exhibit excellent adhesion to copper foil and polyimide film. These materials are potentially useful as adhesives, coatings, composite matrices, fibers, films, membranes, and moldings.

The glass-transition temperatures of cured benzimidazole-, acetylene-, and phenylacetylene-terminated PAEBI's of comparable molecular weights having the same thermal history were 273, 291, and 307 °C, respectively. The cured acetylene- and phenylacetylene-terminated polymers had glass-transition temperatures significantly higher than those of the cured benzimidazole-terminated polymers, presumably due to higher cross-link density. Thin-film properties at ele-

Acetylene- and Phenylacetylene-Terminated PAEBI Oligomers are synthesized in these reaction sequences.

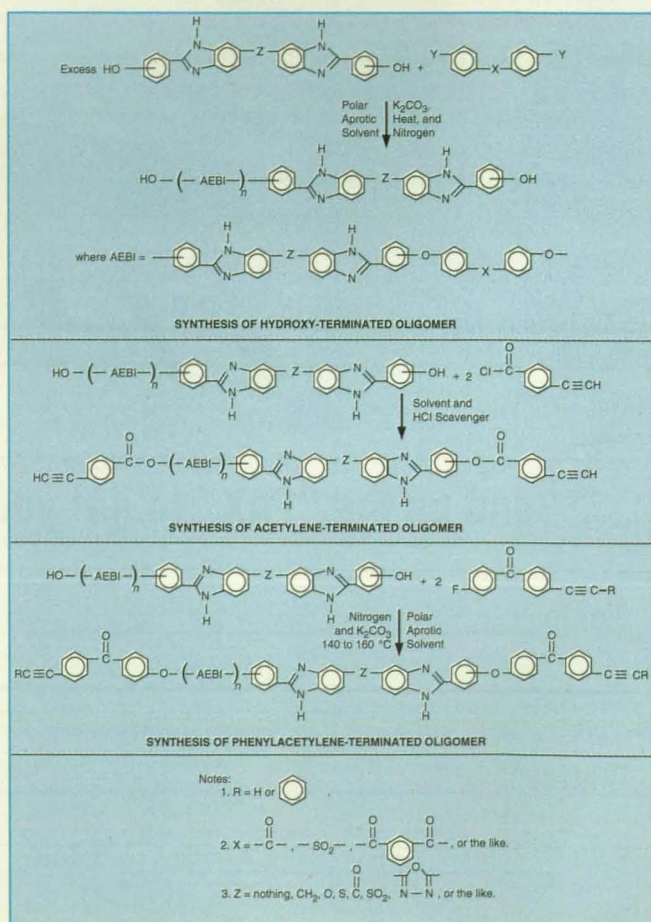

minated temperature followed the same trend as did the glass-transition temperatures. Unoriented thin films [2 mils (0.05 mm) thick] of the benzimidazole-, acetylene-, and phenylacetylene-terminated PAEBI's cured under the same conditions exhibited about the same tensile

strength and modulus at 23 °C, with values of about 17,000 psi (117 MPa) and 540,000 psi (3.8 GPa) respectively. The 23 °C elongation was 25 percent for the benzimidazole-terminated polymer and 11 percent for the acetylene- and phenylacetylene-terminated polymers, again

reflecting the effect of higher crosslink density. A significant difference was observed when the films were tested at 250 °C. The films of the acetylene- and phenylacetylene-terminated polymers exhibited tensile strengths and moduli with values of 10,000 psi (69 MPa) and 300,000 psi (2.1 GPa) at 250 °C, respectively, significantly higher than the films of the benzimidazole-terminated polymers. The film of the benzimidazole-terminated polymer gave elongation of 55 percent at 250 °C, more than twice the values obtained for the films from the acetylene- and phenylacetylene-terminated polymers.

The synthetic route to the acetylene- and phenylacetylene-terminated PAEBI's is depicted in the figure. The top portion of the figure shows the synthesis of the precursor hydroxy-terminated arylene ether benzimidazole polymer. This material is subsequently reacted with 4-ethynylbenzoyl chloride to yield the acetylene-terminated PAEBI or with 4-fluoro-4'-phenylethynyl benzophenone in the presence of potassium carbonate at 140-160 °C in a polar aprotic solvent to provide the phenylacetylene-terminated PAEBI.

This work was done by John W. Connell and Paul M. Herzenrother of **Langley Research Center** and Joseph G. Smith, Jr., of the University of Akron. For further information, **write in 50** on the TSP Request Card.

Inquiries concerning rights for the commercial use of this invention should be addressed to the Patent Counsel, Langley Research Center [see page 20]. Refer to LAR-14965.

Bimaterial Thermal Strip With Increased Flexing

The active materials would have opposite coefficients of thermal expansion. NASA's *Jet Propulsion Laboratory, Pasadena, California*

A proposed modification of the basic concept of the bimetallic strip would make the strip flex more with a given change in temperature. The modified bimetallic strip would be a bimaterial strip, in which one of the two metal layers of the bimetallic strip would be replaced by a material that has a negative coefficient of thermal expansion (see figure). Known materials that have negative coefficients of thermal expansion that could be used in the proposed bimaterial strips include

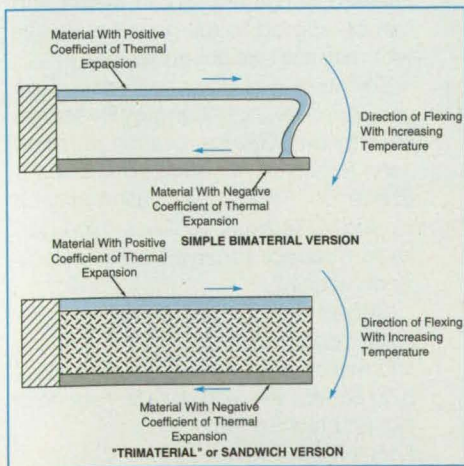

In a **Proposed Bimaterial Thermal Strip**, one layer would have a negative coefficient of thermal expansion, thereby increasing the difference between the coefficients of thermal expansion of the two outer layers and consequently increasing the flexing caused by a change in temperature.

FRICTION

YOU CAN COUNT ON



MATERIAL ML6

- Ultra high friction, low wear.
- Precision molded: O.D. tolerances of 0.001" T.I.R. without grinding!
- Low volume production & prototypes.
- Rebuild-reface existing parts.
- Superior to rubber & urethane.
- Increase machine speed and productivity while eliminating downtime.
- Proven by twenty years of actual use.

Material ML6 can be applied to any metal surface or provided as a slip-on assembly. ML6 is available in an assortment of colors and hardnesses. Send us a sample part to coat and see how ML6 can solve your friction problem.



meridian laboratory
800-837-6010
or 608-836-7571 (FAX 608-831-0300)

P.O. Box 620156
2415 Evergreen Road
Middleton, WI 53562-0156

For More Information Write In No. 454

Master Bond Problem Solver

THERMAL SHOCK RESISTANT ADHESIVE HAS HIGH PEEL STRENGTH

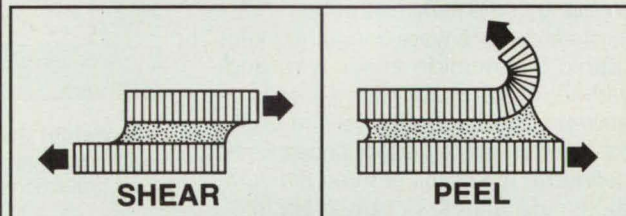

EP21TDC has a shear strength in excess of 2800 psi and a T-peel strength of 35 pli.

Superior durability, high peel, high shear strength, thermal shock resistance and chemical resistance is a combination hard to beat. Master Bond EP21TDC offers this enviable product performance profile and more. It cures at room temperature and has a non-critical 1 to 1 mix ratio by weight or volume. EP21TDC can be applied without sagging or dripping even on vertical surfaces. Bonds are remarkably resistant to thermal cycling over the exceptionally wide temperature range of -60°F to +250°F. EP21TDC has a shear strength in excess of 2800 psi for aluminum to aluminum bonds and a T-peel strength of 35 pli. Adhesion to metals, glass, ceramics, wood, vulcanized rubber and many plastics is excellent. So when looking for high performance - look no further!

Master Bond Inc.
Adhesives, Sealants & Coatings

154 Hobart Street, Hackensack, New Jersey 07601
Tel: (201) 343-8983 • Fax: (201) 343-2132

For More Information Write In No. 455

spodumene (LiAlSi₂O₆) and spodumene-based ceramics. The proposed bimaterial strips could be used in thermostats, for example.

Because metals have positive coefficient strips, which contain metals that have different coefficients of thermal expansion, may not flex enough, or with enough force, to meet the requirements for certain applications. By replacing one metallic layer in such a strip with a layer that has a negative coefficient of thermal expansion, one

can increase the difference between the coefficients of thermal expansion of the two layers, thus increasing the extent and the force of the flexing caused by a change in temperature.

In the basic bimaterial version of the proposed strip, the two materials — one with a positive coefficient of thermal expansion and the other with a negative coefficient of thermal expansion — would simply be directly connected to each other, as shown in the figure. In a "trimaterial" or sandwich

version, a material with little stiffness and/or a coefficient of thermal expansion close to zero would be sandwiched between a metallic layer (with its positive coefficient of thermal expansion) and a layer with a negative coefficient of thermal expansion. Other versions may also be feasible.

This work was done by Andrew D. Morrison of Caltech for **NASA's Jet Propulsion Laboratory**. For further information, **write in 84** on the TSP Request Card. **NPO-18848**

Thin CVD Coating Protects Titanium Aluminide Alloys

Low catalytic activity and good protection against oxidation are obtained.

Langley Research Center, Hampton, Virginia

The useful characteristics of titanium aluminide alloys, candidate materials for use in structures and heat shields on hypersonic vehicles, are limited by the responses of these materials to the hypersonic environment. Thermal-control coatings on the surfaces of these materials are needed to lower temperatures of the vehicles by radiating heat from the surfaces and by minimizing the catalytic heating caused by recombination of dissociated molecular species at the surfaces. At high temperatures, titanium aluminides are susceptible to environmental degradation in the form of oxidation and embrittlement. Therefore, these coatings must also provide shielding of the substrate alloys.

Investigations were conducted into titanium aluminide alloys with and without coatings for thermal control and/or protection against the environment. Baseline performances were defined in the cases of three titanium aluminide alloys: Ti/14Al/21Nb (α_2), Ti/14Al/19Nb/3V/2Mo (super- α_2), and Ti/33Al/6Nb/1.4Ta(γ). Static oxidation tests were conducted with the three alloys in air, using the thermogravimetric analysis to obtain weight-gain data at temperatures up to 1,000 °C. Coated and uncoated samples were exposed to simulated hypersonic flight conditions for as long as 5 hours at a surface temperature of 982 °C to determine their catalytic efficiencies. Post-test evaluations included measurements of radiative properties to determine emittance, plus metallurgical evaluations to determine oxide phases and microstructural changes.

A 10- μ m-thick Al/SiB_x coat produced by physical vapor deposition and chemical vapor deposition (CVD) performed very well under simulated hypersonic flight

conditions and showed promise as a barrier against oxygen. The catalytic efficiency of the coating is about 0.02, which is lower than that of any coating previously evaluated. The change in the weight of an Al/SiB_x-coated α_2 sample in oxidation for 100 h at 982 °C compares favorably with that of an α_2 sample covered with a much thicker commercially available diffusion coating (see figure).

The feasibility of using very thin CVD coatings to provide both protection against oxidation and surfaces of low catalytic activity for thin metallic heat-shield materials has been demonstrated. The use of aluminum in the compositions increases the emittances of the coatings and reduces the transport of oxygen

through the coatings to the substrates. These coatings are light in weight and can be applied to foil-gauge materials with minimum weight penalties.

This work was done by Ronald Clark and Terry Wallace of Langley Research Center and George Cunnington and John Robinson of Lockheed Missiles & Space Co. Further information may be found in AIAA paper 90-1742, "Non-Catalytic Coatings for Hypersonic Vehicle Applications."

Copies may be purchased [prepayment required] from AIAA Technical Information Services Library, 555 West 57th Street, New York 10019, Telephone No. (212) 247-6500. LAR-14381

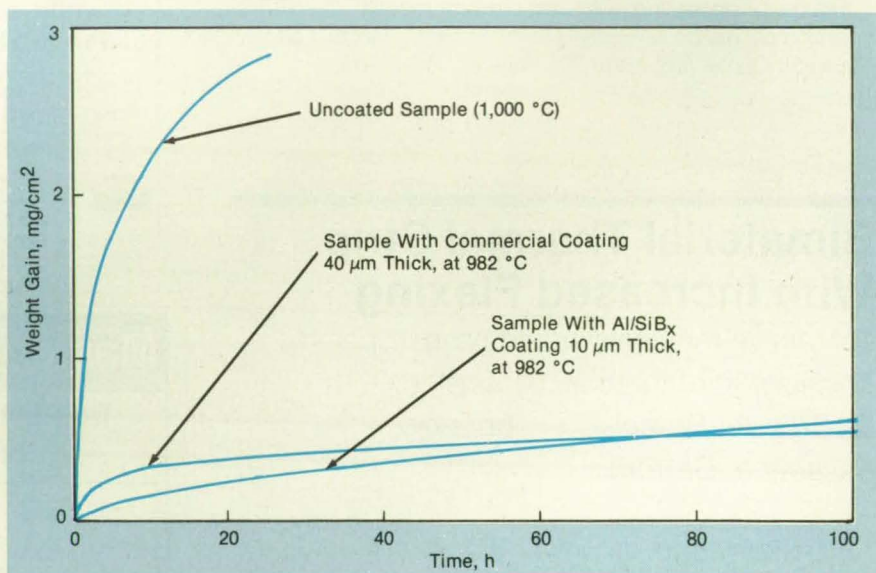

The **Weight Gained in Oxidation**, an inverse indicator of the protection against oxidation, was measured on one coated and two coated α_2 specimens. The Al/SiB_x coat provided the best protection (lowest weight gain) for more than 80 h.



In The World Of Hybrid Microelectronics, Bigger Is Better.

When you're wrestling to find space for a hybrid on a packed board, you want the smallest, lightest product you can find.

But when you're looking for small, lightweight hybrids in large quantities, you need the capabilities of a big, powerful company. A company that can handle

Raytheon currently produces over 400,000 high-reliability hybrid assemblies a year, including MCMs, as well as MIBs (Multilayer Interconnect Boards, SEM-A through E).

high-reliability and high-volume at the same time.

Raytheon is the largest manufacturer of high-reliability hybrids in the world. Our fully-integrated, MIL-STD-1772 certified facility is dedicated to the design, production and testing of hybrid microelectronics, and includes more than 130,000 square feet devoted to fully automated manufacturing, with more than 75% better than Class 100,000.

We use high-precision robotic assembly, automated 100% wire bond pull testing, automatic parametric testing, and automatic vision systems for 100% inspection. As a result, we can handle high-volume production of hybrids that meets virtually any system requirements. We could even double our hybrid production, without sacrificing quality or reliability.

When it comes to hybrids themselves, small is beautiful. But when you're selecting a company you can rely on to supply you with those miniature hybrids and still maintain high-reliability at high-volume, bigger is definitely better.

To learn more about our high-reliability hybrids, call or write for technical support and applications assistance. Raytheon Company, Quincy Operations Division, 465 Centre Street, Quincy, MA 02169.

(617) 984-4104. FAX: (617) 984-4199.

Raytheon

WE THRIVE ON CHALLENGES

For More Information Write In No. 608

Synthesis of Perfluoro Orthocarbonates

These novel, thermally stable compounds were prepared by direct fluorination.

Lewis Research Center, Cleveland, Ohio

Perfluoro tetraalkyl orthocarbonates and perfluoro dialkyl acetals have been synthesized by direct fluorination of orthocarbonates and polyalkoxy propanes (see figure). These new perfluoro compounds are far more volatile than are the perfluoropolyethers that have

These **Chemical Reactions** are typical of the class of reactions described in the text.

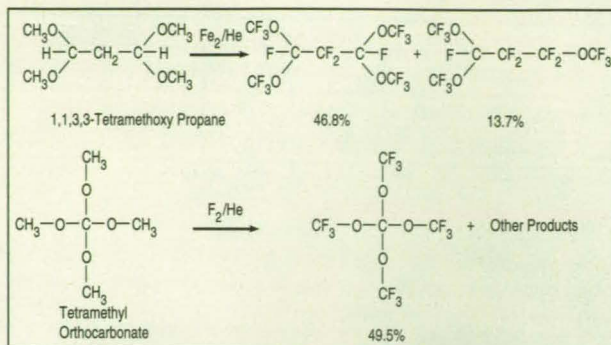

Introducing The Anti-Stiction™ Air Cylinder.



It's a new kind of air cylinder called Airpel™. And it's unlike any air cylinders you've used in the past.

What makes Airpel stand apart is its absence of a phenomenon we call "stiction".

Stiction is that notorious affliction common to air cylinders that causes them to stick at the start of a stroke—resulting in erratic, runaway motion.

Airpel air cylinders are, by comparison, *stiction-free* and virtually *friction-free*. Which gives them a unique ability to impart smooth motion—even at very low pressures, even at very slow speeds, even with very short strokes.

What's more, Airpel air cylinders contain no oil and never need lubrication. Yet they can operate under extreme temperatures—at very high speeds—with *no* degradation. And because all their exposed surfaces are stainless steel and nickel, they are extremely corrosion resistant.

For your convenience, Airpel air cylinders are sold direct from factory stock and can usually be shipped to you within a day or two.

For information on models, prices and technical specifications, write Airpel Division, Airpot Corporation, 35 Lois Street, Norwalk, Connecticut 06851.

Or call 1-800-848-7681.

Airpel™

The Anti-Stiction Air Cylinder.

Airpel™ and Anti-Stiction™ are trademarks of the Airpot Corporation.

the same molecular weights and are stable at temperatures up to at least 150 °C. They might be useful as heat-exchange fluids, lubricants, and/or vapor-phase soldering fluids.

In preparation for a typical experimental synthesis, a mixture of measured amounts of starting orthocarbonate or acetal with approximately 10 g of powdered NaF was packed in a copper tube, which was then placed in the first zone of a four-zone cryogenic reactor. The last three zones were packed with fluorinated copper turnings. After all zones were cooled to -100 °C or -120 °C for 2 h, the system was flushed with helium for 10 h. The fluorination was then carried out by passing a time-varying mixture of He and F₂ gases through the reactor, the zones of which were maintained at various time-varying temperatures from -100 °C or -120 °C to ambient.

As the reaction was completed, the products were fractionated into sequential traps at temperatures of -78, -131, and -196 °C, respectively, on a vacuum line. The majority of the product was obtained in the -78 °C trap. Final purification was done by gas chromatography, using a fluorosilicone column.

The products were identified by elemental analysis, nuclear-magnetic-resonance spectroscopy of ¹⁹F, mass spectrometry, and infrared spectroscopy. The perfluoro tetraalkyl orthocarbonates and dialkyl acetals were found to decompose in hydrogen fluoride solution and concentrated hydrochloric acid but to be stable in concentrated sulfuric and nitric acids.

This work was done by Richard J. Lagow and Wen-Huey Lin of the University of Texas for Lewis Research Center. For further information, write in 60 on the TSP Request Card. LEW-15152

PLATECOIL® PANELCOIL® CRYOPANEL®

Efficient and Versatile Heat Exchangers for

• Space Simulators • Wind Tunnels • Jet Engine and Rocket Engine Test Stands • Sub-zero Cooling of Superconductive Materials



Tranter, inc. and Dean Products, Inc. have supplied efficient and flexible PLATECOIL®, PANELCOIL® and CRYOPANEL® prime surface heat exchangers for a wide variety of space age projects—from large and small solar simulator space chambers, to components for jet and rocket engine test stands, to heat exchange surfaces for helium cryopumping, to bell jar shrouds.

With the acquisition of Dean Products' assets and the addition of a large, dedicated location for production of special space-oriented heat exchangers at its Wichita Falls, TX

facility, Tranter is now producing PANELCOIL and CRYOPANEL products, in addition to PLATECOIL units.

These outstanding heat exchangers can be supplied with grit blasted and blackened interior surfaces for low emissivity and high absorptivity to enhance acceptance of radiation from test objects. Outside surfaces can be electropolished for high emissivity and low absorptivity, reflecting radiation to reduce cryo-liquid usage.

Discover the unparalleled versatility of PLATECOIL, PANELCOIL and CRYOPANEL units, and the potential efficiency and savings they can bring

to your operation. Call us at (817) 723-7125, or contact your local Tranter representative. Better still, ask your local Tranter representative about our Heat Transfer Symposia.



The heat transfer answer.

tranter®

TRANTER, inc., Texas Division
Old Burk Road • P.O. Box 2289
Wichita Falls TX 76307 • (817) 723-7125
TELEX: 73-4410 • FAX: (817) 723-5131

© 1992 TRANTER, inc.

MADE IN U.S.A. 650102

For More Information Write In No. 644



Computer Programs

COSMIC: Transferring NASA Software

COSMIC, NASA'S Computer Software Management and Information Center, distributes software developed with NASA funding to industry, other government agencies and academia.

COSMIC's inventory is updated regularly; new programs are reported in *Tech Briefs*. For additional information on any of the programs described here, write in the appropriate TSP number.

If you don't find a program in this issue that meets your needs, call COSMIC directly for a free review of programs in your area of interest. You can also purchase the annual *COSMIC Software Catalog*, containing descriptions and ordering information for available software.

COSMIC is part of NASA's Technology Transfer Network.

COSMIC® —

John A Gibson, Director

Phone (706) 542-3265;

FAX (706) 542-4807

The University of Georgia,

382 East Broad Street,

Athens, Georgia 30602

Itsy Bitsy Sliders

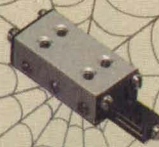

Del-Tron Precision pioneered subminiature linear bearings.

Today our range of subminiature slides for compact automated equipment in the medical, electronics, robotics, assembly, and packaging industries is larger (and smaller) than ever.

	Height	Width	Length	Weight oz.
Ball slides from: (model C-1)	0.23"	0.38"	0.75"	0.10
Positioning stages from: (model 99-X)	0.53"	0.75"	2.28"	1.00
Crossed roller slides from: (model RD-1)	0.32"	0.56"	1.00"	0.35



Call, fax, or write today for a free evaluation unit and 40 page product guide.

Del-Tron® Precision, Inc.

5 Trowbridge Drive, P.O. Box 505, Bethel, CT 06801
TOLL FREE: 1-800/245-5013 FAX: 203/778-2721

Computer Programs

These programs may be obtained at a very reasonable cost from COSMIC, a facility sponsored by NASA to make computer programs available to the public. For information on program price, size, and availability, write in the reference number on the TSP and COSMIC Request Card in this issue.



Mathematics and Information Sciences

General-Purpose Plotting Software

TADPLOT makes it easy to generate publication-quality plots from numerical data.

The TADPLOT computer program was developed to give the researcher a general-purpose plotting software package that is easy to use, can quickly create X-Y plots, and is powerful enough to create full-feature publication-quality plots. Such a package gives the researcher control over the content and layout of each image, and delivers publication-quality plots quickly. With TADPLOT integrated into an applications software network, researchers can view experimental (or theoretical) results immediately after collection. The underlying graphics software package enables the user to save selected plot information that can be displayed subsequently on several different devices, including "hard-copy" plotters. Postprocessing features that enable the user to manipulate and combine plots are also available.

TADPLOT is coordinated by a single easy-to-use interface, enabling the re-

searcher to gain access to several standard file formats, collect selectively specific subsets of data, and create full-featured publication-quality plots. The user interface was designed to be independent of any file format, yet provide capabilities to accommodate highly specialized data queries. With TADPLOT integrated into an applications software network, data can be retrieved, collected, and viewed quickly and easily.

DI-3000 from Precision Visuals, Inc. is used as the underlying graphics software for TADPLOT. TADPLOT generates external files (called metafiles), which can be postprocessed by use of the Metafile Translator in DI-3000. The same DI-3000 metafile can be displayed on several different devices.

TADPLOT is written in ANSI STANDARD FORTRAN 77 for CRAY-series computers running UNICOS, and CONVEX C-series computers running CONVEX OS. No binaries are included with this distribution. TADPLOT requires the DI-3000 Graphics package from Precision Visuals, Inc. With minor modifications, TADPLOT can be installed on any UNIX system that supports the DI-3000 Graphics software package. This program is available on a 9-track, 1,600-bit/in. (630-bit/cm) magnetic tape in UNIX tar format (standard distribution medium). It is also available on a 0.25-in. (6.35-mm) streaming-magnetic-tape cartridge in UNIX tar format. TADPLOT was developed in 1991.

This program was written by Dana P. Hammond of Computer Sciences Corp. for Langley Research Center. For further information, write in 55 on the TSP Request Card. LAR-14846

Raster Metafile and Raster Metafile Translator Programs

The Raster Metafile program is meant to help standardize the representation of raster image data.

There is an ever-growing demand for graphical depiction of numerical results to aid visualization in a scientific computing environment. Along with this demand, there has emerged an associated demand for one or more portable device-independent graphical output formats. Developed at NASA's Langley Research Center (LaRC), the Raster Metafile (RM) computer program is a generic raster-image-format program, and the Raster Metafile Translator (RMT) program is an assortment of software tools for processing images prepared in this format.

The problem of processing raster image data in LaRC's computing environment can be characterized by an increasing number of software-package-specific raster data formats that are to be displayed on an increasing number of raster devices that accept only device-specific raster data input. As a consequence, there has been a proliferation of data-translator computer programs that convert package-specific raster output into device-specific raster input. To minimize translation of raster data, LaRC has adopted a generic RM format and developed an RMT for processing RM-formatted image data. The Raster Metafile program is the product of an attempt by LaRC to standardize the representation of raster image data. The generation and processing of raster image data can be simplified greatly by adoption of the RM format.

The specification of a generic raster image format does not eliminate the requirement for conversion of the data format. It remains necessary to convert package-specific data into RM format and to convert RM data into device-specific data.

Now with **LASER aiming!**

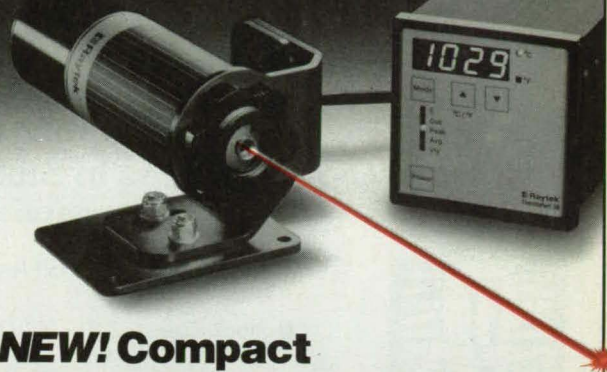

NEW! Compact Noncontact Temperature Measurement Systems

- New Thermalert®30 monitor fits in 1/4 DIN panel space
- Fast response, large bright display, DC or 110/220 VAC available
- Designed to be used with any Raytek Thermalert sensing head in a wide variety of applications: 0 to 3000°C (0 to 5400°F)
- Thermocouple or Current output, with simultaneous RS232 output

For free literature or to arrange a demo fast, call our Laser Hotline:

800-227-8074

In the USA and Canada,
others call 408-458-1110

Raytek®

1201 Shaffer Road Box 1820
Santa Cruz, CA 95061-1820
FAX 408-458-1239

See us at NDES Booth #7447

For More Information Write In No. 410

Over 8,000 Optical Products OFF-THE-SHELF OPTICS

Edmund Scientific
1993 Annual Reference Catalog For Optical Scientists and Engineers

America's Largest Selection of Optics and Optical Components

- OEM Optics
- Optical Systems
- Video Systems
- Imaging Systems
- Positioning Equipment
- Machine Vision
- Critical Measuring
- Lasers, Laser Optics
- Electro Optics
- Magnifiers
- Comparators
- Microscopes
- Telescopes

Optical reference catalog featuring optics and optical instruments used in industry, science and research.

Write or call for 220 page full color catalog, complete with technical data and prices.

AMERICA'S FIRST
#1
OPTICAL
CATALOG • SINCE 1942

Edmund Scientific Co.

Dept 14B1, N954 Edscorp Bldg., Barrington, NJ 08007
PHONE: 1-609-573-6250 FAX: 1-609-573-6295

THE BETTER BELLEVILLE

Precision Belleville Disc Springs

Over 500 Sizes In Stock!

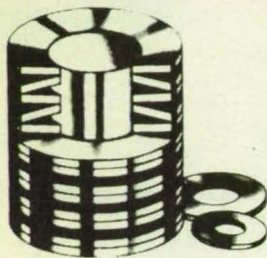

- Heavier, Predictable Loading in Less Space
- Resists Fatigue, Won't Relax Under Load
- Stock Sizes - 3/8" - 10" OD, Special sizes Too!
- In Stainless, Inconel, and Other Special Materials From Stock
- DIN Standards Available

Call or write for our free comprehensive catalog.

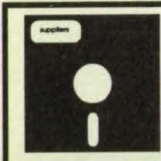

NOW! Rolex offers, without charge, a unique Design Guide on PC Diskette. Engineers can evaluate load and stress of single disc springs or stacks, for rapid and simple disc spring design.

● Call us or order on company letterhead

ROLEX COMPANY

385 Hillside Ave, Hillside, NJ 07205
(201) 926-0900 ● FAX (201) 926-5626

For More Information Write In No. 412

SEAL MASTER INFLATABLE SEALS

Providing fitting solutions
for your toughest
sealing problems

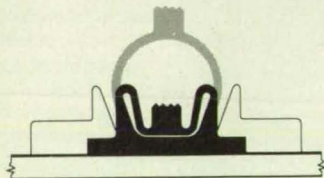

It's the practical and efficient solution where sealing difficulties exist

Weather • Water • Noise • Heat/Cold
Light/Dark • Pressure/Vacuum • Chemicals
Radiation • Contaminants • Interference

We customize to your needs where a positive seal is required between opposing surfaces. Call or write for design assistance. Illustrated literature available.



"They're Deucedly Clever"



SEAL MASTER CORPORATION

INFLATABLE SEALS AND OTHER CUSTOM RUBBER PRODUCTS

368 MARTINEL DRIVE • KENT, OH 44240-4368 USA
(216) 673-8410 • FAX (216) 673-8242

For More Information Write In No. 413

However, software tools are provided to simplify the conversion from package-specific formats to RM format. In addition, translation from RM format to a device-specific format is simplified through the invocation of a collection of software device drivers, including a device-driver template.

RMT is a command-driven program with the primary function of processing RM-formatted raster image data. RMT processing includes reading, writing, and displaying RM images. Such other image-manipulation features as a minimal compositing operator and a resizing option are available under the RMT command structure.

The RMT is written in FORTRAN 77 and C language for Sun4-series computers running SunOS and CONVEX C-series computers running CONVEX OS. No binaries are included with this distribution. RMT requires 2.5 Mb of random-access memory for execution. The following is a list of supported output devices: CELCO film recorders, PostScript and color PostScript printers, Tektronix 4109 and 4125 terminals, Sun color and monochrome workstations, and Versatec ECP-42 and thermal plotters. The standard distribution medium for RMT is a 9-track, 1,600-bit/in. (630-bit/cm) magnetic tape in UNIX tar format. It is also available on a 0.25-in. (6.35-mm) streaming-magnetic-tape cartridge in UNIX tar format. RMT was developed in 1989 and was first released in 1992.

This program was written by Donald P. Randall, Raymond L. Gates, and Kristi M. Skeens of Computer Sciences Corp. for Langley Research Center. For further information, write in 99 on the TSP Request Card. LAR-14114

Resupply Scheduler Program Using Integer Optimization

Lifetimes of components, assembly schedules, and other constraints are taken into account.

Resupply Scheduling Modeler (RSM) is a fully menu-driven computer program that uses integer programming techniques to determine an optimum schedule for replacing components on or before the ends of fixed replacement periods. Although written to analyze the electrical power system on the Space Station Freedom, RSM is quite general and can be used to model the resupply of almost any system subject to user-defined constraints on resources.

RSM is based on a specific form of the general linear-programming problem in which all variables in the objective function and all variables in the constraints are integers. While more computationally intensive, integer programming was required for accuracy when modeling systems that contain small numbers of components. Input values for the lifetimes of components can be real numbers. RSM converts them to integers by dividing the lifetimes by the durations of the replacement periods, then reducing the results to the next lowest integers. For each component, there is a set of constraints that ensure that it is replaced before its lifetime expires.

RSM includes such user-defined constraints as transportation mass and volume limits as well as lifetimes of components, available repair-crew time, and assembly sequences. A weighting factor enables the program to minimize such factors as cost. The program then performs an iterative analysis, which is displayed during processing. A message gives the first period in which resources are being exceeded on each iteration. If the scheduling problem is unfeasible, the final message also indicates the first period in which resources are exceeded.

RSM is written in APL2 for IBM PC-series and compatible computers. A stand-alone executable version of RSM is provided; however, this is a "packed" version of RSM that can uti-

lize only the memory within the 640K DOS limit. This executable code requires at least 640K of memory and DOS 3.1 or higher. Source code for an APL2/PC workspace version is also provided. This version of RSM can make full use of any installed extended memory but must be run with the APL2 interpreter; it requires an 80486-based microcomputer or an 80386-based microcomputer with an 80387 math coprocessor, at least 2 Mb of extended memory, and DOS 3.3 or higher. The standard distribution medium for this package is one 5.25-in. (13.34-cm), 360K MS-DOS format diskette. RSM was developed in 1991.

APL2 and IBM PC are registered trademarks of International Business Machines Corp. MS-DOS is a registered trademark of Microsoft Corp.

This program was written by L. A. Viterna of Lewis Research Center and D. M. Reed of Wittenberg University. For further information, write in 75 on the TSP Request Card. LEW-15309

Computer Program Helps Enhance Images

Pixel Pusher works with color images digitized to 8 bits.

Pixel Pusher is a Macintosh application program for viewing and performing minor enhancements on imagery. It reads image files in JPL's two primary image formats — VICAR and PDS — as well as in the Macintosh PICT format. VICAR (NPO-18076) handles an array of image-processing capabilities that may be used for a variety of applications, including processing of biomedical images, cartography, imaging of Earth resources, and geological exploration. Pixel Pusher can also import color lookup tables in VICAR format for viewing images in pseudocolor (256 colors).

This program currently supports only 8-bit images but works on monitors with any number of colors. Arbitrarily large image files can be viewed in a normal Macintosh window. Enhancement of color and contrast can be performed with a graphical "stretch" editor (as in contrast stretching). In addition, VICAR images can be saved as Macintosh PICT files for export to other Macintosh programs, and individual pixels can be queried to determine their locations and actual data values.

Pixel Pusher is written in Symantec's Think C and was developed for use on

How most materials affect design engineers.

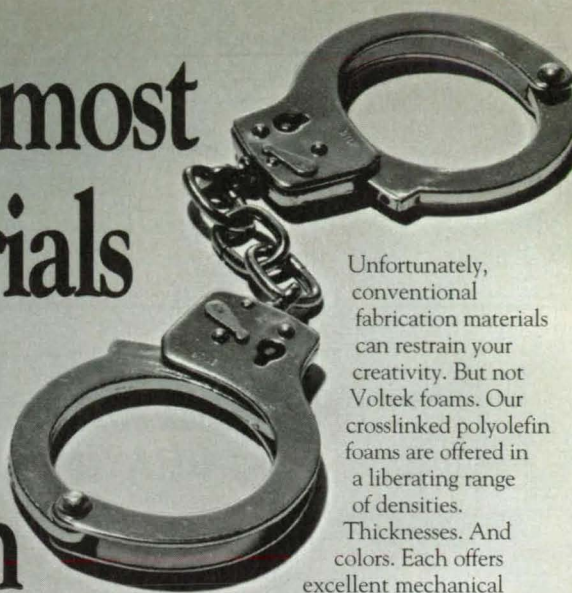

Unfortunately, conventional fabrication materials can restrain your creativity. But not Voltek foams. Our crosslinked polyolefin foams are offered in a liberating range of densities.

Thicknesses. And colors. Each offers excellent mechanical

strength, resilience, thermal, chemical and moisture resistance. Available in rolls, sheets, or buns.

For free foam samples and literature, call Voltek at 800-225-0668.

Voltek
A Division of Sekisui America Corp.
100 Shepard Street
Lawrence, MA 01843
Tel: 508-685-2557 Fax: 508-685-9861



For More Information Write In No. 430

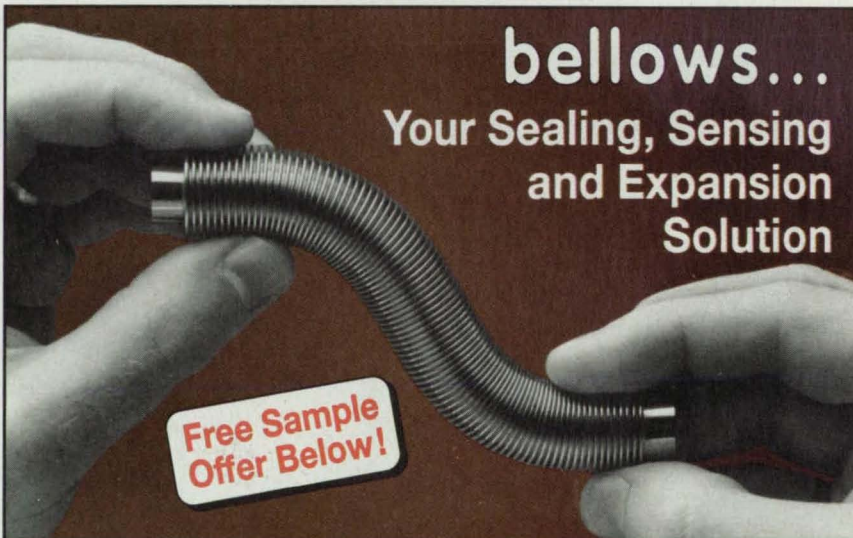

bellows... Your Sealing, Sensing and Expansion Solution

Free Sample Offer Below!

Servometer **bellows** and precision welded **bellows assemblies** offer superb performance and are ideal in applications requiring long life, a high degree of flexibility, precise sensibility and maximum sealing qualities.

- Wide range of ODs and lengths
- Variable wall thickness and no shape limitations
- Multi-ply walls for high pressure
- 125,000 psi min tensile strength
- Available with integral electroformed, soldered, or E-B Welded ends

Call or write today for a free sample and brochure.

SERVOMETER®

501 Little Falls Road • Cedar Grove, NJ 07009
(201) 785-4630 • Fax: (201) 785-0756

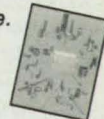

a Macintosh SE30, LC, or II-series computer running System Software 6.0.3 or later and 32-bit QuickDraw. Pixel Pusher runs only on a Macintosh computer that supports color (whether or not a color monitor is in use). The standard distribution medium for this program is a set of three 3.5-in. (8.89-

cm) diskettes in Macintosh format. The price of the program includes documentation. Pixel Pusher was developed in 1991.

Think C is a trademark of Symantec Corp. Macintosh is a registered trademark of Apple Computer, Inc.

This program was written by Daniel F.

Stanfill, IV, of Caltech for NASA's Jet Propulsion Laboratory. For further information, write in 72 on the TSP Request Card.
NPO-18635

MATH77, Version 4.0

This is a collection of programs that are used repeatedly in science and engineering.

MATH77 is a high-quality library of ANSI FORTRAN 77 subprograms that implement contemporary algorithms for the basic computational processes of science and engineering. The portability of MATH77 meets the needs of scientists and engineers who typically use a variety of computing environments. Release 4.0 of MATH77 contains 454 user-callable and 136 lower-level subprograms. Usage of the user-callable subprograms is described in 69 sections of the 416-page user's manual.

The topics covered by MATH77 are indicated by the following list of chapter titles in the user's manual: Mathematical Functions, Pseudo-random Number Generation, Linear Systems of Equations and Linear Least Squares, Matrix Eigenvalues and Eigenvectors, Matrix Vector Utilities, Nonlinear Equation Solving, Curve Fitting, Table Look-Up and Interpolation, Definite Integrals (Quadrature), Ordinary Differential Equations, Minimization, Polynomial Rootfinding, Finite Fourier Transforms, Special Arithmetic, Sorting, Library Utilities, Character-based Graphics, and Statistics.

Besides subprograms that are adaptations of public-domain software, MATH77 contains a number of unique packages of software developed by the authors of MATH77. Instances of the latter type include (1) adaptive quadrature, allowing for exceptional generality in multidimensional cases, (2) an algorithm that solves ordinary differential equations and that has been used in computing trajectories of spacecraft for JPL missions, (3) univariate and multivariate table lookup and interpolation, allowing for "ragged" tables, and providing estimates of errors, and (4) univariate and multivariate derivative-propagation arithmetic.

MATH77 release 4.0 is a subroutine library that has been carefully designed to be usable on any computer system that supports the full ANSI standard FORTRAN 77 language. It has been successfully implemented on a CRAY Y/MP computer running UNICOS, a UNISYS 1100 computer running EXEC



WANT TO FIND FIBERGLASS BEAM AND GRATING DESIGN ON YOUR PC?

**EXTREN® Fiberglass Structural Shapes
DURADEK®/DURAGRID Fiberglass Grating**

- Software for fiberglass beam, column and grating design
- Programs on 3 1/2" high density computer disk for use on IBM/PC compatible computers
- Comes with 117 page software user's manual
- Also available 395-page Design Manual for **EXTREN®** and **DURADEK®** in three ring binder (Computer disk intended to be used with Design Manual)

CALL, WRITE OR FAX TODAY!

MMFG

400 Commonwealth Ave., P.O. Box 580
Bristol, VA 24203-0580, (703) 645-8000
FAX: (703) 645-8132

For More Information Write In No. 458

NOTEBOOK 8.0 - *Simply Windows™*

Exceptional **ease-of-use** has made LABTECH's data acquisition software an industry standard for over 13 years. And now, we've **radically re-engineered** NOTEBOOK with a 100% true Windows look-and-feel. We've proven once again that LABTECH stands as the undisputed leader in open-systems data acquisition applications software that, above all, is intuitive and easy to use.

Start collecting data right away, with a few simple mouse clicks using dynamic dialog boxes, icon bars, and intelligent drag-and-drop features. Version 8's major advancements in functionality include:

- Global parameter changes across I/O
- High-speed DMA data streaming (*To 1 MHz!*)
- Hierarchical icon grouping (*You asked for it!*)
- Drill-down layer navigation (*Multiple views!*)
- Extensive, Windows-style on-line help
- Multimedia support (*It talks!*)
- Bitmap image support...*and more!*

NOTEBOOK automatically supports over 400 popular data acquisition I/O boards and boxes, through the magic of LABTECH's new Universal Driver. No other data acquisition software is this open or offers device support this extensive. Period.



With an installed base of over 30,000 copies, NOTEBOOK is the original and still the best PC-based software for laboratory and test data acquisition, analysis and control.

Call now to order your free evaluation copy!

1-800-899-1612
ask for extension 804

LABTECH • 400 Research Drive • Wilmington, MA 01887
Tel: (508) 657-5400 • FAX: (508) 658-9972
Windows is a trademark of Microsoft Corporation

For More Information Write In No. 416

An Engineer's Spreadsheet Under Windows? WOW!

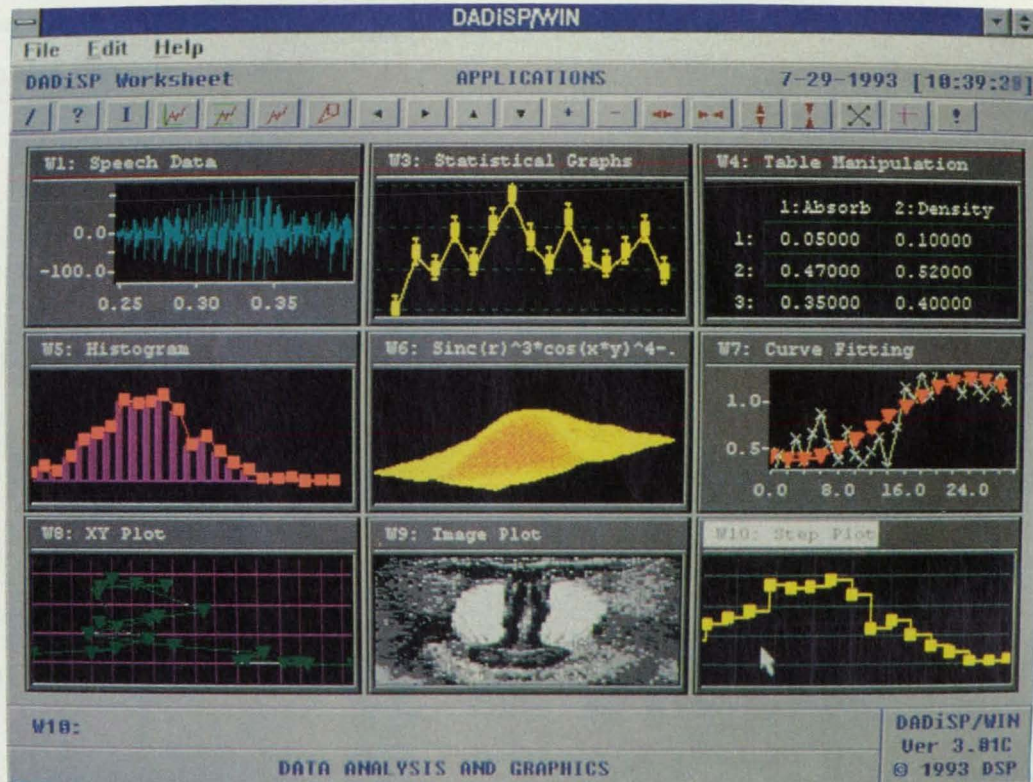

DADiSP combines more than 500 functions for displaying and analyzing your type of data with the power and flexibility of a spreadsheet. Construct sophisticated data analysis in windows, in seconds, at a new level of price/performance.

Now Data Analysis is as easy as pushing a button.

No more fumbling with business software. And no need to learn a new programming language. Just *point and click* and DADiSP displays your results *immediately*. Load a new data series, matrix, signal or image, and all cells update automatically.



One Kendall Square Cambridge, MA 02139
Phone 617-577-1133, FAX 617-577-8211

Extended features tackle your toughest Data Analysis problems.

With DADiSP, you can build an endless number of new worksheets and even your own custom menus. And DADiSP/DDE let's you run external software—IEEE 488 drivers, data acquisition software, *even your own analysis programs*.

Call today: 1-800-777-5151

for your Free DADiSP Trial Kit. DADiSP is available for SUN, HP, IBM, NeXT, DEC, Concurrent, and Silicon Graphics work stations, and of course, IBM PC compatibles.

DADiSP/Windows

Australia & New Zealand-Interworld Electronics, (03) 563-5011; Austria-Norma Goerz Instruments GmbH, (02236) 6910; Belgium-Electronique-Mesures, Brazil-SDC, (011) 564-6024; (02) 384-7309; Denmark-Engberg, (042) 25-1777; Finland-Mespek (9) 0-351-1800; France-SM2, (01) 34-89-78-78; Germany-L.H.L. (0631) 99226; Ingenieurbüro, (069) 9765-000; PDV Systeme (0521) 80761; Hungary-Selectrade Computer, (01) 163-2905; India-Dynalog Microsystems, (022) 517-0514; Israel-Racom, (03) 491922; Italy-BPS Computers, (02) 660-14267; Japan-Astrodesign, (044) 751-0111; Korea-Echo Microsystems, (02) 704-5378; Netherlands-Peel Instruments (010) 4152722; Portugal & Spain-Novatronic, (04) 452-0811; Singapore-Neurotech, 336-4767; Sweden-SYSTEC, (013) 11-01-40; Switzerland-Urech & Harr, (061) 61-13-25; Taiwan-Howching (02) 505-0525; U.K.-Adept Scientific, (0462) 480055

For More Information Write In No. 648

8, a DEC VAX-series computer running VMS, a Sun4-series computer running SunOS, a Hewlett-Packard 720 computer running HP-UX, a Macintosh computer running MacOS, and an IBM PC-compatible computer running MS-DOS. Accompanying the library is a set of 196 "demo" drivers that exercise all of the user-callable subprograms.

MATH77 comprises 109K lines of FORTRAN source code in 375 files with a total size of 4.5 Mb. The demo drivers occupy 11K lines of code with a total size of 418K. Forty-four percent of the lines of the library code and 29

percent of those in the demo code are comment lines. The standard distribution medium for MATH77 is a 0.25-in. (6.35-mm) streaming-magnetic-tape cartridge in UNIX tar format. It is available on a 9-track, 1,600-bit/in. (630-bit/cm) magnetic tape in VAX BACKUP format and a TK50 tape cartridge in VAX BACKUP format.

Previous releases of MATH77 have been used over a number of years in a variety of JPL applications. MATH77 Release 4.0 was completed in 1992. MATH77 is a copyrighted work with all copyright vested in NASA.

This program was written by Charles L. Lawson, Fred Krogh, W. Van Snyder, Carol A. Oken, Faith A. McCreary, Jay H. Lieske, Jack Perrine, Ralph S. Coffin, and Warren J. Wayne of Caltech for NASA's Jet Propulsion Laboratory. For further information, write in 68 on the TSP Request Card. NPO-18918



Machinery

Analyzing Thermal Conditions in Rocket Engines

RTE computes three-dimensional temperature profiles in the cooling jacket wall.

Currently, high-pressure rocket thrust chambers are being designed to be reusable. In order to create a durable design, an accurate prediction of the temperatures within the cooling-jacket wall is necessary. Since large thermal gradients are present in the wall during operation, a new computer code, RTE, has been developed to perform three-dimensional thermal analyses of rocket thrust chambers. RTE calculates the rate of heat transfer from the combustion gases to the coolant, the coolant-temperature rise and pressure drop, and temperature profiles within the cooling-jacket wall. This program can be used for any propellant combination and most coolants that are commonly used in rockets.

Input data files for RTE contain the composition of the fuel/oxidant mixture and rates of flow, chamber pressure, temperature and pressure of the coolant at the entrance, dimensions of the engine materials, and the number of nodes in different parts of the engine. RTE includes subroutines that evaluate the thermodynamic and transport properties of both the combustion gases and the coolant, while another subroutine evaluates the nodal distribution of temperature. These calculations are made for each iteration and are given as part of the output.

RTE also calculates the combustion-gas wall static pressure, temperature and enthalpy, as well as the coolant pressure, temperature, and mach number for all stations. This code can be used for both regeneratively and radiatively cooled engines. However, in the case of regeneratively cooled

**Visualize,
Realize,
EYES**

With CrystalEYES, computer or video-generated images leap out of the screen in true 3D stereo depth. CrystalEyes is a high-quality, affordable solution to viewing stereo images on a wide range of workstations and PCs, as well as the CrystalEyes Video System. It dramatically increases your ability to analyze complex computer graphics, or intricate details recorded on video for Medicine, Science, Education, Entertainment and Industry.

For more information or to order, call:
800 783-2660

Contact StereoGraphics Corporation, 2771 E. Francisco Blvd., San Rafael, CA 94901 Tel: 415.459.4500, Fax: 415.459.3020
StereoGraphics and CrystalEyes are registered trademarks of StereoGraphics Corp. All other trade names are trademarks or registered trademarks of their respective holders.

StereoGraphics

engines, its applicability is limited to those engines that feature single-pass cooling and rectangular cooling channels. All inputs and outputs of the program are in the English system of units.

RTE is written in FORTRAN for DEC VAX-series computers running VMS. The program requires 2 Mb of virtual memory for execution. This program is available in DEC VAX BACKUP format on a 9-track, 1,600-bit/in. (630-bit/cm) magnetic tape (standard distribution medium) or on a TK50 tape cartridge. RTE was released in 1991.

DEC, VAX, and VMS are trademarks of Digital Equipment Corp.

This program was written by M. H. N. Naraghi of Manhattan College for Lewis Research Center. For further information, write in 51 on the TSP Request Card. LEW-14941

Computing Flows of Coolants in Turbomachines

CPF computes the flow in a one-inlet/one-outlet passage of any shape.

A computer code has been developed to predict accurately the coolant flow and heat transfer inside turbomachinery cooling passages (either radial or axial blading). The computer program Coolant Passage Flow (CPF) resulted from a joint NASA Lewis and Army Propulsion Directorate effort to design, build, and test a cooled radial turbine.

CPF analyzes a turbomachinery coolant-flow path that has any size and shape and that consists of one passage with a single inlet and outlet. Flow can be bled off for tip-cap impingement cooling, and one can specify a flow bypass in which a flow of coolant can be taken out and reintroduced at a point farther downstream in the passage.

CPF calculates the rate of flow of coolant, the temperature, the pressure, the velocity, and the heat-transfer coefficients along the passage. It integrates the one-dimensional momentum and energy equations along a defined flow path, taking into account the change in area, addition or subtraction of mass, pumping, friction, and transfer of heat. The user can choose the rate of flow of coolant or let the program compute it from the specified inlet and outlet conditions. The flow must be subsonic everywhere, but it can be choked at the main and bypass exits, as well as at the tip-cap inlet and outlet. CPF predictions show good agreement with closed-form solutions for isentropic flow, Fanno-line flow, and Rayleigh-line flow.

CPF is written in FORTRAN IV and was originally developed for an AMDAHL computer running VM; however, the program has been executed successfully on a variety of other computers. With little or no modification, this program should run successfully on any computer with a FORTRAN compiler that supports NAMELIST. The main memory requirement for running CPF on a DEC VAX computer running VMS is 165K. The program source code and sample input and output are provided with the program. CPF is available on a 9-track, 1,600-bit/in. (630-bit/cm) BPI ASCII CARD IMAGE magnetic tape (standard distribution medium) or a 5.25-in. (13.34-cm), 360K diskette in MS-DOS format. This program was developed in 1990.

IBM is a registered trademark of International Business Machines. DEC, VAX, and VMS are trademarks of Digital Equipment Corp. MS-DOS is a registered trademark of Microsoft Corp.

This program was written by P. L. Meitner of Army Propulsion Directorate, located at the Lewis Research Center. For further information, write in 17 on the TSP Request Card. LEW-15180

ELECTROID

PULSE-OPERATED BI-STABLE BRAKES

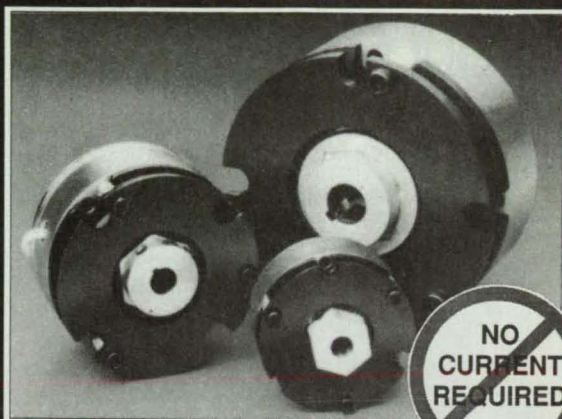

Patented

Pulse Operated Bi-Stable Brakes require **NO CURRENT** to hold either the ON or OFF position. Suitable for any battery powered or low current supply application requiring a brake...AGV/s, wheel chairs, robots, aircraft actuators, electric forklifts, etc.



ELECTROID COMPANY

A DIVISION OF VALCOR ENGINEERING CORP.
45 Fadem Road, Springfield, NJ 07081
201/467-8100 Fax: 201/467-5656

For More Information Write In No. 447

ENGINEERING AND DESIGN SERVICES



Autostereoscopic
Video Imaging System for
Vision III Imaging®, Inc. Herndon, VA

- Microprocessor Systems Applications
- Special Purpose Instruments and Machinery
- Product Engineering and Design
- Short Run Production and Prototypes

Electronic and Mechanical Design
Engineering and Development

ELECTROKINETICS 212-473-1125

Electrokinetics Inc. 380 Lafayette St. Suite 304
New York, New York 10003 Fax: 212-473-3717

Now on Windows 3

IEEE 488.2
control.



Made painless.

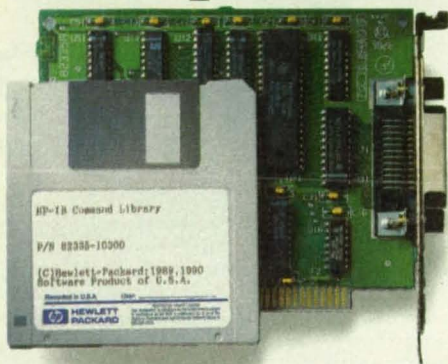

When you need a simple solution to IEEE-488.2 control, the HP 82335B PC HP-IB card gives you fast relief. It makes programming easier with powerful commands (HP-type calls). It helps you get started quickly with comprehensive programming examples. And it includes standard features that take the frustration out of system development. Like a definitive set of common sense commands. Support for all the most popular languages. Automatic software installation and full IEEE-488.2 and SCPI compatibility.

You get all these advantages, from the company that invented HP-IB. So why settle for anything less.



To order, call HP DIRECT
1-800-452-4844, Ext. 7379.

A sixty day, money-back guarantee is included. All you need is a company purchase order or credit card.

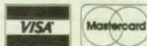

*In Canada call 1-800-387-3154

There is a better way.



HEWLETT
PACKARD

©1992 Hewlett-Packard Co. TMMSO120A/NTB

Analyzing Flows in Rocket Nuclear Reactors

CAC computes aspects of the flows of fluid and heat.

One of the most important factors in the design of a nuclear rocket engine is to be able to predict the temperatures and pressures throughout a fission nuclear reactor core with axial flow of hydrogen along circular coolant passages. CAC is an analytical prediction program to study the heat-transfer and fluid-flow characteristics of a circular coolant passage. CAC predicts, as a function of time, the axial and radial fluid conditions, temperatures of passage walls, rates of flow in each coolant passage, and approximate maximum material temperatures.

CAC incorporates the hydrogen-properties mathematical model of the STATE computer program to provide fluid-state relations, thermodynamic properties, and transport properties of molecular hydrogen in any fixed ortho/para combination. The program requires the general core geometry, the properties of the core materials as functions of temperature, the core power profile, and the core inlet conditions as functions of time.

Although CAC was originally developed in FORTRAN IV for use on an IBM 7094 computer, this version is written in ANSI standard FORTRAN 77 and is designed to be machine-independent. It has been successfully compiled on IBM PC-series and compatible computers running MS-DOS with Lahey F77L, a Sun4-series computer running SunOS 4.1.1., and a VAX-series computer running VMS 5.4-3. CAC requires 300K of random-access memory (RAM) under MS-DOS, 422K of RAM under SunOS, and 220K of RAM under VMS. No sample executable code is provided on the distribution medium. Sample input and output data are included. The standard distribution medium for this program is a 5.25-in. (13.34-cm), 360K diskette in MS-DOS format. CAC was developed in 1966, and this machine-independent version was released in 1992.

IBM-PC and IBM are registered trademarks of International Business Machines, Corp. Lahey F77L is a registered trademark of Lahey Computer Systems, Inc. SunOS is a trademark of Sun Microsystems, Inc. VMS is a trademark of Digital Equipment Corp. MS-DOS is a registered trademark of Microsoft Corp.

This program was written by J. S. Clark and J. T. Walton of Lewis Research Center and M. McGuire of the University of Cincinnati. For further information, write in 98 on the TSP Request Card. LEW-15400



Physical Sciences

Software for Calibration of Polarimetric SAR Data

OLCAL calibrates data supplied in Stokes-matrix format.

Calibration of polarimetric radar systems is a field of research in which great progress has been made during the last few years. POLCAL (Polarimetric Radar Calibration) is a software tool intended to assist in the calibration of synthetic-aperture radar (SAR) systems. In particular, POLCAL calibrates Stokes-matrix-format data produced as the standard product by the NASA/Jet Propulsion Laboratory (JPL) airborne imaging synthetic aperture radar (AIRSAR).

The AIRSAR is a multifrequency (wavelengths of 6, 24, and 68 cm), fully polarimetric SAR system that produces 12x12 km imagery at 10 m resolution. AIRSAR was designed for use as a test bed for NASA's Spaceborne Imaging Radar program. While

the images produced after 1991 are thought to be calibrated (phase calibrated, crosstalk removed, channel imbalance removed, and absolutely calibrated), POLCAL can and should still be used to verify the accuracy of the calibration and to correct it if necessary.

Version 4.0 of POLCAL is an upgrade of version 2.0 of POLCAL released to AIRSAR investigators in June 1990. New options in version 4.0 include automatic absolute calibration of 89/90 data, distributed-target analysis, calibration of nearby scenes with calibration parameters from a scene with corner reflectors, altitude or roll-angle corrections, and calibration of errors introduced by known topography.

Many sources of error can lead to false conclusions about the nature of scatterers on the surface. Errors in the phase relationship between polarization channels result in incorrect synthesis of polarization states. Crosstalk, caused by imperfections in the radar antenna itself, can also lead to error. POLCAL reduces crosstalk and corrects phase calibration without the use of ground calibration equipment.

Removal of the antenna patterns during SAR processing also forms a very important part of the calibration of SAR data. Errors in the processing altitude or in the aircraft roll angle are possible causes of error in computing the antenna patterns inside the processor. POLCAL uses an altitude-error-correction algorithm to remove the antenna pattern from the SAR images correctly. POLCAL also uses a topographic-calibration algorithm to reduce those calibration errors that result from ground topography.

By utilizing the backscatter measurements from either the corner reflectors or a well-known distributed target, POLCAL can correct the residual amplitude offsets in the various polarization channels and correct for the absolute gain of the radar system. POLCAL also gives the user the option of calibrating a scene by use of the calibration results from a nearby scene. This enables precise calibration of all the scenes acquired on a flight line where corner reflectors were present. Construction and positioning of corner reflectors is covered extensively in the program documentation.

In an effort to keep the POLCAL code as transportable as possible, the authors eliminated all interactions with a graphics display system. For this reason, it is assumed that users will have their own software for doing the following: (1) synthesizing an image by use of either horizontal or vertical polarization in both transmitting and receiving, (2) displaying the synthesized image on a display

device, and (3) reading the pixel locations of the corner reflectors from the image. The only inputs used by the software (in addition to the input Stokes-matrix data file) is a small data file with the corner-reflector information.

POLCAL is written in FORTRAN 77 for use on Sun-series computers running SunOS and DEC VAX computers running VMS. It requires 4 MB of random-access memory for execution. The standard distribution medium for POLCAL is a 0.25 in. (6.35-mm) streaming-magnetic-tape cartridge in UNIX tar format. It is also available on 9-track, 1,600 bit/in.

(630-bit/cm) magnetic tape in DEC VAX FILES0-11 format. Other distribution media may be available upon request. Documentation is included in the price of the program. POLCAL 4.0 was released in 1992 and is a copyrighted work with all copyrights vested in NASA.

This program was written by Jakob Van Zyl, Howard Zebker, Anthony Freeman, John Holt, Pascale Dubois, and Bruce Chapman of Caltech for NASA's Jet Propulsion Laboratory. For further information, write in 70 on the TSP Request Card.
NPO-18954

WHO SAYS GET FLOWCHARTS ARE HARD? FLOW CHARTING 3™

If team members drag their feet when it comes to creating flowcharts, you need Flow Charting 3. Its straightforward, no-nonsense approach makes it easy to learn, yet powerful to use.

A must in today's competitive world, flowcharts are essential to documenting, streamlining, and improving processes and procedures. Flow Charting 3 lets you:

- Chart fast with "Hot-Keys" or mouse
- Put shapes, lines and text anywhere you want them
- Create unlimited custom shapes
- Print boardroom perfect charts on dot matrix and laser printers
- Access context-sensitive, on-line help
- Use on a LAN— share files, set up work groups, access usage reports
- Import and export between other popular programs

And Flow Charting 3 is backed with unparalleled post-buy support including free unlimited technical support, free subscription to "The Flow Charter™", access to valuable flowcharting resources, and a full 90-day, no-risk guarantee.

See your dealer today, or for a full interactive demo disk, call now:

800-525-0082 Ext. 283

PATTON & PATTON



Excellence in charting the flow of ideas!

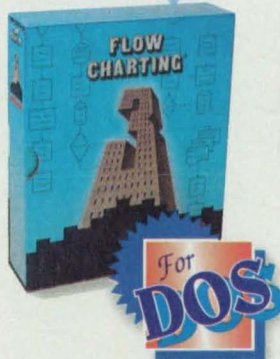



Retractable Rotary-Bit Tool

An allen key can be removed from the workspace.

Goddard Space Flight Center, Greenbelt, Maryland

A tool designed to be part of the end effector of a robot can be retracted when it is not in use to provide clear workspace. The tool bit can be an allen key, for example.

The tool includes telescoping sections that are spring-loaded toward extension. The tool also includes a catch mechanism that retains the inner end of the tool bit and keeps the tool retracted. The tool is mounted on a gripper at the end of the robot arm. The tool includes a base section (see figure), which is one of the two telescoping sections and is

bolted to a rotatable circular mount. This mount, in turn, is fastened to the shaft of a drive motor. An end cap, which keeps the tool bit from falling out, is screwed onto the outer end of the extension section, which is the other of the two telescoping sections.

When the tool is extended, the motor transmits torque to the tool through keyways and keys. The tool is designed to fit loosely in the end cap to give it a small amount of compliance, which is desirable in robotic applications.

After the tool has been used, the robot pushes the outer end of the tool bit against a shallow cup, and the telescoping sections are compressed axially. As this is done, a conical head on the inner end of the tool bit makes contact with the slanted wall of a hole in a block that can slide sideways in a groove. The force of contact pushes the block sideways until the lip of the block engages the undercut shoulder of the cone. This action locks the tool in the retracted position. Thereafter, the compression

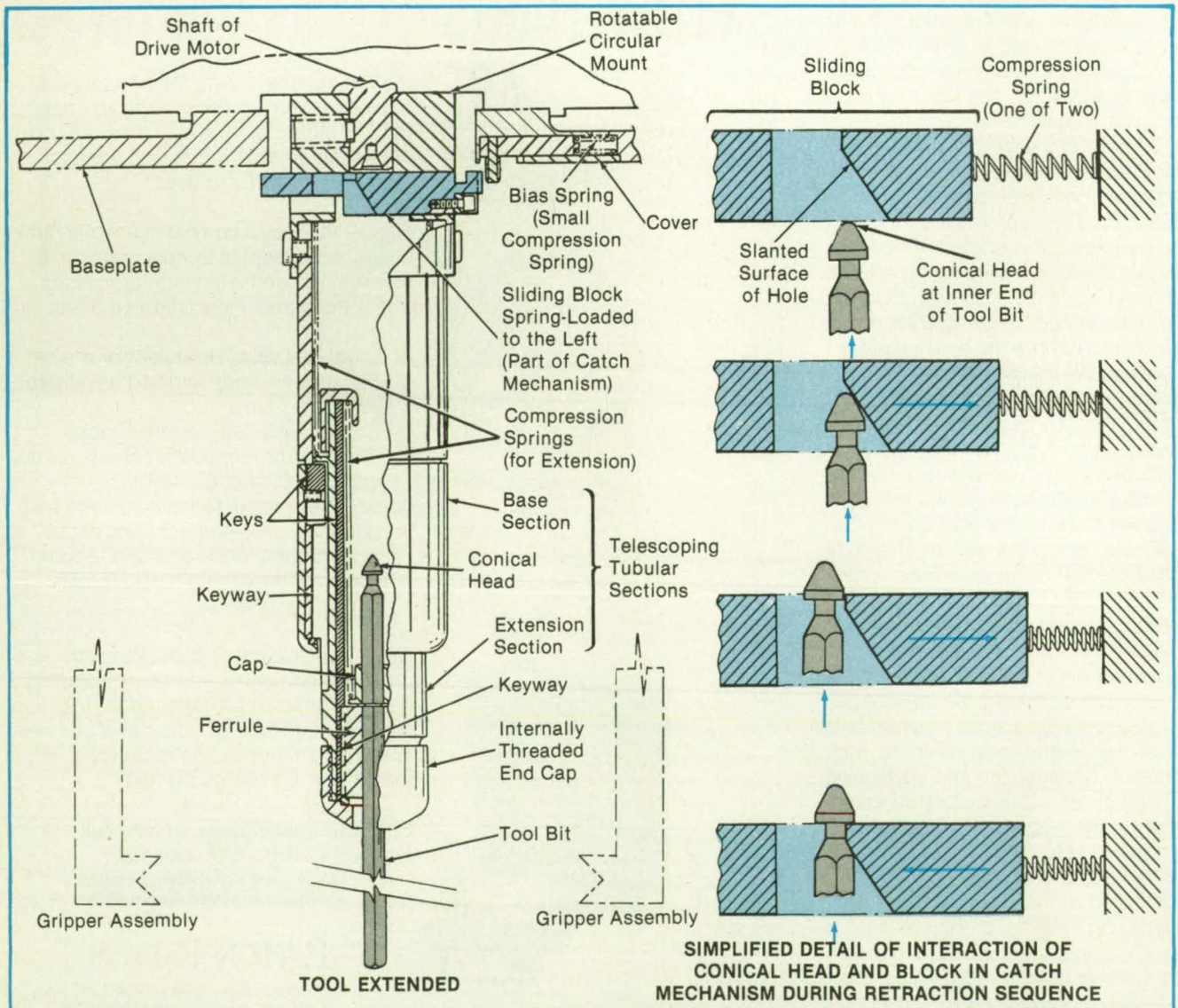

Built-in Springs extend the tool to its working position. When the tool is no longer needed, the telescoping assembly is compressed until the conical head on the inner end of the tool bit engages the lip of sliding block, latching the tool in the retracted position.

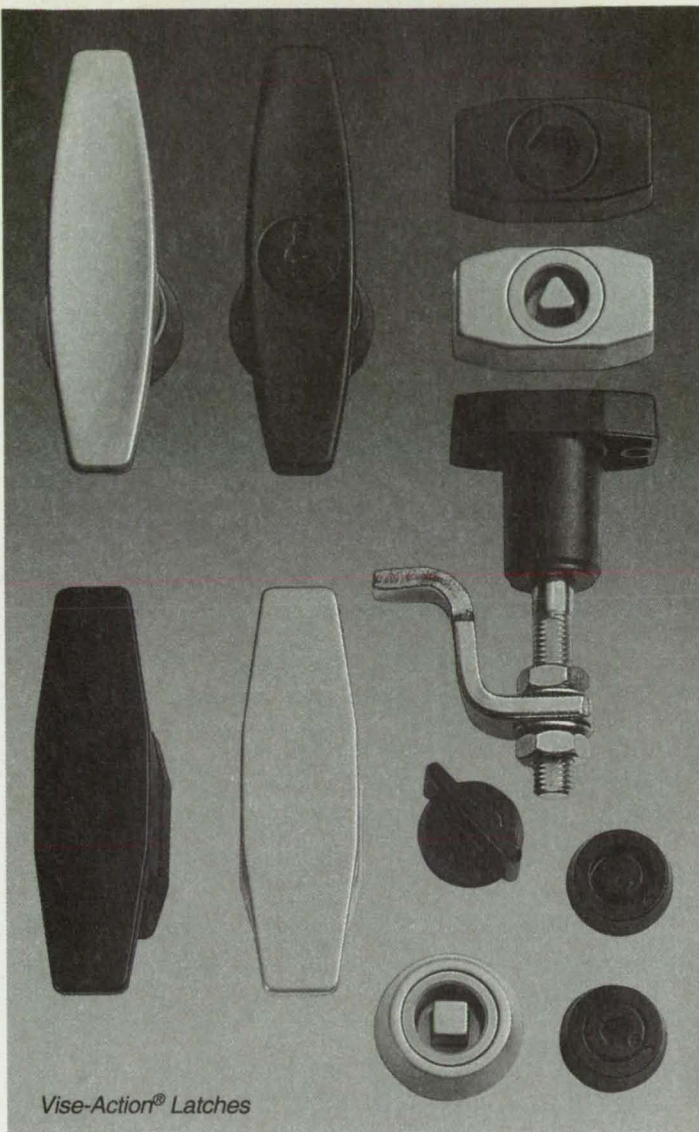

Vise-Action® Latches

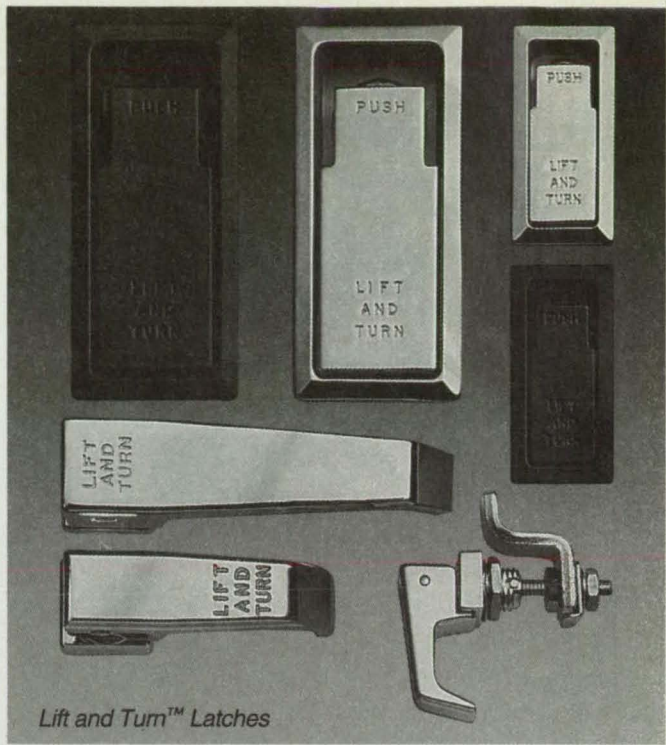

Lift and Turn™ Latches

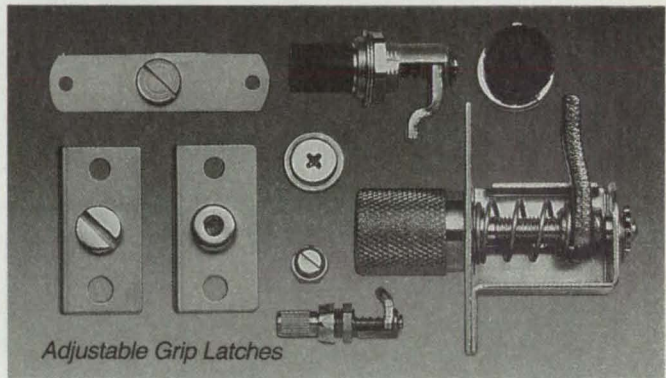

Adjustable Grip Latches

How to securely latch a door and compress a gasket.

Southco can help satisfy your design requirements with hundreds of compression latch options in a wide range of materials, sizes, finishes, colors, and styles.

- In fact, there's probably a standard Southco compression latch waiting to help solve your need to
- consistently compress EMI/RFI shielding and environmental gasketing
 - provide positive latching • allow fast access • install quickly • resist tampering
 - provide multiple-point compression
 - present a flush profile • adjust to vary-

ing panel thicknesses • resist vibration and rattle.

Southco designs and manufactures a full line of latches and access hardware, offering value-added support such as

- CAD library files to facilitate your design efforts
- factory-trained field sales and engineering service — at your service!
- product modifications and custom design expertise to provide precisely the solutions you want.

For more information, or help with satisfying your application needs, contact Southco.



SOUTHCO, INC.

Brinton Lake Road • Concordville, PA 19331 • TEL: 610-459-4000 • FAX: 610-358-6314

Write no. 646. Call me. I'm interested.
Write no. 647. Send information only.

Thermoplastic Quick Couplings for plastic tubing.



One hand connect/disconnect

Free guide to CPC fittings and quick couplings for plastic tubing.

- Easy thumb latch operation
- Over 700 off-the-shelf tubing connections
- Couplings for 1/16" to 3/8" tubing
- Leak free O-Ring seal



CPC™ COLDER PRODUCTS CO.

1001 Westgate Drive • St. Paul, MN 55114 • Phone 612-645-0091
Fax 612-645-5404 • Call Toll Free 1-800-444-2474
For More Information Write In No. 460

Introducing

RUSSIAN TECH BRIEFS

THE OFFICIAL TECHNOLOGY TRANSFER PUBLICATION
OF THE RUSSIAN SPACE AGENCY

Featuring EXCLUSIVE reports of the latest innovations developed in Russia's premier aerospace research labs...previously classified technologies offered for the first time to U.S. businesses. Discover novel engineering solutions and new product ideas across the high-tech spectrum:

Advanced Manufacturing
Biotechnology
Computing
Electronics
Materials
Mechanics
Machinery
...and much more!



Write in No. 590 for a free sample — while supplies last.

springs that would otherwise cause extension hold the shoulder against the lip, while other compression springs force the block sideways against the narrow neck on the tool bit just below the conical head. No dedicated actuators are needed to perform the retraction; robot arm movements alone perform the task.

To reextend the tool, the rotatable circular mount is actuated by the drive shaft. By cam action, the rotation of the mount pushes the lip of the block away from the shoulder of the conical head on the tool bit. The compression springs in the telescoping sections then extend the tool to its working position.

This work was done by George Voellmer of **Goddard Space Flight Center**. For further information, **write in 83** on the TSP Request Card.

This invention is owned by NASA, and a patent application has been filed. Inquiries concerning nonexclusive or exclusive license for its commercial development should be addressed to the Patent Counsel, Goddard Space Flight Center [see page 20]. Refer to GSC-13358.

Retractable Rotary Tool With Simplified Latch

Opposing catch springs latch onto a head, retaining the tool in retraction.

*Goddard Space Flight Center,
Greenbelt, Maryland*

The figure shows a retractable rotary tool that is part of a robot hand. The tool is similar to the one described in the preceding article, "Retractable Rotary-Bit Tool" (GSC-

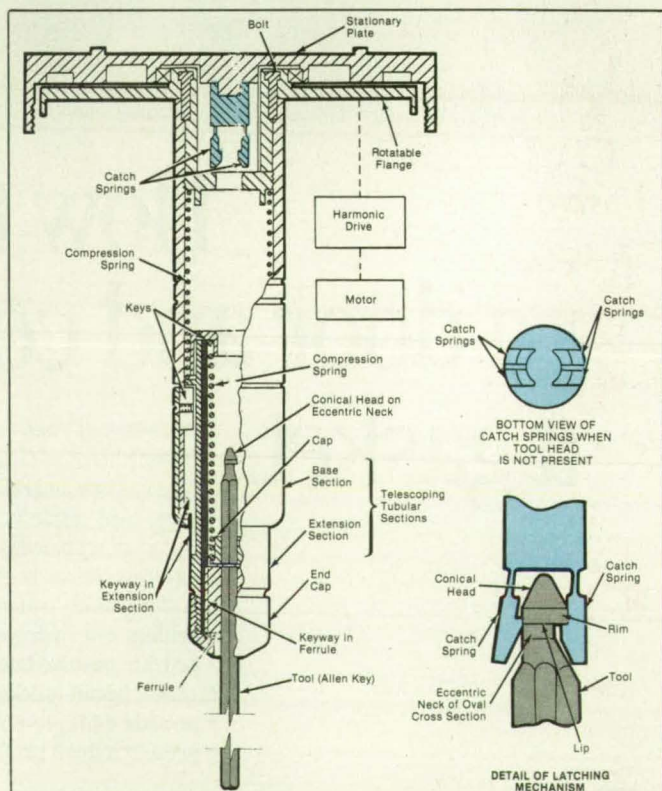

The **Conical Head** at the upper end of the tool bit is latched in the retracted position by catch springs. The eccentric neck just below the head makes it possible to release the head from the catch springs by rotating the telescoping tubular sections and tool bit.

Leak-tight Valves & Fittings for Analytical Instrument Applications

The leak-tight technology of the SWAGELOK companies is built into all the products you see here.

They work with each other to give you design flexibility. You can select sizes, shapes, materials and ratings to handle **your** service conditions.

They're all manufactured to the same standards of precision and quality control. You can count on consistent tolerances, compatible end connections, and reliable seals.

They're available locally from Authorized Sales and Service representatives. You can save money through efficient purchasing, controlled inventories, and on-time delivery.



TUBE FITTINGS



BALL & PLUG VALVES



FILTERS

CHECK &
RELIEF VALVES



METERING VALVES

QUICK-CONNECTS



WELD FITTINGS

O-RING
& METAL GASKET FACE SEAL FITTINGS

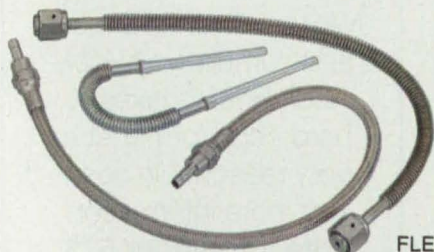

FLEXIBLE HOSE



NEEDLE VALVES

These Products are subjects of
patent or patents pending



the
SWAGELOK
companies

SWAGELOK Co.
Solon, Ohio 44139
SWAGELOK Canada Ltd., Ontario

© 1988 SWAGELOK Co., all rights reserved SW-4
See us at the Design Engineering Show - Booth #2202
See us at the Plant Engineering Show - Booth #5504

For More Information Write In No. 420

13358), except that it includes a simpler mechanism for retention in, and release from, the retracted position.

Like the prior tool, this one includes telescoping tubular sections (see figure) and a tool bit that are spring-loaded toward axial extension. As before, the telescoping sections and tool bit are prevented from rotating with respect to each other (but allowed to move axially) by keys and mating keyways. Also as before, the base section (one of the two telescoping tubular sections) is mounted on a rotatable flange. The flange is driven by

a motor and a harmonic gear drive.

The inner end of the tool bit differs from that of the prior version. It includes a conical head with a short cylindrical rim and an eccentric neck with an oval cross section. When the robot pushes the outer end of the tool against a suitable unyielding object, the tool bit and telescoping sections are forced inward against the spring bias. As this motion continues and just as the tool is about to reach the fully retracted position, the conical head pushes apart two opposing pairs of catch springs mounted on a stationary

plate near the inner (upper in the figure) end of the base section. When the tool is pushed in a little farther, the lip under the rim of the conical head engages clawlike protrusions on two of the springs, and the springs snap inward. The clawlike protrusions of the left (in the figure) pair of springs are located slightly above those of the right pair of springs; this ensures that at any angle of rotation of the eccentric neck, two springs are always available to latch onto the head.

The spring catches thus retain the tool in the retracted position. To initiate release, the drive motor and harmonic drive turn the rotatable flange; this causes the telescoping sections and tool bit to rotate about the cylindrical axis, while the catch springs remain stationary. At some point during the rotation, the conical tip and eccentric neck of the tool bit pass through the angular position in which there is no lip to engage the clawlike protrusions on the catch springs, and the tool bit is free to slip out of the grip of the catch springs, axially outward (downward in the figure) under the push of the compression springs. If the head is caught on the upper pair of clawlike protrusions, it first slips down to the slightly lower pair of clawlike protrusions, then eventually slips free as the rotation passes the release point of the lower protrusions. Then the compression springs extend the telescoping tubular sections and the tool bit to the full-length working position.

*This work was done by George Voellmer of **Goddard Space Flight Center**. For further information, write in 36 on the TSP Request Card.*

This invention is owned by NASA, and a patent application has been filed. Inquiries concerning nonexclusive or exclusive license for its commercial development should be addressed to the Patent Counsel, Goddard Space Flight Center [see page 20]. Refer to GSC-13359.

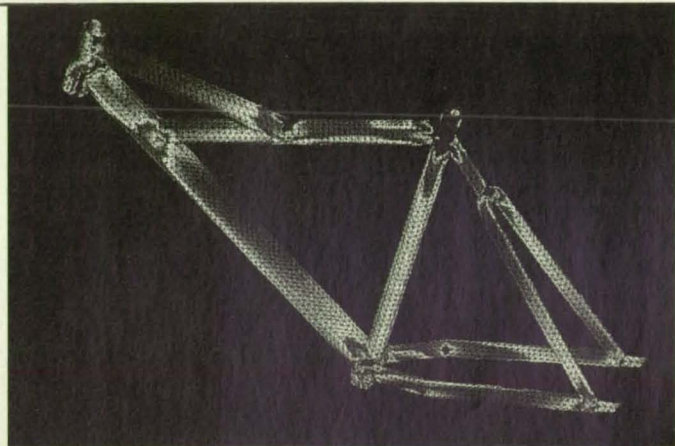

Stress contour plot of a bicycle frame

NOW DESIGNING A BICYCLE IS AS EASY AS RIDING ONE.

Take a ride on COSMOS/M 1.70. The Finite Element Analysis tool that helps you put quality into your designs while shortening both design cycle and analysis time.

Sprint ahead with powerful new COSMOS/M features that automatically mesh complex 2D and 3D models, and increase analysis accuracy by generating fine meshes in critical areas of your model. Mesh different parts of the model, using different types of elements, and bond or assemble them together for analysis.

Measure solution reliability with new convergence plots. Optimize model parts faster and more reliably. Then coast to the finish while COSMOS/M solves nonlinear problems using a new automatic stepping technique.

Even transfer a design from your preferred CAD package to COSMOS/M for the analysis of your choice - statics, dynamics, heat transfer, fatigue, nonlinear, fluid flow and electromagnetics.

Whether you're getting started in FEA, or are already analyzing critical and complex problems, COSMOS/M provides a single, easy-to-learn, interactive graphics environment. Call 310-452-2158 and experience its power and simplicity with our free evaluation copy.

COSMOS/M

THE ULTIMATE TESTING GROUND FOR YOUR IDEAS

COSMOS/M is available for PCs, Apple, SunSparc, IBM RS/6000, SGI Iris and Indigo, DECstation and HP 9000/700 series. COSMOS/M is a registered trademark of Structural Research. All other names mentioned may be registered trademarks of their respective companies. Model courtesy of Cannondale Corporation.

TECH BRIEF INDEXES

NASA publishes annual and cumulative NASA Tech Brief indexes in hard copy format at a very reasonable cost. For more information write in number 573.

Improved All-Terrain Suspension System

A simpler linkage is proportioned to operate in sand and climb obstacles.

NASA's Jet Propulsion Laboratory, Pasadena, California

A redesigned suspension system for an all-terrain vehicle (see figure) exhibits enhanced ability to negotiate sand and rocks. Designed for a rover vehicle for exploration of Mars, the suspension also has potential application in off-road vehicles, military scout vehicles, robotic emergency vehicles, and toys.

Predecessors of this suspension system were described in "Articulated Suspension Without Springs" (NPO-17354), *NASA Tech Briefs*, Vol. 14, No. 1 (January 1990), page 60; "Four-Wheel Vehicle Suspension System" (NPO-17407), *NASA Tech Briefs*, Vol. 14, No. 8 (August 1990), page 55; and "High-Clearance Six-Wheel Suspension" (NPO-17821), *NASA Tech Briefs*, Vol. 16, No. 6 (June 1992), page 77. The six-wheel suspension described in the last-mentioned article contained a more complicated pantograph mechanism, which tended to become stalled by large rocks between the wheels.

The redesigned suspension, with a rocking bogie, is much simpler: it contains only two links per three-wheel set. A vehicle is supported by a right and a left set of three wheels connected to the body by a differential linkage. This differential mechanism stabilizes the body by averaging the tilt angles of each side.

The key to the agility of the new suspension is its relative dimensions. The proportions have been sized by computer simulations to minimize the friction required to surmount rocks and other objects. Other design tradeoffs included the placing of pivots high enough to clear objects and the enlarging of the wheels to improve performance in soft sand. The rocker bogie performs in both directions without the need to shift the center of gravity.

This work was done by Donald B. Bickler of Caltech for NASA's Jet Propulsion Laboratory. For further information, write in 86 on the TSP Request Card. NPO-18719

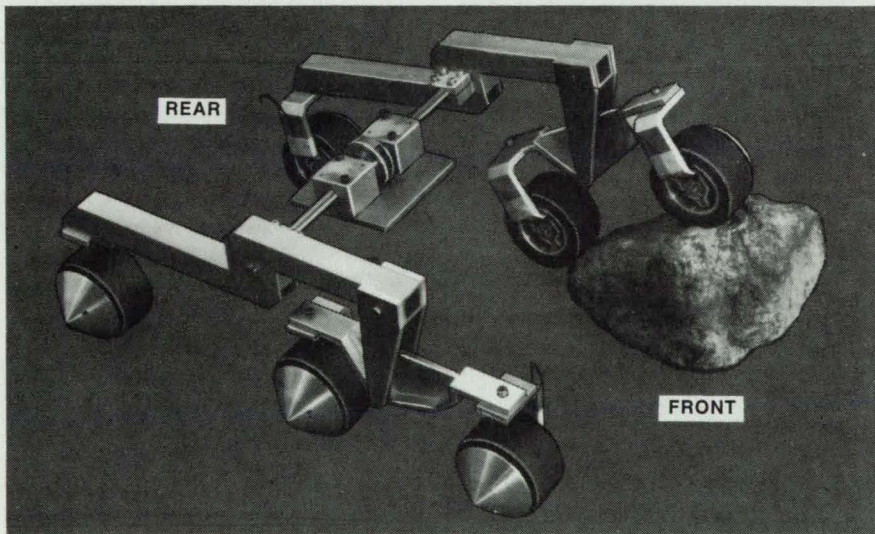

The Improved Six-Wheel Suspension System includes only two links on each side. The bogie tends to pull the rear wheels with it as it climbs.

Latching Solenoid-Operated Ball Valve

Electrical energy would be consumed only during opening or closing motion.

Marshall Space Flight Center, Alabama

A proposed solenoid-operated ball valve would latch in its open or closed position until it is energized to change

position. The valve would consume energy only during the switching (opening or closing) interval, which would

Data Acquisition for Windows With a Huge Advantage...



The Price. Packed with On-Board DSP, 1 MHz sampling to host memory, 16 A/D Channels, and utilizing the power of Windows, the WIN-30D has the speed, resolution and overall performance of boards three times its price. Starting at \$995, the WIN-30 Series has a decided advantage.

WIN-30 Series Hardware

- 1 MHz, 12 bit, 16 channel A/D (16 channels at 62.5 kHz/channel)
- 150 kHz, 16-bit, 16 channel A/D
- Dual channel DMA or 16/32 bit Rep String operation
- On-board DSP
- Samples directly to all Windows memory at full speed
- Programmable gain and SSH models available

UEIDAQ Software Includes

- Windows 3.1 (including Visual BASIC), Windows NT and DOS drivers
- Complete source code in Microsoft C for entire driver system
- LabVIEW[®] 3.0 for Windows drivers
- Status for Windows[™] advanced acquisition system is ready to use



UNITED ELECTRONIC INDUSTRIES

Leaders in Windows Data Acquisition[™]

Call 800-829-4632 for product information and demo disk

Ten Dexter Avenue, Watertown MA 02172
617-924-1155 Fax: 617-924-1441 Telex: 6732760

©Copyright 1993, United Electronic Industries, Inc. All rights reserved. Product and company names listed are trademarks of trade names of their respective companies.

For More Information Write In No. 449

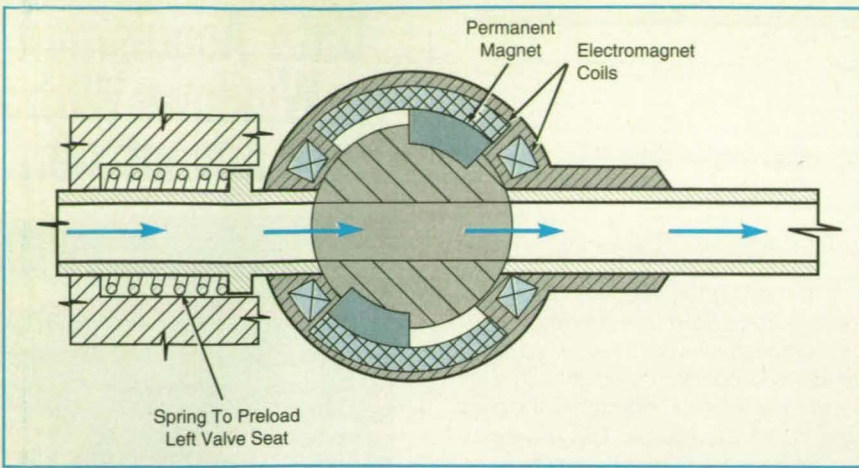

The **Ball Would Hold Permanent Magnets** and would constitute a permanent-magnet armature of a rotary solenoid. The housing would contain the stator coils of the solenoid. The ball is shown here in the open position.

last no more than 40 ms. The maximum power consumed during this interval would be only 42 W.

The valve ball would contain a central channel through which fluid could flow. The ball would be made of a highly magnetically permeable steel. Permanent magnets would be mounted in recesses in the ball and would protrude from the ball (see figure). The valve housing would also be made of highly magnetically permeable steel and would contain electromagnet coils.

When the appropriate coil(s) were energized by a brief pulse (or pulses) of electrical current at the appropriate polarity, the ball would rotate clockwise until the permanent magnets came to rest against hard stops in the housing, and the inlet and outlet ports would be aligned with the central channel so that the fluid could flow through the valve. The magnets would adhere to the stops by magnetic attraction, thus latching the valve in the open position; no electrical current would be needed to keep the valve open.

To close the valve, the appropriate coil(s) would be energized by a pulse (or pulses) of the appropriate polarity to generate magnetic forces that would rotate the ball counterclockwise until the magnets made contact with hard stops, and the inlet and outlet ports would be sealed. As before, magnetic attraction would latch the valve in the closed position.

The angle of shutoff or turn-on rotation would be only 45°. The shortness of this rotational stroke would help to minimize wear, actuation time, and consumption of electrical energy.

The valve could be equipped with a manual override knob connected to the ball by a shaft through an O-ring seal. The knob would also indicate the position of the valve. The valve would latch in its most recent position, regardless of whether it has been moved manually or electrically.

An additional electromagnet coil would be placed near each hard stop to reduce the latching force: The coils near the stops at which the permanent magnets were latched would be energized momentarily along with the main turning coils. The fluxes generated by these coils would buck the permanent-magnet fluxes, thereby reducing the latching

THE EVANS CAPATTERY

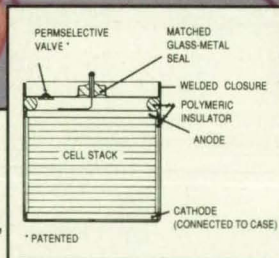
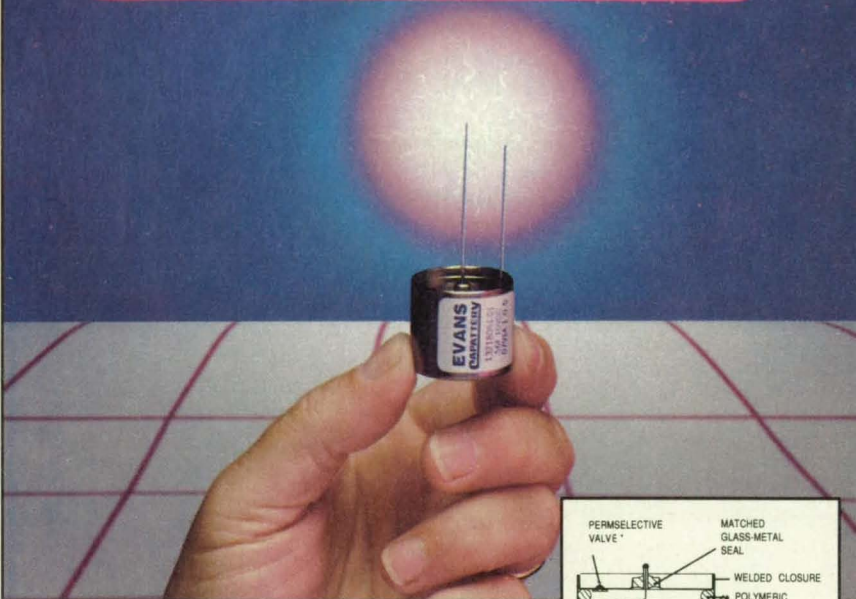

**Power.
When you
need it.
Whenever
you need it.**

The Evans Capattery. Very small, very powerful, very reliable.

This incredible double-layer capacitor is a unique carbon-based device that is housed in a welded tantalum package.

Its patented Permselective valve allows it to release CO₂ generated during normal operation while inhibiting the escape of electrolyte vapors and preventing contaminants from entering the container.

A 5.5-volt, 1F Capattery has a volume of 0.5 in.³, an 11-volt, 0.5 F Capattery has a volume of less than 1 in.³.

The Capattery has a temperature range of -55°C to 85°C. It withstands unlimited charge/discharge cycles.

EVANS

P.O. Box 4158, East Providence RI 02914
(401) 434-5600. Fax (401) 434-6908.

For More Information Write In No. 407

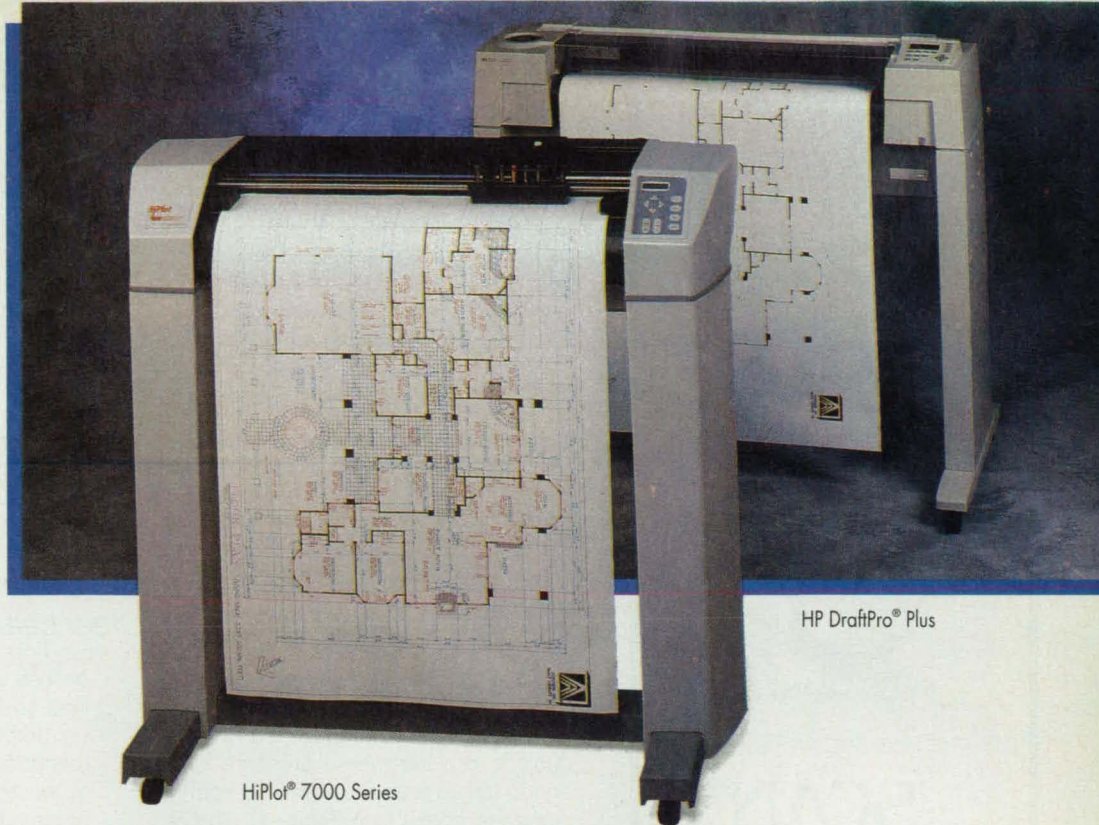

HP DraftPro® Plus

HiPlot® 7000 Series

Our Competition is 100% Behind Us.

Hey, facts are facts! The HiPlot 7000 Series D- and E-size pen plotters are the best in the world.

- **100% Faster.** HiPlot combines 5.7g acceleration and 45ips velocity to produce plots twice as fast as HP DraftPro Plus. It even beats the DesignJet™ 650C on some drawings.



- **100% More Accurate.** Even at these higher velocities, HiPlot delivers 0.1% accuracy compared to 0.2% for the DraftPro plus - and the DesignJet 650C.

- **100% More Intelligence.** Vector sorting and vector look-ahead minimize motion and make HiPlot's curves noticeably smoother than DraftPro Plus and the DesignJet 650C.

- **100% More Versatility.** Our exclusive SCAN-CAD accessory allows the HiPlot to double as a wide format, 400dpi scanner - for under \$2,700!
- **3-Year Warranty.** HiPlot's unique FlexLoop™ platen, HI® Grip drive system and Plotting-On-Air design revolutionize the way pen plotters handle media. Increased reliability, backed by an increase in warranty coverage.
- **\$300 to \$5000 Less.** The kicker - you get all

Plotter	Acceleration	Accuracy	Plot Time*	Intelligence	
HiPlot 7200	5.7g	0.1%	31 minutes	Vector Sorting	Vector Look-Ahead
HP DraftPro Plus	3.0g	0.2%	69 minutes	N/A	N/A

* Based on plot shown above using AutoCAD® Release 12 on a 386 33MHz computer.

this speed, quality and versatility at a lower price than the HP DraftPro Plus and the DesignJet 650C. If this makes you think twice, give us a call for more information and for the HiPlot dealer nearest you.

HiPlot® 7000 Series

Summagraphics®

1-800-337-8662

For More Information Write In No. 672

HEADHUNTER™

HEAD & EYE SLAVED POINTING SYSTEM

COMPLETE, NON-INVASIVE, REAL-TIME
HARDWARE AND SOFTWARE INSTRUMENTATION TO COMPUTE AND ANALYZE
COMBINED HEAD AND EYE VECTORS FOR
ADVANCED WEAPONS POINTING, SIMULATION
/TRAINING & HUMAN FACTORS ASSESSMENT.

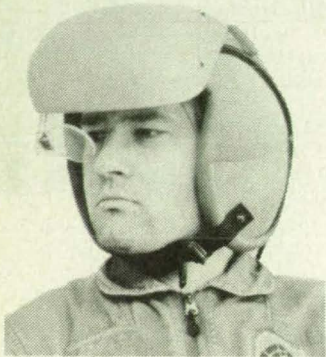

ISCAN®

125 CAMBRIDGE PARK DR.
CAMBRIDGE, MA 02140
TEL: 617-868-5353 FAX: 617-868-9231

For More Information Write In No. 424

VERSATILE!

UniSlide® Positioners

Stackable • Move 1 oz. to 400 lbs.

With or without travel distance
measurement. Travel lengths
from ¼" to 86"

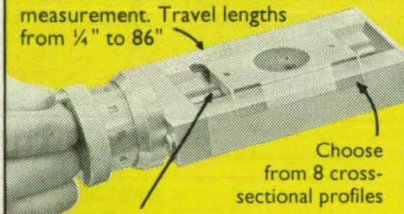

Choose
from 8 cross-
sectional profiles

7 lead screw pitches, English or Metric,
in standard or high precision grades

Save down-time and expense.
New Catalog G has over 960
reliable UniSlide Assemblies
including Rotary Tables, Plain,
Rapid Advance and Micrometer
Models. Call 800 / 642-6446
for your free copy.

VELMEX INC.

P.O. BOX 38 • BLOOMFIELD, NY 14443
IN NY STATE 716 657- 6151

For More Information Write In No. 425

force at the old position and making it easier to turn the ball to the new position.

This work was done by Myron Brudnicki of Allied-Signal Aerospace Co. for Marshall Space Flight Center. For further information, write in 94 on the TSP Request Card.

Title to this invention has been waived under the provisions of the National Aeronautics and Space Act [42 U.S.C 2457 (f)], to Allied-Signal Aerospace

Company. Inquiries concerning licenses for its commercial development should be addressed to:

Terry L. Miller Patent Council
Allied-Signal Aerospace Company
2525 West 190th Street
Torrance, CA 90504-6099

Refer to MFS-28715, volume and number of this NASA Tech Briefs issue, and the page number.

Deflection and Stress in Preloaded Rectangular Membrane

Previous calculations for a square membrane are generalized.
Goddard Space Flight Center, Greenbelt, Maryland

A theoretical analysis has yielded equations for the transverse deflection of, and stresses in, a rectangular membrane subject to a transverse pressure load and to tensile preloads applied uniformly along the edges (see Figure 1). This is an extension of the analysis reported in "Deflection and Stress in Preloaded Square Membrane" (GSC-13367), NASA Tech Briefs, Vol. 15, No. 9 (September 1991), page 96.

Like the previous analysis for the square membrane, this analysis follows a strain-energy/virtual-deflection approach, which is common in stress-and-strain problems of this kind. Indeed, this analysis is identical to the previous one except in the following respects:

- The assumed expressions for the stretching (in-plane deflection) and bending (out-of-plane or transverse

deflection) of the membrane are modified so that the boundary conditions on displacements (zero displacements along the edges) are satisfied at the edges of the rectangle instead of the edges of the square.

- The use of the modified displacements in the strain-energy integrals results in three simultaneous nonlinear equations (instead of one in the case of the square) for the relationship among the maximum deflection at the center of the membrane, the transverse pressure load, the edge preloads, the modulus of elasticity and Poisson's ratio of the membrane material, and the thickness of the membrane.

The simultaneous nonlinear equations can be solved iteratively to obtain the in-plane and transverse displacements, then the tensile stresses in the membrane

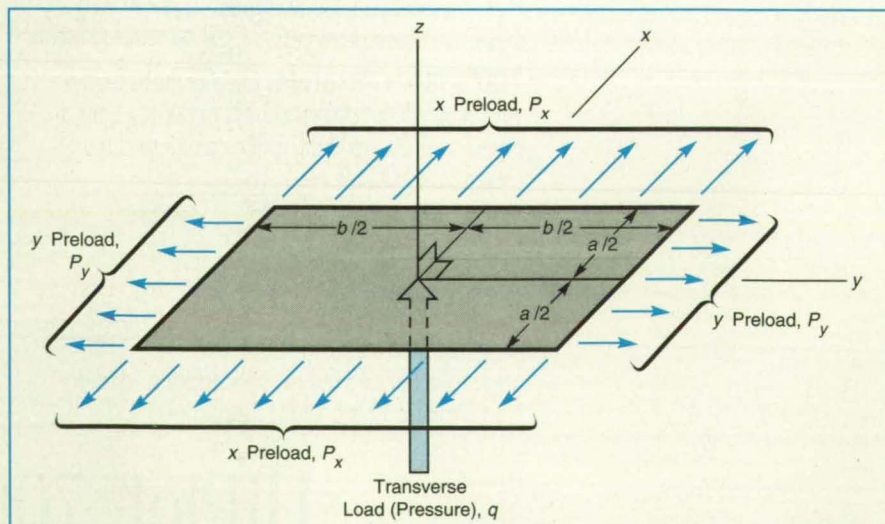

Figure 1. Uniform Stretching Preloads are applied to the edges of a rectangular membrane that is also subject to a transverse pressure load.

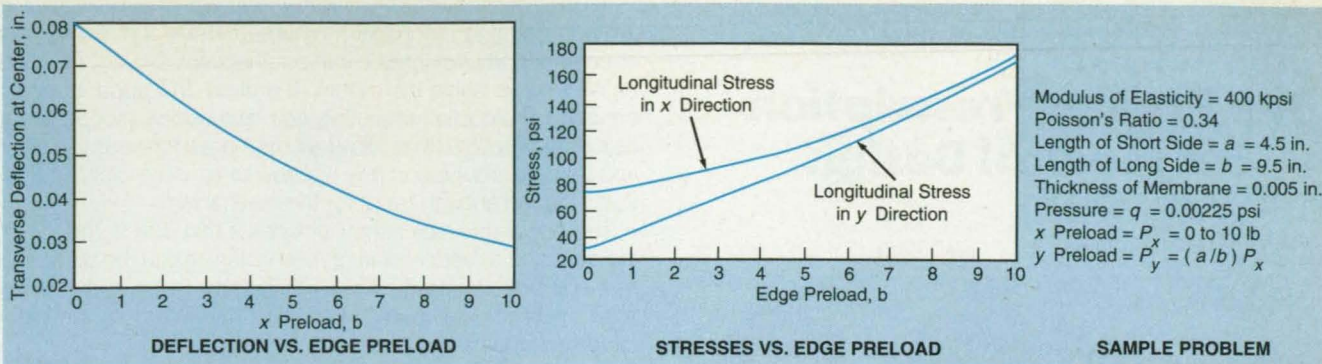

Figure 2. **Deflection and Stresses** as functions of edge preload were computed for a rectangular polyimide membrane under a fixed pressure load and a varying edge preload.

can be computed from the displacements. Figure 2 presents an example of calculations of deflections and stresses in a Kapton (or equivalent) polyimide

membrane.

*This work was done by Alfonso Hermida of **Goddard Space Flight Center**. For further information, write*

in 5 on the TSP Request Card.
GSC-13561

Versatile Support for Electromagnetic-Test Model

One unit accommodates models of various sizes and shapes.

Langley Research Center, Hampton, Virginia

A supporting apparatus holds a model for measurements of its electromagnetic properties. The apparatus includes a rigid

swept strut, on the end of which the model is oriented over a range of angles. The apparatus is designed to interfere

minimally with the electromagnetic measurements.

Unlike an older apparatus that includes

When R&D can't wait...

...1-Day DELIVERY

(in-stock inventory items)

Largest inventory of polished laser optics in the industry for the fastest delivery on coatings

The choice is clear...

- ▶ High Damage Threshold
- ▶ Wavelengths from 248nm to 2100 nm
- ▶ Three fully equipped coating facilities to serve your needs

Glass lenses on site in 2 days.

We can coat in 2 days. CVI polished substrate or customer-supplied substrate.

**3 locations:
California, Connecticut, New Mexico**

CVI LASER

CVI EAST
(203) 928-1928
FAX (203) 928-1515

CVI WEST
(510) 449-1064
FAX (510) 294-7747

Box 11308, Albuquerque, NM 87192
(505) 296-9541
FAX (505) 298-9908

The Proven Prescription For Medical Design

See us at
MD&M West,
Booth 271

Thermofoil™ Heaters



- Clinical diagnostic equipment, oximetry, imaging, NMR coils
- Etched-foil element for precise, efficient heat
- Complete assemblies available: Factory mounting to heat sink, integral sensors, connectors, thermostats, fuses

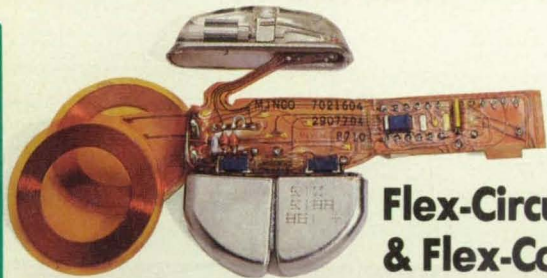

Flex-Circuits & Flex-Coils™

- Pacemakers, defibrillators, drug pumps, laboratory electronics
- Flex and rigid-flex circuits to 16 layers
- Integral wire-wound telemetry coils
- Connector & pin assembly optional

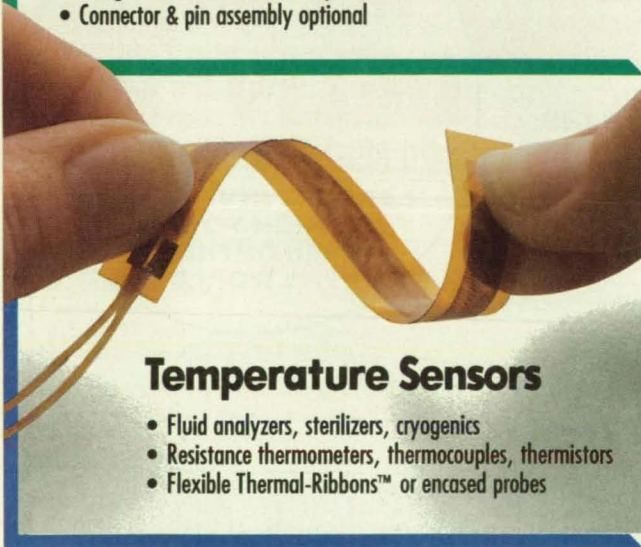

Temperature Sensors

- Fluid analyzers, sterilizers, cryogenics
- Resistance thermometers, thermocouples, thermistors
- Flexible Thermal-Ribbons™ or encased probes

MINCO

PRODUCTS, INC.

7300 Commerce Lane
Minneapolis, MN 55432-3177
Phone: (612) 571-3121 • Fax: (612) 571-0927

a model-rotating mechanism mounted inside the model, this apparatus does not intrude into an unacceptably large portion of the volume inside the model. Therefore, this apparatus can be used to hold a flat, essentially two-dimensional model as well as a solid or hollow three-dimensional model, whereas the older apparatus could support only a hollow three-dimensional model that included enough room for the mechanism.

This apparatus (see figure) includes a thin disk at the top of the strut and a model-rotating mechanism inside the strut. The model is bolted onto the disk, which rests on a thrust bearing atop the strut. The model is oriented in azimuth by turning a drive shaft that is part of the mechanism.

The disk and bearing can be removed and replaced. They are available in a variety of thicknesses, diameters, and load capacities to accommodate models in a range of sizes and weights.

The top section of the strut is also replaceable. The top surface of this top section is flat, and the slant of this surface determines the pitch angle of the model. Thus, the pitch angle of the model can be changed by selecting a top section that has a different slant.

This work was done by Richard M. Wood of Langley Research Center and Eddie D. Ford of Lockheed Engineering & Sciences Co. No further documentation is available.

Inquiries concerning rights for the commercial use of this invention should be addressed to the Patent Counsel, Langley Research Center [see page 20]. Refer to LAR-14758

The Model
Is Mounted
on the disk,
which is
rotated to
the desired
azimuth
angle

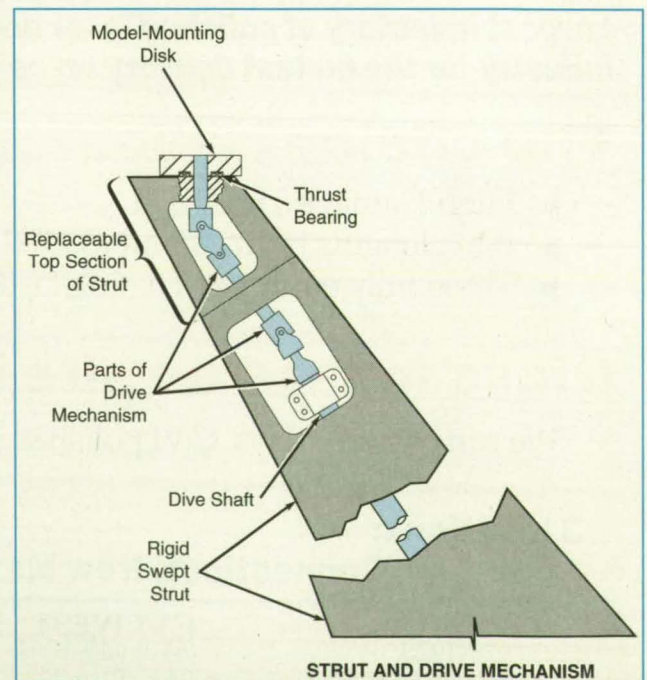
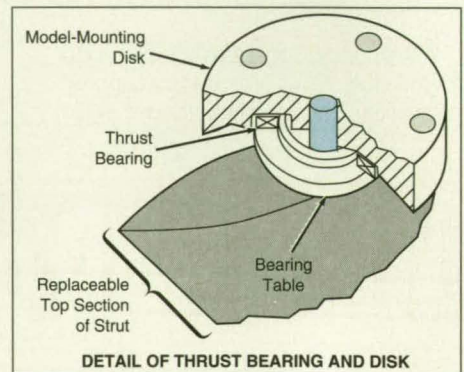

What Goes Up, Usually Comes Down...

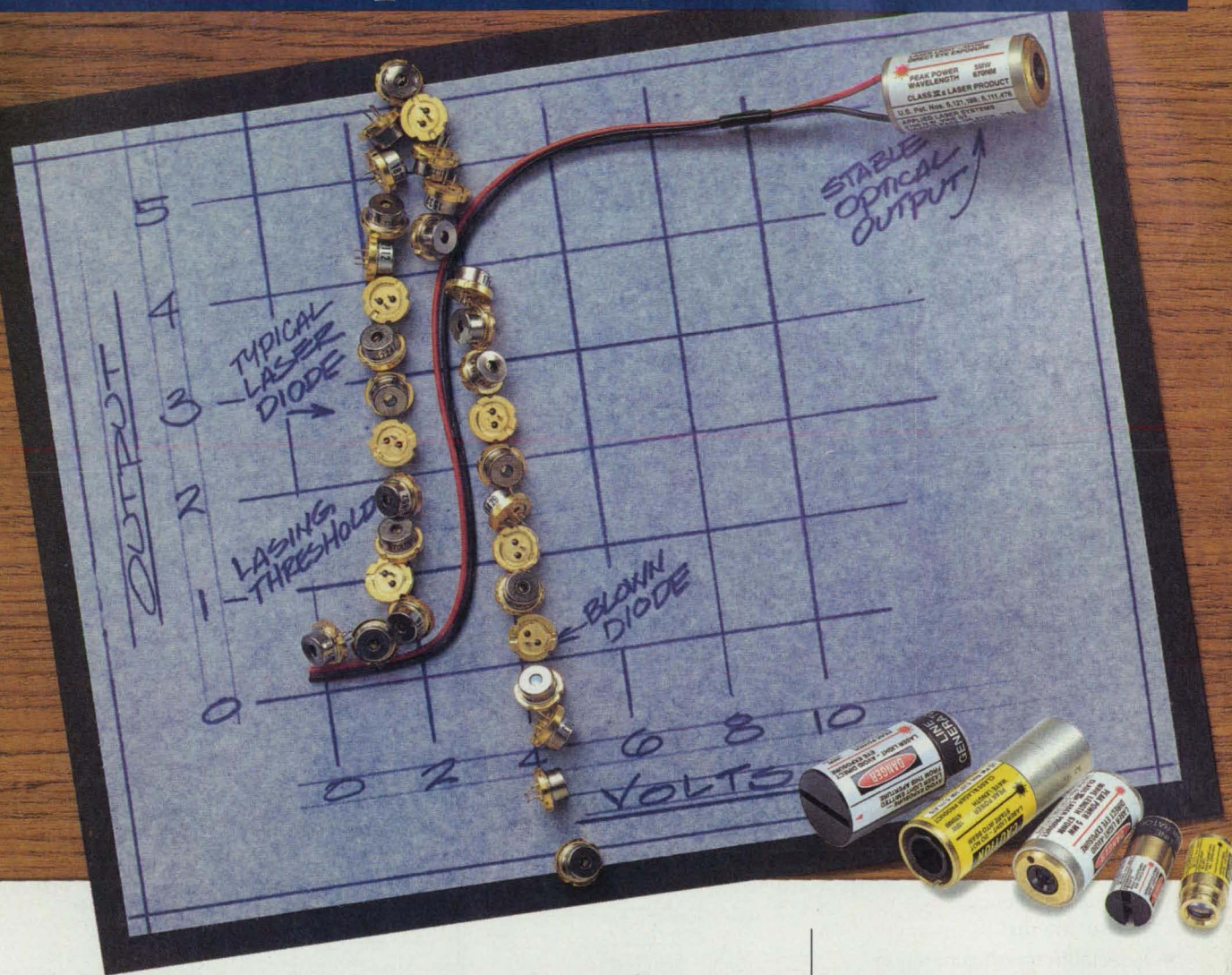

Unless

...the laser diode destined for your product application is completely protected against the forces of electro-static discharge, temperature and handling abuse. That's because a raw laser diode is a fragile and highly volatile device with extreme threshold behavior that will quickly "blow up" under unstable environmental conditions. The typical laser diode is capable of turning on in "one millionth" of a second...and one very short "mistake" usually results in total destruction, rendering the laser diode useless. Applied Laser Systems (ALS) has solved this problem and makes the laser diode usable in the real world.

So, while it may seem practical to engineer your laser product "from the ground up," it makes far more sense to bypass the frustrating process of trying to stabilize the laser diode by simply "plugging in" our patented

VLM™ product directly into your application. Our modular system is so user friendly, all you have to do is add a power supply.

Simply put, the ALS Visible Laser Module, or VLM™ product is the most advanced laser module system on the market today. Our miniature design incorporates the laser diode, drive circuits, and sophisticated optics into one tiny, self-contained, shock resistant package, allowing us to maximize power efficiency while protecting the internal circuitry from electro-static discharge, spiking overload and reverse polarity. In short, the VLM™ product makes the fragile laser diode virtually indestructible.

And with a field failure rate of less than 1 percent, Applied Laser Systems supports its products with a full **two year warranty**, setting the industry standard. In addition, a small green LED indicator is mounted on the rear of each module to indicate when the laser is operating...a safety factor that ALS alone provides.

The versatile VLM™ product comes ready-to-use in a variety of beam configurations and wavelengths, in both the visible and infrared bands. Modules can easily be integrated into a wide variety of applications that require precision and accuracy, such as alignment and positioning, counting and timing, signal transmission, testing and measurement, and illumination...right out of the box.

Why waste critical R&D funds on costly experimentation? At ALS we've already figured it out!

ALS

APPLIED LASER SYSTEMS

2160 N.W. Vine Street
Grants Pass, OR 97526, U.S.A.
Fax: (503) 476-5105
Telephone: (503) 474-6560

**For QWIK-FAX Information
call (503) 479-1526**

Protected by U.S. Patents Nos. 5,121,188; 5,111,476
For More Information Write In No. 630

New Loran Receiver delivers competitive punch



If you're looking for a Loran receiver that performs like a champ, check out just a few of the features that make our **NEW Model 2104 Loran Receiver** the top contender:

- Only frequency receiver to track multiple Loran stations
- Minimizes impact of individual transmitter failures
- Low cost
- Field upgradeable to include GPS
- Quick acquisition of Loran stations
- Unknown Position Locator determines best GRI
- Provides optimal control of internal disciplined crystal oscillator
- USNO and NIST traceable calibration source
- New technique for quick external frequency measurements
- Selectable report generation
- Supports up to 2,000' antenna cable



The Model 2104 comes standard with disciplined crystal oscillator, I/O interface (RS-232 or IEEE-488), input module (1, 5 or 10 MHz), output module (.1, 1, 5, or 10 MHz), passive whip antenna and cable. A variety of output and interface options are also available.

For more information
call or Fax today.

datum inc
AUSTRON DIVISION
P.O. BOX 14766 • AUSTIN, TEXAS 78761-4766
Phone (512) 251-2341 • FAX (512) 251-9885

For More Information Write In No. 459



Machinery

Three-Stage Regenerative Sorption Cooler Reaches 65 K

Efficiency is comparable to that of a Stirling-cycle cooler.
NASA's Jet Propulsion Laboratory, Pasadena, California

A three-stage regenerative sorption cooler provides 0.5 to 1.0W of third-stage cooling at temperatures from 65 to 90 K while consuming about 60 W of input power. If the first- and second-stage sorption compressors are made over-size, it can also provide additional cooling at 165 to 190 K and 120 to 140 K, respectively.

The power efficiency of this sorption cooler is comparable to that of a mechanical Stirling-cycle cooler and except for some check valves, this cooler includes no precise, wearing moving parts. Consequently, it produces no

measurable vibration and is expected to last much longer in operation — possibly more than 10 years. The present cooler also represents an improvement over the two-stage sorption cooler described in "Regenerative Sorption Refrigerator" (NPO-17630), *NASA Tech Briefs*, Vol. 15, No. 3 (March 1991), page 51. That refrigerator was not as efficient as a Stirling-cycle cooler. Furthermore, it included a thermoelectric device (represented as a radiator in the illustration in the noted article) that provided 1.5 W of cooling at 200 K, and its sorption compressors operated at temperatures and

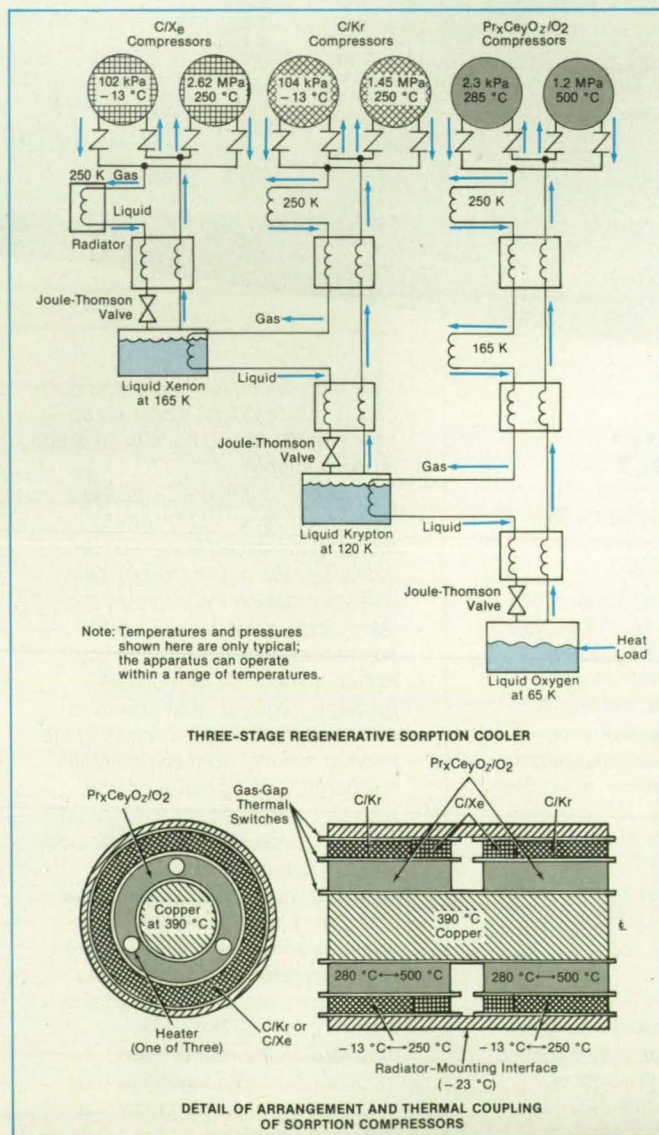

This Three-Stage Regenerative Sorption Cooler produces no measurable vibration, is highly reliable, and exhibits efficiency comparable to that of a less-reliable mechanical Stirling-cycle cooler.

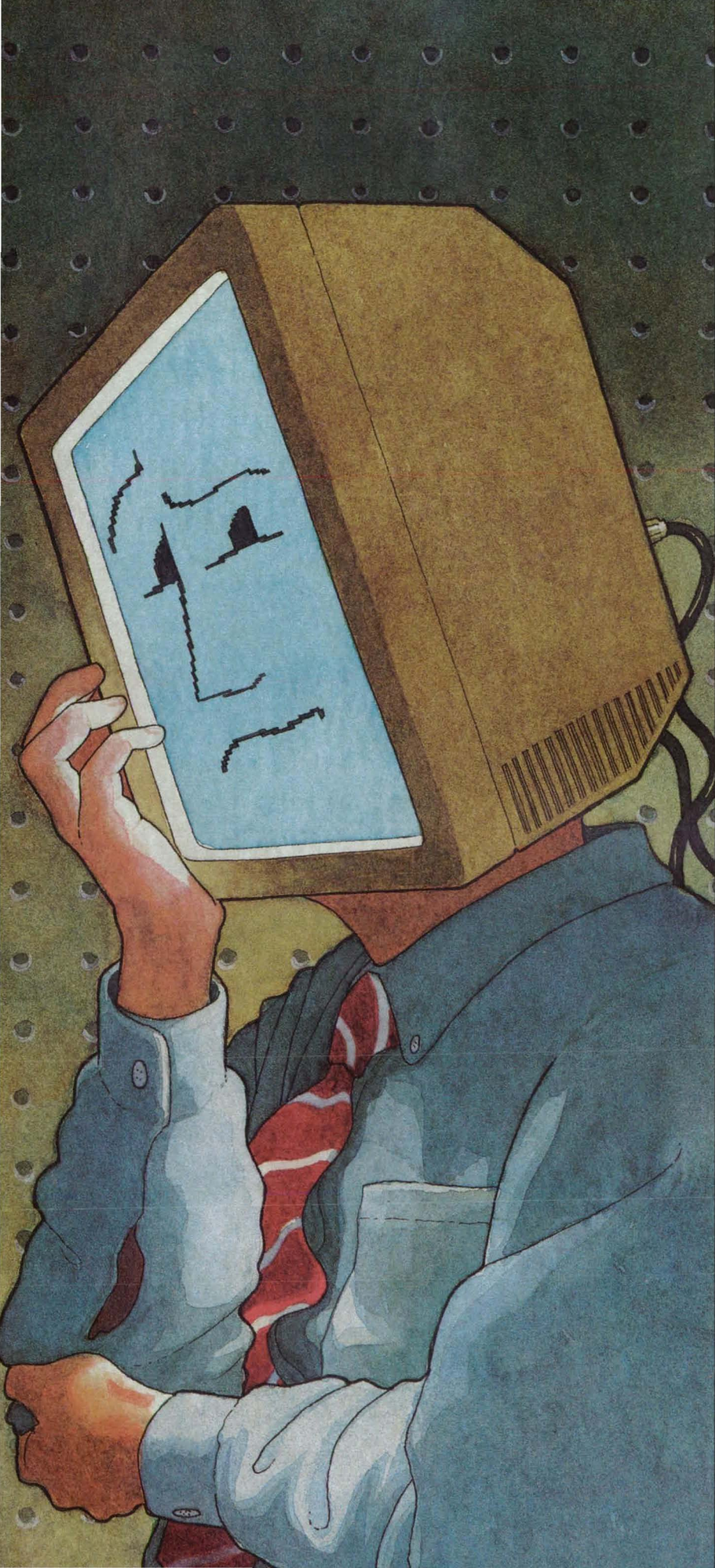

**THE MOST
ADVANCED SIMULATION
SOFTWARE SHOULDN'T MAKE
AN ENGINEER FEEL LIKE
A BLOCKHEAD.**

No long learning curve. No detailed programming. No mind-bending code. With the new Graphic Modeller™ from MGA, it's easier than ever to use ACSL, the standard in simulation software with over 30,000 users throughout the world. It eliminates virtually all of the roadblocks required to use simulation software as advanced as ACSL. So you can do more simulation, improve your designs and get to market faster. Instead of making you feel simple, we made ACSL simple and easy to use.

For a free computer demonstration disk, call 1-800-647-ACSL.

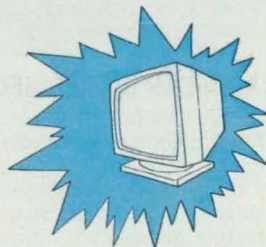

**Mitchell and Gauthier
Associates, Inc.**

The only real choice for simulations.
For More Information Write In No. 626

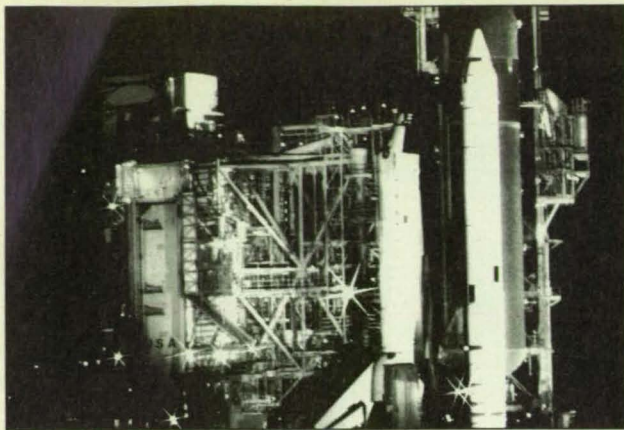

Precision Flying Requires Precision Materials. Elgiloy®

- Resists Stress & Cracking
- Corrosion Resistant
- Non-Magnetic • Long Fatigue Life
- Performs Consistently in Temperatures Ranging From -300° to 850° F

Over 40
Alloys in
Strip
AND
Wire

Elgiloy® Limited Partnership



1565 Fleetwood Drive
Elgin, IL 60123
Tel: (708) 695-1900
Fax: (708) 695-0169

Pratt & Whitney and GE Approved

For More Information Write In No. 445

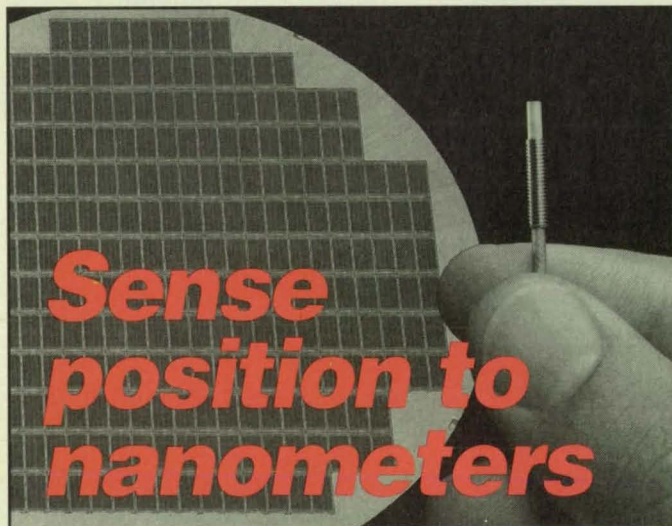

Sense position to nanometers

IT CAN MEAN HIGHER SEMICONDUCTOR YIELDS

From the delicate positioning of optical elements in mask aligners. To the calibration standard for a CVD system. A position sensor that resolves to better than a nanometer is crucial to your yield. We designed our SM μ -9100 noncontact position sensor to meet your OEM performance needs: packaging, range, operating temperature, linearity, etc. Please call today for details.

800-552-6267

Kaman Instrumentation, 1500 Garden of the Gods Road,
Colorado Springs, CO 80907 719-599-1132, Fax 719-599-1823

KAMAN

For More Information Write In No. 428

pressures higher than those of the present cooler, with consequent adverse effects on reliability and lifetime.

The three-stage regenerative sorption cooler (see figure) includes two C/Xe and two C/Kr physisorption compressors and two Pr_xCe_yO_z/O₂ chemisorption compressors arranged concentrically and axially in two sets, with radial and axial thermal coupling controlled by gas-gap heat switches. The switches are activated to transfer heat as required to effect the two-phase operating cycle. These compressors supply flows of liquid Xe, Kr, and O₂ through Joule-Thomson expansion valves to provide the cooling fluids at the three stages of refrigeration.

At the time represented in the figure, the Pr_xCe_yO_z compressor unit on the left is at its peak temperature and pressure of 500 °C and 11.8 atm (1.2 MPa), and the Pr_xCe_yO_z compressor on the right is at its minimum temperature and pressure of 285 °C and 0.023 atm (2.3 kPa). The gas-gap heat switch between the Pr_xCe_yO_z units and the central copper rod is then activated by adding small amounts of gas (e.g., helium) at about 10 torr (about 1.3 kPa) pressure. Heat from the left Pr_xCe_yO_z unit then passes through the central copper rod over to the right Pr_xCe_yO_z unit. The temperature of the two Pr_xCe_yO_z compressors eventually equalizes at about 390 °C.

Next, the heat switch between the left Pr_xCe_yO_z and concentrically located C/Kr and C/Xe compressors is filled, and the Pr_xCe_yO_z compressor continues to cool down to 285 °C, passing its remaining heat to the C/Kr and C/Xe compressors. The C/Kr and C/Xe compressors thus heat up to about 250 °C and liberate gas and pressurize to about 14.3 atm (1.45 MPa) and 25.9 atm (2.62 MPa), respectively. After cooling, the left Pr_xCe_yO_z reabsorbs oxygen at low pressure; e.g., 0.023 atm (2.3 kPa) at 285 °C.

Meanwhile, a set of three heaters heats up the right Pr_xCe_yO_z compressor from 390 to 500 °C, wherein oxygen is chemically liberated from the Pr_xCe_yO_z at high pressure; e.g., 11 atm (1.1 MPa). The right C/Kr and C/Xe compressors pass their heat through the outer gas-gap heat switch to a radiator at -13 °C. When cooled to about -13 °C, the C/Kr compressor adsorbs Kr gas at about 1.03 atm (104 kPa), and the C/Xe compressor adsorbs Xe at about 1.01 atm (102 kPa).

By alternately filling and evacuating the gas-gap heat switches and turning the heaters in the Pr_xCe_yO_z units on and off at the appropriate times, each of the compressors can be thermally cycled, thereby producing the pressures and flows required by the Joule-Thomson refrigeration loops.

This work was done by Steven Bard and Jack A. Jones of Caltech for NASA's Jet Propulsion Laboratory. For further information, write in 31 on the TSP Request Card.

This invention is owned by NASA, and a patent application has been filed. Inquiries concerning nonexclusive or exclusive license for its commercial development should be addressed to the Patent Counsel, NASA Resident Office-JPL [see page 20]. Refer to NPO-18366.

Simpler Three-Stage Regenerative Sorption Cooler

Some power efficiency can be traded for some simplification.

NASA's Jet Propulsion Laboratory,
Pasadena, California

A simpler version of the three-stage regenerative sorption cooler described in the preceding article has also been described. With the exception that it effects less regeneration

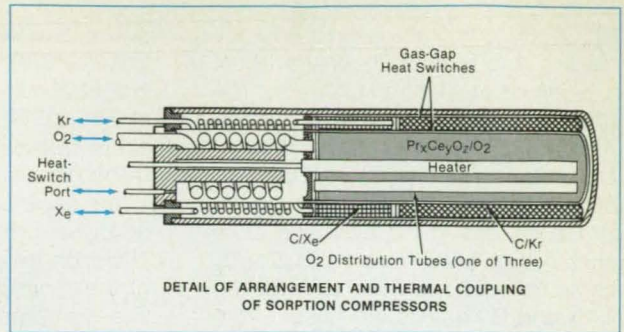
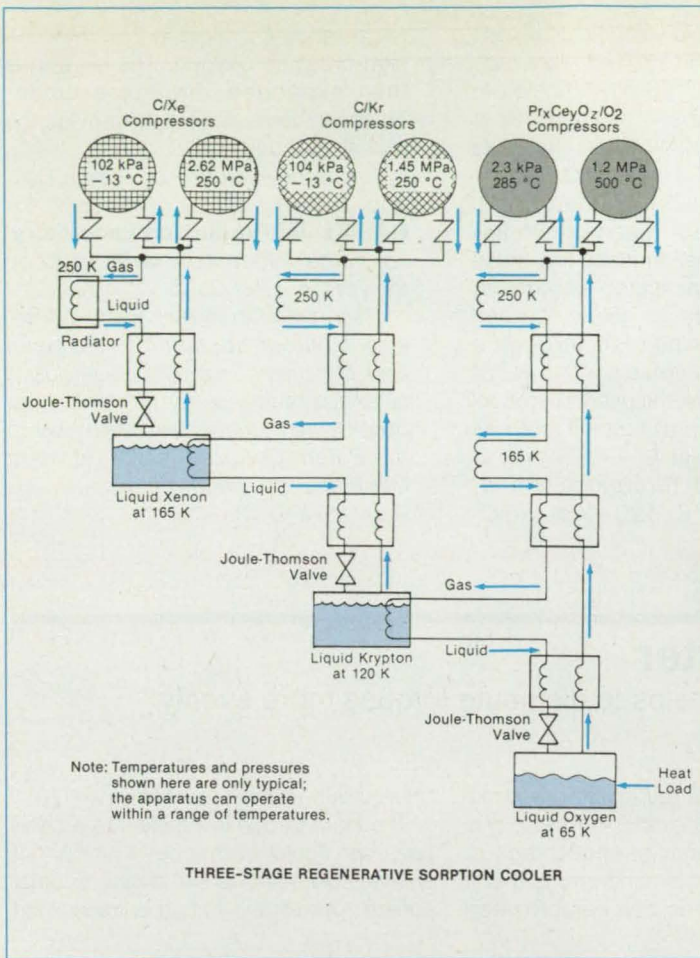

This **Three-Stage Regenerative Sorption Cooler** is a simpler version of the one described in the preceding article. In exchange for simplification, it requires about 1 1/2 times the input power of the more-complicated version.

(and, therefore requires a little more power), this version offers all the advantages of the more-complicated version. Thus, it offers an additional engineering option to trade away some power efficiency to gain some simplicity (and the reliability that accompanies simplicity). This version requires about 88 W of input power to provide 1 W of cooling at 65 K.

The simpler apparatus operates on the same cooling cycle as that of the more-complicated version. As before, C/Xe and C/Kr sorption compressors operate on waste heat from the Pr_xCe_yO_z/O₂ sorption compressor, but the heating, plumbing, and thermal-coupling configurations are simpler (see figure).

At the beginning of a typical operating cycle, the central heater heats the

No matter how you express it, it still means DERIVE® is half price.

The *DERIVE*, A Mathematical Assistant program lets you express yourself symbolically, numerically and graphically, from algebra through calculus, with vectors and matrices too—all displayed with accepted math notation, or 2D and 3D plotting. *DERIVE* is also easy to use and easy to read, thanks to a friendly, menu-driven interface and split or overlay windows that can display both algebra

$$\lim_{x \rightarrow 0} \frac{1 - \cos x}{x^2} \quad \lim_{x \rightarrow 0} \frac{x}{\sin(2x)} \quad \frac{1}{2}$$

50% 0.5

$$\sum_{n=1}^{\infty} \frac{1}{2^{n+1}} \quad \int_0^1 x dx$$

and plotting simultaneously. Better still, *DERIVE* has been praised for the accuracy and exactness of its solutions. But, best of all

the suggested retail price is now only \$125. Which means *DERIVE* is now half price, no matter how you express it.

(eXtended Memory): 386 or 486 PC compatible with at least 2MB of extended memory. Suggested list price now \$250!

System requirements

DERIVE:
MS-DOS 2.1 or later, 512K RAM, and one 3 1/2" disk drive. Suggested retail price now **\$125 (Half off!)**.
DERIVE ROM card: Hewlett Packard 95LX & 100LX Palmtop, or other PC compatible ROM card computer. Suggested retail price now **\$125!**

DERIVE XM

DERIVE

Soft Warehouse
HONOLULU • HAWAII

Soft Warehouse, Inc. • 3660 Waiialae Ave.
Ste. 304 • Honolulu, HI, USA 96816-3236
Ph: (808) 734-5801 • Fax: (808) 735-1105

DERIVE is a registered trademark of Soft Warehouse, Inc.

$\text{Pr}_x\text{Ce}_y\text{O}_z$ unit from 280 to 500 °C, causing it to liberate O_2 chemically at a pressure of 11 atm (1.1 MPa). The gas-gap heat switch between the $\text{Pr}_x\text{Ce}_y\text{O}_z$ and C/Kr units is then closed by introducing a small amount of gas, allowing heat to pass from the $\text{Pr}_x\text{Ce}_y\text{O}_z$ unit to the C/Kr and C/Xe units in such a way that the $\text{Pr}_x\text{Ce}_y\text{O}_z$ cools from 500 to 285 °C while the C/Kr and C/Xe units are heated from about -13 to 250 °C

At 285 °C, the $\text{Pr}_x\text{Ce}_y\text{O}_z$ reabsorbs O_2 at a pressure of 0.023 atm (2.3 kPa), while the C/Kr liberates krypton at 14.3 atm (1.45 MPa) and the C/Xe liberates xenon at 25.9 atm (2.62 MPa). Next, the outer gas-gap heat

switch is closed, allowing heat to pass from the C/Kr and C/Xe units to a radiator at about -13 °C. When cooled to about -13 °C, the C/Kr reabsorbs Kr at about 1.03 atm (104 kPa) and the C/Xe reabsorbs Xe at 1.01 atm (102 kPa).

The flows produced by the sorption compressors are used in Joule-Thomson refrigeration loops like those of the more-complicated apparatus. The high-pressure Xe gas is liquefied at 250 K and expanded through a Joule-Thomson valve to 165 K, at which temperature it is used to precool further the high-pressure Kr that has been precooled to 250 K. The Kr is then expanded through a Joule-Thomson valve to 120 K, at which

temperature it is used to preliquefy the high-pressure oxygen. The oxygen is then expanded through a Joule-Thomson valve to 65 K to provide the final-stage cooling.

This work was done by Steven Bard and Jack A. Jones of Caltech for NASA's Jet Propulsion Laboratory. For further information, write in 42 on the TSP Request Card.

This invention is owned by NASA, and a patent application has been filed. Inquiries concerning nonexclusive or exclusive license for its commercial development should be addressed to the Patent Counsel, NASA Resident Office-JPL [see page 20]. Refer to NPO-18367.

Floating-Pinion Torque Splitter

Designed-in looseness at the right locations helps to distribute torques more evenly.

Lewis Research Center, Cleveland, Ohio

A gear-drive mechanism helps to apportion torques nearly equally along two parallel drive paths from an input bevel gear to an output bull gear. A mechanism of this type could be used, for ex-

ample, as part of a redundant drive train between the engine and the rotor of a helicopter. The principal advantage of this torque-splitting mechanism is that it weighs less than do comparably rated

prior torque-splitting mechanisms.

The input torque is supplied to a bevel gear (see figure) from a bevel pinion (not shown) connected to the engine or other source. Overall, the torque is transmitted

The World Class Leader In Fibrous Ceramics And High Performance Insulation, Is ZIRCAR Products Inc., On The Cutting Edge Of Technology.

At ZIRCAR[®], a complete line of off-the-shelf high temperature products is always available for immediate shipment. And ZIRCAR[®] is the acknowledged specialist in custom designed applications. For quality, performance and purity in thermal insulation, ceramic fibers, composites and vacuum formed shapes, make ZIRCAR[®] your one stop source for superior energy saving products.

Zirconia, Alumina, Alumina-Silica



Zirconia Cloths & Felts



Furnace Modules



Refractory Sheet



Custom Heaters



ZIRCAR PRODUCTS INC.
110 N. Main St., PO Box 458
Florida, New York 10921-0458
(914) 651-4481 • Telex 996608
FAX (914) 651-3192

POLYMER ENGINEERING MATERIALS TO MATCH YOUR DEMANDING DESIGN, PRODUCTION AND COST REQUIREMENTS

CONAP® creates and supplies a wide range of special engineered materials... including unique polymers... to meet the critical applications of the aerospace, computer, defense, bio-medical, electrical/electronics, automotive and associated industries.



Electrical Insulating Materials



A wide range of polyurethane and epoxy, filled and unfilled, potting and encapsulating compounds for the electrical/electronics industry.

CONATHANE® and CONAPOXY® potting and encapsulating materials are used worldwide for potting electrical components such as transformers, modules, strain sensitive circuitry, coils, cable connectors and similar devices.

CONAP potting materials meet the requirements for many military and commercial specifications. In addition, a number of CONATHANE potting materials have received UL-Recognition.

For More Information Write In No. 531

Tooling Resins and Elastomers

Liquid, two-component, CONATHANE room or elevated temperature curing elastomers and CONAP elastoplastics, ranging in hardness from 40 Shore A to 80 Shore D.



These systems are typically used for casting abrasion-resistant parts, checking fixtures, stamping dies, press pads, rollers, core boxes, flexible molds and a variety of other applications.

In addition, CONAP offers a complete series of high-performance polyether, polyester and aliphatic elastomers.

For More Information Write In No. 532

Adhesives and Sealants

One and two component epoxy adhesives, two component polyurethane and epoxy adhesive/sealants and primers for bonding materials to a wide variety of substrates.



Extensive versatility; low viscosity to highly thixotropic; flexible to rigid; room or elevated temperature curing. Adhesives for industrial/structural applications. Sealants for bio-medical, air and liquid filtration.

For More Information Write In No. 533

Conformal Coatings

CONAP has developed a wide range of coatings for the electrical/electronics industry, for military and commercial applications.



Several CONAP coatings meet the requirements of military specifications.

These include: polyurethanes, acrylics and silicones. We take pride in being one of the first formulators to receive UL-Recognition for several of our polyurethane and acrylic conformal coatings.

Included among the MIL-Spec approved and UL-Recognized coatings is a unique, single component, water-based polyurethane coating.

For More Information Write In No. 534

Chemical Products

CONACURE® curing agents for epoxies and polyurethanes.

Accessory Products

Mold release agents and color concentrates for epoxy and polyurethane resin systems.

CONAP Research Provides Answers

Challenged by our customers daily with problems in polymer science, CONAP's skilled and imaginative R&D team responds. We continually create materials matched to meet your most difficult product performance specifications.

CONAP has more than 30 years experience as an innovative problem solver. We employ the latest technology to help our people provide you with fast and accurate answers.

Economical Manufacturing, Convenient Packaging and Prompt Shipping For Any Size Order

Whether you require large quantities of standard products, or small quantities of specialized materials, we can manufacture them efficiently, effectively and economically.

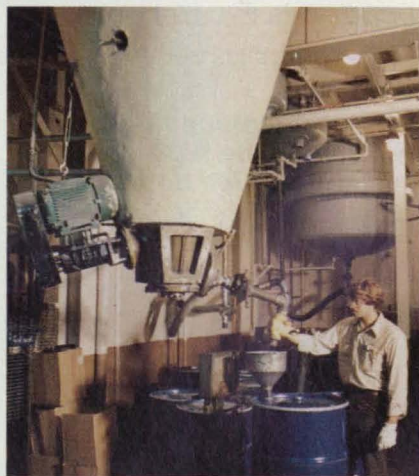

We are fully equipped to manufacture low viscosity, high viscosity and thixotropic material systems, requiring simple blending, high shear mixing or high temperature reactions.

CALL OR WRITE FOR A FREE CAPABILITIES BROCHURE!

For More Information Write In No. 535

conap®

CONAP, INC.
1405 Buffalo Street
Olean, NY 14760-1139
(716) 372-9650
FAX: (716) 372-1594
TELEX: 510-245-2769

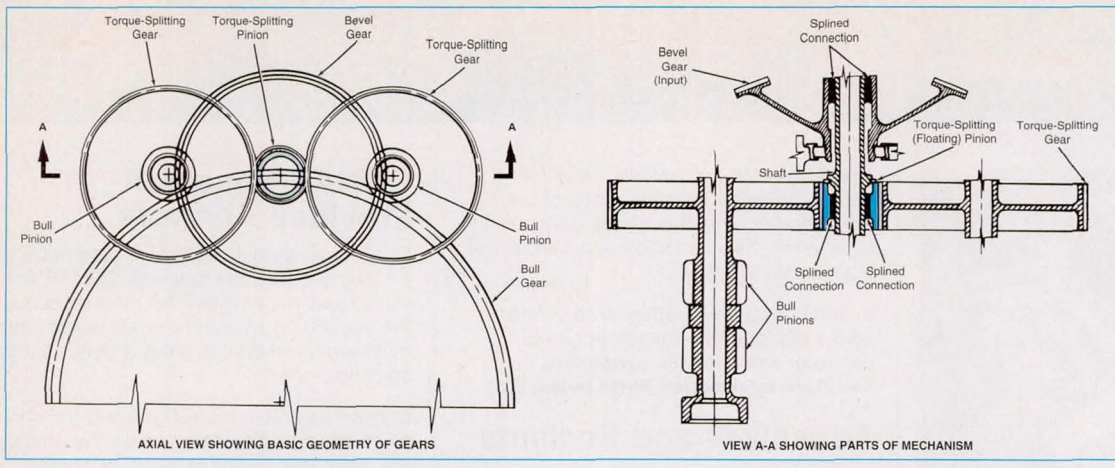

Splined Connections permit small angular excursions of a shaft, the bevel gear on its upper end, and the torque-splitting pinion on its lower end. These small excursions are essential for equalization of torques in the presence of machining tolerances and other geometric imperfections of the drive train.

Who says graphics programmers can't interact?

You can...with Exponent Graphics® for FORTRAN, C, and X - the only interactive graphics libraries that are both flexible *and* easy to use.

"Exponent Graphics fills an open niche in the high-end scientific graphics domain."
Matthew Witten, *Sun World*

Exponent Graphics includes:

- powerful, built-in interactive editing and customization tools
- presentation-quality 2D and 3D graphs callable from FORTRAN, C, and X
- utilizes various graphics accelerators for improved interactive performance
- only two function calls to automatically produce one of over 30 different plot types
- nearly 300 attributes for modifying plot characteristics
- CGM and many other device drivers included at no charge

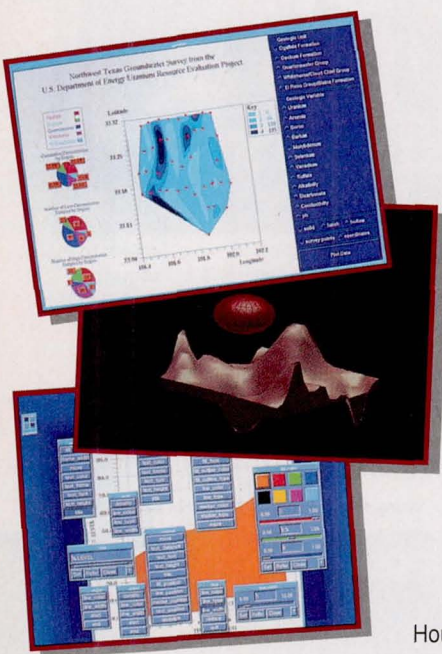

FORTRAN and C application development tools from

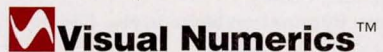

Houston • Boulder • London • Paris • Stuttgart • Tokyo

from the bevel gear through a torque-splitting pinion to two torque-splitting gears, then from the two torque-splitting gears through the associated two bull pinions to the bull gear, then to the output shaft. The purpose of the torque-splitting feature is to distribute the loads as nearly equally as possible to all gear teeth in the two parallel load paths to keep the load on each tooth as nearly equal as possible, thereby prolonging the life of the gear train.

In a redundant drive mechanism, of the same basic configuration but without explicit provision for torque splitting, the slightest deviation from precision in machining could cause the entire load to be transmitted along one of the two paths while the gear and pinion in the other path rotate freely. To provide explicitly for torque splitting in the presence of manufacturing tolerances, elastic deformations, and other deviations from the nominal precise gearing geometry, it is necessary to incorporate a low-spring rate member at one or more critical locations in the mechanism.

In this mechanism, the resultant load on the torque-splitting pinion is zero when the torque is identical on the left and right members. If there is a difference in torque, the resultant load will displace the torque-splitting pinion until the loads are again in balance, thereby ensuring equal loads in each path.

This work was done by Harold W. Melles of United Technologies Corp. for Lewis Research Center. For further information, write in 100 on the TSP Request Card. LEW-15073

For more information or for a **30-day free trial**, call **1-800-364-8880** or 713-954-6785. Fax 713-781-9260. International inquiries will be forwarded to our subsidiaries.

Supported on Sun Microsystems, Hewlett-Packard®, Silicon Graphics, IBM®, and Digital Equipment™ computing platforms. Exponent Graphics for FORTRAN also available on Convex™, and Cray systems.

Visual Numerics, IMSL and Exponent Graphics are trademarks of Visual Numerics, Inc. All other brand or product names are trademarks of their respective owners.

AD9451

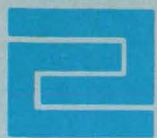

Robotic Processing of Rocket-Engine Nozzles

Advantages will include reduction of processing time and increase in consistency of results.

Marshall Space Flight Center, Alabama

An automated manufacturing cell that will contain a computer-controlled robotic processing system is being developed to implement some important related steps in the fabrication of rocket-engine nozzles. The robotic processing system will perform several tedious and repetitive fabrication, measurement, adjustment, and inspection processes and subprocesses that are now performed manually. The manual versions of these processing steps are not only labor-intensive and time consuming but also involve considerable subjectivity of judgment, inconsistency of results, and difficulty in acquisition of archival process data.

The automated manufacturing cell will offer the advantages of reduced processing time, greater consistency, excellent collection of data, objective inspections, greater productivity, and simplified fixturing. The computer-controlled robotic processing system will also afford flexibility: by making suitable changes in hardware and software, it will be possible to modify the process and subprocesses. This flexibility should also make the work cell adaptable to fabrication of heat exchangers and other items structured similarly to rocket nozzles.

The manufacturing cell will contain a standard nozzle dolly that will be modified to rotate the nozzle under computer control. Several of the processes and subprocesses will be performed with the nozzle mounted in the same position on the dolly. A robotic arm with two degrees of freedom will position an end effector (see figure). As the various processes and subprocesses are performed, the

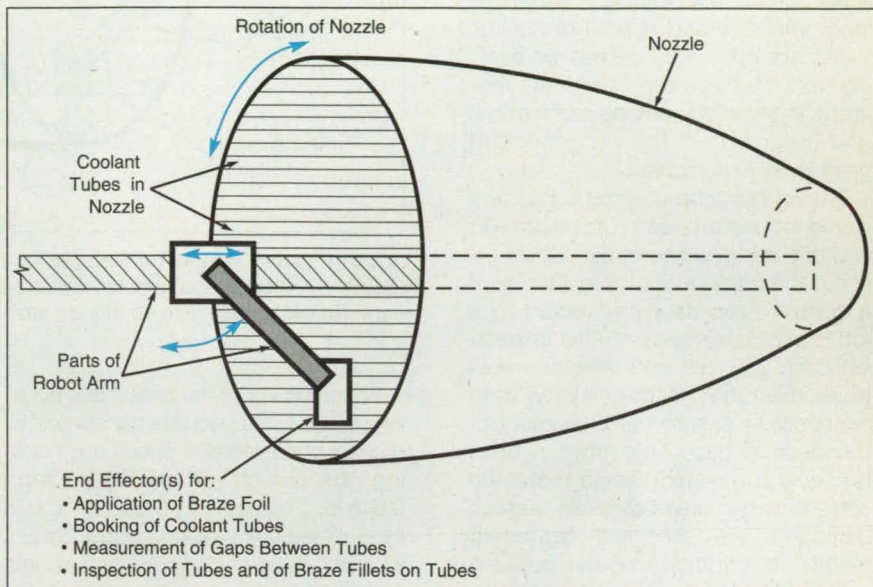

The Nozzle (or Other Workpiece) in Process will be rotated while a two-degree-of-freedom robot arm positions an end effector.

robotic arm will be fitted with various end effectors, each designed for a specific subprocess. The end effectors will be removed and installed either manually or else automatically by use of a robotic quick-change mechanism. The control software will be written in modules, all of which will be loaded into the computer. Each module will be capable of running independently and will control a particular process or subprocess. To supplement the computer-controlled collection of process data, a videotape recorder can be used to monitor the process and provide a visual record of the work performed.

Processing steps that have been selected for automation include the appli-

cation of brazing foil, inspection of gaps between coolant tubes, booking of coolant tubes (see accompanying article), application of brazing alloy paste, and inspection of coolant tubes and of braze fillets on coolant tubes. Several preliminary proof-of-concept experiments have shown that these steps can be implemented in manners that are similar enough to enable integration of them into the processing routine of the automated manufacturing cell.

This work was done by Jeffrey L. Gilbert, John E. Maslakowski, David A. Gutow, and David C. Deily of Rockwell International Corp. for Marshall Space Flight Center. No further documentation is available. MFS-29927

Robotic Booking of Coolant Tubes

Advantages would include complete brazeable area and elimination of damage.

Marshall Space Flight Center, Alabama

A robotic tube-booking subsystem has been proposed for use in the automated manufacturing cell described in the

preceding article, "Robotic Processing of Rocket-Engine Nozzles" (MFS-29927). As used here, "booking" means

deformation of the tubes and adjustment of their positions to obtain the desired gaps between them.

In the case of the nozzle of the Space Shuttle Main Engine, to which the tube-booking system would be applied initially, the gaps between the coolant tubes must be 0.003 in. (0.076 mm) or less to ensure brazeability. Where the gaps are larger, the tubes must be booked to this specification without damaging them. At present, booking is done manually by use of a ball-peen hammer and polytetrafluoroethylene sheet. Manual ball peening is extremely labor-intensive and difficult to control; tubes are frequently dented or over-booked. Furthermore, there are variations in technique among technicians, and judgment of the reductions in gaps is very subjective.

The robotic tube-booking subsystem would include an electric or pneumatic end effector (see figure) that would inspect the gaps under the guidance of a control processor connected to a robotic vision subsystem. After inspecting each gap, the end effector would book the tubes in the vicinity, then reinspect to ensure the attainment of the desired gap. The robotic tube-booking subsystem would make the entire tube-gap area brazeable, without damage to the tubes, with consistent results. In addition, robotic booking would take less time and cost less than manual booking does.

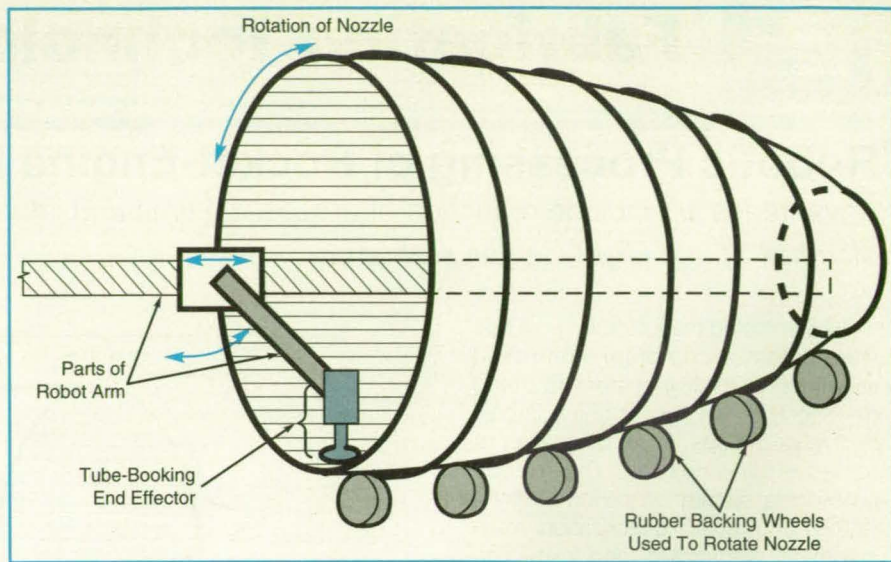

Coolant Tubes Would Be Booked (that is, deformed) and inspected robotically by a specially designed end effector under computer control with dedicated application software. No system that can do this is commercially available now.

The feasibility of the pneumatic booking process has been demonstrated by manual operation of a pneumatic booking gun, which reduced gaps from 0.016 in. (0.41 mm) to 0.003 in. (0.076 mm) or less. It would be desirable to incorporate noise-damping features into a production version of the robotic tube-booking subsystem.

This work was done by Garret E. Wagner, David A. Gutow, Jeffrey L. Gilbert, and David C. Deily of Rockwell International Corp. for Marshall Space Flight Center. No further documentation is available.
MFS-29925

Bolted Structural Joint Sustains Reversing Shear Load

Eccentric bushings accommodate tolerances, yet provide a snug fit.

Marshall Space Flight Center, Alabama

The figure illustrates a bolted structural joint that satisfies competing requirements to accommodate tolerances yet fit snugly to sustain reversing shear loads. One technique

used heretofore to accommodate tolerances between two structural members has been to drill oversize holes, then bolt the members together with washers covering the holes; but such joints,

with their loose fits, cannot sustain high reversing shear loads. Alternatively, matched holes could be marked and drilled in both structural members at assembly to obtain the tight fit needed to sustain reversing shear loads, but this technique is not suitable for assembly of the structure in the field.

The present bolted joint includes a shear block that is riveted to one of the structural members. This shear block contains an oversize hole, which accommodates the tolerances on the centers of the boltholes in both structural members. Two eccentric bushings that fit precisely with each other, with the hole in the shear block, and with the bolt provide the snug fit needed to sustain reversing shear loads. The bushings can be turned, by use of knurled flanges, to align the bolt with the bolthole in the other structural member; this latter bolthole fits the

Vacuum Pump Vibration Isolator



NEC vibration isolators effectively remove turbomolecular and cryo pump vibrations.

Available in elastomer and air-isolated versions, they are UHV compatible, have short insertion lengths and high conductance. A wide variety of flanges are available.

**National
Electrostatics
Corp.**

7540 Graber Rd., P.O. Box 620310
Middleton, Wisconsin 53562-0310
Tel. 608/831-7600 • Fax 608/256-4103

Contact NEC for detailed product specification sheets describing the models VI-1 and VI-2.

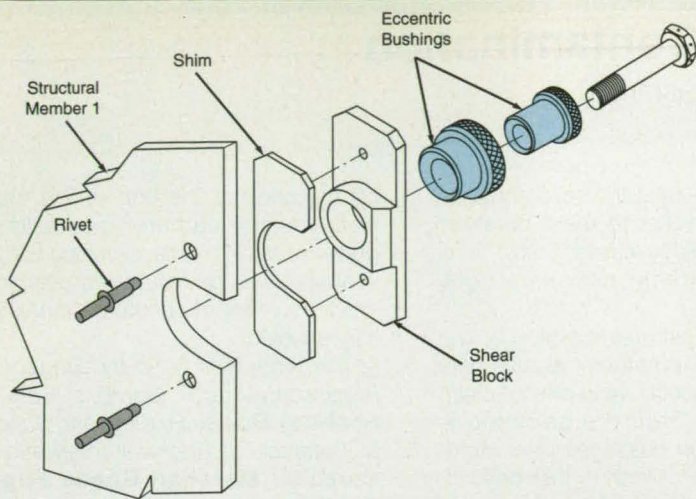

EXPLODED VIEW (OMITTING STRUCTURAL MEMBER 2 AND NUT)

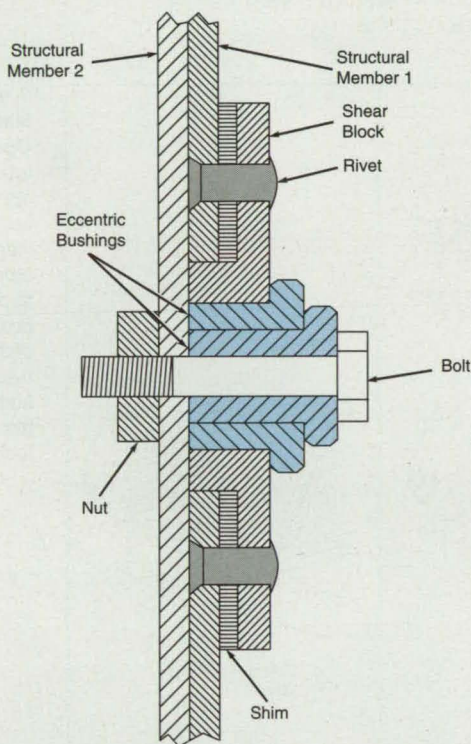

CROSS SECTION OF COMPLETED JOINT

Inner and Outer Eccentric Bushings fit in a shear block. Frictional force generated by bolt tension prevents rotation of the bushings after assembly.

TURBOMACHINERY DEVELOPMENT MADE EASY



With advanced turbomachinery software systems from NREC you can balance performance, reliability, and cost.

Or, we can do it for you.

Product Design & Development

Services include product specification, feasibility studies, fluid and mechanical design, controls engineering, finite element analysis, rerating, performance upgrades, and failure analysis.

Specialized CAE/CAM Software

Advanced technology software improves design, performance prediction, vibration analysis, and N/C machining of compressors, pumps, and turbines.

Precision Manufacturing

NREC provides the highest quality 5-axis machining of complex impellers, rotors, blades, and blisks, up to 60 inches, plus balancing, spin testing, and assembly.

For More Information

Please request free literature or contact Frank Hines to discuss your application. Phone 617 937-4655 or Fax 617 935-9052.

NREC

Northern Research and Engineering Corporation

39 Olympia Avenue, Woburn MA 01801
A part of worldwide Ingersoll-Rand

bolt precisely.

When the bolt is tightened, the resulting friction between the flanges of the eccentric bushings and between the shear plate and the flange of the outer eccentric bushing is more than enough to prevent the eccentric bushings from turning when reversing shear loads generate turning moments. In tests, a bolt prestressed to 18 kpsi (124 MPa) locked the bushings against rotation at an applied shear load of 3,800 lb (16.9 kN).

This work was done by J. B. Mott and D. Medley of Teledyne Brown Engineering for **Marshall Space Flight Center**. For further information, **write in 29** on the TSP Request Card.

Title to this invention has been waived under the provisions of the National Aeronautics and Space Act [42 U.S.C. 2457(f)], to the Teledyne Industry. Inquiries concerning rights for its commercial use should be addressed to

*Teledyne Brown Engineering
A Division of Teledyne Industries Inc.
Cummings Research Park
Attn: F. R. Andrzejewski
Director of Contracts
300 Sparkmann Drive N. W.
P.O. Box 070007
Huntsville, AL 35807-7007*

Refer to MFS-28744, volume and number of this NASA Tech Briefs issue, and the page number.

Balloon Catheter Prevents Contamination

An inflatable device seals out debris from machining.

Marshall Space Flight Center, Alabama

A balloon catheter similar to that used in such medical procedures as angioplasty and heart surgery protects small orifices against contamination and blockage by chips generated in machining operations. The catheter includes a small, inflatable balloon at the end of a thin, flexible tube. Although essentially the same as a pulmonary-artery catheter, it contains additional features that adapt it to anticontamination service. For example, the balloon is larger to fit the wider channel that it must block; it is made of polyurethane (rather than latex), which does not

fragment if it bursts; the balloon material is made thicker to resist abrasion better; and a kink-resistant axial wire helps the catheter negotiate tight bends.

The figure illustrates a typical application. First, the catheter is attached to the closed control valve of a pressurized-air line. Then the catheter is pushed through passages in a workpiece until the balloon is just beyond the position where a tube is to be cut. The control valve is opened and the air inflates the balloon. The valve is closed and cutting is begun. The balloon seals

off the parts at the end of the tube. Because the catheter can hold its pressure for 2 to 3 days, cutting can be interrupted — perhaps even overnight — without fear of contamination when it is resumed.

This work was done by Gregory A. Higginson, Marc R. Bouffard, Beth S. Hoehicke, Bradley D. King, and Sandra L. Peterson of Rockwell International Corp. for Marshall Space Flight Center. For further information, write in 33 on the TSP Request Card. MFS-29908

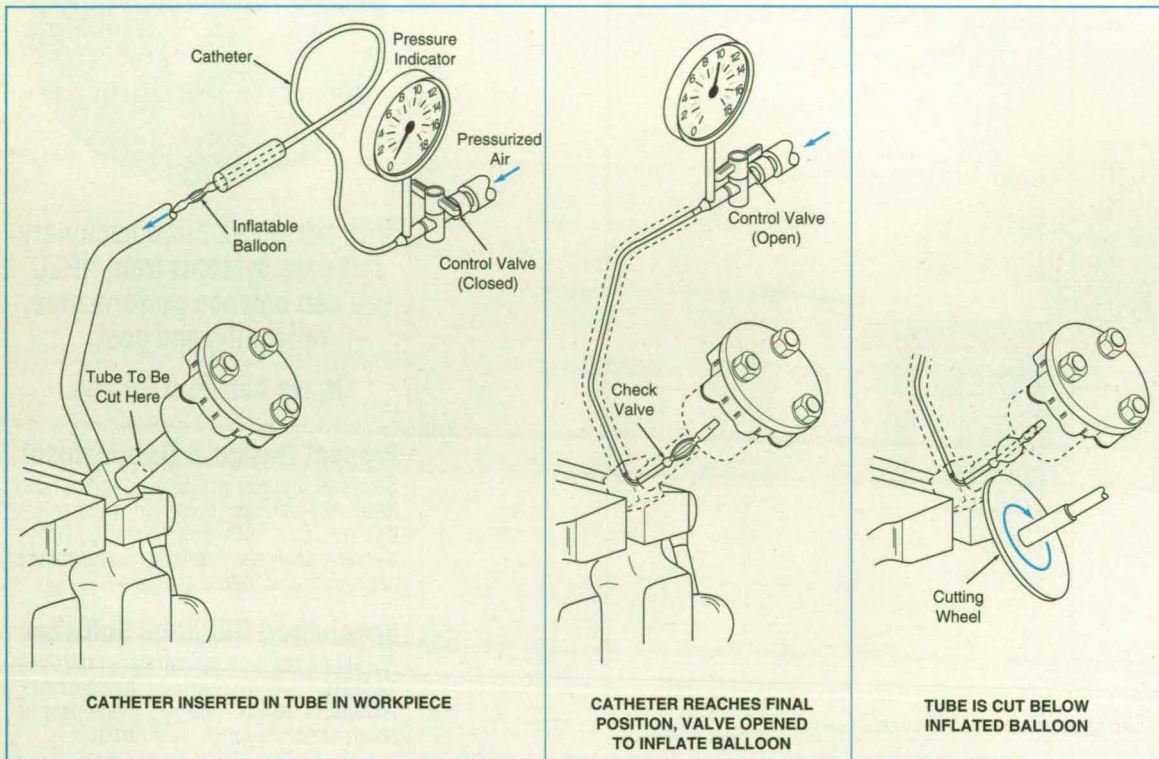

In a Typical Machining Operation, a tube is to be cut. The catheter is inserted before cutting to prevent contamination of the parts in the cylindrical body at the top of the tube.

Preventing Clogging in a Vacuum Plasma Spray Gun

Modification of powder-injection ports enables lengthy, high-temperature deposition operations.

Marshall Space Flight Center, Alabama

Graphite inserts prevent clogging of ports through which copper powder is injected into a vacuum plasma spray (VPS) gun. The graphite liners thus eliminate the need to spend production time refurbishing the VPS gun, thereby

reducing the cost of production and increasing productivity.

In the VPS process, metal or ceramic powder to be deposited is injected into a plasma flame, which is created by the ionization of gases by a dc arc.

This flame melts and accelerates the powder toward a substrate on which the powder is to be deposited. The plasma gun includes a tungsten cathode and a water-cooled copper anode, into which the powder-injection

ports have been drilled (see top part of figure). The VPS gun in question is being considered for use in depositing a copper alloy to form combustion-chamber liners thicker than 0.1 in. (0.25 cm). Deposition to such a thickness necessitates operation of the VPS gun at high temperature for several hours, during which powder builds up until it clogs the powder-injection ports, causing premature termination of deposition.

The powder-injection ports were modified by drilling them out to a larger diameter to accommodate the graphite inserts (see bottom part of figure). Graphite was chosen for this application partly because it can be tailored to have high thermal conductivity and high hardness to reduce wear. More important, however, is that copper does not wet or stick to graphite because of surface-energy considerations. The powder-port-liner concept could also be applied to other material systems to be used for net-shape fabrication via VPS if these considerations are evaluated case by case.

This work was done by Phillip D. Krotz, Ronald L. Daniel, Jr., and William M. Davis of Rockwell International Corp. for Marshall Space Flight Center. For further information, write in 38 on the TSP Request Card. MFS-29938

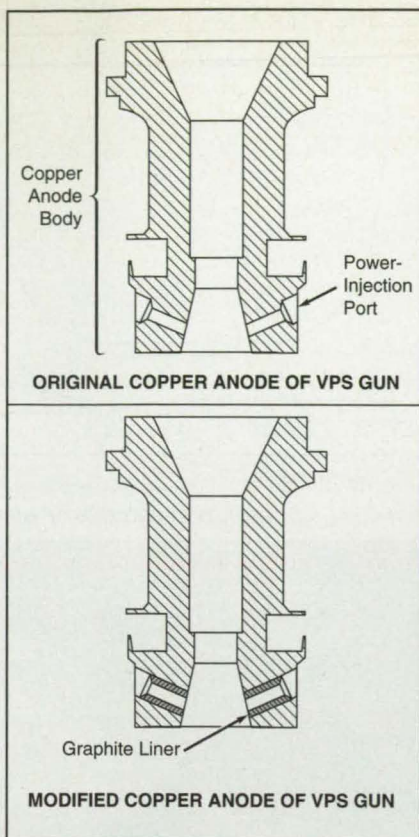

Graphite Inserts in the modified anode prevent clogging because copper does not wet or stick to graphite.

Wire-Guide Manipulator for Automated Welding

The wire guide can be moved in three dimensions.
Marshall Space Flight Center, Alabama

A compact motor drive positions a guide for welding filler wire. The drive is part of an automated wire feeder in a partly or fully automated welding system. The device is suitable for both variable-polarity plasma arc welding and gas/tungsten arc welding.

The drive unit moves the filler wire holder — and thus the tip of the wire at the weld bead — in three degrees of freedom:

- Linear motion perpendicular to the direction of welding (perpendicular to the plane of the workpiece) over a range of 1 in. (2.54 cm),
- Transverse to the direction of welding (but in the plane of the workpiece) over a range of 0.5 in. (1.27 cm), and
- Rotation over a range of 30° in

the plane perpendicular to the direction of welding.

To provide these three degrees of freedom in a small package, the design of the drive incorporates an unusual system of three parallel lead screws, attached to the filler-wire guide with pivoting rod-end joints (see figure). By suitable control of common and relative motions of the lead screws, the wire guide can be made to move as desired. For example, motion of all screws in the same direction at the same speed moves the holder perpendicular to the plane of the workpiece. Moving screws 1 and 2 opposite to screw 3 moves the holder transversely. Moving screws 2 and 3 opposite to screw 1 rotates the holder.

Each lead-screw mechanism includes

DATA ACQUISITION

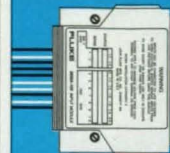

Fluke's new Hydra Data Bucket lets you connect 21 different user-selectable inputs with no external signal conditioning.



Its removable Memory Card lets you store data for later analysis on a PC.

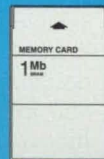

Thermocouples, RTDs, DC voltage, AC voltage (True RMS), frequency, resistance — the Data Bucket collects data from virtually any sensor type. The Memory Card makes it easy and convenient to transfer data to your PC.

Call today for more information and a FREE demo disk.

1-800-443-5853

FLUKE®

© 1993, John Fluke Mfg. Co., Inc. Ad. No. 00317

From one to a billion.

If we can give you 3-day delivery on one prototype rubber part – how long will it take for a billion parts?

Try us and see. You'll be surprised. Our modern manufacturing facilities ensure on-time delivery – on orders from 100 to 1 billion units at very competitive prices. And our SPC Program assures you of consistently high quality on orders of any size.

As for our 3-day prototypes, just send us a sketch, blueprint or product sample – and we'll take it from there. We'll analyze your design, select the compound, and produce sample parts that meet your exact needs.

So, whatever your requirements, give us a try. And we'll give you the kind of personal attention and service that keeps our customers coming back for more.

Millions –
even billions
– more.

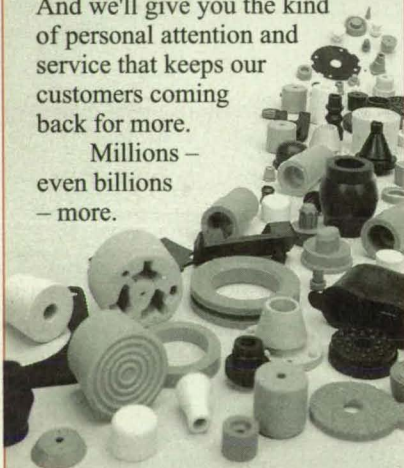

SYNTEX
RUBBER CORPORATION

938 Crescent Avenue, P.O. Box 4006NI 3
Bridgeport, CT 06607
Tel (203) 367-8469 Fax (203) 367-6403

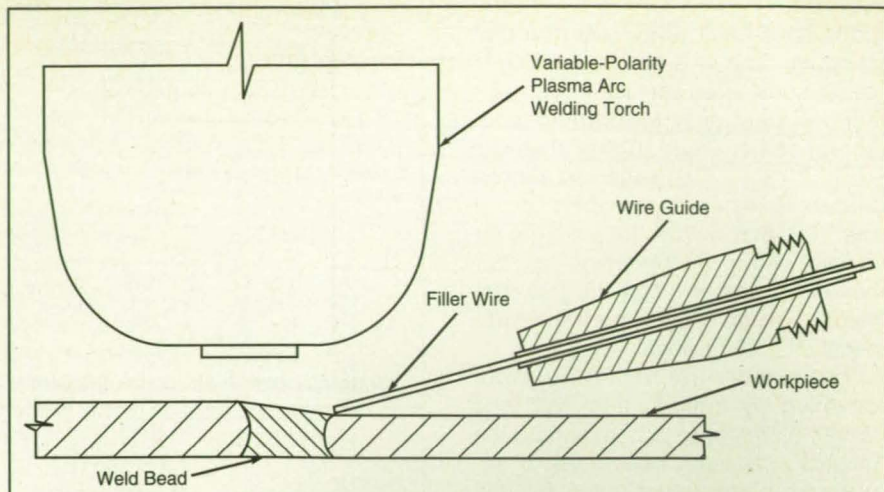

RELATIVE POSITIONS OF WIRE GUIDE, TORCH, AND WORKPIECE

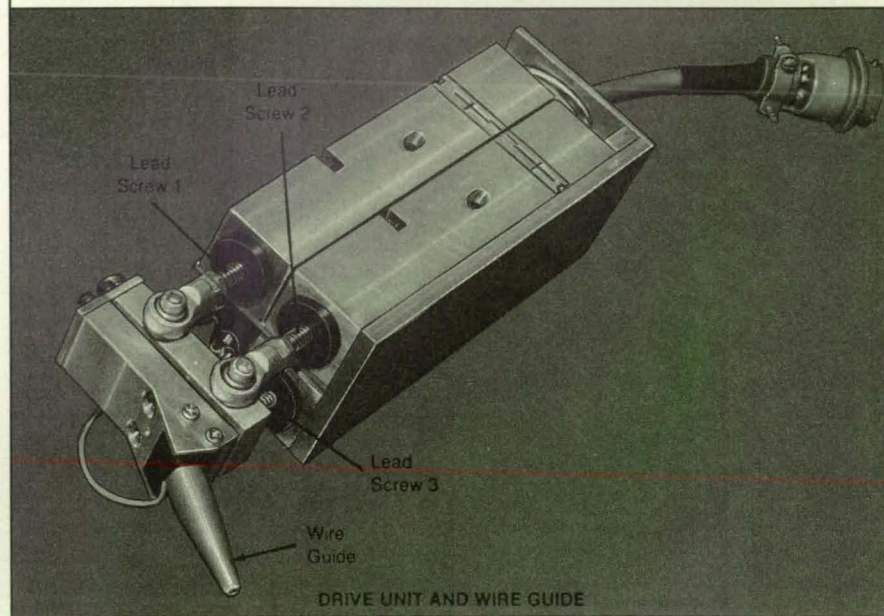

The Drive Unit contains three parallel subunits. The rotations of the lead screws in the three subunits are coordinated to obtain the desired motions in three degrees of freedom.

a motor of 22-mm diameter with an encoder and gearhead coupled directly to a drive sleeve and nut held by a single bearing. The nut drives the lead screw. An optical switch detects the arrival of the lead screw at the midpoint of its travel. The encoder measures the distance traveled from the midpoint and thereby provides a position-feedback signal to control circuitry. Motor control is complex because all three motors are used for each degree of freedom and their motions must, therefore, be coordinated.

The drive contains relatively few moving parts. It is contained in a monolithic housing. It includes a rigid coupling between each motor and its drive sleeve, plus only one bearing per lead screw. These features make it possible to keep the drive unit small. However, proper functioning necessitates accurately

machined components; precise concentricity between all rotating components is critical. The drive exhibited no mechanical failures during many hours of testing in a simulated production environment.

This work was done by Tim Morris, Kevin White, Steve Gordon, Dave Emerich, Dave Richardson, Mike Faulkner, Dave Stafford, Kim McCutcheon, Ken Neal, and Pete Milly of Nichols Research Corp. for Marshall Space Flight Center. For further information, write in 34 on the TSP Request Card.

Inquiries concerning rights for the commercial use of this invention should be addressed to the Patent Counsel, Marshall Space Flight Center [see page 20].

Refer to MFS-26231.

Multiple Pages Intentionally Left
Blank



Optimal Preprocessing of GPS Data

The number of data is reduced without degrading the strength of the data.

NASA's Jet Propulsion Laboratory, Pasadena, California

An improved technique for preprocessing data from a Global Positioning System (GPS) receiver reduces the processing time and the number of data that have to be stored. The technique is optimal in the sense that it maintains the strength of the data. It can also sometimes increase the ability to resolve ambiguities in the numbers of cycles of the received GPS carrier signals.

To give meaning to even a brief description of the improved preprocessing technique, it is necessary to describe some aspects of preprocessing and processing of GPS data. Preprocessing of GPS data involves combination of the four streams of GPS data, which are described below, into one stream of data. As used here, "strength" denotes a semiquantitative measure of the validity, utility, and/or precision of the data, and it increases with decreasing standard deviation of the data.

Preprocessing is applicable to data on the signals received from one GPS satellite. Each GPS satellite transmits at two frequencies: $f_1 = 1.57542$ GHz and $f_2 = 1.2276$ GHz. By use of (1) satellite-ephemeris data broadcast via at least four GPS satellites themselves plus (2) measured times of arrival of signals from these GPS satellites, the data-processing subsystem in a GPS receiver can compute the position of the receiver. The range (distance) between the receiver and each satellite transmitter is an essential component of GPS data.

A GPS receiver can acquire two types of precise data from the f_1 and f_2 signals from each satellite: these are the P-code pseudoranges and the phases of the f_1 and f_2 carrier signals. Except for contamination by clock errors, atmospheric delays, and instrumental delays, pseudorange is an absolute measure of the range between the transmitter and the receiver. The phase of a carrier signal is also a measure of range but differs from pseudorange in two respects: it is biased by an unknown integral number of cycles, and it is characterized by a data noise much lower than that of pseudorange. Hence, these two data types complement each other nicely,

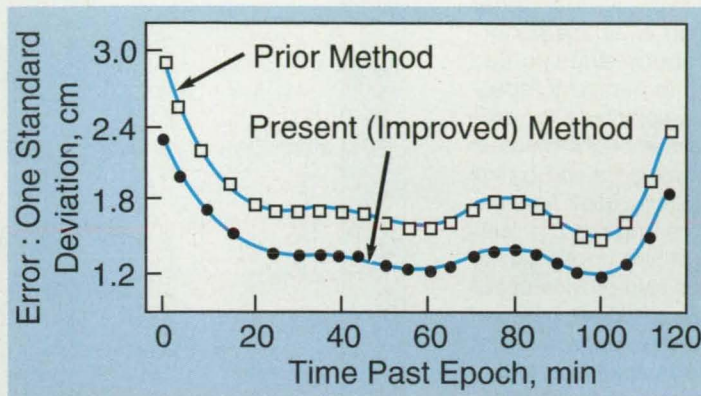

The Error in Determination of Position of a site that carries a GPS receiver is reduced by use of the improved data preprocessing technique.

and together they provide information substantially stronger than does either by itself.

It is common practice to combine measurements at the two frequencies to remove the ionospheric delays. This combination is performed independently, and thus suboptimally for pseudorange and carrier phase, leaving two streams of data to be used in the estimation process that follows. These two streams of data can be combined further to reduce the volume of data, but the preprocessing technique used heretofore for this purpose was again suboptimal in that it diminished the strength of the data.

The four streams of GPS data from one satellite are given by

$$\Phi_1(t_i) = \rho(t_i) - \alpha_1 \xi(t_i) + B_1 \text{ with data noise } \sigma_\Phi$$

$$\Phi_2(t_i) = \rho(t_i) - \alpha_2 \xi(t_i) + B_2 \text{ with data noise } \sigma_\Phi$$

$$R_1(t_i) = \rho(t_i) + \alpha_1 \xi(t_i) \text{ with data noise } \sigma_R$$

$$R_2(t_i) = \rho(t_i) + \alpha_2 \xi(t_i) \text{ with data noise } \sigma_R$$

for $i = 1, 2, \dots, N$, where t_i is the i th observation time, Φ is the measured phase of a carrier signal, R is a measured pseudorange, the subscripts 1 and 2 denote the two frequencies, $\rho(t_i)$ is the ionosphere-free pseudorange, $\xi(t_i)$ is a quantity proportional to the line-of-sight ionospheric electron content, B_1 and B_2 are carrier-phase biases (ambiguities in the numbers of cycles), which are unknown and constant over the whole span of the data,

$$\alpha_1 = f_2^2 / (f_1^2 - f_2^2)$$

and

$$\alpha_2 = f_1^2 / (f_1^2 - f_2^2).$$

The data noise is assumed to be white and of the same level in the f_1 and f_2 signals. This completes the necessary description of GPS data to be preprocessed and processed.

The improved preprocessing technique is based partly on elimination of B_1 and B_2 in the data-stream equations and introduction of a correlation between the Φ_1 and Φ_2 . It is feasible to base the technique partly on these concepts because a common bias with a given uncertainty is equivalent to a fully correlated data noise of the same uncertainty. The resulting modified data-stream equations are written in a matrix-vector form that facilitates simplification, leading to a complicated but nevertheless closed-form equation that combines the four streams of data into an optimal, weighted-least-squares estimate of $\rho(t_i)$, plus an associated equation for the covariance of ρ ; the form of the latter equation is identical to that of a stream of carrier-phase measurements with a constrained bias. The figure illustrates an example of the increase in precision afforded by use of the improved processing technique.

This work was done by Sien-Chong Wu and William G. Melbourne of Caltech for NASA's Jet Propulsion Laboratory. For further information, write in 6 on the TSP Request Card. NPO-18767

Frequency Analysis of Data on Telerobotic Tasks

Spectral signatures could lend insight into design and performance.

NASA's Jet Propulsion Laboratory, Pasadena, California

Data on forces and torques measured in experiments with remote manipulators can be processed into spectral signatures via a special frequency-analysis procedure. The spectral signatures complement other measures used to evaluate performances of telerobotic systems and human operators. In particular, spectral signatures can contribute to verification of some assumptions made in designing manipulator arms and control subsystems and can be used as feedback by operators engaged in real-time monitoring of telerobotic tasks. Spectral signatures also provide useful indications of flows of power between manipulators and their environments: this is important in that it is highly desirable to minimize both task-execution times and the magnitudes of forces and torques employed in tasks, thus minimizing such flows of power.

The telerobotic experiments involve various tasks and subtasks in which the operator commands the remote manipulator to move a peg to a marked location on a board, tap the peg on the mark, move the peg to a hole in the board, insert the peg in the hole, release the peg, regrasp and extract the peg, return to and tap the mark with the peg, then move the peg to a final position. The start-and-stop motions in these subtasks give rise to sudden changes in torques and forces on the manipulator, so that traditional spectral analysis is almost useless in analyzing the resulting force and torque data. In the special frequency-analysis procedure, which was developed specifically for this application, segmentation algorithms are used to extract data on homogeneous subtasks from different experiments. By so doing, the algorithms synthesize artificial streams of data, such that all data in a given stream pertain to a given subtask — for example, move, grasp, or insert.

The segmentation algorithms include a Viterbi-decoder algorithm based on an underlying hidden Markov model of the peg-in-hole task and its subtasks. A hidden Markov model is a mathematical model of a Markov process that cannot be observed directly. Each state of the Markov model is associated with a probability density that manifests itself in the experimental observations. In most cases, the probability densities overlap, and the problem of

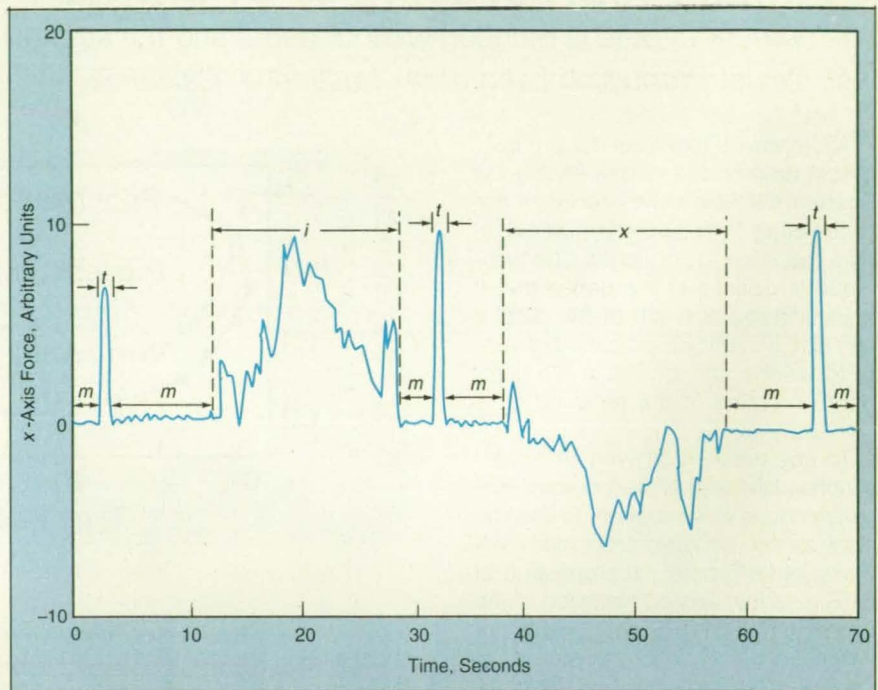

Figure 1. These **Force Data** from a peg-in-hole experiment have been segmented by use of the hidden Markov model. The letter symbols *i*, *m*, *t*, and *x* denote the "insert," "move," "tap," and "extract" Markov states, which correspond to subtasks of the same names.

recognizing the sequence of states that generates a given sequence of measurement data involves the combination of information on probabilities of transitions between states with state-observation densities and with the specific sequence of observations. The figure presents an example of segmentation of force data by use of the hidden Markov model plus intervention by the operator to establish the intermediate "tap" states that correspond to the tapping subtasks.

Following segmentation, the data that pertain to the taps are eliminated, and the remaining data on each subtask are filtered by use of a Hanning window over time. Filtering is necessary to compress the data at the tails of the subtasks and reduce their effects on the spectra. The data on homogeneous tasks are then combined into a single file, and this file is processed with a fast Fourier transform to obtain the desired spectral signature (see Figure 2).

This work was done by Paolo Fiorini and Antonio Giancaspro of Caltech for **NASA's Jet Propulsion Laboratory**. For further information, **write in 12** on the TSP Request Card.

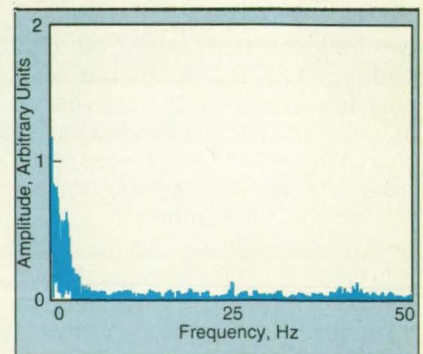

Figure 2. This **Frequency Spectrum** of force data for a complete peg-in-hole experiment was generated by the method described in the text.

This invention is owned by NASA, and a patent application has been filed. Inquiries concerning nonexclusive or exclusive license for its commercial development should be addressed to the Patent Counsel, NASA Resident Office—JPL [see page 24]. Refer to NPO-18805.



Life Sciences

Continuous-Flow Gas-Phase Bioreactors

Separation of products from aqueous solutions would not be necessary.

NASA's Jet Propulsion Laboratory, Pasadena, California

Continuous-flow gas-phase bioreactors have been proposed for biochemical, food-processing, and related industries. A reactor of this type would contain one or more selected enzymes that have been dehydrated or otherwise immobilized on a solid carrier (e.g., enzyme-coated carrier beads). Selected reactant gases would be fed into the reactor, wherein chemical reactions catalyzed by the enzyme(s) would yield product biochemicals.

This bioreactor concept is based on the discovery that enzymes do not necessarily have to be placed in the traditional aqueous environments to function as biocatalysts; enzymes at reduced hydrations have been shown to function either neat or suspended in organic solvents or supercritical fluids. This discovery has expanded the variety of reactions that can be considered for enzyme-based biocatalysts.

For those situations in which the reactants are gases or can be vaporized, gas-phase reactions in the presence of dehydrated enzymes are advantageous over reactions in aqueous solutions for several reasons. First, the dehydrated form of a typical enzyme can be more resistant to thermoinactivation than is the aqueous form: this enables the use of temperatures greater than those that could be used with aqueous solutions. Second, diffusivities in the gas phase are

orders of magnitude larger than in water. Third, the concentrations of gaseous reactants can be increased directly by increasing the pressures in the reactors, circumventing problems of low solubility in aqueous phases. Fourth, the products of gas-phase reactions (including unconverted reactants) can be separated and recovered by facilitated fractional condensation with high purities, avoiding difficult and expensive separations from aqueous solutions.

In preparation for a series of experiments to demonstrate the feasibility of this bioreactor concept, alcohol oxidase (the enzyme) was immobilized on various solid supports. Then the biocatalysts thus prepared were exposed to reactant streams of ethanol vapor in air in the effort to oxidize the ethanol to acetaldehyde. The figure shows the concentrations of acetaldehyde and unconverted ethanol obtained in one of these experiments. Further development will be needed to overcome the short lifetime of the catalyst and the low percentage of conversion, both of which are evident in these plots.

This work was done by Donald L. Wise and Debra J. Trantolo of Northeastern University for NASA's Jet Propulsion Laboratory. For further information, write in 41 on the TSP Request Card. NPO-18948

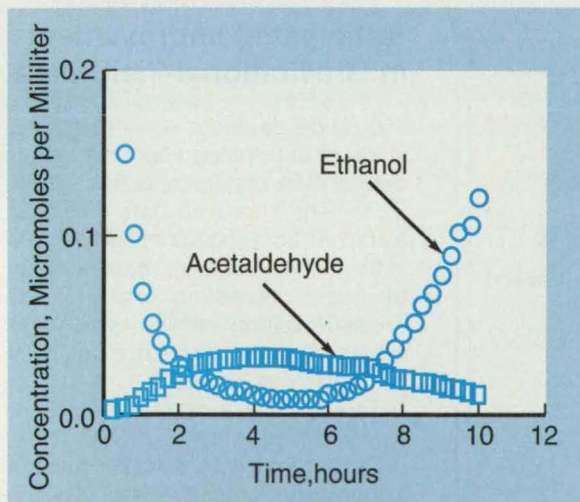

These Concentrations of Acetaldehyde and Ethanol were measured as a function of reaction time in an experimental continuous-flow gas-phase bioreactor.

Spend More Time Doing Science and Less Time Programming

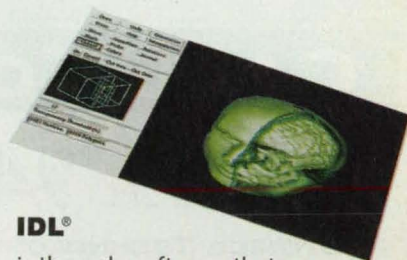

IDL®

is the only software that allows you to program four to ten times faster* than FORTRAN or C. It seamlessly integrates all of your scientific computing needs in a single package – breathtaking 2D, & 3D graphics, powerful number crunching, flexible data I/O and more. It even includes a complete GUI toolkit for creating point and click applications. And, because IDL runs on PCs, Macs, Unix and VMS workstations you won't have to rewrite your code every time you change machines.



Join the elite group of more than 20,000 scientists around the world who are saving time and money by using IDL.

Call us for a free demo.

303-786-9900 FAX 303-786-9909

Research Systems, Inc.
2995 Wilderness Place
Boulder CO 80301

IDL



*based on a survey of IDL users

Books & Reports

These reports, studies and handbooks are available from NASA Technical Support Packages (TSP's) when a Request Card is cited; otherwise they are available from NASA Technical Information Service.



PHYSICAL SCIENCES

GPS Measurements Show Subdaily Changes in Earth Rotation

A report presents an analysis of data from a 3-week worldwide Global Positioning System (GPS) tracking experiment that was conducted from

January 22 through February 14, 1991. The focus of the analysis was upon detection and interpretation of subdaily variations in the rate of rotation of the Earth. These variations are interesting since they are caused by interactions between solid and fluid portions of the Earth and permit unique insights into Earth-system science. They are important as their neglect introduces significant systematic errors in space navigation.

This work was done by Stephen M. Lichten, Steven L. Marcus, and Jean O. Dickey of Caltech for NASA's Jet Propulsion Laboratory. To obtain a copy of the report, "Sub-Daily Resolution of Earth Rotation Variations With Global Positioning System Measurements," write in 61 on the TSP Request Card. NPO-18838

CALL FOR PAPERS

LASERTECH '94

PHOTONICS TECHNOLOGY TRANSFER CONFERENCE

NOVEMBER 9, 1994

WASHINGTON, DC CONVENTION CENTER

Sponsored by the Technology Utilization Foundation and *Laser Tech Briefs* magazine

LaserTech '94, a special one-day meeting to be held concurrently with the Technology 2004 national technology transfer conference, will spotlight the best new photonics innovations developed by federal laboratories and their contractors.

Who Will Attend

Engineers, scientists, technology managers, and entrepreneurs looking for photonics technologies they can use to solve engineering problems, develop and test products, and start new businesses.

Who Should Present Papers

- Researchers from federal agencies/labs and their contractors who have produced important new photonics technologies that are available or licensable for commercial use;
- Designers and engineers whose companies have successfully exploited photonics technologies transferred from government labs.

Paper Categories

1. Lasers and Laser Systems 2. Lenses and Optical Systems 3. Fiber Optics Devices and Systems 4. Electro-Optical Systems 5. Infra-red Technology 6. Detectors, Cameras, and Imaging Devices 7. Positioning and Motion Control Equipment 8. Test and Measurement Equipment 9. Design, Fabrication, and Manufacturing

Deadline For Submission

Paper abstracts must be submitted to the Program Chairman no later than April 29, 1994. They should be 1 to 1-1/2 pages long and MUST describe the technology's novelty and commercial potential (see abstract format).

Mail or fax abstracts to:

Robert Clark
Program Chairman
LaserTech '94
41 East 42nd St., #921
New York, NY 10017
Fax (212) 986-7864
Phone (212) 490-3999

For information on attending LaserTech '94 write in no. 798.

For information on exhibiting write in no. 797.

PLEASE FOLLOW THIS FORMAT:

LASERTECH '94

Paper Abstract

Name: (if multiple authors, please provide the name of main contact to whom correspondence should be addressed)

Position/Title:

Affiliation:

Address:

Phone Number:

Fax Number:

Govt. Agency/Lab The Subject Technology Was Developed By/For:

(if contractor-developed, please include contract #)

Paper Title:

Category:

Description:

Dynamics of Two Ions in a Time-Varying Potential

A report summarizes a computer-simulation study of the motions of two ions trapped in a time-varying axisymmetric potential well. In practice, such a potential is created by applying suitably configured radiofrequency electric fields; for example, in a high-resolution trapped-ion atomic clock or frequency-standard apparatus. The two-trapped-ion problem has been studied because it is a paradigm of nonlinear dynamics, with implications not only for the behavior of larger numbers of trapped ions but also for applications as diverse as control systems and dynamics of fluids.

This work was done by Angelyn P. Williams and Lutollah Maleki of Caltech for NASA's Jet Propulsion Laboratory. To obtain a copy of the report, "Chaos and Dynamical Behavior of Two Ions Confined in RF Traps," write in 27 on the TSP Request Card. NPO-18684

Anticipated Improvements in Gravitational-Field Data

A report describes a computational study of anticipated improvements in data on the gravitational field of the Earth. The improved data would be extracted from measurements, by use of the Global Positioning System (GPS), of nearly repeating orbits of the Topex/Poseidon satellite (which was scheduled to be launched shortly after this article was written).

This work was done by William I. Bertiger, Jiun-tsong Wu, and Sien C. Wu of Caltech for NASA's Jet Propulsion Laboratory. To obtain a copy of the re-

port, "Gravity Field Improvement Using GPS Data From Topex/Poseidon: A Covariance Analysis," **write in 96** on the TSP Request Card. NPO-18333

Heating and Positioning in a Microwave Cavity

Two reports describe theoretical and experimental studies of (a) microwave dielectrophoretic positioning of a spherical sample of lossy dielectric material in a microwave resonant cavity and (b) the heating of the positioned sphere by the electromagnetic field. These studies are parts of a continuing effort to develop techniques for containerless (more accurately, contactless) processing of materials in microgravity.

Previous studies in this series were described in "Microwave Dielectrophoretic Levitation in Microgravity" (NPO-18824), *NASA Tech Briefs*, Vol. 17, No. 10 (October 1993), page 120. The positioning principle of the present and previous studies involves exciting the appropriate resonant mode(s) of the microwave cavity to obtain the potential well of the dielectrophoretic force field, away from the wall of the microwave cavity, where the sample can be held stably. By manipulation of the excited mode(s), one could move the sample around the cavity, and by suitable phasing of degenerate modes, one could apply torque to rotate the sample.

This work was done by Henry W. Jackson, Martin B. Barmatz, and John L. Watkins of Caltech for NASA's Jet Propulsion Laboratory. To obtain copies of the reports, "Applications of Improved Methods for Calculating Electromagnetic Properties of a Microwave Cavity Containing a Lossy Dielectric Sphere" and "Microwave Processing of Materials in Microgravity," write in 80 on the TSP Request Card. NPO-18881



MACHINERY

High-Temperature Rocket Engine

Two rocket engines that operate at a temperature of 2,500 K, as compared with 1,700 K for older engines of the same general type, are designed to provide thrust for station-keeping adjustments of geosynchronous satellites, for raising and lowering orbits, and for changing orbital planes. The engines may also be useful as the final propulsion stages of launch vehicles that will deliver small satellites to low orbits around the Earth. With further development, the engines could be used on planetary exploration missions for orbital maneuvers. The high-temperature technology of these engines may also be adaptable to gas-turbine combustors, ramjets, scramjets, and the hot components of many energy-conversion systems.

This work was done by Steven J. Schneider of Lewis Research Center, Sanders D. Rosenberg of Gencorp Aerojet, and Melvin L. Chazen of TRW, Inc. To obtain a copy of the report, "High-Performance Rockets for Satellites: Aerojet AJ10-221, TRW Advanced DM-LAE," write in 64 on the TSP Request Card. LEW-15774

Integrated Booster-Rocket Propulsion Module

A report summarizes a study of a conceptual integrated booster propulsion module for use in launching a spacecraft. The substitution of the integrated propulsion modules for the multi-



Find out how 3M
can keep your harness
out of hot water.
Call (800) 328-0016 ext.57.

3M Electrical Specialties Division

3M Practicality

For More Information Write In No. 438

Technology 2003 Conference Proceedings

If you missed the show, here's your chance to discover the best new technology being generated by U.S. government labs. Two-volume set features keynote addresses as well as 100 papers spotlighting new inventions with commercial promise in:

- ★ Artificial Intelligence
- ★ Biotechnology/Medicine
- ★ CAD/CAE
- ★ Computer Hardware
- ★ Information Management
- ★ Photonics
- ★ Robotics
- ★ Environmental Technology
- ★ Advanced Manufacturing
- ★ Materials
- ★ Computer Software
- ★ Test & Measurement
- ★ Power & Energy
- ★ Virtual Reality/Simulation

Only \$95⁰⁰ while supplies last

Ship me ___ set(s) of the Technology 2003 official proceedings at \$95⁰⁰ each postage-paid. (NY residents add sales tax to total.)

Total enclosed: \$ _____

Name _____

Company _____

Address _____

City/State/Zip _____

Phone # _____ Fax # _____

Mail with check or money order to:

Technology Utilization Foundation

41 East 42nd St., #921

New York, NY 10017

For credit card orders call (212) 490-3999.

Speakeasy®

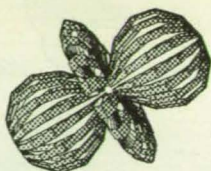

makes math easy

With English-language commands modeled on conventional mathematics, and an intuitive user interface, Speakeasy lets you concentrate on solving your mathematical problems - not on running your software.

"Speakeasy will continue to be our principal software system, because by using Speakeasy, our researchers can translate their thoughts into results faster than with any other software."
Robert Lodder Ph.D.
Chandler Medical Center
University of Kentucky

Comprehensive

If you've been thinking about using a matrix-based language, but don't want to buy a half-dozen modules to perform basic operations - then Speakeasy, with its vocabulary of over 1000 words, is the tool you need for:

array and matrix algebra, differential equations, curve fitting, fast Fourier transforms, exploratory data analysis, 2D and 3D plots, contour plots, statistics, real and complex

computations, linear and quadratic programming

Proven

Speakeasy has been providing problem-solving capabilities to research scientists, physicists, engineers, statisticians, economists and financial analysts for more than twenty years.

"The granddaddy of math software has never stopped evolving..."
IBM Visions Magazine

Now on UNIX and DOS

Call 312.427.2400 today to learn how Speakeasy can help solve your mathematical problems at a price tag that you can afford.

Speakeasy Computing Corporation

224 S. Michigan Avenue
Chicago, Illinois 60604
Telefax: 312.427.4777

For More Information Write In No. 446

**New
Version!**

Plotting Rule # 1:

"If Your Data Is Defined on Non-Rectangular Grids, You'd Better Get Tecplot"

The Tecplot Way
(Original Grid)



Exact
Boundaries
Retained

Original
Data Point
Values and
Positions
Preserved

Their Way
(Interpolated Grid)

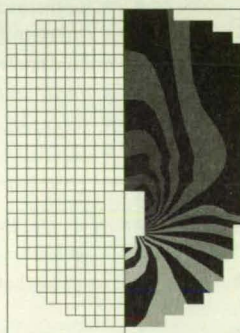

Crude
Boundaries

Lost
Resolution
Near
Center Hole

Data
Smoothed
by
Interpolation

Tecplot Version 6 is the only leading interactive data-visualization package that allows you to easily plot multi-block 2D and 3D data defined on curvilinear and finite-element grids. Other plotting programs can't handle multiple blocks and they force you to interpolate your data into a rectangular grid. If you'd like a plotting program that preserves the integrity of your data, you'd better give us a call at **800-676-7568**.

Tecplot®

Amtec Engineering, Inc.
P.O. Box 3633, Bellevue WA 98009
206-827-3304 • Fax 206-827-3989

For More Information Write In No. 440

ple engines of present booster rockets is intended to simplify ground operations and reduce costs. The conception of the integrated booster propulsion module was motivated by focusing on operational efficiency. According to the concept, many duplicate components and subsystems, with their many interfaces, would be integrated to make the module function as a single engine with a minimum number of components.

This work was done by Russell E. Rhodes and William J. Dickinson of Kennedy Space Center and George S. Wong and Glen Waldrop of Rockwell International Corp. To obtain a copy of the report, "Fully Integrated Propulsion Module," write in 57 on the TSP Request Card. KSC-11601

Studies of Vibrations in Gearboxes

Three NASA technical memorandums summarize studies of vibrations in gearboxes. These studies are directed toward understanding and reducing the gearbox noise caused by coupling of vibrations from meshing gears, through gear shafts and their bearings, to the surfaces of gearbox housings. Practical systems in which the understanding and reduction of gearbox noise would be beneficial include helicopter, car, and truck transmissions; stationary geared systems; and gear-driven actuator systems.

This work was done by Fred K. Choy, Yeefeng F. Ruan, and Yu K. Tu of the University of Akron and James J. Zakrajsek, Fred B. Oswald, John J. Coy, and Dennis P. Townsend of Lewis Research Center. For further information, write in 65 on the TSP Request Card. LEW-15743



Life Sciences

More About Thin-Membrane Biosensor

A report presents additional information about the device described in "Thin-Membrane Sensor With Biochemical Switch" (MFS-26121), *NASA Tech Briefs*, Vol. 16, No. 1 (January 1992), page 79. To recapitulate: This device is a modular sensor that puts out an electrical signal indicative of a chemical or biological agent. The signal is produced as a membrane-crossing ion current triggered by the chemical reaction between the agent and a recognition

protein conjugated to a channel blocker. As such, this device is a prototype of a biosensor that could be useful in numerous laboratory, industrial, or field applications; for example, to detect bacterial toxins in food, to screen for disease-producing microorganisms, or to warn of toxins or pollutants in the air.

This work was done by George D. Case and Jennings F. Worley, III, of Resource Technologies Group, Inc., for **Marshall Space Flight Center**. To obtain a copy of the report, "Thin Membrane Sensor With a Biochemical Switch," **write in 32** on the TSP Request Card.

In accordance with Public Law 96-517, the contractor has elected to retain title to this invention. Inquiries concerning rights for its commercial use should be addressed to

Resource Technology Group

400 Mississippi Street

Morgantown, West Virginia 26505

Refer to MFS-26211, volume and number of this NASA Tech Briefs issue, and the page number.

Bioregenerative Life-Support System for Long Missions

A collection of four reports proposes an integrated bioregenerative life-support system that would sustain tens of people who are isolated from the Earth's oxygen and sunlight. The system would be self-sufficient for a year or more; it would continue beyond that period with replenishment of its supplies. The system could be used in long-term spaceflights, space stations, such planet bases as those on the Earth's Moon or Mars, and submarine vehicles and installations.

This work was done by Hatice S. Cullingford of **Johnson Space Center**. To obtain copies of the reports, "The Next Generation Life Support System for Air, Water, and Waste/Resource Processing and for Food Production," "Conceptual Design of a Piloted Mars Sprint Life Support System," "Bio-Isolation Analysis of Plants and Humans in a Piloted Mars Sprint," and "Method and Apparatus for Bio-Regenerative Life Support System," **write in 26** on the TSP Request Card.

This invention is owned by NASA, and a patent application has been filed. Inquiries concerning nonexclusive or exclusive license for its commercial development should be addressed to the Patent Counsel, Johnson Space Center, [see page 20]. Refer to MSC-21629.



Mathematics and Information Services

Applications of Modern Systems Analysis

Four papers discuss applications of interdisciplinary methodologies that incorporate elaborate mathematical models and computer programs as paradigms of modern systems analysis. The unifying concept that underlies all four presentations is the need for ever more sophisticated methods of systems analysis to manage increasingly complex engineering and socioeconomic systems.

This work was done by Robert C. Wagner, John V. Biernacki, and Robert F. Bodi of Analytical Engineering Corp. and John E. Juhasz of Badwin Wallace University for **Lewis Research Center**. To obtain copies of the papers, **write in 3** on the TSP Request Card. LEW-15752

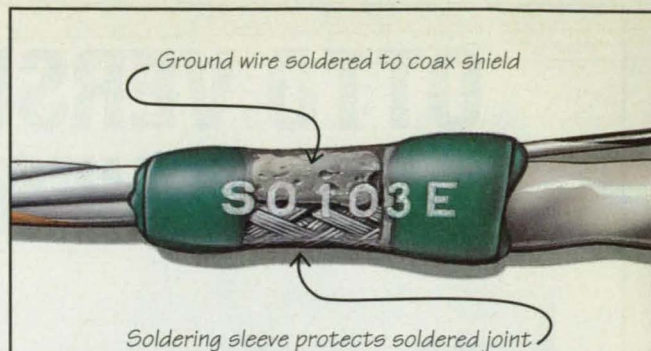

Find out how 3M helps aircraft OEMs stay on course. Call (800) 328-0016 ext. 59.

3M Electrical Specialties Division

3M Practicality

For More Information Write In No. 442

Cool it! With Exergy.

Miniature Shell & Tube Heat Exchangers

- Stainless steel construction
- Pressures up to 1200 psig
- Loads from 100 to 100,000 BTU/hr
- Liquid flows up to 20 gpm
- Custom designs or from stock

Exergy Incorporated
P.O. Box 209, Hanson, MA 02341
Tel. (617) 294-8838
Fax (617) 294-8144

OTTO VERSUS THE OTHERS



OURS

In a side by side comparison of scan converters, nothing compares to OTTO. That's because OTTO is the most advanced scan converter in the world. If you're looking to convert your high-resolution display to broadcast-quality video, have the highest level of automation and control, and want the industry's longest warranty, choose OTTO.

There's simply no comparison.

Folsom Research, Inc. • 526 East Bidwell Street, Folsom, CA 95630-3119
tel (916) 983-1500 • fax (916) 983-7236

THEIRS



Folsom
RESEARCH

For More Information Write In No. 465



Electronic Systems

Performance of a Doppler-Corrected MDPSK Detector

A report presents a theoretical analysis of the effect of the rate of change of Doppler shift ("Doppler rate," for short) of a received multiple-differential-phase-shift-keyed (MDPSK) radio signal on the performance of a Doppler-corrected differential detector. In the particular detector, the phase of the received signal is corrected for the Doppler shift by use of a Doppler estimator that is designed to operate in the presence of a negligibly small Doppler rate. Thus, there arises a question of how the performance of the detector is degraded by a Doppler rate that is not negligibly small.

This work was done by Tien M. Nguyen, Thomas C. Jedrey, Sami Hinedi, and Martin J. Agan of Caltech for NASA's Jet Propulsion Laboratory. To obtain a copy of the report, "Effects of Doppler Rate on the Performance of a Doppler-Corrected Differential Decoder," write in 14 on the TSP Request Card. NPO-19191

'94 TechNet

Featuring the latest in communications, electronics, intelligence, command and control, information systems technologies and imaging

- ❖ More than 500 exhibitors
- ❖ Hundreds of new products to be unveiled
- ❖ The right audience—over 28,000 communications and information technology professionals
- ❖ Special Small Business Pavilion

Hear from senior military leaders addressing the following topics:

- ❖ Digitizing the Battlefield
- ❖ Modeling and Simulation
- ❖ Defense Information Systems Network (DISN)
- ❖ Global Command & Control System (GCCS)

Call today for more information: (800) 336-4583, ext. 6200, or (703) 631-6200 or Fax (703) 818-9177.

AFCEA's 48th International Convention and Exposition

The Information
Technology Puzzle—
Solve It at TechNet

June 7-9, 1994

Washington, D.C.
Convention Center

FREE Panels covering:

- ❖ National Performance Review
- ❖ Information Technology in Support of Intelligence
- ❖ High-Tech and Free Trade Opportunities
- ❖ National Information Infrastructure (NII) Status, State and Local Implications, and Security Issues

AFCEA supports the letter and spirit of the Americans with Disabilities Act of 1990. Attendees with special needs should call (703) 631-6125.

For More Information Write In No. 444

NASA Tech Briefs, March 1994

New on the Market

A rapid prototyping and tooling technology introduced by 3D Systems, Valencia, CA, reduces the lead time on metal castings by 80 percent, according to the manufacturer. QuickCast™ permits the user to bypass the expensive and time-consuming machining of hard tooling traditionally required for wax patterns. Instead, plastic patterns are built directly on 3D Systems' stereolithography apparatus.

For More Information Write In No. 716



Pacific Cyber/Metrix Inc., Dublin, CA, has unveiled a digital signal processing board for real-time image processing. Mating three Texas Instruments TMS320C40 processors with a Motorola 68040 general-purpose processor, the DSP-48 extracts information from images acquired using visible-light cameras, tomographic equipment, radar, sonar, and infrared systems. The board aids the creation of autonomous vehicle controllers, object trackers, and robots that can act on image stimuli.

For More Information Write In No. 707

The Micro Slides Division of Anorad Corp., Hauppauge, NY, has introduced M & V linear bearing guide-ways for accurate guidance where roller bearings are inappropriate. The components feature a precision, Teflon bonded and ground guide rail to provide a highly reliable, wear-resistant surface that absorbs vibration and runs safely without additional lubrication. The guides' components are interchangeable with all standard crossed roller bearing mountings.

For More Information Write In No. 710

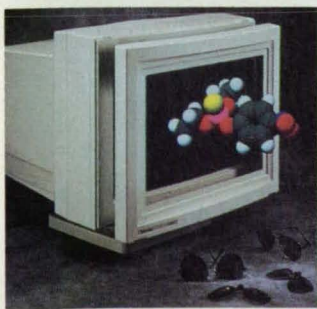

The Dimension® II process controllers from Research Inc., Minneapolis, MN, combine PID control with PLC capabilities in a single instrument. The units integrate single- or multi-loop control, setpoint programming, alarms, logic functions, and auxiliary sensor monitoring. Extensive limiting, scaling, and thermocouple linearization capabilities allow the user to set up input requirements and monitor processes according to specific applications.

For More Information Write In No. 721

An innovative pump/compressor introduced by EP Industries Inc., El Segundo, CA, produces up to 16 times the output of equally-sized units yet weighs one-fifth as much and costs two-thirds less to produce. The patented, valveless CEM (cylindrical energy module) has only five moving parts, which reduces friction, saves energy, and improves reliability. It can be scaled to virtually any size.

For More Information Write In No. 715

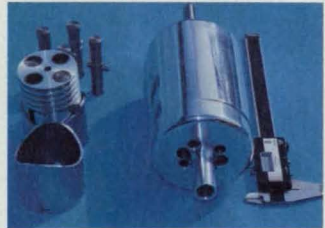

The Camad Company, Manhattan Beach, CA, has released QuickRUN™ software for creating computerized motion control programs without writing software. The PC-compatible package operates on Camad's 2300 series pulse and direction output and 2500 series ±10V analog output closed-loop motion controllers. QuickRUN offers built-in user interface screens and permits the user to select control parameters for each application.

For More Information Write In No. 720

Tektronix Inc., Beaverton, OR, has unveiled two 19-inch color stereoscopic displays that are used with passive stereo glasses and feature integrated liquid crystal modulators. Incorporating patented pi-cell technology, the SGS19U and SGS19C offer higher contrast and more uniform brightness than previously available. Both displays can be used with a scan converter and cameras to create real-time, stereoscopic video.

For More Information Write In No. 718

Microfocus X-Ray Technology Just Took A Giant Leap Forward



Revolutionary!

The KM160 Microfocus X-ray Source and Generator are as compact as you'll get for 160KV with a spot size less than 10 microns. Four different spot size/power combinations are selectable for a variety of inspection needs. Highly magnified real time imaging is a breeze with the short target to window design.

The KM160 uses gas insulated high voltage technology to deliver high performance, reliability, and serviceability. The air cooled metal ceramic x-ray tube is easy to install and manipulate. An RS232 interface facilitates automation of all major control functions. Finally, the KM160 features a performance-to-price ratio hard to beat.

Choose the KM160 for your microfocus x-ray source needs.

KEVEX X-RAY INC.,
320 El Pueblo Road
Scotts Valley, CA 95066-0860
Tel. (408) 438-5940, Fax. (408) 438-5892

FISONS
Instruments
KEVEX X-RAY

For More Information Write In No. 498

MASTERFLEX®

EASY-LOAD® pump systems



Simple design offers simple fluid transfer solutions.

Peristaltic pump confines fluid within the tubing to provide:

- ◆ **Aseptic, noncontaminating** pump chamber,
- ◆ Excellent **chemical resistance**,
- ◆ Gentle transfer of **shear-sensitive** or **viscous** fluids,
- ◆ **Easy maintenance** for fast tubing changes and pump cleaning,
- ◆ **Self-priming** and **run-dry** capabilities,
- ◆ **Variable flow rates** from 0.6 $\mu\text{l}/\text{min}$ to 45 liters/min, and much, much more.

FREE!

Over 10,000 pump combinations to choose from; each covered by a two-year warranty. Get the complete story in the 144-page Masterflex Reference Book. Send for your FREE copy today.

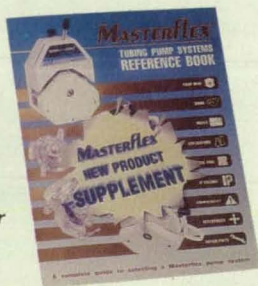

Cole-Parmer Instrument Company

7425 N. Oak Park Ave. Niles, IL 60714

Phone: 1-708-647-7600 ◆ Fax: 1-708-647-9660
1-800-323-4340

New on the Market

The **DSP Lab One™** digital signal processing board from Standing Applications Laboratory, Kirkland, WA, runs more than 113 MIPS and combines real-time signal capture, analysis, and generation with high-resolution SVGA display in one 16-bit ISA slot. Each board features four TMS 320C51 digital signal processors and 16-bit stereo A/D and D/A converters running at up to 166k samples/sec.

For More Information Write In No. 712

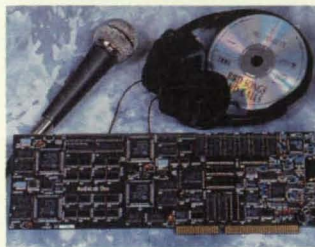

The **vmax/GP** scalable data acquisition and control board from Alta Technology, Sandy, UT, features a VME interface, six independent A/D and D/A channels, a 32-bit digital I/O port, 4 or 16 MB of shared memory, and a transputer controller for creation of multiprocessing environments. The A/D and D/A converters have 12-bit resolution and eliminate skew between sequential operations.

For More Information Write In No. 714

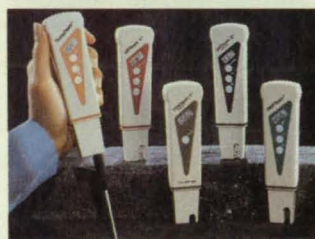

The industry's first microprocessor-based **pH test instruments** are available from Cole-Parmer Instrument Co., Niles, IL. The pHTestr1 features push-button calibration at 4.0, 7.0, or 10.0 pH, extended range pH measurement from -1.0 to +15.0 with ± 0.2 accuracy, auto shutoff, and self-diagnostic error messages. The pHTestr2 includes automatic temperature compensation, multi-point calibration capability, and ± 0.1 pH accuracy.

For More Information Write In No. 701

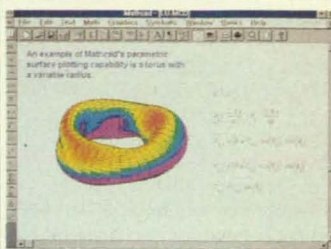

Mathsoft Inc., Cambridge, MA, has released two new versions of its Mathcad **technical calculation software**. Mathcad 5.0, designed for mainstream users, offers enhancements such as equation and text editing, document preparation, improved graphics, automatic unit assignment, and an on-line tutorial. For more advanced users, the expandable Mathcad PLUS 5.0 incorporates all of 5.0's features as well as advanced numeric and symbolic calculations, differential equations, and matrix functions.

For More Information Write In No. 711



DeFelsko Corp., Ogdensburg, NY, has designed the first nondestructive, handheld **coating thickness gauge** that can measure concrete, wood, glass, and plastic coatings, as well as thin walls, delamination, and corrosion. The PosiTector 100 measures thicknesses to 0.0005" and features simple two-button operation and automatic calibration.

For More Information Write In No. 713

Micro Computer Specialists Inc., Vista, CA, has announced the ICB-486DX **single-board computer**, integrating the functionality of a standard motherboard and peripherals with a PC/104 expansion port and watchdog timer. Operating at up to 66 MHz, the AT-type plug-in board features a ZIF CPU socket and unique clock circuit that supports high-performance 486DX, 486DX2, and Intel Overdrive microprocessors.

For More Information Write In No. 717

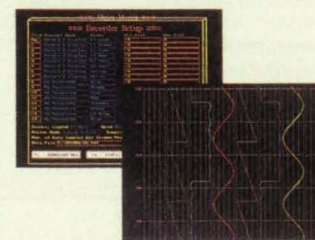

OMEGATREND™ data acquisition software from Omega Engineering Inc., Stamford, CT, offers a low-cost means to emulate high-speed strip-chart recorders. Data can be viewed from six channels and recorded from 16 simultaneously. Priced at \$349, the software supports display rates up to 7000 samples per second.

For More Information Write In No. 705

New on the Market

UNICALC scientific calculation software for Windows, from Calchemy Software Inc., Ft. Collins, CO, allows users to calculate data having inconsistent units. Hundreds of common and esoteric units, including metric and SI, are supported and may be used in any combination. Priced at \$79, the program provides feedback on dimensional errors while offering automatic dimensional analysis to reduce error. **For More Information Write In No. 703**

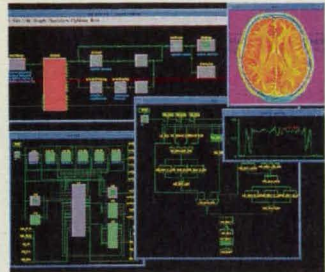

Spyglass Plot, a scientific plotting and graphing tool from Spyglass Inc., Savoy, IL, permits analysis of large datasets using interactive visualization techniques. Running on a UNIX or Macintosh workstation, Spyglass Plot generates line, double-Y, color scatter, and parametric plots. It can read many data formats including HDF, HDF Vset, spreadsheet, ASCII, and binary datasets. **For More Information Write In No. 709**

WitFlow graphical programming software from Datacube Inc., Danvers, MA, enables complex applications on the company's image processing systems without having to write extensive code. WitFlow represents imaging tasks visually as graphical models of processing elements and data paths. These models depict overall application data flow and control, generating C code that can be compiled and executed. **For More Information Write In No. 719**

Hitachi Denshi America Ltd., Woodbury, NY, has announced a **studio/field camera** that permits RGB digital video processing. The SK-2600 has a 62 dB signal-to-noise ratio and 900 lines of resolution. Auto set-up eliminates the need for diascope and viewfinder picture-in-picture lets auxiliary video signals be positioned in four quadrants or reversed with the camera video. **For More Information Write In No. 704**

The Power Wizard™, a digital, pocket-size **power probe** introduced by Synrad Inc., Bothell, WA, enables CO₂ and YAG measurements up to 200 W. The device has a built-in analog computer capable of sequential readings and requires an exposure time under two seconds. Priced at \$400, the probe is powered by a long-life lithium battery, and features digital display, auto ranging, and auto shutoff. **For More Information Write In No. 702**



The PLSyn **programmable logic synthesis** system from MicroSim Corp., Irvine, CA, is the first to enable design and simulation of a system with programmable logic, discrete digital, and analog parts on the same schematic. PLSyn simulates the entire design before and after the physical implementation has been selected, automatically compiling and simulating programmable logic. **For More Information Write In No. 708**



Sparcom Corp., Corvallis, OR, has released **mathematics software** for its HP 48GX calculator that features an advanced interface to aid beginners. Math•Pro™ includes over 1000 mathematics routines, analyses, equations, and references. The software comes programmed onto a plug-in expansion card and requires 5 KB of free calculator memory. **For More Information Write In No. 706**

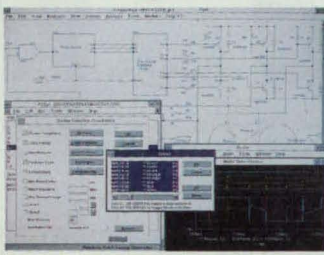

Questions about Pressure Control?



Talk to the problem solvers for a wide range of pressure regulators and valves—for gas and liquid control from subatmospheric to 15,000 PSIG!

Over 50 standard models + options

Choices include materials, pressure ranges, port types and flow capacities ($C_v = .01$ to 15). Pressure reducing, back pressure, dome loaded, two-stage and electronically controlled styles do the job in high purity, hydraulic, high pressure, vacuum and vaporizing applications.

An ISO 9001 System Certified Company!

TESCOM
CORPORATION

12616 Industrial Blvd.
Elk River, MN 55330
612/441-6330

For More Information Write In No. 495

12 BIT, 20 MSPS A/D < \$5K

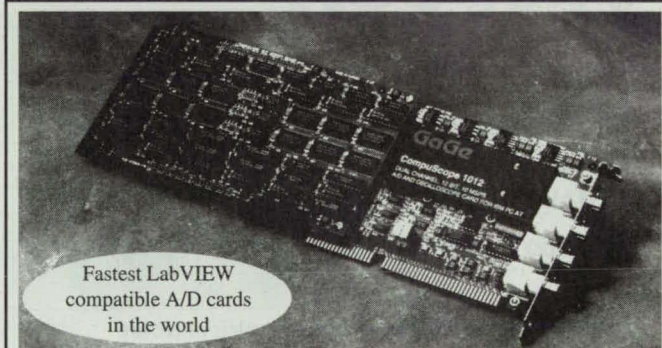

Fastest LabVIEW compatible A/D cards in the world

Gage Applied Sciences Inc., the recognized world leader in ultra-fast PC based data acquisition and instrumentation, presents the CompuScope family :

20 MSPS A/D at 12 bit resolution, 65 dB dynamic range

Up to 100 MHz A/D rate at 8 bit resolution

On-board memory up to 8 megasamples

FREE GageScope software. Winner of BEST IN TEST 1993

Multiple cards can provide up to 32 simultaneous channels

C, Pascal, BASIC drivers, Windows DLL etc.

CSLITE	8 bit / 40 MSPS / 16K	\$595
CS220	8 bit / 40 MSPS / 256K	\$1,995
CS250	8 bit / 100 MSPS / 32K	\$3,500
CS1012	12 bit / 20 MSPS / 512K	\$4,995

CALL 1-800-567-GAGE

Inquire about our D/A cards

Gage Applied Sciences Inc.

5465 Vanden Abeele, Montreal, Quebec, Canada H4S 1S1

From outside North America, call + 1-514-337-6893

Fax : (514) 337-8411, BBS : (514) 337-4317

GAGE

For More Information Write In No. 496

129



SONEX!

**NEW PRODUCTS.
NEW APPLICATIONS.
NEW BROCHURE.**

Send for your **FREE** copy today!

illbruck

Minneapolis, Minnesota

**1-800-662-0032
(612) 520-3620**

For More Information Write In No. 494

ROTOCON

HIGH PERFORMANCE ROTARY CONTACTS

**THERMOCOUPLES,
RTD's, LVDT's
STRAIN GAUGES,
1 to 100 contacts!**

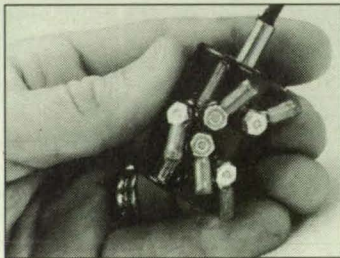

Unlike conventional slipring designs, the unique ROTOCON Sealed Mercury Rotary Contacts are low noise, low resistance, zero maintenance links between stationary and rotating components.

- Zero Electrical Noise
- Low And Stable Resistance
- Compact Size
- Zero Maintenance
- Environmentally Sealed
- Rugged And Reliable
- Unaffected By Vibration
- Mount In Any Orientation

A variety of standard and custom ROTOCON models are available to fit your mounting configuration, rotation speed, and current requirements (up to 2000 Amps!).

"Try Before You Buy"

Call:

800-837-6010

OR 608-836-7571 (FAX 608-831-0300 TELEX 754381)



meridian laboratory

P.O. Box 620156, 2415 Evergreen Road, Middleton, WI 53562-0156

For More Information Write In No. 493

New Literature

A brochure from Litton Poly-Scientific, Blacksburg, VA, showcases its **motion control components**, including slip rings; brush and brushless DC, permanent-magnet, stepper, and DC torque motors; and multispeed, brushless, and brushless pancake synchros and resolvers. The company works with customers to design complete motion control systems offering savings in weight, accuracy, cost, and energy.

For More Information Write In No. 725



Innovative solutions to a wide range of **thermal management** problems are presented in a 16-page brochure from Lytron Inc., Woburn, MA. The company designs and manufactures standard and specialty fin-and-tube heat exchangers; high-performance, compact, lightweight plate-fin heat exchangers; cold plates and electronic card chassis; liquid-cooled plate-fin and solid aluminum thermal planes, and complete cooling systems.

For More Information Write In No. 726

A 24-page pocket handbook on **flow measurement and control** is available from McMillan Co., Georgetown, TX. The publication includes engineering tables on flow equivalents, viscosity rating systems, molecular weights and specific gravities of gases, and chemical resistance of gases, vapors, and liquids.

For More Information Write In No. 724

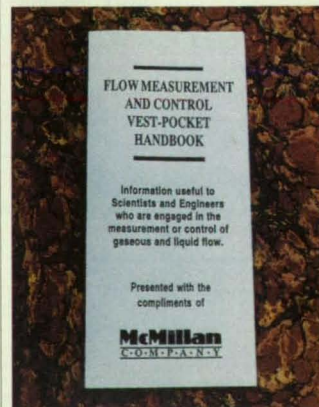

Entran Devices Inc., Fairfield, NJ, has released a catalog of miniature **pressure, force, and acceleration sensors**. Associated power supplies, meters, and amplifiers are included. For More Information Write In No. 723

Apex Microtechnology Corp., Tucson, AZ, has published an expanded edition of its databook featuring **DC/DC converters and power and high-voltage amplifiers**. New application notes address bridge mode and single supply operation of power operational amplifiers, stability, SOA and load lines, motor drives, driving capacitive loads, parallel connection, proper analog wiring, and audio applications.

For More Information Write In No. 728

Tools for Automation, a full-color brochure from Advanced Micro Systems Inc., Nashua, NH, describes the company's **motion control and vision system products**. Featured items include intelligent integrated circuits and board-level controls; the MOTORvator series of motion controllers; drivers, motors, and power supplies; and cross-hair and icon video generators.

For More Information Write In No. 727



A capabilities brochure from Tekscan Inc., Boston, MA, describes its standard and custom **pressure sensors**. Incorporating patented pressure sensor technology, the sensors can be made as thin as .004" with scanning rates up to 200 kHz, ranges from 0 to 8000 PSI, and accuracy to $\pm 5\%$ of range. PC-based systems include sensors, connectors, interface boards, and software.

For More Information Write In No. 722

SONY

CHOOSING YOUR DATA RECORDER SHOULDN'T BE AN EXPERIMENT.

When it comes to data recording, Sony takes the variables out of the equation.

Our field-tested line of helical scan data recorders delivers proven reliability and performance. The DIR-1000 Series offers high capacity (100 GBytes/cassette), high-speed (up to 256 Mb/s) in the industry standard ID-1 format. Sony's robotics-driven Digital Mass Storage Systems let you gain convenient access of up to 30 terabytes of stored data. For portable digital recording (up to 3.072 Mb/s), or analog recording (up to 8 channels), our PC series is your logical solution. So no matter what your recording needs, depend on Sony. And leave nothing to chance.

For more information, call 1-800-328-SONY, ext. DATA.

INNOVATION AT WORK.



Sony Business and Professional Group, 3 Paragon Drive, Montvale, NJ 07645-1735. ©1993 Sony Electronics, Inc. Reproduction in whole or in part without written permission is prohibited. All rights reserved. Sony is a trademark of Sony.

EXPRESS

Best Value in the World
for
POLYIMIDE & FR4
1 to 5 DAY TURN
1 to 12 Layers

PRINTED CIRCUIT PROTOTYPES

2 PIECE PRICES FOR FR4 .062 Th.

LAYERS	1	2	3&4	5&6	7&8
15	\$233	\$292	\$639	\$787	\$935
30	264	330	724	891	1059
60	311	389	853	1049	1137
90	358	448	980	1207	1434
120	385	486	1044	1311	1559

5 PIECES x 1.34 5 DAY PRICES ABOVE
10 PIECES x 1.67 UL LISTED

EXTRAS CAPABILITIES DISCOUNTS

- Photo Plotting
- Testing
- Gold Contacts - \$50
- 25% - Below 8 Mil Hole
- Below 15 Mil Hole
- SMOBC & LPI - \$50
- Buried & Blind Vias
- Polyimide Multilayer
- Full Body Gold
- Carbon Paste
- Tin nickel burn-in boards
- SMT-SMOBC
- Up to 22 layers
- Impedance control boards
- 5%
- COD
- 10%

FOR MORE INFORMATION CALL OR FAX

Ken Bahl 1108 W. Evelyn Ave., Sunnyvale, CA 94086
Phone (408)735-7137 FAX (408)735-1408 Modem (408)735-9842

Alignment Pins

- L,T, Jig
- Detent
- Shoulder
- Expanding
- Clamping
- Lifting
- Locking
- Ball-Lock

Our free component catalog includes 13 pages of pin listings. Send for one today.

Carr Lane MANUFACTURING CO.
4200 Carr Lane Ct., P.O. Box 191979
St. Louis, Missouri 63119-2196
Phone: 314-647-6200, FAX: 314-647-6736

SILICON VIDEO MUX™

Flexible Imaging Board for the PC

- 8,000 - 4 Pixels per Line
- 1,020 - 2 Lines/Image
- 40 MHz - 2 MHz Sampling & Display Rate
- Configurable 4 MB or 1 MB Image Memory
- 6 Input Video Multiplexer
- Programmable Non-Standard, RS-170, & CCIR Video Formats
- Hi-Res Camera Interface
- Extensive Software

EPIX®

381 Lexington Drive
Buffalo Grove, IL 60089
Tel - 708 465 1818
Fax - 708 465 1919
© 1994 - EPIX, Inc., USA

For More Information Write In No. 492

For More Information Write In No. 490

For More Information Write In No. 487

FREE!
130 Page Catalog

"Optics for Industry"

Free 130 page product catalog from Rolyn, world's largest supplier of "Off-the-Shelf" optics. 24-hour delivery of simple or compound lenses, filters, prisms, mirrors, beamsplitters, reticles, objectives, eyepieces plus thousands of other stock items. Rolyn also supplies custom products and coatings in prototype or production quantities. **ROLYN OPTICS Co.**, 706 Arrowgrand Circle, Covina, CA 91722-2199, (818)915- 5707, FAX (818)915-1379

FOR MORE INFORMATION WRITE IN NO. 486

SONY TRINITRON® HIGH RESOLUTION COLOR MONITORS

LATEST MODELS
FLAT SCREEN
MULTISCAN® RGB
FOR SUN, DEC,
HP, PC, MAC,
AND OTHER
WORKSTATIONS
FULL WARRANTY
TILT/SWIVEL OR OEM
CUSTOM RACK MOUNT
AND TOUCHSCREENS
AVAILABLE

AUTOMATICALLY MATCH INPUT TO FULL RANGE OF RESOLUTIONS FROM 640 X 480 TO 1600 X 1280.
PLUS, INTERNAL SONY DISPLAY MEMORY SYSTEM PROVIDES 9 PRESET AND 15 CUSTOMIZED ADJUSTMENT MODES.

800 662 5606

ADVANCED VIDEO TECHNOLOGIES
237 CEDAR HILL ST. • MARLBORO, MA 01752

FOR MORE INFORMATION WRITE IN NO. 491

CANDELA COLOR MANAGEMENT SYSTEM (CCMS)

The CCMS is a color toolbox for software developers. You can create 3-D, non-linear, non-separable color transformations that are necessary for high-end color correction. This comprehensive library of C callable routines, color transformations, gamut mapping functions, image test targets and clearly written API is all you need to solve complex color calibration and color matching problems. You can produce Candela ColorCircuits® for the highest precision-speed transformations or create Color Rendering Dictionaries for compatibility with ADOBE Postscript Level 2. The CCMS is Available for most ANSI C supported environments. A 138 page API is available FREE to qualified developers.

CANDELA
(612) 894-8890

Candela Ltd. • 1676 East Cliff Road
Burnsville, MN 55337-1300

FOR MORE INFORMATION WRITE IN NO. 592

WE'RE THE FIRST... WE'RE THE BEST AND WE HAVE THE

S TO PROVE IT!

THESE IS A DIFFERENCE!

When professionals compare the EVERGREEN TRACKBALLS for • Mechanical Design • Construction • Performance • Reliability • Compatibility, they find the products superior in every way to all the rest.

All units are industrial quality and feature: Diamond Hard Shafts • Ball Bearings • Full Optical Encoders • Velocity Sensing Dynamic Resolution.

Whether you are in CAD/CAM, CAE, PUBLISHING, DRAFTING or BUSINESS GRAPHICS, inevitably you will select a trackball to replace the mouse and you will want VALUE for your money. The EVERGREEN TRACKBALL products have it.

• PERFORMANCE • ACCURACY • RELIABILITY • SURVIVABILITY

All EVERGREEN TRACKBALLS support: Sun, Dec, HP/Apple, Silicon Graphics, PS/2, RS-6000 and PC-AT models WITHOUT REQUIRING A SEPARATE DRIVER.

EVERGREEN SYSTEMS INTERNATIONAL
31208 Via Cottare
Westlake Village CA 91362
Tel. 818 991 7835
Fax 818 991 4036

DIAMOND XL DIAMOND XX OMEGA

FOR MORE INFORMATION WRITE IN NO. 480

Official NASA CAPS

Black cap with gold leaves and official NASA insignia. Only \$9.95 each!

Please send (insert quantity) _____
NASA caps.
Add \$5.00 for handling and shipping charges. NY residents add sales tax.
TOTAL Enclosed: \$ _____

Name _____
Address _____
City _____
State _____ Zip _____

Mail payment to: **Nasa Tech Briefs, Dept. F**
41 East 42nd Street, Suite 921
New York, NY 10017

For credit card order call (212) 490-3999

CALENDAR

A calendar featuring breathtaking four-color photographs of the space shuttle in action, photos taken by the crew of a space shuttle mission, views of the earth and more! Dates and space launches from the 1960s to present included. Printed on deluxe coated stock with laminated colorful covers. Only \$10.95.

Send NASA Calendar(s) at \$10.95 each (quantity) _____
Add \$5.00 for shipping and handling charges _____
(NY residents add sales tax)
Orders from \$51.00 to \$100.00 add shipping and handling charge \$8.50 TOTAL ENCLOSED _____

Name _____
Company _____
Address _____
City/State/Zip _____

Mail to: **NASA Tech Briefs, Dept. F, 41 East 42nd St., # 921**
New York, New York 10017

For credit card orders call (212) 490-3999

ARE YOU STILL TRYING TO MEASURE VERY THIN GAPS THE HARD WAY?

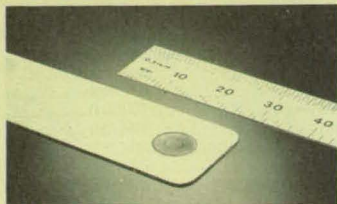

Capacitec HPS Series of thin (back to back) sensors can measure gaps as small as 0.010"(.254mm) inboard 84" (2133.6mm) with accuracies of 0.0003" (7.6µm), without scratching delicate surfaces.

Capacitec

P.O. Box 819, 87 Fitchburg Rd., Ayer, MA 01432 U.S.A.
Tel. (508) 772-6033 • Fax (508) 772-6036

For More Information Write In No. 472

WORKMANSHIP STANDARDS MANUAL



Workmanship Standards were developed by Martin Marietta to use as guidelines in manufacturing electro-mechanical and electronic systems that perform to exacting government/defense requirements. Photographs and clear instructions provide the individual with a clear definition of what is required on the production line and in training programs.

Martin Marietta Information Systems
P.O. Box 590385, MP 1510, Orlando, FL 32859
(407) 356-4769 FAX (407) 356-6288

For More Information Write In No. 462

NEW ENCLOSURES CATALOG FROM BUD



Bud Industries, Inc., the nation's leading electronic enclosure manufacturer, offers a new, 60-page catalog featuring a complete line of standard, off-the-shelf enclosures and accessories. With full-color illustrations, it provides design features, technical data and ordering information on over 3,000 product combinations. Bud enclosures range in size from large cabinet racks and work stations to desktop and portable instrument cases, as well as a complete line of NEMA and plastic enclosures.



Bud Industries, Inc.
BUD INDUSTRIES, INC., 4605 East 355th Street,
Willoughby, OH 44094. Phone: 216-946-3200. FAX: 216-951-4015.

For More Information Write In No. 474

Precision Positioning Anywhere!

Farrand linear and rotary Inductosyn® transducers provide absolute and incremental positioning information accurate to ±40 microinches, ±0.5 arc second, or better. Rugged and reliable, our position transducers operate anywhere, even under extreme conditions—vibration, temperature from 10°K to 160°C, shock, high pressure, vacuum, and dust or oil films.

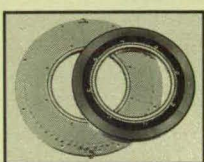

Call 914/761-2600 or fax 914/761-0405.

FARRAND CONTROLS

DIVISION OF RUHLE COMPANIES, INC.
99 WALL STREET—VALHALLA, NY 10595

For More Information Write In No. 476

R&M Prediction and FMECA SOFTWARE

PSI's family of software can meet all of your reliability needs.

- Reliability Prediction
- Automotive Reliability
- FMECA Prediction
- System Reliability
- Industrial Reliability
- Mechanical Reliability
- Maintainability

To receive a direct FAX on documents supported call 1-800-779-0202, code 013318.



POWERTRONIC SYSTEMS, INC.
13700 Chef Menteur Hwy. NO, LA 70129
504-254-0383 FAX 504-254-0393

For More Information Write In No. 473



DON'T SPOIL IT-KROIL IT!

Don't ruin a valuable piece of equipment just because some part is rusted tight. KROIL creeps into millionth inch spaces, dissolves rust and lubricates to quickly...

LOOSEN FROZEN METAL PARTS

A satisfied customer says: "We broke nuts and wasted time and labor. Now with KROIL's help, we haven't ruined one nut."

TEST KROIL AT OUR RISK!

If you're not convinced Kroil is superior, we will refund your money.

Don't Spoil It—Send \$5.00 for 1 aerosol can (Aerokroil) to Kano Laboratories.

Order direct—not available in stores.

KANO LABORATORIES
10589 Thompson Lane, Nashville, TN 37211
615-833-4101



For More Information Write In No. 471

TROMPETER'S NEW 24-PAGE SP1 CATALOG

A new way to order Trompeter products! High quality, premium value RF interconnect components...Coax/Twinax/Triax Patching, Connectors and Cables.



Easy to use!

- Complete part numbers for over 200 of our most popular products.
- 1-99 piece with our new SPL1 Standard Parts Price List.
- Large inventory for quick delivery.
- New customer order forms and 800 toll-free number.
- Low \$25 minimum order, Mastercard/Visa accepted! We connect you with quality!

- Complete part numbers for over 200 of our most popular products.
- 1-99 piece with our new SPL1 Standard Parts Price List.
- Large inventory for quick delivery.
- New customer order forms and 800 toll-free number.
- Low \$25 minimum order, Mastercard/Visa accepted! We connect you with quality!

TROMPETER ELECTRONICS, INC.

1-800-217-2020, Fax: (818) 706-1040.

Send Information Write In No. 600

Please Call Write In No. 601

Full-Wave Solutions

Maxwell® SI Eminence offers a unique, integrated solution to the whole spectrum of high speed design issues from signal delays to EMI/EMC. Characterize full-wave and radiative effects to analyze complex electronic designs.



ANSOFT CORPORATION

Four Station Square, Suite 660
Pittsburgh, PA 15219
Phone: 412-261-3200 Fax: 412-471-9427
Internet: info@ansoft.com

For More Information Write In No. 464

Low Cost Miniature Controllers

Save time. Save money.

Our wide range of C-programmable miniature controllers are ideal for control applications, data acquisition, and test and measurement. Compact and low in price (the Little PLC™ above is 2"x3" and \$195), these controllers are programmed with our easy-to-use Dynamic C™ development system. Our controllers feature digital I/O, ADCs and DACs, relays and solenoid drivers, RS232 and RS485 serial ports, battery-backed memory and time/date clock, LCDs, keypads, enclosures and more!

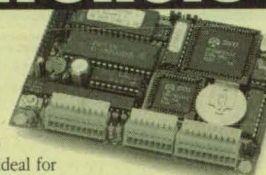

1724 Picasso Ave.
Davis, CA 95616
24-Hour AutoFax 916.753.0618. Call 916.757.3737
from your FAX. 916.753.5141 FAX



For More Information Write In No. 477

THE TECHNOLOGY CONNECTION

To Advertise Call (800) 944-NASA

Engineering & Scientific Software

Engineering, Scientific & Technical Software

Free Catalog!
Call 1.800.622.3345

Software for Science is your source for the best value in engineering, scientific and technical software. More than 1,000 products.

1.312.472.0444 2231 N. Clybourn Ave.
1.312.472.0472 Chicago, IL 60614-3011

Professional Services

INVENTORS

If you have an invention for sale or license, write for our FREE booklet explaining how we can help you. Kessler Sales Corp., Dept. C-67-4, Fremont, Ohio 43420

MARK YOUR CALENDAR NOW

for Technology 2004

November 8-10, 1994, Washington, DC, Convention Center

For information on attending or exhibiting at this premier showcase of new technology, call (800) 944-NASA.

NASA Tech Briefs, ISSN 0145-319X, USPS 750-070, copyright© 1994 in U.S., is published monthly by Associated Business Publications Co., Ltd., 41 E. 42nd St., New York, NY 10017-5391. The copyrighted information does not include the (U.S. rights to) individual tech briefs which are supplied by NASA. Editorial, sales, production and circulation offices at 41 East 42nd Street, New York, NY 10017-5391. Subscription for non-qualified subscribers in the U.S., Panama Canal Zone, and Puerto Rico, \$75.00 for 1 year \$125.00 for 2 years; \$200.00 for 3 years. Single copies \$10.00. Foreign subscriptions one-year U.S. Funds \$150.00. Remit by check, draft, postal, express orders or VISA, MasterCard, or American Express. Other remittances at sender's risk. Address all communications for subscriptions or circulation to NASA Tech Briefs, 41 East 42nd Street, New York, NY 10017-5391. Second Class postage paid at New York, NY and additional mailing offices.

POSTMASTER: please send changes to NASA Tech Briefs, 41 E. 42nd Street, Suite 921, New York, NY 10017-5391.

ADVERTISERS INDEX

3M Electrical Specialties Division.....(RAC 438,442)*.....	123,125	Lockheed Corporation.....(RAC 628).....	4
3M Engineering Document Systems.....(RAC 616).....	31	Loral Data Systems.....(RAC 530).....	45
Actronics, Inc.....(RAC 324).....	57	MACRO Engineering.....(RAC 349).....	59
Advanced Video Technologies.....(RAC 491).....	132	Manufacturers Technologies, Inc.....(RAC 326).....	57
Aegis Engineering, Inc.....(RAC 365).....	60	Manugistics, Inc.....(RAC 517).....	COV III
Aerospace Optics, Inc.....(RAC 519).....	19	Martin Marietta Information Systems.....(RAC 462).....	133
Aerotech, Inc.....(RAC 328).....	57	Master Bond, Inc.....(RAC 455).....	77
AFCEA.....(RAC 444).....	126	MathSoft, Inc.....(RAC 650).....	71
Airpot Corporation.....(RAC 541).....	80	The MathWorks, Inc.....(RAC 611).....	1
Algor, Inc.....(RAC 518).....	17	MCAE, Inc.....(RAC 352).....	59
AMCO Engineering Company.....(RAC 362).....	60	The McNeal-Schwendler Corporation.....(RAC 667).....	2
American Variseal.....(RAC 341).....	58	Meridian Laboratory.....(RAC 454,493).....	77,130
AMETEK.....(RAC 386-392).....	62	Metrum.....(RAC 559,560).....	3
Amtec Engineering, Inc.....(RAC 439).....	123	Micro Motors, Inc.....(RAC 376).....	61
Ansoft Corporation.....(RAC 464).....	133	Microstar Laboratories.....(RAC 332-333).....	57
Apple Computer, Inc.....(RAC 13).....	13	Micro Surface Corporation.....(RAC 350).....	59
Applied Laser Systems.....(RAC 630).....	103	Minco Products Inc.....(RAC 357-359,415).....	59,60,102
Arburg, Inc.....(RAC 368).....	60	Mitchell and Gauthier Associates, Inc.....(RAC 626).....	105
Arconium.....(RAC 451).....	74	MMFG.....(RAC 458).....	86
Astro-Med, Inc.....(RAC 662).....	37	Modgraph, Inc.....(RAC 346).....	59
Austron.....(RAC 459).....	104	Molecu Wire Corporation.....(RAC 314).....	56
Bancomm Division of Datum Inc.....(RAC 453).....	46	National Electrostatics Corporation.....(RAC 435).....	112
The Biltrite Corp.....(RAC 320).....	56	National Instruments Corporation.....(RAC 550).....	Cov II
Bud Industries, Inc.....(RAC 474).....	133	New England Affiliated Technologies.....(RAC 360).....	60
Candela Ltd.....(RAC 592).....	132	Newport Electronics, Inc.....(RAC 308).....	55
Capacitac.....(RAC 472).....	133	Northern Research and Engineering Corp.....(RAC 436).....	113
Carr-Lane Manufacturing Co.....(RAC 490).....	132	Novamet Specialty Products Corp.....(RAC 652).....	73
CETAR.....(RAC 348).....	58	nuLogic Inc.....(RAC 380,381).....	61,62
Colder Products Co.....(RAC 460).....	94	O'Keefe Controls Company.....(RAC 336).....	58
Cole-Palmer Instrument Company.....(RAC 668,497).....	75,128	OMEGA Engineering, Inc.....(RAC 300-307).....	55
Contemporary Cybernetics.....(RAC 578).....	7	Patton & Patton Software Corp.....(RAC 421).....	91
CONAP, Inc.....(RAC 531-535).....	109	Proto Express.....(RAC 492).....	132
CST Images.....(RAC 403).....	30	Powertronic Systems, Inc.....(RAC 473).....	133
CVI Laser.....(RAC 427).....	101	Raytek.....(RAC 410).....	83
Data Physics Corporation.....(RAC 382,383).....	62	Raytheon Company.....(RAC 608).....	79
Data Translation.....(RAC 463).....	21	Research Systems, Inc.....(RAC 431).....	121
David Sarnoff Research Center.....(RAC 538).....	43	RGB Spectrum.....(RAC 678).....	12
DCC Corporation.....(RAC 347).....	59	Ring Feder Corporation.....(RAC 379).....	61
Del-Tron Precision, Inc.....(RAC 310,409).....	56,82	Rogan and Shanley, Inc.....(RAC 354).....	59
Design, Analysis and Research Corp.....(RAC 363).....	60	Rolex Company.....(RAC 412).....	84
Design Solutions Software Co.....(RAC 361).....	60	Rolyn Optics Co.....(RAC 486).....	132
De-Sta-Co.....(RAC 317).....	56	SAGA CAD & Drafting Supply.....(RAC 370,37).....	61
Dianachart Inc.....(RAC 311).....	56	Samtec, Inc.....(RAC 385).....	62
Digi-Key Corporation.....(RAC 515).....	5	Science Accessories Corporation.....(RAC 404).....	49
DSM Engineering Plastics.....(RAC 363).....	60	Seal Master Corporation.....(RAC 378,413).....	61,84
DSP Development Corporation.....(RAC 648).....	87	Sekai International.....(RAC 366).....	60
DuPont Corporation.....(RAC 618).....	8-9	Selco/Asahi.....(RAC 374).....	61
Eaton Corporation.....(RAC 606).....	65	Servometer Corporation.....(RAC 353,414).....	59,85
Eaton Corporation, Lebow Products.....(RAC 373).....	61	Sherex Industries.....(RAC 321).....	56
Edmund Scientific Co.....(RAC 411).....	83	SL Corporation.....(RAC 456).....	54
Elanix, Inc.....(RAC 448).....	48	Small Parts, Inc.....(RAC 351).....	59
Electroid Company.....(RAC 447).....	89	Soft Warehouse, Inc.....(RAC 470).....	107
Electro-Kinetics.....(RAC 418).....	89	Southco Inc.....(RAC 646,647).....	93
Elgiloy Limited Partnership.....(RAC 428).....	106	Speakeasy Computing Corp.....(RAC 440).....	124
Elmo Mfg. Corp.....(RAC 401).....	38	Stainless Design, Inc.....(RAC 327).....	57
EPIX, Inc.....(RAC 318,487).....	56,132	Stereographics Corporation.....(RAC 417).....	88
Eurocopter International.....(RAC 654).....	66-67	Stevens Products, Inc.....(RAC 312).....	56
Evans.....(RAC 407).....	96	Storage Concepts.....(RAC 367).....	60
Evergreen Systems International.....(RAC 480).....	132	StressTel Corporation.....(RAC 330).....	57
Exergy.....(RAC 443).....	125	Structural Research & Analysis Corp.....(RAC 408).....	96
Farrand Controls.....(RAC 476).....	133	Summagraphics Corporation.....(RAC 672).....	99
Firestone Industrial Products.....(RAC 355).....	59	SUNNEX.....(RAC 322).....	57
Fluke Corporation.....(RAC 516,437).....	51-53,115	SUNX Sensors/Ramco Electric Co.....(RAC 335).....	58
Folsom Research.....(RAC 465).....	126	Superior Electric.....(RAC 337).....	58
Frequency Devices, Inc.....(RAC 356).....	59	Surfware, Inc.....(RAC 342).....	58
Gage Applied Sciences, Inc.....(RAC 496).....	129	Swagelok Co.....(RAC 420).....	95
GTSI.....(RAC 642).....	28-29	Syntex Rubber Corporation.....(RAC 423).....	116
H.A. Guden Co., Inc.....(RAC 325).....	57	Tadco.....(RAC 343).....	58
Hardigg Cases.....(RAC 319).....	56	Technology 2003 Proceedings.....	123
Harris Corporation.....(RAC 656).....	47	Technology 2004.....	70,441
Heidenhain Corporation.....(RAC 377).....	61	Teladyne Electronic Technologies.....(RAC 664).....	39
Hewlett-Packard Company.....(RAC 402,419).....	40-41,90	Tescom Corporation.....(RAC 495).....	129
Hi-Techniques, Inc.....(RAC 344).....	58	Thomson Industries, Inc.....(RAC 520-527).....	63
Hughes Aircraft Company.....	11	Titan Tool Supply Co., Inc.....(RAC 334).....	58
Hunter Products, Inc.....(RAC 316).....	56	Toshiba America C.P., Inc.....(RAC 640).....	69
Hyperception, Inc.....(RAC 512).....	Cov IV	Tranter, Inc.....(RAC 644).....	81
HyperLogic Corporation.....(RAC 331).....	57	Tromper Electronics, Inc.....(RAC 600-601).....	133
IEE/INSPEC.....(RAC 384).....	62	United Electronic Industries.....(RAC 449).....	97
Illbruck.....(RAC 494).....	130	Velmex, Inc.....(RAC 425).....	100
Imaging Technology, Inc.....(RAC 698).....	18	Vibration Test Systems.....(RAC 329).....	57
Intergraph Corporation.....(RAC 638).....	23	Vigra.....(RAC 340).....	58
Integrated Engineering Software.....(RAC 467).....	27	Visual Numerics.....(RAC 537,434).....	25,110
Integrated Systems, Inc.....(RAC 632).....	15	Visual Solutions, Inc.....(RAC 405).....	50
International Designs Ltd.....(RAC 369).....	61	Voltek.....(RAC 430).....	85
Ironwood Electronics.....(RAC 339).....	58	WEITEK Corporation.....(RAC 614).....	33-77835
ISCAN.....(RAC 424).....	100	West Coast Lockwasher.....(RAC 323).....	57
ITI.....(RAC 315).....	56	Westinghouse-Flexible Test & Measurement System Group.....(RAC 375).....	61
ITOI Enterprises.....(RAC 345).....	58	Xerox Engineering Systems.....(RAC 338).....	58
Kalamazoo Technical Furniture.....(RAC 364).....	60	Zircar Products, Inc.....(RAC 426).....	108
Kaman Instrumentation Corp.....(RAC 445).....	106	Z-World Engineering.....(RAC 477).....	133
KAND Laboratories.....(RAC 471).....	133		
Kaydon Corporation.....(RAC 372).....	61		
KeveX X-Ray, Inc.....(RAC 498).....	127		
Labtech.....(RAC 416).....	86		

*RAC stands for Reader Action Card. For further information on these advertisers, please write in the RAC number on the Reader Action Card in this issue. This index is compiled as a service to our readers and advertisers. Every precaution is taken to insure its accuracy, but the publisher assumes no liability for errors or omissions.

Read This if You're **CRAZY** About Statistics:

The more you know about statistics, the more you'll love STATGRAPHICS *Plus*. With its completely menu-driven procedures, spectacular interactive 3-D graphics, and a choice of DOS or Windows versions, STATGRAPHICS *Plus* wraps together everything you've ever wanted in a statistics package.

STATGRAPHICS *Plus* makes complicated statistics easy. Point-and-click menus give you access to regression analysis, ANOVA, quality control, experimental design, multivariate and time series methods, nonparametric statistics, and much more. And STATGRAPHICS *Plus* for Windows includes our revolutionary new StatFolio, which makes saving and reusing your work a breeze. Then, when you need to rerun last week's analysis on a new set of data, just a few mouse clicks will recalculate everything automatically.

If you're ready for statistical graphics software that thinks the way you do, call us for details about STATGRAPHICS *Plus*. You'd be crazy not to.

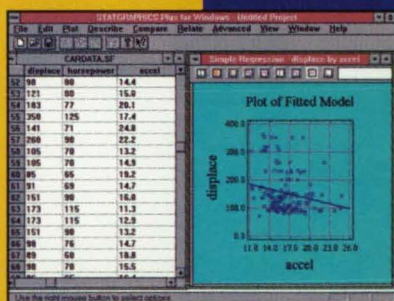
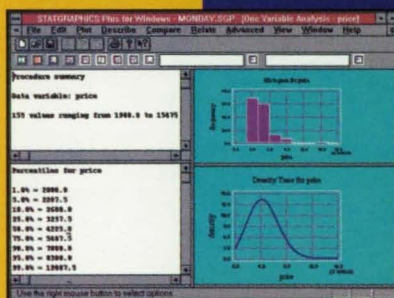
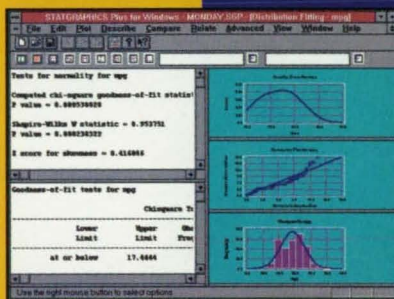
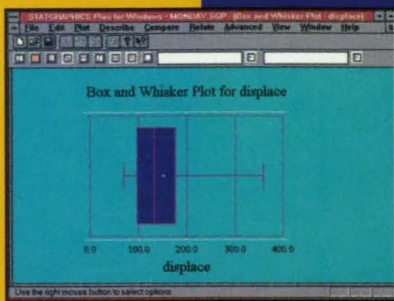

Read This if Statistics Drives You **CRAZY**:

The less you know about statistics, the more you'll love STATGRAPHICS *Plus*. Because you can use it to master statistics even if you barely remember statistics. STATGRAPHICS *Plus* is the easiest-to-learn, easiest-to-use statistical analysis package you can buy. And it's available in both DOS and Windows versions.

No matter how little you remember, or ever learned, about statistics, STATGRAPHICS *Plus* knows it all. In fact, *PC Magazine* says that STATGRAPHICS *Plus* "artfully combines statistics, graphics and data manipulation in an almost seamless way." With just a few keystrokes or mouse clicks, STATGRAPHICS *Plus* will help you make an accurate sales forecast, improve a manufacturing process, or work toward a cure for cancer. And if you ever need assistance, you can rely on our award-winning documentation, intelligent on-line help, and telephone support.

Fact is, STATGRAPHICS *Plus* is the perfect statistical graphics package for people who aren't crazy about statistics. After all, your data analysis problems shouldn't have to drive you insane.

STATGRAPHICS® *Plus*

In Maryland, 301-984-5123, Outside the U.S., 301-984-5412

800-592-0050, ext. 450

Manugistics, Inc., 2115 E. Jefferson St., Rockville, MD 20852. STATGRAPHICS is a registered trademark of Statistical Graphics Corporation. Quote reprinted from *PC Magazine*, May 11, 1993. Copyright ©1993 Ziff-Davis Publishing Company, L.P. Other trademarks are the property of their respective owners. STATGRAPHICS *Plus* runs on 386, 386SX, and 486 computers with at least 4 MB of RAM and a graphics card. DOS version for 286/640K machines also available. Authorized international dealers: Australia (03)866 1766, United Kingdom (071)436-9481, France (01)45-27-20-61, Germany (089)45114-0, (069)80053-0, (0212)339099, Italy (02)29404830, Spain (01)5350125, Sweden (031)776 01 21, Netherlands (03402)66336, Hong Kong 851-7998, Korea (02)222-3418, Taiwan (02)788-6777, Malaysia (03)717-0077, Poland (012)128-270, Singapore 254-5245.

For More Information Write In No. 517

Have Design Secrets to Unlock? Try our New Block...

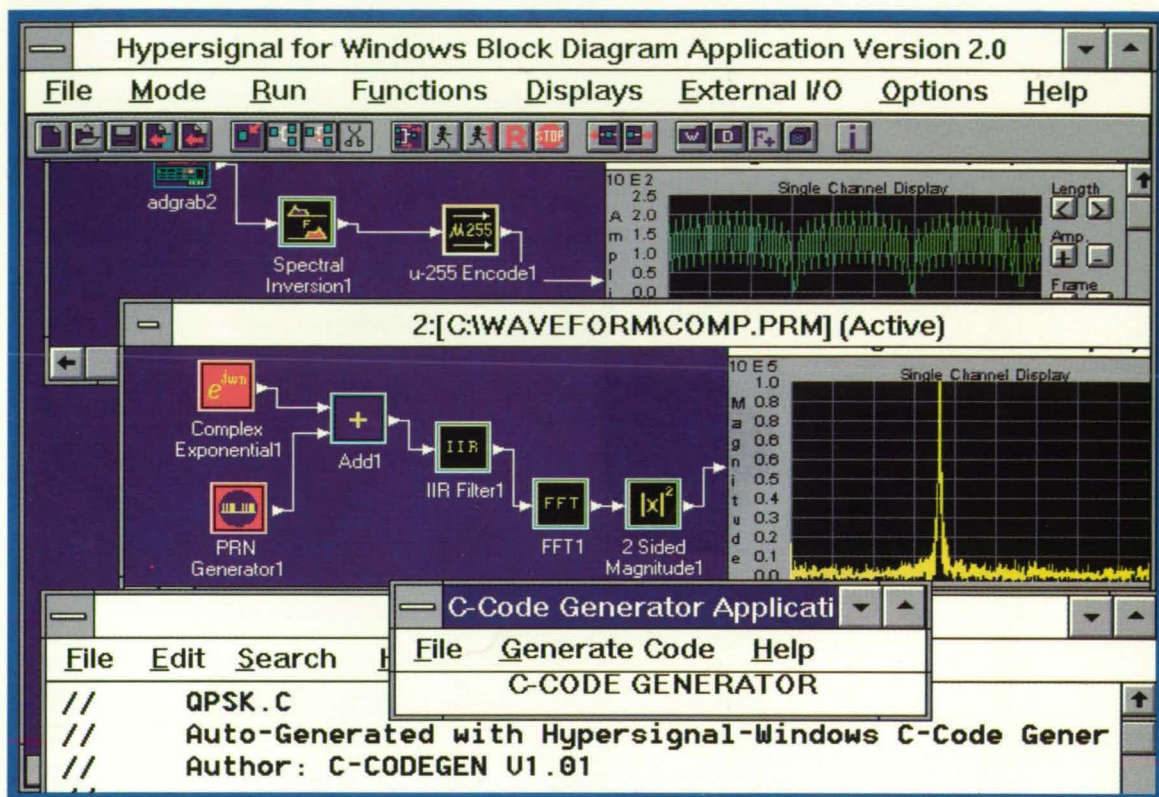

Hypersignal® for Windows Block Diagram V2.0

Advanced Object-Oriented Simulation Software under the
Microsoft® Windows™ Operating System

- **Visually Programmed** Simulation Environment for algorithm simulation and development
- Optional **C Code Generator** available for outputting 'C' source code
- **Open Software Architecture** with Presentation Quality Graphics
- **Real-Time support** of DSP/Acquisition Boards
- New Blocks may be created using standard C compilers
- **New Block Generator** utility for automating the creation of user-defined blocks
- Software architecture allows for many digital signal processing (DSP) applications including multi-dimensional algorithms
- **Hierarchical Capability** simplifies project design
- Improved conditional programming blocks
- **Flexible interface** to allow virtually every algorithm application from classical telecom applications to Digital Image Processing

For More Information Write In No. 512

Hyperception

International Distributors:

AUSTRALIA - Electro Optics PTY, LTD.; phone +61-2-654-1873; FAX +61-2-654-1539, • BENELUX - Inelco Components; phone +32-2-244-2924; FAX +32-2-216-4606, • DENMARK - Assentoft Electronics; phone +45-86-16-29-26; FAX +45-86-16-20-12, • FINLAND - ITT; phone +358-90-739100; FAX +358-90-701-5683, • ISRAEL - IES, LTD.; phone +972-3-7526333, FAX +972-3-7510927, • KOREA - Seoil Enterprise Co.; phone +82-2-237-0872; FAX +82-2-237-0874, • SINGAPORE - Bliss Services PTE LTD.; phone +65-3381300; FAX +65-3381900, • TAIWAN, ROC - Exartech International Corporation; phone +886-2-977-6828; FAX +886-2-977-6829, • UK, IRELAND - Loughborough Sound Images, LTD.; phone (0509) 231843, TLX 341409 LUFBRA G. FAX (0508) 262433.

For more information, including Free Catalog and Demo, contact: Hyperception, Inc.

9550 Skillman LB 125 • Dallas, Texas 75243
phone (214) 343-8525 • fax (214) 343-2457