

Liquid Rocket Engine Testing – Historical Lecture: Simulated Altitude Testing at AEDC

by

N.S. Dougherty

ERC – Jacobs ESTS Group, MSFC

INTRODUCTION

The span of history covered is from 1958 to the present. The [National Aeronautics and Space Act](#) was signed on July 29, 1958, and NASA became operational on October 1. The author began working at Arnold Engineering Development Center, AEDC, in June 1958 as a Co-op Student in the Engine Test Facility (later to be called the Rocket Test Facility).

The outline of this lecture draws from historical examples of liquid propulsion testing done at AEDC primarily for NASA's Marshall Space Flight Center (NASA/MSFC) in the Saturn/Apollo Program and for USAF Space and Missile Systems dual-use customers. NASA has made dual use of Air Force launch vehicles, Test Ranges and Tracking Systems, and liquid rocket altitude test chambers / facilities.

Examples are drawn from the Apollo/Saturn vehicles and the testing of their liquid propulsion systems. Other examples are given to extend to the family of the current ELVs and Evolved ELVs (EELVs), in this case, primarily to their Upper Stages. The outline begins with tests of the XLR 99 Engine for the X-15 aircraft, tests for vehicle / engine induced environments during flight in the atmosphere and in Space, and vehicle staging at high altitude. The discussion is from the author's perspective and background in developmental testing⁺.

⁺ ERC-Jacobs Technical Fellow. Senior Member, AIAA.

ROLES

The role of AEDC in USAF – Space and Missiles Division and NASA missions was:

- Supporting Systems procurement; altitude test before flight (boost, coast, start, separation, shutdown, restart); thrust, Isp_{vac} , thrust vector control performance determination

The role of MSFC in NASA as AEDC's customer is as the primary NASA site for:

- MSFC designed / developed components and test articles, propulsion and vehicle engineering (P & VE)
- Technology development test articles (MSFC engineering involvement)
- Propulsion component research and technology (low technology readiness)
- Cryogenic structural test articles (tanks, ducts, etc.)
- Alternate NASA site for liquid oxygen/liquid hydrogen (LO2/ LH2) ambient testing

AEDC was named an AIAA National Historic Site in 2007 [1]. AEDC is a member organization of the NASA/ DoD National Rocket Propulsion Test Alliance. The rich history of rocket testing at AEDC was reviewed by two former AEDC commanders in USAF publications [2] and [3]. See <http://www.nimr.org/systems/rockets/72-001.htm#Foreword>.

This paper was reviewed and is approved by NASA/MSFC for public release. Distribution is unlimited.

A part of this liquid rocket propulsion history – for the NASA customer – was the author’s history **highlighted in blue** in the Apollo / Saturn era at Sverdrup/ARO, Inc, at Sverdrup Technology; and now at Jacobs Technology with Jacobs’ small business teammate partner, ERC, Incorporated, as Sverdrup was contract-operator of AEDC (now the Aerospace Testing Alliance [ATA]) and facilities designer (now Jacobs Technology). The author later was among the users of AEDC’s facilities, working for Rockwell International and then the Boeing Company. **The author’s role spans participation as designer, test and analysis engineer, and industry user, working for both the USAF and NASA as customers, and in present support to NASA/MSFC, in propulsion, through Jacobs.**

Citing a quote from Col. A.F. Huber, USAF, **[3]** specifically about the Apollo / Saturn Program, *“During the 1960s, AEDC conducted some 55,000 hours of test support for the Apollo program, involving 25 of the center’s then 40 test facilities. These tests included simulated re-entry tests where thermal protection materials were evaluated. From 1960 to 1968, AEDC conducted more than 3,300 hours of wind tunnel tests, representing more than 35 percent of all of NASA’s Apollo wind tunnel tests. From June 1965 to June 1970, 340 rocket (engine static firing tests) were fired in the single largest test program ever conducted at the center to man-rate the Saturn V upper stages.”*

The author had the privilege of developing many relationships over the years with the many people at AEDC and who came to AEDC to test, among them engineers and technicians from Rocketdyne (Pratt and Whitney Rocketdyne), North American Aviation - Space and Information Systems Division, Aerojet, Douglas Aircraft Corporation (then McDonnell-

Douglas and now Boeing, Space Technology Labs (then became TRW), Grumman Aircraft Engineering Corp. (now Northrop-Grumman, United Technologies Corp., and Reaction Motors Div. of Thiokol Chemical Corp., and NASA/MSFC. Among them, the author wants to cite in particular the AEDC on-site Rocketdyne J-2 Engine Team of engineers and technicians for their great dedication/extraordinary work ethic.

We served the Wernher von Braun (b.1912-d.1977) Rocket Team from MSFC/Huntsville. The author wants to cite only a few persons by name from the Apollo / Saturn era and Space Shuttle era: Paul Castenholz, J-2 Engine Program Manager at Rocketdyne; Sam Iacobellis, Vice President of Rocketdyne; Lee James*, Apollo Program Deputy Director from 1962 on and Saturn Program Office Head from 1968 to 1971, Dr. Bernhard H. Goethert, my Sverdrup Facility Chief and Dean of UTSI, and Robert S. Ryan, of the NASA / MSFC Systems Dynamics Laboratory (formerly P&VE). If the reader will allow my use of the first person in telling anecdotes and making references, “I regard Bob Ryan as a mentor; I am only one of many.” And I cite Gen. Lief Jack Sverdrup.

A CHRONOLOGY

The following abbreviated chronology of major events is given as a backdrop:

- Explorer 1 launch (high elliptic orbit, 1563 nm apogee February 1, 1958; (reentry March 31, 1970)
- October 1,1958 **Formation of NASA**

* The author took courses in Management from Lee James at the University of Tennessee Space Institute upon Mr. James’ retirement from NASA.

- Mercury-Atlas 6 Friendship 7 John Glenn **first U.S. manned orbital mission**, February 20, 1962
- Apollo 7 (S-IB / S-IVB / CM / SM orbital mission), **first manned Apollo flight**, October 11, 1968
- Apollo 8 (S-V / S-IVB / CM lunar) **first human space flight to escape Earth's gravity**, December 21, 1968
- Apollo 9 (S-IB / S-IVB / CM / SM / LM) **first LM checkout flight**, March 13, 1969
- Apollo 11 **Lunar landing on July 20, 1969**
- Apollo 17 Last Lunar Mission Splashdown, December 17, 1972

Ref.: <http://history.nasa.gov/apollo.html>

Between the Mercury/Atlas and the Apollo/Saturn Programs was the Gemini/Titan Program (1962 – 1966).

VACUUM THRUST

AEDC's role in liquid propulsion testing performed, test objectives, and some problems found and solved are described herein, and include the measurement of thrust. The liquid rocket propulsion engines (LRPEs) and Stages involved included Saturn I and Saturn IB, the AJ 10-137 Service Propulsion System Engine and the Apollo Service Module, the Lunar Module Descent Engine, and Ascent Engine Bell 8528/RS-18, the Apollo Reaction Control System (RCS) thrusters, the Atlas MA Series Engines, the Titan LR 87 and LR 91 Engines, the Saturn V vehicle, the S-IV Stage and its RL 10 Engines, the J-2 Engine and the S-II and S-IVB Stages on the Saturn V, and the RL 10 on the Centaur vehicle, on the DC-X vehicle, and on Atlas and Delta Upper Stages, the Aerojet AJ10 and TRW TR-201 Engines on ELV upper stages and Bell 8096 on the Agena Target Vehicle for Gemini.

When the LRPE nozzle area ratio (AR) is large, then high AR characteristics must be tested in high-altitude and ultra-high-altitude test facilities. Key performance objectives for test include:

- High area-ratio (AR) nozzle behavior
- System thrust and impulse
- Heat transfer characteristics - both engine and vehicle base regions
- Thrust vector control (TVC) performance
- Systems performance / environments
- Plume characteristics at altitude
- Engineering / Integration
- Ignition / start / shutdown transients
- Induced environments

The test technique for measuring system thrust and impulse at near vacuum, Figure 1, is essentially the same for both LRPEs and Solid Rocket Motors (SRMs), only an accounting is made for the change in weight as propellant is consumed in SRM testing.

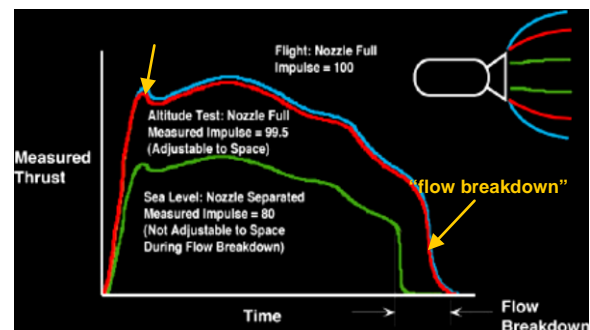

Figure 1. Test Technique for Measuring Thrust of LRPEs and SRMs

Thrust may be changing with time over the action time, and the total impulse (integration of the axial thrust – time curve) differs significantly for the green curve in Figure 1 for test of a system with a high AR nozzle, maybe

only 80 % of the vacuum impulse. A test at near-vacuum with approximately 125,000 ft pressure altitude simulation measures nearly 99 % of the impulse developed. Correction of measured thrust T , impulse I , and specific impulse I_{sp} to vacuum, which is the method of standardizing, is small, approaching about 1 %.

There is some small amount of thrust “overshoot” at ignition and “blowback” with the exhaust flow breakdown at cutoff. A steam-driven ejector in the exhaust gas supersonic diffuser with the exhaust diffuser connected to continuous flow secondary exhausters evacuates the test cell to near vacuum before test and takes over pumping at engine cutoff. The engine, firing into the diffuser duct when the duct diameter is properly sized to the engine, has ejector pumping action and maintains nearly the same evacuation pressure in the test cell.

It is essential to minimize the amount of blowback onto a delicate engine nozzle and base region so as not to cause test article damage. It is important in making the most accurate thrust and impulse measurement to account for the “blowback” with a flow breakdown impulse correction and for the “overshoot” with a correction that removes thrust stand dynamic response contributions to the as-measured “overshoot”. Both corrections are made in AEDC’s thrust and total impulse measuring as well as corrections for any thrust stand interactions and tare forces that may be introduced from pressurized propellant lines and instrumentation cables.

Accurate measurement of thrust and impulse in high altitude and ultra-high altitude test cells (static firings of rockets) involves:

- Accurate geometric alignment in the thrust stand
- Thrust butt and side restrictions to react all forces developed during test
- Axial Load Cell with hydraulic load calibration (in Vertical testing) or Dead Weight Load Application (in Horizontal testing)
- 3 – Component or 6 – Component Side Load Measuring Capability with hydraulic side load calibration system
- Capability for accurate determination of the thrust vector developed from gimbal or plume deflection Thrust Vector Control (TVC)
- Flexures in the load train for each component allowing for the extraction / correction of all thrust measurement interactions
- Both static and dynamic thrust extraction capability
- Capability for removal of tare loads across load paths

A 6-component thrust measuring system such as has been used in AEDC’s vertical Test Stands J-3 and J-4 is shown in Figure 2.

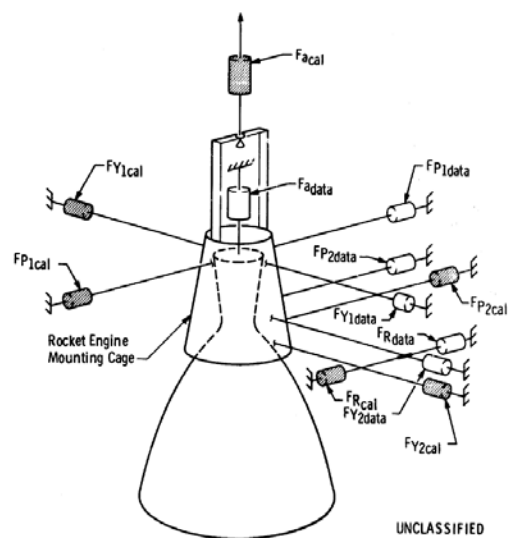

Figure 2. Six-Component Thrust Measuring System

If you will allow my use of the first person to tell anecdotes and lessons learned, I worked many hours at thrust measurement and calibrations. During dynamic thrust periods, the thrust stand-rocket engine mechanical system natural frequencies may be excited, and large measurement errors are possible. The nature of the dynamic thrust measurement in a captive static firing first involves the whole thrust-reacting structure, and the degree of success in analytically predicting the responses of a complex mechanical structure to input forces is directly determined by the adequacy of the model used to approximate the particular structure. Calibrations were made at simulated altitude conditions with the thermal conditioning at stabilized condition, and where facility vibration influences that might affect the impulse measurements could be removed by appropriate corrections.

This was a lengthy calibration process to account for thrust stand interactions, tares, thermal effects, and dynamic influences [4b] and, in the case of horizontal testing with a dead weight axial thrust calibrator, accounting for buoyancy effect of the Test Cell being evacuated during altitude pre- and post-cal measurements and calibrations versus the “sea level” pre-cals and post-cals where air pressure was 14+ psia. The accuracy of measurements obtained is very much in the procedural details. The **lesson learned** is about accounting for the environmental effects and dynamic responses.

The major enabler of the high-altitude rocket test cell to test at near-vacuum conditions was the steam-driven ejector in the supersonic exhaust gas diffuser [4a], even with near zero induced flow. AEDC has, in addition, facilities to test with flight simulation at all altitudes in upper atmosphere for subsonic,

transonic, and supersonic flight with the propulsion system “On”. These are AEDC’s continuous flow propulsion wind tunnel circuits with scavenging scoops and test cells that have continuous airflow delivery plus exhaust cooling water sprays and exhaust plant machines for airflow-plus-exhaust products removal.

INDUCED ENVIRONMENTS

Tests for various vehicle-engine induced environments were treated in the early years at AEDC as special projects. Among these were base flow recirculation / plume heating effects and plume-induced flow separation on the vehicle. The engineering specialties are in the areas of aeroheating, plume radiation heating, base flow recirculation/plume heating effects, and plume-induced flow separation on the vehicle.

An Atlas base flow model, Figure 3, was tested in AEDC’s T-1 Test Cell simulating high-altitude flight in the atmosphere with hot firing model MA Series engines and their turbine exhaust disposal methods. The model base with the two booster engines and sustainer engine at the center was instrumented with calorimeters, radiometers, thermocouples, and pressure transducers to measure heating rates in the base region for varied configurations at varied simulated altitude [5 – 7]. Additionally, base flow studies were performed at AEDC in research facilities with cold flow air simulation of various four-nozzle configurations including a Saturn S-IV Stage simulating a LO2/LH2 RL 10 Engine cluster firing in T-3 Test Cell. We used γ – scaling to actual hot-fire exhaust products. First-hand participation in these base flow induced environment tests formed the author’s introduction to rocket testing as a Sverdrup Co-op Student in 1958-1961.

The Atlas missile model is shown in Figure 3 together with various Atlas MA Series Engines. Figure 4 is a photograph of a hot firing in a sea-level test stand (engine pictures courtesy of

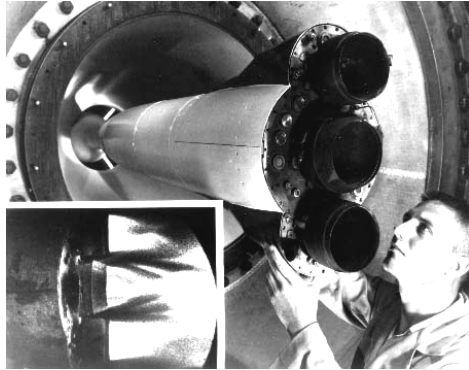

a. Atlas Missile Model in T-1 Test Cell

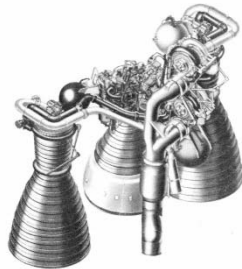
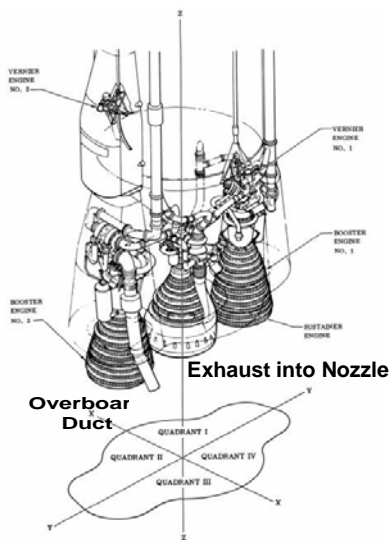

b. Atlas MA-3 and MA-5A Engines

Figure 3. Atlas Missile Model Testing

Pratt and Whitney Rocketdyne) and of the Mercury / Atlas Friendship 7 MA-6 Launch Vehicle (LV) 3B on February 20, 1962 (from Wikipedia). Figure 5 shows cold-flow recirculation (mica dust tracer particles) into the base at high altitudes (> 70,000 ft).

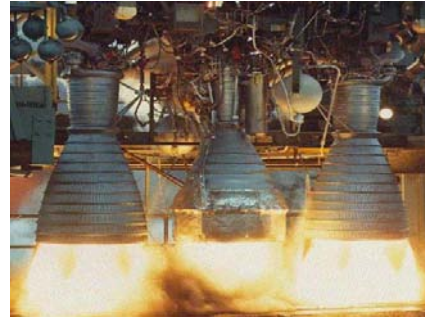
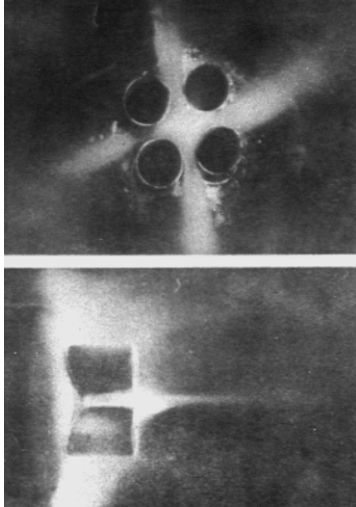
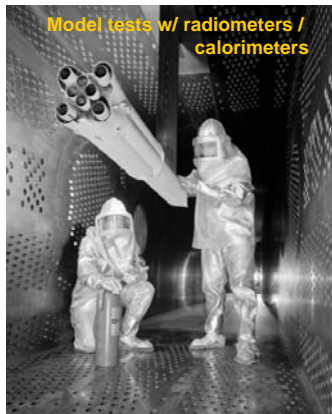

Figure 4. Atlas Engine and Mercury/Atlas Launch

The Saturn S-I vehicle was tested in its SA-1 (first launch) configuration in the AEDC 16-Ft Transonic Propulsion Wind Tunnel and in NASA's Lewis Research Center's 8 X 6-FT Transonic Wind Tunnel, Figure 6. Base flow and heat transfer data were acquired on 5.47 % S-I configurations using LO₂/RP-1 propellants and GH₂ simulant for turbine exhaust. The cold-flow research studies were performed in T-5BR Test Cell. These test helped the inclusion fins and air scoops into the base and in base heat shield design for arriving at the eventual Saturn I-B configuration for the nine S-IB flights designated the SA 200 series.



**Figure 5. Four Nozzle Base Flow Test
– High Altitude in T-5BR Test Cell**



**Figure 6. Saturn SA-1 Vehicle Model in the
NASA/Lewis 8 X 6 – Ft Wind Tunnel**

Base configurations included a center tap turbine exhaust for the four Saturn I center engine cluster and the aspirator turbine exhaust

collector for the four outer H-1 Engines. There was a Block I configuration with the eight engines giving the target 1.5 m lbf thrust and then an uprated Block II H-1 configuration of still higher thrust. The AS-203 and subs configuration, Figure 7, had four turbine exhaust ducts to the star-shaped center flame shield used for the crewed Apollo orbital flights.

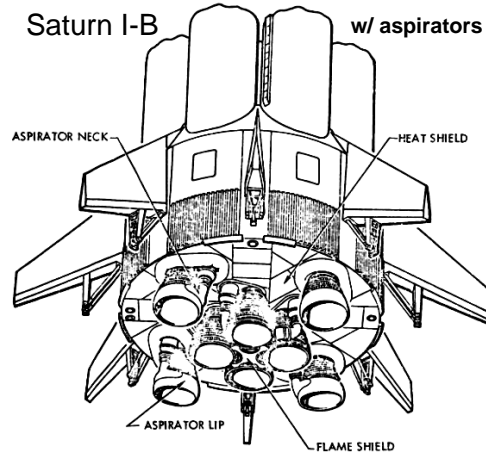

FIGURE 3.1-9. BASE VIEW OF SA-203 AND SUBSEQUENT LAUNCH VEHICLE



Photo courtesy of Chrysler

**Figure 7. Saturn I-B Base Configuration
– AS-203 and Subsequent**

The role of AEDC testing was performance determination for vehicles engines, and stages, in high-altitude flight in the atmosphere at and near staging and in the vacuum or near-vacuum pressure altitude of Space. A Saturn I-B vehicle at launch from Pad 34 and in high-altitude flight is shown in Figure 8. The fuel-rich low-energy

turbine exhaust burning in the base region is clearly in evidence.



**Figure 8. Saturn I-B Launch and Flight
– Crewed Configuration**

The author's role was to help in data reduction for these base recirculation / heating tests and that included specifically keeping the chamber pressure log on the eight model engines in these tests. The high-altitude flight of the Saturn V vehicle is depicted in Figure 9. The AEDC role in the Apollo/Saturn V testing was in the aerodynamics and staging and focused particularly on the S-II and S-IVB Upper

Stages and on Command and Service Module (CSM) in-space propulsion systems. The photographs shown in Figure 9 are of the Apollo 11 launch (AS-506) during transonic flight and at staging of the S-IC and S-II second stage.

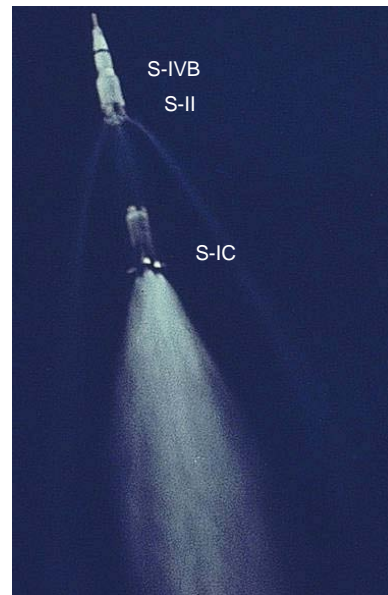

NASA photos

**Figure 9. Apollo 11 Saturn V in Transonic
Flight and at S-IC/S-II Staging**

Between the Mercury/Atlas and Apollo/Saturn Programs were the ten crewed flights of the Gemini/Titan Program in 1965-66. There was a pusher-type Gemini Launch Escape system, different from the tractor-type Launch Escape Tower in the Mercury and Apollo flights

and Launch Abort System designed for the Ares/Orion vehicle. The Gemini Escape System aft section (containing the four solid-propellant rocket escape motors), the RCS section, and the Titan Gemini Launch Vehicle (GLV) 2nd Stage Forward Skirt/Tank Forward Dome were tested in AEDC's J-1 Test Cell on horizontal rails with varied separation distance of the Gemini Spacecraft away at ignition. Upon ignition of the escape motors, there was "fire in the hole", the severity of the blast on the Tank Dome varying with the separation distance in staging before the Launch Escape Motor Ignition Command. Measurements were made about the thermal / structural environment to the Tank Dome and possibility for escaping shrapnel / debris. The Gemini Spacecraft and Launch Escape System are shown in Figure 10.



NASA photo

b. Gemini 6 in Orbit - 1965

Figure 10, concluded

The author helped support the rail test setup in J-1 Test Cell in 1961.

Calculations using Prandtl-Meyer expansion angles and plume boundary envelope mapping were made for both ideally-expanded and under-expanded exhaust plumes at pressure altitude, and a test was performed in J-4 Test Cell of an under-expanded LRPE with N₂O₄ and Aerozine 50 (50-50% N₂H₄ and UDMH blend) as the propellants. The plume boundary is clearly visible in Figure 11 as the

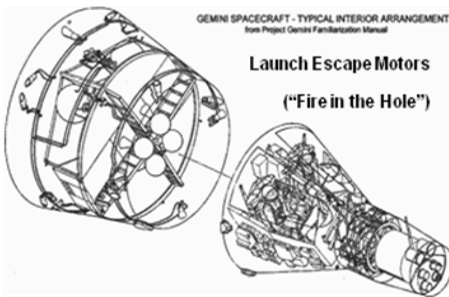

a. Gemini LES Arrangement

Figure 10. Gemini Launch Escape Tests in J-1 Test Cell

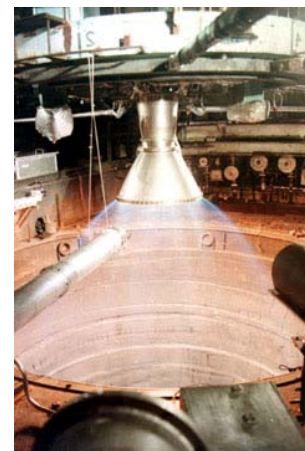

Figure 11. Under-Expanded Plume Test in J-4 Test Cell

plume expands to fill the supersonic exhaust diffuser diameter. The Gemini Launch Escape System tests in J-1 Test Cell included secondary airflow past the separating Gemini/Titan stages for staging in high-altitude flight in the atmosphere. For testing at AEDC at near-vacuum conditions for in-Space simulations, the rocket test article itself provides ejector pumping action down to near-zero secondary flow from the test cell. This design feature is key to maintaining the pressure altitude about the engine and/or stage inside the Test Cell capsule, or chamber.

My career choices to work in thermal and fluid dynamics specialties were largely shaped by these experiences of getting to work in the clustered engine liquid propulsion testing and data analysis I have related here. Our testing at AEDC on these vehicle systems was a significant contributor to how liquid propulsion as we know it evolved. The lessons learned were in all the plume-induced environment testing - base recirculation and multiple plume interactions, plume heating effects, and characteristics of plume expansion at altitude and in-Space measured with thermocouples, radiometers, and calorimeters. They have influenced the propulsion system and vehicle designs. That we could do it with scale model testing was the lesson learned. AEDC testing played a major part in the evolution of solutions for multi-engine base heat shield designs and methods of disposal for the turbine exhaust gases.

THE APOLLO SPS ENGINE

We tested full-scale flight engines and Stages at simulated pressure altitude and with great attention to details of thermal / vacuum

simulation to put engines systems through 'test before flight' in a simulated Space environment. Engines and systems were tested as part of their completing development, environmental, qualification, and acceptance testing at AEDC before flight. The first of these I describe was the Apollo Service propulsion System (SPS).

The Apollo Service Propulsion System (SPS) Engine was tested in AEDC's J-3 Test Cell. The test installation included the F3 Fixture – the ground test version of the Apollo Service Module propellant tanks, lines, avionics, with hydrodynamic characteristics simulation. The SPS Engine was an Aerojet AJ10-137 Engine and the F3 Fixture was made by North American Aviation - Space and Information Systems Division. The North American Apollo Command Module (CM), Service Module (SM), and Grumman Lunar Module (LM) Spacecraft are shown in Figure 12, joined in Space in Low Earth Orbit (LEO).

The J-3 Test Cell is shown in Figure 13. The Apollo SPS Engine is shown in Figure 14 being lifted in place on J-3 Test Stand. A close-up view of the SPS Engine with its columbium radiation-cooled nozzle extension is shown in Figure 15.

The Apollo SPS Engine burned N₂O₄ and Aerozine 50 propellants and developed 21,900 lbf thrust at 100 psia chamber pressure (P_c), AR = 62.5. The Engine installation with its F-3 Fixture, thrust measuring system (Figure 2), and a LN₂ - cooled panel to simulate thermal radiation to Space and accomplish thermal conditioning of the spacecraft and engine (20 to 130 °F propellant delivery) were installed in the test capsule.

The supersonic diffuser and steam-driven ejector exhausted to saturation cooling water

sprays and was connected to continuous - flow secondary exhaust machines exhausting to atmosphere. There were scrubbers provided for treating the drained, vented, and purged propellants to be chemically reacted (and thus inerted) before release to the atmosphere. The author contributed to the design of the Hart and Rader ground hypergolic propellant storage and transfer system at J-3 Test Cell as a young engineering graduate at work after the Co-op Program (1962).

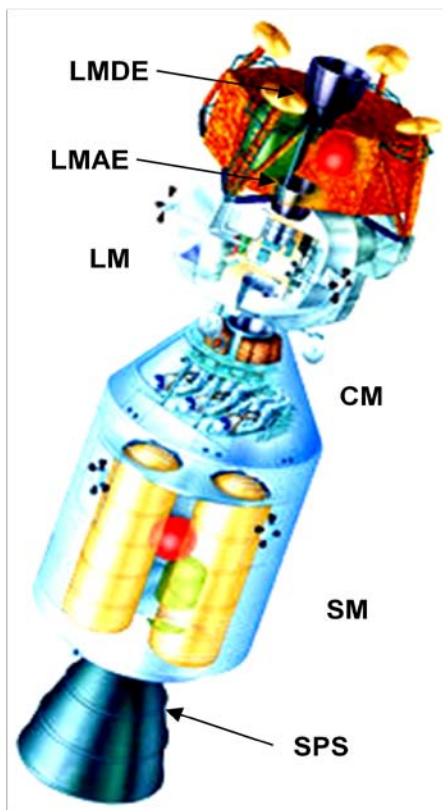

Figure 12. Apollo CSM (CM/SM) and LM Joined in Space

The SPS Engine is clearly visible in Figure 12 (at the bottom). The Lunar Module Descent Engine (LMDE) is at the top, and the Lunar Module Ascent Engine (LMAE) is visible on the LM Ascent Stage. The crew of three astronauts is visible inside the CM.

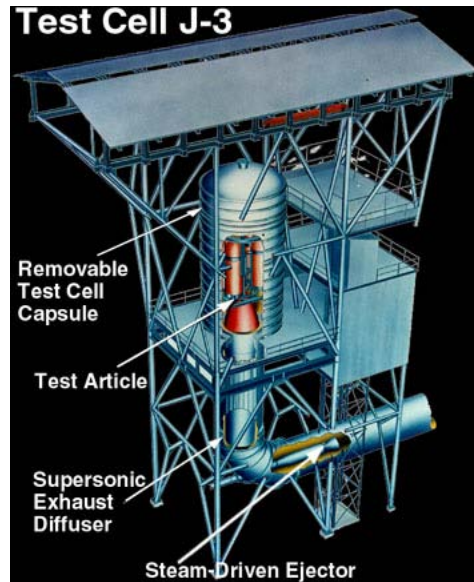

Figure 13. J-3 Test Cell Artists Cutaway View



Figure 14. Apollo SPS Engine being Hoisted up to the J-3 Test Cell Capsule

Later versions of the AJ10 engine have powered Titan, Atlas, and Delta Upper Stages, e.g., the AJ10-118K version Upper Stage Engine, which is planned for the Constellation Orion Service Module main propulsion.



Figure 15. Aerojet AJ10-137 Apollo SPS Engine

The test program at AEDC proceeded in six phases with many firings (hundreds) conducted simulating altitude start, coast, and restart with a pressure altitude above 110,000 ft and thermal conditioning for the test environment [9-13]. Engine Block I and Block II versions were tested. Test objectives included:

- Engine steady-state operation and performance – varied mixture ratio (MR)
- Engine ignition and shutdown transient performance
- Engine thrust vector control (TVC) determination
- Qualification of the Bi-Propellant Valve
- Engine stability rating (bomb tests)
- Six – component thrust measurement and in-place propellant flowmeter calibration

I began as a young design engineer working on modifications to the Hart and Rader storable propellant ground storage and transfer system at J-3 Test Cell. We delivered propellants for test to the Apollo SPS run tanks in the F-3 Fixture. I was a part of the test support team and had a part in this piece of history.

AEDC flowmeters were installed and in-place flowmeter calibration was accomplished in the J-3 Test Stand. The engine gimballed and thrust and thrust vector forces and moments were measured using the six-component thrust measuring system. There were accelerometers complete with voting logic for an automatic engine shutdown in the case of excessive vibrations. A weigh-tank system was utilized for in-place flowmeter calibrations. A heat shield was installed on the F-3 Fixture for protection against the radiated heat from the radiation-cooled nozzle extension. Altitude thrust and impulse measurements made were corrected to vacuum. The nominal MR was 2.0.

Testing of the Apollo SPS Engine in J-3 Test Cell included:

- Engine Development Testing
- Mission Duty Cycles (for SM)
- Engine Qualification Testing

This was over the period from 1964 to 1968. Qualification testing included 72 firings with an accumulated duration of 4524 sec conducted on six engine assemblies at pressure altitudes up to approximately 115, 000 ft between November, 1966, and February, 1967.

The Apollo SPS Engine flew the first time on AS-202 (called informally Apollo 3), August 25, 1966, a Saturn V/S-IVB launched mission to LEO. The SPS Engine was fired four times. The SPS

Engine accelerated the spacecraft to 8.9 km/sec (20,000 mph) at 66 nm altitude for a roller-coaster type reentry.

The Apollo SPS Engine flew for the next time on Apollo 4 (AS-501), the first Saturn V flight, November 7, 1967. The launch (near perfect) placed the S-IVB and Command and Service Module (CSM) into a 100 nm orbit. After two orbits, the S-IVB reignited for the first time, putting the spacecraft into an elliptical orbit with an apogee of more than 9,100 nm. The CSM separated from the S-IVB and fired its Service Propulsion System (SPS) Engine to send it out to 9,700 nm. Passing apogee, the SPS Engine fired again to increase re-entry speed to 11.1 km/sec (21,600 mph), simulating a return from the Moon.

Apollo 6 (AS-502), April 4, 1968, with a CSM and a dummy Lunar Module (LM), second flight, had a failure of the S-IVB to restart in orbit. The Service Module Engine was then used to raise the spacecraft into a high orbit to complete some of the mission objectives. It burned for 442 sec, longer than it would ever have to on a real Apollo mission and raised the apogee of the orbit to 11,900 nm. There was now, however, not enough fuel for second burn to speed up the atmospheric reentry, and the spacecraft entered the atmosphere at a speed of 10 km/sec (22,500 mph) instead of the planned 11.27 km/sec (25,400 mph).

On Apollo 7 (AS-205), October 11, 1968, the Apollo hardware (no LM this mission) and all mission operations worked without any significant problems, and the Service Propulsion System (SPS), and the all-important SPS Engine that would place Apollo into and out of lunar orbit, made eight nearly perfect firings.

The SPS Engine mission performance was excellent for the first lunar mission Apollo 8 and the LM checkout flight Apollo 9, for all Lunar missions through Apollo 17, December, 1972, and for the NASA/MSFC - McDonnell-Douglas Apollo-SKYLAB Program, Figure 16, 1973-1974, and the Apollo-Soyuz Test Project (ASTP), July 15, 1975, see Figure 17.

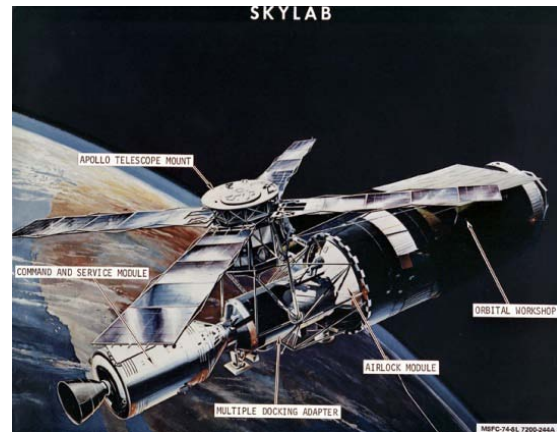

Figure 16. Apollo CSM and SKYLAB Mated in LEO

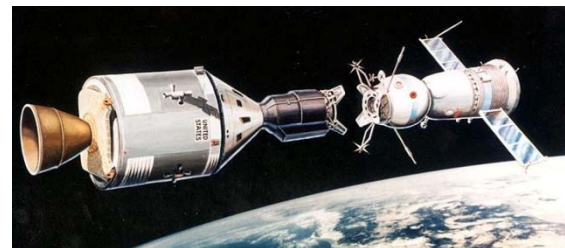

Figure 17. Apollo - Soyuz Test Project shown here Docking in LEO

An important lesson learned in the Apollo SPS testing I will generalize to other systems-level testing that hydrodynamic simulation should be done to greatest extent practical. This was particularly important to understanding and clearing the engine 'overshoot' at start measured in flight and doing good thermal conditioning in understanding the venting of propellants. It was found that five minutes of venting between engine firings would be

adequate if propellant and injector temperatures are maintained above 55° F before a restart in Space. That evaporative freezing of the residual propellants in the injector might result in clogged injector passages had been the concern.

Both issues - the overpressure at engine start and the venting after engine shutdown - were reasons for special tests added at AEDC after orbital flight testing had begun.

A full-scale production Apollo SPS injector was modified to accommodate detailed instrumentation and visual observation capability during a series of propellant rapid expansions to high vacuum conditions in January-February 1968 to determine the venting characteristics of the injector.

On the Apollo 6 flight (AS-502) flight, engine performance had been satisfactory except for an overshoot in chamber pressure during engine start. All other engine-transient criteria had been met [26]. For the Apollo 4 and 6 flights missions, the chamber pressure transducer mounting had been changed on a 2-in. adapter to reduce thermal effects that had caused an erroneous chamber pressure drift in ground testing before flight. The overshoot measured with the new adapter on this unmanned test flight was significantly higher than with previous adapters. The magnitude and duration of the measured overpressure (overshoot) was in the range of what would be considered detrimental to the Command Module/Lunar Module Interstage structure of the Apollo vehicle.

A special test series of 54 tests was conducted in June 1968 in J-3 Test Cell using high-resolution instrumentation to determine if the indicated high overshoot was caused by

instrumentation error. From these flight support tests completed before the first manned flight, Apollo 7, it was determined that that thrust chamber pressure overshoots were reduced significantly if the engines firings were initiated with a single bank of ball valves (single-bore starts), overshoots of 5-25 % occurred, and dual bore starts had been 25-40 %. The **lesson learned** was in the flight procedure for engine start. It became standard operating procedure to start each engine firing in the single-bank mode. If the burn was scheduled to be longer than 6 sec, the redundant bank was opened approximately 3 sec after ignition.

The **lessons learned** included having the ability to support flight operations making use the ground test data records in near real time while monitoring flight data, and that having to do another test series with high-resolution instrumentation added to resolve an issue had resulted from the lack of sufficient instrumentation being in place in previous testing.

More than one ground test program in the 1960s pointed to an awareness of needs for some high-frequency and high-resolution instrumentation always being on the test articles to detect dynamic phenomena that might be occurring, and there was scrutiny applied to transducer mounting blocks and adapters to understand and minimize the potential for instrumentation error. The **lesson learned** was in having high-frequency instrumentation in place during ground testing to detect transient and high-frequency response dynamic phenomena.

Systems-level testing that includes runs at a considerable number of off-nominal test conditions was planned in the Apollo testing, a very large number of tests (over 13,000 sec engine time) on the SPS being a part of its acceptance.

THE LUNAR MODULE DESCENT ENGINE

The Apollo Lunar Module Engines and quad cluster Reaction Control System (RCS) thrusters on the SM and LM were tested in AEDC's J-2A Ultra-High Altitude Test Cell.

Key design features of the J-2A Ultra-High Test Cell - exhaust pumping/altitude simulation/thermal conditioning (200,000-350,000 ft Space environment) were:

- It consisted of an 18.3 ft. diam X 32 ft. long liner with mechanical vacuum pumps plus LN2 cryo liner and GHe panels inside a 20 ft diam duct.
- Small engines were fired directly in the diffuser for long durations at altitudes from 130,000 to 200,000 ft.
- Test Cell altitude, pcell/pexhaust, and long thermal soak were produced by vacuum pumps and LN2 cryo panels and infra-red heaters in the Test Cell.
- Capability existed for very long thermal/vacuum soak (days before Engine firing) at 350,000 ft. Infra-red heaters added propellant thermal conditioning.
- Engine restart after long thermal /vacuum soak was facilitated.
- Exhaust products were collected through ejector – diffuser pumping action out through the facility exhaust machine secondary pumping system and discharged to atmosphere.

Small engines – the LM Descent Engine and Ascent Engine were fired into a 6-ft or 5-ft diam. exhaust diffuser duct equipped with a diffuser valve on the end which was opened for engine firings and closed at engine cutoff to

minimize blowback. A Mylar blanking disk was installed in the diffuser duct which was blown with pyrotechnic charges at Engine Start so that the engine under test was pumping with a sized diffuser insert to maintain pressure altitude in the chamber. With the diffuser valve closed producing isolation of the chamber from the facility exhausters, a replacement Mylar disk valve was rotated into place which sealed against the exhausters and allowed an engine restart with the diffuser valve reopened.

Mechanical exhaust pumps connected to the J-2A Test Chamber produced the near-vacuum pressure altitude of 200,000 ft or more with a LN2 cryogenic liner and cold GHe cryo pumps raising the simulated altitude on up to as much as 350,000 ft. With black body radiation to a dark liner wall, cold thermal conditioning was provided to simulate coast in Space before ignition, the engine burn, coast and thermal conditioning again for a period time, and then a restart again in the near-vacuum Space simulation. The diffuser was LN2 cooled.

Very long test periods (for days) took place in the J-2A Test Cell to simulate thermal/vacuum soak and mission sequences. Infra-red heaters provided propellant heating simulation.

The author got to help as an analysis engineer in 1965 in the data analysis – thrust performance measurements and specific impulse determination – that we did in the LM Descent Engine (LMDE) testing.

The TRW Lunar Module Descent Engine (LMDE) had been tested by TRW in its Capistrano Test Site (Grumman High Altitude Test Stand), San Juan Capistrano, CA, and then in 1965-66 in J-2A Test Cell. There were issues in the early J-2A testing at AEDC with contamination in the propellant systems (that

was quickly cleaned up) and one nozzle damage incident due to blowback from the exhaust diffuser (required a nozzle replacement).

The LMDE (Descent Propulsion System) burned N₂O₄ and Aerozine 50 as propellants and developed 9,870 Lbs max thrust. Stable operation was demonstrated for the LM Descent Engine over a range exceeding the 10:1 throttle requirement with TRW's pintle-type injector. This was a first in LRPE technology and enabled the soft Lunar Landing for the Apollo Program. We tested the LMDE in continuously throttleable operation from 6,000 lbf vacuum thrust down to 1,000 lbf thrust.

Many tests (in two different series of firings August 1965 to June 1967) were performed on two LMDE's in J-2A Test Cell with varied thermal conditioning in vacuum conditions and engine start in the simulated Space environment and landing sequence throttle-down. There were numerous duty cycle firings and then tests with varied quantities of GHe ingestion in the propellant feedlines to test the engine's tolerance for helium ingestion.

Two Lunar Module Descent Engines (LMDEs), Figure 18, were tested at simulated ultra-high altitude in Test Cell J-2A [12] to:

1. evaluate the thermal characteristics of the engine and engine compartment
2. evaluate starting characteristics of the engine after temperature conditioning in the simulated Space environment
3. perform thermal soak in coast periods and engine start

Note: Many of the facts and data here about flight history and other facilities are given in Wikipedia and other historical archive sources.

4. evaluate engine operation/shutdown with varied GHe ingestion
5. have NASA Astronauts come to AEDC to operate deep throttle Lunar Landing simulation tests (for stable operation, accurate control demonstration).



Figure 18. TRW LM Descent Engine

A key to LMDE success was its precision throttleable cavitating venturi valves [20].

Two astronauts came to AEDC in the Deep Throttle Lunar Landing simulation tests in J-2A to operate the throttle, which was placed on the center console in the Control Room.

Apollo 5 (AS-204), no crew, was launched on January 22, 1968. This was the first test flight of the Lunar Module (LM). The primary objectives of this flight were to verify ascent and descent stages of the LM propulsion systems, restart options, spacecraft structure, LM staging, Saturn S-IVB 2nd Stage performance, and Instrument Unit orbital performance.

The Apollo 5 mission was the first to test the LM Descent and Ascent Stage operation. After two orbits, a planned 39 sec burn of the LMDE was aborted after four sec. (There was an automatic cutoff command if thrust did not build quickly enough, and the 4 sec pre-mission design estimate did not allow enough time to pressurize the propellant tanks). The Descent Engine was fired manually two more times in this first flight test. They then performed the "fire in the hole" staging test of the LM Ascent Engine and another Ascent Engine burn after Stage separation.

The engine had an ablative thrust chamber and radiation-cooled columbium nozzle. Because of the location, an engine design with sufficient cooling was needed to prevent overheating of the surrounding propellant tanks during engine operation. The development and qualification of the DPS in support of the first Lunar-landing mission covered a period of approximately 6 years from August 1963 to April 1969. This included component-level and system-level development and qualification. In the developmental and qualification testing of components and systems, extensive design-limits tests, off-limits tests, and malfunction tests were used to determine potential design deficiencies and to document operational limits of the system.

The **lesson learned** was one of thoroughness and rigor in testing including the off-nominal that later proved important on the Apollo 13 mission in the LMDE for a life-boat back-up propulsion system for the SPS. A critical Apollo 13 ground decision was made based on the test data the LMDE thrust chamber ablation had not been too much for the required restart and long-duration burn for the Earth return trajectory.

A **lesson had been learned** from the first LM flight (Apollo 5) was that the LMDE automatic cutoff incident might have been avoided had there been improved interface control regarding engine thrust buildup rate and the GN&C ΔV monitor. A change had been made on this first LM flight to leave a fuel control valve closed until Engine Arm (normally opened several sec earlier) which allowed fuel to the manifold, because the valve was suspected to be leaky.

The Apollo 9 (AS-504) mission, March 13, 1969, was the first manned flight of the Apollo Command/Service Module (CSM) with the LM. The mission proved the LM worthy of manned spaceflight. Two crew members test flew the LM and practiced separation and docking. They flew the LM out 111 nm from the CSM in LEO on the LMDE and then jettisoned it to return to the CSM on the LM Ascent Stage. The S-IVB 3rd Stage was restarted and sent into the Sun with a burn that depleted the propellants.

On the Apollo 13 mission in April 1970, after Oxygen Tank #2 in the SM exploded on that mission en route to the Moon, the LMDE was used to accelerate the attached CSM/LM Spacecraft around the Moon and back to Earth, the LM becoming a 'life raft' for the astronauts on that mission as the CSM had developed serious problems, recovering sufficiently to make a safe reentry and splashdown.

THE LUNAR MODULE ASCENT ENGINE

The Lunar Module Ascent Engine (Ascent Propulsion System) development test program was conducted in J-2A Test Cell in 1964-66 in four phases [9]. This was the Bell Aerospace Corp. Model 8258 Engine with two different

types (manufacturers) of the all-ablative thrust chamber-nozzle assembly. Chamber pressure was 120 psia for 3,500 lbf vacuum thrust at a nominal MR = 1.6.

There was combustion instability present and a parallel contract to Rocketdyne to develop an alternate injector resulted in use of the new injector proved to be stable in the Bell thrust chamber and nozzle. There were simulated duty cycle tests for the engine to safely lift the two-man LM Ascent Stage from the Lunar surface plus return cargo of Moon rocks and rendezvous in Lunar orbit with the CSM. There was one destructive chamber explosion in 1965 in J-2A Test Cell due to an improper post-fire purge operation.

There was evaluation of the proposed LM vehicle staging technique where a 60-in diam. steel deflector plate was positioned 7 to 10 in. downstream of the nozzle and short duration firings were made to determine plume impingement effects on the Ascent Engine performance. The flow passed around the plate and was collected and pumped in the exhaust diffuser. There were shocks in the nozzle plume as the engine started when the distance was 7 in. which were alleviated if the plate was inclined at 10 deg. There were no shocks at 10 in. distance (the engine giving its full thrust at ignition before flyaway from the LM Descent Stage). As mentioned above, Apollo 5 (AS-204) performed a "fire in the hole" test whereby the LMAE would be fired still attached to the Descent Stage simulating an in-flight abort situation.

Rocketdyne eventually became the engine systems integrator, and the engine got the designation RS-18. After the Apollo 5 (AS-204) flight, there was the Apollo 9 (AS-504) first crewed checkout flight of the LM with in-flight

staging in Earth orbit. Apollo 9 was the first flight of a manned spacecraft not equipped to reenter the Earth's atmosphere and the Ascent Engine was used to return to the CM. There were two Ascent Engine burns to an elliptic orbit of 3700 nm apogee. The Apollo 10 (AS-505) crewed flight, which made a close approach to the Moon, did in-flight staging within 8.4 nm of the Lunar surface. There was a little jostle at staging in the Apollo 10 mission in making the transition from the Descent mode computer over to the Ascent mode of powered flight.

There was an extensive Ascent Propulsion System (APS) development and qualification program conducted at White Sands Test Facility. A major **lesson** had been **learned** in parallel engine component development work to overcome the combustion instability issue with the LM Ascent Engine and complete qualification and acceptance of the LM on time with the other Apollo propulsion systems.

The LM Ascent Engine test program at AEDC was conducted in four phases. The ascent engine is a fixed-injector, restartable, bi-propellant rocket engine that has an ablatively cooled combustion chamber, throat, and nozzle extension. Propellant flow to the ascent-engine combustion chamber is controlled by a valve-package assembly, trim orifices, and an injector assembly. The valve package assembly is equipped with dual passages for both the fuel and the oxidizer and has two series-connected ball valves in each flow path.

The Bell Aerospace/Rocketdyne Model 8258 / RS-18 Engine is shown in Figure 19, with the flat plate simulating the Ascent Stage below.

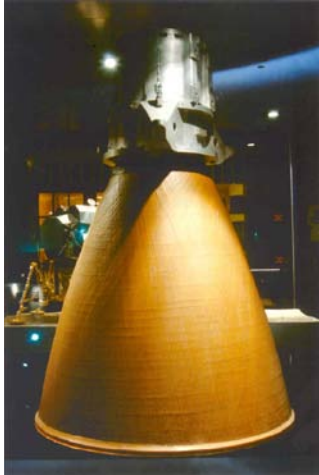

a. Lunar Model Ascent Engine

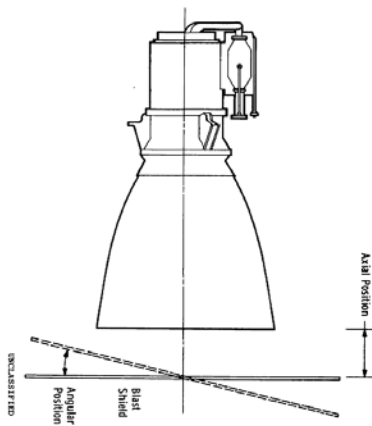

b. Flat Plate in Position Simulating the LM Ascent Stage below

Figure 19. Bell/Rocketdyne Model 8528 / RS-18 Lunar Module Ascent Engine

The LMAE test program primary objectives (Phases I thru IV) included determination of:

1. Engine performance and ablation characteristics of two different all-ablative thrust chamber - nozzle assemblies
2. effect on Engine performance of chamber pressure variations from 100 to 140 psia over a MR range from 1.4 to

2. 1 using an all-metal, water-cooled, thrust chamber- nozzle assembly.

3. Engine performance during a simulated mission duty cycle utilizing the final configuration of the LM Ascent engine thrust-chamber-nozzle assembly.

4. proposed LM Ascent Vehicle staging technique (plume impingement effects on Descent Stage deflector plate).

THE APOLLO/SATURN J-2 ENGINE ENVIRONMENTAL VERIFICATION TEST (EVT) PROGRAM

The J-2 Engine with a complete 'Battleship' version of the Saturn V / S-IVB 3rd Stage, Figure 20, was tested in J-4 Test Cell beginning in 1966. Test preparations were started one year before in July 1965. The J-2 Engine and all propellant lines, vent and purge lines, valves, and avionics were the actual flight systems. Only the Stage had thick walls for safe ground testing.



Figure 20. Douglas S-IVB Stage and Rocketdyne J-2 Engine

Utilizing the S-IVB 'Battleship' Stage, our testing at AEDC supported both the S-II and the

S-IVB Stages as we used parameter set conditions and two engine configuration changes that were specific to S-II Stage operations. We performed short-duration tests (up to 30 sec) – Engine start, orbital coast, and S-IVB restart for Translunar Injection (TLI) burn.

The LO₂/LH₂ S-IVB ‘Battleship’ was installed in the 50 X 120 high Environmental Test chamber and fired into an exhaust diffuser containing a steam-driven ejector extending into the underground 100 ft diameter X 250 ft deep spray chamber, Figure 21.

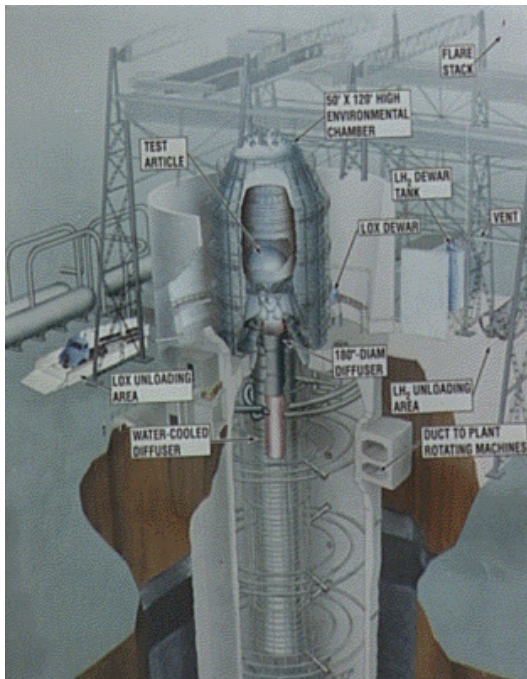

Figure 21. S-IVB ‘Battleship’ Stage Installed in J-4 Test Cell for the J-2 Engine EVT Program

The S-IVB Stage (22 ft diam, 49 ft long) was barged from the Douglas Plant in Sacramento, CA, up the Tennessee River and transported overland by trailer to us for test, arriving in February 1966. AEDC is situated at Tullahoma, Tennessee, close to MSFC in Huntsville in both culture and geographical proximity.

Beginning in the summer of 1965, the author worked on the design, installation, and shakedown of a new 100, 000-gal LH₂ storage and transfer system and Cold GHe/LH₂ heat exchanger system for testing the S-IVB Battleship Stage and J-2 Engine in J-4 Test Cell. I was the LH₂ system test/ installations engineer. The system included an LH₂/GH₂ Steam Heat Exchanger / Pump Vaporizer and a battery of 4,000 psia GH₂ Storage Bottles for the S-IVB LH₂ tank ullage pressurization.

The J-4 Test Chamber Capsule is placed within a blast wall to protect the nearby surrounding buildings (ref. quantity-distance explosive regulations). Two LH₂/Cold GHe helium heat exchangers (HEX) for GHe bottle charging and J-2 Engine Thrust Chamber pre-chill (same as at Launch Complex 39) were placed inside the blast wall.



Figure 22. J-4 Test Chamber Capsule and LH₂/Cold GHe HEX inside the Blast Wall

Installation details in J-4 Test Cell are shown in Figure 23.

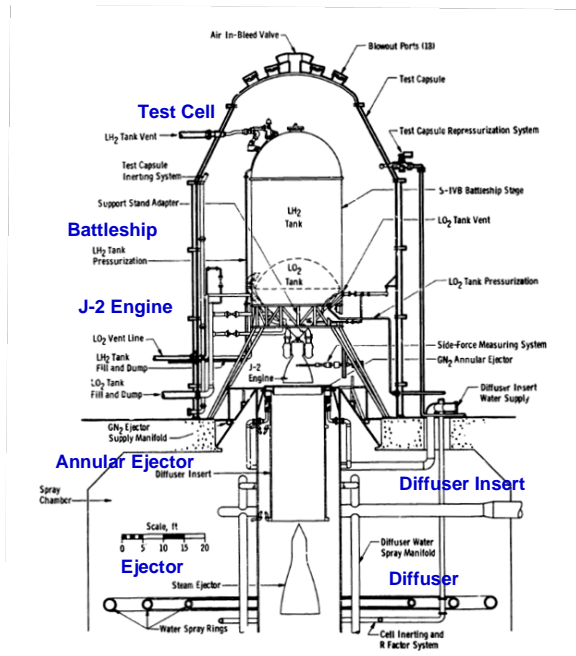

Figure 23. S-IVB 'Battleship' Stage Installation Details in J-4 Test Cell

J-4 Test Cell key design features for exhaust pumping / inerting are as follows for testing LO2/LH2 Engines:

- The J-2 Engine acted as an Ejector with the Diffuser Insert, the Steam Ejector / Diffuser pumped the exhaust flow, maintained the Test Cell altitude, pcell/pexhaust
- At the bottom of underground Spray Chamber – see the Diffuser Exit and Flame Deflector, the flow turns 180 deg, back up through Saturation Water Sprays and LN2 inerting sprays)
- Inert flow discharge (from the top of the Spray Chamber) is exhausted through continuous flow Exhaust Machines to the atmospheric Exhaust Stack, and is maintained as a non-combustible mixture.

AEDC has tested a number of LRPes in J-4 Test Cell – LR 91 (Titan II/III), LR 87 (Titan IIIC), J-2 (Apollo/Saturn), J-2S (Apollo/ Saturn upgrades), RL-10, and TR-201 (all at ~100,000 ft pressure altitude). Among them, the LR 87 and LR 91 and the TR-201 were N2O4/Aerozine 50 storable hypergol engines, the J-2, J-2S, and RL10 LO2/LH2 engines. Hypergol engines require chemical scrubbers or a flare stack for N2O4 on vent lines and water saturation sprays for the exhaust. LO2/LH2 engines require inerting the exhaust gas flow to an inert GN2-GO2-GH2 non-flammable, non-explosive mixture and a hydrogen burn-off flare stack on the GH2 vent line for GH2 purge, vent and drain release to the atmosphere.

Near the end of the decade and up to 1972 as the Lunar Landing missions were taking place, AEDC supported the J-2X (Experimental) Engine Program and tested the J-2S (simplified, tap-off cycle) engine on the Battleship Stage in place of the J-2. The J-2S was fully developed and ready to go into certification for flight

replacement upgrades of the J-2 (higher thrust and simplified) on the S-II and S-IVB Stages when the Apollo Program was cancelled after Apollo 17 (Apollo 18 and 19 cancelled).

The J-2 Engine operated at 230,000 lbf vacuum thrust. The J-2S Engine was updated to operate at any calibrated thrust level between 230,000 and 265,000 lbf and had an idle mode of operation at 5,000 lbf thrust.

J-4 Test Cell key design features for exhaust pumping / inerting included:

- The GN2 Annular Ejector (1st Stage) was both an exhaust pump and added inerting gas and took over pumping at J-2 Engine shutdown.
- The Steam – Driven Ejector (2nd Stage) provided pumping to evacuate the Test Cell and was sized to the Main Diffuser.
- The exhaust flow (H2O + Excess GH2 + GN2 + H2O added steam) exited the diffuser, passed over a deflector, and came back up through liquid water cooling saturation sprays and LN2 inerting sprays condensing out the H2O, resulting in an inert mixture of GN2, GH2, and remaining GO2.
- The inert mixture was pumped out through exhaust ducting to a 300 ft tall Exhaust Stack to atmosphere.

The LO2/LH2 RL 10 Engine, used on the Saturn 1 S-IV Stage, Atlas and Delta Upper stages and on the Centaur Stage and DC-X “Delta Clipper” was tested in two separate entries in J-4 Test Cell.

The storable hypergolic bi-propellant engines tested in J-4 Test Cell included the TRW

TR-201 Engine used on the Delta Upper Stage and the LR 87 Titan II and IIC 1st Stage Engine and LR 91 2nd Stage Engine. The TR-201 Engine was a derivative of the Space Technology Labs Lunar Module Descent Engine (LMDE) of about the same thrust. The LR-87 Engine operating at 430,000 lbf in the Gemini Launch Vehicle (GLV) version when it launched the Gemini Spacecraft, was the largest LRPE tested to date in J-4 Test. The S-IVB ‘Battleship’ was the largest Stage tested in J-4.

The J-2 Engine was operated at 5.5 mixture ratio (MR) and produced about 30 lbf/sec unburned GH2 in the exhaust products. Three banks of saturation water cooling sprays in the 100-ft diam. 250-ft deep spray chamber below condensed out all the steam exhaust leaving free GH2. A steam-driven ejector diffuser provided the primary evacuation of the J-4 Capsule with facility exhausters pumping out the entire capsule and spray chamber through a 1,000+ ft long exhaust duct 13 ft in diam. to a 300-ft tall exhaust stack to atmosphere. That steam was also condensed in the spray chamber saturation sprays. We had a GN2 test cell purge that continuously inerted the Test Capsule for the normal atmospheric in-leakage to the Test Cell.

Hydrogen inerting to below the flammability limits in air was provided by the addition of a GN2-driven annular ejector and diffuser insert at the top of the exhaust diffuser. This added ejector provided some GN2 inerting plus some additional pumping to minimize the blowback into the capsule at engine cutoff.

Then, LN2 inerting sprays in the underground spray chamber provided sufficient mass addition of inert GN2 to reduce the GH2 concentration below the flammability limits everywhere in the entire J-4 Test Cell circuit all

the way out the exhaust stack. The rotating plant exhaust machines are axial flow exhausters and have automatic anti-surge valves that open to keep the machines out of stall. The total inerted gas flow mixture was sized to take care of any normal air in-leakage to the ducting and to keep the surge valves closed. There was additional inerting LN2 storage capacity for the emergency event of a GH2 leak or a GO2 leak inside the capsule to be able to overcome an explosive mixture buildup.

During installation and then testing for the next five years from 1965 to 1970, the author worked in LH2 storage, tanking, fill and drain operations, J-2 Engine thrust chamber cold GHe pre-chill before Engine Start, as the LH2 Start Box NPSH thermal conditioning and pressurization Red Line observer, the J-2 Engine valve sequence / timing data specialist, Engine solar heating simulation heater blanket specialist for thermal soak during orbital coast before restart for Translunar Injection, data analyst for engine performance, and dynamic data specialist for engine and turbopump vibrations and dynamic / unsteady phenomena. There were 21 of us in the Control Room as Red Line observers and operators*. I held a 'pickle button' in my hand and wore a communications head set. I was in the Control Room and took part in 321 engine starts / tests.

We were very much a part of the NASA Saturn team at MSFC. I always held that feeling from the Saturn/Apollo Program through the Space Shuttle and International Space Station Programs. NASA Management made us all feel part of one Government-Industry Team.

* One day before a test Gen. Lief Jack Sverdrup came to our Control Room, came around and thanked us each one personally for what we were doing that day. It was on a Saturday.

For me, the J-2 Engine Program began one Friday afternoon in August 1965 when our Sverdrup Division Chief in the Rocket Test Facility at AEDC called three of us into his office and pointed across the street at J-4 Test Cell. He explained the J-2 Engine EVT Program to us and told us that the facility had to have a modification for LO2/LH2 capability and begin testing within one year. He said, "A team is already working on it and you three have been selected for that team. You will start Monday morning and your desks will be moved tomorrow."

Soon thereafter I went to MSFC for a day as the new LH2 System test installations engineer. I arrived at lunchtime and was quickly ushered out to the Blockhouse and witnessed a full-duration F-1 Engine firing at 1:00 P.M. There were two S-IVB 'Battleship' Stages, the one brought to AEDC from Sacramento and one at MSFC. I was brought along for all of the LH2 purge preparation and propellant loading procedural operations on the Test Stand that day and witnessed the whole countdown operation and a full-duration J-2 Engine firing at 7:00 P.M. that evening.

The J-2 Engine, Figure 24, was delivered to us from Rocketdyne's facility at Canoga Park, CA, on March 6, 1966. We began the J-2 Engine Altitude Environmental Verification Test (EVT) with our first firing July 31, 1966.

The J-2 Engine had completed engine acceptance tests by the manufacturer and had flown three times on AS-201 on February 26, 1966, AS-202, and AS-203. The S-IVB has flown three times successfully. Only once did we have to do a 'pickle button' Engine Observer Cutoff. There were, however, a few automatic sequence 'Red Line' exceedance cutoffs.



Figure 24. J-2 Engine being Hoisted to the J-4 Test Capsule

Test objectives were to evaluate the engine transient operation and performance at simulated altitude under thermal conditions for first burn start, Mainstage, shutdown, for Saturn IB (AS-203) and subsequent, Saturn V (AS-502) S-II 2nd Stage/S-IVB third Stage, and for the S-IVB 3rd Stage orbital coast, and restart (restart for the Translunar Injection [TLI] burn). The TLI burn would take humans for the first time to V_e (escape velocity) from Earth's gravity. The first manned launch to escape velocity occurred on the Apollo 8 (AS-503) flight.

The AS-203 flight (unmanned) had just taken place on July 5, 1966, to evaluate performance of the S-IVB and Instrument Unit Stage under orbital (weightless) conditions and obtain flight information on venting and chill-down systems, fluid dynamics and heat transfer of propellant tanks; attitude and thermal control systems, launch vehicle guidance, and checkout in orbit.

Stage data on the four-orbit AS-203 flight showed that the S-IVB could restart in Space. Our testing began with AS-203 time sequencing for J-2 Engine Start. We did many tests with start sequence timing variations to help confirm the nominals.

J-2 Engine restarts were made at crossover duct and turbine hardware conditions predicted for coast periods of both one and two orbits. Engine starts had been made by February-March 1967 at both S-IB/S-IVB and S-V/S-IVB predicted flight conditions that showed a gas generator (GG) over-temperature condition for the orbital restart with the planned 8-sec fuel lead for TLI. We did J-2 Engine restarts with varied Main Fuel Valve (MFV) opening time, and settled on a confirmation of the planned 8-sec fuel lead for satisfactory thrust chamber orbital pre-chill. Our testing isolated and verified the existence of the orbital restart problem [17a] of excessive GG temperature as caused by the warm turbine hardware condition following the engine first burn. We then did testing to verify that the solutions selected for the AS-501 flight were adequate to achieve successful engine restart in orbit.

The GG temperature overshoot was primarily a function of the Main Oxidizer Valve (MOV) timing. The detrimental transient GG O/F conditioning was brought about the warm Turbine hardware and Cross-over Duct after orbital coast before restart. We accomplished a re-sizing of the MOV closing control orifice to provide a 1650 msec dry sequence ramping time (re-sequencing) as opposed to 1825 msec. This was the lesson learned. An orbital restart transient mixture ratio (O/F) situation in the Gas Generator start sequence, which was very much related to Spin Start Tank discharge and pump spin-up sequence, thrust chamber

ignition, and Main Oxidizer Valve (MOV) opening ramp cycle, could be 'fixed' by re-sequencing the MOV ramp timing.

We did mixture ratio variations (by changing the Propellant Utilization Valve setting) for MR = 4.5, 5.0, and 5.5. The engine rated thrust (225,000 lbf uprated to 230,000 lbf) was at MR = 5.5. There were programmed MR shifts to the mission duty cycle. In one of those MR shift tests at 4 sec after Engine Start, the LO2 Pump Inlet Observer had to do a 'pickle' Observer Cutoff. The test had been planned to start a deliberate low safe NPSH limit for Engine Start, and because of LO2 Tank Pressure control factors, the LO2 Inlet Pressure migrated to below Safe Operating limits soon into Mainstage. So the 'pickle' action was as it was supposed to. I was the Fuel Inlet NPSH Observer, and the LO2 Inlet Observer and I stood side by side right next to each other watching the respective propellant pressures and temperatures each on an 11 X 17 -in. plotter. My LO2 counterpart made that 'pickle cutoff' standing right next to me.

We were well along in the J-2 EVT on January 27, 1967, when tragedy struck the Apollo Program when a flash fire occurred in Command Module 012 during a launch pad test of the Apollo/Saturn space vehicle being prepared for the first piloted flight, the AS-204 mission. This tragedy took the lives of Lt. Col. Virgil I. Grissom, a veteran of Mercury and Gemini missions, Lt. Col. Edward H. White, the astronaut who had performed the first United States EVA during the Gemini program; and Roger B. Chaffee, an astronaut preparing for his first space flight.

The AS-501 first Saturn V flight (Apollo 4) flight occurred the next year on November 9, 1967.

The AS-502 flight (Apollo 6), no crew, was launched April 4, 1968, and was the final qualification mission of the Saturn V launch vehicle and Apollo spacecraft for the manned Apollo missions. There was Pogo on the 1st Stage and an augmented spark igniter fuel line failure and fire on S-II Engine No. 2 causing shutdown of adjacent Engine No. 3. When that engine shut down, its low Pc cutoff signal shut down the engine on fire, and the mission proceeded to orbit with S-II engines out [14-18].

We used an auxiliary start sequence taken from the AS-501 flight sequence:

| Time, sec | Event |
|-----------|--|
| T4 | S-V/S-II Engine Cutoff |
| T4 + 0.2 | Command S-IVB/S-V Prevalves Open |
| T4 + 1.0 | S-V/S-IVB Engine Start (1-sec Fuel Lead) |
| T4 + 1.4 | Shutdown Oxidizer Recirculation Pump |
| T4 + 2.2 | Shutdown Fuel Recirculation Pump |

J-2 Engine restarts were made at crossover duct and turbine hardware conditions predicted for coast periods of both one and two orbits. Engine starts had been made by February-March 1967 at both S-IB/S-IVB and S-V/S-IVB predicted flight conditions that showed a gas generator (GG) over-temperature condition for the orbital restart with the planned 8-sec fuel lead for TLI. Our testing isolated and verified the existence of the orbital restart problem [17a] of excessive GG temperature as caused by the warm turbine hardware condition following the engine first burn. We then did testing to

verify that the solutions selected for AS-501 were adequate to achieve successful engine restart in orbit.

The GG temperature overshoot was primarily a function of the main oxidizer valve (MOV) timing. We accomplished a re-sizing of the MOV closing control orifice to provide a 1650 msec dry sequence ramping time (re-sequencing) as opposed to 1825 msec.

The AS-503 mission (Apollo 8), six day mission launched December 21, 1968, was my biggest mission as our GG over-temperature 'fix' was applied to AS-502 and AS-503 and subsequent. Our J-2 EVT Program testing had already benefitted the AS-501 and AS-502 missions. The S-IVB was restarted twice in the Apollo 9 (AS-504) mission and sent into an Earth-escape trajectory to the Sun.

The test program was accomplished using attribute testing wherein all eligible variables at 'Engine Start' were varied high – low – medium in combinations high – low, high – high, and so on in a controlled manner:

- Turbopump Inlet 'Start Box' corners and mid NPSH, GH2 Start Tank energy level, LH2/Cold GHe HEX thrust chamber pre-chill duration and thrust chamber H2 injection temperature
- Repeat of flight conditions from previous S-IB and S-IC launches, e.g., the unmanned AS-502 flight, April 4, 1968, for both the S-II Stage and the S-IVB start conditions
- Demonstration of Engine Start (1-sec fuel lead), First Burn, Shutdown, Orbital Coast, Restart (8-sec fuel lead)

- Included asymmetric on orbit solar heating simulation on nozzle (small effect).

Figure 25 shows the engine firing into the diffuser. The annular GN2 ejector and centerbody steam – driven ejector are visible in this picture.

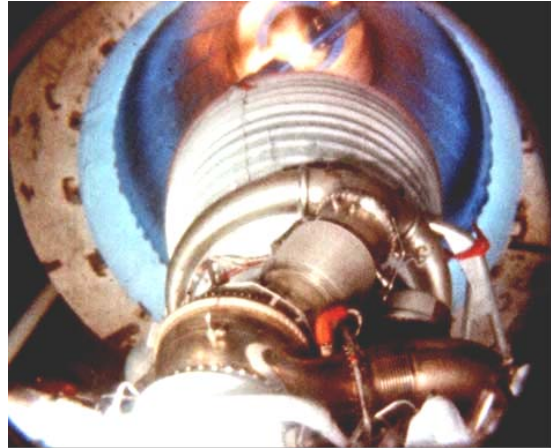

Figure 25. J-2 Engine EVT Firing in J-4 Test Cell

There was also an automatic cutoff due to excessive Vibration Safety Cutoff (VSC) Counts. This occurred at the time of thrust chamber LO2 dome 'prime', as two-phase oxygen flow into the injector dome chilling the dome and injector elements changes suddenly to cryogenic operating temperature and suddenly 'primes' the injector elements to liquid flow. There is a sudden jump in fuel and oxidizer injector pressures, and sudden rise in combustion chamber pressure [17a].

The VSC controller was set to cut the engine if at any time the Engine sustained 150 msec of more duration of vibrations exceeding +/- 150 g as measured by a voting logic of two out of three accelerometers on the LO2 dome seeing that much vibration. Furthermore, the vibration signals were band-passed filtered such that the +/- 150 g's had to be in the frequency range

from 960 to 6,000 Hz, which covered the high-frequency combustion instability range from the 1st longitudinal mode up to and including the 3rd tangential mode of the main combustion chamber. Predominant frequencies recorded in VSC bursts at Engine Start were 340 Hz and 2100 Hz with many other discrete oscillations present also. We added a high-frequency pressure transducer to the LO2 Dome to confirm the magnitude and duration of the 340 Hz oscillations. I was our dynamics specialist monitoring all of the vibration safety data.

Many tests had at least some VSC counts, most of them for well below the time duration cutoff setting, and frequency decomposition revealed a number of organized acoustic oscillations to be present - the 1st tangential mode and several others, not all concentrated in just one mode. The J-2 Engine was flown without stability aids (baffles or acoustic cavities) unlike many other engines in the 1960s that had experienced serious combustion instability and required stability aids to be added.

Most of the altitude simulation tests in the J-2 EVT Program with VSC Counts had cold fuel injection pre-chill temperatures in the 1st burn tests. Restart 2nd burn tests generally had little or no VSC Counts. There is a Hydrogen 'transition temperature' (fuel injection temperature too low, nearing LH2 temperature) where the VSC worsened, above that it was less and nearly inconsequential. The minimum temperature that the Pre-Chill Controller (an added ground system) would allow an Engine Start to proceed was -150 °F. A first burn test, either S-IVB or S-II simulation, with too much Cold He / LH2 Heat Exchanger pre-launch

conditioning was the primary cause for excessive VSC Counts at J-2 Engine Start.

The normally 1-sec fuel lead following thrust chamber pre-chill to below -150 °F for both S-II and S-IVB Engine Start was followed by tests for orbital restart with deliberate temperature conditioning to the high-end limits, as warm as - 70 °F fuel injection temperature. Our ground Pre-chill Controller would do a check for < -150 °F fuel injection temperature and start a timer to extend the fuel lead up to maximum preset time limit before allowing the start sequence to proceed. For an orbital restart, this turned out to be a design set 8 sec fuel lead duration to complete satisfactory fuel injection temperature for Engine Restart after orbital coast.

We added deliberate heating of the thrust chamber and nozzle to simulate asymmetric solar heating (vehicle not rolling and presenting only one side to the Sun). This heating simulation was done with heater blankets applied to one side of the thrust chamber / nozzle. Thrust chamber heating tests proved adequacy of the 8 sec fuel and little consequence of asymmetric solar heating. We were able to remove the heating blankets. I was the thermal engineer assigned to the heating blanket investigation.

The times I served as the Thrust Chamber Pre-chill Observer, I guided operation of the Cold He/ LH2 Heat exchangers to a predetermined fuel injection temperature and then asked for Pre-chill to be terminated, ready for the particular test. I then watched the thrust chamber injector warm up until T0 that it was still in range for the target conditioning temperature. What would become interesting was a case when there was a countdown 'Hold' for any reason that might result in excessive

thrust chamber warming. I would have to ask for another cold He Pre-chill if the thrust chamber got too warm. If it wound up trending high or low, I would be the one asking the Test Conductor for countdown 'Hold' until we did something that made my observed temperature come back into acceptable limits.

The S-II Stage with its five J-2 Engines is shown in Figure 26.



Figure 26. The Saturn V/S-II Stage

The AS-502 shutdown and fire had been caused by a flow-induced bellows resonance rupture in the ASI fuel line. A single-ply, single-braid overlap upper fuel line flex hose was superseded in an ECP for a triple-ply, double-braid overlap configuration, and then a final 'fix' with a new ASI fuel line that eliminated the flex hoses. Ice, frost formation occurred in ground testing from the liquid air in sea level tests, and in our simulated altitude tests also because we did not have a dry condition for test. We helped validate the 'fix' but did not reproduce the problem before the AS-502 flight [17b]. We had accelerometers, thermal data, and high-speed movies in our tests. Later AEDC testing moved from what had been development testing into flight support testing [18] following the AS-503 mission.

The problem in the igniter fuel lines was not detected during ground testing because the stainless steel mesh braid covering the fuel line bellows became saturated with liquid air and ice/frost due to the extreme cold once LH2 was flowing through it at Mainstage. The liquid air damped bellow resonance mode that became evident when flex hose tests were conducted later in a vacuum after the Apollo 6 flight. There was a simple fix, involving replacing the flexible bellows section where the break occurred with a loop of stainless steel pipe. The S-IVB used the same J-2 engine design as the S-II and so it was decided that an igniter line problem had also stopped the third stage from reigniting in Earth orbit. Ground testing confirmed that the slight underperformance seen in the first S-IVB burn was consistent with damage to the igniter line.

The **lessons learned** were two. The first lesson was a less than adequate knowledge and control of flex hoses and bellows in our liquid propulsion systems at the time. NASA MSFC

then took control over the design and operation of all flex hoses and bellows, and performed studies and technology improvement releases of data and guidelines for control, e.g., [28] and [33]. The second lesson was in environmental simulation and testing techniques and that we might have bagged off the LH2 line with the bellows in a shroud (like we had shrouded the GG LO2 supply line) that would have precluded liquid air or LN2 formation on the line, a lesson for doing better local thermal / vacuum conditioning techniques.

At the end of the AEDC testing, the J-2X (Experimental) Program had begun. Near the end of the decade and up to 1972 as the Lunar Landing missions were taking place, AEDC supported the J-2X Engine Program and tested the J-2S (simplified, tap-off cycle) engine on the Battleship Stage in place of the J-2 [19]. The J-2S Engine was fully developed and ready to go into certification for flight replacement upgrades of the J-2 (higher vacuum thrust of 265,000 lbf and simplified) on the S-II and S-IVB Stages when the Apollo Program was cancelled after Apollo 17.

In all our tests of the J-2 and the J-2S Engines in J-4 Test Cell, we kept performance logs for calculated thrust based on measured pressures, temperatures, and flow rates and power balance using Rocketdyne-supplied engine constants, and we corrected calculated thrust and specific impulse to vacuum from the actual measured Test Cell pressure altitude.

The Apollo 8 (AS-503) crew was in Lunar orbit on Christmas Eve and gave a televised transmission back to Earth. Pogo was not evident on the S-II Stage until this AS-503 flight, possibly because of the lack of sufficient instrumentation, and a self-limiting local oscillation appeared at 480 sec into the flight.

Concern was raised over this oscillation by the Pogo Working Group. It was agreed that the next flight would be made safe by raising the LO2 pump inlet pressure (NPSH). AS-504, however, developed a 17 Hz oscillation locally in the S-II thrust frame region of +/- 12 g's. It was decided to shut down the center engine, where the local oscillation was found, 60 sec early and avoid the Pogo problem. The Apollo 10 (AS-505) and Apollo 11 (AS-506) flights had no observed Pogo using the center engine early cutoff.

Apollo 12 (AS-507) was the next flight to experience significant Pogo oscillations. Several bursts of Pogo occurred showing the Pogo loop marginally stable at best. There was a stable limit cycle theory that S-II Pogo would be self-limiting. Then Apollo 13 (AS-508) had the worst Pogo of all starting at 16 Hz between 120 and 160 sec with a center engine low Pc safety cutoff when the center engine vibration was at +/- 34 g's and the Pc was +/- 250 psi. It is believed that nonlinear damping was overridden by nonlinear LO2 pump gain characteristics, where AS-507 had gone into a stable limit cycle. There were only small differences in AS-508 going unstable [23, 27].

In a test series with our Battleship Stage we installed an S-II engine fuel feedline in place of the S-IVB feedline and varied turbopump inlet NPSH in support of the Pogo investigation. We performed engine starts simulating both LO2 and LH2 S-II low-limit NPSH for the center engine. A Pogo suppressor system was fitted to the S-II center engine LO2 feedline for Apollo 14 (AS-509) and the subsequent lunar flights.

During the J-2 Engine Environmental Verification Tests (EVT), issue resolution was supported for the S-II Stage including:

- AS-503 (Apollo 8) – AS-508 (Apollo 13) center engine Pogo instability investigation
 - S-II propellant line substituted and low NPSH tested for the Center Engine simulation
- AS-502 S-II Augmented Spark Igniter fuel line rupture and fire (2 engine shutdown occurrence)
 - Flow-induced bellows resonance failure (redesign 'fix' helped verify by June 5, 1968).

THE LR 87 ENGINE

Aerojet's Titan II LR 87 Engine was tested in J-4 Test Cell. Used as the 1st Stage engine on the Titan II, III, and IV, the LR 87-AJ-5 version was the 1st Stage engine on the Titan Gemini Launch Vehicle (GLV), for NASA's ten manned Gemini/Titan launches in 1965-66. The first flight was in 1962.

The LR 87 Engine is shown in Figure 27. The Martin Gemini Launch Vehicle (GLV) is shown at lift-off in Figure 28. The LR 87 burned hypergolic storable N_2O_4 and Aerozine 50 bi-propellants (50% N_2H_2 /50% UDMH).

The LR 87 Engine (twin thrust chambers) delivered approximately 430,000 lbs thrust.

Later updated for the Titan III and IV, the LR 87-AJ-11 engine version delivered 526,000 lbs thrust.

Turbine exhaust ducts were at the center of the open Titan base. Tests were later

performed in the AEDC 16-Ft Supersonic Propulsion Wind Tunnel with the Titan IIIC and IV solid rocket boosters (SRBs), Figure 29, to evaluate the high-altitude aerodynamic and base flow characteristics.

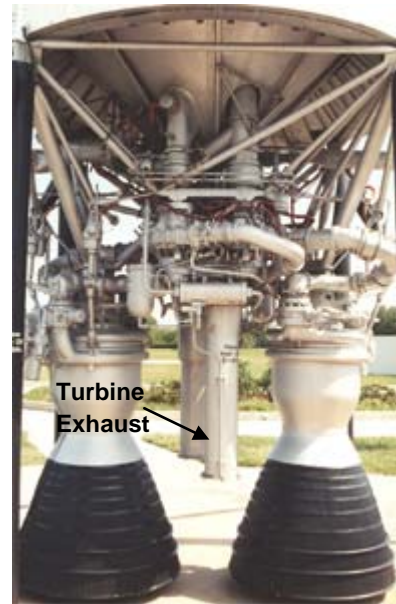

Figure 27. The Aerojet LR 87 Engine



Figure 28. The Martin Titan II Gemini Launch Vehicle

The LR 87 Engine was tested in J-4 Test Cell for its high altitude performance and turbine exhaust disposal characteristics.



Figure 29. The Titan IIIC Launch Vehicle in the AEDC 16-Ft Supersonic Wind Tunnel and Titan IV in the 16-Ft Transonic Wind Tunnel

THE LR 91 ENGINE

The Titan II LR 91-AJ-11 Engine used hypergolic bi-propellants N₂O₄ and Aerozine 50. The LR-91 2nd Stage Engine was tested in J-4 Test Cell to determine its high-altitude start / performance characteristics.

The LR 91 Engine testing utilized the six-component thrust mount and thrust measuring system shown in Figure 30 and developed 100,000 lbf vacuum thrust. It was tested in the early 1960s in the LR 91-AJ-5 Titan II 2nd Stage version that powered the Titan Gemini Launch

Vehicle (GLV). The LR 91-AJ-11 version was first flown in 1968 on the Titan III and 1989 on the Titan IV Launch Vehicles. In 1996, a \$15-million upgrade added new cryogenic and hypergolic propellant system test capabilities. AEDC installed a new hypergolic N₂O₄/Aerozine 50 propellant system which was used to test the Aerojet Titan IV LR-91 engine and added an upgraded cryogenic (LO₂/LH₂) propellant system to test the new Pratt and Whitney RL 10B-2 Engine.

The J-4 Test Cell has been used to test a variety of engines over the years [26] with the most recent being the RL10B-2 and the LR-91(Titan II/III/IV). Others included the LR-87 (Titan IIIC), J-2 (Apollo/Saturn), J-2S (Post-Apollo), RL10 (Delta III/IV, EELV) and TR-201 (Delta). AEDC's J-4 Test Cell is unique in its capability to match altitude pressures during shut down and provide a 'soft shutdown' to minimize stress on the nozzle. AEDC's altitude pumping is maintained during the test run and ramped up during the engine's shutdown event to protect fragile state of the art carbon-carbon rocket engine nozzles.

J-4 has added an extensive suite of state-of-the-art diagnostic instrumentation - diagnostic tools, which include laser fluorescence [28], infrared and ultraviolet imagery, high-speed video, and real-time radiography, to verify engine system performance/structural integrity and characterize plume flow signatures.

J-4 Test Cell is equipped with a temperature-conditioning system designed to maintain the test article at a prescribed temperature from 50 to 110 °F (± 5 °F), storable propellants at 65 °F (± 5 °F). The LR 91-AJ-11 Engine, first flown in 1968 on the Titan III and IV 2nd Stage is shown in Figure 31. It had a fuel

regeneratively-cooled, fuel film cooled thrust chamber and an ablative nozzle extension and was tested in run durations of up to 300 sec.

THE RL 10 ENGINE

Probably the longest-running and most prolific production cycle of LRPEs in the U.S. has been the RL 10 Engine.

Pratt and Whitney began design on the RL-10 Expander Cycle Engine in 1958. The first Engine run was in 1959. The first successful flight, on the General Dynamics Centaur Stage, was November 27, 1963. AEDC was preparing to test the Centaur Stage in 1962, and the author was supporting design of a cryogenic LO₂/LH₂ propellant storage and transfer system for J-3 Test Cell. The first Centaur flight on November 27, 1963 was powered by two RL 10A-3 engines. Our Centaur testing was cancelled.

Beginning with the Atlas II Vehicle, as Upper Stage, the Centaur was capable of delivering payloads to Geosynchronous Orbit (GEO) and to escape velocity from the Earth.

In an expander cycle, the LH₂ fuel is heated before delivery to the combustion chamber with waste heat from the main thrust chamber / nozzle. As the liquid fuel goes through the coolant passages in the walls of the combustion chamber, it undergoes phase change to GH₂ and expands through the turbine using the pressure differential from the supply pressure to the ambient exhaust pressure to drive turbopump rotation at Engine Start.

The RL 10 has been used in a single-engine upper stage configuration (Delta), in both single- and dual- engine arrangements on the Centaur Upper Stage for Atlas and for Titan, in a cluster of four on the McDonnell-Douglas DC-X "Delta Clipper", and in a cluster of six engines on the Douglas Saturn I/S-IV Stage. There were six RL 10A-3 Engines on the Saturn 1/S-IV Stage.

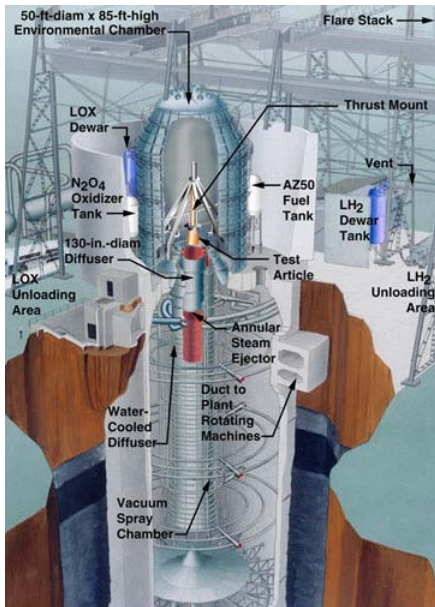

Figure 30. LR 91 Engine in J-4 Test Cell

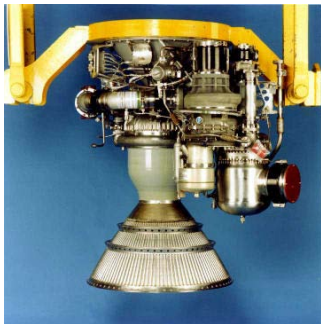

Figure 31. Aerojet LR 91-AJ-11 Engine

The first RL 10A-1 Engine at 15,000 lbf thrust was certified in 1961. The first pair of production RL10 Engines (RL10A-3) flew on the General Dynamics (now Lockheed Martin) Atlas-Centaur II. Each engine provided 16,000 lbf thrust.

The S-IV Stage is shown in Figure 32. The DC-X “Delta Clipper – Experimental” configuration, flight-tested at White Sands Proving Grounds, Figure 33 (photograph courtesy of McDonnell-Douglas), single-stage-to-orbit, vertical takeoff/vertical landing launch Reusable Launch Vehicle (RLV) concept, flew to

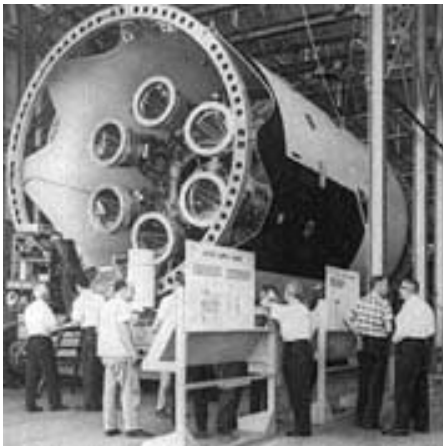

Figure 32. Saturn I/S-IV Stage



Figure 33. McDonnell-Douglas DC-X

an altitude of 3140 m (10,300 ft) for 142 sec flight time. It was flown by Astronaut Pete Conrad using ground-based remote controls. The aeroshell was built by Scaled Composites. The DC-X flew for the first time in August, 1993. On one flight in 1996, a deliberate ‘slow landing’ overheated the aeroshell. The last flight occurred on July 7, 1996. There had been a crack developed in the LO2 Tank, a landing strut failed to extend, the DC-XA fell over and the tank leaked. LO2 from the leaking tank fed a fire which severely burned the DC-XA, completely destroying it. Throttleability and soft landing had been demonstrated but not perfected.

Among the major milestones in the RL 10’s illustrious history of applications were:

Milestones:

| | |
|----------------|--|
| October 1958 | Began design |
| July 1959 | First Engine Run |
| 1961 | First certified |
| September 1962 | Full-scale engine throttle ability demonstrated |
| November 1963 | First Centaur Flight |
| January 1964 | First Saturn flight with six RL-10A-3 engines (Saturn S-I / S-IV Stage) |
| October 1966 | First completely successful restart of a LH2 - fueled rocket engine in Space |
| December 1974 | First operational Titan / Centaur flight |

January 1995 First flight with RL10A4-1 engines

Spring 1998 **First flight with the RL10B-2 engines**

Applications:

RL 10B-2 used on Delta III 2nd Stage and Delta IV 2nd Stage

RL 10A-5 used on the McDonnell Douglas DC-X (throttleable down to 30 %)

RL 10A-4-2 used as an Upper Stage engine on Atlas V

RL 10A-4 used on Centaur Upper Stage of Atlas II, IIA, IIAS, Atlas V

RL 10A-3-3A used on Titan Centaur

The RL 10 has been used on numerous NASA robotic missions. The RL 10 has placed more than 150 Government, military, and commercial payloads in Space. The RL10 has powered Earth-orbital and interplanetary missions to Mercury, Venus, Mars, Saturn, Jupiter, Uranus and Neptune, and the New Horizons mission to Pluto and the Kuiper Belt. Some of its notable missions for NASA include Pioneer, Mariner, Surveyor, Viking, Cassini, and New Horizons. It has also supported placing astronomical observatories and two solar probes. The Aerojet AJ 10 was an upper stage on many of the flights also with such a record.

The first RL 10A-1 Engine at 15,000 lbf thrust was certified in 1961. Pratt and Whitney's RL10A-4 family of engines produce 22,300 lbf thrust and the RL10B-2 engine produces 24,750 lbf thrust and features the world's largest carbon-carbon extendable nozzle.

Two configurations of the Centaur Stage are shown in Figure 34, the dual-engine used on the Atlas II Vehicle, the single-engine on the Atlas V. Two configurations of the RL 10 Engine are shown in Figure 35.



Figure 34. Versions of the Centaur Upper Stage



RL10B-2

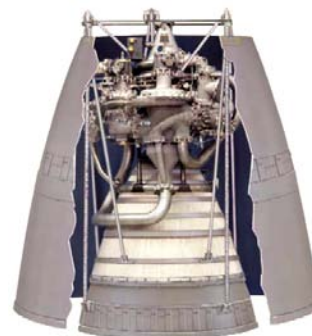

Figure 35. Two Configurations of the RL 10 Engine

There were two test entries of the RL 10 Engine in AEDC's J-4 Test Cell, one in the mid 1970's and the other in 1996-1998. The second entry tested the RL 10B-2 (FS1-10) version with its extendable carbon-carbon nozzle (AR = 285) [29], see Figure 36. Test requirements included 250-sec burn times. Accurate multi-component thrust measurements were required.



Figure 36. The RL 10B-2 Engine in J-4 Test Cell

THE SPACE SHUTTLE

Reference is made here to Space Shuttle testing support at AEDC. This was scale model testing. The author's role was as a user of several AEDC wind tunnels as a representative of Rockwell International. The author, an engineering manager at the time, sent test engineers to AEDC and other facilities for tests.

AEDC's 16-Ft Transonic Propulsion Wind Tunnel was used for forebody aerodynamic force and moment and pressure air load tests, aeroacoustic tests, and a series of hot plume model tests, Figure 37. AEDC's 4-Ft von Karman Facility Supersonic Wind Tunnel A was used for

Solid Rocket Booster (SRB) Staging separation tests, Figure 38.

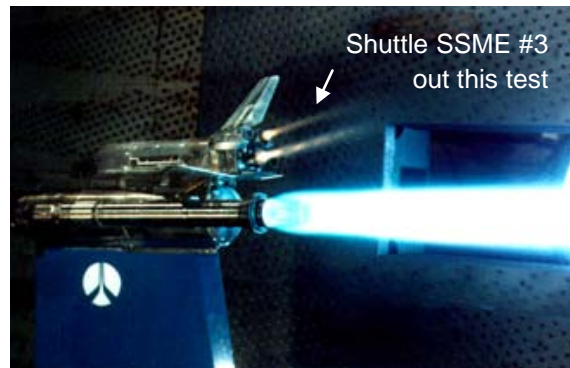

Figure 37. Space Shuttle Aerodynamic/Propulsion Model Tests at AEDC and at NASA/Lewis

The propulsion model tests occurred in the 1988 time-frame during the return-to-flight from the Challenger tragedy. We were doing additional investigations having to with safe

aborts during the ascent phase of powered flight. This test series was conducted in the Calspan 8-FT Transonic Wind Tunnel in Buffalo, New York, and in the NASA/Lewis 10 X 10 - Ft Supersonic Wind Tunnel at Cleveland, Ohio. The author was one of the Rockwell user representatives for Orbiter reentry tests in 1980 in the AEDC von Karman Facility Tunnel B at Mach 8 at attitudes that would be experienced during Trans Atlantic (TAL) abort maneuvers [22]. The engine-out tests pictured in Figure 37 were in support of updated vehicle element certifications for a Return-to-Launch Site (RTL) abort should an engine-out occur early in the boost phase of ascent. There is base recirculation and heating on the Orbiter with an engine out that would affect the other engines and their Thermal Protection System (TPS) insulation.

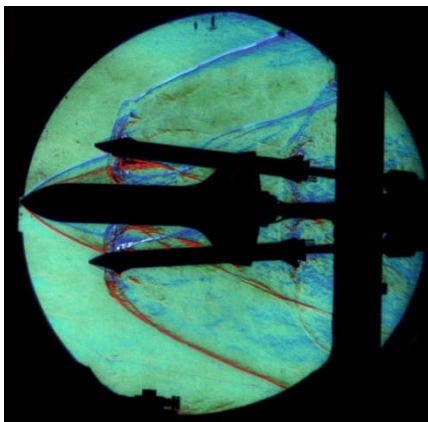

Figure 38. Space Shuttle SRB Staging Tests in AEDC's 4-FT Supersonic Wind Tunnel A

Later, we were able to model the engine-out and the backward-flying Orbiter using computational fluid dynamics (CFD) during an RTL abort (at 135 deg and 180 deg angle of attack) where 4,000 °F exhaust gases would impinge for a brief time on surfaces of the engines, Orbiter, and External Tank (ET) [24-25]. This would be during the Powered Pitch-Around (PPA) maneuver where the Orbiter and ET would be at approximately 400,000 ft altitude in a 'heads down' attitude above the Atlantic Ocean heading towards Europe and would translate to the vertical with the SSME thrust vector downward working against gravity. Completing a full 180-deg maneuver while descending to about 200,000 ft altitude, the Orbiter would continue its burn in a 'heads up' attitude heading back towards the Florida coast until propellants in the ET have been depleted and it is safe to jettison the ET. Then the Orbiter would then perform a Gliding Return to Launch Site (GRTL) and land at the Shuttle Landing Facility at Kennedy Space Center for an Intact Abort.

Our Shuttle testing at AEDC was mainly in the induced environments area with model tests. The SSMEs were tested in full scale mainly at NASA's Stennis Space Center in Mississippi and the Orbital Maneuver System (OMS) Engines and Primary Reaction Control System (PRCS) thrusters were tested at NASA's White Sands Test Facility (WSTF) in Las Cruces, New Mexico.

OTHER TEST FACILITIES

NASA's WSTF was constructed in 1962. The Apollo SPS Engine, LM Descent Engine, and LM Ascent Engine were also tested there in 1964-1970. Special sampling and analysis of LM

Descent Engine exhaust gas identified possible gas contaminants in the Lunar rocks. The WSTF also supported NASA/MSFC's Apollo – SKYLAB and DC-X Programs with propellant system work.

Six test stands at WSTF provide vacuum test capability:

- Engines and engine systems up to 25,000 lbf thrust
- Altitude greater than 100,000 ft with chemical steam ejectors during engine firings; up to 250,000 ft using vacuum pumps without firing
- Hypergolic and LO₂/LH₂ and LCH₄ propellants available.
- Large Altitude Simulation System (LASS) consisting of 3-Module Steam Plant powering sets of 2-stage LO₂/isopropyl alcohol Chemical Steam Ejectors for the altitude chambers.

The Pratt and Whitney Rocketdyne RS-18 Engine (last used on Apollo 17 in 1972) shown here is being tested in a WSTF Altitude Test Cell with LO₂ and LCH₄ propellants.

WSTF did propulsion systems development and qualification testing on the SPS and LM Descent and Ascent Propulsion Systems.

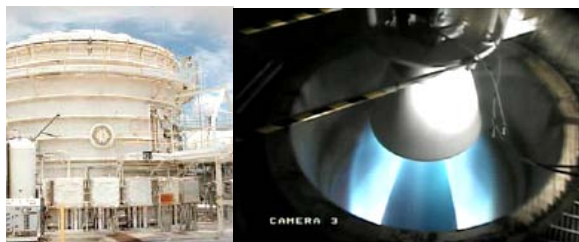

Figure 39. WSTF Altitude Test Stand and RS-18 Engine Firing with LO₂/LCH₄

NASA's B-2 Facility at Plumbrook Station, Sandusky, Ohio, provides altitude simulation and has been used to test engines and engine systems/Upper Stages with up to a 400,000 lbf thrust capability at over 100,000 ft pressure altitude using staged steam ejectors.

Among the Upper Stages tested at Plumbrook Station are the Centaur Stage and the Upper Stage for the Delta III Vehicle, both of which use the RL 10 Engine. The Delta III Stage is shown being lowered into the B-2 Facility in Figure 40.



Figure 40. Delta III Upper Stage in the Plumbrook B-2 Facility

The Pratt and Whitney Rocketdyne Common Extensible Cryogenic Engine (CECE) of the RL 10 family is shown being tested at the P&W E-6 Facility in West Palm Beach in Figure 41. Of all the many major accomplishments in the Apollo Program, the astronauts heralded the TRW LM Descent Engine's deep throttle ability (10:1), enabling very precise thrust and flow rate/mixture ratio (MR) control as being among the most significant enabling the 'soft landings' made on the Moon [20]. The CECE

testing has been demonstrating smooth and stable operation exceeding the 10:1 requirement. At low thrust, the expansion is so great in the nozzle that water crystals are forming at the nozzle lip from the H₂O product of combustion.

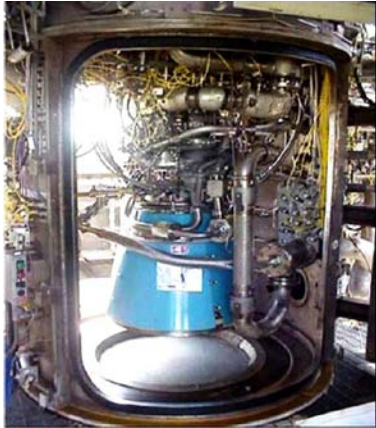

Figure 41. CECE Deep Throttling Engine being Tested in PWR's E-6 Facility

The Rocketdyne (now Pratt and Whitney Rocketdyne) Space Shuttle Main Engine (SSME) was tested at what was North American Rocketdyne Division's A-3 Test Stand at Santa Susanna, California. Components and full engine systems tests took place at the Santa Susanna facilities and at NASA's Stennis Space Center (SSC) A-1 and A-2 Test Stands and E - Complex Component Test Facility. An SSME firing at Santa Susanna A-3 Test Stand and an

SSME firing at the SSC Test Stand A-2 are shown in Figures 42 and 43.

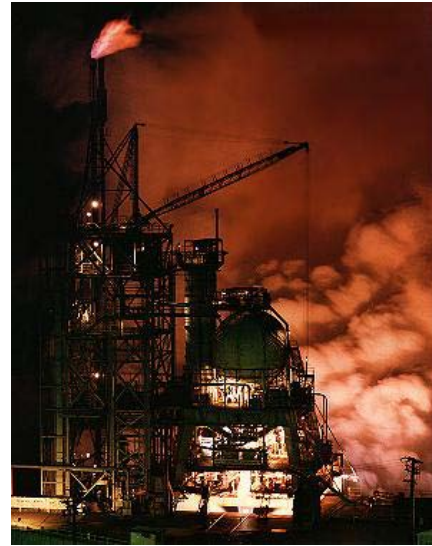

Figure 42. SSME Night Firing at Santa Susanna A-3 Test Stand



Figure 43. SSME Firing at the Stennis Test Stand A2

Sverdrup (now Jacobs) was the designer of test facilities at Stennis Space Center and at AEDC and then on-site contract operator. Test Stand A-2 was fitted with an "Altitude Diffuser" for the SSME while Test Stand A-1 fired into the flame deflector directly to atmosphere. The ejector-pumping action of the SSME in Test Stand A-2 assured that the nozzle flowed full. The diffuser could simulate altitudes of 54,000 to 70,000 ft. The ejector-diffuser concept [4] has seen wide use in LRPE test facilities design.

The SSME, shown in Figure 44 during a test in Test Stand A-1, has variable power settings (for varied thrust). These are 100 % Rated Power Level (RPL), 104 % Normal Power Level (NPL), 109 % Full Power Level (FPL), and 67 % Minimum Power Level (MPL), and there is 3g-limit throttle-back late in the burn. The Stennis Test Stands A-1 and A-2 and B-1 have been used for development and acceptance testing of all SSMEs before installation on the Shuttle Orbiters. SSME acceptance testing has been done in Test Stand A-2.

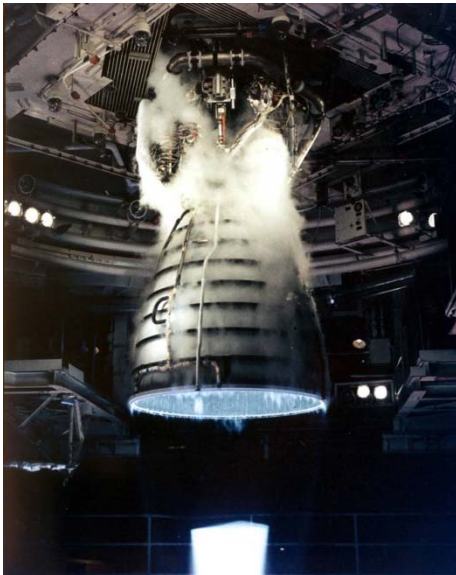

Figure 44. SSME Firing in SSC Test Stand A-1 at 104 % NPL

The Stennis Test Stands A-1, A-2, and B-1/B-2 were built in the late 1960s. The F-1 Engine and S-IC Stage were tested at Marshall Space Flight Center (MSFC) in the early 1960s, and the Saturn S-IC Stage was then acceptance tested in B-2 in 1967-1970 and the S-II Stage was tested in A-1 and A-2 in the same time frame at Stennis Space Center. The F-1 Engine was tested at the Edwards AFB 2-A Test Stand in the early 1960s. SSME testing began in Test Stand A-1 in 1975 and in A-2 in 1976 and occurred also in the 2-A Test Stand at Edwards AFB. The

Pratt and Whitney Rocketdyne RS-68 and RS-68A Upgrade Engine used on Boeing's Evolved Expendable Launch Vehicle (EELV) Delta IV Common Booster Core were tested at Stennis Test Stand B-1. Test Stand A-1 has a 1.7 Mlbf dynamic thrust capability, A-2 has 1.1 Mlbf capability, and B-1/B-2 supports an 11 Mlbf thrust capability.

The RD-180 Engine on the Lockheed-Martin EELV Atlas V 1st Stage was tested in Khimki, Russia, and completed a systems-level test at MSFC in 1998 and its acceptance and qualification tests for the Atlas V in 2002.

AEDC's large-thrust LRPE testing capability available in J-4 Test Cell up to 1.5 Mlbf dynamic has yet to be utilized. The planning to accommodate Booster-class LRPEs of up to an envisioned 800,000 lbf thrust requirement, however, is being done at AEDC in anticipation of needs for the future.

Other test facilities for LRPEs have included flight test beds and advanced flight test articles, e.g., the McDonnell-Douglas DC-X Vehicle flight-tested at White Sands Proving Grounds in New Mexico, Figure 45, and the Lockheed SR71 aircraft at NASA's Dryden Flight Research Center (DFRC) at Edwards AFB, Figure 46. The DC-X, with its four RL 10 Engines, and the X-33 Reusable Launch Vehicle (RLV) concepts were analyzed by MSFC's Fluid Dynamics Branch** using CFD simulations at different points of its flight trajectory. The Rocketdyne XRS-2200 Linear Aerospike Engine was tested in Test Stand A-1 at SSC and was planned to be used on

**MSFC's Propulsion Department Fluid Dynamics and Thermal and Combustion Devices Branches, where the author now works on Jacobs' Engineering Science and Technology Support (ESTS) contract did these and numerous other CFD simulations.

Lockheed-Martin's X-33 Vehicle. The XRS-2200 Engine utilized the updated turbomachinery that had been developed in the J-2S Engine Program and array of 10 thrusters on each side of the aerospike ramp in the single-engine configuration. The dual-engine configuration had two single engines side-by-side for a total of 20 thrust chambers (thrust modules) on both sides of two ramps.

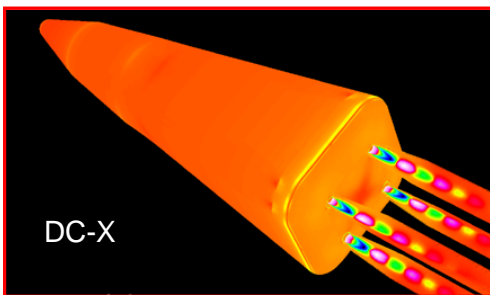

Figure 45. "Delta Clipper" DC-X in Flight Test at White Sands, CFD by MSFC

The XRS-2200 single-engine developed 207,000 lbf thrust at sea level and the dual-engine configuration was designed to produce approximately 410,000 lbf. A model aerospike engine was installed on a NASA SR71 high-

altitude aircraft for flight testing at altitude. It consisted of four thrust modules per side and was designed for 7,000 lbf thrust. There were ground run-up tests of the model engine in the Linear Aerospike SR71 Experiment (LASRE) in 1997 and there were gaseous propellant flow blow-down mode tests from pressurized tanks in flight at varied flight altitudes and speeds.

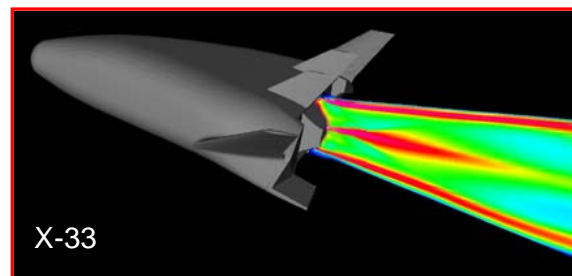
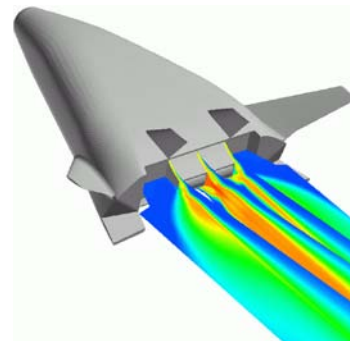

Figure 46. X-33 Linear Aerospike Engine and LASRE

LASRE was cancelled abruptly without completing the actual engine flight tests. Enough aerodynamic data had been gathered to help verify the aerodynamic validity in the CFD predictions that were made. A dual-engine firing at Stennis' Test Stand A-1 is shown in Figure 47.

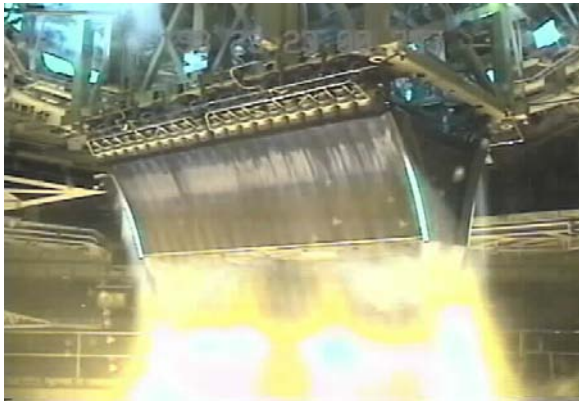

Figure 47. The XRS-2200 Linear Aerospike Dual-Engine in SSC Test Stand A-1 (2001)

The XRS-2200 Engine was predicted to produce 266,000 lbf thrust at altitude (single engine). The RS-2200 Engine (halted in 2001) derived from the XRS-2200 (Experimental) was designed to have seven RS-2200 Engines to produce 542,000 lbf thrust each to boost the single-stage-to-orbit (SSTO) Lockheed Venture Star Reusable Launch Vehicle (RLV).

The aerospike engine, which had its beginnings under Sam Iacobellis, Vice President, Rocketdyne, in the 1960s has yet to receive full systems-level test verification of its altitude-compensating features.

NASA MSFC has received and analyzed all of the data from the ground tests and flights of the Saturn and the Space Shuttle Vehicles as well as the XRS-2200 and numerous R&D LRPEs. MSFC has also done numerous fluid dynamic, thermal, structural, and performance simulations and analyses for the SSME as well.

THE FUTURE

It is hard to say. NASA continues both on-going and new Commercial Orbital Transportation Services (COTS) and Commercial Crew and Cargo Program Office (C3PO) as a lead investor and customer of transportation services by privately owned and operated space transportation systems to LEO.

The future includes planned testing of the J-2X Engine, the AJ 10-118K Upper Stage Engine, Upper Stages with RL 10 Engines, see, e.g., [30], future engines / stages, including new heavy lift LRPEs (.....)?, new NASA Commercial Orbital Transportation Services (COTS) systems to LEO, various new NASA and USAF cooperation ventures in Space and continued use our national resource facilities to test new systems for exploration to enable

$$V_e = R_0 \sqrt{2g_0 / (R_0 + h)}$$

Here R_0 is the radius of the Earth, h is the orbit height of the Spacecraft above Earth's sea level, and g_0 is Earth's gravitational constant at sea level, V_e is escape velocity (11.12 km/sec, or 25,000 mph, from the Earth's surface and ~ 10.9 km/sec from LEO). The escape velocity from the Sun at the Earth/Moon location (to escape the Solar System) is 42.1 km/sec.

NASA and the USAF are both engaged in research and development for a new heavy-lift 1st Stage LO₂/hydrocarbon LRPE capability. NASA is a user of the Evolved Expendable Launch Vehicles (EELVs) for satellites and robotic payloads being sent throughout the Solar System. NASA MSFC, partnered with the Glenn Research Center (GRC), is engaged in new propulsion and cryogenic advanced development (PCAD) efforts for missions beyond Earth orbit and cislunar Space.

NASA is well along at Stennis Space Center (SSC) in construction of the new Test Stand A-3, Figure 48, to test the J-2X Engine. Pratt and Whitney Rocketdyne's J-2X Upper Stage Engine (USE) is derived from the heritage of the J-2 and J-2S Engines and benefits greatly from the development work that was done on the XRS-2200 Engine. J-2X Engine run durations of 442 sec first burn to LEO and an orbital restart for another 442-sec burn are part of the planning

the ejector pumping action of the J-2X Engine will provide pressure altitude simulation at up to 100,000 ft during the engine operating times.

Nine water, isopropyl alcohol (IPA) and liquid oxygen (LO2) tanks have been delivered and installed, with five more water tanks scheduled for delivery. The two IPA tanks shown on the left and the three LO2 tanks shown on the right are 35,000 gallons each. The four water tanks in the center are 39,000 gallons each. All 14 of the tanks will be used by the chemical steam generator units that will be installed on the A-3 stand for creating simulated altitudes of up to 100,000 feet. The IPA and LO2 tanks will fuel the generators; the other tanks will provide the water needed to generate the steam necessary for creating the simulated altitudes.[^] The tanks are 65 to 85 feet tall. Test Stand A-3 is due to be completed and brought on line in 2011. The driving exhauster flow will be 5,000 lbm/sec.

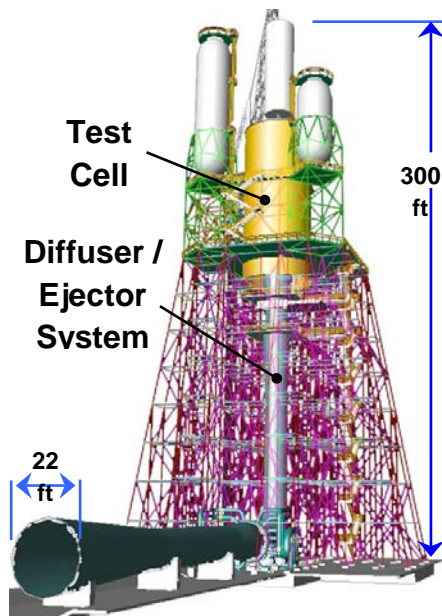

The A-3 Altitude Test Chamber as planned (J-2X Engine shown installed) and the J-2 Engine detail with its very large AR = 92 nozzle are shown in Figure 49. The J-2X Engine with its 120-in. nozzle extension exit diameter is designed to deliver 294,000 lbf or more vacuum thrust.



Figure 48. Test Stand A-3 under Construction at SSC

that has set requirements for Test Stand A-3. A two-stage chemical ejector in the diffuser-ejector system exhausting to atmosphere plus

The J-2X Engine development, qualification, and acceptance testing is planned to be accomplished in SSC Test Stand A-1 (sea level testing without the nozzle extension), Test Stand A-2 (with a portion of the nozzle extension to be able to test the nozzle extension's film cooling concept), and Test Stand A-3 (to perform complete engine systems testing with the full nozzle extension). Critical aspects of testing in the new A-3 Altitude Chamber operation will be the handling of the large exhaust mass flow for the full run durations and minimizing the "blowback" from

[^] Jacobs Engineering is the test facilities designer for Stennis Space Center's new Test Stand A-3.

the diffuser at J-2X Engine shutdown so as not overload the fragile nozzle extension.

The steam ejector-diffuser system provides two important functions. Before rocket engine ignition, the two-stage steam ejector-diffuser system operates alone to establish the altitude test cell pressure.

Jacobs Engineering (Facility designer)

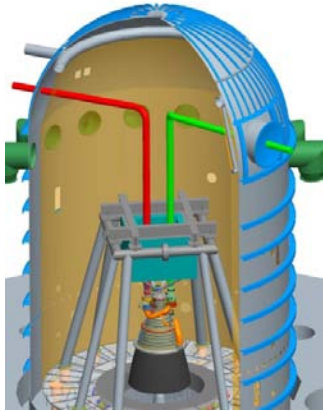

Figure 9. J-2X Engine to be installed in SSC Test Stand A3

After rocket engine ignition, test cell pumping responsibility is transferred to the rocket engine ejector-diffuser action allowing one or both steam ejector(s) to be "throttled back." Upon engine shutdown, the process is reversed, and a transition in the pumping and

pressure recovery responsibility is handed back to the steam ejector-diffuser system alone.

Operating in this manner, the tandem engine ejector-diffuser system performs like a quick response pneumatic check valve that minimizes the test cell pressure transients during engine ignition and shutdown. The steam ejectors isolate the test cell from the exhaust cooling sprays in the diffuser and allow a controlled pressure equalization process between the test chamber (capsule) and the diffuser discharge pressure exhausting to atmosphere.

Jacobs' operating experience includes that of being NASA's engineering support contractor at NASA's Johnson Space Center (JSC) in Houston, White Sands Test Facility (WSTF) in Las Cruces, as well as at Stennis Space Center (SSC) in Mississippi and MSFC in Huntsville. The Jacobs – Aerospace Testing Alliance (ATA) experience gained at AEDC, particularly in testing the RL 10B-2 Engine, benefitted the design and operations approach used for Test Stand A-3.

Lockheed-Martin's Orion spacecraft is shown in Figure 50. The plans are for its propulsion system and RCS thrusters to be tested in the altitude test cells at WSTF.

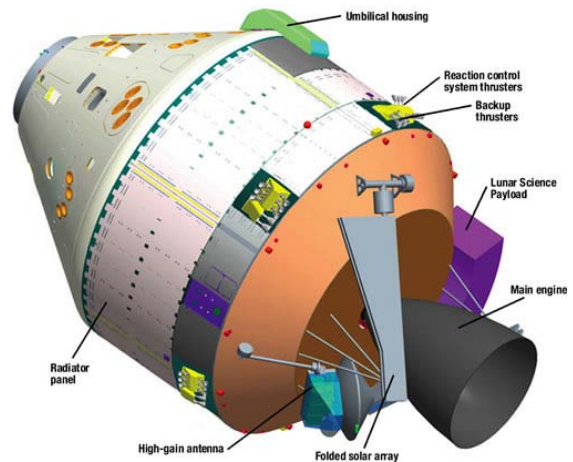

Figure 50. Lockheed-Martin Orion Spacecraft

The Service Propulsion System (SPS) Main Engine for the Orion is planned to be the new and improved Delta Upper Stage derivative of the Aerojet AJ 10 Engine that was the Apollo SPS Engine, the AJ 10-118K version.

AEDC with its demonstrated capabilities to test large LRPEs in the boost phase of flight in the atmosphere and capabilities for systems-level Upper Stage tests (in-space propulsion systems and whole Stages) is an important national resource now and for the future.

To quote Col. Michael Heil USAF, [2], *“AEDC is planning future upgrades to AEDC’s rocket propulsion facilities to accommodate the anticipated requirements for out-year DoD, NASA, and Commercial programs such as the Evolved Expendable Launch Vehicle (EELV), Reusable Launch Vehicle (RLV), validation of component performance, and upgrades to existing space lift and strategic launchers.*

Upper stage engines in the small, medium, and heavy lift categories are being evaluated for technology improvements or new applications requiring altitude qualification. These engines use cryogenic, hypergolic, or tri-propellants to optimize performance for the specific application. Examples of technology insertion are new exhaust nozzles, control systems, and materials to improve altitude operational and economic performance. While existing propellant support systems are in place to test typical upper stage cryogenic and hypergolic propellant engines, new propellant delivery systems are in planning to support the heavy lift engine requirements. These engines are estimated to be in the 200,000- to 800,000- lbf thrust category.

Out-year plans for supporting these test requirements include additions of large engine cryogenic propellant systems, upgrades of the data acquisition system, increased integration of plume phenomenology instrumentation, and automation and optimization of consumable systems to improve system reliability and

performance. AEDC is planning other modifications including systems to support complete upper stage mission duty cycle testing. This includes provisions for mounting complete stage structures, engine gimbaling, stage propellant delivery control and instrumentation systems, thermal conditioning, as well as loading, venting, and detanking systems. All of these modifications are planned to maintain AEDC’s position as the simulated-altitude test center of choice.”

CONCLUDING REMARKS

AEDC’s liquid rocket test facilities have played a major role in the United States’ history of human spaceflight (Earth orbit and Lunar), some parts of which has been recounted specifically in this lecture, and in NASA’s robotic missions to the Moon and Planets. Regarding the future, reference is made to USAF Col. Michael Heil’s paper referenced here.

Focus in this paper has been on Liquid Rocket Propellant Engines (LRPEs); there is a solid rocket motor history at AEDC as well.

The USAF has been a strong partner to NASA in DDT&E since before 1958 and remains so today in the Nation’s go-forward technology pursuits and ground ‘test before flight’ of components and systems in simulated altitude flight environments.

Situated close to NASA’s Marshall Space Flight Center not only by culture but by geographic proximity and access at Tullahoma, Tennessee, AEDC remains a major asset in the U.S. National Rocket Propulsion Test Alliance (NRPTA). Many test techniques and practices used throughout the U.S. were developed at / for AEDC.

BIBLIOGRAPHY

1. "American Institute of Aeronautics and Astronautics Historic Aerospace Site, Arnold Engineering Development Center, Arnold Air Force Base," AIAA 07-0419, 2007.
2. Heil, Col. Michael, "Rocket Testing at AEDC," <http://www.nimr.org/systems/rockets/72-001.htm#Foreword>.
3. Huber, Col. A. F., USAF, "Supporting Space Testing," Military Space and Missile Forum, Volume 2, Issue 6, November/December, 2009.
4. Barton, D.L, and Taylor, D., "An Investigation of Ejectors without Induced Flow – Phase I," AEDC-TN-59-145, December 1959; Crosswy, F.L, and Kalb, H.T., "Investigation of Dynamic Rocket Thrust Measurement Techniques," AEDC-TR-67-202, November 1967.
5. Goethert, B.H., and Barnes, L.T., "Some Studies of the Flow Pattern at the Base of Missiles with Rocket Jets," AEDC-TR-12, June 1960.
6. Goethert, B.H., "Base Flow Characteristics of Missiles with Cluster Rocket Exhausts," IAS Paper No. 60-89, June, 1960.
7. Parker, J.R., and Gillard, T.J., "An Investigation of Base Heating with a 5.47-Percent Saturn SA-1 Booster Model at Mach Numbers 0.8 and 1.15," AEDC-TN-61-134, November 1961.
8. Matz, R.J., and Little, D.W., "Experimental Investigation of the Influence of Altitude and Nozzle Geometry on the Base Flow Characteristics of a Four-Nozzle Cold-Flow Rocket Model," Sverdrup/ARO Project 8953, December, 1961.
9. Matkins, E.H., and Farrow, K.L., "Summary of the Altitude Development Testing of the Bell Model 8258 Rocket Engine (LEM Ascent Stage Primary Propulsion System) in the Propulsion Engine Test Cell [J-2A]," AEDC-TR-65-97, June 1965.
10. Robinson, C.E., and Runyan, "Thrust Vector Determination for the Apollo Service Propulsion Engine using a Six-Component Force Balance," AEDC-65-250, December 1965.
11. Schulz, G.H., and Deford, J.F., "Simulated Altitude Testing of the Apollo Service Module Propulsion System, Report II, Phase II Development Test," AEDC-TR-67-17, February 1966.
12. Farrow, K.L, German, J.A., and Gernstein, T.M., "Operating Characteristics of the Apollo LM Descent Engine with Helium Ingestion and Propellant Depletion in a Simulated Space Environment," AEDC-TR-67-193, November, 1967.
13. Schulz, G.H., Berg, A.L., and Robinson, C.E., "Apollo Block II SPS Engine (AJ10-137) Environmental Tests and Mod C Bipropellant Valve Qualification Tests (Phase VI, Part 2)," AEDC-TR-68-178, October 1968.
14. "Saturn V Launch Vehicle Flight Evaluation Report – AS-502 Apollo 6 Mission," NASA MPR-SAT-FE-68-3, June 25, 1968."
15. "The Apollo Spacecraft – A Chronology," NASA SP-4009, 1963, 1973, 1978.

16. "J-2 Engine AS-502 (Apollo 6) Flight Report S-II and S-IVB Stages," Rocketdyne Report R-7450-2, Volumes 2 and 3, June 17, 1968, Volume 4, September 13, 1968.
17. Collier, M.R., and Dougherty, N.S.; Dougherty, N.S., and Rafferty, C.A., "Altitude Developmental Testing of the J-2 Rocket Engine in Propulsion Engine Test Cell [J-4]," AEDC-TR-67-145, October 1967, and AEDC-TR-68-266, February 1969.
18. Counts, H.J., "Flight Support Testing of the J-2 Rocket Engine in Propulsion Altitude Test Cell [J-4]," AEDC-TR-68-272, January, 1969.
19. Vetter, N.R., "Altitude Developmental Testing of the J-2S Rocket Engine in Propulsion Altitude Test Cell [J-4]," AEDC-TR-69-44, February 1969.
20. Harvey, D.W., "Throttling Venturi Valves for Liquid Rocket Engines," AIAA-70-703, June 1970.
21. Mullen, C.R., Bender, R.L., Bevill, R.L., Reardon, J., and Hartley, L., "Saturn Base Heating Handbook," The Boeing Co., NASA CR-61390, May 1972.
22. Ticatch, L.A., and Nutt, K.W., "NASA/Rockwell International Space Shuttle Orbiter Abort Heating Test (OH-111)," AEDC-TSR-V36, November 1981.
23. Ryan, R.S., "Problems Envisioned and Experienced for Dynamical Physical Systems," NASA TP 2508, August 1985.
24. Dougherty, N.S., and Liu, B.L., "Navier-Stokes Computations with Finite-Rate Chemistry for LO₂/LH₂ Rocket Engine Plume Flow Studies," AIAA-91-0246, January, 1991.
25. Dougherty, N. S., Holt, J. B., Liu, B. L., and S. L. Johnson, "Computational Fluid Dynamics Analysis of Space Shuttle Main Engine Multiple Plume Flows at High-Altitude Flight Conditions," presented at the NASA 10th CFD Applications in Rocket Propulsion, Part 2, Goddard Space Flight Center, pp. 923-943, July 1992.
26. Tucker, E.K., Dehoff, B.S., and McAmis, R.W., "Liquid-Propellant Rocket Engine Testing and Analysis Capabilities (AEDC)," AIAA, SAE, ASME, and ASEE, Joint Propulsion Conference and Exhibit, 29th, Monterey, CA, June 28-30, 1993.
27. Ryan, R.S., "A History of Aerospace Problems, Their Solutions, Their Lessons," NASA TP 3653, September 1996.
28. Brasier, C.W., Drakes, J.A., Anspach, K.M., Porter, R.G., Simmons, M.A., and Pruitt, D.W., "Laser-Induced Fluorescence Measurements of OMS and LR 91 Amine Rocket Exhausts," AIAA-97-2378, June 1997.
29. Pichon, T., Lacombe, A., Joyez, P., Ellis, R., Humbert, S., and Payne, M., "RL10B-2 – Nozzle Extension Improvements for Delta IV," AIAA-2001-3549, July, 2001.
30. Wilkins, M. "Upper Stage Evolution," United Launch Alliance, AIAA Joint Propulsion Conference and Exhibit, Denver, CO, August 3, 2009.