

# Updated Heliostorm Warning Mission: Enhancements Based on New Technology

Roy M. Young,  
NASA Marshall Space Flight Center, Huntsville, AL 35812  
[roy.young@nasa.gov](mailto:roy.young@nasa.gov)

## Abstract

The Heliostorm (also referred to as Geostorm) mission has been regarded as the best choice for the first application of solar sail technology. The objective of Heliostorm is to obtain data from an orbit station slightly displaced from the ecliptic at or nearer to the Sun than 0.98 AU, which places it twice as close to the sun as Earth's natural L1 point at 0.993 AU. Heliostorm has been the subject of several mission studies over the past decade, with the most complete study conducted in 1999 in conjunction with a proposed New Millennium Program (NMP) Space Technology 5 (ST-5) flight opportunity. Recently, over a two and one-half year period dating from 2002 through 2005, NASA's In-Space Propulsion Technology Program (ISTP) matured solar sail technology from laboratory components to fully integrated systems, demonstrated in as relevant a space environment as could feasibly be simulated on the ground. Work under this program has yielded promising results for enhanced Heliostorm mission performance. This paper will present the preliminary results of an updated Heliostorm mission design study including the enhancements incorporated during the design, development, analysis and testing of the system ground demonstrator.

## 1.0 Introduction

The space between the sun and the planets is filled with particles and fields that are constantly changing. Driven by solar events and modulated by planetary magnetic fields, this changing "space weather" affects humans and our technological systems. The Heliostorm mission will measure the solar wind and heliosphere state "upstream" of the Earth and Moon. NASA's Heliophysics Roadmap<sup>1</sup> identified Heliostorm as the most likely first mission that could utilize a solar sail. The concept for the Heliostorm mission originated in the summer of 1996 after NOAA asked the Jet Propulsion Laboratory (JPL) whether an improvement in the warning time available from a satellite positioned at L1 could be achieved through the application of emerging new technologies in solar sails, inflatable structures, and microspacecraft. The results of the ensuing 1996 JPL study<sup>2,3</sup> showed a viable mission/satellite system concept to provide the desired improvement in storm warning time. Subsequent updates to the work<sup>4,5</sup>, carried the original 1996 work several important steps further, adding detail to the design of both the sailcraft bus and sail and refining the sailcraft performance estimates to a more achievable factor of two increase in warning time while at the same time validating the original Geostorm system concept and its estimated costs. This latter work was sponsored by NASA's New Millennium Program (NMP) as part of a competition for NASA's FY '00 Space Technology 5 (ST-5) technology flight validation opportunity, leading to a formal project proposal presented to NASA Headquarters by JPL in the summer of 1999 for a project known as the Sub-L1 Sail Project. Unfortunately, the ST-5 Solar Sail proposal was not selected, however key concepts from the ST-5 proposal were incorporated by L'Garde into a winning proposal to the In-Space Propulsion Technology (ISPT) Program's Research Opportunities in Space Science (ROSS) NASA Research Announcements (NRA) announcement in 2002.

## 2.0 ST-5 Mission Concept

The 1999 NMP ST-5 proposal utilized an inflatable UV-rigidized boom and a sailcraft and sailcraft bus concept developed by Ball Aerospace Corp., Boulder, CO, in conjunction with JPL. The overall sailcraft system could achieve beginning-of-life and end-of-life sailcraft loadings of 42 and 36 g/m<sup>2</sup>,

respectively, sufficient to achieve an operational station location between 0.984 and 0.983 AU. The sail design utilized UV-rigidized, inflatable Kevlar booms with a 4.5-mil-wall-thickness, a 0.33-mil (8-micron) thick Kapton sail membrane, and a jettisonable stowage canister and inflation system. The total launch mass of the sail, or Sail Propulsion Subsystem (SPS), was 78.7 kg, including 7 kg of jettisonable elements, making the flight or operational mass of the SPS 71.7 kg. The jettisonable element mass included 5 kg for the stowage canister and 2 kg for the inflation system. The boom linear mass density for the tapered 8 cm-diameter boom at the base and 2.5-cm diameter boom at the tip was 41.1 g/m. The sailcraft is comprised of the sailcraft bus, SPS, SPS stowage canister, and a three-instrument payload. The sailcraft employs spin stabilization for attitude control, utilizes conventional monopropellant hydrazine propulsion to control sailcraft orientation and has the capability to jettison the sail if it fails to deploy properly and thus perform a conventional L1 Geostorm.

Deployment proceeds in positive and negative directions along one axis and then along the orthogonal axis. A blowdown inflation system with a regulated pressure is used for simplicity and lightweight. A latching valve for each axis allows axis sequencing as well as deployment halt in case of an anomaly. Contacts at each ring (~1-m intervals) on each boom allow monitoring of all boom/sail positions during deployment. The inflation system is jettisoned after deployment and rigidization to lower sailcraft areal density. The operator will be able to bypass regulated pressure in the unlikely event of a tube hang up.

The sail is attached to the booms via rings at ~1-meter intervals. Therefore, the boom deployment control also controls sail deployment; no mechanisms are added. The sail is pulled out from points all along its length rather than just from the tip. If the first axis fails to deploy completely, the second axis of the sail can still be pulled fully out. In addition, since the inboard section of sail is deployed first, sail tensioning can still be accomplished in the event of incomplete boom deployment.

### **3.0 20-meter Ground System Demonstrators**

The ISPT goal is the advancement of key transportation technologies that will enable or enhance future robotic science and deep space exploration missions. Technologies in the portfolio include aerocapture, advanced chemical propulsion, solar electric propulsion, and solar sail propulsion (SSP). The first of two SSP research elements in the ISTP Cycle 1 was called the Ground System Demonstration (GSD), which developed a prototype solar sail system for ground testing that would be used to validate design concepts for: sail manufacturing, packaging, launch to space and deployment; attitude control subsystem function; and to characterize the structural mechanics and dynamics of the deployed sail in a simulated space environment. SSP awarded ground demonstration contracts to two companies that had proposed two distinct technologies in order to achieve the project objectives. ABLE Engineering Company's (now ATK Space Systems) proposed work based on their prior NMP ST-7 proposal, incorporating a rigid coilable boom, an articulating boom attitude control system (ACS) subsystem and partner SRS, Inc.'s (now part of ManTech, Inc.) CP1 sail membrane. L'Garde, Inc. proposed work based on the experience they gained on their NMP ST-5 proposal and as the sail provider for a commercial venture, Team Encounter, incorporating an inflatable and sub-T<sub>g</sub> rigidizable boom, a control vane based ACS and commercial mylar for the sail membrane. Technical descriptions of work performed by AEC<sup>6, 7, 8, 9</sup> and L'Garde<sup>10, 11, 12</sup> on the 20-meter GSD can be found in the respective team's papers

### **4.0 Comparison of 1999 ST-5 and New-Technology Heliostorm Sailcraft Designs**

Missions that might benefit from the use of very large structures in space place a high value on mass-efficient structures and, for sail missions, on space-suitable thin-film membranes. The reason for this is obvious: for missions requiring large space structures most of the mass is in the structure and therefore most of the potential mass savings lies in the structure. Also important to note, specifically for sail missions, is the desire to reduce not only launch mass but also to eliminate mass post launch. Sail missions can continue to benefit from the staging principle after completion of the ballistic portion of the launch. This makes vehicle system design approaches that provide for jettison of the hardware necessary to deploy a sail in space highly valuable. It also places a premium on vehicle system design engineering that takes into account the most mass efficient way to perform all required post-launch spacecraft

functions, particularly those that involve propulsive events and attitude control and stabilization. Although sail technology may offer the possibility of propellantless propulsion and attitude control, many potential sailcraft mission scenarios may benefit from, or even require, jettison of the sail at some point in the mission, requiring the spacecraft to carry a conventional capability for attitude control and propulsive events after sail jettison. Adding the extra mass required to implement a propellantless method for attitude control, such as vanes or a gimbaled-mass-on-a-boom system, during the sail-attached portion of the mission saves propulsion subsystem mass for the overall vehicle use after sail jettison.

L'Garde and the team of JPL and Ball Aerospace used the concepts discussed above to improve the performance of their sailcraft from the ST-5 proposal through the 20-meter GSD program. A preliminary assessment of the benefits provided by implementing the above concepts and their enhancements to the Heliostorm mission was performed prior to the 20-meter test program<sup>15</sup>. Much of the mass savings came from selecting a thinner material (2 micron Mylar). Additional mass savings were brought about by moving to a completely propellantless attitude control system using a set of tip vanes to provide roll, pitch and yaw control of the sailcraft. The vane design includes all component required for stowage in the canister, rotation of the vane into the plane of the sail for deployment, and finally to provide the cant angle to provide passive stability during operation. The boom were lightened by implementing a striped net design that allows the solar loads to be more efficiently spread along the length of the boom, with the sail laid loosely on the supporting stripped net with little stress. Sail wrinkles in the radial direction formed by a small amount of extra sail material are designed to absorb any lateral deformations in the film due to thermal effects. Lateral deformations are absorbed by the additional material, and the deformation from net element to net element is absorbed by slight changes in the billow between net elements. In this way, the net elements and not the sail material dictate the overall shape of the sail effectively decoupling the global sail shape from the membrane material properties. Since the booms are not sized to withstand the bending generated by the solar flux alone, a tensioned truss or spreader system is used to allow the boom to absorb the bending. The spreader system consists of lightweight composite spreader bars mounted to rigid rings integrated into the boom and Kevlar truss lines connecting the spreader bars together.

Table 1 summarizes the key aspects of the ST-5 Geostorm sailcraft and new-technology-based Heliostorm sailcraft design, as just described. Table 2 details the mass breakout for the entire sailcraft and carrier for both designs, including Current Best Estimates (CBE) and mass margins. One accomplishment of the updated mission design is that with the use of thinner sails and a clever design of the jettisonable carrier, the science payload that the sail can carry has increased from 5 kg to 50 kg, which accounts for the majority of the difference between columns 3 and 4 of Table 2. Figure 1 graphically shows the advancement in warning time based on the characteristic acceleration of the sailcraft. The L1 point is .993 astronomical units (AU) from the sun, so it is located at the right side of the graph. The ST-5 design had a goal of maneuvering to .983 AU, however the best achievable was .986 AU. The Heliostorm design based new technologies demonstrated under the ISPT GSD program can achieve a position at .969 AU with a corresponding increase in the amount of warning time for CMEs.

It is important to note that this updated mission concept, and the associated mass allocations, does not include the option for a halo orbit around the L1 point. This is a riskier approach compared to the ST-5 concept where a ballistic trajectory is flown to a halo orbit around L1 and then the sail is deployed to fly to the sub-L1 point. The ST-5 mission design allowed for an operational spacecraft at L1 if the sail failed to deploy. Under the GSD program, L'Garde has perfected an enhanced boom packing concept, allowing the diagonal dimension of a stowed 100 meter sail to decrease from 213 cm to 140 cm. By reducing this dimension and taking the risk of not having a operating spacecraft at L1 if the sail fails to deploy, the entire spacecraft can now be launched on a Taurus class vehicle, compared to a Delta II launched required for the ST-5 sailcraft, saving approximately \$40 million in launcher costs.

## **5.0 CONCLUSION**

Described herein is a concept for a new-technology-based Heliostorm Warning Mission sailcraft design. The sailcraft is capable of operating at a station location inside the Earth's L1 point near 0.969 AU.

Positioned here, the sailcraft offers an improvement in solar storm warning time equivalent to a factor of nearly 2 compared to the 1999 ST-5 Geostorm proposal sailcraft, with that sailcraft positioned at 0.984 AU. The new sailcraft design makes maximal use of new developments in sail design sponsored by NASA's ISPT Program which make viable the scaling up of inflatable-based rigidizable sail designs.

Table 1: ST-5 and Updated Heliostorm Mission Comparison			
Item	1999 NMP ST-5 Proposal	Start of GSD Program	End of GSD Program
System Characteristic Performance Metric			
- Sailcraft Characteristic Acceleration	0.182 mm/s <sup>2</sup>	0.356 mm / s <sup>2</sup>	0.522 mm / s <sup>2</sup>
- Operational Station Location	0.983 AU	0.974 AU	0.967 AU
- Sailcraft Areal Density (dry)	42.6 g/m <sup>2</sup>	9.4 g/m <sup>2</sup>	14.8 g/m <sup>2</sup>
- Sail Propulsion Subsystem Areal Density	18.6 g/m <sup>2</sup>	5.1 g/m <sup>2</sup>	5.6 g/m <sup>2</sup>
Sailcraft System			
- Mass(after carrier sep)	213.1 kg	94.8 kg	148.3 kg
- Power (On-Station)	193.3 W	No change	same
- Attitude Stabilization	Spin	3-axis using vanes	same
- Attitude Control/Propulsion	Conventional monopropellant Hz	Hz system used during deployment only	same
Sail Propulsion Subsystem (SPS)			
-Booms/Structure	Inflatable UV-rigidized Kevlar. Linear mass density: 41.1 g/m <sup>2</sup>	Inflatable sub-Tg- rigidized Kevlar. Linear mass density: 30.5 g/m <sup>2</sup>	Inflatable sub-Tg- rigidized Kevlar. Linear mass density: 31.5 g/m <sup>2</sup>
- Membrane	8-micron-thick Kapton	2-micron-thick mylar	same
- Vanes	Not used	Used	Used
- Jettisonable Elements	7 kg	72 kg	89 kg
Payload/Instrumentation	4.5 kg total	No change	50 kg science package

## REFERENCES

1. NASA Science Mission Directorate (SMD) Draft Heliophysics Roadmap, April, 10, 2006, <http://sec.gsfc.nasa.gov/HeliophysicsRoadmap4106.pdf>
2. J. West, NOAA/NASA/DOD Geostorm Warning Mission, JPL Internal Document D-13986, 18 October 1996.
3. C. McInnis, Solar Sailing: Technology, Dynamics, and Mission Applications, 1999.
4. J. West, NMP ST-5 Solar Sail Project Concept Study Report, July 15, 1999.
5. J. West and B. Derbes, Solar Sail Vehicle System Design for the Geostorm Warning Mission, - AIAA-2000-5326, September 21, 2000.
6. D. Murphy, "Validation of A Scalable Solar Sailcraft", 53rd JANNAP Propulsion Meeting, December 2005
7. J. Gaspar et al., "Testing Of A 20-Meter Solar Sail System", 53rd JANNAP Propulsion Meeting, December 2005
8. B. Taleghani et al, "20 Meter Solar Sail Analysis And Correlation", 53rd JANNAP Propulsion Meeting, December 2005

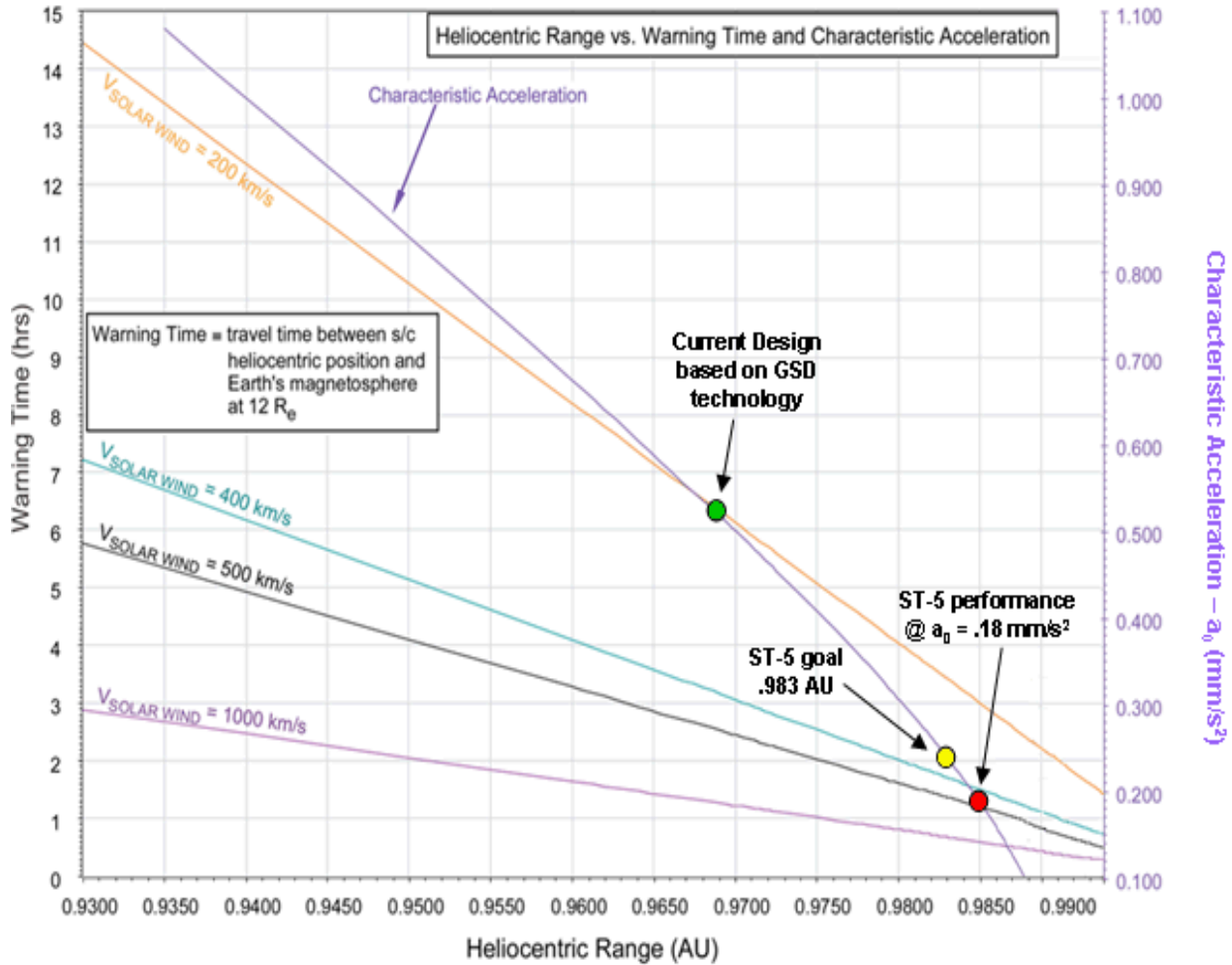

Figure 1: Improved Warning Time

9. G. Laue, D. Case, J. Moore, "Fabrication and Deployment Testing of Solar Sail Quadrants for a 20-meter Solar Sail Ground Test System Demonstration", 41st AIAA Joint Propulsion Conference, July 2005, AIAA 2005-3930
10. D. Lichodziejewski et al., "Vacuum Deployment and Testing Of a 20 meter Solar Sail System", 47th AIAA/ASME/ASCE/AHS/ASC Structures, Structural Dynamics, and Materials Conference, May 2006, AIAA 2006-1705
11. D. Sleight et al., "Structural Analysis and Test Comparison of a 20-Meter Inflation-Deployed Solar Sail", 47th AIAA/ASME/ASCE/AHS/ASC Structures, Structural Dynamics, and Materials Conference, May 2006, AIAA 2006-1706
12. T. Mann et al., "Ground Testing A 20-Meter Inflation Deployed Solar Sail", 47th AIAA/ASME/ASCE/AHS/ASC Structures, Structural Dynamics, and Materials Conference, May 2006, AIAA 2006-1707
13. J. West, The Geostorm Warning Mission: Enhanced Opportunities Based on New Technologies, AAS 04-102, February 2004

Table 2: ST-5 and Updated Heliostorm Mission Mass Summaries

Subsystem/Item	1999 ST5			2006 Heliostorm		
	CBE Mass (Kg)	Contingency (%)	Mature Mass (kg)	CBE Mass (Kg)	Contingency (%)	Mature Mass (kg)
<b>Sail Jettisonable Elements</b>				20.6	30.0%	26.8
Carrier Element Structure	5		5	19.9	30.0%	25.9
Mechanisms				0.3	2.0%	0.3
Electrical Power and Distribution				17.1	20.0%	20.5
Communications				0.3	2.0%	0.3
Thermal Control (Carrier elements)				1.9	30.0%	2.5
Attitude Determination and Control				0.8	2.0%	0.8
RCS Pressurization (Dry)	2		2	11.2	9.0%	12.2
<b>Subtotal: Sail Jettisonable Elements</b>	<b>7.0</b>		<b>7.0</b>	<b>72.1</b>	<b>24.0%</b>	<b>89.4</b>
<b>Spacecraft element Peculiar Structure</b>	17	30%	22.1	5.51	30.0%	7.2
Mechanisms	7.1	30%	9.2	3.45	2.0%	3.5
Electrical Power & Distribution	29	30%	37.7	6.1	17.8%	7.2
Command. Control & Data Handling	11	30%	14.3	9.6	2.0%	9.8
Communications	8.75	30%	11.4	10.8	10.3%	11.9
Thermal Control	2.5	30%	3.3	1	30.0%	1.3
Attitude Determination & Control	1.1	30%	1.4	0.5	2.0%	0.5
Propulsion RCS (Dry)	11.2	30%	14.6			
<b>Subtotal, Spacecraft elements</b>	<b>87.7</b>		<b>113.9</b>	<b>37.0</b>		<b>41.4</b>
<b>Science Payload (Total)</b>	<b>5.9</b>		<b>5.9</b>	<b>50</b>	<b>0.0%</b>	<b>50.0</b>
<b>Solar Sail (Total)</b>	<b>71.7</b>	<b>30%</b>	<b>93.2</b>	<b>49.7</b>	<b>14.5%</b>	<b>56.9</b>
<b>Subtotal, Sailcraft after Carrier Separation</b>	<b>165.3</b>		<b>213.1</b>	<b>136.7</b>		<b>148.3</b>
Deployment Pressurant	2		2	2.9		2.9
<b>Total; Sailcraft and Carrier @ LV separation</b>	<b>174.3</b>		<b>222.1</b>	<b>211.7</b>		<b>240.6</b>
Sail Area dimensions -meters	76.3			104		
Sail Area - m2	5000			10000		
Sail areal density - g/m2	18.642			5.69065		
System areal density - g/m2	42.611			14.82887		
Characteristic acceleration	0.181924855			0.52276404		



# Updated Heliostorm Warning Mission: Enhancements Based on New Technology



**Roy M. Young,**  
*NASA Marshall Space Flight Center, Huntsville, AL, 35812*

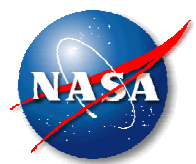

# Acknowledgement



**This work was funded in whole or in part by the In-Space Propulsion Technology Program, which is managed by NASA's Science Mission Directorate in Washington, D.C.**

**The program objective is to develop in-space propulsion technologies that can enable or benefit near and mid-term NASA space science missions by significantly reducing cost, mass, or travel times.**



# HelioStorm Mission





# Solar Radiation and Plasma Effects



**Solar radiation, magnetospheric and galactic particles ionize and heat Earth's atmosphere and ionosphere**

- \* communications & navigation
- \* aurora
- \* currents induced in power grids
- \* spacecraft detector upsets
- \* hazards to humans in space
- \* ozone depletion in major events
- \* speculated climate impacts
- \* spacecraft drag, collisions, loss

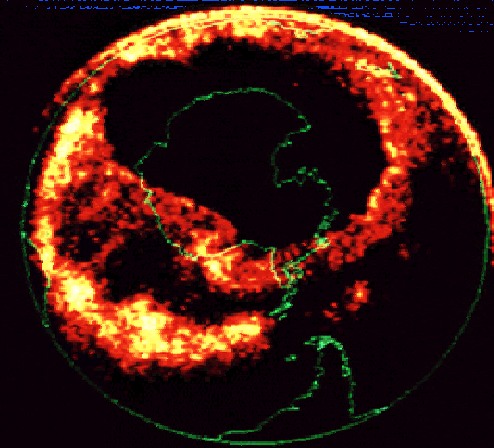
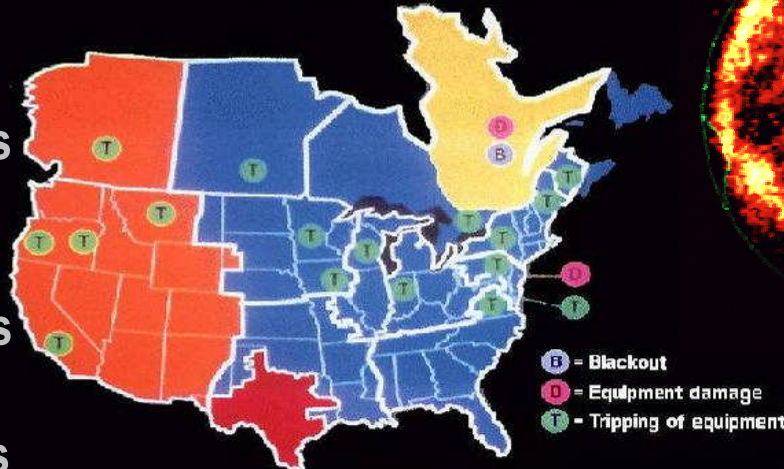

**March 1989:  
Auroral Oval**

**Power System Events**

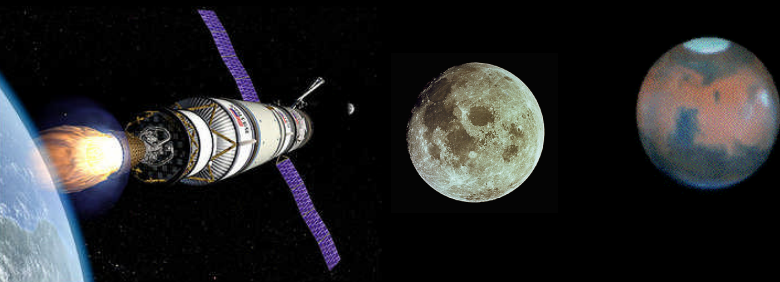
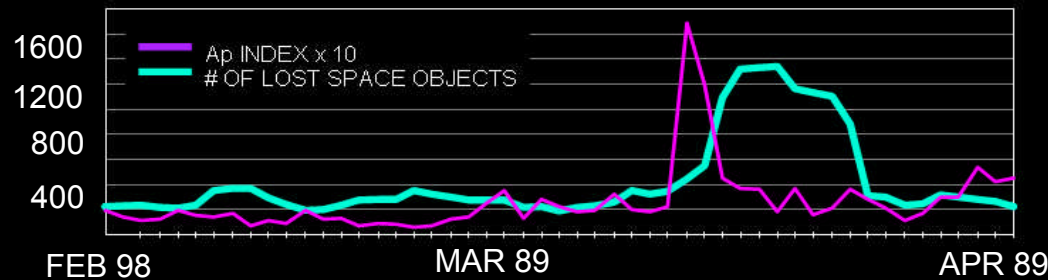

## Sample Impacts (Solar Max, 1989)

- SATCOM interruptions (Desert Storm)
- Worldwide HF comm blackouts
- Lost contacts with Air Force One
- Premature satellite orbit decay
- Hundreds of satellite ops disruptions
- Dozens of failed satellite subsystems
- NORAD lost 1300 orbiting objects
- Six million people lost electrical power

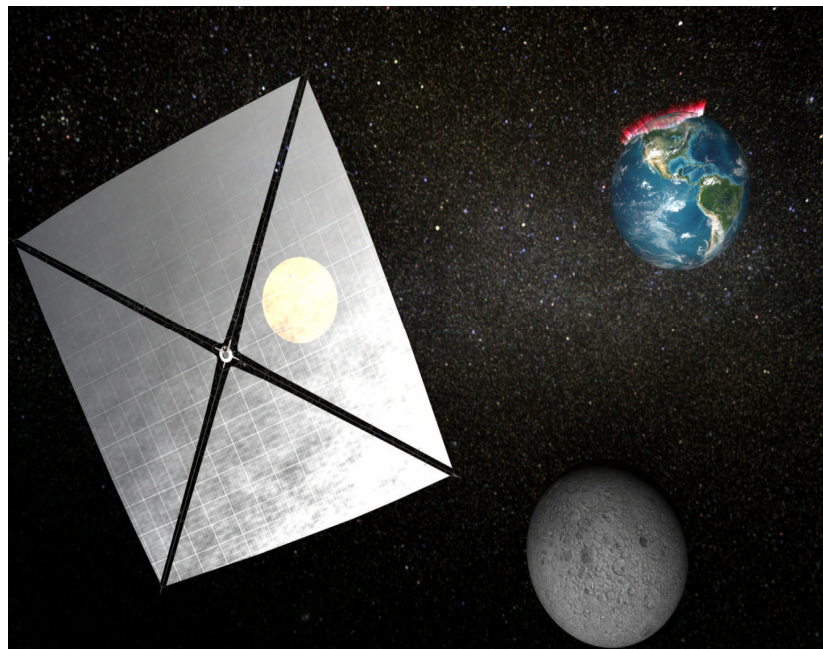

## Science Objectives

- Understand the Sun-to-Earth evolution of CMEs, shocks and particle radiation from solar eruptions
- Remote- and local sense Earth-impacting solar disturbances
- Determine the structure of the solar wind on spatial and temporal scales that are relevant for driving magnetospheric processes
- Provide warning time to protect lunar and Earth-orbiting and ground assets
- Provide a demonstration platform for Exploration and a pathfinder for the Solar Polar Imager science mission

## Mission Description

- Delta II Launch Vehicle
- Trajectory: ballistic transfer from Earth to L1 Halo (~90 days), solar sail transition from L1; 80m square sail @ 14.3 g/m<sup>2</sup>
- Continuous Solar Viewing: 2 years In Final Orbit
- Flight System Concept
- Solar-array powered S/C with solar sail
- Payload: Fields and Particles+ Imaging (33 kg/24 W)

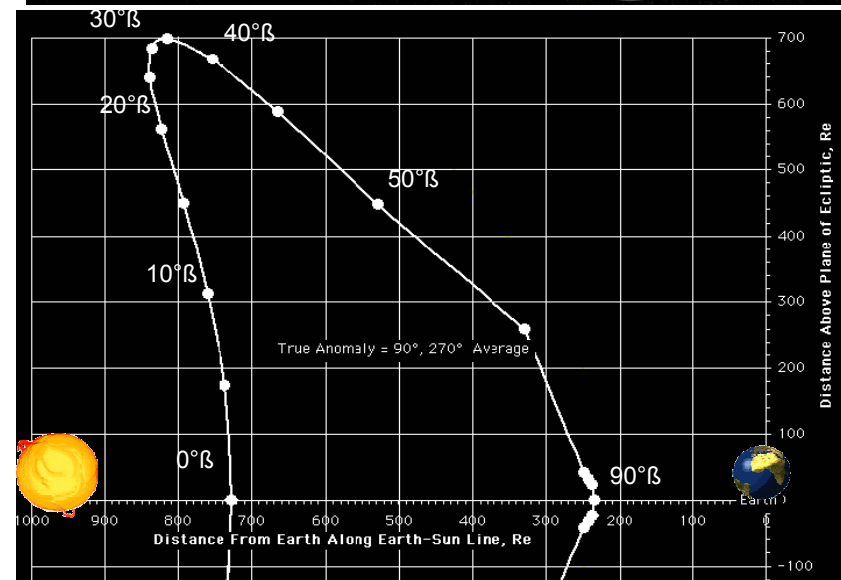



# Sub-L1 Orbit



Sail loadings and cone angles for 0-30 deg artificial Lagrange points  
L1 region, flat sail, 85% reflectivity

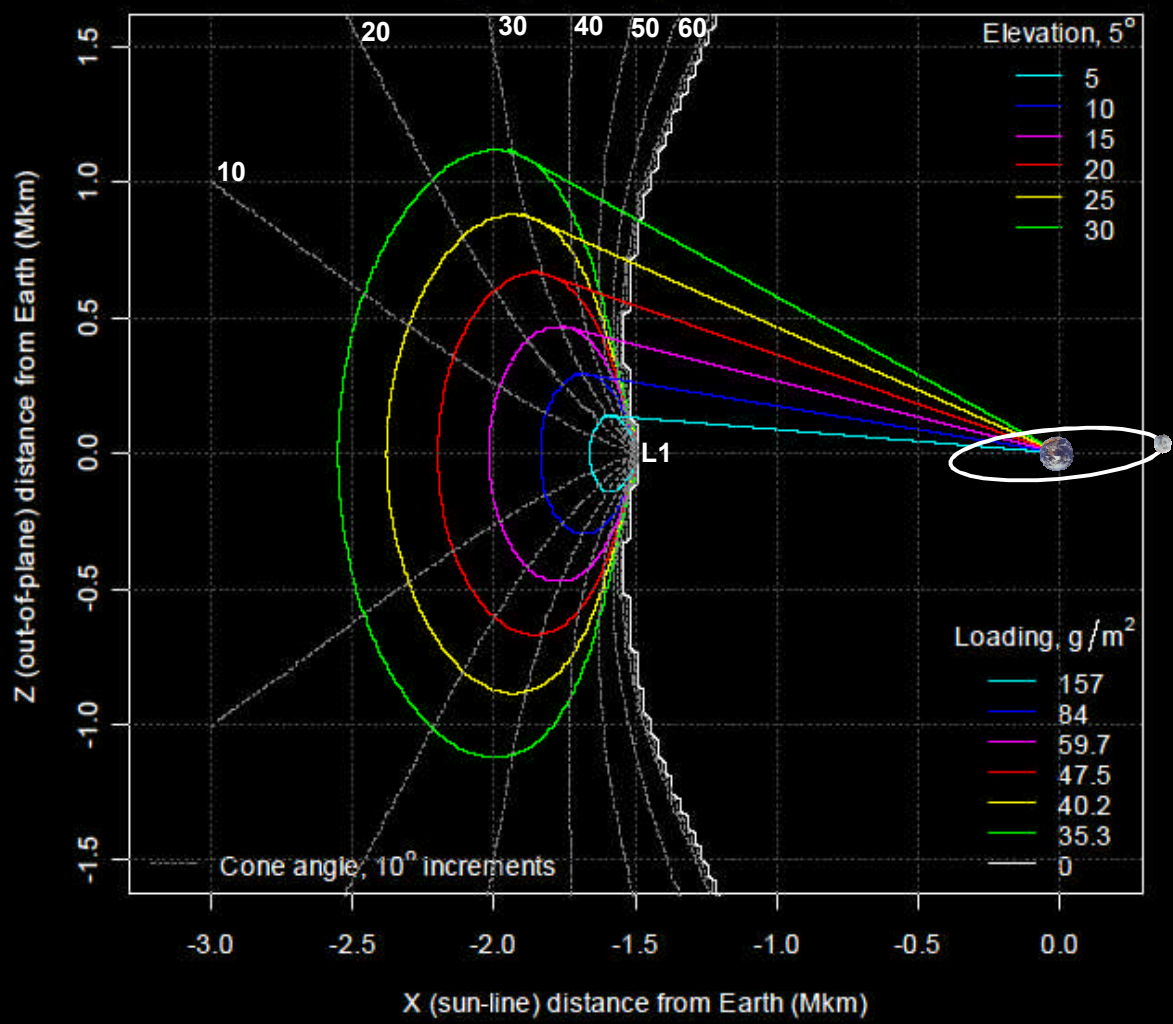

Using small satellite technology merged with a space-inflatable solar sail to take advantage of solar photon pressure to permit the satellite to maintain an unnatural station near the Earth-Sun line at -0.98 AU, well inside the L1 point at -0.993 AU. So positioned, the satellite could provide a factor of 3 increase in warning time over the 30 minutes to 1 hour available at L1.



# Mission Pull

## (2006 Heliophysics Roadmap)



### Solar Sail Demo (SSD)

Because of the impossibility of fully validating Solar Sail technology on the ground, the application of solar sails to a strategic science mission **absolutely** requires a prior successful flight validation. - **page 93**

**Heliostorm**, in the LWS line, uses **solar sails** to hover twice as far up-stream as an L1 mission. **This is the preferred option.** The Helio-physics mission cost would be similar to an Explorer if NOAA and DoD partnered with NASA - **page 60**

We encourage continued development of this technology (**solar sails**) and support the idea of a flight demonstration during Phase 1 of this Roadmap (CY 2005 – 2015). - **page 118**

Progress in key areas of Heliophysics science requires access to unique vantage points and in some cases, non-Keplerian orbits. For example, imaging of the Sun's polar regions requires a high-inclination, heliocentric orbit. Conventional technology would require either 5 years of solar electric propulsion and multiple Venus flybys just to reach a 38° inclination in the inner heliosphere (as for ESA's Solar Orbiter) or a Jovian gravity assist and conventional propulsion to provide an eccentric 0.25 x 2.5 AU polar orbit (as for our future Telemachus mission). **Neither means is as efficient or cost effective as solar sail technology.** - **page 97**

# Mission Concept Based On Space Technology 5 (ST-5) Proposal

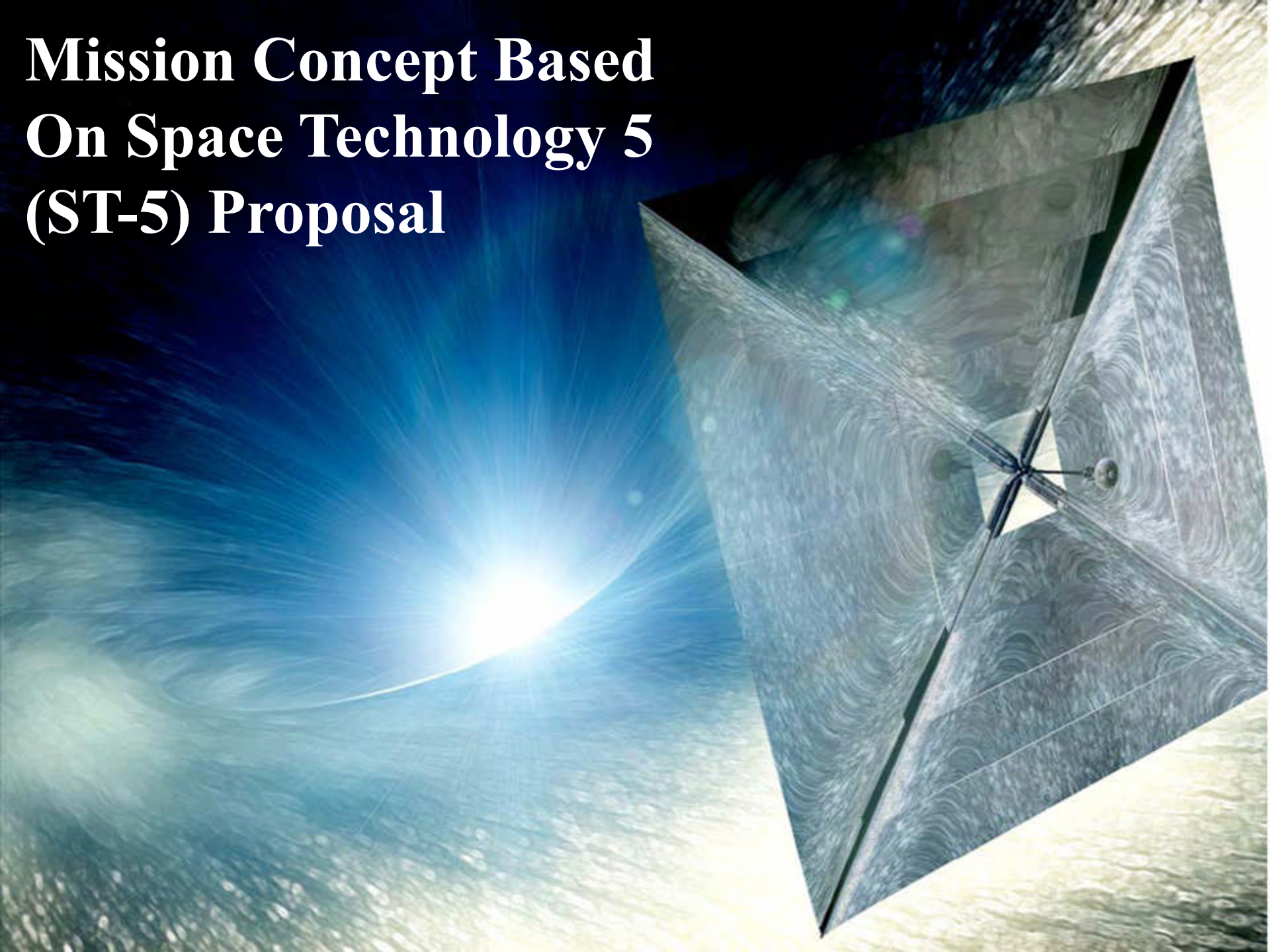



# ST-5 GeoStorm Mission Hardware

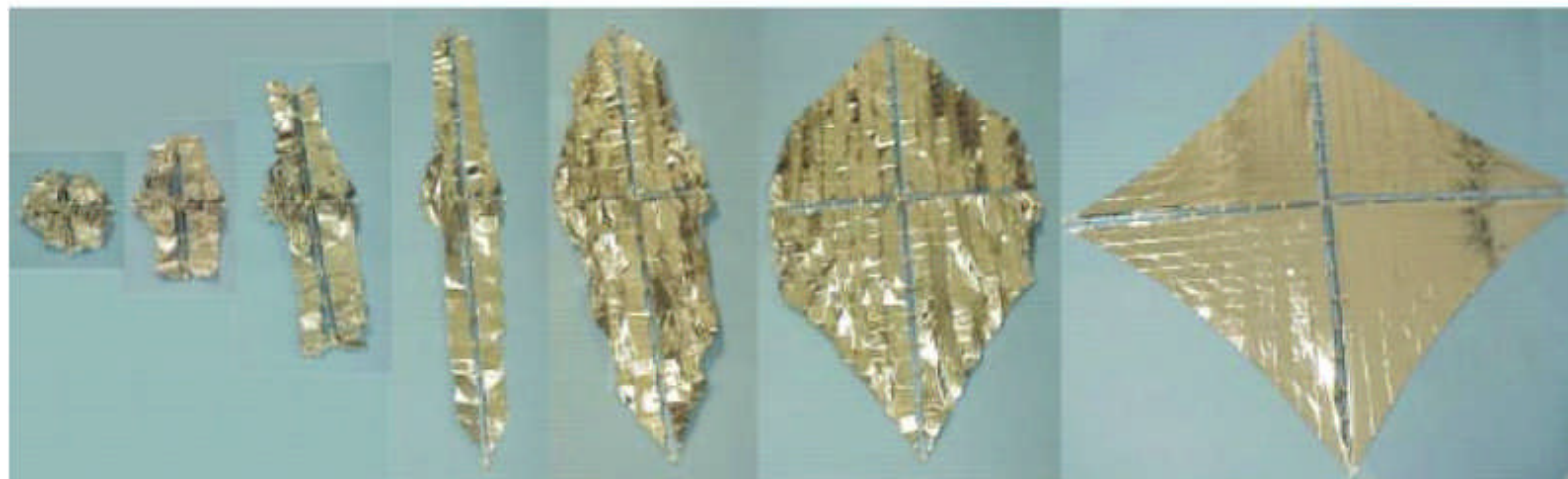

**Sub-scale Sail Deployment – uni-directional deployment with moderate sail tension**

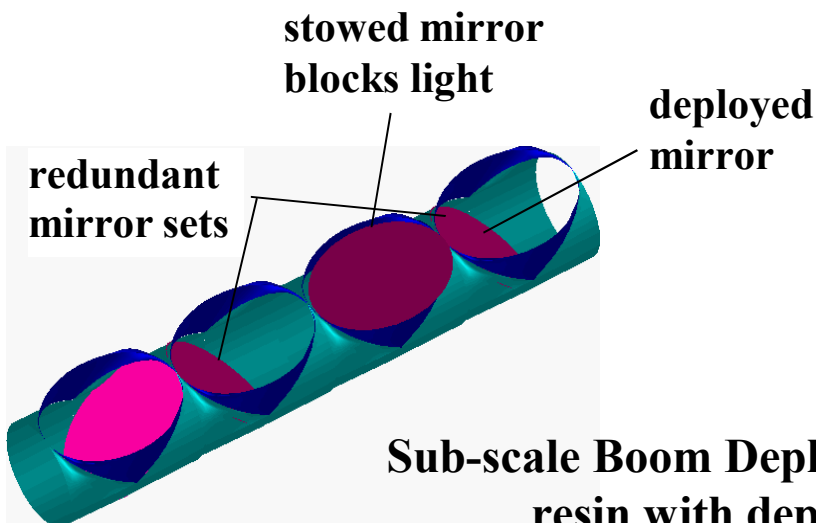

**Sub-scale Boom Deployment – UV rigidized resin with deployable mirrors**



# ST-5 GeoStorm Design

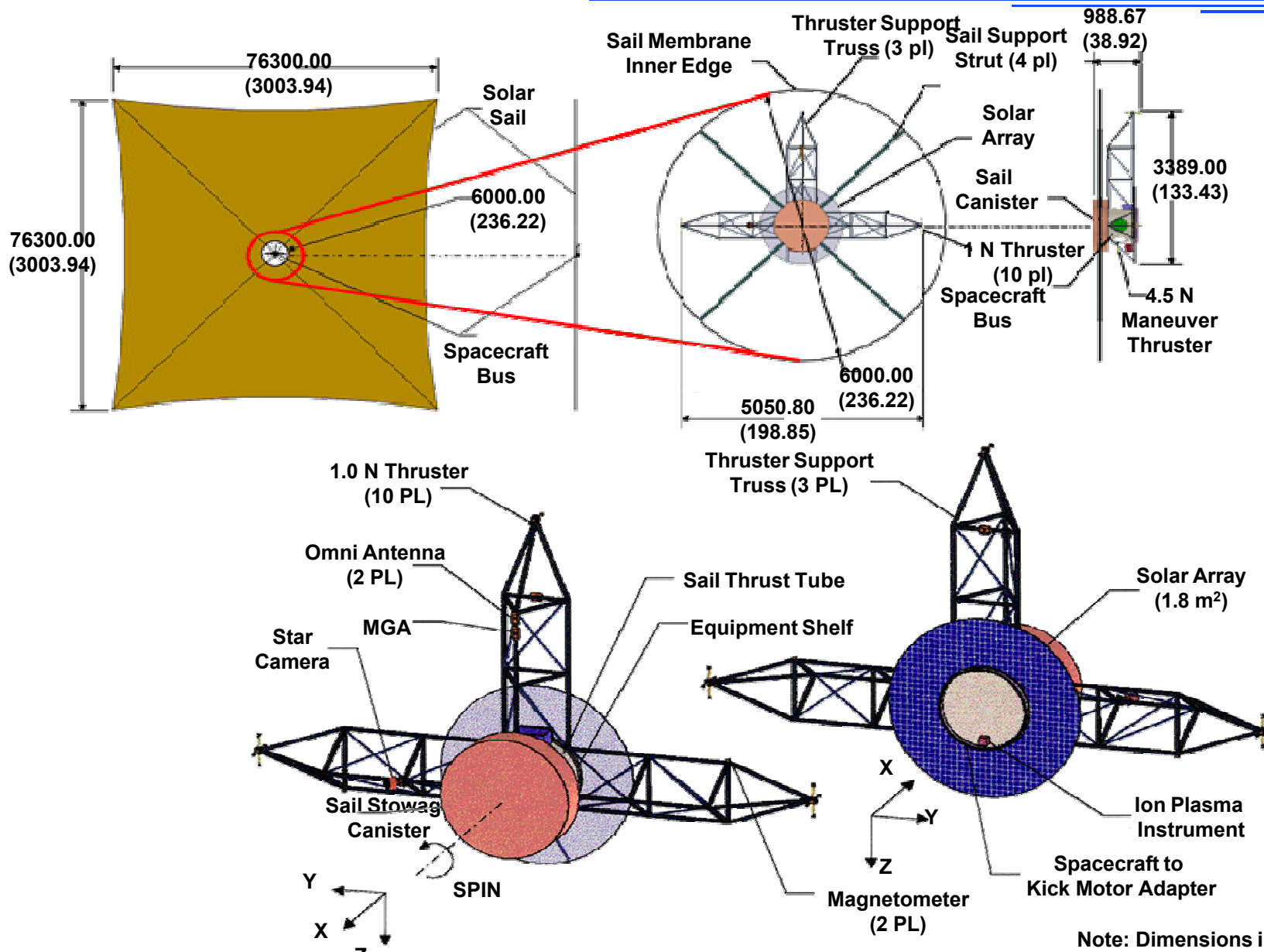





# ST-5 GeoStorm Mission Concept

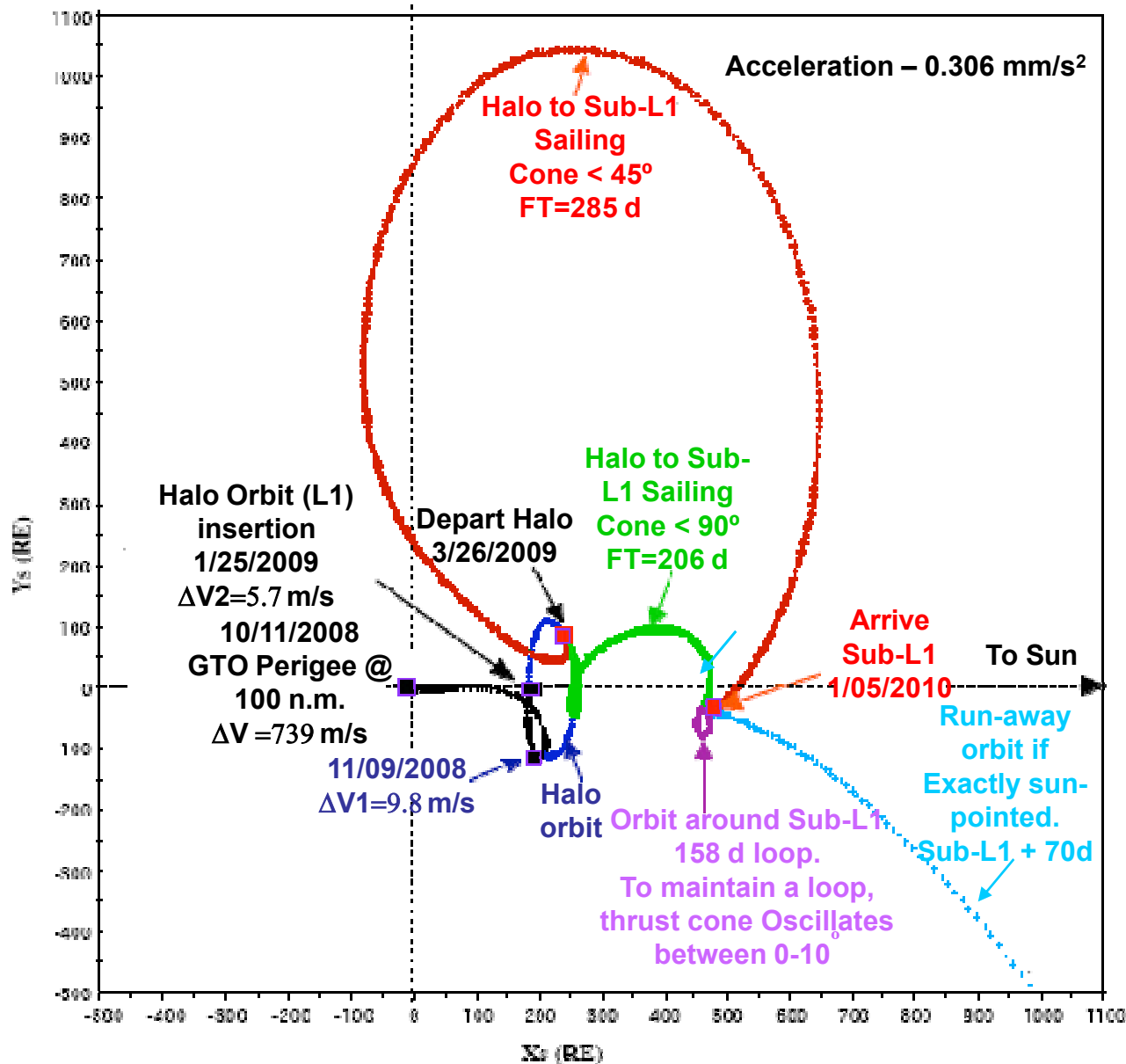

- ST-5 mission concept was a ballistic trajectory to L1 Halo orbit and then, following sail deployment, maneuvering to the sub-L1 point.
- Risk was reduced since a functioning spacecraft was left at L1 if the sail didn't deploy.

# Ground System Demonstration Hardware Development



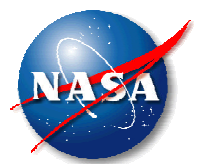

# Solar Sail Propulsion Technology

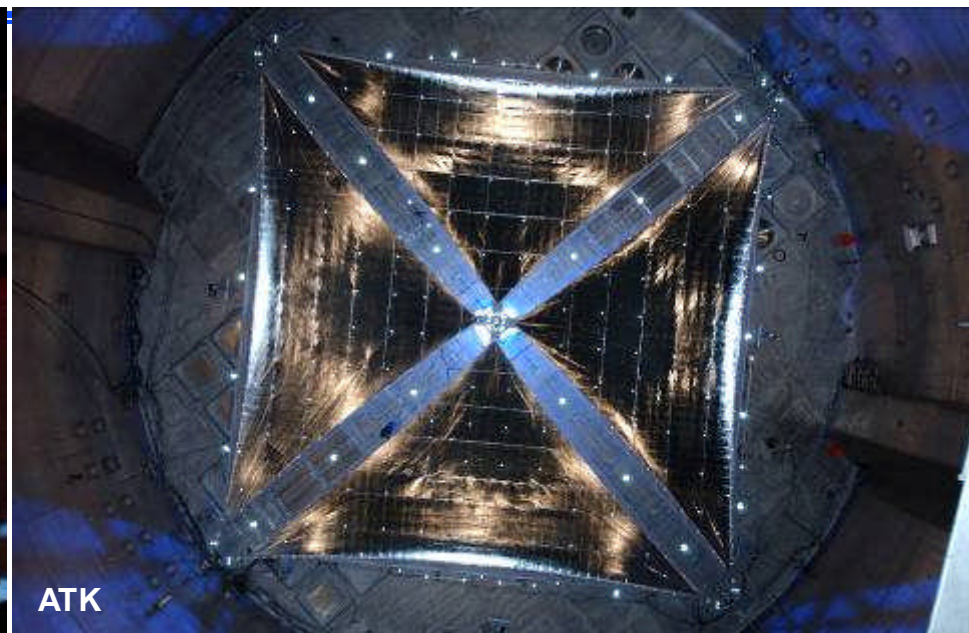
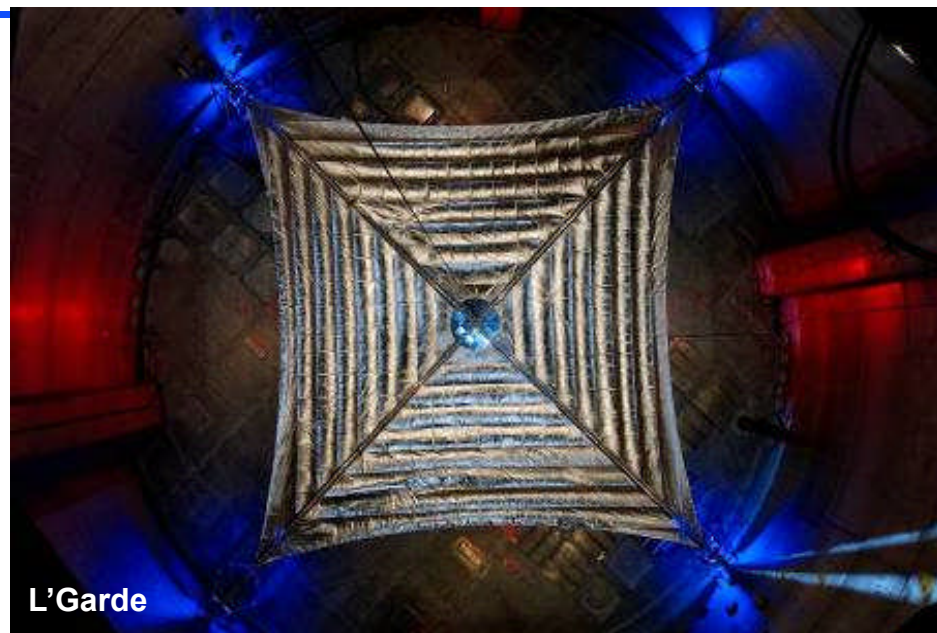

- **Technology Area Status:**

- Two parallel awards to design, fabricate, and test competing sail concepts for system level ground demonstration:
  - 10 m system ground demonstrators were developed and tested in 2004.
  - *20 m system ground demonstrators designed, fabricated, and tested under thermal vacuum and flight conditions in 2005.*
- Multiple awards to develop and test high-fidelity computational models, tools, and diagnostics.
- Multiple awards for materials evaluation, optical properties, long-term environmental effects, charging issues, smart adaptive structures.



# L'Garde Task Summary



## ◆ PI: David (Leo) Lichodziejewski, L'Garde, Inc.

- L'Garde, Inc. (Tustin, CA) systems engineering and inflatable truss
- Ball Aerospace & Tech Corp. (Boulder, CO) mission eng. & bus design
- LaRC (Hampton, VA) sail modeling & testing
- JPL (Pasadena, CA) mission planning & space hazards

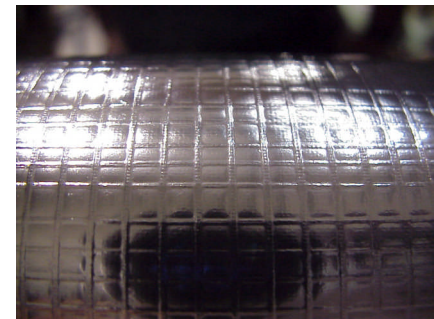

## ◆ Overall Strategy

- Concept Leverages ST-5 Phase A and Team Encounter experience
- Sail membrane, AL coated 2  $\mu\text{m}$  Mylar attached with stripped net
- Lightweight Semi-monocoque Boom With Sub-Tg Rigidization
- 4 Vane Thrust Vector Control

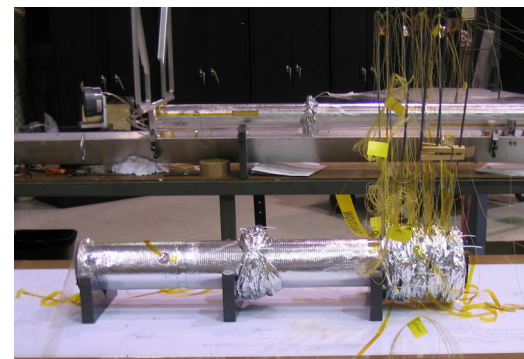

Stowed 7 m boom (~.5 m)

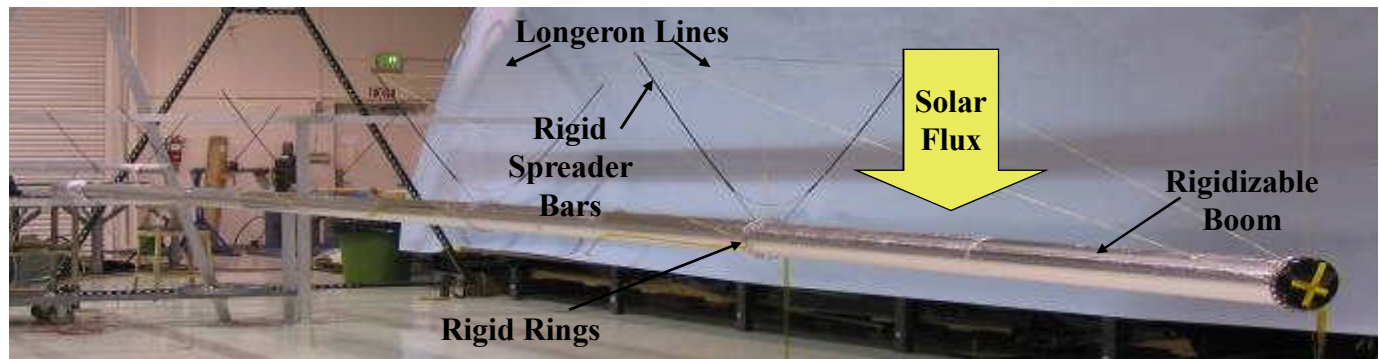

Deployed 7 m boom

An aerial photograph of a large, complex metal structure, identified as a 20-meter ISPSS vacuum deploy, mounted on a dark, metallic surface of a space station. The structure consists of several vertical support beams and horizontal cross-arms, forming a rectangular frame. Two large, cylindrical components are visible at the top of the structure. The background shows the intricate details of the station's exterior, including various panels, pipes, and structural elements.

20 Meter ISPSS  
Vacuum Deploy

ECGarde

# Mission Concept Based on Technology Enhancements

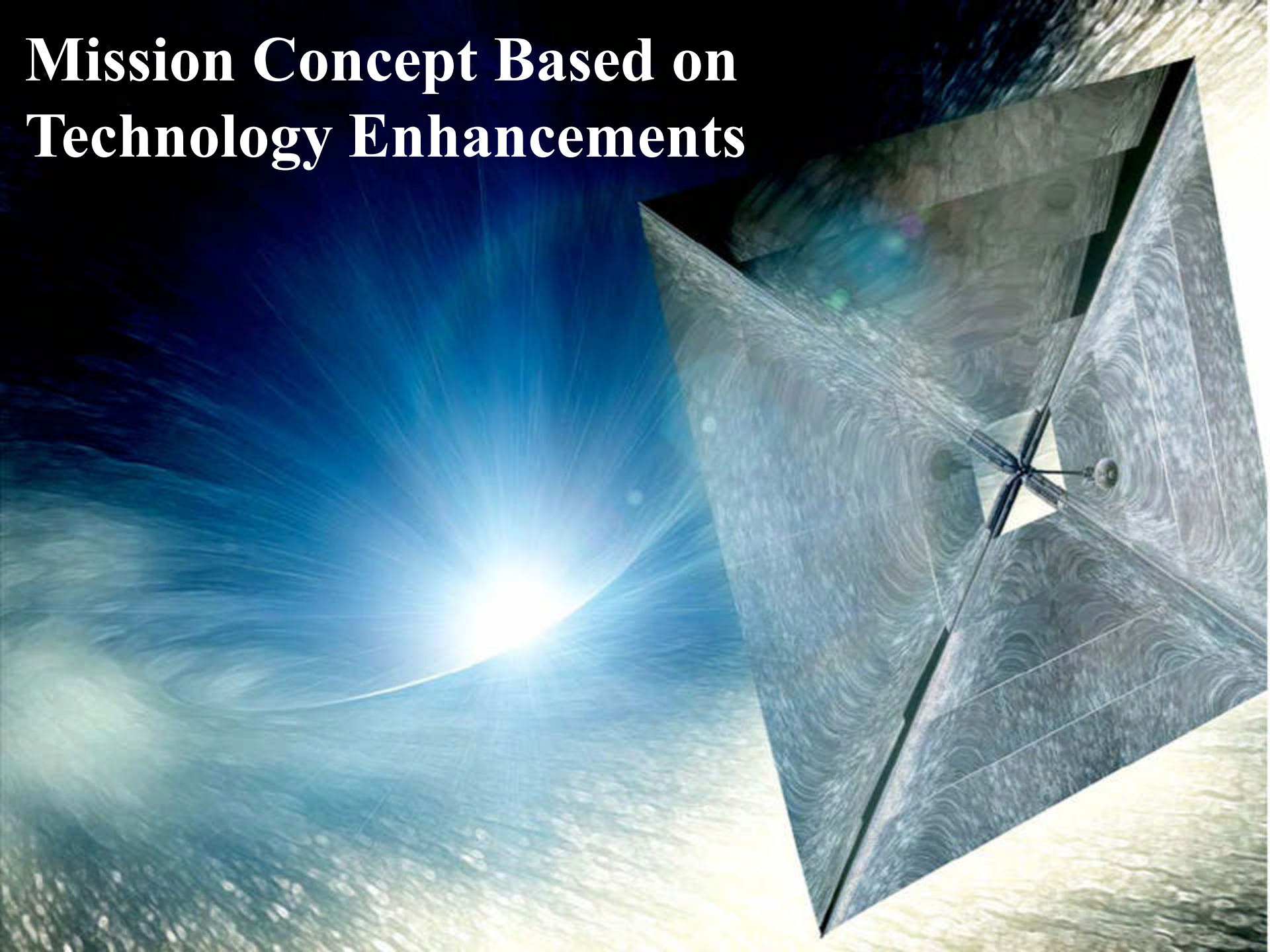



# Heliostorm Design

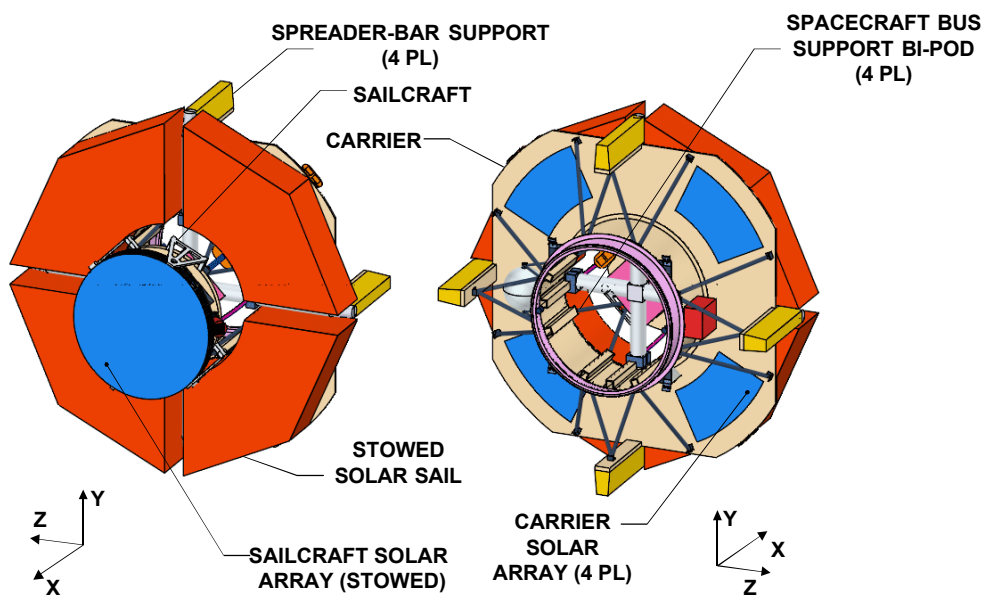
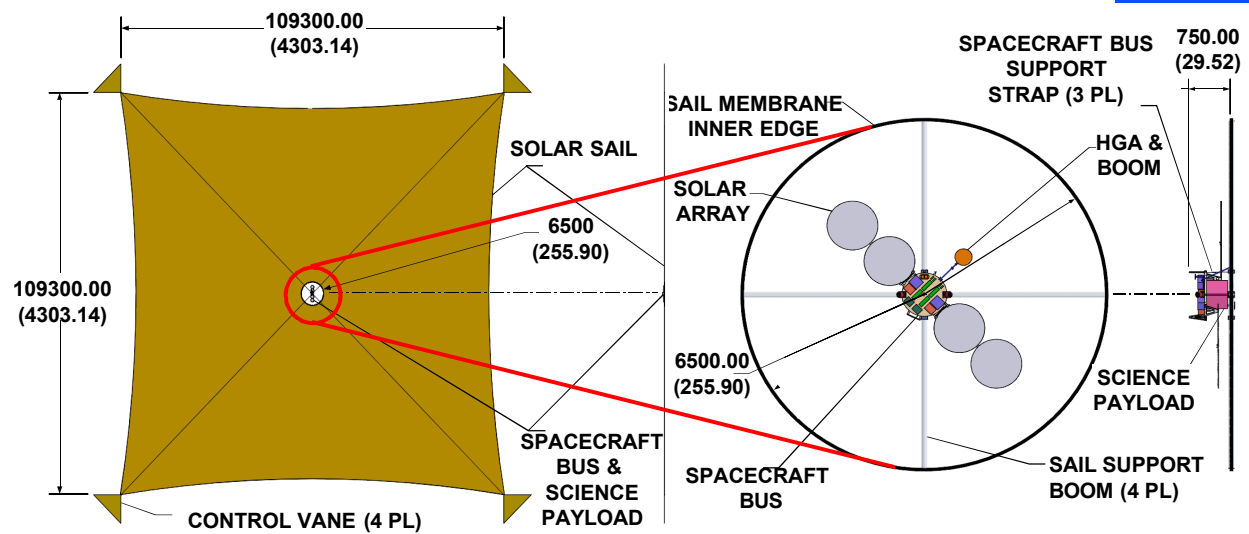

Note: Dimensions in mm (in)

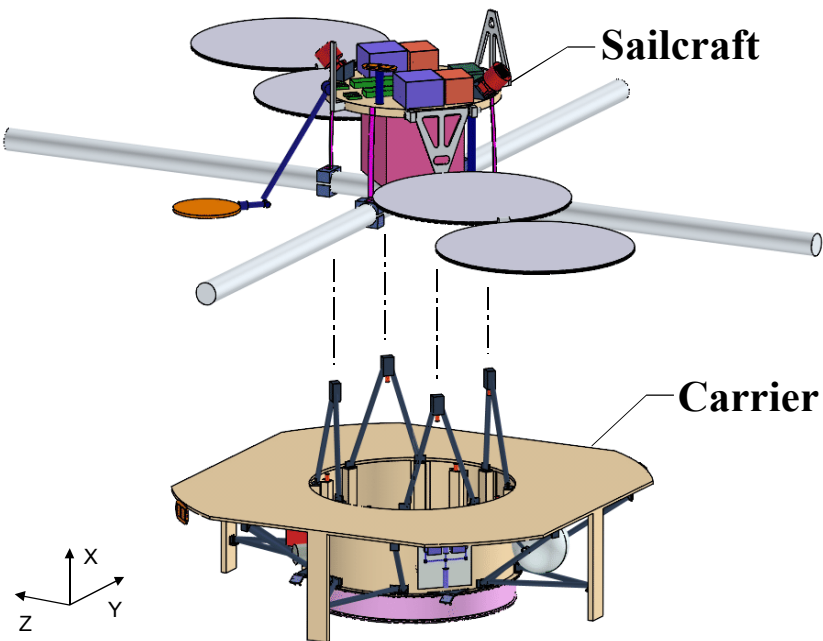
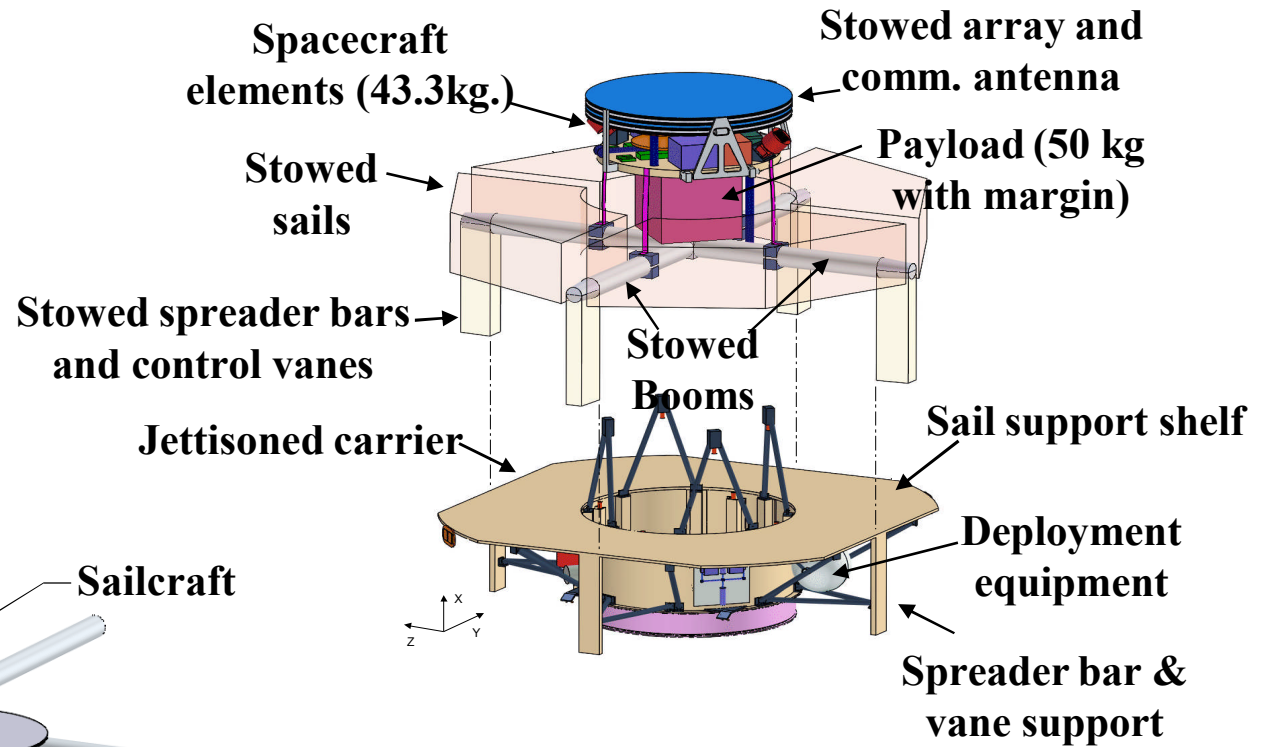

- New design maximizes staging concept
- Riskier plan in that sail is deployed without entering a L1 halo orbit







# Sail Propulsion System Mass Estimates



LGMS100A Main sc Projected Area (m <sup>2</sup> )	10,000							
Closest Solar Approach (AU)	0.95							
	<b>Original</b>	<b>Phase 1 Concept Design</b>			<b>Post Goddard</b>	<b>Phase 3 Final Design</b>		
<b>Mainsail Quadrant Component</b>	<b>Estimated</b>	<b>Estimated</b>	<b>Contingency</b>	<b>Mature</b>	<b>Boom Test</b>	<b>Estimated</b>	<b>Contingency</b>	<b>Mature</b>
2m Mylar quadrant (ST5 is 8m Kapton)	7,366	6,704	5%	7,039	N/A	6,664	5%	6,997
900 A frontside aluminum	446	620	15%	713	N/A	617	20%	740
200 A backside chromium	476	368	15%	423	N/A	914	20%	1,097
quadrant features	731	597	20%	716	N/A	534	30%	694
stripe net	151	70	15%	81	N/A	103	20%	124
membrane management	0	136	15%	156	N/A	148	20%	178
mainsail quadrant system, each	9,170	8,495	7%	9,129	N/A	8,980		9,830
4 mainsail quadrants	36,680	33,980		36,515		35,920		39,319
<b>boom system</b>	1,551	1,273	15%	1,469	1,489	1,516		1,926
unis	623	528	15%	607	623	641	30%	833
spiral wrap	203	177	15%	204	203	216	30%	281
bladder	311	262	15%	301	270	309	20%	371
encapsulation	194	96	10%	106	157	117	20%	140
insulation	210	202	20%	242	219	215	30%	280
PBO rings	10	8	10%	9	16	18	20%	22
<b>spreader system total</b>	672	501	16%	583	580	481		590
spreader bars with torsion web	445	297	15%	342	287	307	20%	368
spreader wires	141	92	10%	101	162	43	20%	52
bay rings	86	112	25%	140	131	131	30%	170
<b>beam deployment control system</b>	97	425	16%	493	284	478		595
boom holdback straps	30	34	15%	39	27	48	30%	62
ring & boom fold doubler tapes	15	12	15%	14	10	30	20%	36
tip mandrel with tip cap	39	99	20%	119	65	117	30%	152
line management pockets		4	15%	5		7	20%	8
quarter of center box with base cap	13	52	15%	60	13	52	30%	68
extensometer line		7	10%	8		7	20%	8
Heater/vane motor control wires		217	15%	250	169	217	20%	260
<b>mainsail beam, each</b>	2,320	2,199	16%	2,545	2,353	2,475		3,112
4 mainsail beams	9,280	8,796		10,180		9,900		12,448
LGV30A Vane Projected Area (m <sup>2</sup> )	30.4 m <sup>2</sup>							
Closest Solar Approach	0.95 AU							
<b>Vane Component</b>								
vane panel	117	103	8%	111	N/A	110	10%	120
vane struts	433	370	30%	481	N/A	476	30%	619
base deployment yokes & actuator	100	400	30%	520	N/A	400	30%	520
vane mass, each	649	873	27%	1,109		986		1,259
4 vanes	2,596	3,492		4,435		3,944		5,037
<b>Sail System</b>	48,556	46,268		51,129		49,764		56,804



# Sailcraft Mass Estimates



Subsystem/Item	1999 ST5			2006 Heliostorm		
	CBE Mass (Kg)	Contingency (%)	Mature Mass (kg)	CBE Mass (Kg)	Contingency (%)	Mature Mass (kg)
Sail jettisonable Elements				20.6	30.0%	26.8
Carrier Element Structure	5		5	19.9	30.0%	25.9
Mechanisms				0.3	2.0%	0.3
Electrical Power and Distribution				17.1	20.0%	20.5
Communications				0.3	2.0%	0.3
Thermal Control (Carrier elements)				1.9	30.0%	2.5
Attitude Determination and Control				0.8	2.0%	0.8
RCS Pressurization (Dry)				11.2	9.0%	12.2
<b>Subtotal: Carrier (Dry)</b>	<b>7.0</b>		<b>7.0</b>	<b>72.1</b>	<b>24.0%</b>	<b>89.4</b>
S/C element Peculiar Structure	17	30%	22.1	5.51	30.0%	7.2
Mechanisms	7.1	30%	9.2	3.45	2.0%	3.5
Electrical Power & Distribution	29	30%	37.7	6.1	17.8%	7.2
Command. Control & Data Handling	11	30%	14.3	9.6	2.0%	9.8
Communications	8.75	30%	11.4	10.8	10.3%	11.9
Thermal Control	2.5	30%	3.3	1	30.0%	1.3
Attitude Determination & Control	1.1	30%	1.4	0.5	2.0%	0.5
Propulsion RCS (Dry)	11.2	30%	14.6			
<b>Subtotal, spacecraft elements</b>	<b>87.7</b>		<b>113.9</b>	<b>37.0</b>		<b>41.4</b>
<b>Science Payload (Total)</b>	<b>5.9</b>		<b>5.9</b>	<b>50</b>	<b>0.0%</b>	<b>50.0</b>
<b>Solar Sail (Total)</b>	<b>71.7</b>	<b>30%</b>	<b>93.2</b>	<b>49.7</b>	<b>14.5%</b>	<b>56.9</b>
<b>Subtotal, Sailcraft at Carrier Separation</b>	<b>165.3</b>		<b>213.1</b>	<b>136.7</b>		<b>148.3</b>
Pressurant	2		2	2.9		2.9
<b>Total; Sailcraft and Carrier @ LV separation</b>	<b>174.3</b>		<b>222.1</b>	<b>211.7</b>		<b>240.6</b>
Sail Area dimensions -meters		76.3			104	
Sail Area - m2		5000			10000	
Sail areal density - g/m2		18.642			5.69065	
System areal density - g/m2		42.611			14.82887	
Characteristic acceleration		0.18192			0.522764	



# Current Heliostorm Performance

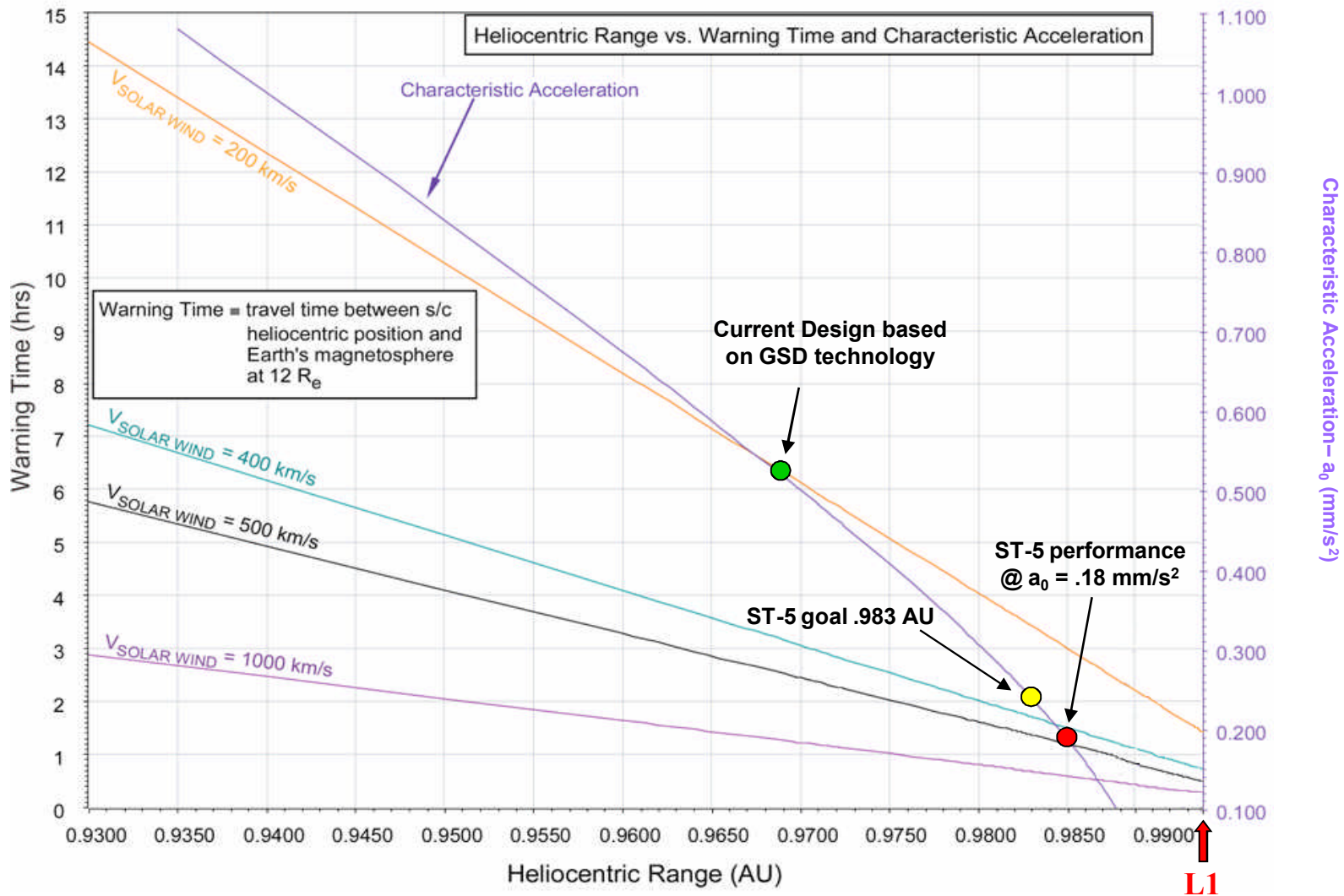

Updated solar sail technology allows a Heliostorm mission concept that increases warning times by a factor of 3



**QUESTIONS ??**