

DRAFT

Source of Acquisition
NASA Johnson Space Center

Space Power Workshop 2003

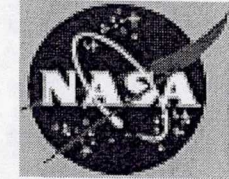

COTS Li-Ion cells in high voltage batteries

Francis Davies NASA-JSC Battery Group Houston fdavies@ems.jsc.nasa.gov

Eric Darcy NASA-JSC Battery Group Houston edarcy@ems.jsc.nasa.gov

Judy Jeevarajan NASA-JSC Battery Group Houston jjeevara@ems.jsc.nasa.gov

Phil Cowles COM DEV Battery Group Cambridge Ontario philip.cowles@comdev.ca

Abstract

Testing at NASA JSC and COMDEV shows that COTS Li Ion cells can not be used in high voltage batteries safely without considering the voltage stresses that may be put on the protective devices in them during failure modes.



COTS Li-Ion cells in high voltage batteries

Table of contents

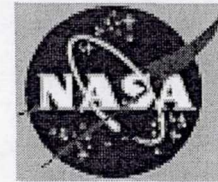

- Overview of high voltage battery.
- Description of protective systems in COTS Li-Ion cells
 - PTC
 - CID
 - Shutdown separator
- Initial 24S failure.
- Testing to investigate PTC voltage tolerance
- Description of diode scheme
- Short circuit testing successful
- Test with diodes failed
- Conclusions

Overview of high voltage battery

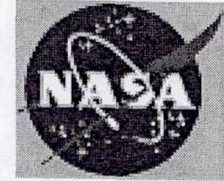

- Currently a hydrazine-fueled turbine-driven unit drives the Shuttle hydraulics. There are three redundant systems.
- Drives: thrust vectoring, propellant valves, body flaps, landing gear, nosewheel steering
- Required during launch and de-orbit.
- NASA is looking at alternative battery solutions.
 - Safety
 - Reliability
 - Cost

Protective devices in COTS cells: overall

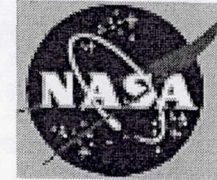

- Structure of battery shown below.

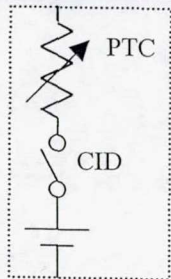
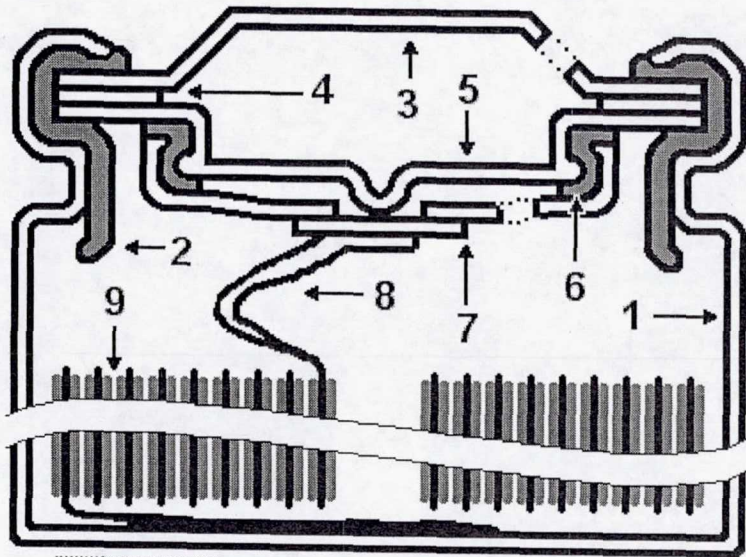

Sony 18650
Li Ion cell

1. Cell housing.
2. Insulating seal.
3. End cap. This is a metal disk with a raised area with three vent holes. This is the positive terminal of the cell.
4. PTC (Positive Temperature Coefficient) disk. This is sandwiched between the end cap and the CID. All electrical current into or out of the battery flows through this disk. It functions like a resettable fuse.
5. CID (Current Interrupt Device) rupture disk. This disk serves as a pressure activated switch which opens if pressures in the cell rise. All battery current passes through this contact point.
6. CID insulator. This plastic insulator fits between the CID disk and the CID back plate holding the two together while insulating them from each other.
7. CID back plate. This metal plate presses against the point on the CID disk. It has large holes in it that allow the gasses inside the battery cell to press against the CID disk.
8. Electrode tab. Connection from CID back plate to electrode
9. Shutdown separator. At high temperatures, this becomes less porous, reducing rate of energy release.

Protective devices in COTS cells: CID

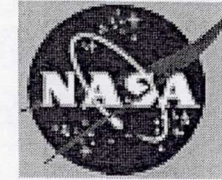

■ CID

- Trips when overcharging or heating creates high pressures (190 psiD) inside cell.
- Acts like a pressure activated switch
- Deformation due to pressure not reversible.

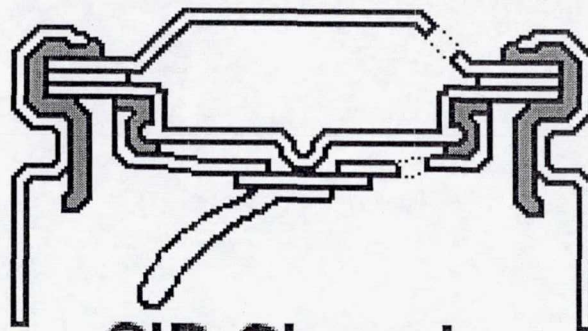

CID Closed

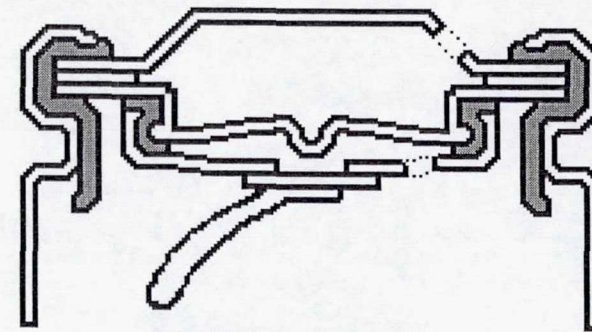

CID Open

Protective devices in COTS cells: PTC

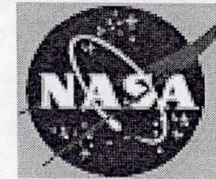

- The PTC is a Positive Temperature Coefficient thermistor. Its resistance jumps dramatically when current heats it above the threshold temperature
- PTCs act differently after first trip: higher cold resistance, shorter trip time, higher withstand voltage.

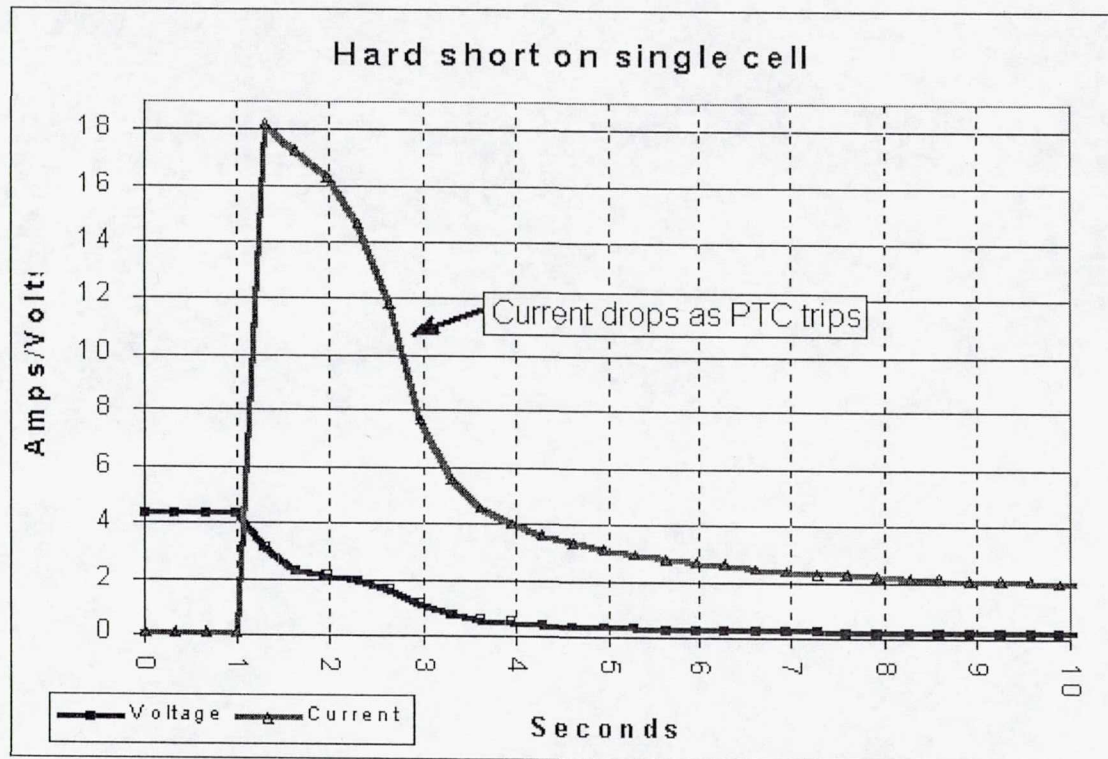
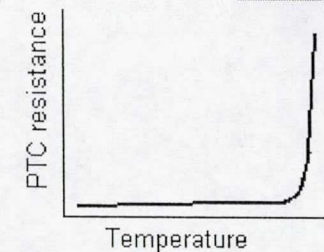

Notes:

PTC current tapers to approx 1.1 A after approx. 200 sec.

After trip, voltage across cell is low (<0.1V) but most of the voltage drop is across PTC.

After trip, temperature of case at PTC end of cell reached approx 170F (76C). Large thermal gradient along length of cell case (22F, 12C)

Tests at different voltages show PTC holds constant power (4-5W) over wide voltage range (4V to 34V)

Hotter ambient temperature results in faster trip times

Protective devices in COTS cells: Separator

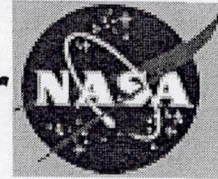

- Shutdown separator: Becomes less porous, limiting cell current at high temperatures.

Inactivated separator

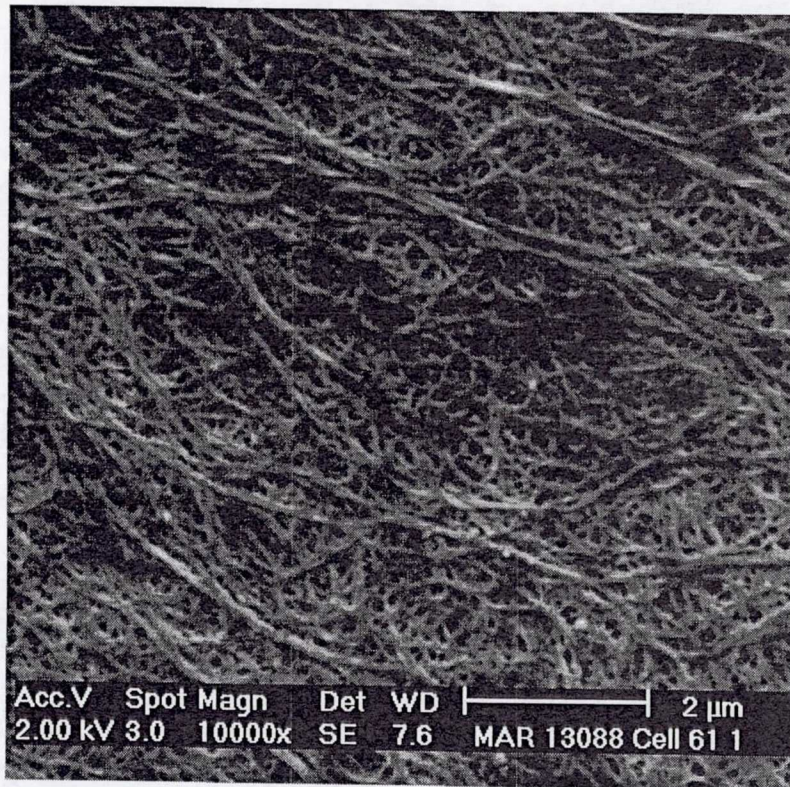

Activated separator

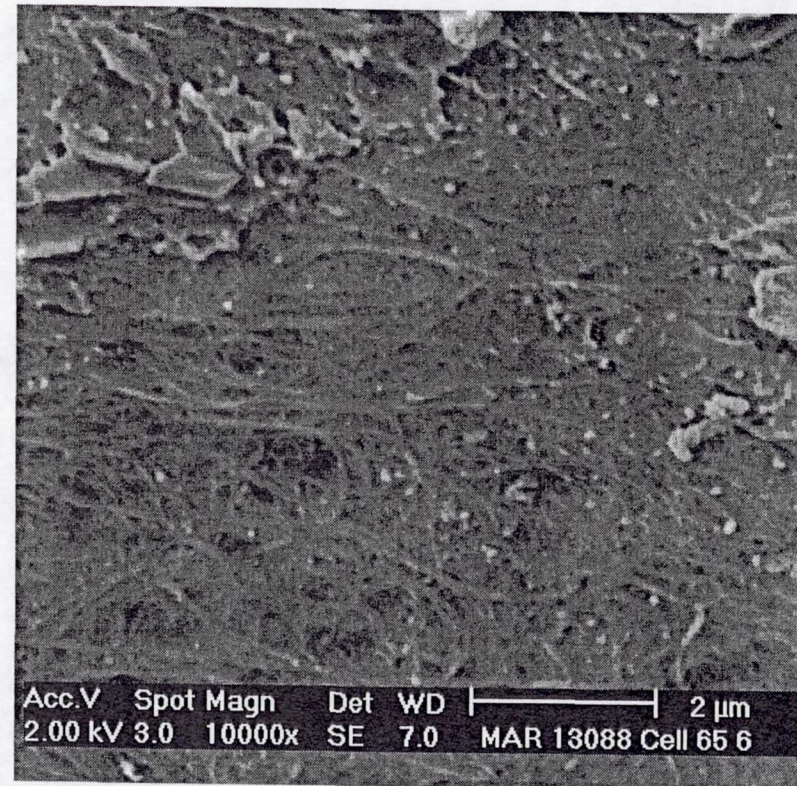

Initial 24S failure

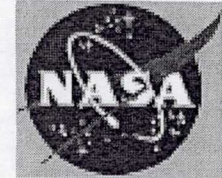

- Initial design review raised doubts that PTC could handle the high voltages that result when PTCs activate during short circuits.
 - Multiple PTCs in series: only one will trip and take all the voltage.
- Short circuit on 24S2P unit showed cell overheating and venting (shown below)
- Measurements showed cells momentarily experiencing large negative voltages.

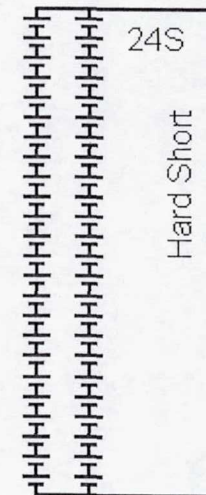
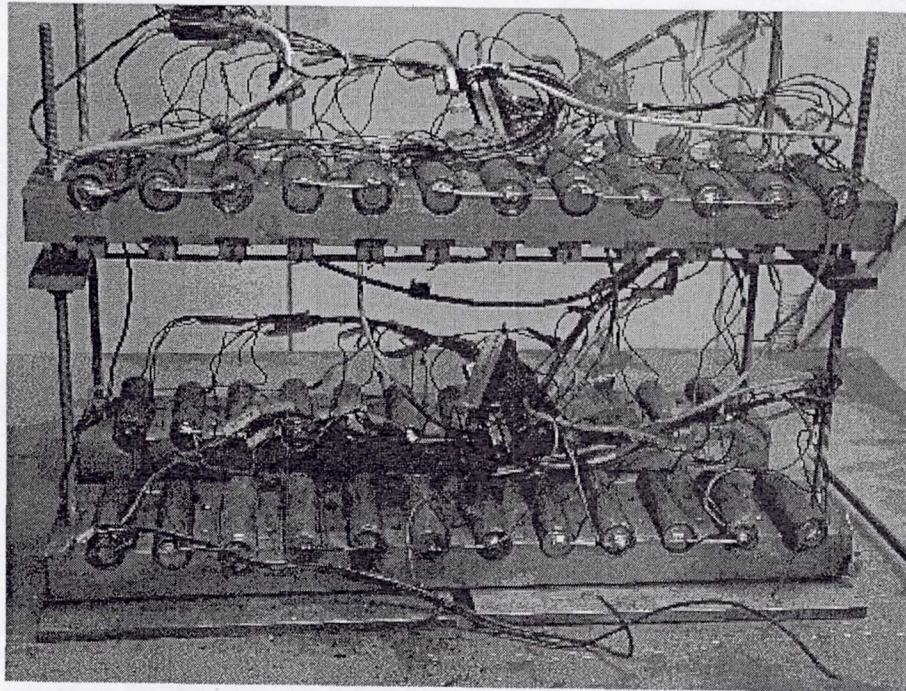

PTC failure under high voltage conditions

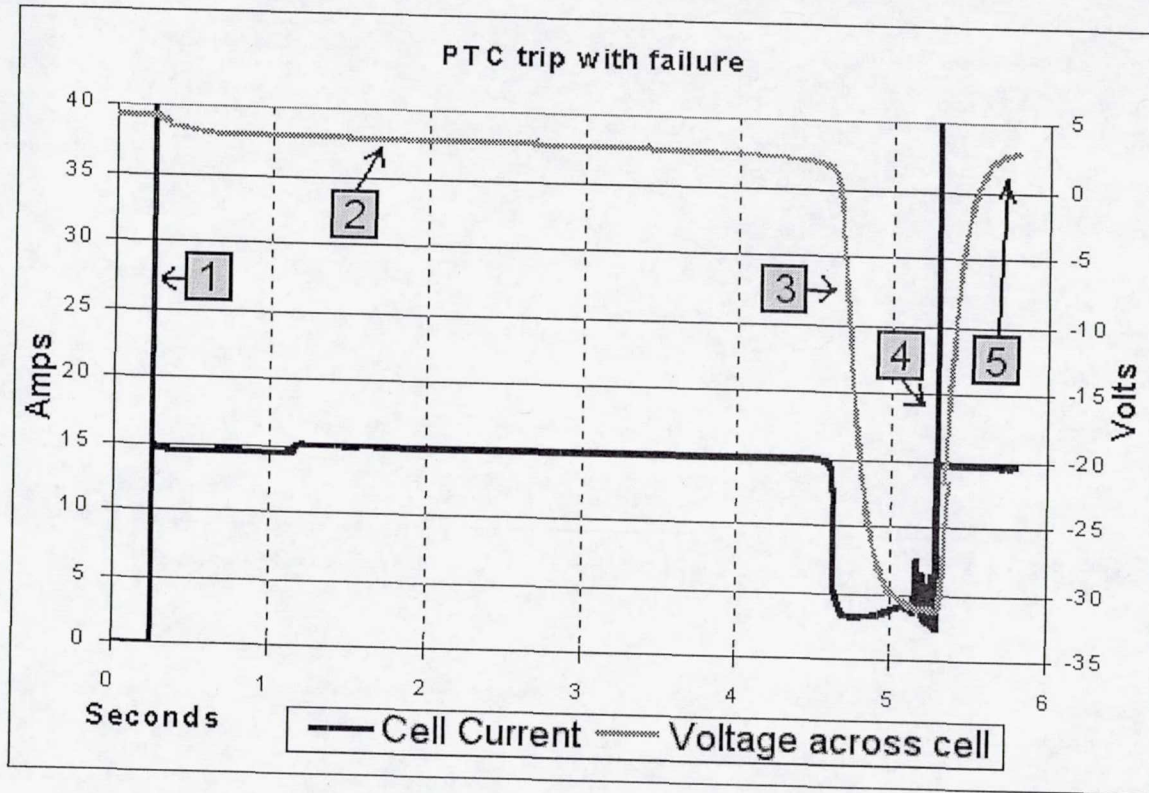
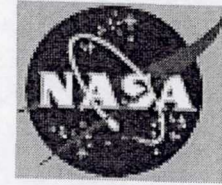

Test setup:

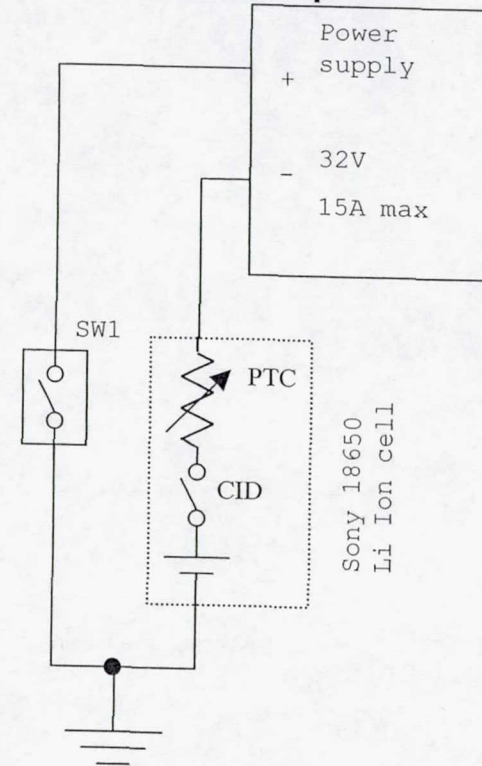

1. SW1 closed, simulating short of 8S batter. Current spike due to power supply capacitors.
2. Power supply in current limit, cell voltage reduced due to 15A flowing through cell and PTC impedance. PTC heating up
3. PTC trips (goes high resistance). PTC gets approx 36V across it, current drops.
4. PTC breaks down, turns to charred mass.
5. Power supply in current limit, PTC has been effectively replaced by a poor short.

Summary of PTC voltage tolerance testing

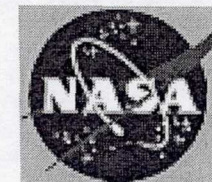

- Manufacturer's information indicated maximum PTC voltage of 30V

S/N	Temp at start	Voltage after trip	Notes	DPA notes
061	25C	0.0V 1.0 cells	No failure	
065	25C	0.0V 1.0 cells	No failure	
049	25C	-25.4 V 6.8 cells	No failure	
060	25C	-32.36 V 8.4 cells	Failed after less than 1 second of -32 V Data shows PTC failure, then seal failure after 8 seconds	DPA showed damage to PTC and shorted seal
056	25C	-30.9 V 8.1 cells	Failed after less than 1 second of -31V	DPA showed damage to PTC and shorted seal
066	25C	-30.6 V 8.0 cells	Failure 43 sec after trip PTC end at 36C at failure. PTC end went up to 83C while supply on (15A).	DPA showed minor damage to PTC and shorted seal
057	25C	-22.5 V 6.2 cells	No failure	
064	65C	-22.6 V 6.2 cells	No failure	
055	65C	-27.3 V 7.3 cells	Failure after 90 sec of -27.3 V PTC end stayed at 84C after external supply removed and during purge.	DPA showed no damage to PTC, but seal shorted under curled over crimp edge.
051	65C	-26.8 V 7.2 cells	No Failure	

Description of diode scheme: Overview

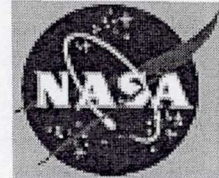

- Problem: PTCs in series do not share voltage when tripped. When a high voltage series string of cells is shorted, one PTC takes the full voltage and will fail
- Solution: Place diodes across groups of cells. Like reversal prevention diodes, they will prevent large reverse voltages across the PTCs.

Description of diode scheme: Details

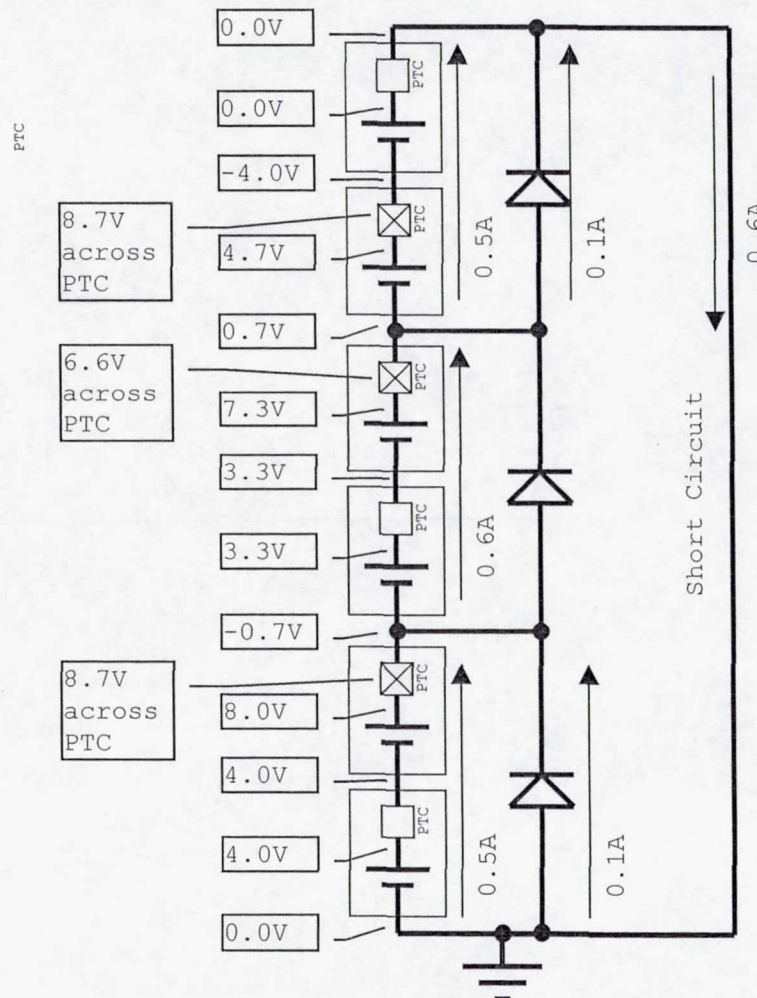
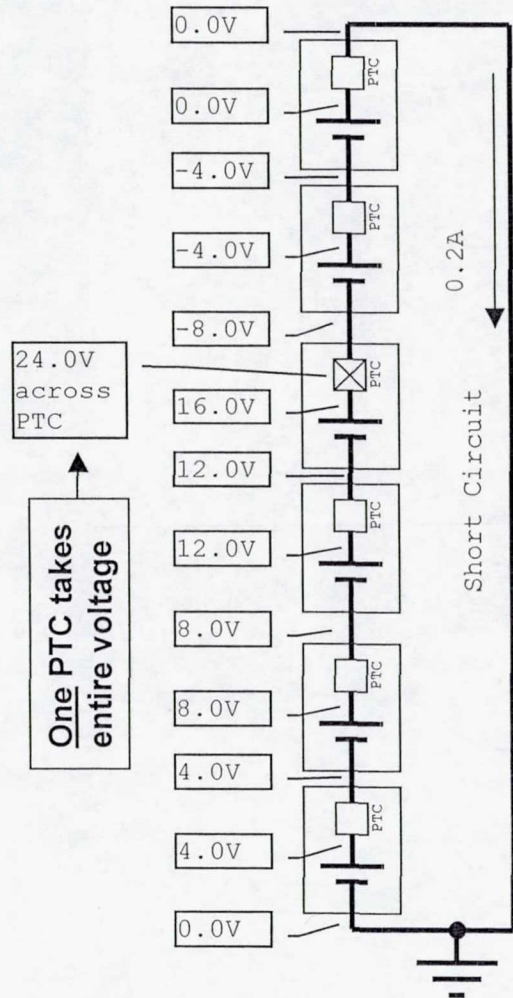
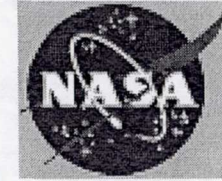

Notes:

1. Diagram has reduced number of cells for simplicity
2. If the short is removed, then no current will flow through the PTCs, and they will cool down, resetting themselves to a low impedance state.
3. Diodes allow PTCs to share the voltage, thus reducing voltage stresses on PTCs.
4. Scheme only works for discharge current, not charge current.

Short circuit testing successful

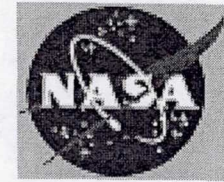

- Result of short circuit on 41S battery with diodes was no damage to cells or performance.

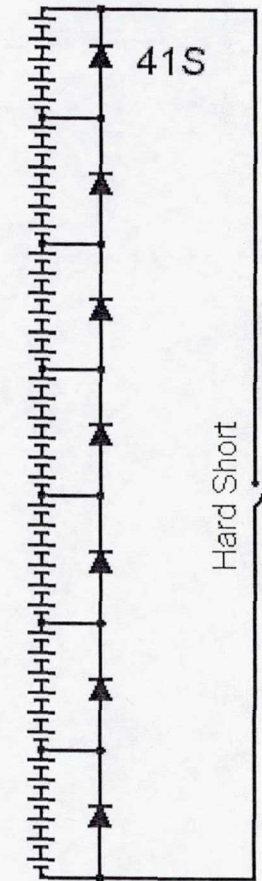
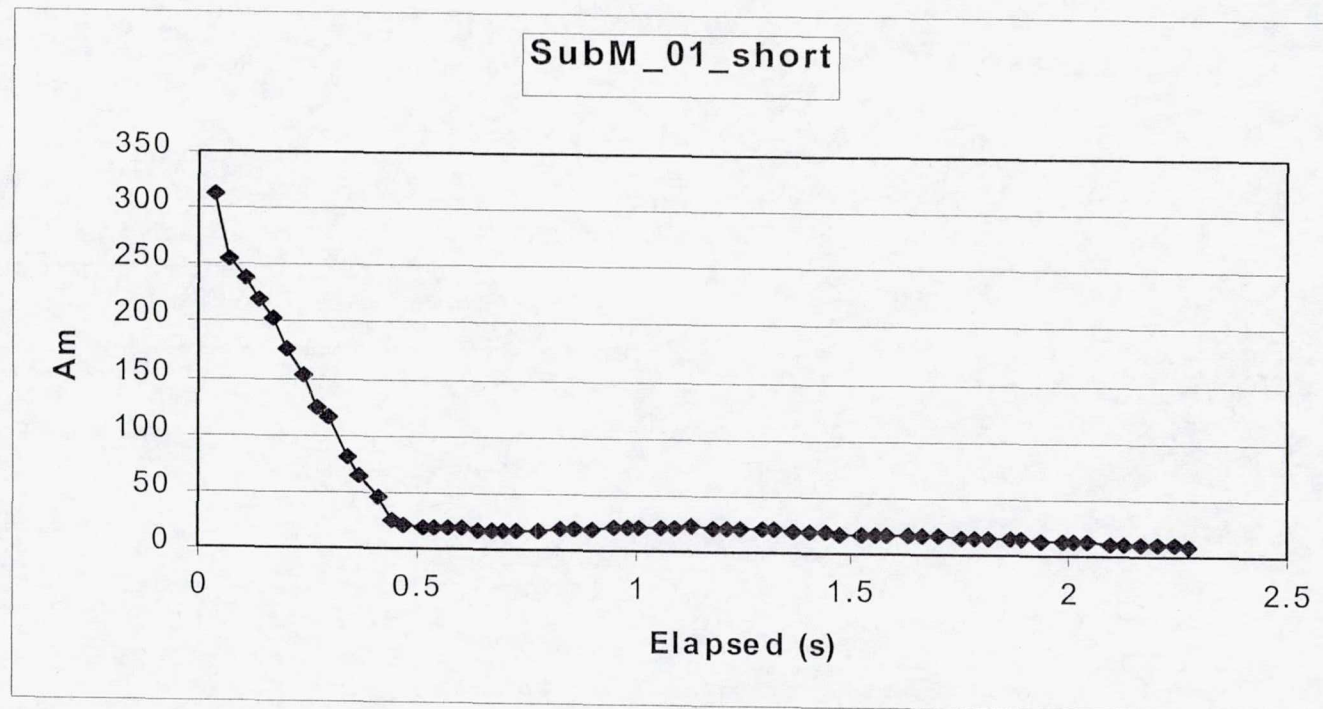

Test with diodes failed short



Sequence of events:

1. Set power supply to 211V (48 cells, 4.4V per cell) to simulate other parallel strings
2. Shorted diodes with switches. Cells started to charge with 4A (power supply in current limit)
3. PTC activated and diode voltage rating exceeded (12 cells at 4.4V=52.8V, diode rated at 45V). First diode failed.
4. Diodes continue to fail due to over-voltage as PTCs trip.
5. CIDs open due to over-charge.
6. At least one cell over-heats. Other cells enter thermal runaway.

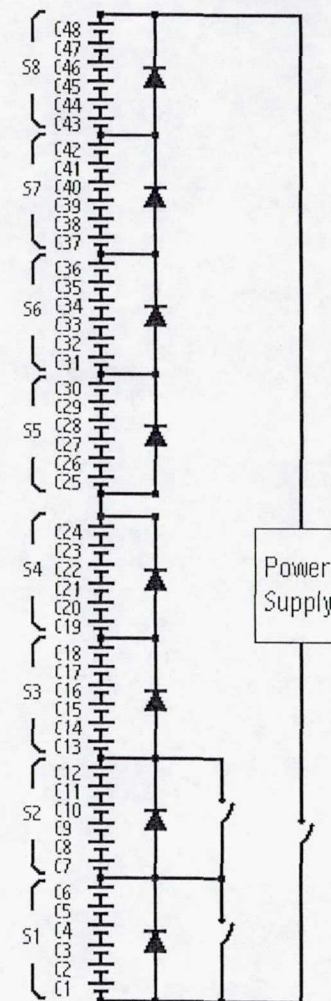
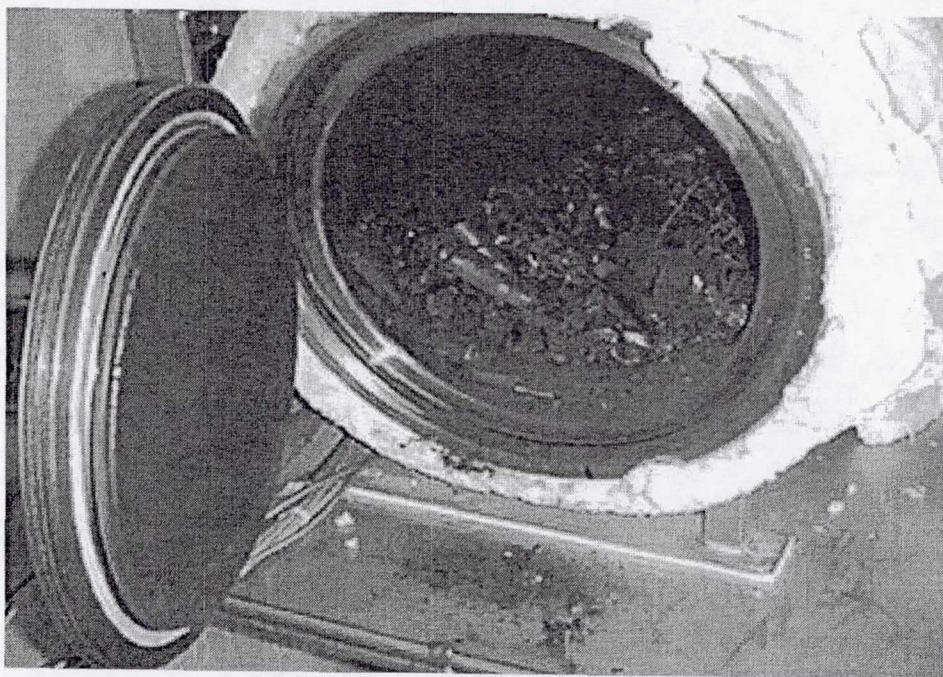

Conclusions

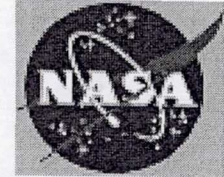

- COTS Li-Ion cells can not be used in high voltage batteries safely without considering the voltage stresses that may be put on the protective devices in them
- Diode scheme reduces voltage stress on PTCs during short circuits.
- CID needs more testing to spot if arcing is a possibility when CIDs open in a faulted high voltage battery.