

Abstract for Advanced Hydraulic Power System (AHPS) Upgrade

April 16, 2004, AIAA Annual Technical Symposium

Brad Irlbeck NASA Johnson Space Center 281-483-8617 bradley.w.irlbeck@nasa.gov

March 2, 2004

Three Auxiliary Power Units (APU) on the Space Shuttle Orbiter each provide 145 hp shaft power to a hydraulic pump which outputs 3000 psi hydraulic fluid to 41 hydraulic actuators. A hydrazine fuel powered APU utilized throughout the Shuttle program has undergone many improvements, but concerns remain with flight safety, operational cost, critical failure modes, and hydrazine related hazards.

The advanced hydraulic power system (AHPS), also known as the electric APU, is being evaluated as an upgrade to replace the hydrazine APU. The AHPS replaces the high-speed turbine and hydrazine fuel supply system with a battery power supply and electric motor/pump that converts 300 volt electrical power to 3000 psi hydraulic power. AHPS upgrade benefits include elimination of toxic hydrazine propellant to improve flight safety, reduction in hazardous ground processing operations, and improved reliability. Development of this upgrade provides many interesting challenges and includes development of four hardware elements that comprise the AHPS system:

Battery – The battery provides a high voltage supply of power using lithium ion cells. This is a large battery that must provide 28 kilowatt hours of energy over 99 minutes of operation at 300 volts with a peak power of 130 kilowatts for three seconds.

High Voltage Power Distribution and Control (PD&C) – The PD&C distributes electric power from the battery to the EHDU. This 300 volt system includes wiring and components necessary to distribute power and provide fault current protection.

Electro-Hydraulic Drive Unit (EHDU) – The EHDU converts electric input power to hydraulic output power. The EHDU must provide over 90 kilowatts of stable, output hydraulic power at 3000 psi with high efficiency and rapid response time.

Cooling System – The cooling system provides thermal control of the Orbiter hydraulic fluid and EHDU electronic components.

Symposium presentation will provide an overview of the AHPS upgrade, descriptions of the four hardware elements, and a summary of development results to date.



Space Shuttle Upgrades Advanced Hydraulic Power System

**April 16, 2004 AIAA Annual Technical Symposium
In Houston, TX**

Brad Irlbeck - NASA Johnson Space Center Energy Systems Division
281-483-8617 bradley.w.irlbeck@nasa.gov



Hydrazine APU



Orbiter Hydrazine APU Description

Hydrazine APU Used Throughout the Shuttle Program to Power Hydraulic Systems

- Operates During Ascent, On-Orbit Flight Control System Checkout, and Descent
- Converts Chemical Hydrazine Fuel to Shaft Power to Drive a Hydraulic Pump
 - Catalytic Reaction Drives a High Speed Turbine; Speed Reduced to Hyd Pump via a Gearbox

Three Hydraulic Systems Distributed Throughout the Orbiter Power Hyd Actuators

- Variable Displacement, Piston Pump Converts APU Shaft Power to 3000 psi / 69 gpm Fluid Power (120 hp max)
- Hydraulic Power Distributed to 41 End Effectors

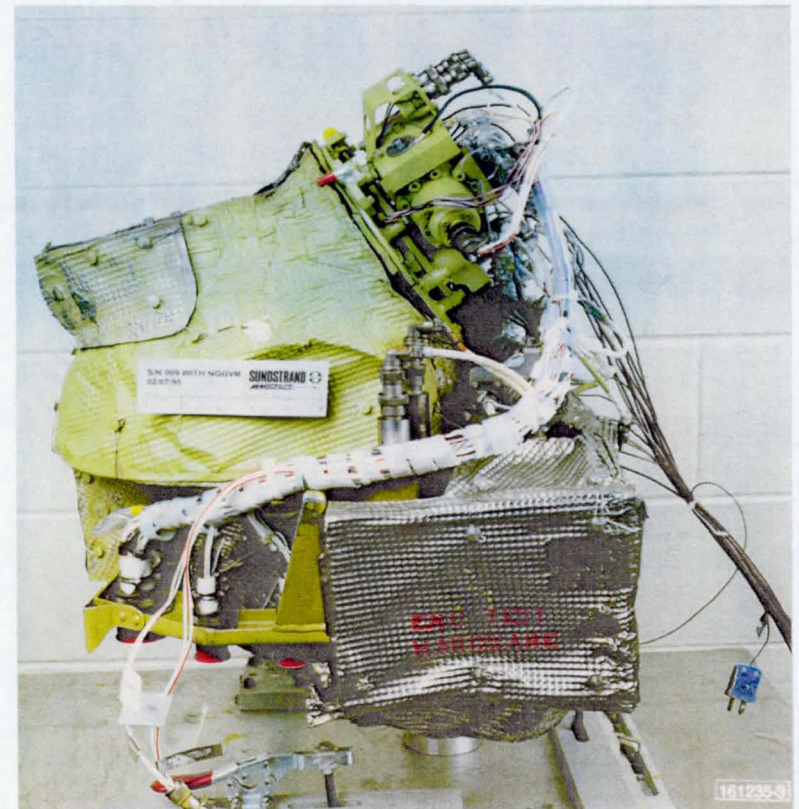
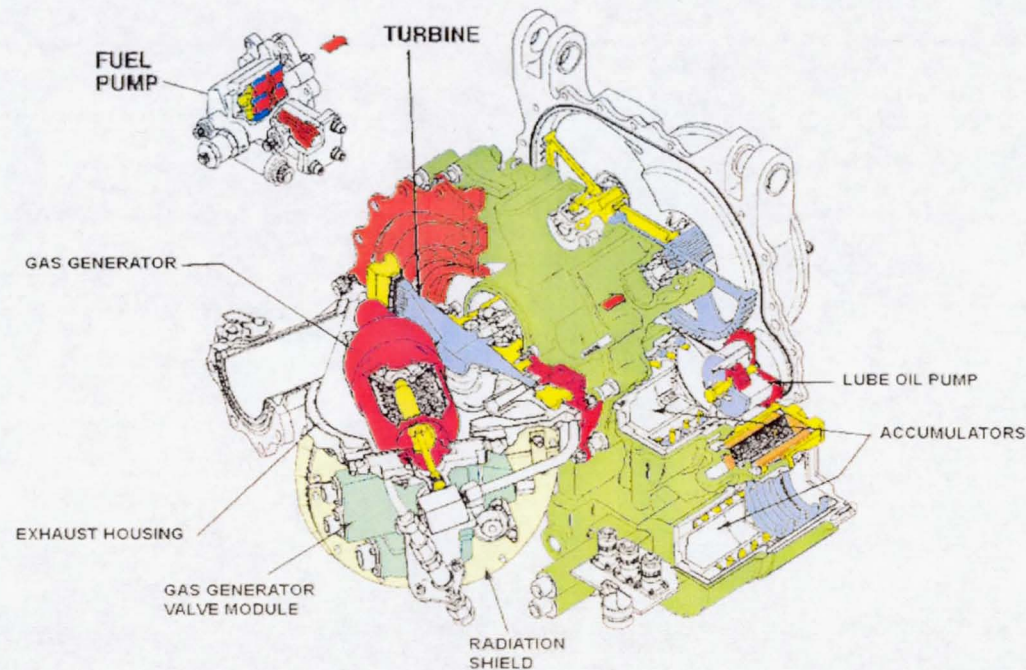



Hydrazine APU Has Safety Risks

Flight Safety Risks

- Hydrazine APU Analysis Shows a 1 in 809 Risk for Loss of Crew / Vehicle
 - 17 Hazards
 - 24 Crit 1 CILs
- } *Applicable Items from APU, WSB, Flight Control, Integrated*
- Hydrazine APU Risk Areas
 - Hydrazine Fire and Explosion
 - Corrosive Agent
 - Hot Exhaust Gas Leak
 - Material Compatibility
 - Hot Ignition Sources
 - 74,000 rpm Turbine
 - Hot Restart Ignition

Ground Safety Risks

- Safety Hazards Associated With Hydrazine
 - Toxicity
 - Corrosion
 - Ignition



Advanced Hydraulic Power System (AHPS) Upgrade



AHPS Upgrade Selected to Address Hydrazine APU Risks

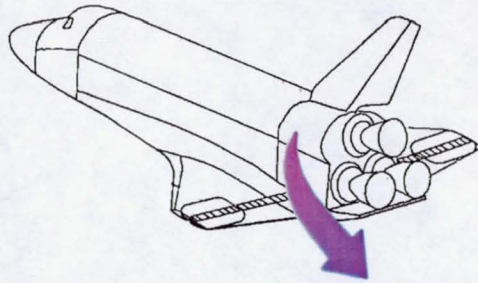

Replace Orbiter Hydrazine APU & Fuel Supply System with Electric Motor and Battery Power Supply

3 APUs in Orbiter Aft Fuselage Supply Power to Hydraulic System

AHPS Upgrade

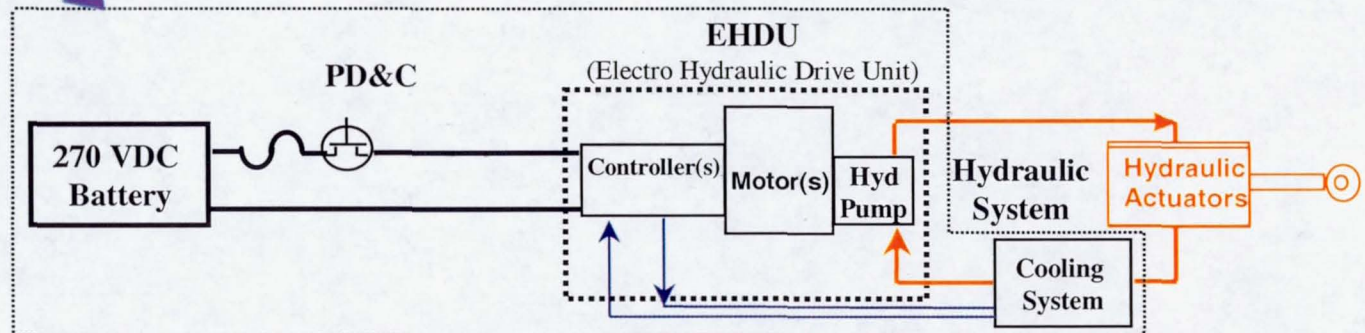

Current Hydrazine APU

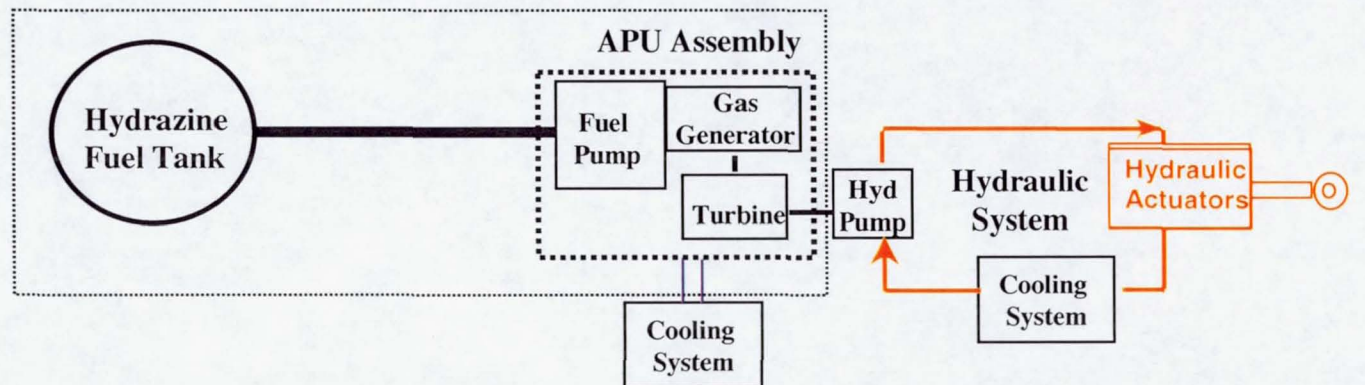



AHPS Contains 4 Major Hardware Elements

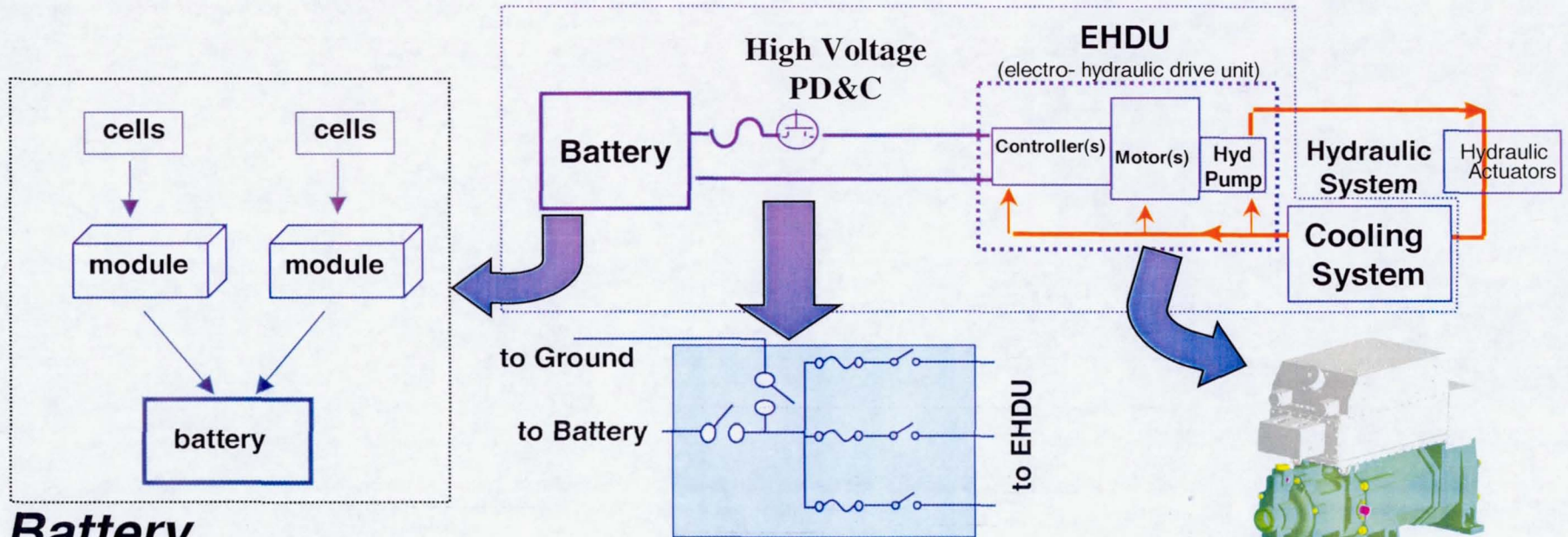

Battery

- Power source providing 130 kW and 230-360 VDC
- Includes cells, protection diodes, structure, wiring



PD&C

- High voltage power distribution to the EHDUs
- Includes contactors, fuses, wires, sensors

Cooling

- Provide hydraulic and electronics cooling
- Modified water spray boiler

EHDU

- Provides hyd supply pressure / flow
- Includes controller, inverter, motors, pumps (2)



AHPS Development History

- **Selected Electric APU as APU Replacement Concept in 1998 with Initial Requirements Set Aggressively to Maximize Benefits**
- **Advanced Development Included a Significant Amount of Hardware and Testing**
 - FY01 Integrated System Testing Completed Showing that the Design Solution Meets Requirements
- **As Advanced Development Matured thru 2001, Weight & Battery Technology Risks Threatened Viability of the Project and an Over Designed System Reflected Excessive Implementation Costs**
- **NASA Deferred Implementation in FY01 & Funded a FY02 Technology Risk Reduction Effort**
 - Allowed the Team to Step Back and Re-Consider the Real Requirements and Applicable Design Solution Options for Meeting the Top Level Goals
- **As a Result, a New Architecture was Identified with Reduced Complexity, Energy Demand, Weight, & Cost, but Still Achieving Safety Benefits**
 - Renamed from EAPU to AHPS to Reflect the New Architecture
- **FY03 Shuttle Service Life Extension Program (SLEP) Recommended to Proceeding**
- **FY04 Effort Authorized to Complete Development Through an Implementation Decision Point**



AHPS Key System Requirements

Requirements Documents

Program Requirements Document (PRD) NSTS 37342

System Requirements Document (SRD) NSTS 47002

Key Technical Requirements

Design Timeline	99 minute timeline with 1 of 3 AHPS subsystems failed
Weight	5150 lb max. (2000 lbs above hydrazine APU)
Flight Control	Transparency in hydraulic output to the actuators
Hyd Output Flow	2 to 70 gpm
Hyd Output Pressure	2900 – 3150 psi Steady State, 2400 – 4050 Transient
Hyd Response	0.080 sec response / 0.180 sec transient
DC Voltage	230 – 360 VDC
DC Power Peak	130 kw for 3 seconds
Battery Energy	28 kw-hr
Life	50 missions except 8 mission / 3 years for the battery
Reliability	0.99995 single mission reliability (1 in 20,000)
Fault Tolerance	2 fault tolerant system, single fault tolerant subsystem (2 of 3 AHPS systems needed for safe landing)



AHPS Benefits

Eliminates Hydrazine APU Risk Areas

- Hydrazine Fire and Explosion
- Hot Spots
- Corrosive Agent
- Hot Exhaust Gas Leak
- Turbine Wheel Structural Failure

Eliminates the Single Largest Risk to Orbiter Flight Safety

- Eliminates toxic hydrazine propellant; driver to hydrazine APU risk
- Reduces APU's contribution to Orbiter risk from 30% to 5%
- Crit 1 CILs reduced from 24 to 6
- Reduces hazards from 17 to 13; 6 causes eliminated

Supports Long Term Consideration of Shuttle Flights Well into 21st Century

- Hydrazine APU design uniqueness, hardware age, and limited supplier activity provide a threat to long term supportability
- AHPS will alleviate supportability concerns and increase hardware life – 75 hour operating limit and long term hydrazine exposure effects

Improves KSC Ground Turnaround Effort

- Eliminates toxic propellant handling and hazardous waste production

Develops Technology Applicable to Next Generation Vehicle



AHPS Development Testing



Hardware Tested for Each of the 4 AHPS Hardware Elements

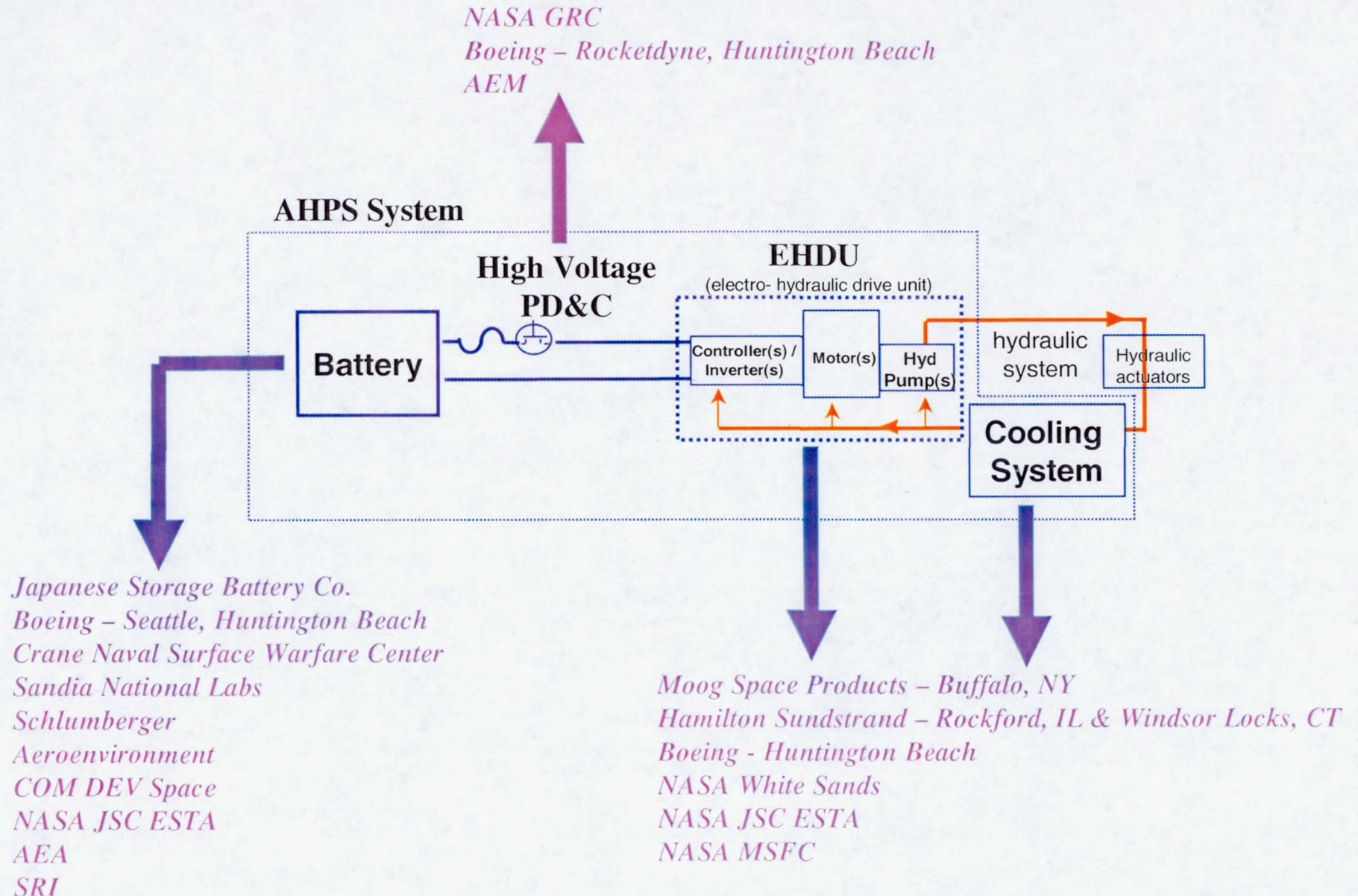



Testing has Matured Hardware Designs



2 Battery Concepts Tested

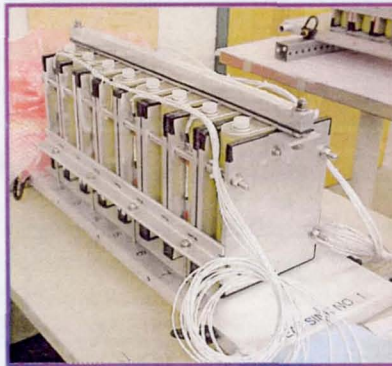

2 EHDU Concepts Tested

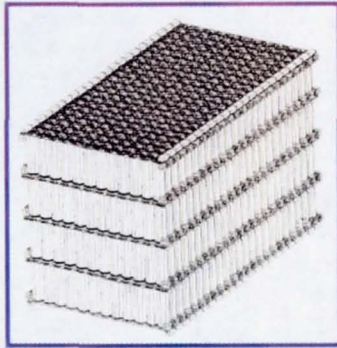

Complete System Tested

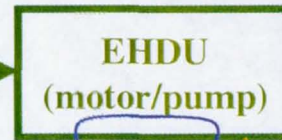
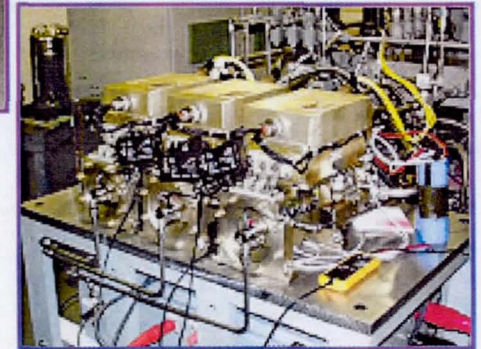

Hyd System



PD&C Concept Tested



2 Cooling Concepts Tested

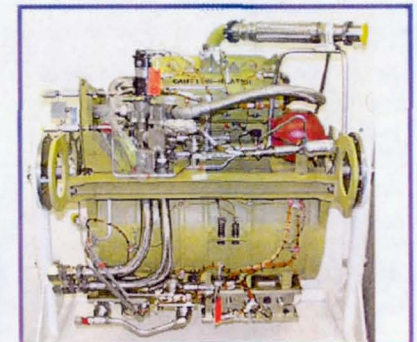



2 EHDU Solutions Evaluated (full size prototypes tested for each)

Hamilton Sundstrand

3 Channel Architecture for each EHDU

Output from 3 Hydraulic Pumps Summed

- Variable Speed with Variable Displacement Pumps
- 2 Channels Together Provide 70 gpm Flowrate

3rd Channel Provides Redundant Leg & Extra Flow for 90 gpm Single APU enhancement

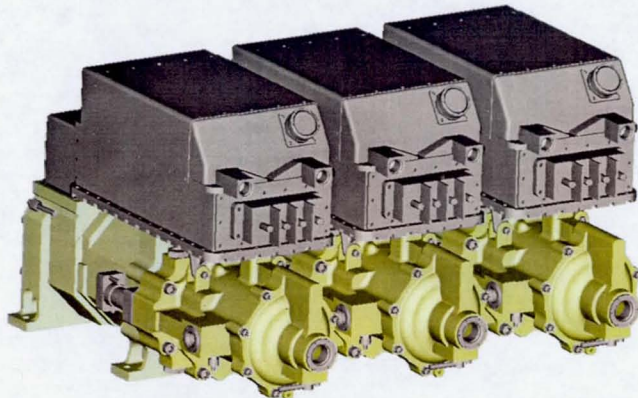
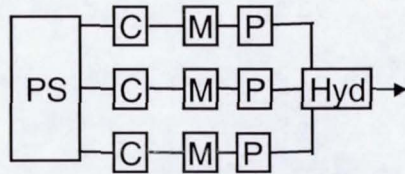

Concept Selected Based on Test Results

Boeing Phantom Works

3 Channel Architecture for each EHDU

Output from 3-in-1 SEMA Motor Summed to Single Shaft

- Constant Speed with Variable Displacement Pump (Orbiter)
- Two Speed Levels for 70 or 90 gpm Modes

Provides Parallel Channels at Controller / Motor Level to Meet Redundancy Requirement

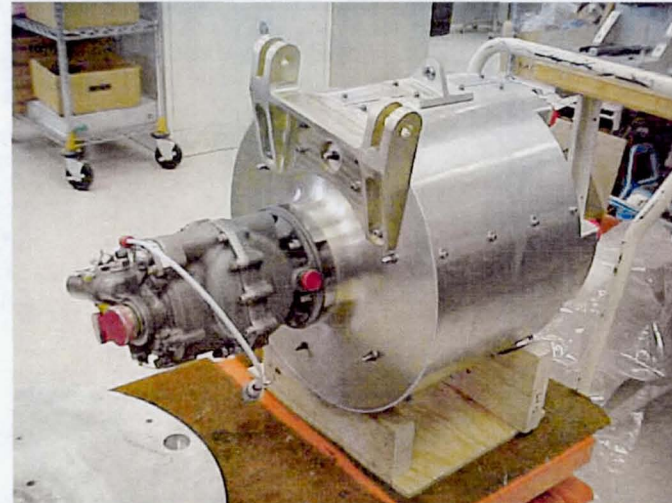
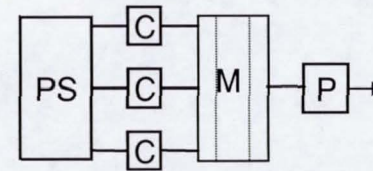



2 Cooling System Solutions Evaluated

Hamilton Sundstrand

Modified Water Spray Boiler Provides Cooling

- Water Spray Cooling of Hydraulic Fluid
- Recirculating Water Cooling of Electronics

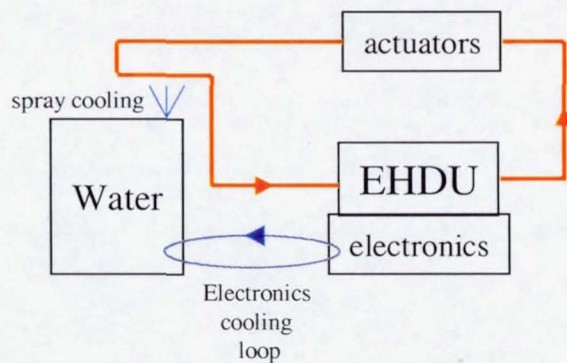

Boeing Phantom Works

Phase Change Heatsinks Provides Cooling

- Large Heatsink for Cooling of of Hydraulic Fluid
- Individual Heatsinks for Cooling of Electronics

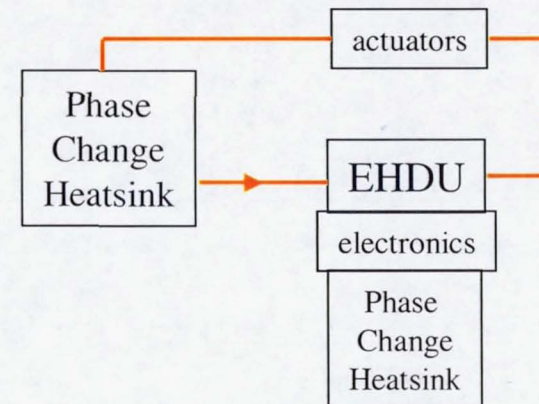

Hamilton Sundstrand Modified Water Spray Boiler Selected

- Selection driven by weight, re-use of existing components, and cost
- Also, more flexible because it is adaptable to either EHDU concept



2 Battery Solutions Evaluated

Large Cell Battery

- Single string of large capacity cells
- 190 Ah MELCO/JSB lithium ion cell developed and tested extensively in 01.
- Requirements reduction allowed reduction to a battery consisting of 82, 120 Ah cells.
- Limited testing of the 120 Ah shows excellent performance

Small Cell Battery

- Multiple parallel strings of low capacity, commercial cells
- Initially pursued as a single mission battery, but cost drove design to a 3 year battery
- 41S-5P submodules developed at ComDev and tested extensively in 03 (Sony 18650, hard carbon cells)



VS





Hamilton Sundstrand EHDU Test Articles

*EHDU
Module*

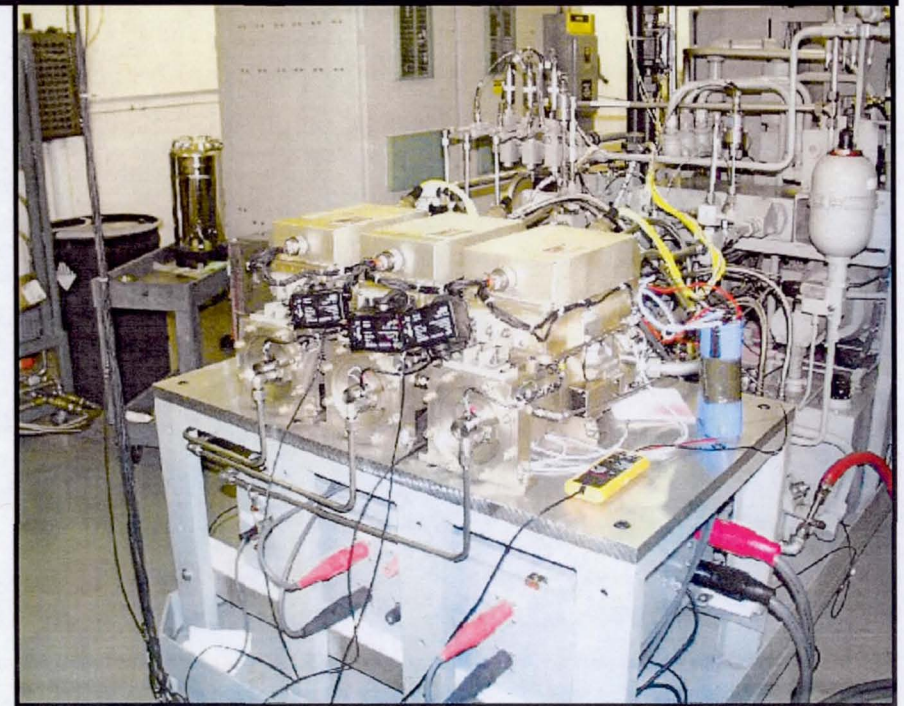
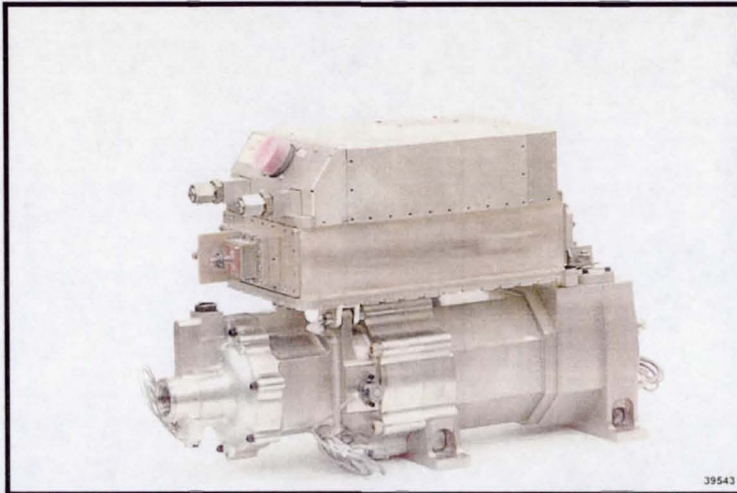

EHDU in Test at Hamilton Sundstrand

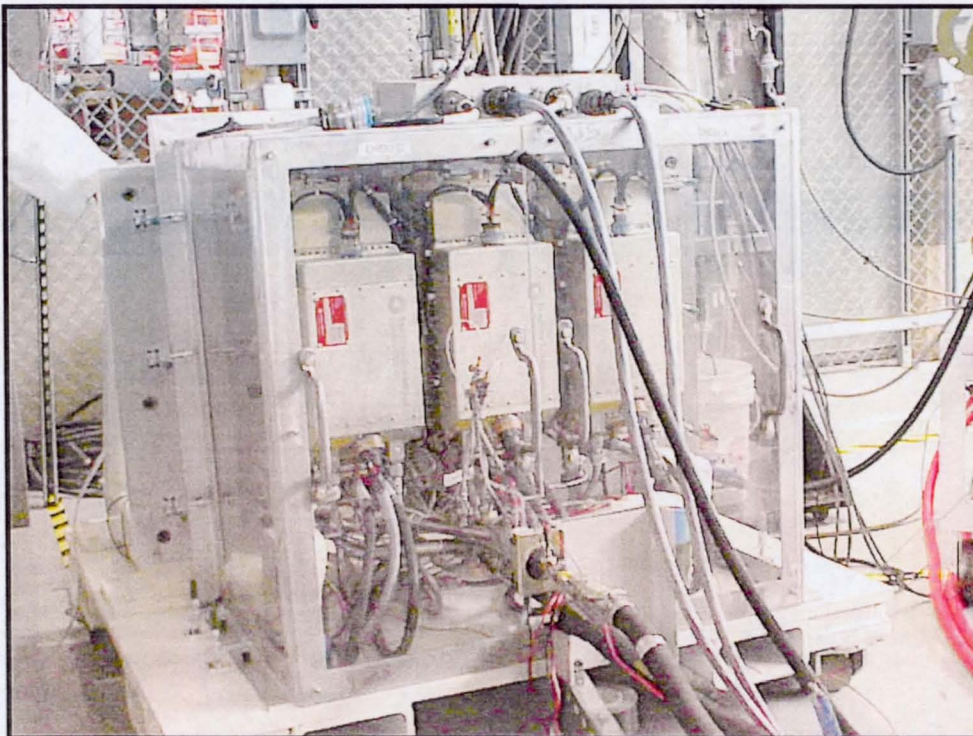

EHDU in Test at Boeing

Hamilton Sundstrand EHDU

*Power
Module*

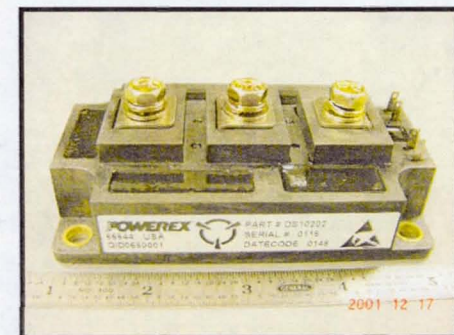



Hamilton Sundstrand Modified Water Spray Boiler Test Articles

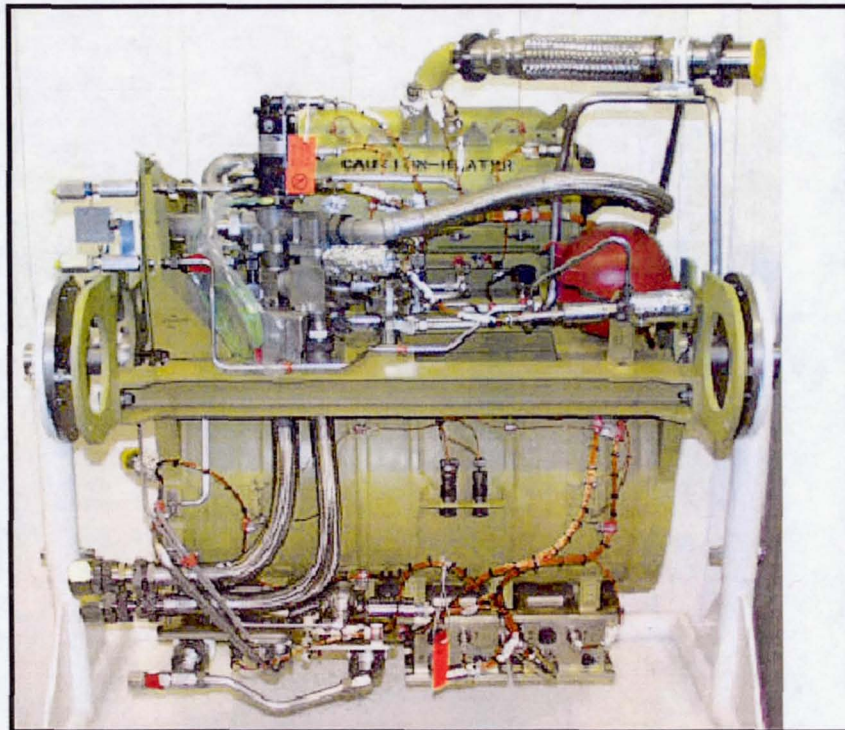

MWSB in Test at Hamilton Sundstrand

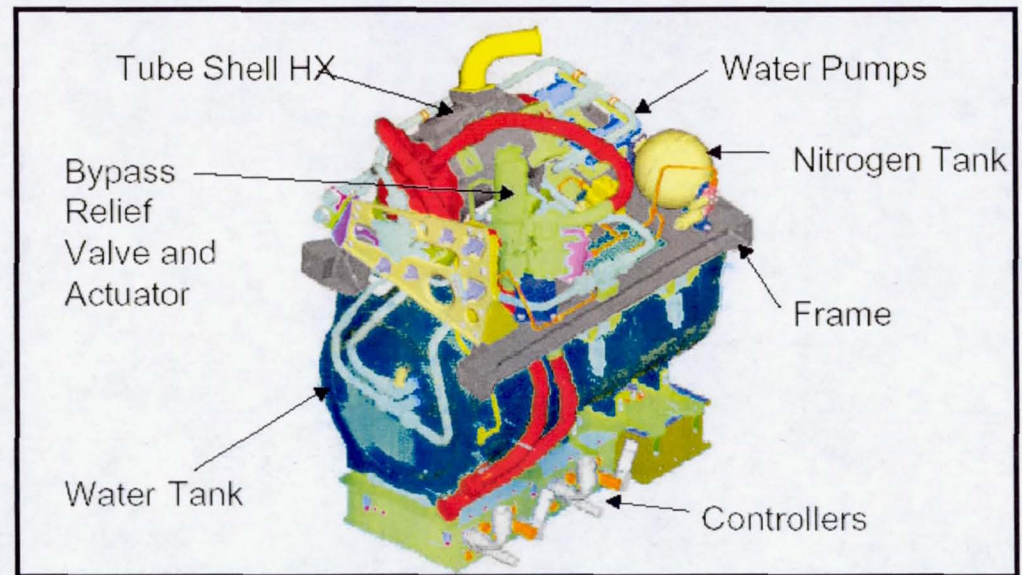



Boeing Phantom Works EHDU Test Articles

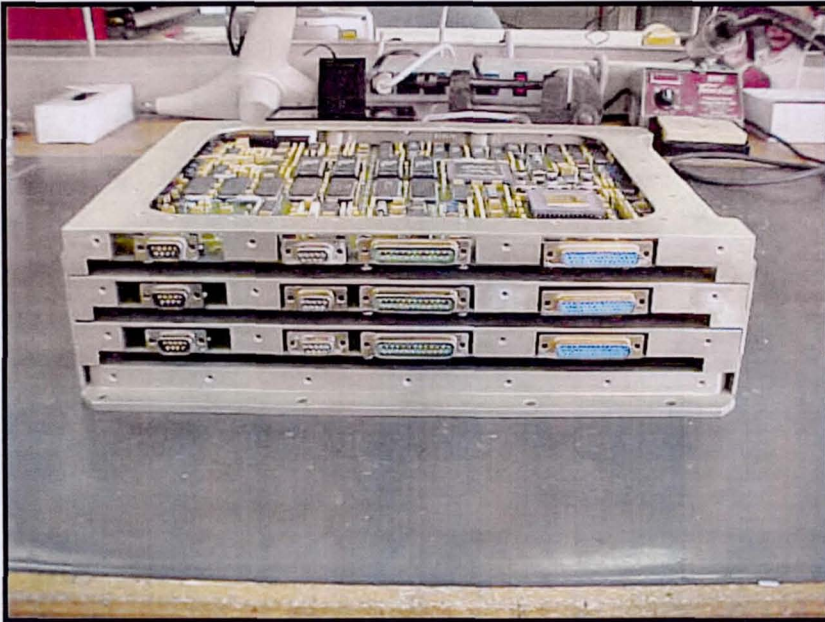

Motor Control Unit



EHDU

*Hydraulics
Cooling
Heatsink*

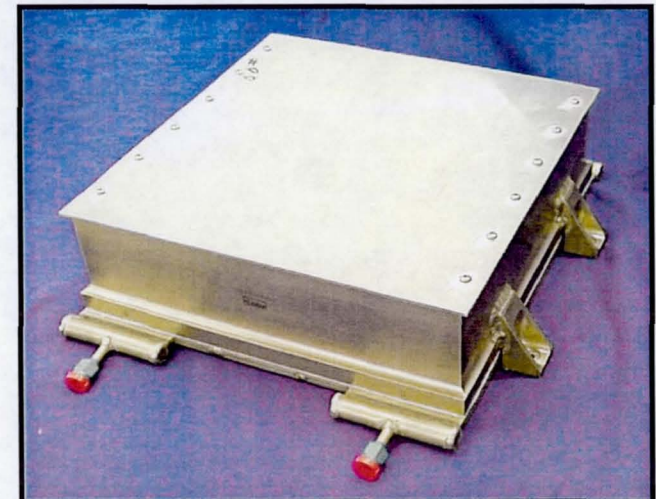
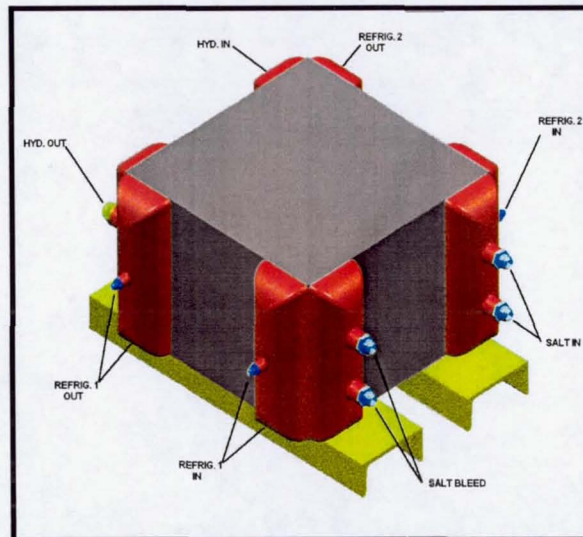

Electronics Cooling Heatsink



Large Cell Battery Test Articles

*Battery
Module In
Assembly*

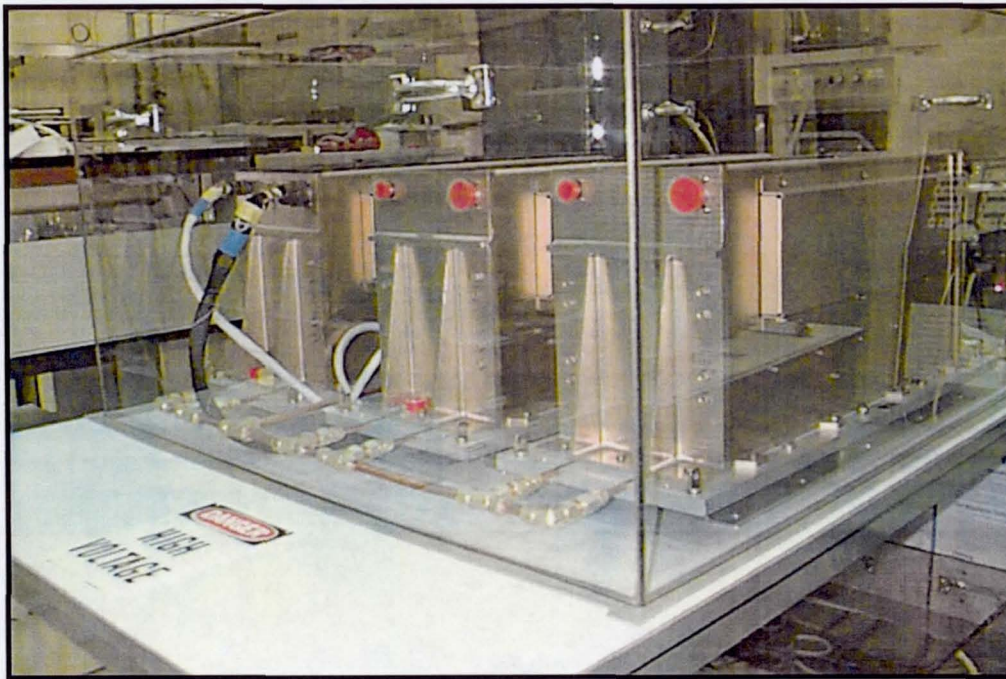
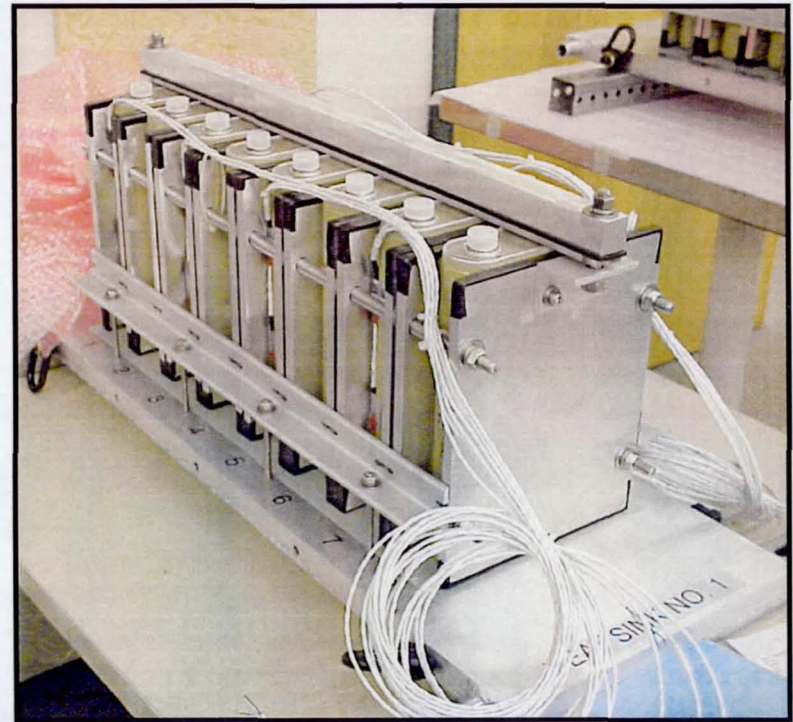

Battery Modules in Seattle

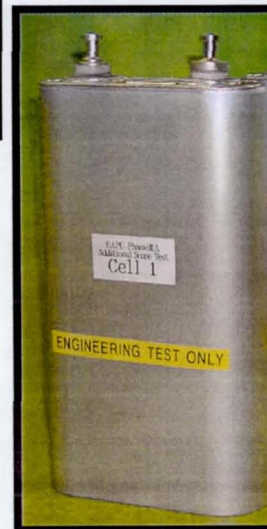

*MELCO JSB
120 Ah Cell*



MELCO JSB 190 Ah Cell



ComDev Small Cell Battery Test Articles



Sony 18650 Cells

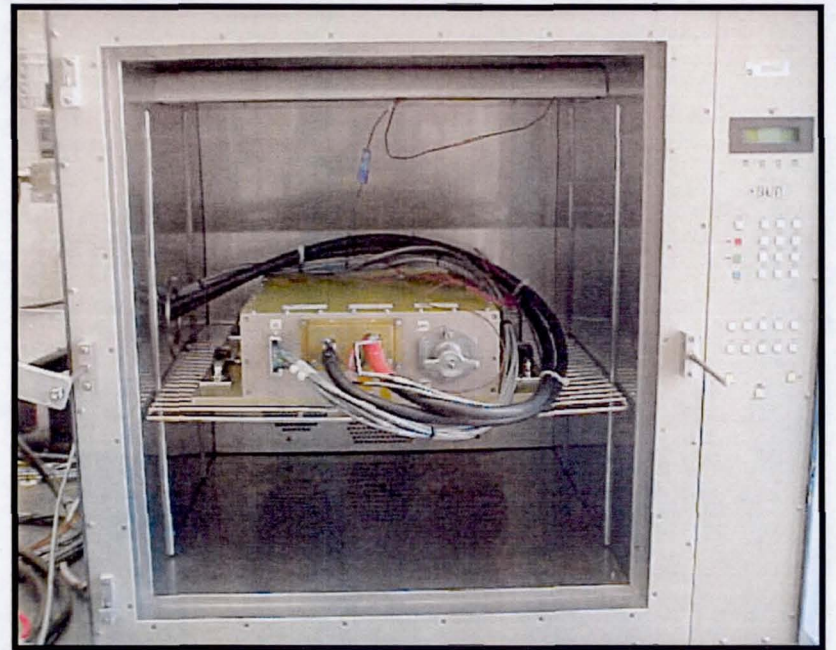

*Engineering Unit
Submodule In JSC Test*



*Engineering
Unit
Submodule*



Concluding Remarks

- **AHPS has Successfully Completed a Significant Amount of Development That Shows the Design Solutions Meet Requirements**
- **Upgrade Maturity is High Relative to Some Other Candidate Upgrades**
- **AHPS Does Provide a Flight Safety Improvement**
- **Early in FY05, All Needed Data Would Be Available for a Program Implementation Decision If the Safety Improvement is Worth the Cost and Risk**
- **February 04 SLEP Summit Concluded that AHPS Implementation Schedule is Not Compatible with the President's 2010 Shuttle Goal**
 - Project Shutdown is Currently in Progress
 - AHPS Technology Can Be Applicable to a "New Spacecraft" Pending Results from Their Vehicle Architecture Trade Studies.