

# Vertical Drop Testing and Analysis of the WASP Helicopter Skid Gear

Yvonne T. Fuchs and Karen E. Jackson

[Yvonne.T.Fuchs@nasa.gov](mailto:Yvonne.T.Fuchs@nasa.gov) and [Karen.E.Jackson-1@nasa.gov](mailto:Karen.E.Jackson-1@nasa.gov)

NASA Langley Research Center  
Hampton, VA 23681-2199

## Abstract

Human occupant modeling and injury risk assessment have been identified as areas of research for improved prediction of rotorcraft crashworthiness within the NASA Aeronautics Program's Subsonic Rotary Wing Project. As part of this effort, an experimental program was conducted to assess the impact performance of a skid gear for use on the WASP kit-built helicopter, which is marketed by HeloWerks, Inc. of Hampton, Virginia. Test data from a drop test at an impact velocity of 8.4 feet-per-second were used to assess a finite element model of the skid gear test article. This assessment included human occupant analytic models developed for execution in LS-DYNA. The test article consisted of an aluminum skid gear mounted beneath a steel plate. A seating platform was attached to the upper surface of the steel plate, and two 95th percentile Hybrid III male Aerospace Anthropomorphic Test Devices (ATDs) were seated on the platform and secured using a four-point restraint system. The goal of the test-analysis correlation is to further the understanding of LS-DYNA ATD occupant models and responses in the vertical (or spinal) direction. By correlating human occupant experimental test data for a purely vertical impact with the LS-DYNA occupant responses, improved confidence in the use of these tools and better understanding of the limitations of the automotive-based occupant models for aerospace application can begin to be developed.

## Introduction

Since its inception in 2006, the Rotorcraft Crashworthiness task under the NASA Aeronautics Program's Subsonic Rotary Wing (SRW) Project has focused attention on two main areas of research: development of an externally deployable energy absorbing concept and improved prediction of rotorcraft crashworthiness [1]. The energy absorber being developed is a composite honeycomb structure that can be externally deployed to provide energy attenuation, much like an external airbag system [2]. The second main research area relates to crash modeling and simulation. Several research topics have been identified to achieve improved prediction of rotorcraft crashworthiness, including: fundamental materials characterization, human occupant modeling and injury prediction, multi-terrain impact simulation, development of fully integrated simulation models, and validation studies that focus on probabilistic analysis and uncertainty quantification. In order to pursue the research to improve analytical prediction of rotorcraft crashworthiness, NASA requires relevant experimental data.

In 2007, HeloWerks, Inc. of Hampton, VA approached NASA to conduct a test evaluation program on a

skid gear design for their HX-2 WASP, a 1,000-lb. gross weight kit-built two-seat helicopter fabricated using monocoque composite sandwich construction. The helicopter is 19-ft. long, 9-ft. high, and 7-ft. wide at the skids. A photo of the helicopter is shown in Figure 1. During a flight demonstration of the prototype aircraft, the pilot inadvertently shut off the engine during hovering flight resulting in a crash. As a result of the impact, the pilot experienced severe back injuries. The flight demonstration aircraft was outfitted with a composite skid gear that was designed for energy absorption. However, during the actual crash, the skid gear snapped and failed, absorbing very little crash energy. This accident led HeloWerks engineers to redesign the helicopter's skid gear and to approach NASA to conduct a test evaluation program to meet the Federal Aviation Regulation (FAR) crash energy absorption requirements for FAA certification [3].



Figure 1. Photograph of the HX-2 WASP helicopter with original skid gear.

---

Presented at the American Helicopter Society 64<sup>th</sup> Annual Forum, Montreal, Canada, April 29 – May 1, 2008. This paper is a work of the US Government and is, therefore, in the public domain.

Simulation of the HeloWerks redesigned skid gear provided an opportunity for NASA to evaluate current occupant modeling capabilities within LS-DYNA [4] using vertical impact test data from a fairly simple test article. Helicopter crashworthiness is unique in the crash industry due to the large vertical component of acceleration that is transmitted to the occupants. In contrast, frontal and side accelerations are much more predominant in the automotive crash environment. The automotive industry has made a tremendous investment into developing finite element models of Anthropomorphic Test Devices (ATDs) commonly used in automotive crash testing.

Note that although the LS-DYNA models are referred to as human occupant models, they are truly modeled after the standards set forth for ATDs, which themselves are physical models meant to mimic human responses. There are also differences between the physical ATDs available for automotive use and aviation use. Automotive ATDs have a curved spine; Aerospace ATDs have a vertical spine to allow for load cells to measure lumbar loads. The development of Aerospace ATDs was driven by ejection seat testing, thus necessitating the ability to modify a standard automotive ATD to measure for vertical accelerations and loading [5]. However, very little research has been done to determine what, if any, refinements are needed to commercially available analysis models of automotive ATDs for aerospace applications.

To pursue this mutually beneficial program, a cooperative agreement was developed between HeloWerks, Inc. and NASA Langley Research Center [6]. As part of this program, HeloWerks designed and fabricated the test articles. NASA instrumented the test articles, performed the vertical drop tests, and shared all test information with HeloWerks.

### Experimental Program

The complete details of the test program evaluating HeloWerks skid gear designs are documented in Reference 7. Out of all of these tests, the 8.4-fps impact test of the final skid gear design was selected to evaluate the human occupant response models in LS-DYNA. A short overview of the experimental program focusing on results from this particular test is included in this paper for reference in the test-analysis correlation discussion to follow.

As mentioned previously, the original skid gear used on the WASP helicopter was a composite design that did not function as intended in an actual crash. The gear was redesigned based on the work reported in Reference 8. The redesigned gear was fabricated using aluminum

circular cross-section tubes; the tubes were reinforced at the crossbeam attachments using 4130 steel sleeves and at the intersection with the skid beams using saddles to prevent premature collapse and local buckling of the gear. The fully instrumented test article, shown in Figure 2, weighed 1,064 lb, including 320 lbs of ballast and 450 lbs for the two 95th percentile Hybrid III male Aerospace ATDs. The test article consisted of the redesigned skid gear mounted beneath a steel plate, a seating platform attached to the upper surface of the steel plate, and two 95th percentile Hybrid III male Aerospace ATDs seated on the platform and secured using a four-point restraint system. Ballast weights were mounted to the test article to ensure the correct position of the Center-of-Gravity (CG). These parts are shown in Figure 3.

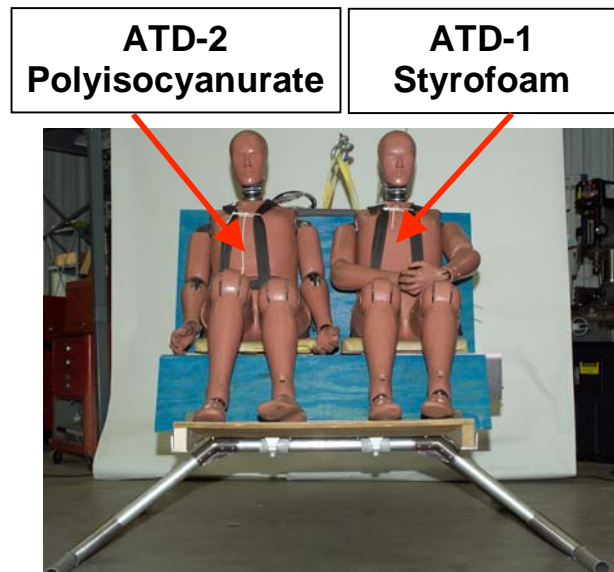

Figure 2. Front view of test article with ATD naming convention.

An opening was cut into the seat platform to allow space for seat foam filler, as shown in Figure 3(b). The foam filler space under ATD-1 was filled with several layers of Styrofoam, as shown in Figure 4(a) and 4(b). Under ATD-2, three blocks of polyisocyanurate foam were used, as shown in Figure 4(c) and 4(d), with two blocks facing forward and one intersecting block positioned laterally.

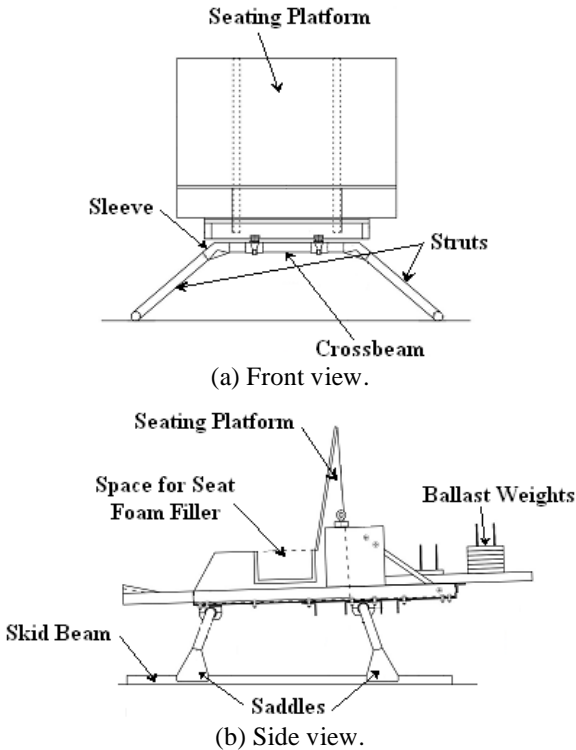

Figure 3. Schematic of the test article.

The test article and two 95<sup>th</sup> percentile Aerospace ATDs were instrumented with a total of 26 accelerometers and 2 lumbar load cells. Test data were collected at 50,000 samples per second using a digital data acquisition system. The vertical drop test was performed by attaching lifting cables to the test article, raising the test article through its CG, and then releasing the test article to impact a smooth concrete surface.

**Test Results: 8.4-fps Vertical Drop Test**

The test article was lifted to a height of 13 inches and released to impact a smooth concrete surface at 8.4-fps. Post-test measurements of permanent deformation show that the measured spread of the skid gear was 4.4 inches. No permanent deformation of either the Styrofoam stack or the polyisocyanurate foam blocks was visible post-test.

Comparisons of the two Aerospace ATD occupants' filtered vertical acceleration responses of the head, chest, and pelvis are shown in Figure 5. Data were post-processed using an SAEJ211 equivalent low-pass filter with a cut-off frequency of 33.5 Hz [9]. The peak magnitudes of the acceleration responses range from 6 to 9g. The acceleration responses of the head have the lowest magnitude (6g) and the pelvic acceleration responses have the highest magnitude (9g). Some minor differences are seen between the ATD-1 and ATD-2 acceleration responses for the head and chest;

however, both curves have similar magnitudes. ATD-2 exhibits a higher peak acceleration of 9-g in the pelvis, than seen for ATD-1 (8-g).

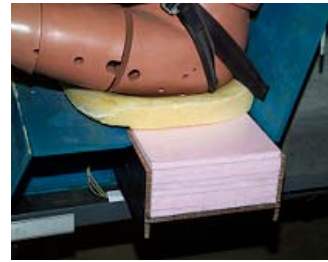

(a) Styrofoam layers (ATD-1) side view.

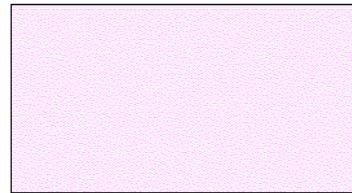

(b) Styrofoam layers (ATD-1) top view.



(c) Polyisocyanurate blocks (ATD-2) side view.

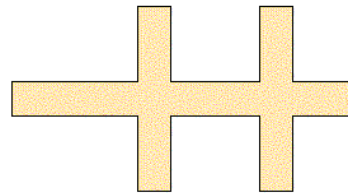

(d) Polyisocyanurate blocks (ATD-2) top view.

Figure 4. Styrofoam and polyisocyanurate foam fillers.

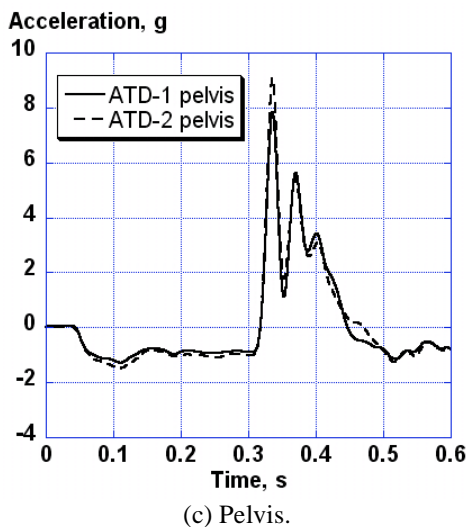
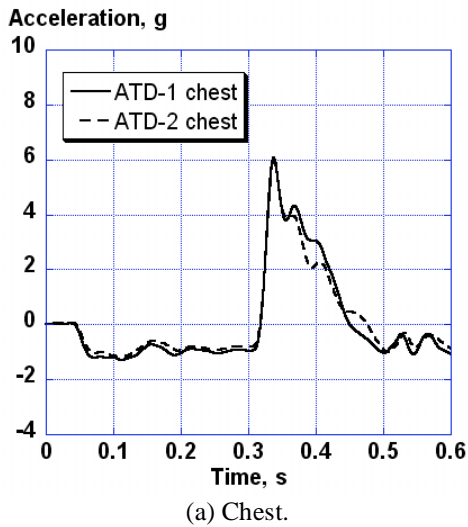
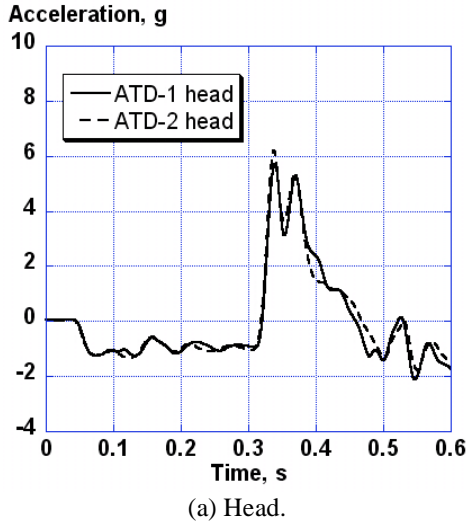

Figure 5. Occupant acceleration responses during the vertical drop test.

## Injury Assessment

The dynamic acceleration responses obtained from the instrumented Aerospace ATDs were used to perform an injury risk assessment. Several methods are typically used to evaluate human injury potential, including the Dynamic Response Index (DRI) [10-12], the Brinkley Index [13, 14], Lumbar Load limits [12], Head Injury Criteria [15, 16], and Eiband whole body acceleration tolerance limits [17, 18]. In this study, occupant injury was evaluated based on the DRI due to the fact that the ATDs only experienced significant load in the spinal direction.

The Dynamic Response Index (DRI) [10-12] is derived from a simple one-dimensional lumped-mass spring damper system, as depicted in Figure 6. This model was developed by the Air Force's Wright Laboratory to estimate the probability of compression fractures in the lower spine due to acceleration in a pelvis-to-head direction, as might be experienced by aircrew during seat ejections. Operational data from actual ejection seat incidents indicate that the spinal injury rate for maximum DRI values between 20 and 23 range from 16 to 50 percent [11, 12]. A plot showing spinal injury rate versus maximum DRI is shown in Figure 7. This plot contains operational data, as well as data calculated from cadaver tests.

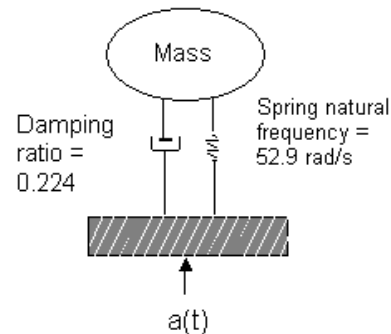

Figure 6. Schematic of the DRI injury model.

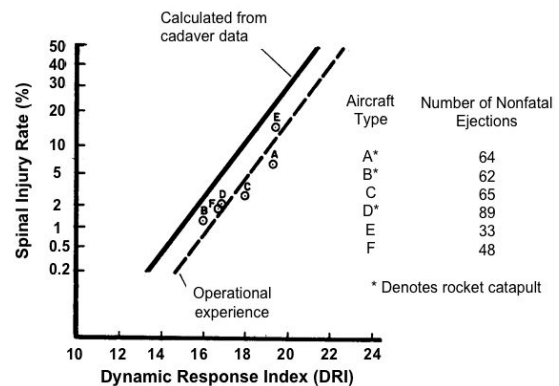
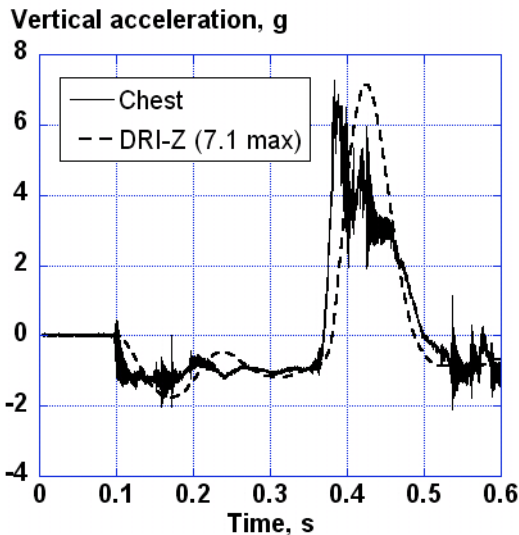
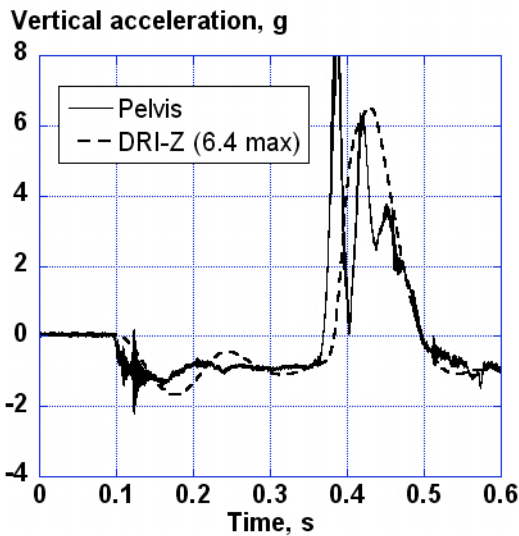

Figure 7. Plot of spinal injury rate versus maximum DRI.

The chest and pelvis acceleration responses are plotted versus the computed continuous DRI responses for ATD-1 and ATD-2 in Figures 8 and 9, respectively. The maximum DRI recorded for either of these two dummies is 7.5. This value is well below the lowest level indicative of injury, as indicated in Figure 7. Operational data from actual ejection seat incidents indicate that the spinal injury rate for a maximum DRI value of 7.5 is less than 0.2% percent (see Figure 7). Based on cadaver data, the spinal injury rate for a maximum DRI of 7.5 is also less than 0.2%.



(a) Chest responses.



(b) Pelvis responses.

Figure 8. ATD-1 acceleration and continuous DRI responses.

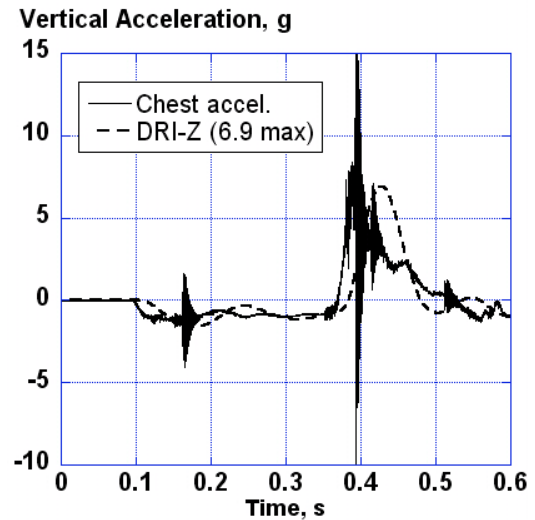

(a) Chest responses.

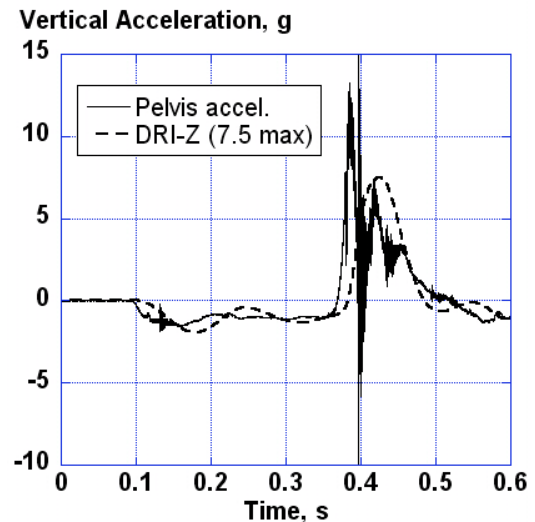

(b) Pelvis responses.

Figure 9. ATD-2 acceleration and continuous DRI responses.

### Analytical Modeling

A finite element model of the final skid gear test article including ATD occupants was developed using the commercial non-linear, explicit transient dynamic code, LS-DYNA [4]. There are four ATD occupant models available for use within LS-DYNA. Two of the models use built-in keyword formats: \*COMPONENT\_GEBOD, shown in Figure 10, and \*COMPONENT\_HYBRIDIII, shown in Figure 11. The GEBOD model is a rigid body model only, and the HYBRIDIII model is rigid with 3 deformable parts that may be activated. A user may choose to enable the three deformable parts, choosing from the head skin,

chest, and/or pelvis, which were developed for interaction with seatbelts and head strike events.



Figure 10. LS-DYNA \*COMPONENT\_GEBOD model.

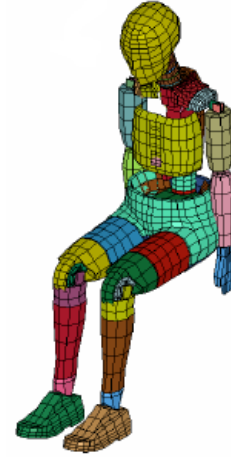

Figure 12. LS-DYNA stand-alone rigid model.

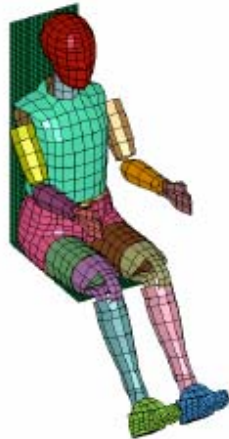

Figure 11. LS-DYNA \*COMPONENT\_HYBRIDIII model.

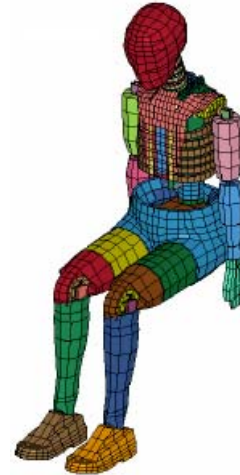

Figure 13. LS-DYNA stand-alone deformable model.

There also exists Hybrid III finite element or “stand-alone” models. There are two versions of this model. A rigid version, shown in Figure 12, is similar to the built-in \*COMPONENT\_HYBRIDIII model in that it has the same set of three deformable parts that may be activated. The deformable stand-alone version, shown in Figure 13, has many more deformable features.

The trade-offs between use of the various models include CPU and pre-processing time. Due to the fact that the built-in models are not compiled until a simulation execution, positioning the occupants correctly in a model can be a tedious, trial-and-error effort. The stand-alone models are easier to position, but are more CPU costly. For the purposes of this analytic simulation of the skid gear, the built-in \*COMPONENT\_HYBRIDIII model was selected for integration and evaluation.

The complete LS-DYNA finite element model of the modified skid gear is shown in Figure 14. The structural model consists of: 52 parts; 12,564 nodes; and 15,511 elements including 11,908 Belytschko-Tsay quadrilateral shell elements, 2,275 hexagonal solid elements, 925 beam elements, 371 seatbelt elements, and 32 lumped mass elements. Material properties were defined for the various parts including \*MAT\_PLASTIC\_KINEMATIC for 4130-steel, 6061-T6 and 2024-T6 aluminum shell elements used to represent the skid gear test platform and \*MAT\_ELASTIC for the plywood and beam elements. The seat foam fillers were represented using solid elements that were assigned a material model in LS-DYNA called \*MAT\_CRUSHABLE\_FOAM. Material characterization testing was performed to evaluate the behavior of the two seat foams, Styrofoam and polyisocyanurate. The test data were used as input for the material model. The seat foam material characterization test results are presented in Figure 15.

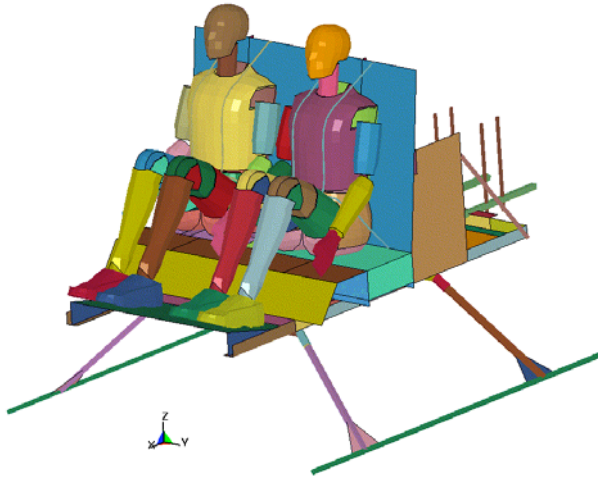
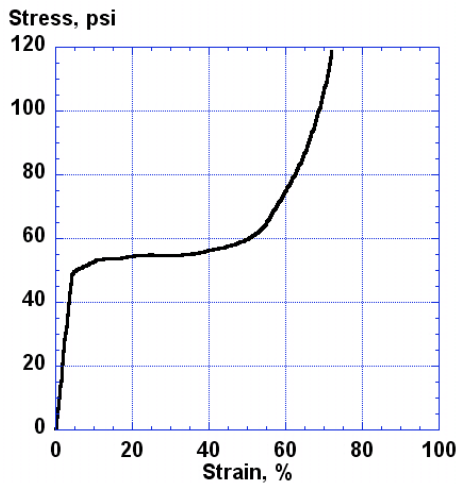
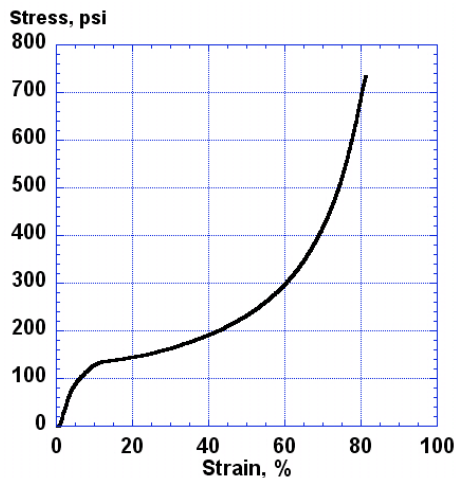

Figure 14. LS-DYNA model of the skid gear with occupants.



(a) Polyisocyanurate (ATD-2).



(b) Styrofoam (ATD-1).

Figure 15. Seat foam material characterization results.

The skid gear was modeled using circular cross-section beam elements of varying thickness. Concentrated masses were used in the model to represent the ballast weights. Two Hybrid III 95<sup>th</sup> percentile male occupants were inserted into the structural model using the \*COMPONENT\_HYBRIDIII command. These models represent the human body using rigid links, surrounded by ellipsoids, with kinematic joints that mimic the motion of the human body. Once added, the two occupants were positioned using LS-PrePost [19], a pre- and post-processing software for LS-DYNA. Beam seatbelt elements were modeled after the seatbelts used in the test article to constrain the motion of the occupant models.

Contact surfaces were defined to represent contact between the skid gear and the impact surface, between the occupants and the seatbelts, and between the occupants and the seating platform. The impact surface was modeled as a non-rigid surface and given properties of 4130-steel. The contact friction between the skid gear and impact surface was defined as 0.1. The model was executed in LS-DYNA version 971 on a Linux workstation computer with a single processor. A simulation time of 0.2 seconds required 8 hours and 50 minutes of CPU time.

#### Original Model

Comparisons of the filtered vertical acceleration responses of the pelvis and chest of the two ATD occupants with LS-DYNA analytical predictions are shown in Figures 16 and 17, respectively. Both the experimental and analytical results were filtered with a SAEJ211 equivalent low-pass filter with a cut-off frequency of 60 Hz [9]. As a reminder, ATD-1 is seated on Styrofoam and ATD-2 is seated on polyisocyanurate foam blocks.

When performing test-analysis correlation with dynamic acceleration data, three assessments are typically made: comparisons of peak acceleration, pulse duration, and pulse shape. In dynamic model test-analysis correlation, qualitative correlation with up to 15% difference is considered good correlation. For the original model, the peak accelerations correlate within an average of 7.4% for both ATD-1 and ATD-2 pelvis and chest comparisons. The time duration of the pulse matches well, but is slightly too short in the analysis data for both pelvis responses. The general behavior of the curve matches better for ATD-1 than for ATD-2. There is a strong secondary pulse shown in the analysis data for both ATD-1 and ATD-2 with an average over prediction of 92.5%. Also of note in both ATD-1 and ATD-2 chest correlation is that the analysis shows a slight onset rate delay as compared to the test response.

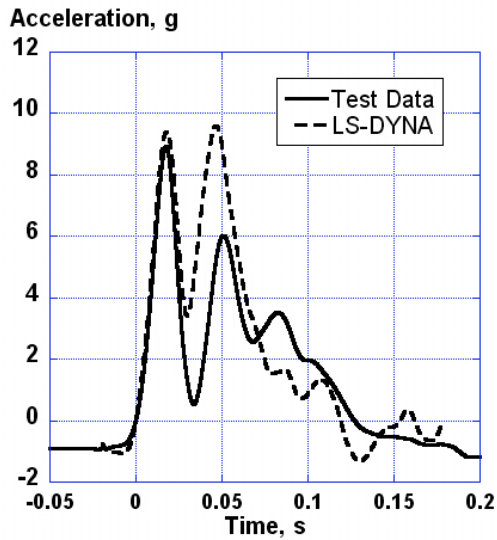

(a) Pelvis response.

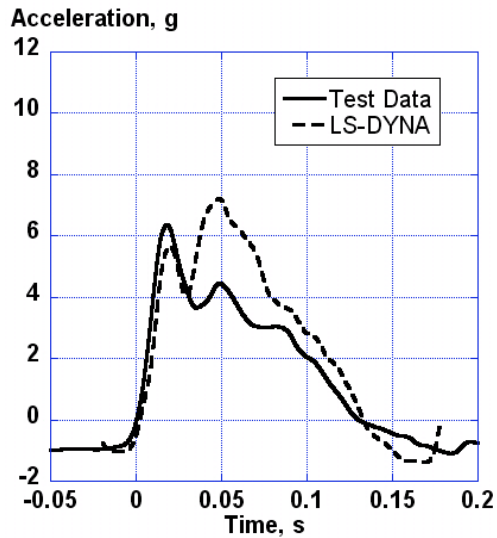

(b) Chest response.

Figure 16. ATD-1 (Styrofoam) test data versus updated LS-DYNA results.

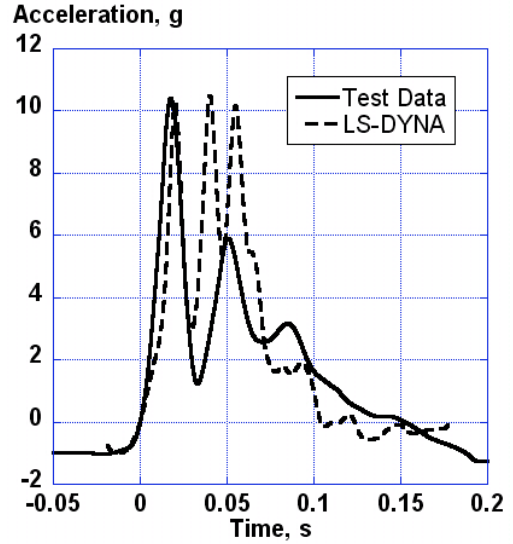

(a) Pelvis response.

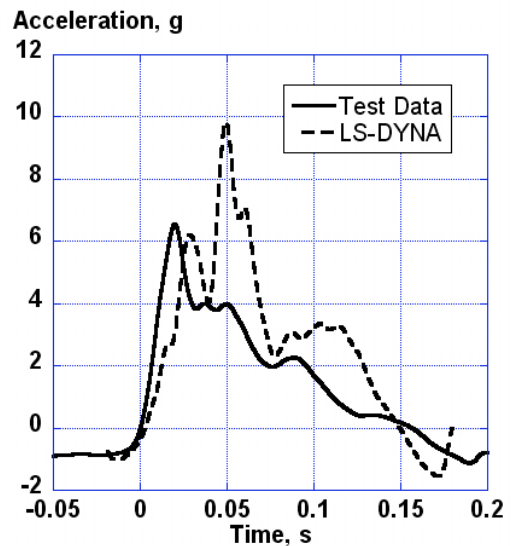

(b) Chest response.

Figure 17. ATD-2 (Polyisocyanurate) test data versus updated LS-DYNA results.

Examining the model further, the energy results, shown in Figure 18, indicate that there is a sharp increase in the internal energy at the same time that the strong secondary pulse is seen in the ATD-2 chest response. Looking closely, there is also an associated increase in the hourglass energy at that time that can be traced down to the hourglass energy associated with the polyisocyanurate material on which ATD-2 is seated, as seen in Figure 19. Also seen in Figure 19 is a secondary hourglass energy spike in the polyisocyanurate foam. Hourglass energy counteracts the forces to prevent non-physical element deformations, and a \*HOURLASS\_CONTROL type 6 was defined for the



polyisocyanurate foam. In general, hourglass energy of 10% or less of the total energy is desirable in a model, and sharp increases in hourglass energy can signify additional non-physical energy additions and unwanted deformation shapes of elements.

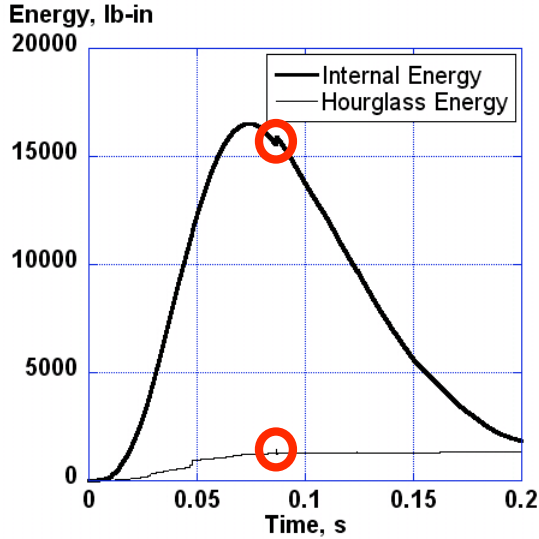

Figure 18. Original LS-DYNA model energy results.

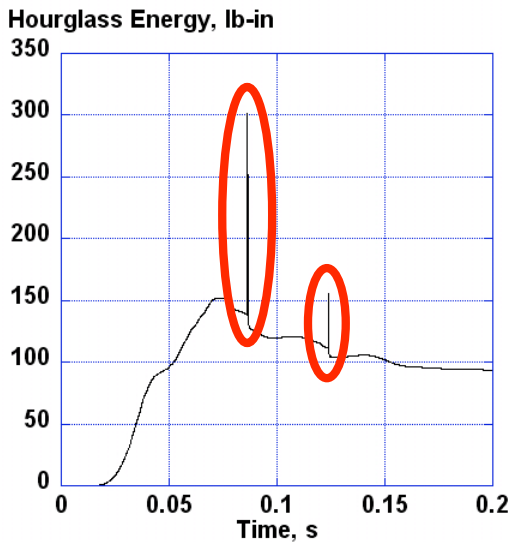

Figure 19. Original LS-DYNA model polyisocyanurate foam hourglass energy.

Hourglass energy for foam materials is often related to the material representation and mesh size. In standard compression testing, it is typical not to capture the strong increase in bulk modulus of the foam once the cells have tightly compacted. This is due to several factors, one of which is the need to obtain material characterization data at a strain rate representative to that which is expected in the test/analysis. Testing the same material in quasi-static method would not provide

the correlation with the dynamic data or capture the dynamic hardening effects. As seen in the material test data that is presented in Figure 15(a), the data ends at just over 70% strain. Using this material curve alone will produce non-physical results in LS-DYNA. To allow the compaction of the elements to propagate from the top element of the foam down through the foam without producing negative volume elements in the finite element model, it is necessary to include the “tail” in the material represent the large bulk modulus stiffening of the foam. The original load curve used in LS-DYNA is shown in Figure 20. When the original results showed that the hourglass energy from the foam was observed to impart large, non-physical accelerations into ATD-2, the tail of the curve was modified to have a smoother response, as also shown in Figure 20.

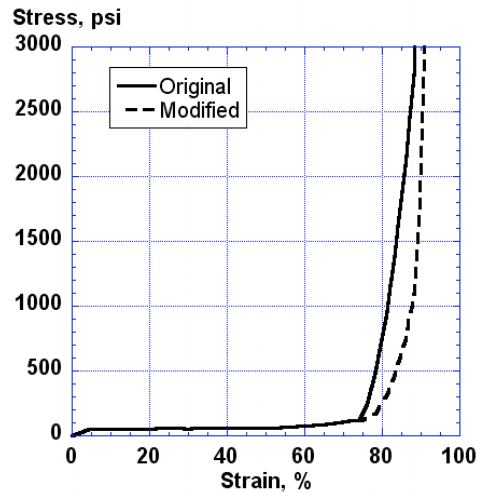

Figure 20. LS-DYNA polyisocyanurate material model load curves.

#### Modified Model

Utilizing the modified polyisocyanurate material load curve as shown in Figure 20, the simulation was repeated. No other changes to the model were made. The results of the simple change of the material load curve on ATD-1 and ATD-2 responses can be seen in Figures 21 and 22, respectively. The energy results for the modified model show a much improved internal energy curve, as shown in Figure 23. Also, the hourglass energy for the polyisocyanurate foam was significantly reduced, as shown in Figure 24.

All qualitative correlations are improved for both ATD-1 and ATD-2, except that the peak acceleration for ATD-2 is now under predicted by the analysis. The initial peak magnitudes correlate within an average of 15%, and the secondary peak acceleration magnitudes correlate within an average of 38.4%. The large secondary response previously seen in the ATD-2 chest

has been reduced, and in general the ATD-2 analysis curves now more closely match the shape of the test acceleration curves. In addition, ATD-1 also saw benefits in the reduction of energy by modifying the polyisocyanurate foam response, thus the reduction in difference in secondary peak magnitude correlation.

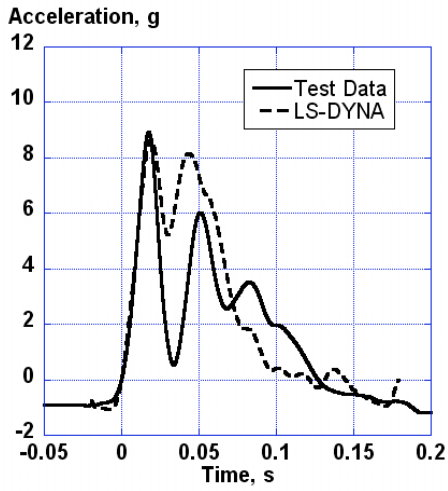

(a) Pelvis response.

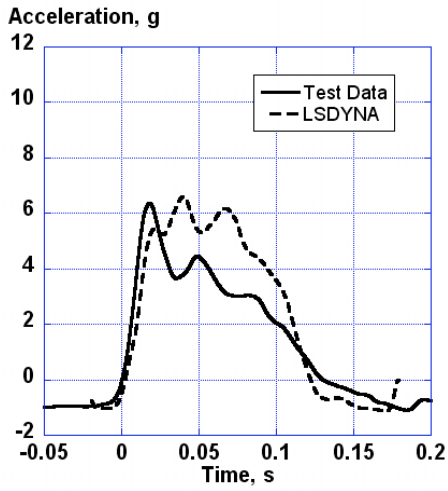

(b) Chest response.

Figure 21. ATD-1 test data versus updated LS-DYNA results for the 8.4-fps test.

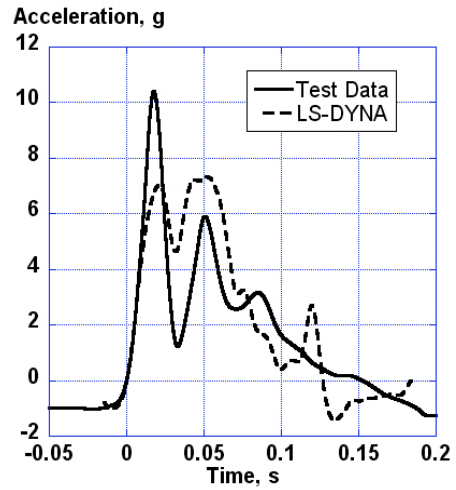

(a) Pelvis response.

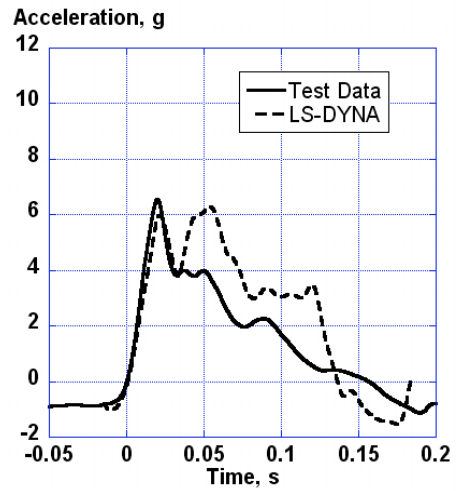

(b) Chest response.

Figure 22. ATD-2 test data versus updated LS-DYNA results for the 8.4-fps test.

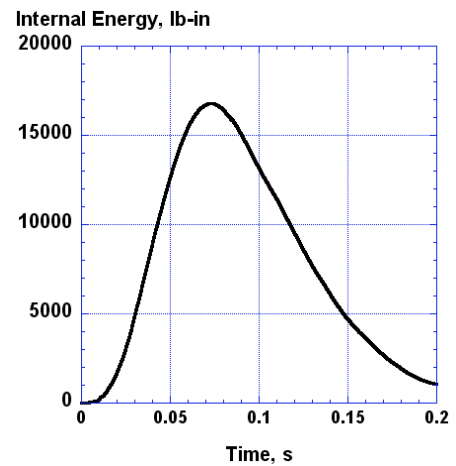

Figure 23. Modified LS-DYNA model internal energy results.

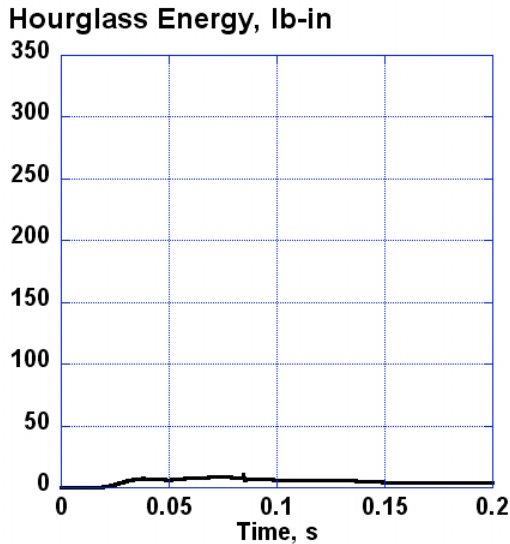

Figure 24. Modified LS-DYNA model polyisocyanurate foam hourglass energy.

Comparisons were made between the accelerometer data from the skid gear itself with nodal accelerations from matching locations in the analysis model, thus improving confidence in the overall model. Representative test-analysis correlations between skid gear platform accelerometers are presented in Figure 25. These results are presented for the modified finite element model; however, changes in the polyisocyanurate material response had little influence on the structural responses shown in Figure 25.

The initial peak acceleration is over predicted by an average of 39%, suggesting that the use of beam elements, and subsequently elastic material properties, for the skid gear is leading to too much energy being transferred into the test platform upon which the LS-DYNA occupants are seated.

### Discussion of Results

The occupant data collected from the two 95<sup>th</sup> percentile Hybrid III male Aerospace ATDs proved useful in performing an analysis and injury assessment. The DRI human injury prediction models were applied using the test data from the 8.4-fps drop test performed in December 2006. The results of the injury assessment indicate a maximum DRI value of 7.5, which is associated with a spinal injury risk of less than 0.2 %, based on operational data during ejection seat incidents. The DRI assessment is based solely on the vertical acceleration responses of the Aerospace ATDs.

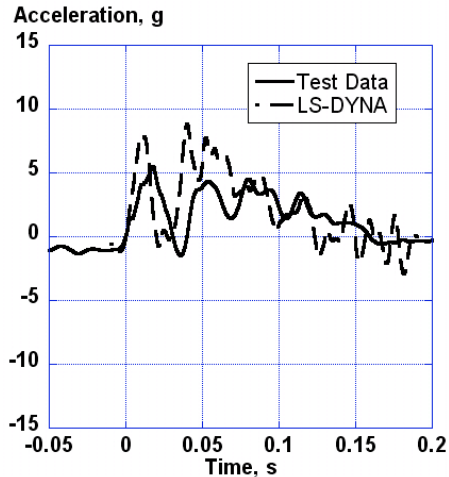

(a) Bottom center.

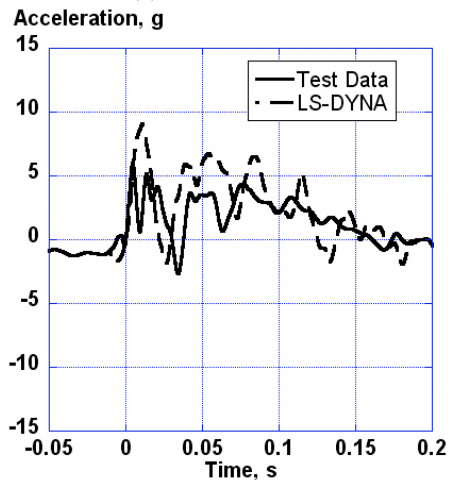

(b) Left rear.

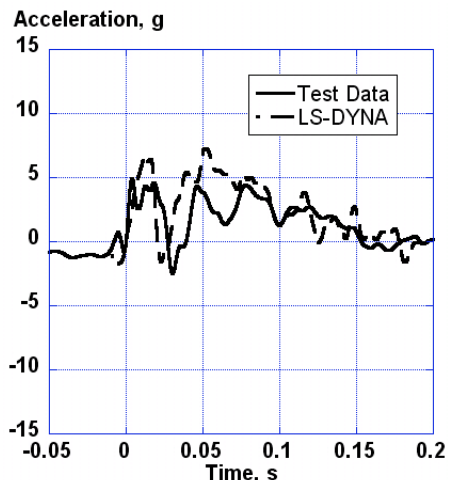

(c) Right rear.

Figure 25. Skid gear platform accelerometer test-analysis correlation.

Foam filler was used in the seat platform to provide additional protection to the ATDs. However, no discernable crushing of the Styrofoam or the polyisocyanurate foam was measured during any of the vertical drop tests. The crush response of each material is shown in Figure 15. Polyisocyanurate foam exhibits an average crush stress of approximately 57 psi. One recommendation for improving the crashworthiness performance of the system would be to incorporate a lower crush stress foam material. Crushing of the foam would provide a secondary means of energy absorption.

The LS-DYNA models representing the 95<sup>th</sup> percentile male Hybrid III occupants performed well during the simulations and generally good agreement with the experiment was obtained. LS-DYNA occupant peak acceleration magnitudes correlated within an average of 15%. However, some differences were seen in the acceleration onset rates. It should be noted that the LS-DYNA occupant models were developed and validated for use in automotive crash simulations in which impulsive loading is primarily in the frontal plane. Rarely would an occupant experience vertical impulsive loading in an automotive crash. Therefore, the difference in acceleration onset rate between test and analysis correlation is attributed to the development history of the analysis occupant models.

While the ability to correctly model the seat foam material proved to be critical in predicting the response of the ATDs, it is also important to capture the correct response of the skid gear test platform itself to ensure that the correct energy is being transmitted into the ATDs. The test-analysis correlation for the skid gear platform accelerometers shows an average over prediction of the initial peak acceleration of 39%. This large difference is attributed to the modeling of the skid gear as beam elements with elastic material properties. The over prediction of the skid gear platform accelerometers indicates that the skid gear in the analytical model does not dissipate as much energy as the test article. This also means that the human occupants in the analytical model are receiving too much load. Therefore, suggested changes to improve correlation include: 1) further refinement of the skid gear to be represented as shell elements, 2) representative plastic kinematic material models for the skid gear, 3) the establishment of a testing program with a simplified the test platform.

## Conclusions

An 8.4-fps vertical drop test was performed on the final skid gear design provided by HeloWerks, Inc. This skid gear is intended as a replacement for an existing composite design that did not perform well during an

actual crash event of the WASP prototype helicopter. Two 95<sup>th</sup> percentile Hybrid III male Aerospace Anthropomorphic Test Devices (ATDs) were seated on the test platform and secured using a four-point restraint system. Test data were collected from accelerometers located on the test fixture, steel plate, the seating platform, and the Aerospace ATDs. The test article was used as a means to obtain ATD test data for correlation with the built-in LS-DYNA \*COMPONENT\_HYBRIDIII occupant model.

Conclusions from this research project were:

- An occupant injury assessment was performed for an 8.4-fps vertical drop test that was conducted on the final skid gear design, using the Dynamic Response Index (DRI). The risk of human injury, based on this model, is less than 0.2%.
- A finite element model of the skid gear test article was developed using LS-DYNA built-in \*COMPONENT\_HYBRIDIII occupant models. This model predicted the ATD initial impact peak responses obtained during the 8.4-fps vertical drop test of the final skid gear design within 15%. Based on these preliminary findings, the LS-DYNA occupant models may be used in aerospace simulation applications to determine occupant body motion response. Also, the fact that occupant models were found to predict peak accelerations in an un-optimized model to within 15% implies that with careful analytic modeling techniques, the LS-DYNA occupant model responses will be able to provide valuable data.
- Further model refinement of the skid gear to shell elements and representative plastic kinematic material models or the establishment of a testing program simplifying the test platform would be desirable to draw the best test-analysis correlation conclusions between automotive derived LS-DYNA model predictions and Aerospace ATD test results.

## References

1. Jackson, K.E., Fuchs, Y.T., and Kellas, S., "Overview of the NASA Subsonic Rotary Wing Aeronautics Research Program in Rotorcraft Crashworthiness," Proceedings of the 11<sup>th</sup> ASCD Earth and Space Conference, Special Symposium on Basllistic Impact and Crashworthiness of Aerospace Structures, Long Beach, CA, March 3-5, 2008.
2. Kellas, S. and Jackson, K.E., "Deployable System for Crash-Load Attenuation," Proceedings of the 63<sup>rd</sup> American Helicopter Society (AHS) Forum, Virginia Beach, May 1-3, 2007.

3. Code of Federal Regulations, Federal Aviation Regulations for Aviation Maintenance Technicians FAR AMT, Part 27 Airworthiness Standard: Normal Category Rotorcraft, 27.723 Landing Gear Shock Absorption.
4. Anon, "LS-DYNA Keyword User's Manual," Version 971, Livermore Software Technology Company, Livermore, CA, August 2006.
5. First Technology: The Aerospace Dummy, <http://www.ftss.com/pcat/products.cfm?obr=NS&bm=4&pcat=aero>
6. Annex 1 Space Act Agreement (SAA) for Crash Safety Evaluation Between NASA Langley Research Center and HeloWerks, Inc., SAA1-807, October 24, 2006.
7. Jackson, K.E., and Fuchs, Y.T., "Vertical Drop Testing and Analysis of the WASP Helicopter Skid Gear," NASA Technical Memorandum, NASA-TM-2007-214907, September 2007.
8. Tho, Cheng-Ho, Sparks, Chad E., Sareen, Ashish K., Smith, Michael R., and Johnson, Courtney, "Efficient Helicopter Skid Landing Gear Dynamic Drop Simulation," Proceedings of the American Helicopter Society 59<sup>th</sup> Annual Forum, Phoenix, AZ, May 6-8, 2003.
9. Society of Automotive Engineers (SAE), Recommended Practice: Instrumentation for Impact Test – Part 1, Electronic Instrumentation, SAE J211/1, March 1995.
10. Stech, E. L. and Payne, P. R., "Dynamic Models of the Human Body," AAMRL-TR-66-157, Aerospace Medical Research Laboratory, Wright-Patterson Air Force Base, Ohio, 1969.
11. Brinkley, J. W. and Shaffer, J. T., "Dynamic Simulation Techniques for the Design of Escape Systems: Current Applications and Future Air Force Requirements," Aerospace Medical Research Laboratory; AMRL Technical Report 71-292, Wright-Patterson Air Force Base, Ohio, December 1971, AD 740439.
12. Coltman, J. W., Van Ingen, C., Johnson, N. B., and Zimmerman, R. E., "Crash Survival Design Guide, Volume II - Aircraft Design Crash Impact Conditions and Human Tolerance," USAAVSCOM TR 89-D-22B, December 1989.
13. Brinkley, J. W. and Mosher, S. E., "Development of Acceleration Exposure Limits to Advanced Escape Systems," Implications of Advanced Technologies for Air and Spacecraft Escape, AGARD-CP-472, April 24-28, 1989.
14. Mosher, S. E., "DYNRESP Six Degree-of-Freedom Model for Injury-Risk Evaluation User's Manual," NASA Johnson Space Center, April 29, 1993.
15. Anon., "Human Tolerance to Impact Conditions As Related to Motor Vehicle Design - SAEJ885," APR 80, SAEJ885, Society of Automotive Engineers, Inc., Warrendale, PA, April 1980.
16. Gadd, C. W., "Use of a Weighted-Impulse Criterion for Estimating Injury Hazard," Proceedings of the Tenth Stapp Car Crash Conference, Society of Automotive Engineers, New York, 1966.
17. Eiband, A. M., "Human Tolerance to Rapidly Applied Accelerations: A Summary of the Literature," NASA Memorandum 5-19-59E, National Aeronautics and Space Administration, Washington D.C., June 1959.
18. Desjardins, S. P., Zimmerman, R. E., Bolukbasi, A. O., and Merritt, N. A., "Crash Survival Design Guide, Volume IV-Aircraft Seats, Restraints, Litters, and Cockpit/Cabin Delethalization," USAAVSCOM TR 89-D-22B, December 1989.
19. Anon., "LS-PRE/POST Version 1.0 Manual," Livermore Software Technology Company, Livermore, CA, August 27, 2002.