

Homologous Deformation of the Effelsberg 100-m Telescope Determined with a Total Station

Axel Nothnagel, Judith Pietzner, Christian Eling, Claudia Hering

Institute of Geodesy and Geoinformation, University of Bonn

Contact author: Axel Nothnagel, e-mail: nothnagel@uni-bonn.de

Abstract

Due to gravitation the main reflector of the Effelsberg 100-m telescope of the Max Planck Institute for Radio Astronomy is deformed whenever it is tilted from zenith to arbitrary elevation angles. However, the resulting shape always is a paraboloid again, though with different parameters, a phenomenon which is called homologous deformation. In summer 2008, we have carried out measurements with a total station to determine the magnitude of these deformations in order to evaluate existing assumptions provided by the manufacturer from the telescope's design phase. The measurements are based on a newly developed approach with a Leica TCRP 1201 total station mounted head down near the subreflector. Mini-retro-reflectors are placed at various locations on the paraboloid itself and on the subreflector support structure. The results indicate that the measurement setup is suitable for the purpose and provides the information needed for a determination of elevation dependent delay corrections. The focal length changes only by about 8 mm when the telescope is tilted from 90° to 7.5° elevation angle.

1. Motivation and Constraints

The 100-m radio telescope of the Max Planck Institute for Radio Astronomy (Fig. 1) was completed in 1972 and is mainly used with feed horns and receivers in secondary focus employing a Gregorian subreflector. For certain frequencies, prime focus operation is maintained with relocatable receiver boxes installed in an opening of the subreflector. The main parabolic reflector is designed for homologous deformation. When tilted to non-zenith elevations, this design permits the paraboloid to deform but guides the deformation to end up as a paraboloid again, though with different parameters. For this purpose, the subreflector support structure with its four legs is completely disconnected from the main reflector (Fig. 4). As a consequence of the homologous deformation, the focal length and, thus, the focal point are elevation dependent. To maintain optimal gain of the telescope, the secondary reflector or the receiver box in prime focus are shifted to compensate for the gravitational displacements. The elevation-dependent model for these shifts has originally been provided by the manufacturer of the telescope and since then has been updated by empirical gain optimization models from test measurements.

In summer 2008, a geodetic survey was carried out to validate the empirical model and to evaluate the deformations for VLBI delay corrections. For these measurements the paraboloid is represented by 16 mini-retro-reflectors mounted in groups of four reflectors each along four meridians (Figures 2 and 5). Ideally, the local coordinates of these reflectors are determined from a single invariant position of a total station outside of the telescope. However, when the telescope is pointing to higher elevations, not all the reflectors are visible simultaneously from anywhere on the ground or adjacent hilltops. The only way around this limitation is that the total station is placed within the movable part of the dish. So, we mounted the instrument head-down close to

the subreflector and controlled it with a cable link to a PC. The operator had to sit in the focus cabin of the telescope and trigger the measurement program for all reflectors with automatic target recognition for each elevation position. The paraboloid was sampled in seven different elevation positions (90° , 75° , 60° , 45° , 30° , 15° , and 7.5°).



Figure 1. Effelsberg 100-m telescope with primary focus cabin at the top.

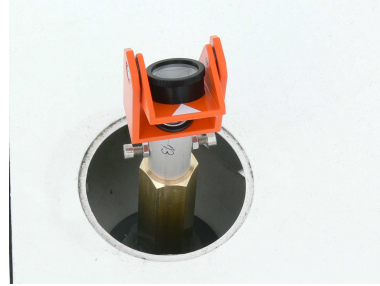

Figure 2. Retro-reflector on paraboloid surface.

The mounting of the instrument near the subreflector had the disadvantage that the position and orientation of the instrument was subject to the displacements and distortions of the prime focus cabin and the subreflector. For this reason, no relationship of the estimated paraboloids existed between the positions when the telescope pointed at different elevations. To link the independent systems related only to the orientation of the axes of the total stations, four more reflectors were observed which were mounted as low as possible on the four subreflector support legs (Fig. 4). A first assumption was that these four points could serve as invariant points for all elevation positions.



Figure 3. Leica TCRP 1201, mounted top-down.

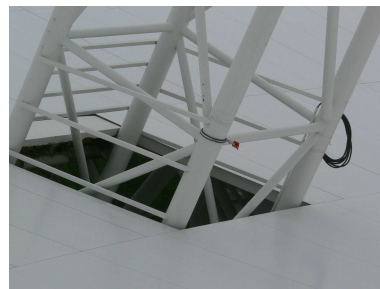

Figure 4. Retro-reflector on support leg.

2. Data Reduction

2.1. Instrument Location and Orientation

When computing the positions of all reflectors relative to the (arbitrary) axes of the total station, it was of course immediately obvious that none of the reflector points maintained its position when tilting the telescope in elevation because the instrument itself was not only displaced but also tilted by about a quarter of a degree. What was unexpected, however, was the fact that

the distances between the four points assumed as invariant changed significantly. When tilting the telescope from 90° to 7.5° elevation, the distances changed continuously and monotonically to a maximum of 18 mm (Fig. 6). The reason for these distance changes is a bending of the subreflector support legs which depends on various factors, in particular on what geometrical position each individual beam has w.r.t. the gravitation vector and in what directions the gravitational force is actually acting. When the telescope, for example, is in a 60° elevation position, the lower leg is almost upright with the consequence that the bending force is eliminated while the upper leg is inclined by about 30° and, thus, subject to a bending force which is close to 90% of the gravitational force (Fig. 7). The reflectors near the bottom ends of the legs are, however, only affected by a small fraction of the bending.

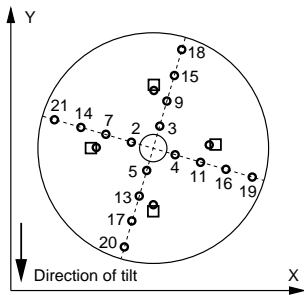

Figure 5. \circ = Positions of reflectors, \square = Intersections of subreflector support legs.

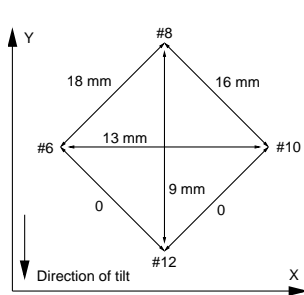

Figure 6. Differences in distances between foot points of subreflector support legs when tilting from 90° to 7.5° elevation.

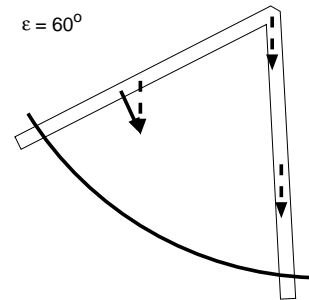

Figure 7. Gravitational force (dashed vector) and bending force (solid vector) acting on upper and lower support legs.

To end up with quasi-invariant reference points at the bottom parts of the subreflector support legs, we developed a simple gravitational model for each of the four legs. Since we are only interested in the movements of the reflectors close to the bottom ends of the support legs, the model can assume simple beams which are joint at the free end (at the prime focus cabin) and supporting each other. Thus, the main deformation is in the middle of the beams with a greatly reduced effect at the bottom of the legs.

With the corrections for the bending applied, the positions of the reflectors could be considered as invariant to the tilting of the telescope. The quality of the model can best be characterized by the resulting residuals of the distance determinations from the measurements (Fig. 8).

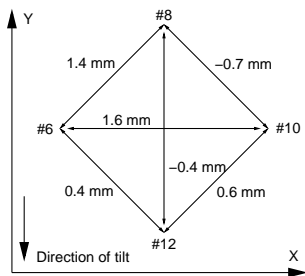

Figure 8. Residual differences in distances between foot points when tilting from 90° to 7.5° elevation.

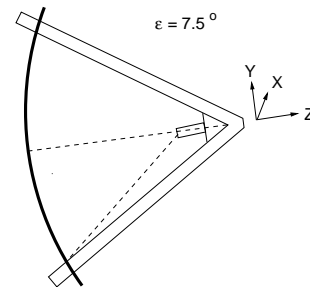

Figure 9. Sketch of telescope at 7.5° elevation with axis definition.

Now, having established invariant points, the position and orientation of the total station or rather its displacement from the initial position at 90° elevation was determined from a 6-parameter similarity transformation. As expected, the largest displacement of the instrument occurred in the direction tangential to the main reflector and the subreflector. This effect is most obvious when the telescope points at 7.5° elevation and the weight of the prime focus cabin and of the subreflector pull the whole construction down. In our local coordinate system, this axis is the y-axis, while the x-axis is perpendicular (parallel to the elevation axis, Fig. 9). This movement, which is tangential to the incoming radiation, reaches 47 mm at 7.5° elevation (Fig. 10). In the radial direction with the z-axis towards the observed object, the maximum displacement of 5 mm towards the main reflector is surprisingly small (Fig. 11). The graph does not appear as smooth as that of the Δy component; this, however, originates from a slight deviation of the measurement at 45° elevation together with the scale which is only 1/10 of the other component.

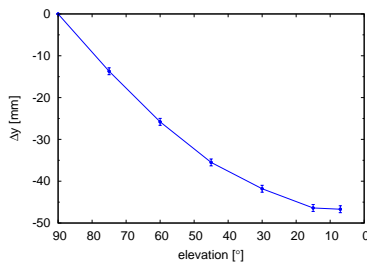

Figure 10. Displacement of instrument in y direction vs. elevation.

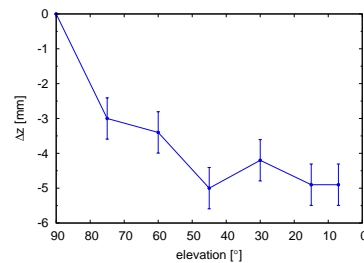

Figure 11. Displacement of instrument in z direction vs. elevation.

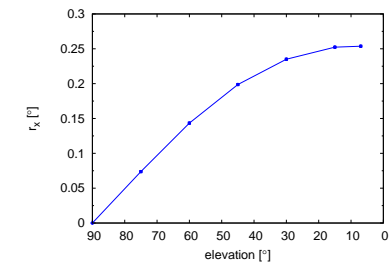

Figure 12. Rotation of instrument about x-axis.

The last effect is a tilt of the instrument about the x-axis of at maximum 0.25° . This is a clockwise rotation towards $-y$ resulting in the head of the total station being pulled down. Here, 0.25° is equivalent to 1.1 mm displacement of the instrument's intersection of axes. This is a very small effect and is assumed to be a consequence of the deformation of the whole prime focus cabin and support leg structure. However, due to the long lever arm of more than 35 m, this rotation shifts the apparent positions of the points on the main reflector by about 15 cm.

2.2. Reflectors on the Paraboloid

The flexibility of the main reflector is an important design element of the Effelsberg 100-m radio telescope, being the basis for homologous deformation at all elevation angles. Having determined the position and orientation of the total station in each elevation step through simple six-parameter similarity transformations, the positions of the subreflectors on the main paraboloid can now be determined applying the respective transformation parameters to these positions as well. When the telescope is tilted from 90° elevation angle downwards the reflectors are displaced in the y and z direction in a monotonous way confirming the high quality of the measurements (Figures 13 and 14). Here, reflector #20 is displaced as much as 50 mm in y direction and 41 mm in z direction when the 7.5° elevation position is reached.

Looking at the results for the 7.5° elevation angle tilt in a 2D representation (Fig. 15), it can be seen that the upper part of the paraboloid is folded inwards (#15 by 57 mm). Unfortunately the very top reflector (#18) was not visible any more at 7.5° elevation due to obstruction by the

subreflector support leg. Towards the vertex, the magnitude of the folding naturally decreases changing direction at the bottom part with reflector # 20 pulled down by as much as 66 mm.

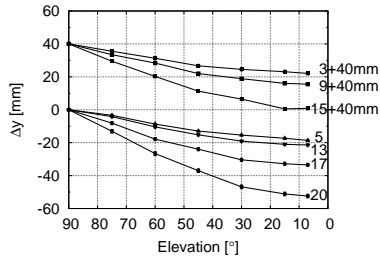

Figure 13. Displacement of reflectors in y direction. Points 3, 9 and 15 (see Fig. 5) are offset by +40 mm for better readability.

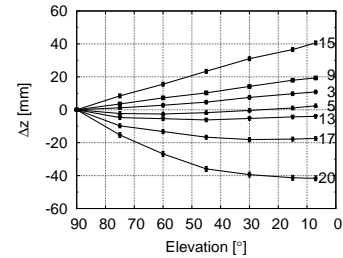

Figure 14. Displacement of reflectors in z direction.

2.3. Focal Length Results

A first result of the project is the estimate of the focal lengths of the telescope in the individual elevation angle positions. This quantity is invariant to any transformations which are necessary for a determination of the shift of other parameters, e.g., of the vertex. Taking into account the formal errors, the focal lengths of the 75° and 60° positions are hardly changed while down to 7.5° elevation, it is shortened by 13 mm. For such a large telescope, this result is surprisingly small. However, together with an upward movement of the vertex of about 7 mm, the results agree well with an empirical model for a gain adjustment through focus/subreflector movements. These results indicate that the earlier steps have been carried out correctly, and the approach looks very promising for further steps of data analysis.

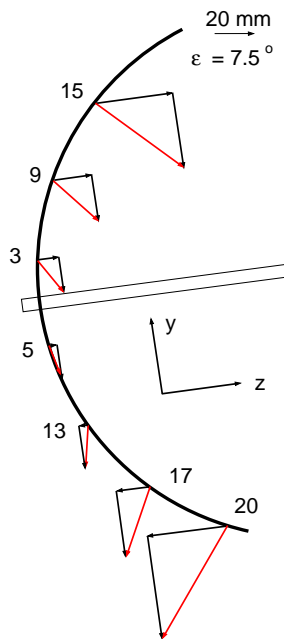

Figure 15. Folding of main paraboloid along the 10° meridian at 7.5° elevation. The top reflector is missing due to visibility problems.

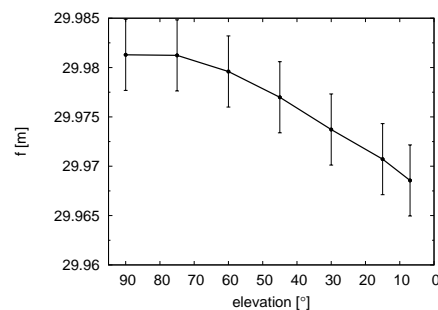

Figure 16. Focal length estimates w.r.t. elevation angle of telescope.

Acknowledgements. We are grateful to the staff of the Max Planck Institute for Radio Astronomy at Effelsberg for their efforts to make these measurements possible. In particular, we should mention Klaus Bruns, who did not hesitate to mount our reflectors at the edge of the paraboloid, which required some really acrobatic exercises.