

5.18 EEG Artifact Removal Using A Wavelet Neural Network

EEG Artifact Removal Using A Wavelet Neural Network

Hoang-Anh T Nguyen, John Musson, Jiang Li and Frederick McKenzie
Old Dominion University

Hnguy025@odu.edu jmuss003@odu.edu JLi@odu.edu rdmckenz@odu.edu

Guangfan Zhang and Roger Xu
Intelligent Automation, Inc.
gzhang@i-a-i.com hgxu@i-a-i.com

Carl Richey and Tom Schnell
University of Iowa
richeyc@ccad.uiowa.edu thomas-schnell@uiowa.edu

Abstract- In this paper, we developed a wavelet neural network (WNN) algorithm for EEG artifact removal without EOG recordings. The algorithm combines the universal approximation characteristics of neural network and the time/frequency property of wavelet. We compared the WNN algorithm with the ICA technique and a wavelet thresholding method, which was realized by using the Stein's unbiased risk estimate (SURE) with an adaptive gradient-based optimal threshold. Experimental results on a driving test data set show that WNN can remove EEG artifacts effectively without diminishing useful EEG information even for very noisy data.

1.0 INTRODUCTION

Electroencephalogram (EEG) recordings are known to be contaminated by physiological artifacts from various sources, such as eye blinking or movements, heart beating and movements of other muscle groups [1]. Such types of artifacts are mixed together with the brain signals, making interpretation of EEG signals difficult [2].

Eye movements or blinks usually produce large electrical potentials, which spread across scalp and contaminate EEG recordings. This class of potential generates significant electrooculographic (EOG) artifacts in the recorded EEG. Removal of EOG artifacts is nontrivial because these artifacts spread across the scalp, contaminate and overlap in frequency with the EEG. The effect of EOG artifacts on EEG activity is found most significantly in low frequency bands: Delta (1-4Hz), Theta (4-8 Hz) and Alpha (8-13 Hz) [3]. Eye blinking generates spike-like shapes with their peaks can reach up to 800uV and occur in a very short period, 200-400 ms [4]. Meanwhile, artifacts generated by eye movements are square-shaped, smaller in amplitude but last longer in time, corresponding to lower frequency components [5].

In recent years, there has been an increasing interest in applying various techniques to remove ocular artifacts from EEG [1, 2, 5, 6,8, 10, 13, 14-19]. The methods for removing EOG artifacts based on regression in time domain or frequency domain [8] were widely studied. All regression methods, both in time and frequency domains, rely on EOG recordings, which are however, not always available. Furthermore, these methods usually eliminate the neural potentials which are common to reference electrodes and other frontal electrodes.

Berg and Scherg [10] proposed principle component analysis (PCA) based technique for removing ocular artifacts. In this method, EEG and EOG signals were simultaneously collected. It was observed that PCA of the variance in these signals produced major components corresponding to various eye blinks and eye movements. The artifacts were removed by eliminating these contaminated components. Their experiments proved that PCA removes artifacts more effectively than regression based models. However, PCA models usually failed to completely separate artifacts from cerebral activity [11], and the

orthogonal assumption for data components in PCA is hardly satisfied [5].

Independent component analysis (ICA), which was developed for the blind source separation problems, the class of algorithms which decompose mixtures into original sources without any *a priori* knowledge about the mixing process or properties of those sources, has been used as an alternative method for EEG artifact removal [1, 12-14]. ICA for artifact removal usually requires a large amount of data and manual visual inspection to eliminate noisy independent components, making the method time-consuming and not suitable for real-time applications.

Recently, the wavelet-based methods [14-19] for EEG artifacts removal have received significant attention. Wavelet analysis has been used as an effective tool for measuring and manipulating non-stationary signals such as EEG. It provides flexible controls over the resolution with which neuroelectric components and events can be localized in time, space, and scale. The biggest advantage of using this method for EEG correction is that it does not rely on neither the reference EOG signal nor visual inspection.

This paper proposes a novel, robust, and efficient technique to remove EEG artifacts by combining the approximation capabilities of both wavelet and neural network methods. The method can be described briefly as the following (1) contaminated EEG signals are first decomposed to a set of wavelet coefficients, (2) low frequency wavelet sub-band coefficients are then passed through and corrected by a trained neural network and (3) the corrected coefficients are used to reconstruct clean EEG signals. The method was applied to correct EEG data contaminated by ocular artifacts and compared with other state-of-the-art methods including ICA and a wavelet thresholding method.

The rest of the paper is organized as follows: Section 2 shows other related works. Section 3 presents the proposed

technique. Section 4 describes the experimental settings. Section 5 presents some of the achieved results. Section 6 provides discussions for the results and Section 7 concludes the paper.

2.0 RELATED WORK

2.1 EEG model

We assume the model for contaminated EEG signal as in the following form:

$$EEG_{rec}(t) = EEG_{true}(t) + k.EOG(t)$$

where $EEG_{rec}(t)$ is recorded contaminated EEG, $EEG_{true}(t)$ denotes the true EEG signal, and $k.EOG(t)$ represents the propagated ocular artifact from eye to the recording site. The ultimate purpose of any artifact removal techniques is to recover $EEG_{true}(t)$ from $EEG_{rec}(t)$

2.2 Wavelet thresholding

Wavelet thresholding technique is built on the multiresolution analysis of wavelet transform, a tool that analyses signal in different time and frequency components [20]. These components, called approximations and details, are further processed by thresholding before reconstruction [14]-[18]. By selecting a 'good' mother wavelet, which resembles the shapes of the artifacts, large-valued coefficients are generated in the areas corresponding to the EEG artifacts at low-frequency sub-bands and are considered as an estimate of the ocular artifacts. Thus, shrinking the amplitude range of these coefficients by nonlinear thresholding functions would remove those artifacts. In this paper, a wavelet thresholding method was implemented as follow,

- a. Use a butterworth lowpass filter to smooth the EEG signal before further processing
- b. Apply Wavelet transform to the contaminated EEG signal
- c. Utilize a thresholding function to automatically corrected high-valued coefficients at low-frequency sub-bands
- d. Reconstruct the corrected EEG signal

2.3 Independent Component Analysis

Independent component analysis was first proposed by Herault and Jutten at a meeting in Snowbird Utah in 1986 [1, 11] to solve the blind source separation problem (BSS). ICA aims at recovering independent source signals $s = \{s_1(t), s_2(t), \dots, s_N(t)\}$, from recorded mixtures $x = \{x_1(t), x_2(t), \dots, x_N(t)\}$ by an unknown matrix A of full rank. The basic problem of ICA is to estimate the mixing matrix $[A]$ or equivalently, the original independent sources (s) based on the following linear relationship ($x = As$) while no knowledge is available about the sources or the mixing process. The method was developed based on several assumptions such as, the sources are statistically independent, the independent components must have non-Gaussian distributions and the matrix $[A]$ is assumed to be square and invertible. ICA identifies an unmixing matrix, $[W]$, which decomposes the multi-channel scalp data into a sum of temporally independent and spatially fixed components. ICA finds ($u = Wx$), where the rows of the output data matrix represent time courses of activation of the ICA components [1, 9, 11]. Several algorithms have been proposed to implement ICA such as INFORMATION MAXimization approach (InfoMax), Fixed-

point ICA, Joint Approximate Diagonalization of Eigenmatrices (JADE) algorithm and the Second Order Blind Identification (SOBI). In this research, the InfoMax algorithm was used to perform for EEG artifact removal.

3.0 PROPOSED METHOD

In this paper, we present a novel algorithm, Wavelet Neural Network (WNN), for EEG artifact removal. In our method, the WNN is trained with simulated data resembling the properties in both time and frequency domains of EEG signal. The trained WNN is then used as the corrector for contaminated data. In both testing and training processes, the original signal is decomposed first with a wavelet to get different frequency components. The low frequency sub-band coefficients are then interpolated to maintain same lengths. A trained artificial neural network (ANN) is fed with such interpolated inputs to yield the corrected coefficients at its outputs. Finally, the corrected coefficients are downsampled for the wavelet construction to get the corrected signal y of original contaminated x as shown in Figure 1.

The core idea of the method, decomposing the signal in both time and frequency domains with wavelet and using an ANN to

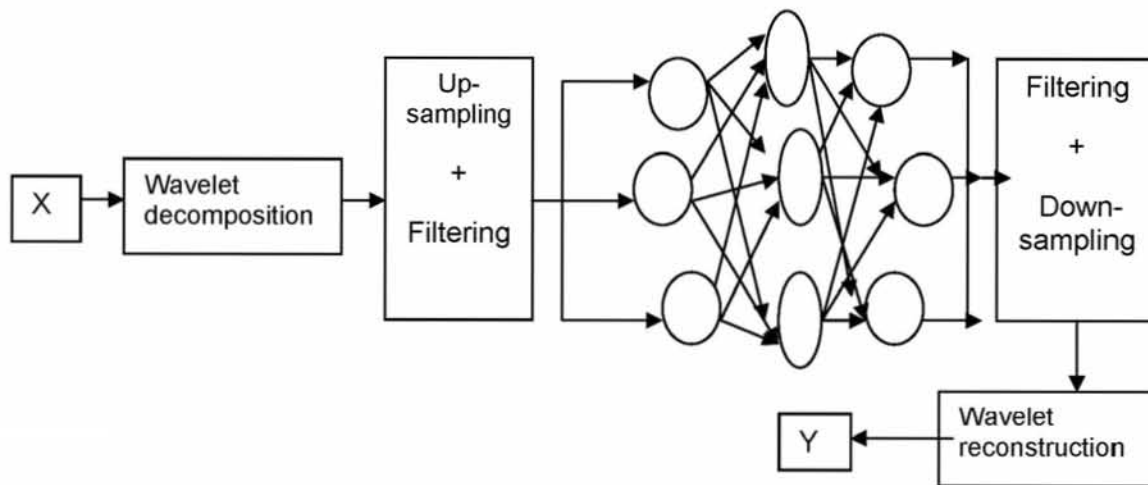

Figure 1. Proposed Wavelet Neural Network Structure.

correct them, can be viewed in a more succinct (and perhaps more precise) way. By combining the time/frequency property of wavelet and the universal approximation capability of neural network, we would be able to keep useful information related to cognitive activities while eliminate artifacts in EEG.

3.1 EEG data simulation

As described in [23], EEG signal can be simulated based on three assumptions, (1) Short segments of the spontaneous EEG can be described as linearly filtered, (2) non-stationary components in the spontaneous EEG can be simulated by changing the characteristics of this filtering process and (3) the spectral property of the simulated EEG data resembles that of actual signal. As shown in Figure 2, a set of Gaussian noises (GN) were generated and then filtered by a number of lowpass and bandpass filters with different cut-off frequencies that are similar to the spectral property of EEG frequency bands. Transients like eye blinks and eye movements, collected from real signals were then filtered by lowpass filter and added to make the simulated data contaminated. Cutoff frequencies for those filters are

summarized in Table 1.

Table 1. EEG Frequency Band Specifications

Freq. bands	Lower (Hz)	Upper (Hz)
Delta	0.5	4
Theta	4	8
Alpha	8	13
Beta-1	13	20
Beta-2	20	30
Gamma	30	50

3.2 Neural Network Training

The backpropagation (BP) is used as the machine learning technique for multi-layer perceptron (MLP) neural network. Experimental results show that the one hidden layer neural network structure 3-5-3 (3 inputs, 5 hidden units and 3 outputs) is good enough for EEG ocular artifact removal issue. The trained ANN's input and output are low frequency sub-band coefficients of the wavelet-decomposed simulated data and these coefficients after corrected, respectively. In this paper, the number of iterations for ANN training is set

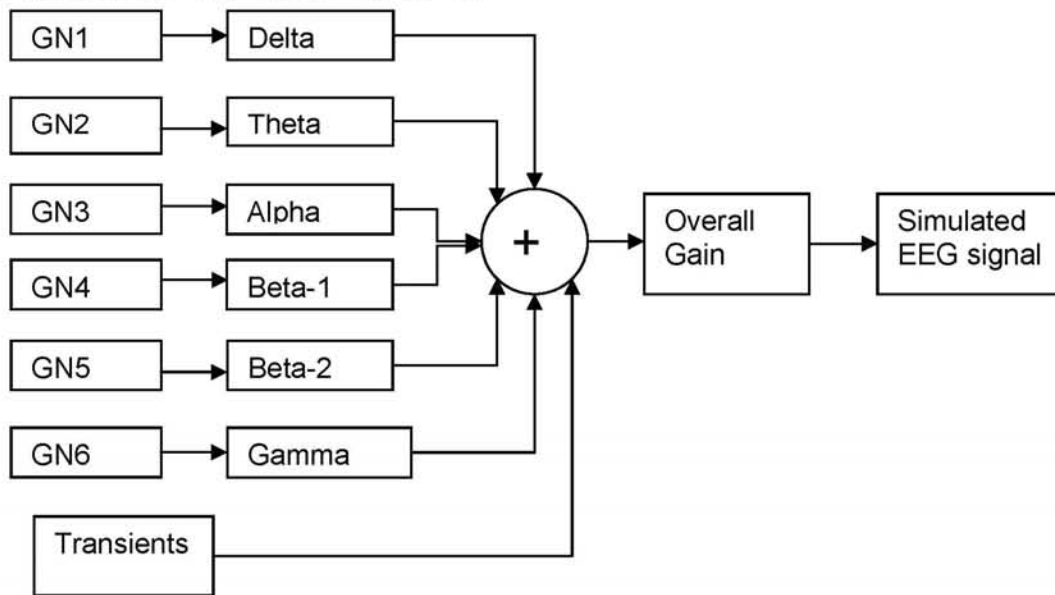

Figure 2. EEG Signal Simulation Model.

at 200, but this number might be optimized to improve the training accuracy.

3.3 Performance metric

We use two metrics, power spectrum density (PSD) and frequency correlation, to assess the proposed method. The PSD is a popular metric used to show information about the power spectrum of EEG signal at specific frequencies. Calculation of the correlation in frequency domain before and after artifact removal is equivalent to the correlation in time domain after filtering the time series with the corresponding frequency filter [14]-[22]. The frequency correlation between \tilde{x} and \tilde{y} is computed as in the following formula,

$$c = \frac{\frac{1}{2} * \sum_{w1}^{w2} (\tilde{x} * \tilde{y} + \tilde{y} * \tilde{x})}{\sqrt{\sum_{w1}^{w2} \tilde{x} \tilde{x} * \sum_{w1}^{w2} \tilde{y} \tilde{y}}}$$

where $w1$ and $w2$ are the lower and upper limits of the interested power spectrum region to be calculated, c is the correlation value that will be assigned to the frequency of $(w1+w2)/2$. If frequencies \tilde{x} and \tilde{y} are identical, c gets 1, otherwise, c obtains a value between 0 and 1. In this paper, the 'window size', $w1-w2$, is selected equal to 2.

4.0 EXPERIMENTS

4.1 Datasets

We validate our method on a data set, which was collected when participants were performing a driving test. The EEG information was collected by a 128-channel recording system at the sampling rate of 1000 Hz along with other information including description of the task, system dynamics related information, performance measures, physiological signals (ECG, respiration, etc.), and eye tracking. The workload was also analyzed according to the driving conditions (city-driving, stopped, highway passing, etc.). Due to the recording condition, the subject eye movements and blinks happen at high frequency making the data, especially at frontal recording

channels, highly contaminated by ocular artifacts.

4.2 Experimental settings

We implemented three artifact removal methods for comparison, the ICA method, the wavelet thresholding algorithm and the proposed WNN technique. For each algorithm, we computed PSD and frequency correlation before and after artifact removal to illustrate the effectiveness of each of the algorithms. For the proposed method, we first simulated EEG signals to train an ANN and tested the trained model on a simulated signal and the driving test data set. For the wavelet thresholding method, we implemented it by following the instruction in [20] and for the ICA, we utilized the EEGLAB software.

5.0 RESULTS

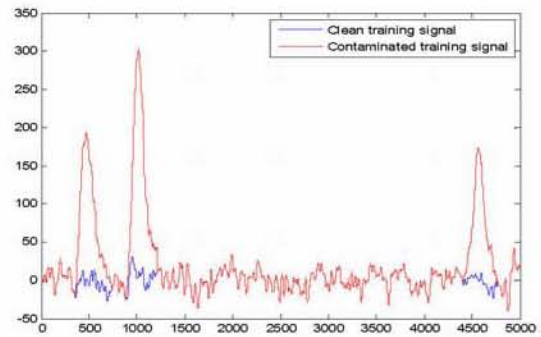

(a)

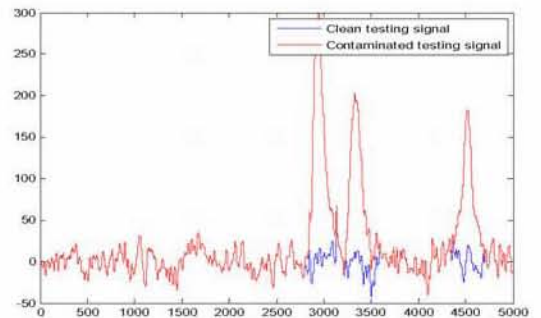

(b)

Figure 3. Clean and Contaminated Simulated Signal for (a) Training and (b) Testing.

For the proposed WNN algorithm, two simulated segments with a length of 5 seconds for training and testing at sampling rate of 1000 Hz were created as shown in Figure 3a and 3b, respectively, where the artifacts were taken from the driving test data set and added to the simulated data segments. Data in Figure 3a was then used to train the neural network in the proposed WNN algorithm. We applied the trained WNN model to the testing data segment (Figure 3b), and the corrected EEG signal is shown in Figure 4. Figures 5 shows PSD of the contaminated, corrected and the clean EEG signals. Figure 6 shows frequency correlations among those signals.

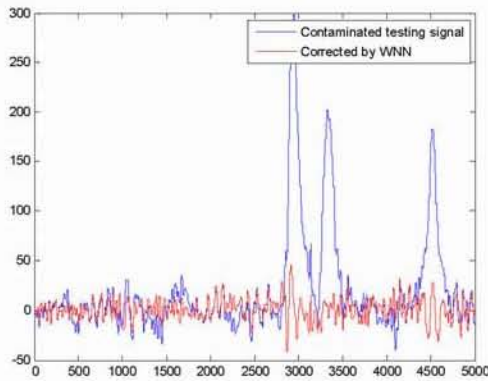

Figure 4. Contaminated Simulated and WNN Corrected Singals

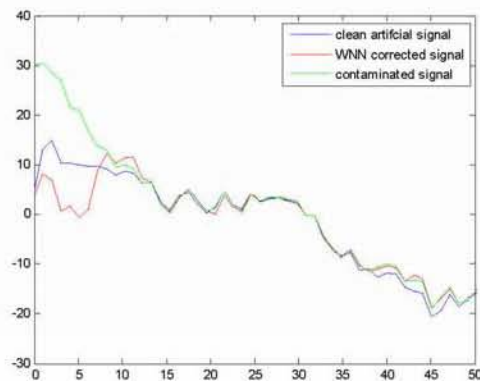
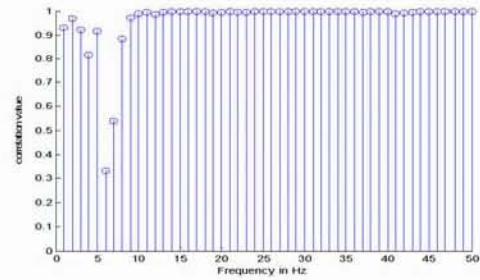

Figure 5. PSD of Clean, Contaminated and WNN Corrected Signals for Testing

For the ICA algorithm, it took a computer, equipped with Intel(R) Core(TM) 2 CPU 6400 @ 2.13 GHz and RAM 2.00 GB, 27 minutes

with 382 steps to remove the artifacts for one EEG segment in the driving data set.



(a)

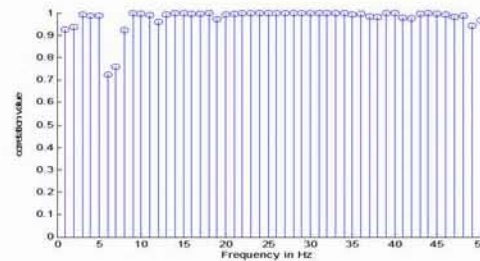

(b)

Figure 6. Frequency Correlation between (A) Contaminated and Corrected Simulated Signals and (B) Clean and Corrected Simulated Signals.

We then applied the trained WNN model to the driving test data set. We decomposed the EEG signal to 8 levels and 3 low frequency sub-band coefficients were corrected by the WNN algorithm.

The wavelet thresholding method was used to adaptively correct 4 low frequency sub-bands coefficients. For specific data segments, the corrections were repeated a number of times with various wavelets and at different levels of decompositions in order to make the corrected data most acceptable. The wavelets from Coiflet and Daubechies family were chosen because experiments show that they could extract the features of artifacts efficiently.

Figure 7 show PSD plots for one sample artifact removed segment in the driving test data by the three algorithms. Figure 8 shows the segment in time domain. Figure 9 shows frequency correlations between the contaminated and corrected segments.

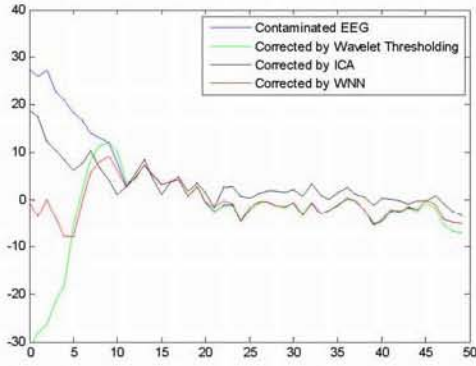
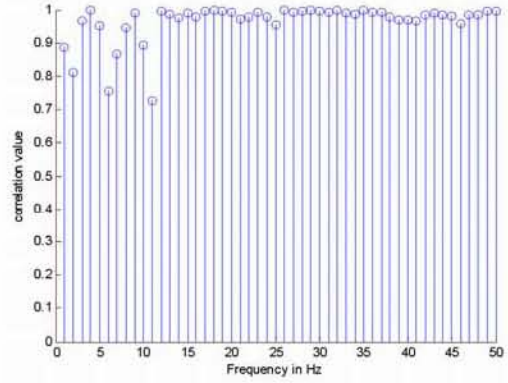
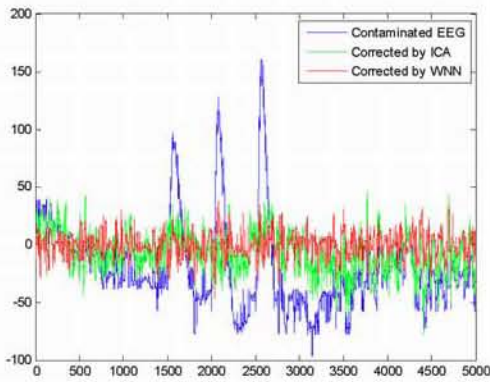

Figure 7. PSD of Contaminated and Decontaminated EEG



(a) ICA



(a)

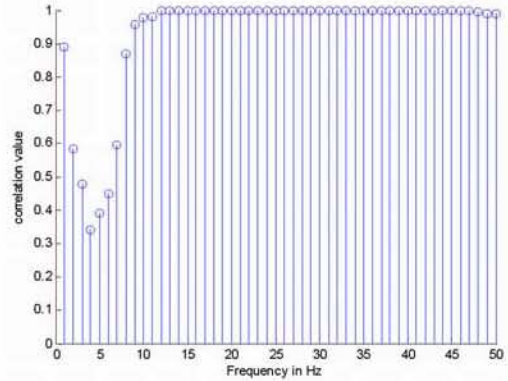

(b) Wavelet Thresholding

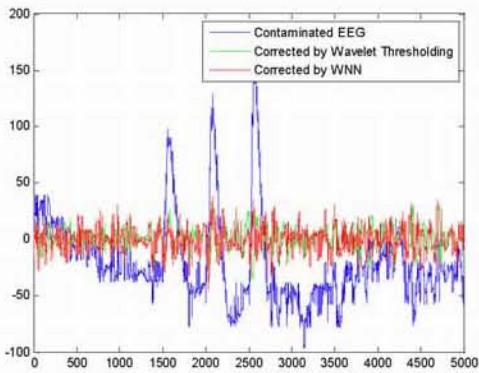

(b)

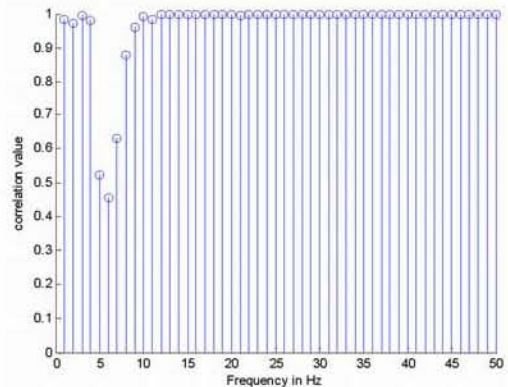

(c) WNN

Figure 8. Contaminated and Decontaminated EEG (a) Contaminated, ICA and WNN Corrected EEG (b) Contaminated, Wavelet Thresholding and WNN Corrected EEG

Figure 9. Frequency Correlation between Contaminated and Decontaminated EEG, (a) by ICA, (b) by Wavelet Thresholding and (c) by WNN

6.0 DISCUSSION

It is observed from various results that the WNN algorithm removes ocular artifacts efficiently while keeping cerebral background information. Like Wavelet Thresholding, WNN just needs one single channel data to perform correction that makes it advantageous over ICA, which needs to perform on the whole dataset. Furthermore, the method was proved through repeated experiments on various data segments for its effectiveness and stability, which is not true for the wavelet thresholding algorithm.

The PSD plot shows that the low frequency components are reduced significantly in the corrected signal. That is more evident if we look at the frequency correlation metric plot between contaminated and corrected signals: there is a slight difference in the range of low frequency components while in other ranges, the useful information is well-preserved.

The frequency correlation plots also show that the correction made by ICA spreads over the entire frequency range and the power of low frequency components are reduced not significantly. Mean while, the low frequency components in the signal were derogated by Wavelet Thresholding and WNN while high frequency components are well preserved by both.

ICA requires a lot more computing power and multiple channel data sources for artifact removal. It also demands either an automatic or a manual step to determine which independent component is artifact, making an online implementation of ICA difficult.

7.0 CONCLUSIONS

We proposed a novel algorithm, WNN, for artifact removal for EEG signal. The algorithm combines the time/frequency property of wavelet and the approximating capability of neural network to locate and eliminate artifacts. Experimental results on a driving data set show that WNN can effectively remove artifact and achieve

better results than the wavelet thresholding algorithm. WNN is also much computationally efficient than the ICA algorithm making it possible an automatic online algorithm.

8.0 ACKNOWLEDGEMENT

This project was funded by the NASA (Contract No: NNX10CB27C). We thank Dr. Alan T. Pope, our COTR, for his comments and suggestions as we performed this research. We also thank Dr. Kara Latorella for her comments and feedback during various discussions over the course of this project.

9.0 REFERENCES

- [1]. T. Jung, S. Makeig, C. Humphries, T. Lee, M. Mckeown, V. Iragui, and T. J. Sejnowski, "Removing electroencephalographic artifacts by blind source separation," *Psychophysiology*, vol. 37, pp163-178, 2000.
- [2]. E. Urretarazu, J. Iriarte, M. Alegre, M. Valencia, C. Vireri, and J. Artieda, "Independent component analysis removing artifacts in ictal recordings," *Epilepsia*, vol. 45, pp. 1071-1078, Sep. 2004.
- [3]. Diego A. Pizzagalli, "Electroencephalography and High-Density Electrophysiological Source Localization", Chapter prepared for Cacioppo, J.T. et al., *Handbook of Psychophysiology (3rd Edition)*
- [4]. D. Hagemann and E. Naumann, "The effects of ocular artifacts on (lateralized) broadband power in the EEG," *Clinical Neurophysiology*, vol. 112, pp. 215-231, 2001.
- [5]. C.A. Joyce, I. F. Gorodnitsky, and M. Kutas, "Automatic removal of eye movement and blink artifacts from EEG data using blind component separation," *Psychophysiology*, vol. 41, pp. 313 - 325 2004
- [6]. Croft R J and Barry R J, "Removal of ocular artifact from the EEG: a review," *Clin. Neurophysiol.* Vol. 30, pp 5-19, 2000.
- [7]. Kandaswamy A, Krishnaveni V, Jayaraman S, Malmurugan N and Ramadoss K, "Removal of ocular artifacts from EEG-a survey", *IETE J. Res.* Vol. 52 pp 121-130, 2005.

- [8]. Gratton G, Coles M G and Donchin E, "A new method for off-line removal of ocular artifact," *Electroencephalogram. Clin. Neurophysiol.* Vol. 55, pp 84-468, 1983.
- [9]. Woestenburg J C, Verbaten M N and Slangen J L, "The removal of the eye movement artifact from the EEG by regression analysis in the frequency domain," *Biol. Psychol.* Vol 16, pp 47-127, 1983
- [10]. P. Berg, and M. Scherg, "Dipole models of eye activity and its application to the removal of eye artifacts from the EEG and MEG". *Clinical Physics and Physiological Measurements*, vol.12(Supplement A), pp49-54, 1991b.
- [11]. T. D. Lagerlund, F. W. Sharbrough, and N. E. Busacker, "Spatial filtering of multichannel electroencephalographic recordings through principal component analysis by singular value decomposition". *Journal of Clinical Neurophysiology*, vol. 14, pp73-82, 1997.
- [12]. P. Common, "Independent Component Analysis, A new concept?". *Signal Processing*, vol. 36, pp 287-314, 1994.
- [13]. Delorme A, Makeig S and Sejnowski T, "Automatic artifact rejection for EEG data using high-order statistics and independent component analysis," *Proc. Third Int. ICA Conf.* pp 9-12, 2001
- [14]. V Krishnaveni, S. Jayaraman, L. Anitha and K. Ramadoss, "Removal of ocular artifacts from EEG using adaptive thresholding of wavelet coefficients," *J. Neu. Eng.* 3, pp 338-346, 2006
- [15]. K.P. Indiradevi, E. Elias, P.S. Sathidevi, S. Dinesh Nayak and K. Radhakrishnan, "a multi-level wavelet approach for automatic detection of epileptic spikes in the electroencephalogram", *Com. In Bio. And Medicine* 38, pp 805-816, 2008
- [16]. L. Senhadji, J-L Dillenseger, F. Wendling, C. Rocha, and A. Kinie, "Wavelet analysis of EEG for three-dimensional mapping of epileptic events," *Ann. Biomed Eng.* Vol. 23(5), pp 543-552, 1995
- [17]. V. J .Samar, A. Bopardikar, R. Rao and K. Swartz, "Wavelet analysis of neuroelectric waveforms: A conceptual tutorial", *Brain and Language*, Vol. 66, pp 7-60, 1999.
- [18]. X. P. Zhang and M. D. Desai "Adaptive denoising based on SURE risk," *IEEE Sig. Pro. Letters*, Vol. 5, No. 10, Oct. 1998
- [19]. V. J. Samar, A. Bopardikar, R. Rao, and K. Swartz, "Wavelet Analysis of Neuroelectric Waveforms: A Conceptual Tutorial," *Brain and Language* 66, 7-60(1999).
- [20]. Daubechies Ingrid, "Ten lectures on wavelets".
- [21]. Nicole A.M. de Beer *et al*, "Educational simulation of the electroencephalogram (EEG)"
- [22]. A. Jung 'Dissertation on Statistical Analysis of Biomedical Data'

EEG Artifact Removal Using A Wavelet Neural Network

¹Hoang-Anh T. Nguyen, ¹John Musson, ²Guangfan Zhang,
²Roger Xu, ³Carl Richey, ³Tom Schnell, ¹Frederic D.
McKenzie and ¹Jiang Li

¹Department of Electrical and Computer Engineering, Old Dominion University,
Norfolk, VA

²Signal Processing Group, Intelligent Automation, Inc., Rockville, MD

³Department of Industrial Engineering, University of Iowa, IA

1

Outline

- Introduction
- Related work
- Proposed method
- Experiment and results
- Discussion and conclusions

2

Outline

- Introduction
- Related work
- Proposed method
- Experiments and results
- Discussion
- Conclusions

3

EEG and artifacts

- **Electroencephalogram (EEG):**
 - Neural electrical signal
 - Recorded by using recording system
 - Important to many application fields: Computer control and communication, entertainment, education, military, commercial, etc.
- **Artifacts:**
 - Unavoidable non-cortical activities
 - Sources: Muscle activity, line noise, heart beating, eye movements and blinks, etc.
- **Electrooculogram (EOG) artifact:**
 - Generated by eye movements or blinks
 - Main artifactual portion of EEG recordings

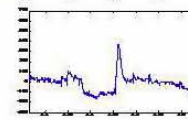
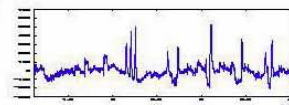
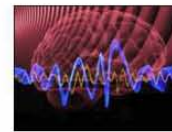

Contaminated EEG

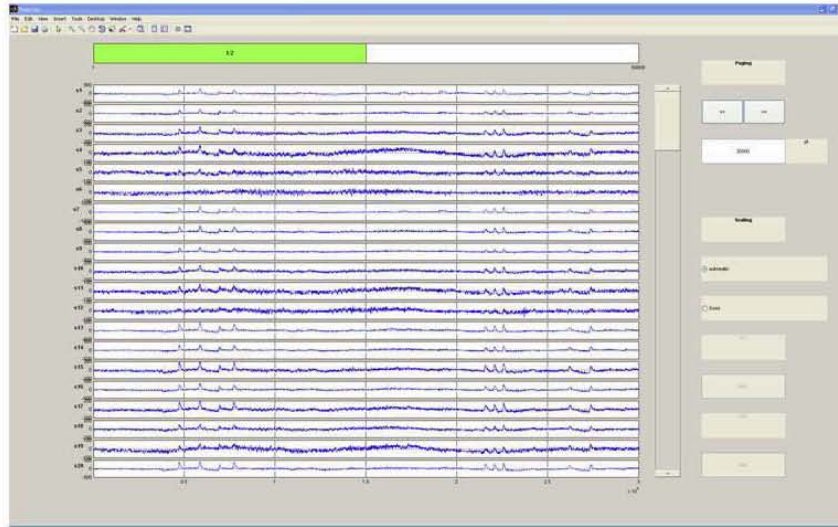

5

Artifact removal techniques

- Regressions in time/frequency
- Principle Component Analysis (PCA)
- Independent Component Analysis (ICA)
- Wavelet Thresholding (WT)
- Wavelet Neural Network (WNN)?

Techniques comparison

Techniques	Regression	PCA	ICA	WT	WNN
Need EOG?	Yes	Yes	No	No	?
Single channel	No	No	No	Yes	?
Reliability	?	?	Yes	No	?
Automatic	Yes	No	No	Yes	?

6

Wavelet neural network brief description

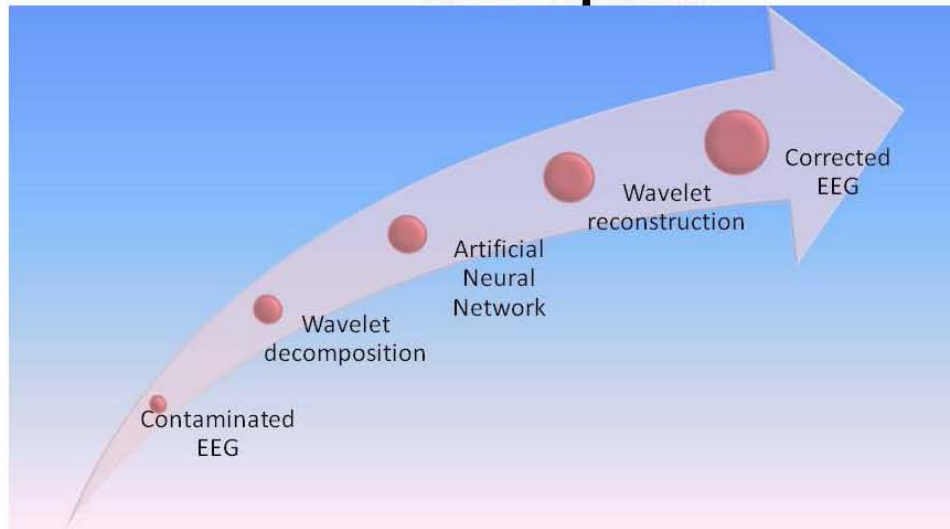

7

Outline

- Introduction
- Related work
- Proposed method
- Experiments and results
- Discussion
- Conclusions

8

EEG model

- EEG recordings
 - Contaminated EEG
 - Superposition of true EEG and propagated artifacts
- True EEG
 - Cortical signals excluding artifacts
- Propagated Artifacts
 - Non-cerebral activities
 - Contaminated EEG electrode recordings
 - Propagation factor k proportional to the recording electrode location

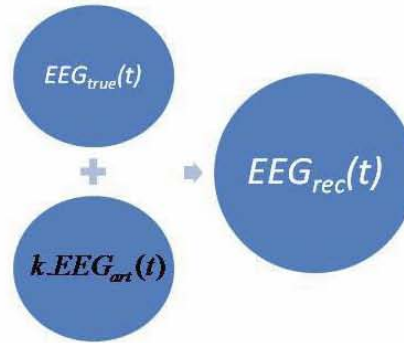

9

Wavelet transform

$$\Psi_{a,\tau}(t) = \psi\left(\frac{t-\tau}{a}\right)$$

$$W(a, \tau) = \frac{1}{\sqrt{a}} \int_{-\infty}^{\infty} x(t) \Psi_{a,\tau}^*(t) dt$$

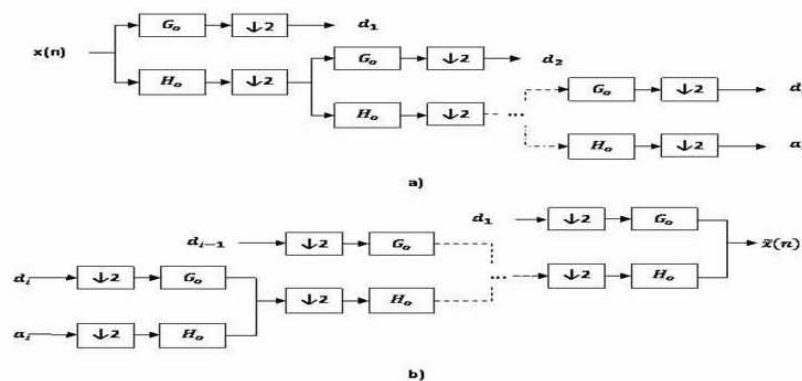
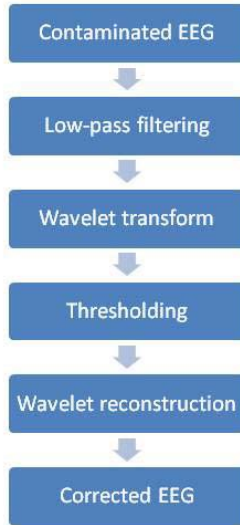

Figure 1. [a] Wavelet transform and [b] Wavelet reconstruction

10

Wavelet thresholding



- Threshold function[18]:

$$w_k^c(w, t) = \begin{cases} w + t - \frac{t}{2k+1}, & w < t \\ \frac{1}{(2k+1)t^{2k}} w^{2k+1}, & |w| \leq t \\ w + t + \frac{t}{2k+1}, & w > t \end{cases}$$

- Low-pass filter:
 - Butterworth
- Wavelet basis function selection:
 - Daubchies and Coiflet
 - Sensitive to time/frequency properties of EEG waves

11

Independent Component Analysis

- Notations:
 - \mathbf{x} original mixtures
 - \mathbf{s} blind source matrix
 - \mathbf{u} estimated source
 - \mathbf{A} mixing matrix
 - \mathbf{W} un-mixing matrix, inverse of \mathbf{A}
- ICA assumptions:
 - Source independence
 - Non-Gaussianity
 - \mathbf{A} and \mathbf{W} to be square and invertible
- Source independence definition:
 - Minimizing mutual information
 - Maximizing non-Gaussianity

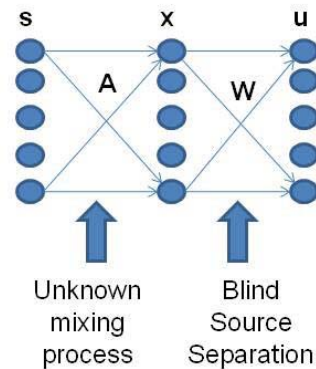

12

ICA in EEG artifact removal

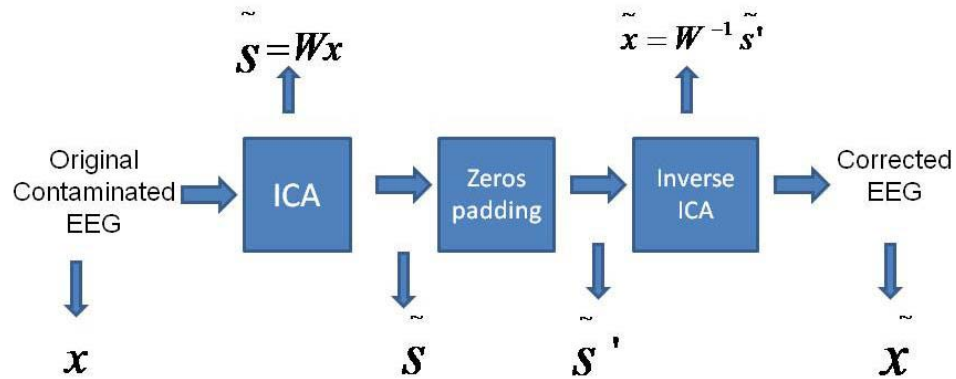

Being a batch algorithm, ICA needs to be performed on the whole data set with at least an adequate number of data points, so the computational power is expensive.

13

Outline

- Introduction
- Related work
- Proposed method
- Experiments and results
- Discussion
- Conclusions

14

Wavelet Neural Network

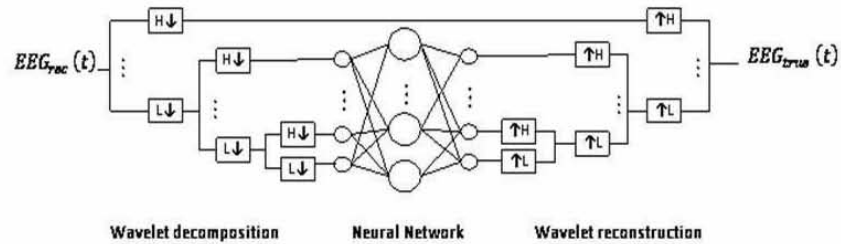

Figure 2. Wavelet Neural Network structure

15

Network Training

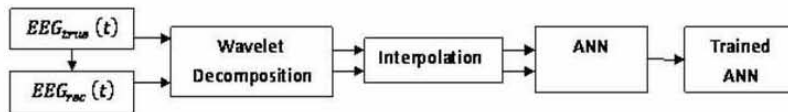

Figure 3. Neural network training procedure

16

EEG data simulation

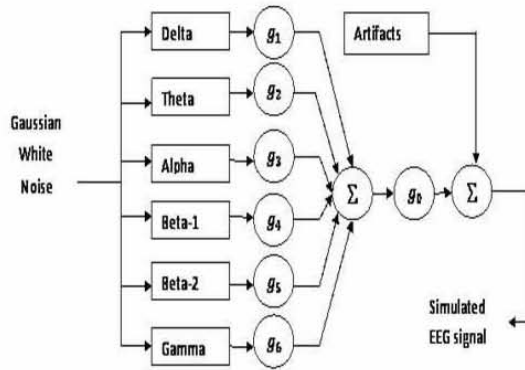

Table 1. EEG frequency band specifications

Freq. bands	Lower (Hz)	Upper (Hz)
Delta	0.5	4
Theta	4	8
Alpha	8	13
Beta-1	13	20
Beta-2	20	30
Gamma	30	50

Figure 4. Simulated EEG generator model

17

Simulated EEG

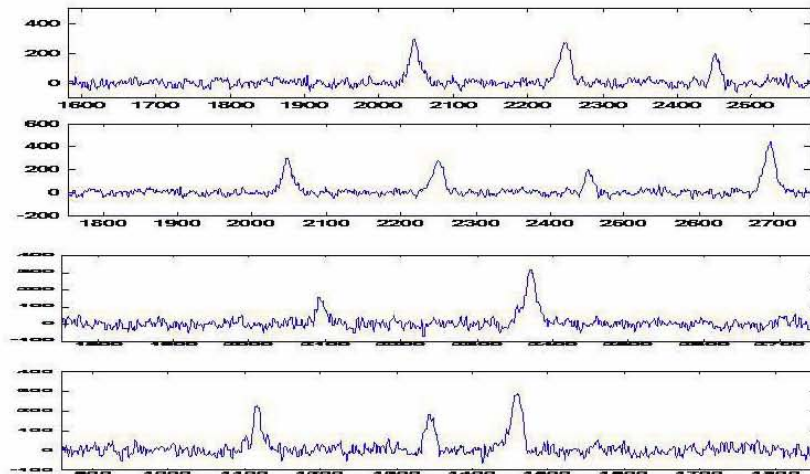

18

Network testing

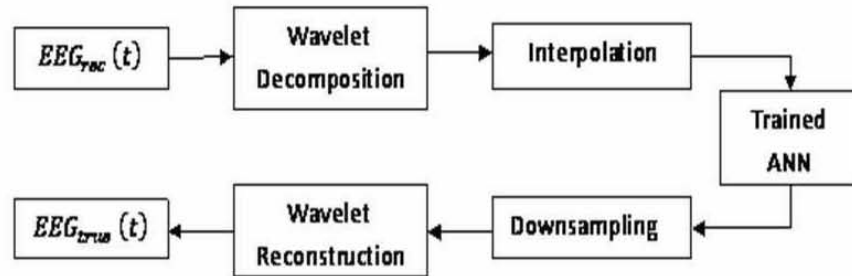

Figure 5. Wavelet Neural Network testing procedure

19

Outline

- Introduction
- Related work
- Proposed method
- Experiments and results
- Discussion and conclusions

20

Experiments

- Data set:
 - Driving test
 - 128 recording channel system
 - Highly disturbed by multi-type artifacts
- Experimental settings:
 - Methods: WNN, WT and ICA
 - Validation metrics: PSD and frequency correlation
 - Frequency correlation mathematical formula:

$$c = \frac{\frac{1}{2} * \sum_{w1}^{w2} (\tilde{x} * \tilde{y} + \tilde{y} * \tilde{x})}{\sqrt{\sum_{w1}^{w2} \tilde{x} \tilde{x} * \sum_{w1}^{w2} \tilde{y} \tilde{y}}}$$



21

Results – Simulated EEG

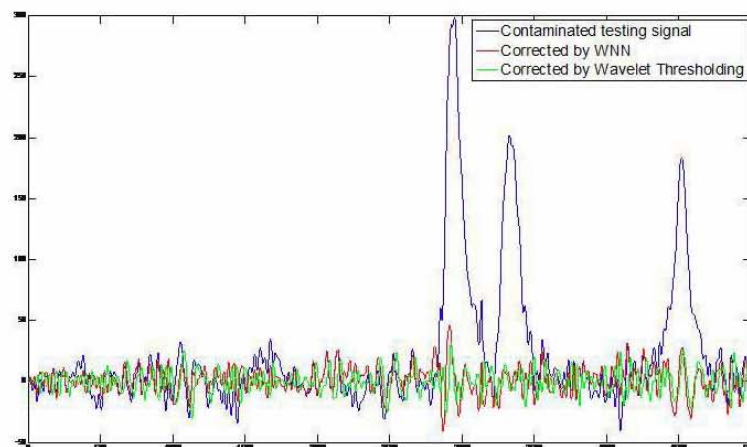

Figure 6. WNN performance on simulated data

22

Results – Simulated EEG

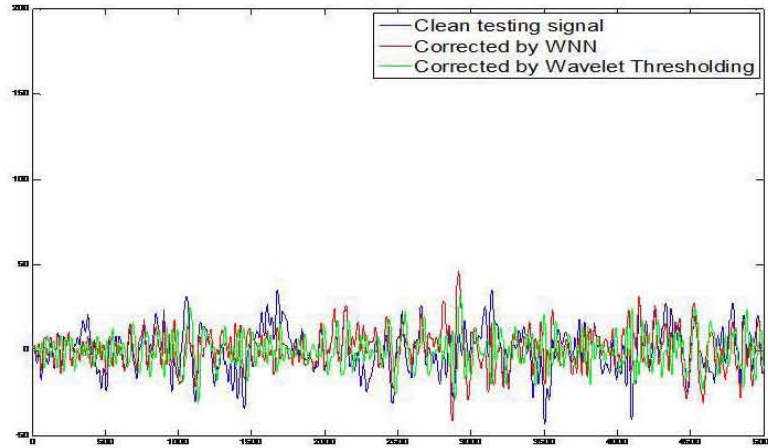

Figure 7. Clean simulated and Decontaminated signals by WNN and Wavelet Thresholding

23

Error signals

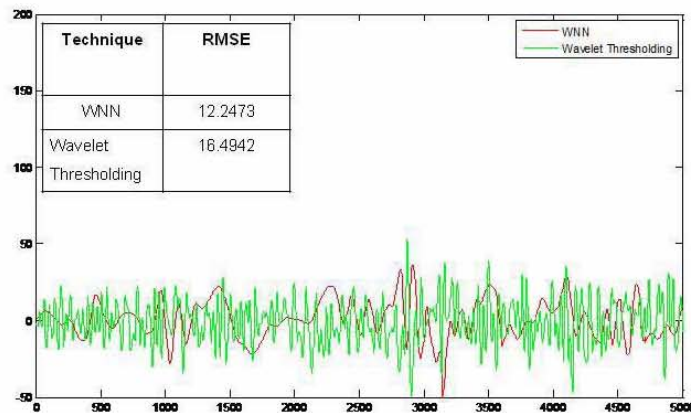

Figure 8. Error signals, or differences between the 'ground truth' and signals corrected by WNN and WT

24

PSD and frequency correlation

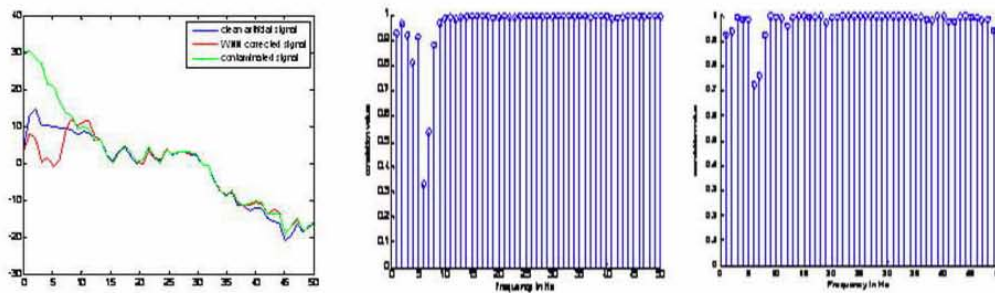

Figure 9. PSD (left) and frequency correlation between contaminated and corrected simulated signals (center) and clean and corrected simulated signals (right)

25

Results – Real EEG

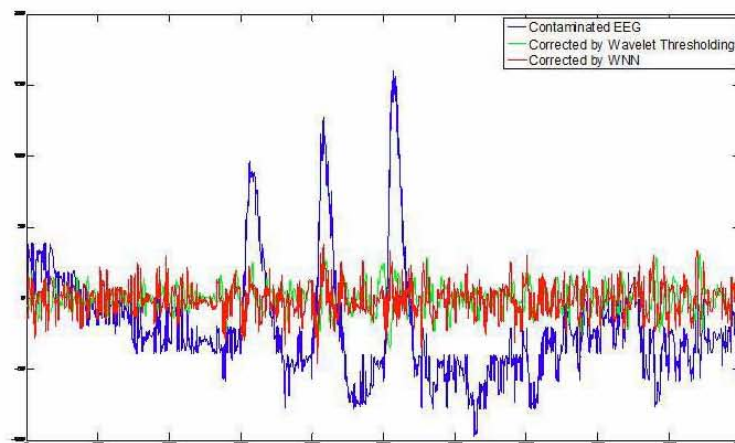

Figure 10. Contaminated, Wavelet Thresholding and WNN Corrected EEG

26

Results – Real EEG

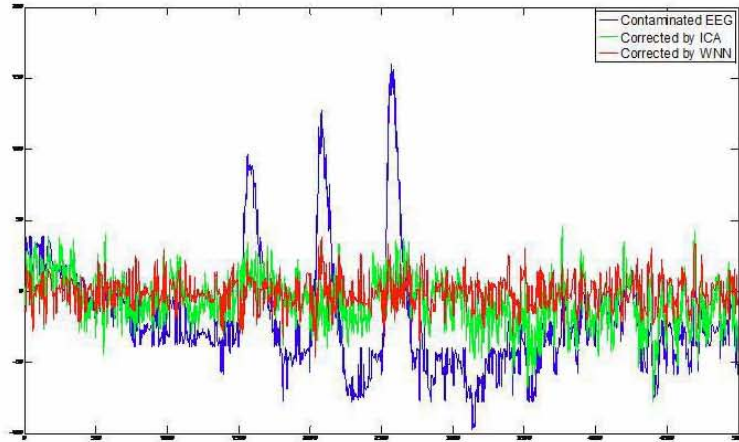

Figure 11. Contaminated, ICA and WNN Corrected EEG

27

Power Spectrum Density

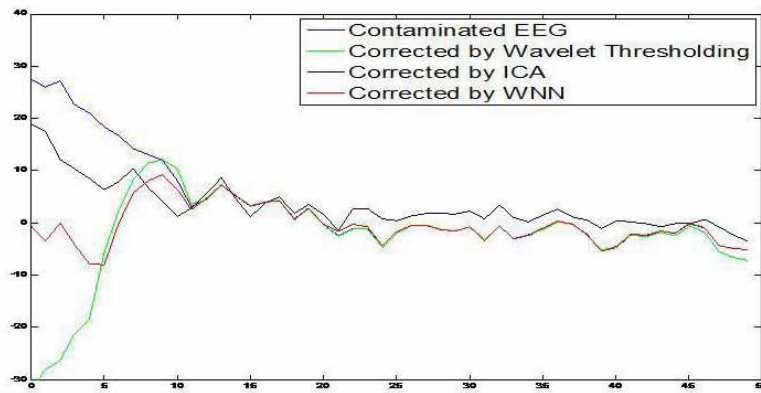

Figure 12. PSD of Contaminated and De-contaminated EEG

28

Frequency correlation

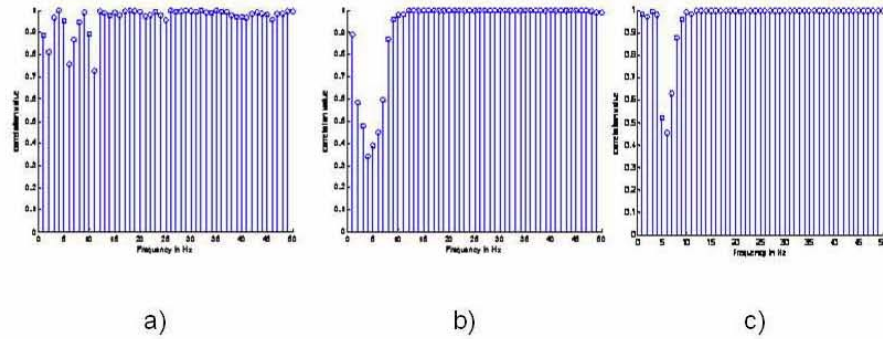

Figure 13. Frequency Correlation between Contaminated and Decontaminated EEG, (a) by ICA, (b) by Wavelet Thresholding and (c) by WNN

29

Outline

- Introduction
- Related work
- Proposed method
- Experiments and result
- Discussions and conclusions

30

Discussions

Techniques comparison

Techniques	Regression	PCA	ICA	WT	WNN
Need EOG	?Yes	Yes	No	No	No
Single channel	No	No	No	Yes	Yes
Reliability	?	?	Yes	No	Yes
Automatic	Yes	No	No	Yes	Yes

Wavelet Thresholding: It is sensitive to Wavelet basis function choice

ICA: computational complexity

31

Conclusions

- ❖ A novel and efficient method Wavelet Neural Network and its application to EEG artifact removal
- ❖ Make comparisons with several methods
 - ICA
 - Wavelet Thresholding
- ❖ Future work

32

References

1. T. Jung, S. Makeig, C. Humphries, T. Lee, M. Mckeown, V. Iragui, and T. J. Sejnowski, "Removing electroencephalographic artifacts by blind source separation," *Psychophysiology*, vol. 37, pp 163-178, 2000.
2. E. Urretarazu, J. Iriarte, M. Alegre, M. Valencia, C. Virri, and J. Artieda, "Independent component analysis removing artifacts in ictal recordings," *Epilepsia*, vol. 45, pp. 1071-1078, Sep. 2004.
3. Diego A. Pizzagalli, "Electroencephalography and High-Density Electrophysiological Source Localization", Chapter prepared for Cacioppo, J. T. et al., *Handbook of Psychophysiology* (3rd Edition)
4. D. Hagemann and E. Naumann, "The effects of ocular artifacts on (lateralized) broadband power in the EEG," *Clinical Neurophysiol.*, vol. 112, pp. 215-231, 2001.
5. C. A. Joyce, I. F. Gorodnitsky, and M. Kutas, "Automatic removal of eye movement and blink artifacts from EEG data using blind component separation," *Psychophysiology*, vol. 41, pp. 313 - 325 2004
6. Croft R J and Barry R J, "Removal of ocular artifact from the EEG: a review," *Clin. Neurophysiol.* Vol. 30, pp 5-19, 2000.
7. Kandaswamy A, Krishnaveni V, Jayaraman S, Malmurugan N and Ramadoss K, "Removal of ocular artifacts from EEG-a survey", *IETE J. Res.* Vol. 52 pp 121-130, 2005.
8. Gratton G, Coles M G and Donchin E, "A new method for off-line removal of ocular artifact," *Electroencephalogram. Clin. Neurophysiol.* Vol. 55, pp 84-468, 1983.
9. Woestenburg J C, Verbaten M N and Slangen J L, "The removal of the eye movement artifact from the EEG by regression analysis in the frequency domain," *Biol. Psychol.* Vol 16, pp 47-127, 1983
10. P. Berg, and M. Scherg, "Dipole models of eye activity and its application to the removal of eye artifacts from the EEG and MEG". *Clinical Physics and Physiological Measurements*, vol.12(Supplement A), pp49-54, 1991b.
11. T. D. Lagerlund, F. W. Sharbrough, and N. E. Busacker, "Spatial filtering of multichannel electroencephalographic recordings through principal component analysis by singular value decomposition". *Journal of Clinical Neurophysiology*, vol. 14, pp73-82, 1997.
12. P. Common, "Independent Component Analysis, A new concept?," *Signal Processing*, vol. 36, pp 287-314, 1994.
13. Delorme A, Makeig S and Sejnowski T, "Automatic artifact rejection for EEG data using high-order statistics and independent component analysis," *Proc. Third Int. ICA Conf.* pp 9-12, 2001
14. Krishnaveni, S. Jayaraman, L. Anitha and K. Ramadoss, "Removal of ocular artifacts from EEG using adaptive thresholding of wavelet coefficients," *J. Neu. Eng.* 3, pp 338-346, 2006
15. K.P. Indiradevi, E. Elias, P. S. Sathidevi, S. Dinesh Nayak and K. Radhakrishnan, "a multi-level wavelet approach for automatic detection of epileptic spikes in the electroencephalogram", *Com. In Bio. And Medicine* 38, pp 805-816, 2008
16. L. Senhadji, J.-L. Dillenseger, F. Wendling, C. Rocha, and A. Kinie, "Wavelet analysis of EEG for three-dimensional mapping of epileptic events," *Ann. Biomed Eng.* Vol. 23(5), pp 543-552, 1995
17. V. J. Samar, A. Bopardikar, R. Rao and K. Swartz, "Wavelet analysis of neuroelectric waveforms: A conceptual tutorial", *Brain and Language*, Vol. 66, pp 7-60, 1999.
18. X. P. Zheng and M. D. Desai "Adaptive denoising based on SURE risk," *IEEE Sig. Pro. Letters*, Vol. 5, No. 10, Oct. 1998
19. V. J. Samar, A. Bopardikar, R. Rao, and K. Swartz, "Wavelet Analysis of Neuroelectric Waveforms: A Conceptual Tutorial," *Brain and Language* 66, 7-60(1999).
20. Daubechies Ingrid, "Ten lectures on wavelets".
21. Nicole A.M. de Beer *et al*, "Educational simulation of the electroencephalogram (EEG)"
22. A. Jung "Dissertation on Statistical Analysis of Biomedical Data"

33

Thank You !

Q & A

34