



Improving Data Collection and Analysis Interface for the Data Acquisition Software of the Spin Laboratory at NASA Glenn Research Center

Ali Abdul-Aziz
Cleveland State University, Cleveland, Ohio

Ben S. Curatolo and Mark R. Woike
Glenn Research Center, Cleveland, Ohio

NASA STI Program . . . in Profile

Since its founding, NASA has been dedicated to the advancement of aeronautics and space science. The NASA Scientific and Technical Information (STI) program plays a key part in helping NASA maintain this important role.

The NASA STI Program operates under the auspices of the Agency Chief Information Officer. It collects, organizes, provides for archiving, and disseminates NASA's STI. The NASA STI program provides access to the NASA Aeronautics and Space Database and its public interface, the NASA Technical Reports Server, thus providing one of the largest collections of aeronautical and space science STI in the world. Results are published in both non-NASA channels and by NASA in the NASA STI Report Series, which includes the following report types:

- **TECHNICAL PUBLICATION.** Reports of completed research or a major significant phase of research that present the results of NASA programs and include extensive data or theoretical analysis. Includes compilations of significant scientific and technical data and information deemed to be of continuing reference value. NASA counterpart of peer-reviewed formal professional papers but has less stringent limitations on manuscript length and extent of graphic presentations.
- **TECHNICAL MEMORANDUM.** Scientific and technical findings that are preliminary or of specialized interest, e.g., quick release reports, working papers, and bibliographies that contain minimal annotation. Does not contain extensive analysis.
- **CONTRACTOR REPORT.** Scientific and technical findings by NASA-sponsored contractors and grantees.

- **CONFERENCE PUBLICATION.** Collected papers from scientific and technical conferences, symposia, seminars, or other meetings sponsored or cosponsored by NASA.
- **SPECIAL PUBLICATION.** Scientific, technical, or historical information from NASA programs, projects, and missions, often concerned with subjects having substantial public interest.
- **TECHNICAL TRANSLATION.** English-language translations of foreign scientific and technical material pertinent to NASA's mission.

Specialized services also include creating custom thesauri, building customized databases, organizing and publishing research results.

For more information about the NASA STI program, see the following:

- Access the NASA STI program home page at <http://www.sti.nasa.gov>
- E-mail your question via the Internet to help@sti.nasa.gov
- Fax your question to the NASA STI Help Desk at 443-757-5803
- Telephone the NASA STI Help Desk at 443-757-5802
- Write to:
NASA Center for AeroSpace Information (CASI)
7115 Standard Drive
Hanover, MD 21076-1320

NASA/TM—2011-217214



Improving Data Collection and Analysis Interface for the Data Acquisition Software of the Spin Laboratory at NASA Glenn Research Center

Ali Abdul-Aziz
Cleveland State University, Cleveland, Ohio

Ben S. Curatolo and Mark R. Woike
Glenn Research Center, Cleveland, Ohio

National Aeronautics and
Space Administration

Glenn Research Center
Cleveland, Ohio 44135

September 2011

This report contains preliminary findings,
subject to revision as analysis proceeds.

Trade names and trademarks are used in this report for identification
only. Their usage does not constitute an official endorsement,
either expressed or implied, by the National Aeronautics and
Space Administration.

Level of Review: This material has been technically reviewed by technical management.

Available from

NASA Center for Aerospace Information
7115 Standard Drive
Hanover, MD 21076-1320

National Technical Information Service
5301 Shawnee Road
Alexandria, VA 22312

Available electronically at <http://www.sti.nasa.gov>

Improving Data Collection and Analysis Interface for the Data Acquisition Software of the Spin Laboratory at NASA Glenn Research Center

Ali Abdul-Aziz
Cleveland State University
Cleveland, Ohio 44115

Ben S. Curatolo¹ and Mark R. Woike
National Aeronautics and Space Administration
Glenn Research Center
Cleveland, Ohio 44135

Abstract

In jet engines, turbines spin at high rotational speeds. The forces generated from these high speeds make the rotating components of the turbines susceptible to developing cracks that can lead to major engine failures. The current inspection technologies only allow periodic examinations to check for cracks and other anomalies due to the requirements involved, which often necessitate entire engine disassembly. Also, many of these technologies cannot detect cracks that are below the surface or closed when the crack is at rest. Therefore, to overcome these limitations, efforts at NASA Glenn Research Center are underway to develop techniques and algorithms to detect cracks in rotating engine components. As a part of these activities, a high-precision spin laboratory is being utilized to expand and conduct highly specialized tests to develop methodologies that can assist in detecting predetermined cracks in a rotating turbine engine rotor.

This paper discusses the various features involved in the ongoing testing at the spin laboratory and elaborates on its functionality and on the supporting data system tools needed to enable successfully running optimal tests and collecting accurate results. The data acquisition system and the associated software were updated and customized to adapt to the changes implemented on the test rig system and to accommodate the data produced by various sensor technologies. Discussion and presentation of these updates and the new attributes implemented are herein reported.

Introduction

The theory behind the crack detection scheme is that a crack, or some other related condition, will cause a shift in the center of mass of the disk, thus modifying the turbine disk's vibrational characteristics compared with those typically experienced by an undamaged turbine disk. Earlier work on this research covered running spin tests of a 32-blade disk that simulated a turbine engine-like rotor, where tip clearance measurements were collected using capacitive sensors (Refs. 1 to 4). These tests were conducted to help establish a crack detection methodology to monitor the health of rotating aircraft engine components. This is to improve safety and lower maintenance costs. Typically, health monitoring systems require a sensor system that must sustain operation in a harsh engine environment. For rotors, the sensor and software must be able to detect a crack above a pre-specified size, but below a critical length that would lead to failure. The intended health management system should operate independently and act neutrally upon the overall performance of the engine system and not interfere with engine maintenance operations. Presently, there are research activities and many techniques that are being used in the detection of any cracks that may have formed before failure (Refs. 5 to 10). These techniques are limited to applying nondestructive evaluation (NDE) approaches. However, their effectiveness and reliability vary substantially depending on the inspection conditions (Ref. 1). This highlights the need for more

¹NASA Glenn Research Center, John Carroll University, summer intern.

trustworthy and reliable diagnostic tools for damage detection and health monitoring of the rotating components to ensure engine safety and dependability. Besides improving safety, health monitoring can also reduce maintenance costs.

The NASA Aviation Safety Program (AvSP) recognizes that issues regarding safety and maintainability are of high concern, so efforts to develop the needed technology are ongoing. This ambitious program is a partnership that includes NASA, the Federal Aviation Administration (FAA), the aviation industry, and the Department of Defense (Ref. 2). Developing health management and ultrasafe engine technologies are the primary goals of this project.

This paper discusses the spin rig capabilities, hardware upgrades, and data acquisition software updates. These upgrades include eddy current sensors for measuring shaft displacement positions and enhancement of the usability of the LabVIEW (Ref. 12) data-acquisition-based software by integrating three modules into one single cohesive entity written in the most current version of LabVIEW. Discussion and presentations of these updates and the new attributes implemented are summarized in this report.

Spin Laboratory Description

Figure 1(a) shows a full layout of the Rotor Dynamics Laboratory along with all the equipment. The spin laboratory operates under specified conditions and it allows the disk rotor to be rotated at variable speeds at various conditions and at settings that are monitored by the operator via a series of equipment and the data acquisition system. A picture showing an artificially induced crack-notch in the disk, along with the blade tip clearance probe, is shown in Figure 1(b). The test specimen disk has an outside diameter of 23.495 cm (9.25 in.); a bore and an outside rim thickness of 2.54 cm (1 in.) and 3.175 cm (1.25 in.). The thickness of the web is 0.254 cm (0.10 in.), and the cross section and height of the blades are 3.175 by 0.330 cm (1.25 by 0.13 in.) and 0.838 cm (0.33 in.), respectively. The disk rotor has 32 blades evenly spaced around the circumference.

Eight holes with a 0.508 cm (0.20 in.) diameter each were drilled through the disk halfway in the rim. The holes were spaced every 45° and were designed for future studies as possible mass attachment points or notch initiation sites. The weight of the disk is (4.88 KG) 10.75 lb and the materials being used for manufacturing the disk are nickel-base alloy Haynes X-750 and Grade 2 Titanium; test specimens were made for each material. Additional details about the system can be found in Reference 3.

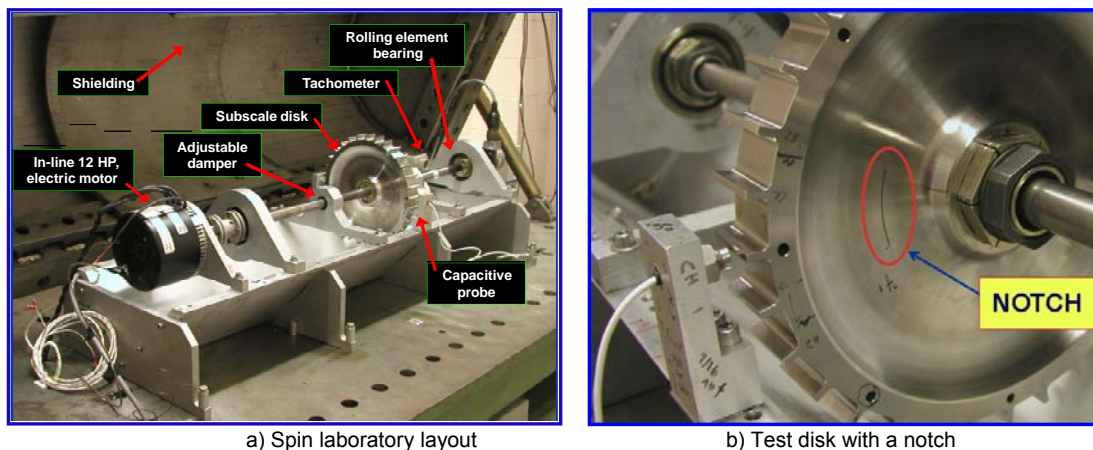

Figure 1.—Rotor dynamics spin laboratory equipment layout and the disk specimen.

Data Acquisition Software Description

The data acquisition software in the spin rig setup is considered the focal element in terms of data acquisition and analysis. The previous data collection routine utilized LabVIEW Version 6 (Ref. 11) based software and consisted of three different subroutines each with a separate function. They are simply a collection of functions introduced in Virtual Instrument (VI) modules or front end panels. The purpose of such tools and programming is to automate the usage of processing and measuring equipment in the laboratory setup. However, the previous data collection routine lacks flexibility and robustness. It is very primitive and uses an old file format that requires a long processing time to analyze and sort data. In addition, the files produced during data acquisition are relatively large and processing time is dependent on test length and mission profile complexity. For instance, for a simple 10-min, 3000-rpm test acquisition run, data processing and analysis takes 541 sec, or approximately 9 min. This deficiency created an undesired situation and caused holdups in evaluating the results and delays in testing.

Simultaneously with the continuous equipment upgrades, such as new sensors, digital tachometers, high-speed cameras, etc., the LabVIEW-based data acquisition software needed to be modified to accommodate the changes made. Figures 2(a) and (b) show the original and the currently updated data logger front panel VI for recording the data measurements. The original setup consisted of three programs. The data logger, or the first VI, functioned as a standalone unit that recorded measurements and readings from the sensors and other instruments. The second VI, also known as the reader, was used to analyze, sort, and convert the raw data voltage readings into meaningful units. The last VI module, referred to as the display, allows the representation of the results in graphical charts, such as the trace of vibration vector, X and Y components, blade tip clearance, rotational speed versus time, blade time of arrival, amplitude, and phase angle. Figure 2(b), which represents a view of the updated front panel, has all of the previously mentioned options combined into one single panel that displays more selections with greater details. Therefore, the need for a more efficient VI module to overcome all of the later difficulties and enable the use of the latest programming technology and tools available was a necessary option to pursue.

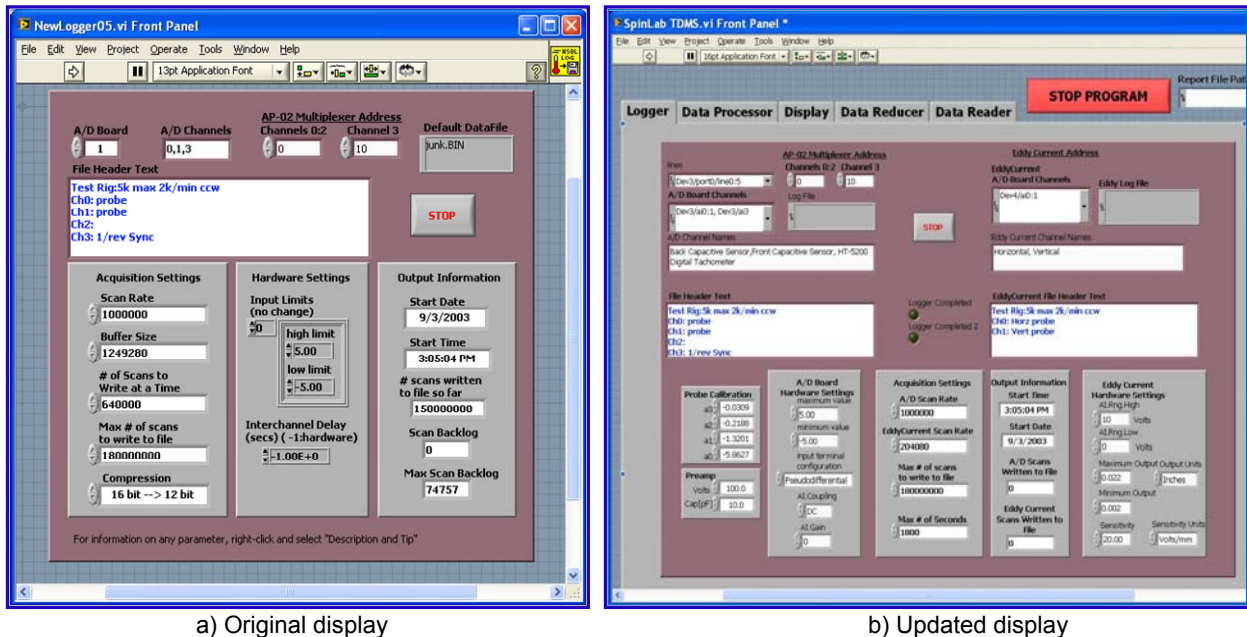

Figure 2.—Display of the front end data logger VI.

Software Enhancements and Updates

To overcome the above difficulties in the data analysis and processing, a complete restructuring of the three LabVIEW programs front panels was implemented. A major shift in the file format was adopted by switching from the standard old high-speed data logger (HSDL) format (LabVIEW Version 6.0) to the newer technical data management streaming (TDMS) format, in the latest LabVIEW version, that is, LabVIEW 9.0. National Instruments (NI) introduced the Technical Data Management Streaming (TDMS) file format as a result of the deficiencies of other data storage options commonly used in test and measurement applications. The binary TDMS file format is an easily exchangeable, inherently structured, high-speed-streaming-capable file format that, when combined with the other technologies in the NI TDM solution, becomes quickly searchable without the need for complicated and expensive database design, architecture, or maintenance (Ref. 12).

Figure 3 shows a display of the new and improved front panel VI that includes all of the three original programs or VIs. The data reader option tab, shown in the figure, reads the newly installed eddy current sensors. Improvements and updates consist of making the displays interactive and adding the capability of simultaneously overlaying two data sets during analysis. Options to include additional sensors and the ability to perform signal processing on raw data are examples of the new features that have been added. This version of the software is automated such that upon completion of logging or recording the data, the software will automatically activate the reader, and subsequently the display and the eddy current data analyzer, respectively. The user will only have to perform periodic monitoring and save the results files as prompted during the analysis process. Interactive displays of critical testing information are also displayed in real time during the analysis procedure. The graphs in Figure 3 show signal processing of voltage data and the sinusoidal response, blade tip clearance, speed versus time, and critical speed response in addition to many other parameters that are of importance to testing. Such information is highly essential and beneficial to the success of test runs and proper achievements of anticipated results. Furthermore, the front end contained functions to display, record, and input various parameters. Examples of such parameters are dates, clock time test time, test length, scanning rate, experimental constraints and limits, hardware identification channels and settings, buffer size, image captures, report generation, critical speed and center of mass calculations, performance data of the equipment (e.g., voltage and temperature), as well as other important statistics. Data file directory names and locations are also displayed.

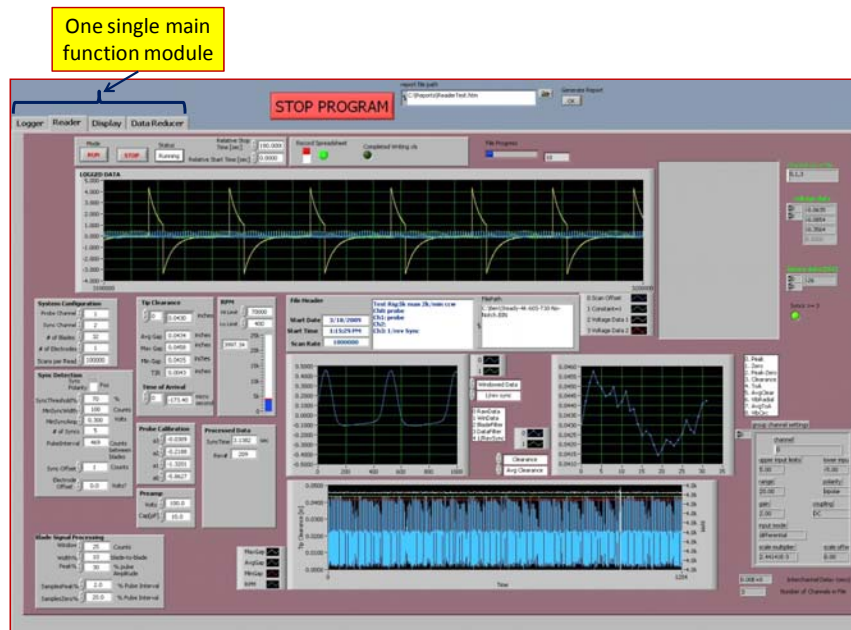

Figure 3.—Data acquisition software front end display.

Figure 4 represents a sample output display of the newly updated software. As noted, the display is widely diversified and offers an ample range of information. It is designed to show various results in different representations and other relevant test data. The software displays are interactive and the software has the capability of simultaneously overlaying two data sets during analysis. This feature has simplified the comparison of test results and characterization of the findings with a higher level of accuracy than was previously attainable. An action window, identified as the Data Analysis Progress Display in Figure 4, has also been added to the VI display to monitor the elapsed processing time and completion percentage. Such options greatly assisted in the data processing, analysis, and time management. Options to include additional sensors and the ability to perform signal processing on raw data are also examples of new software features that have been added (see Fig. 5).

Figure 5 represents an output display showing the newly added feature of sensor reader of both eddy current and capacitive sensors. The earlier version of the software lacked this option due to the nonexistence of the eddy current sensors. The eddy current sensor monitors the rotating shaft displacement and the capacitive one observes the rotor blade tip displacement. Such addition has added a much needed attribute to the software capabilities and to the experimental capacities. The sensors reader display allows the user to monitor the sensors response and other information related to the files directory, storage locations, experimental outputs, etc.

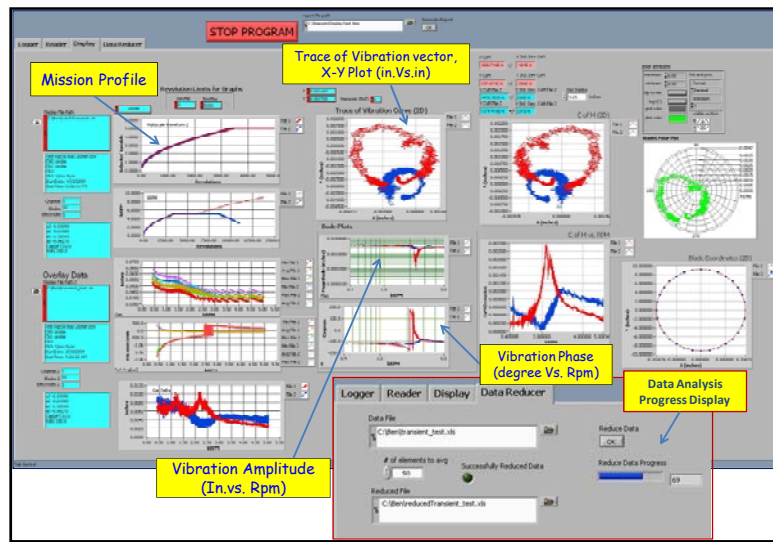

Figure 4.—Data acquisition software sample output display.

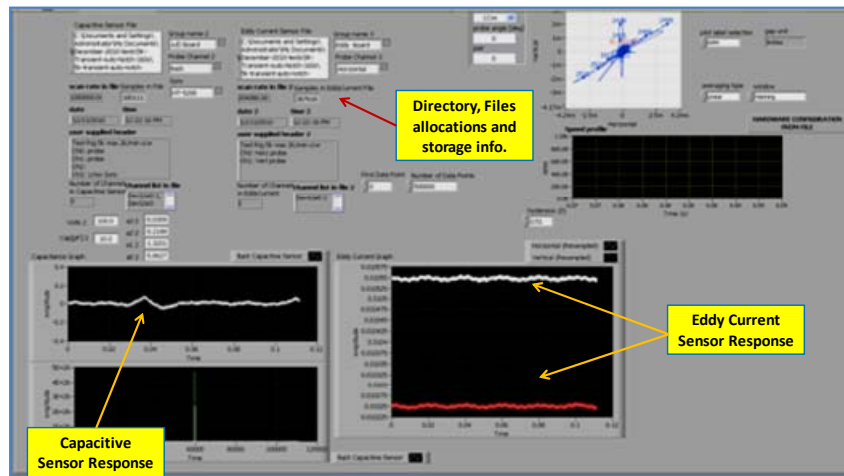

Figure 5.—Data acquisition sample output display showing eddy current response.

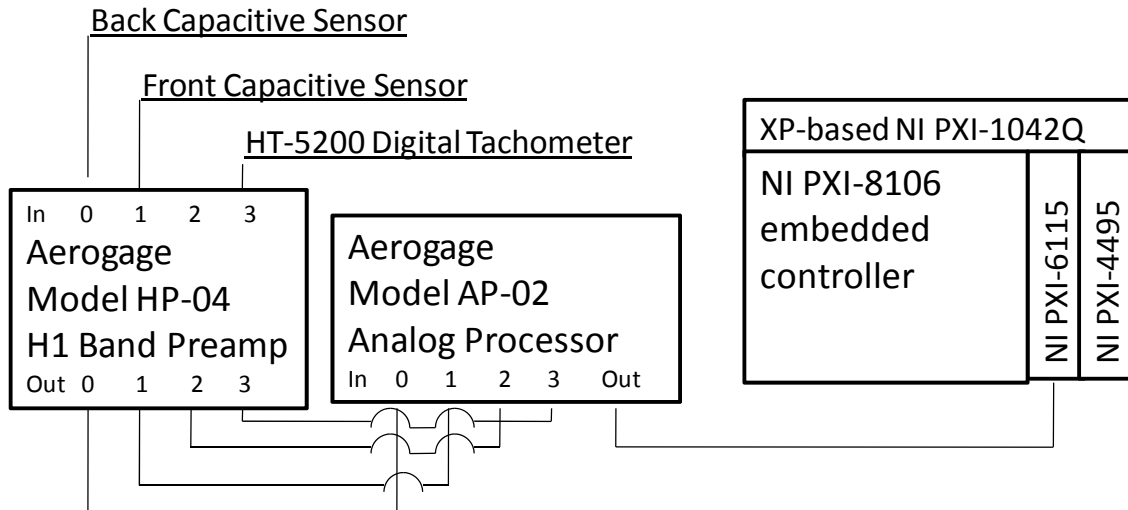

Figure 6.—Data acquisition hardware system diagram.

TABLE I.—DATA COMPARISON AND TIME SAVING RATE USING THE UPDATED HARDWARE

Transient spin test	Data file size, MB	Old software processing time, sec	New software processing time, sec	Time saving rate, percent
Old 3000 rpm	159	541	284	47
Old 5000 rpm	195	910	478	47
New 3000 rpm	219	541	304	44
New 5000 rpm	260	910	476	48
10 000 rpm	1188	3504	1501	57

Figure 6 represents the data acquisition system hardware diagram. It contains one set of capacitive sensors, a digital tachometer, a preamplifier, and an analog processor. Data is recorded from the sensors at a rate of 1 MHz per channel. The output of the analog processor was interfaced with a NI controller having a Windows XP-based NI PXI-1042Q chassis with core 2 capacity, a T6400 2.13-GHz processor, and 4 GB of RAM. The PXI-1042Q was the best NI controller available; higher capacity systems were not available when the spin rig was being upgraded. The prior system was a PXI-8171 series with a maximum of 1.266 GHz and a memory size of 512 KB RAM. This had resulted in a noticeable reduction of processing time.

The updated software capabilities were checked against the old data acquisition routine. Several spin tests were conducted to gather enough data to enable verification of the robustness and the efficiency of the updated software. The speed applied during the current testing ranged from a minimum of 3000 rpm up to a maximum of 10 000 rpm, with acceleration-deceleration rates of 60 rpm/sec. This speed range ensured surpassing the critical speed of 2610 rpm leading to post-critical state, which is the state where the system reaches stability without any systemic vibration. Table I contains a display of the results of test data comparisons for various rotational speeds and test times using the upgraded computer hardware, the PXI-1042Q. An obvious improvement can be noted as a nearly 50 percent decrease in processing time was achieved. For instance, for the 10 000 rpm test, data processing required 3504 sec or 58.4 min. The newly updated routine resulted in a 57 percent reduction in processing time, which equates to 33.4 min. This delivered a tremendous outcome resulting in increased testing capability and faster data, which in return helped expanding the productivity of experiments. The effectiveness of the algorithms employed in managing and sorting the data has facilitated and minimized the workload enormously. One disadvantage of using the TDMS file format lies in its tendency to generate larger file sizes than the compressed HSDL. However, this constituted no major issue since vastly larger data storage devices are now easily available and are relatively very inexpensive.

TABLE II.—DATA COMPARISON AND TIME SAVING RATE BETWEEN OLD AND NEW HARDWARE FOR EQUAL SIZE DATA FILES

Spin test	Data file size, KB	New software processing time, sec	Old software processing time, sec	Time saving rate, percent	Computer hardware
10 000 rpm transient (short test)	1 142 579	695	885	21.45	Updated PXI-1042Q
10 000 rpm transient (short test)	1 142 579	N/A	14 220	95	Old PXI-8171 series

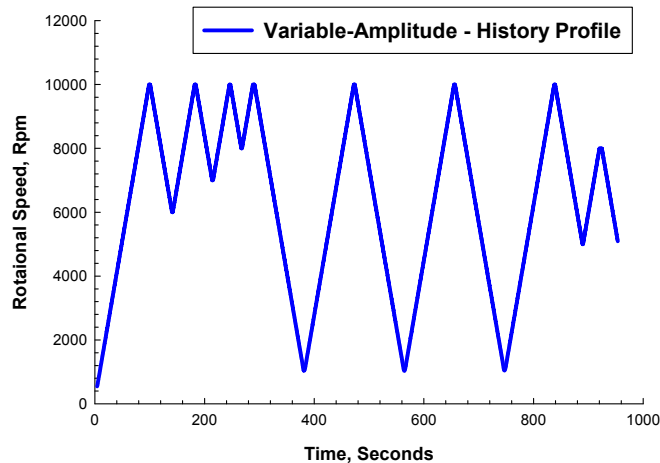

Figure 7.—Typical test mission history profile; variable amplitude.

Table II shows a comparison of data processing time for test results of data files that are of equal size for the two NI systems used, outdated older and new updated. In fact, the data listed in Table II clearly shows that the updated hardware has made a substantial improvement to the data processing acquisition time. For instance, for a 10 000 rpm transient test, its data file size of 1 142 579-KB processing time is reduced by 21 percent from 885 to 695 sec by using the updated PXI-1042Q system. Furthermore, for the same 10 000 rpm transient test, the difference between the old data acquisition system and the updated one has shown that the processing time has been reduced by 95 percent from a high of 14 220 sec to a low of 695 sec. Therefore, the combination of both the updated hardware system and the new software has offered remarkable and much needed improvements to the testing procedure and resulted in hefty time saving in the data collection and processing time.

In addition, testing indicated that the memory limitation of the PXI-1042Q, a maximum of 4 GB of RAM, had impacted the performance of the data processing to some extent. Also, adding the capability to log data from the eddy current sensor has made the software far more user friendly than the initial data logger routine. With the updated layout, the user is able to completely process and analyze the data using a single screen window. Figure 7 shows a typical test mission history test profile indicating the complexity of the test and the time required for completion. The total time needed to wrap up this test required 970 sec of data collection and over 4 GB of data storage.

Conclusions and Future Work

The necessity of coordinating the results from separate applications was removed by integrating the functions of the three applications into one new program. The updated program has the ability to record and process data from eddy current sensors in parallel with the already existing capacitive sensors. New program features include the ability to display data from two different trial runs simultaneously to aid in data analysis. The addition of center of mass and critical speed disk calculations enhanced the software

support for the LabVIEW technical data management streaming (TDMS) file format, and a reader Virtual Instrument (VI) that can apply filters, compute Fast Fourier Transform (FFT), and simulate signal processing to the raw data collected from the spin rig. Also, hardware improvements and updates were the key factors in enhancing the overall performance of the system. Future goals are to include syncing rotational speed with eddy current data, integrating newer rotor dynamics calculations, validation of center of mass and critical speed calculations, and improving documentation of results.

References

1. Woike, M.R.; and Abdul-Aziz, A.: Crack-Detection Experiments on Simulated Turbine Engine Disks in NASA Glenn Research Center's Rotordynamics Laboratory. AIAA-2010-587 (NASA/TM-2010-216239), 2010.
2. Abdul-Aziz, A., et al.: Development of a Flaw Detection/Health Monitoring Scheme for Turbine Engine Rotating Components. Presented at the AIAA Infotech@Aerospace 2010, Atlanta, GA, 2010.
3. Abdul-Aziz, Ali, et al.: NDE Using Sensor Based Approach to Propulsion Health Monitoring of a Turbine Engine Disk. SPIE Smart Structure/NDE, San Diego, CA, 2009.
4. Abdul-Aziz, A.; Trudell, J.J.; and Baaklini, George Y.: Finite Element Design Study of a Bladed, Flat Rotating Disk To Simulate Cracking in a Typical Turbine Disk, Part II. Proceedings of the 11th SPIE's Annual International Symposium on Nondestructive Evaluation for Health Monitoring and Diagnostics, San Diego, CA, 2006.
5. Simon; Donald L.: An Overview of the NASA Aviation Safety Program Propulsion Health Monitoring Element. NASA/TM-2000-210348 (AIAA-2000-3624), 2000.
6. Drumm, M.J.: Nondestructive, Real-Time Measurement of Cracks in Jet Engine Rotors. 1998. www.testdevices.com Accessed August 29, 2011.
7. Sonnichsen, H.E.: Real-Time Detection of Developing Cracks in Jet Engine Rotors. IEEE 0-7803-5846-5/00, 2000. www.testdevices.com Accessed August 29, 2011.
8. Bently, D.E.: Detecting Cracked Shafts at Earlier Levels. Orbit Magazine, vol. 3, no. 2, 1982.
9. Sekar, A.S.; and Prabhu, B.S.: Condition Monitoring of Cracked Rotors Through Transient Response. Mechanism and Machine Theory, vol. 33, issue 8, 1998, pp. 1167-1175.
10. Wauer, J.: On the Dynamics of Cracked Rotors: A Literature Survey. Appl. Mech. Rev., vol. 43, no. 1, 1990, pp. 13-17.
11. LabVIEW 2010 Software. Austin, TX, 2010.
12. National Instruments Developer Zone. August 16, 2010. <http://zone.ni.com/devzone/cda/tut/p/id/3727%20> Accessed August 29, 2011.

REPORT DOCUMENTATION PAGE			Form Approved OMB No. 0704-0188		
<p>The public reporting burden for this collection of information is estimated to average 1 hour per response, including the time for reviewing instructions, searching existing data sources, gathering and maintaining the data needed, and completing and reviewing the collection of information. Send comments regarding this burden estimate or any other aspect of this collection of information, including suggestions for reducing this burden, to Department of Defense, Washington Headquarters Services, Directorate for Information Operations and Reports (0704-0188), 1215 Jefferson Davis Highway, Suite 1204, Arlington, VA 22202-4302. Respondents should be aware that notwithstanding any other provision of law, no person shall be subject to any penalty for failing to comply with a collection of information if it does not display a currently valid OMB control number.</p> <p>PLEASE DO NOT RETURN YOUR FORM TO THE ABOVE ADDRESS.</p>					
1. REPORT DATE (DD-MM-YYYY) 01-09-2011		2. REPORT TYPE Technical Memorandum		3. DATES COVERED (From - To)	
4. TITLE AND SUBTITLE Improving Data Collection and Analysis Interface for the Data Acquisition Software of the Spin Laboratory at NASA Glenn Research Center			5a. CONTRACT NUMBER		
			5b. GRANT NUMBER		
			5c. PROGRAM ELEMENT NUMBER		
6. AUTHOR(S) Abdul-Aziz, Ali; Curatolo, Ben, S.; Woike, Mark, R.			5d. PROJECT NUMBER		
			5e. TASK NUMBER		
			5f. WORK UNIT NUMBER WBS 284848.02.03.02.01		
7. PERFORMING ORGANIZATION NAME(S) AND ADDRESS(ES) National Aeronautics and Space Administration John H. Glenn Research Center at Lewis Field Cleveland, Ohio 44135-3191			8. PERFORMING ORGANIZATION REPORT NUMBER E-17895		
9. SPONSORING/MONITORING AGENCY NAME(S) AND ADDRESS(ES) National Aeronautics and Space Administration Washington, DC 20546-0001			10. SPONSORING/MONITOR'S ACRONYM(S) NASA		
			11. SPONSORING/MONITORING REPORT NUMBER NASA/TM-2011-217214		
12. DISTRIBUTION/AVAILABILITY STATEMENT Unclassified-Unlimited Subject Categories: 01 and 05 Available electronically at http://www.sti.nasa.gov This publication is available from the NASA Center for AeroSpace Information, 443-757-5802					
13. SUPPLEMENTARY NOTES Ben S. Curatolo, NASA Glenn Research Center, John Carroll University, summer intern.					
14. ABSTRACT In jet engines, turbines spin at high rotational speeds. The forces generated from these high speeds make the rotating components of the turbines susceptible to developing cracks that can lead to major engine failures. The current inspection technologies only allow periodic examinations to check for cracks and other anomalies due to the requirements involved, which often necessitate entire engine disassembly. Also, many of these technologies cannot detect cracks that are below the surface or closed when the crack is at rest. Therefore, to overcome these limitations, efforts at NASA Glenn Research Center are underway to develop techniques and algorithms to detect cracks in rotating engine components. As a part of these activities, a high-precision spin laboratory is being utilized to expand and conduct highly specialized tests to develop methodologies that can assist in detecting predetermined cracks in a rotating turbine engine rotor. This paper discusses the various features involved in the ongoing testing at the spin laboratory and elaborates on its functionality and on the supporting data system tools needed to enable successfully running optimal tests and collecting accurate results. The data acquisition system and the associated software were updated and customized to adapt to the changes implemented on the test rig system and to accommodate the data produced by various sensor technologies. Discussion and presentation of these updates and the new attributes implemented are herein reported.					
15. SUBJECT TERMS Rotor dynamics; Spin laboratory; Labview; Software development; Data acquisition; Crack detection; Eddy current					
16. SECURITY CLASSIFICATION OF:			17. LIMITATION OF ABSTRACT	18. NUMBER OF PAGES 24	19a. NAME OF RESPONSIBLE PERSON STI Help Desk (email: help@sti.nasa.gov)
a. REPORT U	b. ABSTRACT U	c. THIS PAGE U			UU

