

2201

LOW COST NUCLEAR THERMAL ROCKET CERMET FUEL ELEMENT ENVIRONMENT TESTING (CFEET)

David E. Bradley



Nuclear Systems, NASA MSFC
Huntsville, AL

Purpose of Test Hardware

- Low-Cost, small scale testing of NTR fuel element samples to obtain non-fissile materials data.
- Concentrated heating of fuel sample to near-prototypical temperatures (and expose to Hydrogen) to identify material failure modes.
- Allow for rapid turnaround testing of fuel elements manufactured using variety of materials and techniques.

Illustration of Test Setup

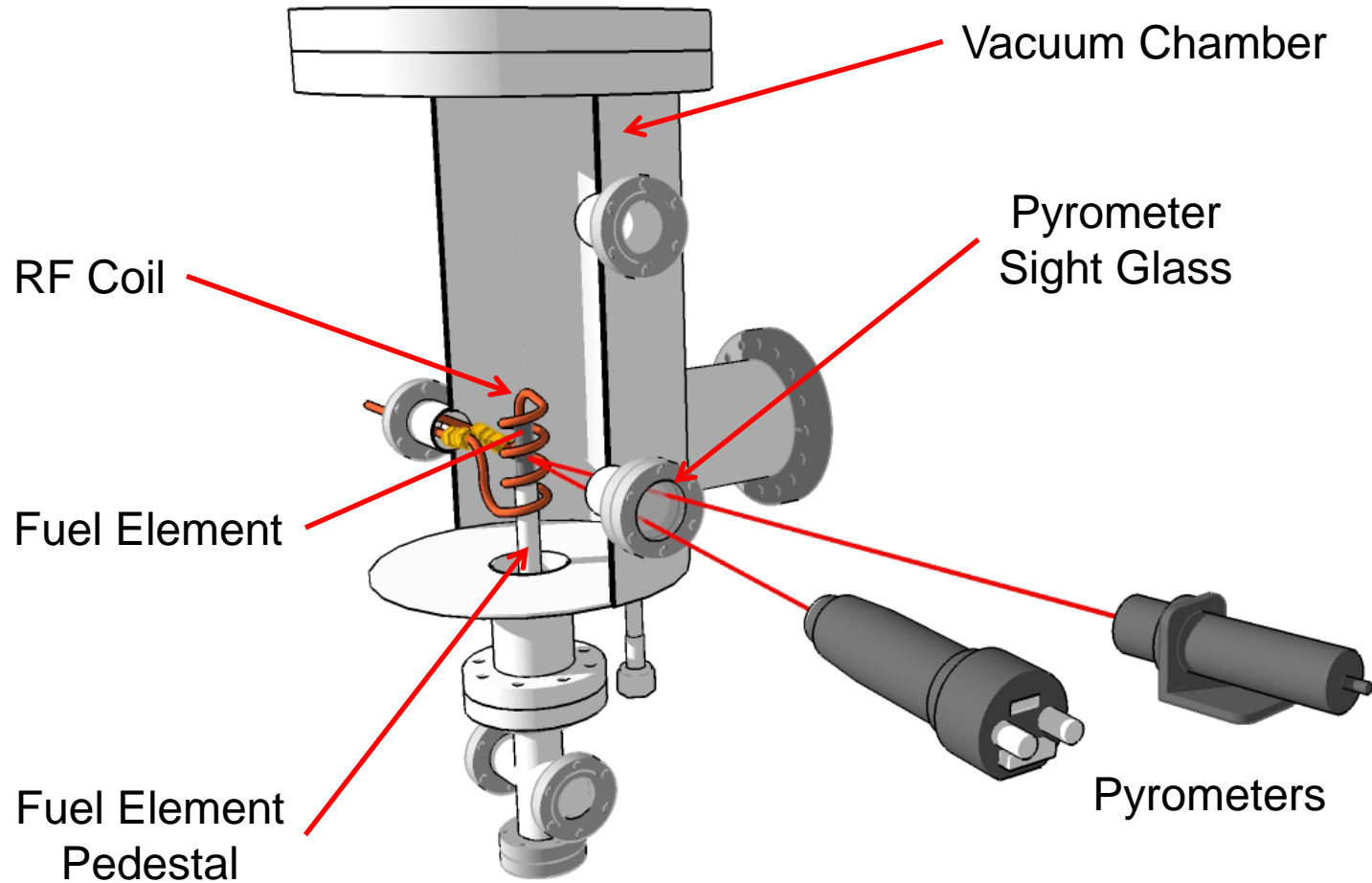

Test Setup Dimensions

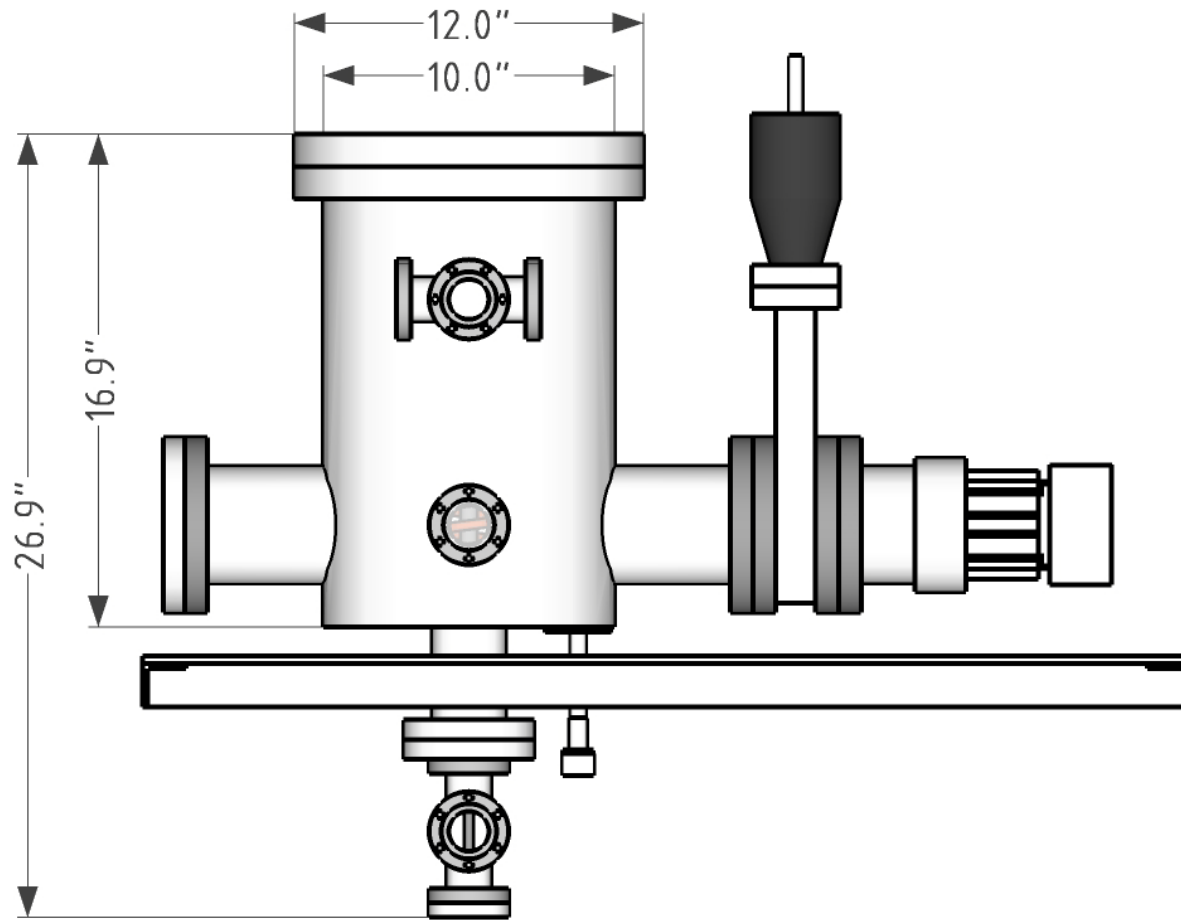

RF Coil, Fuel Element, Pyrometer Detail

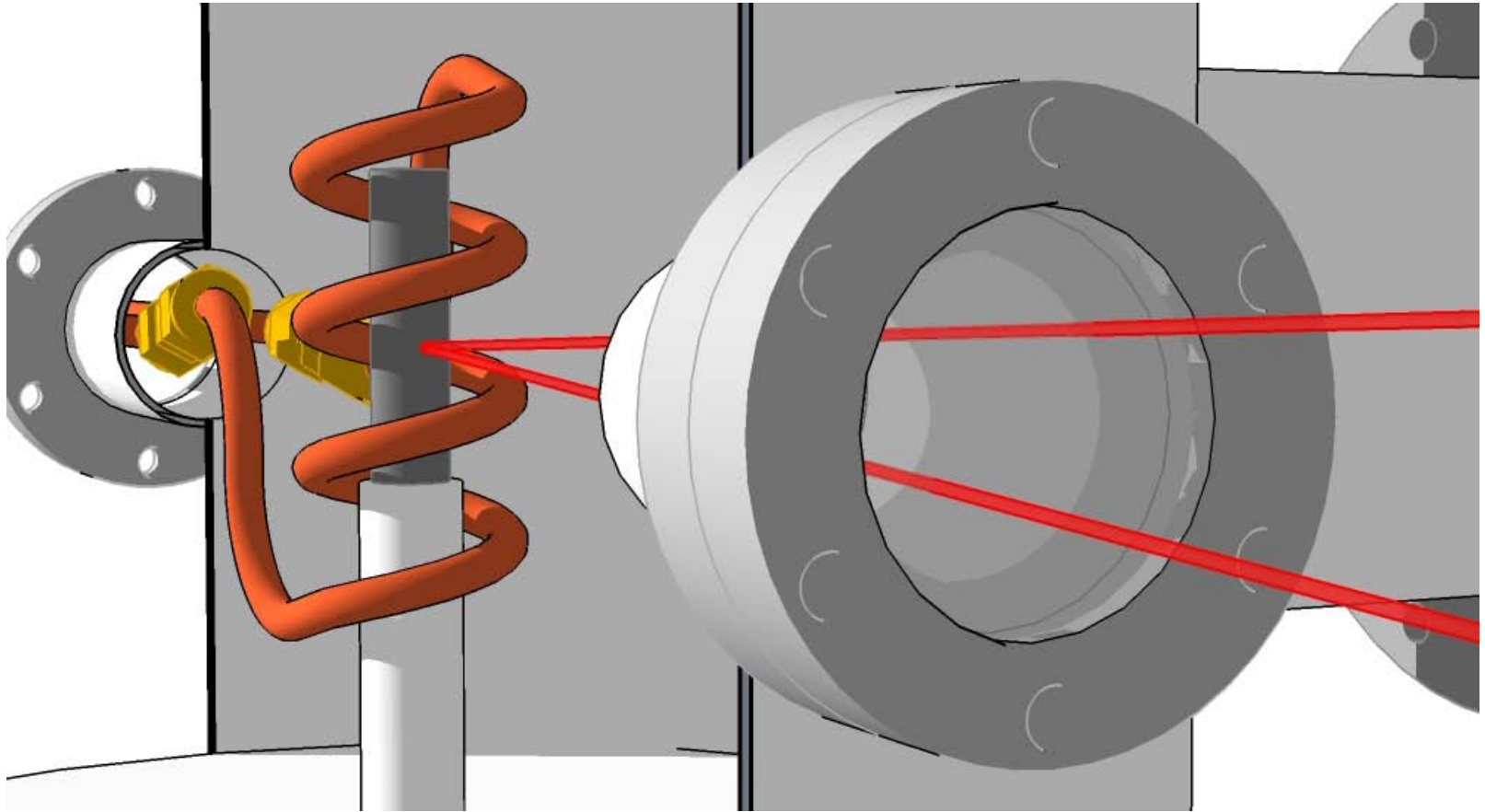

Fuel Sample Pedestal Details

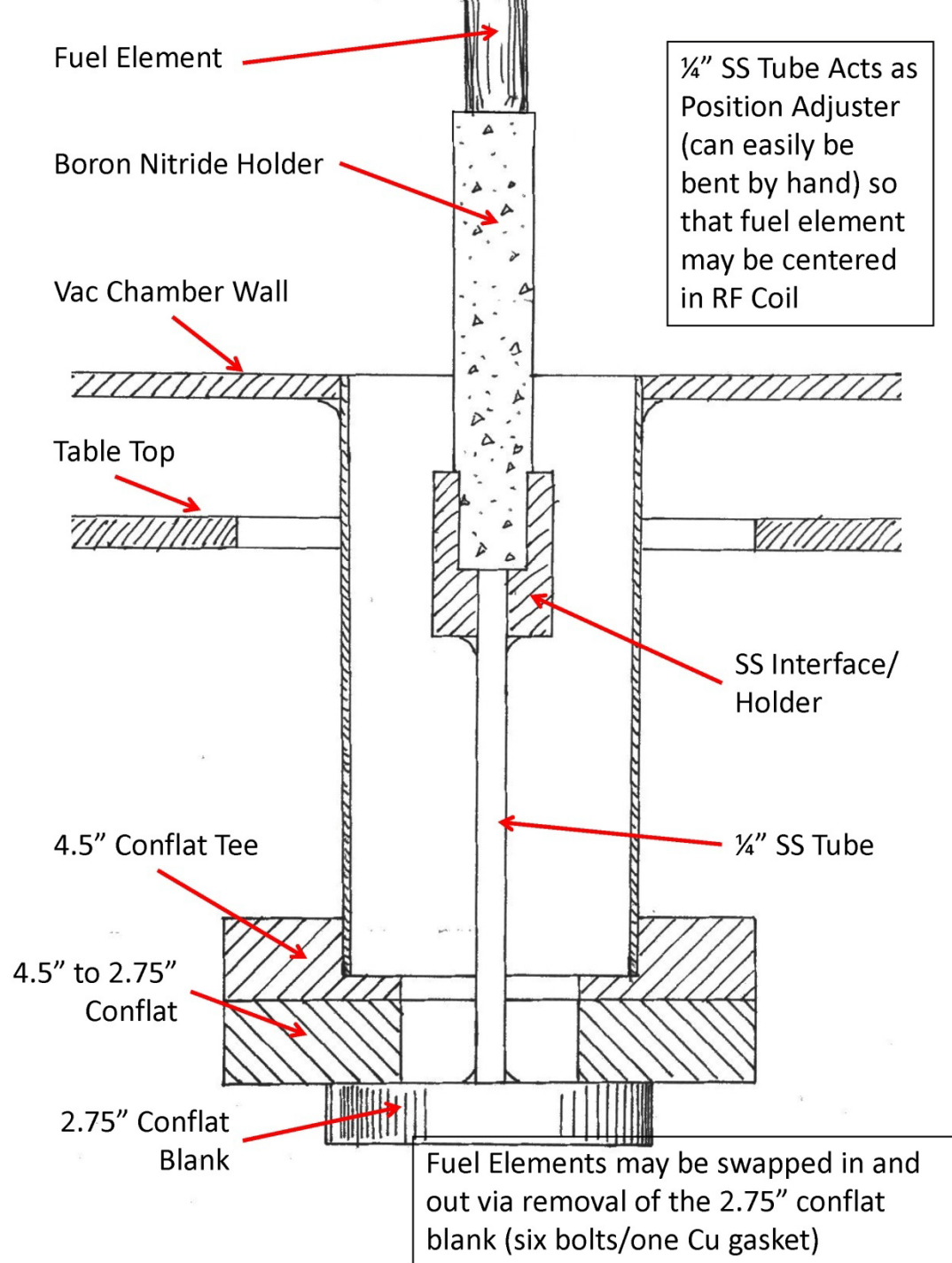

Vacuum Chamber Setup – front view

Chamber Relief Valve

Vacuum Chamber

RF Coil Feedthrough

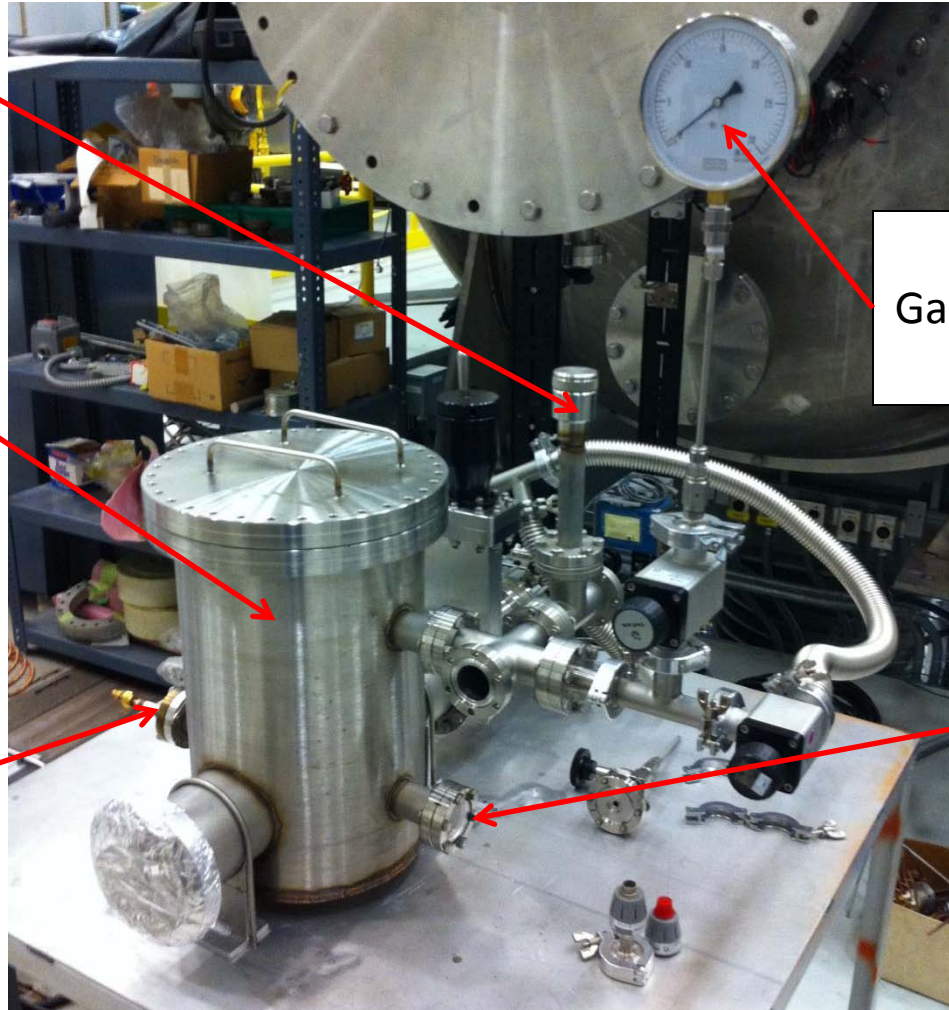

Analog Vacuum Gauge – since replaced by digital sender.

Pyrometer Sight Glass

Vacuum Chamber Setup – rear view

Chamber Relief Valve

Vacuum Chamber



Pyrometer Sight Glass

Turbo Pump Isolation Valve

Turbo Pump

Roughing Pump (under table)

View Inside Vac Chamber Showing RF Coil

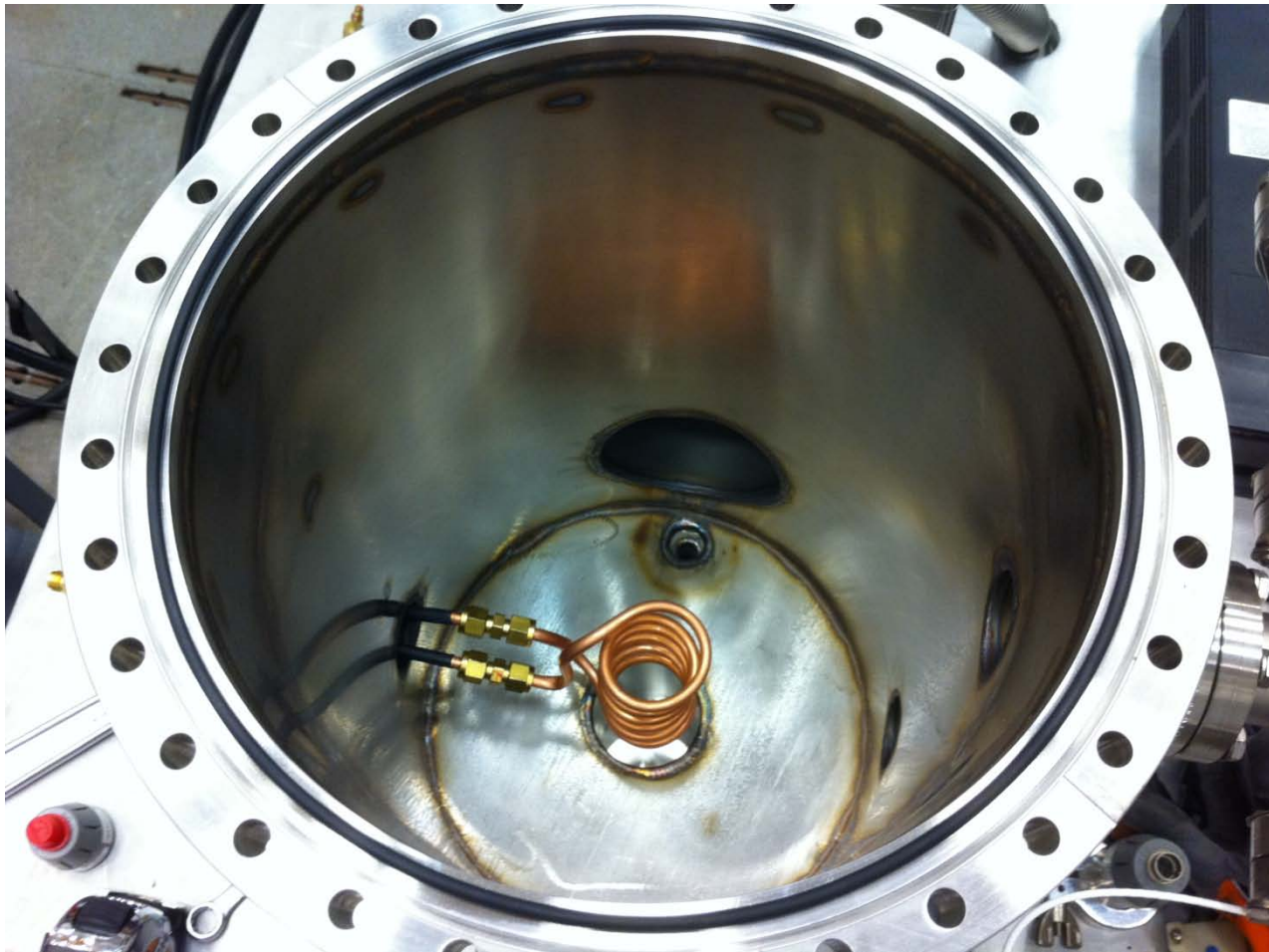



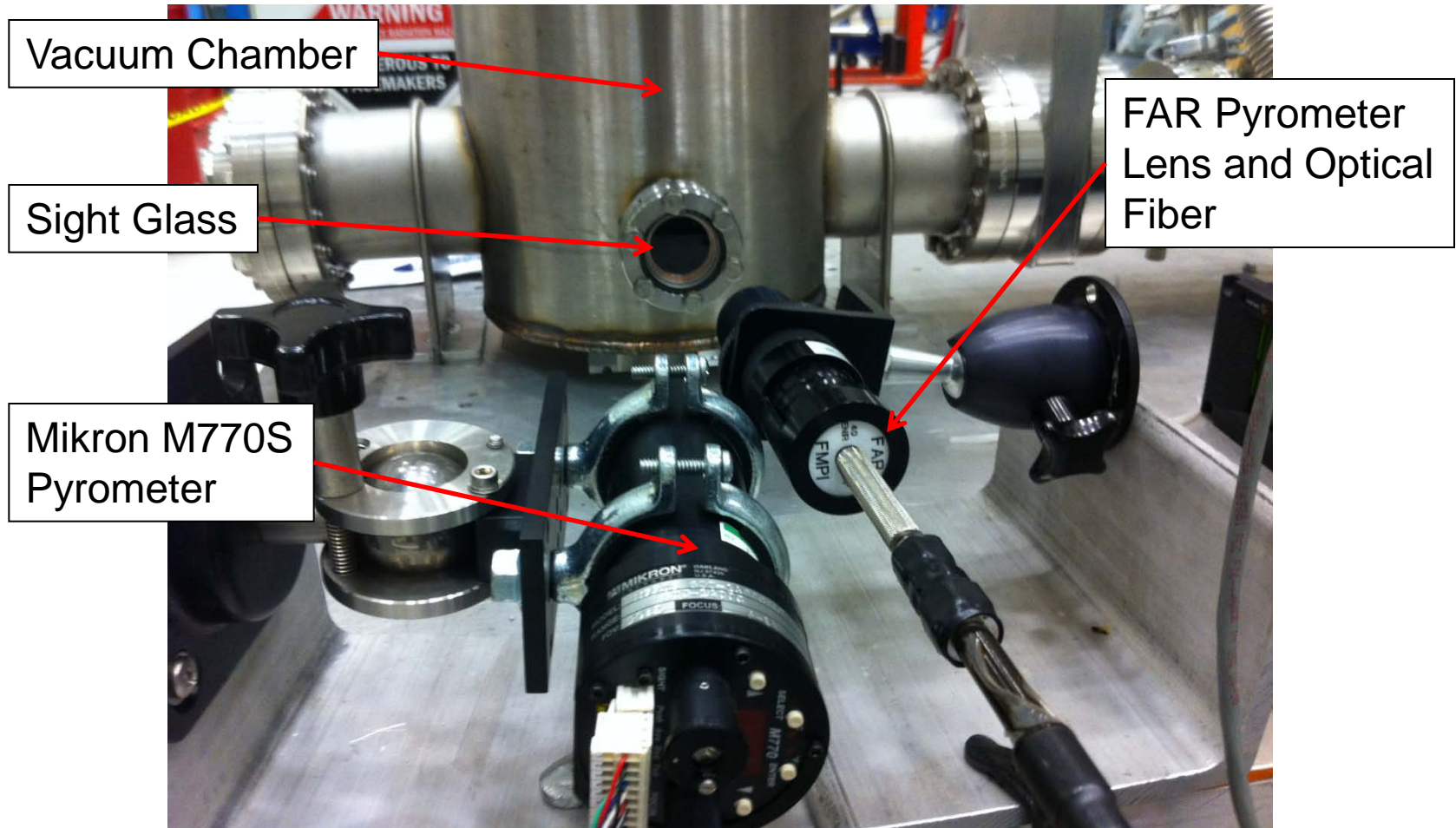



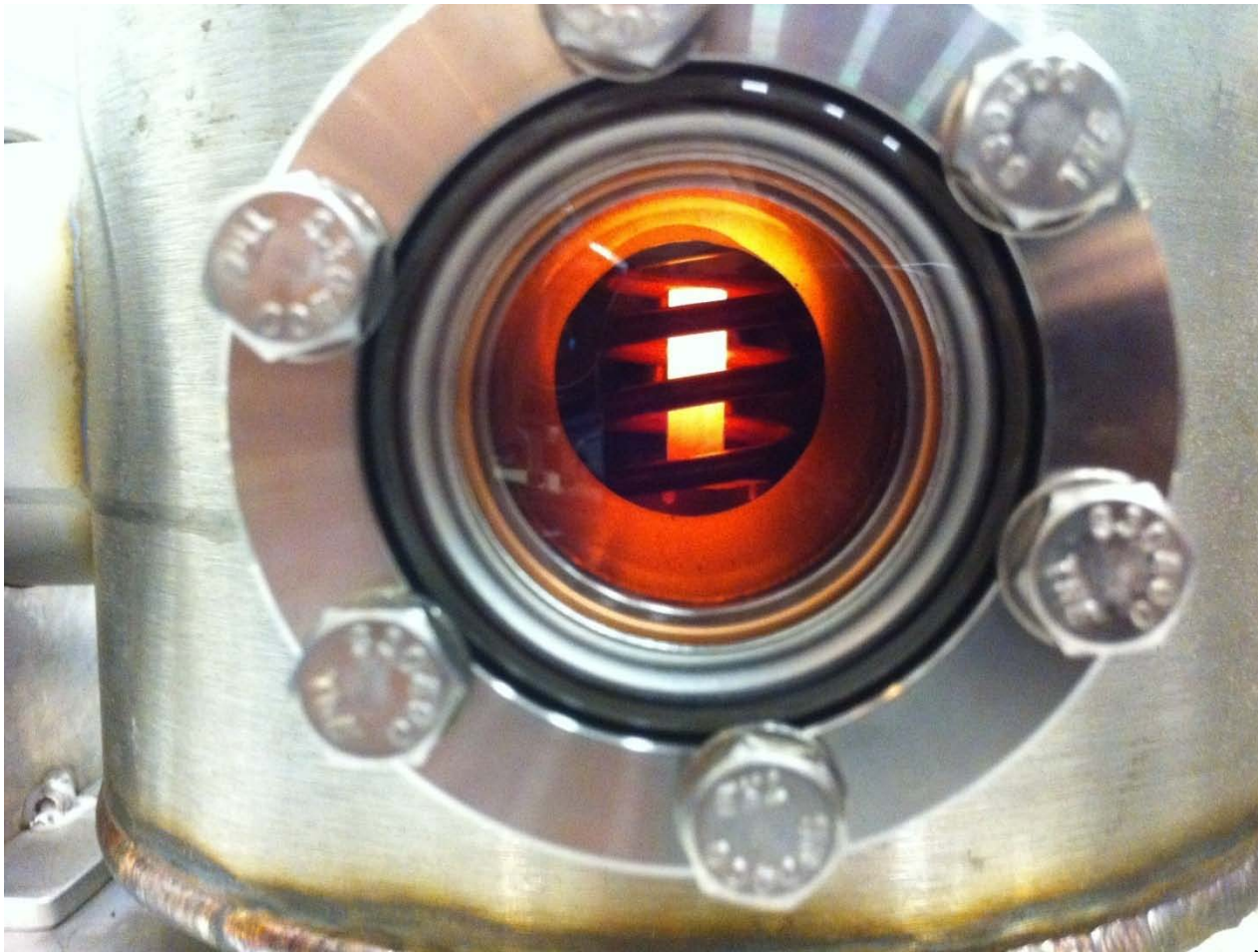







Non-Contact Pyrometers



View Into Sight Glass During Heating Test



HEAT COLORS	
MILD STEEL	
	1371 C
	1316 C
	1260 C
	1204 C
	1149 C
	1093 C
	1038 C
	982 C
	927 C
	871 C
	816 C
	760 C
	704 C
	649 C
	693 C

* http://www.blksmith.com/heat_colors.htm

Temperature Scale Shown for Reference – NOT ACTUAL ELEMENT TEMPERATURE

Data Plot from 1.5kW Non-Melt Test of 308 stainless steel sample

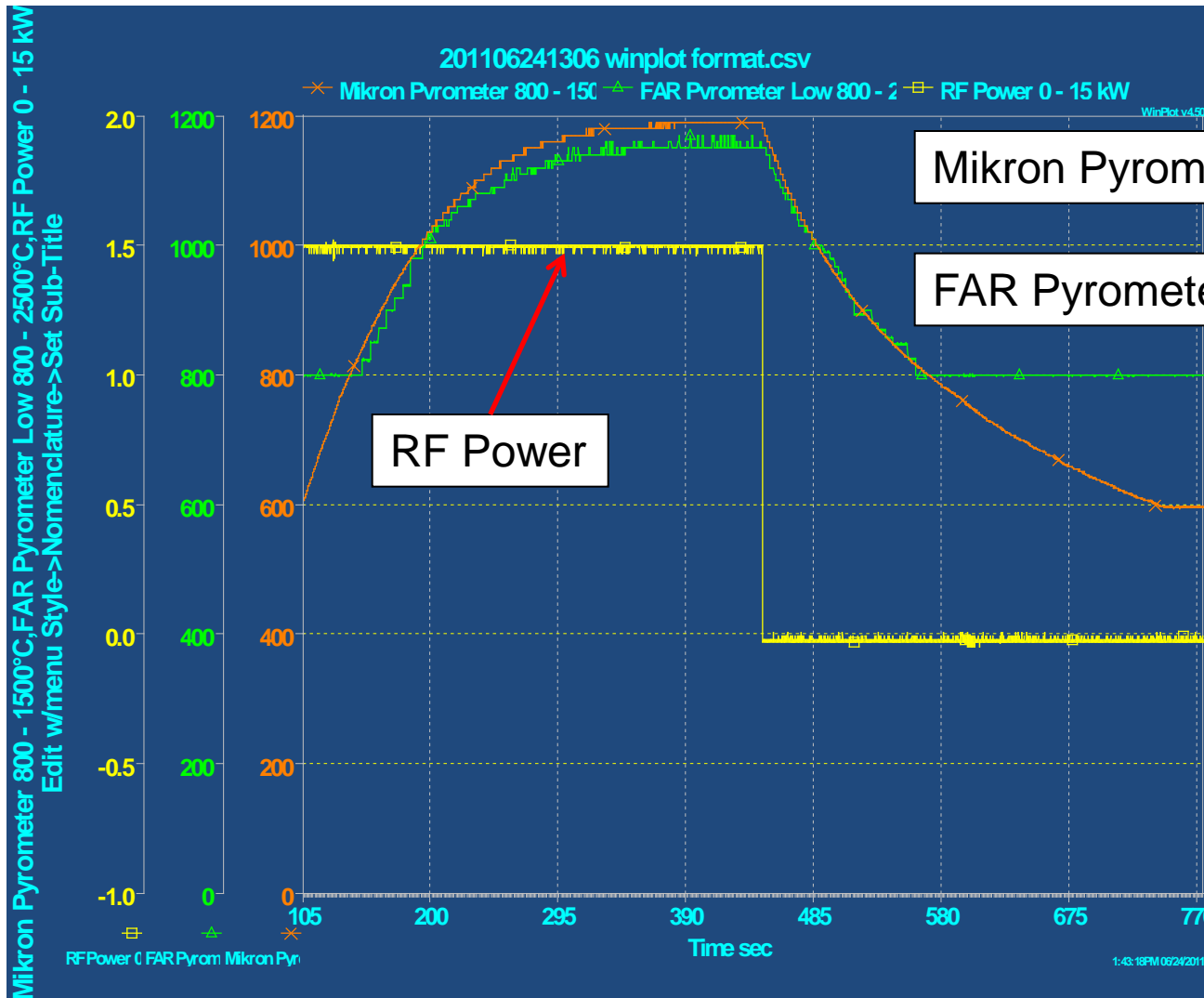

Pyrometer Viewport During Melt Test



Melt Test Videos

- melt test view 1.mp4
- melt test view 2.mp4

304 Fuel Element in RF Coil Before and After Melt



Estimated RF Heating Efficiency during Melt Test, no shielding

RF Heating of Fuel Element Energy Equations

308 Stainless Steel					
	50	duration of applied RF, (seconds)			
	9.3	Power output level indicated on Flexitune, (kW)			
	465	total energy input, (kJ)			
	25	fuel element start temperature, (°C)			
	1500	fuel element end temperature, (°C)			
	0.5	specific heat of fuel element, C_p , (kJ/kg·K)			
	8.03	fuel element density, ρ , (g/cm ³)			
	6.44	fuel element volume, V , (cm ³)			
	51.67	mass of fuel element, m , (g)			
	38.11	total energy added to fuel element (kJ)			
	8.2%	overall efficiency of RF heating (%)			

Thermodynamic Modeling

- Using simple equations for conduction and thermal radiation heat transfer, heat loss rates were predicted.
- Conduction heat loss is proportional to the element temperature.
- Thermal radiation heat loss is proportional to the fourth power of element temperature.
- At higher operating temperatures, thermal radiation dominates.

Shielding Techniques

- Reducing thermal radiation heat loss from the fuel element to the vacuum chamber requires a shield of some kind.
- An Alumina ceramic insulator was fabricated to fit between the fuel element and the RF coil.

Alumina Sleeve Insulator as Installed

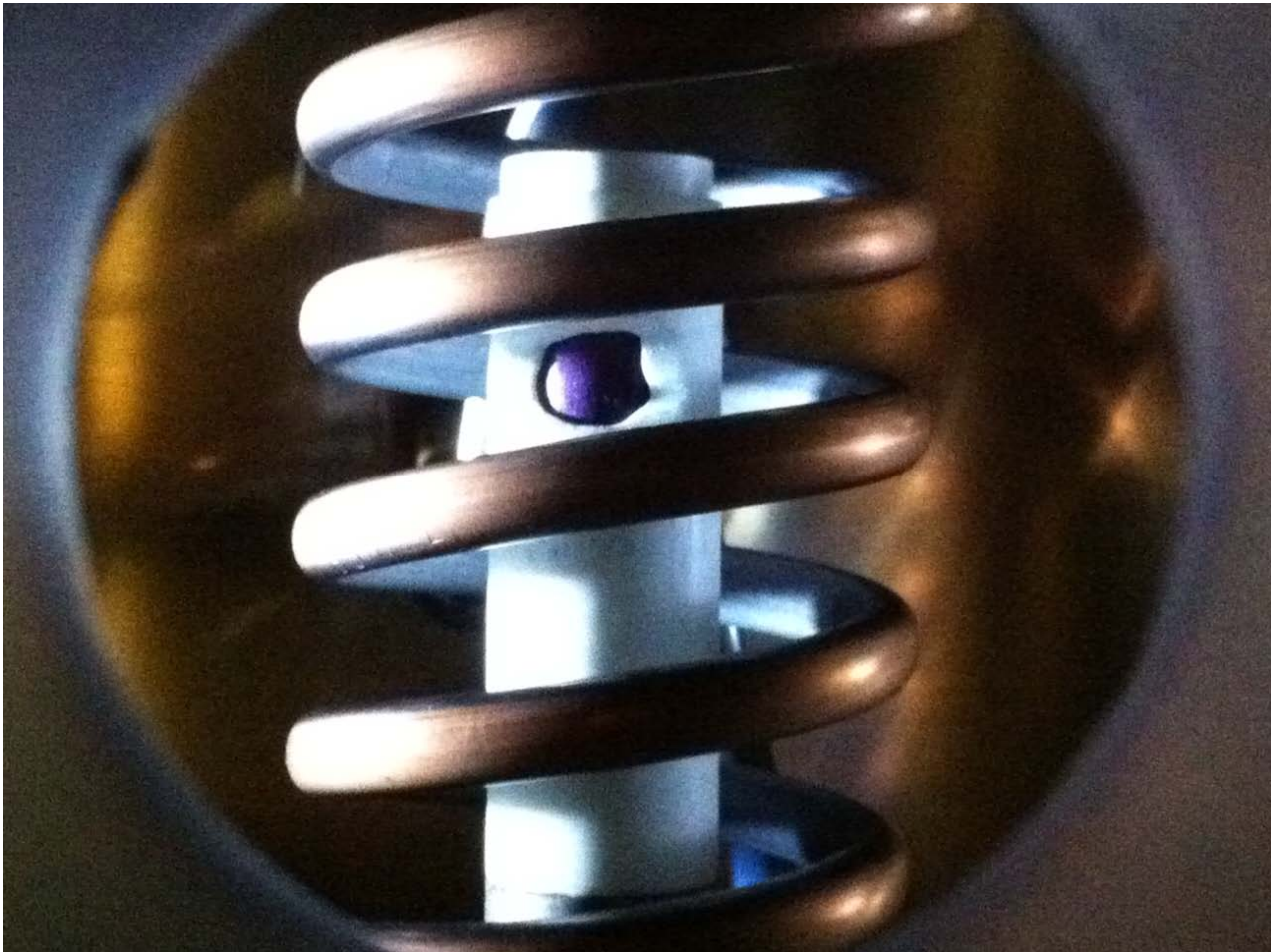

Alumina Sleeve Insulator during Test

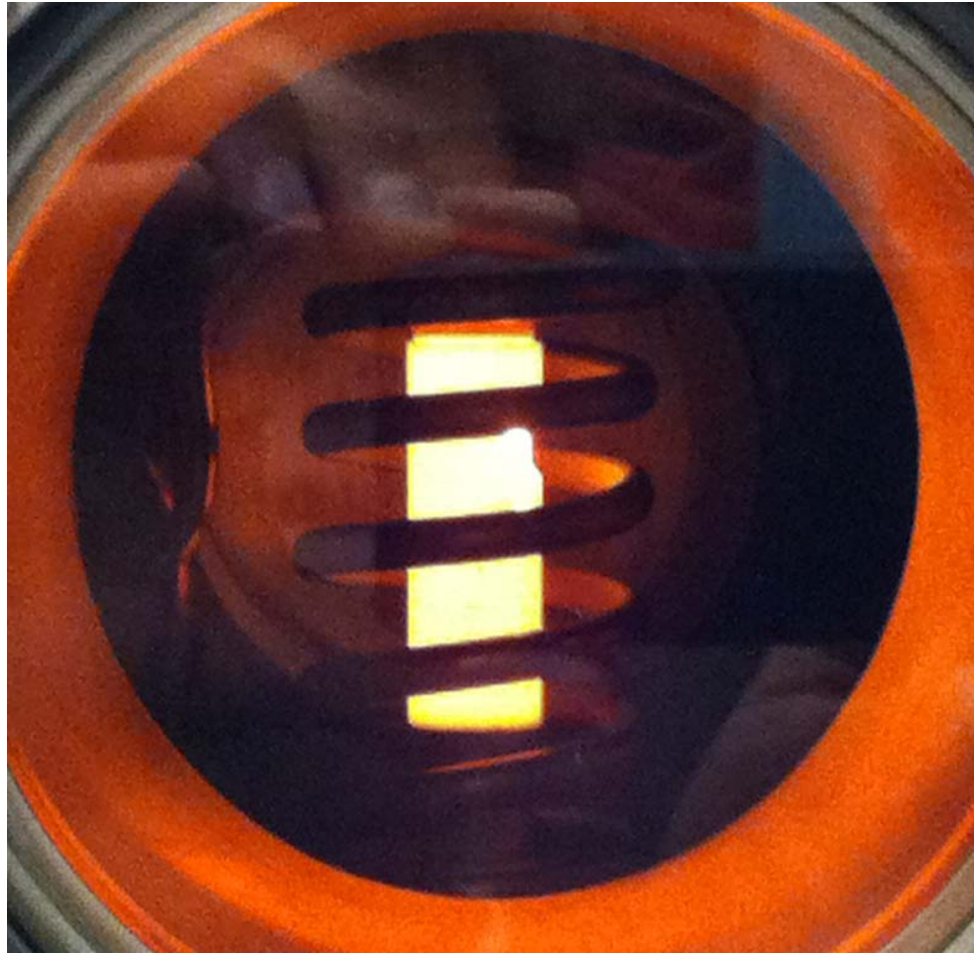

Low Power Heating Tests, Element Temp During Heating

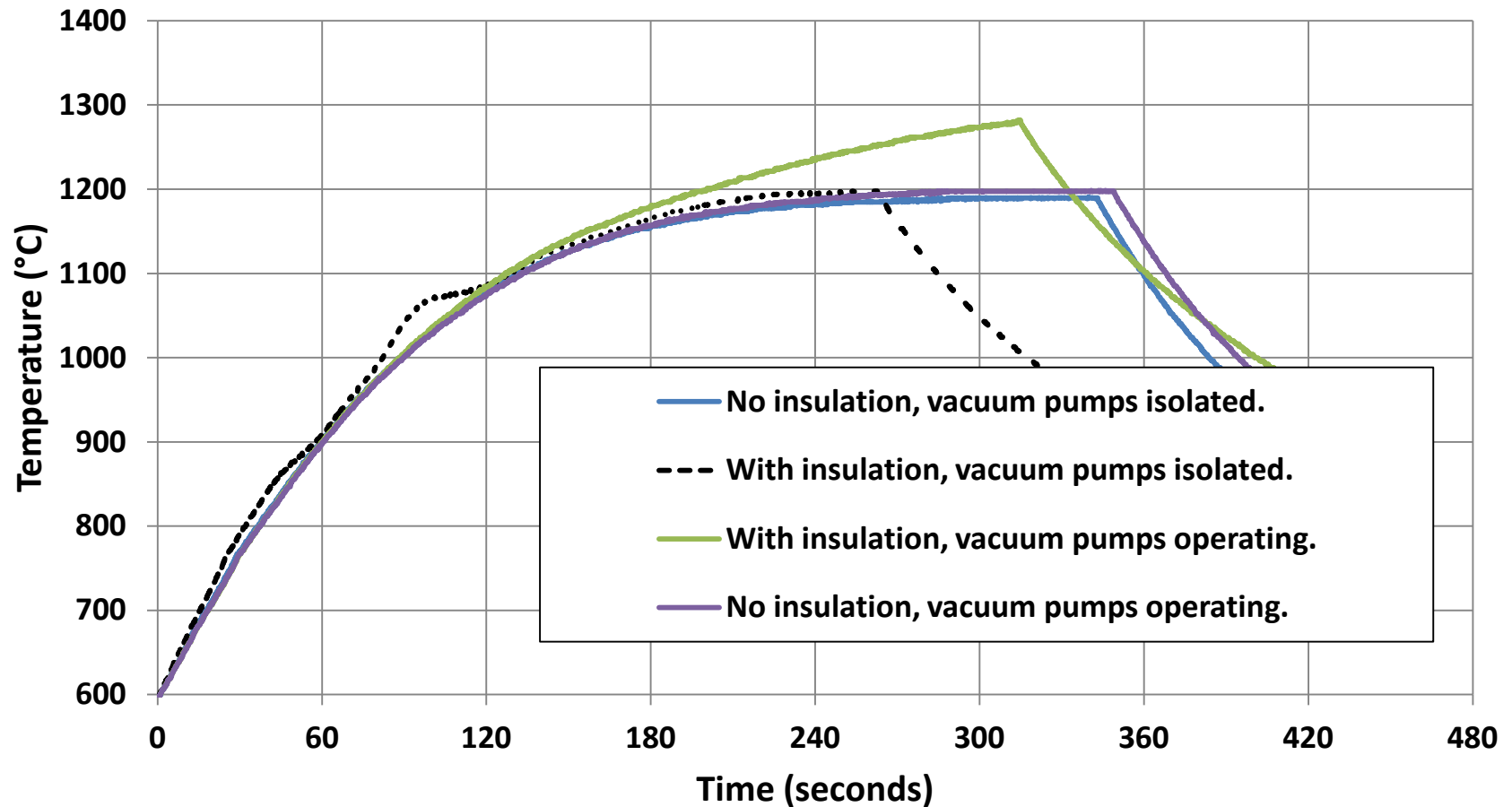

Low Power Heating Test, Element Temp During Cool Down

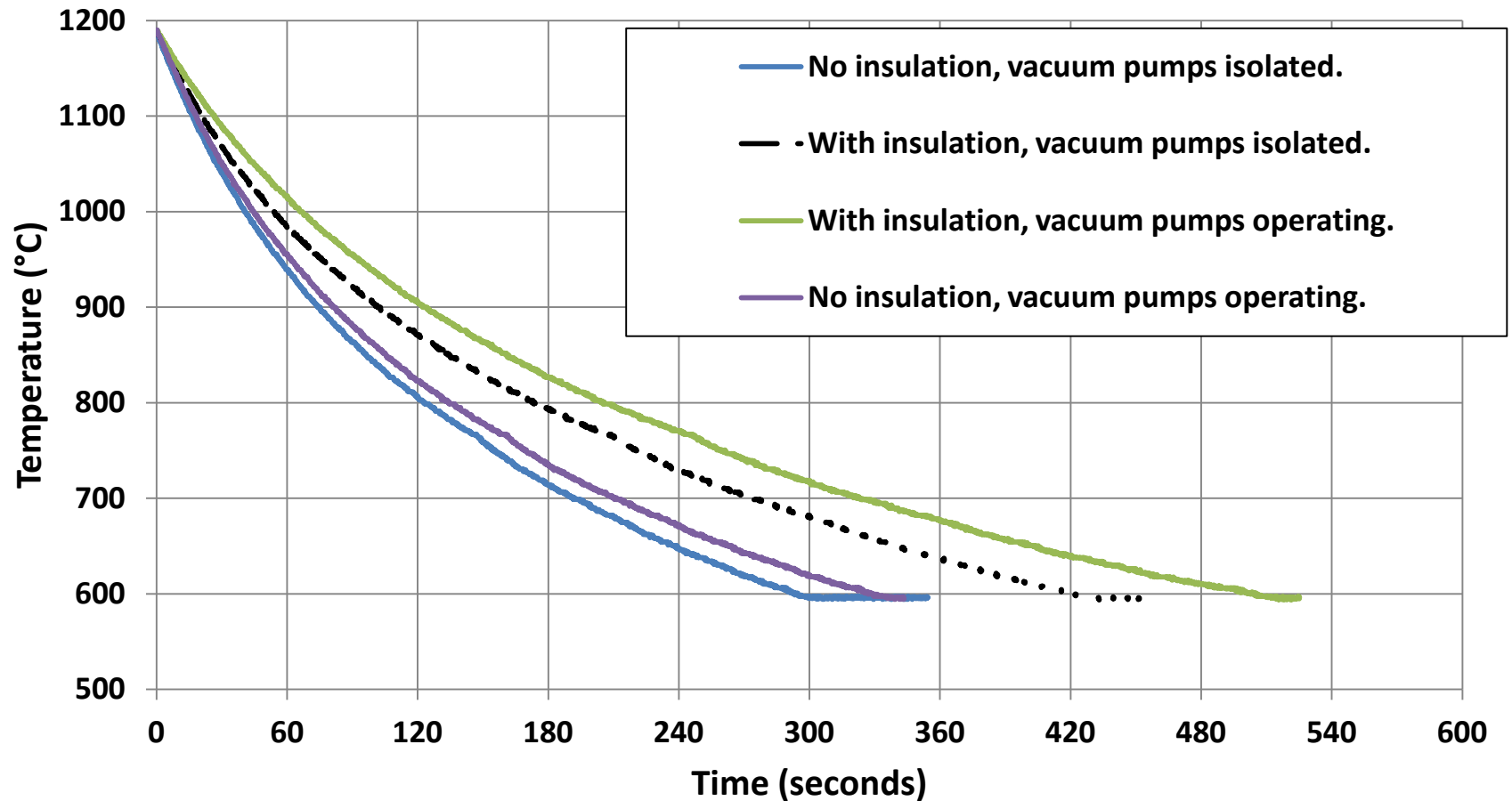

High Power Heating Tests

- Some estimate of maximum system performance was desired.
- An in-coil ceramic insulator provided potential gains in heating efficiency.
- A heavier wall Zirconia ceramic insulator was cast and installed around a high-melting point cermet surrogate fuel element for this testing.

Cermet Surrogate Fuel Element Specifications

- W: Tungsten, 63% by weight, $C_p=132 \text{ J/Kg}\cdot\text{K}$, $MP=3422 \text{ }^\circ\text{C}$
- Rh: Rhenium, 5% by weight, $C_p=136 \text{ J/Kg}\cdot\text{K}$, $MP=3186 \text{ }^\circ\text{C}$
- HfN: Hafnium Nitride, 32% by weight, $C_p\approx 249 \text{ J/Kg}\cdot\text{K}$, $MP=3305 \text{ }^\circ\text{C}$
- Sample Mass: 92.881 g
- Estimated properties (based on mass percentages): $C_p=169.8 \text{ J/Kg}\cdot\text{K}$, $MP=3373 \text{ }^\circ\text{C}$
- Dimensions: $\frac{1}{2}$ in. in diameter x 1.5 in. in length
- Sample Density: 19.2 g/cm^3

RF Coil, Fuel Element and Insulator Setup for High Power Test

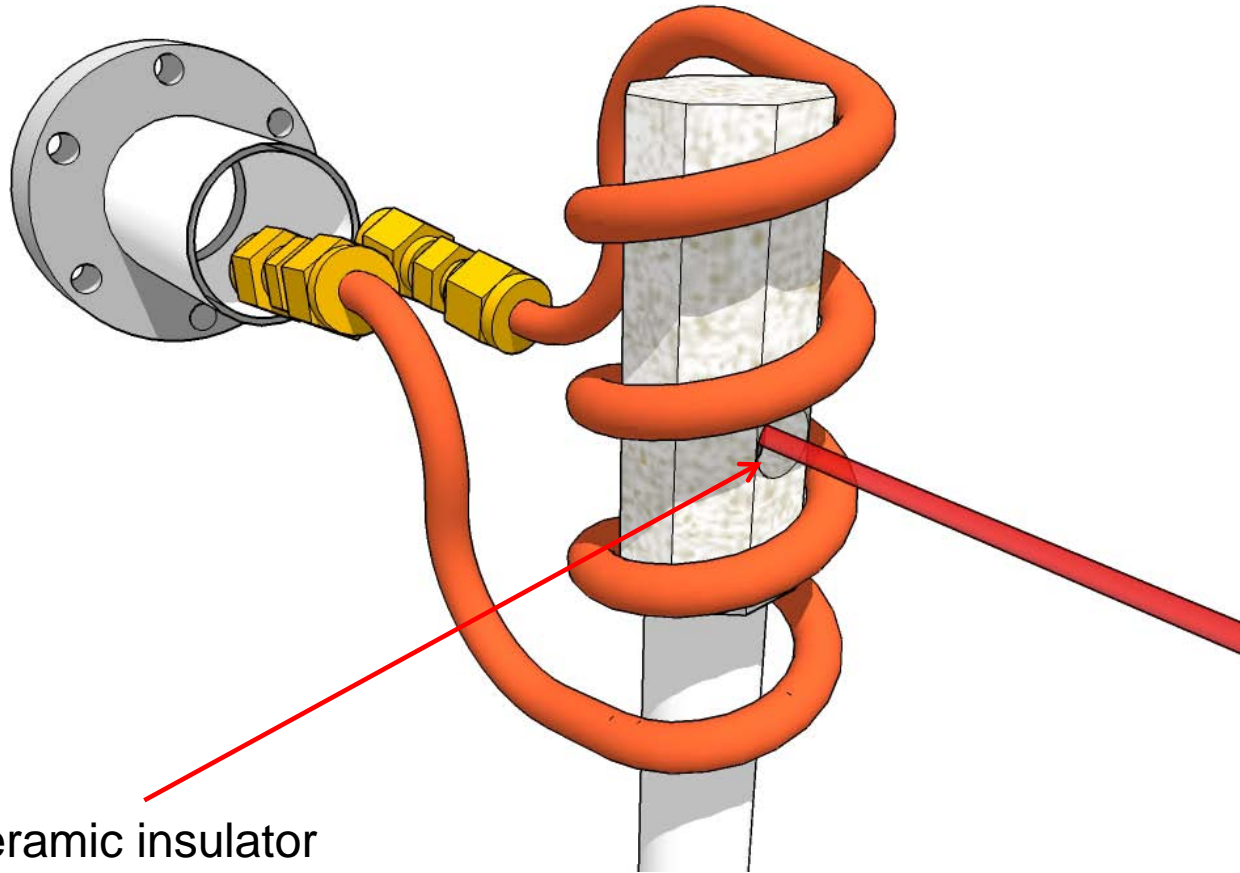

Note hole in ceramic insulator for pyrometer temperature measurement.

Time Lapse Photos of High Power Test



1



2



3



4



5

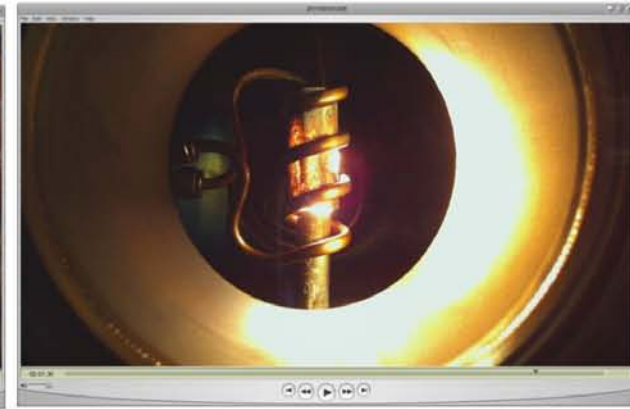

6

High Power Test Video

- high power test with W-Rh-HfN.mp4

High Power Heating Fuel Element Temperature Plot

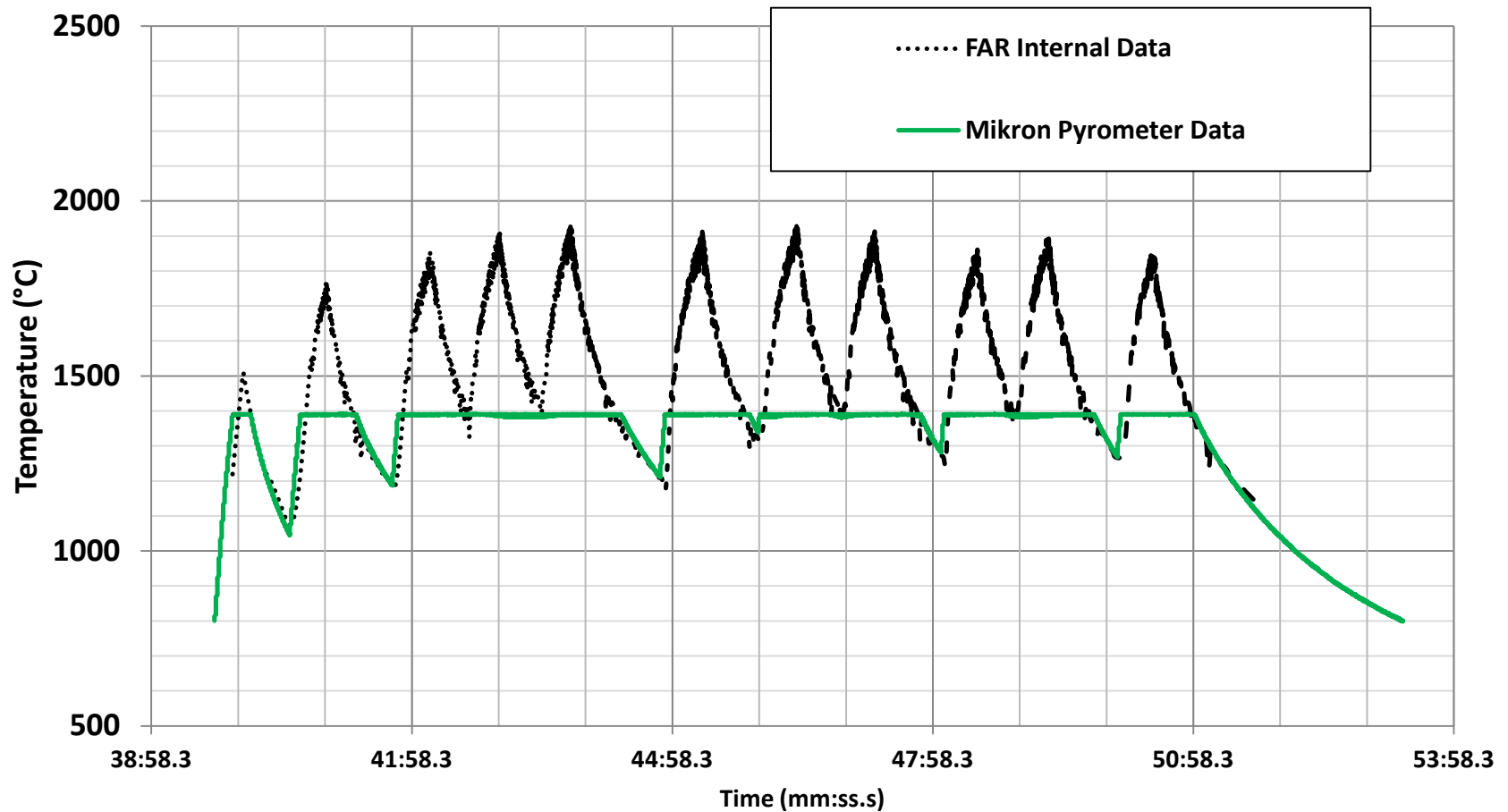

High Power Testing Results and Discussion

- RF Power supply tripped off on high water temperature limit (40°C).
- Water temperature dropped sufficiently to resume heating after about 60 seconds.
- Maximum fuel element temperature achieved: 1931°C
- Heating was limited by a cooling water limit and not insufficient heating power.

High Power Testing Results and Discussion (continued)

- The hardware was observed post-test and physical contact between the in-coil insulator and the water-cooled RF coil was detected.
- Excessive conduction of heat from ceramic insulator to cooling water most likely cause of high water temperature trip.
- Eliminating physical contact and increasing cooling water flow rate should preclude further high temperature water trip.

System Upgrades – Water Supply

Custom 6" CONFLAT™
RF Power Feed-through

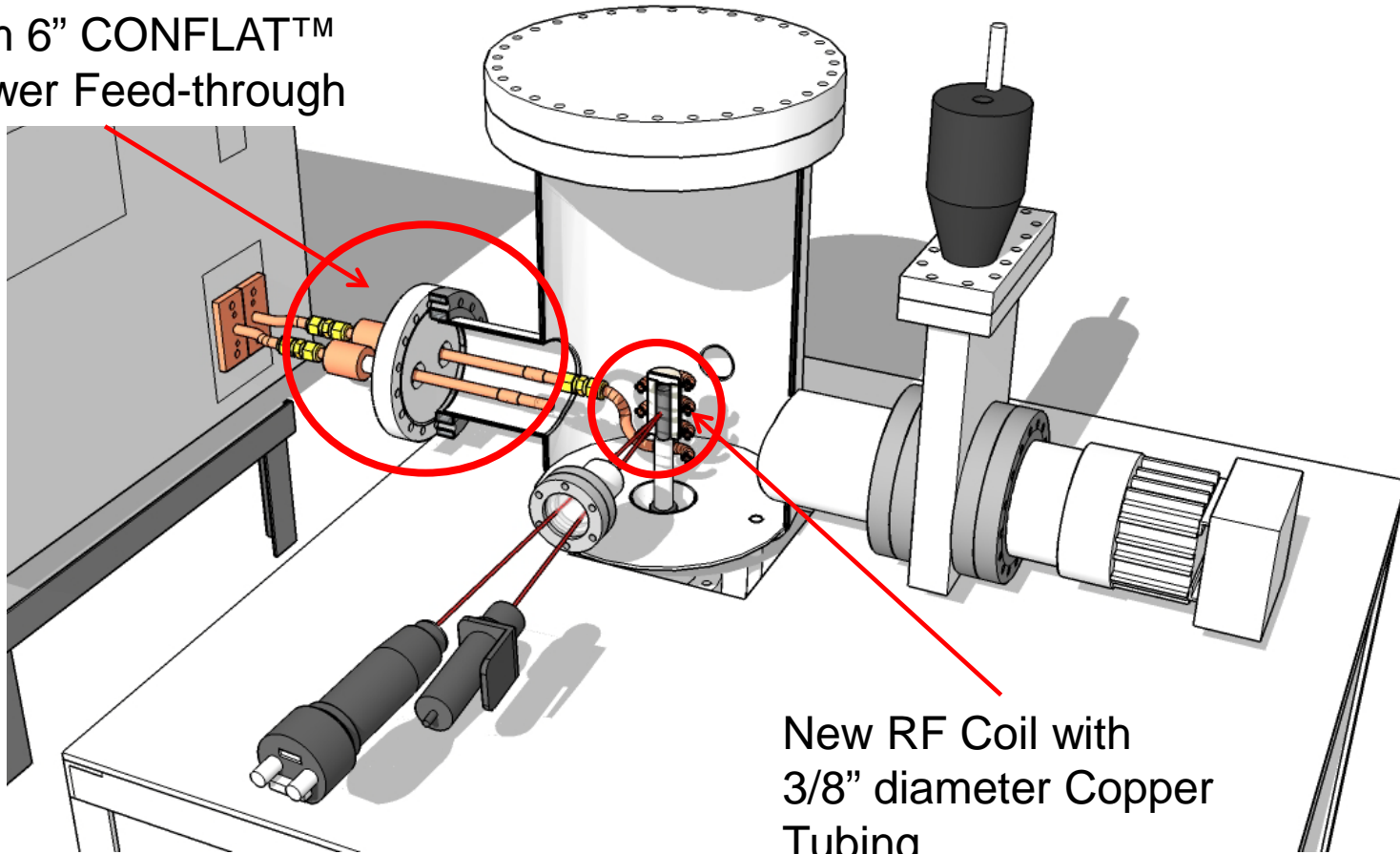

New RF Coil with
3/8" diameter Copper
Tubing

System Upgrades –

New Ceramic Insulator with Clearance Fit to Coil

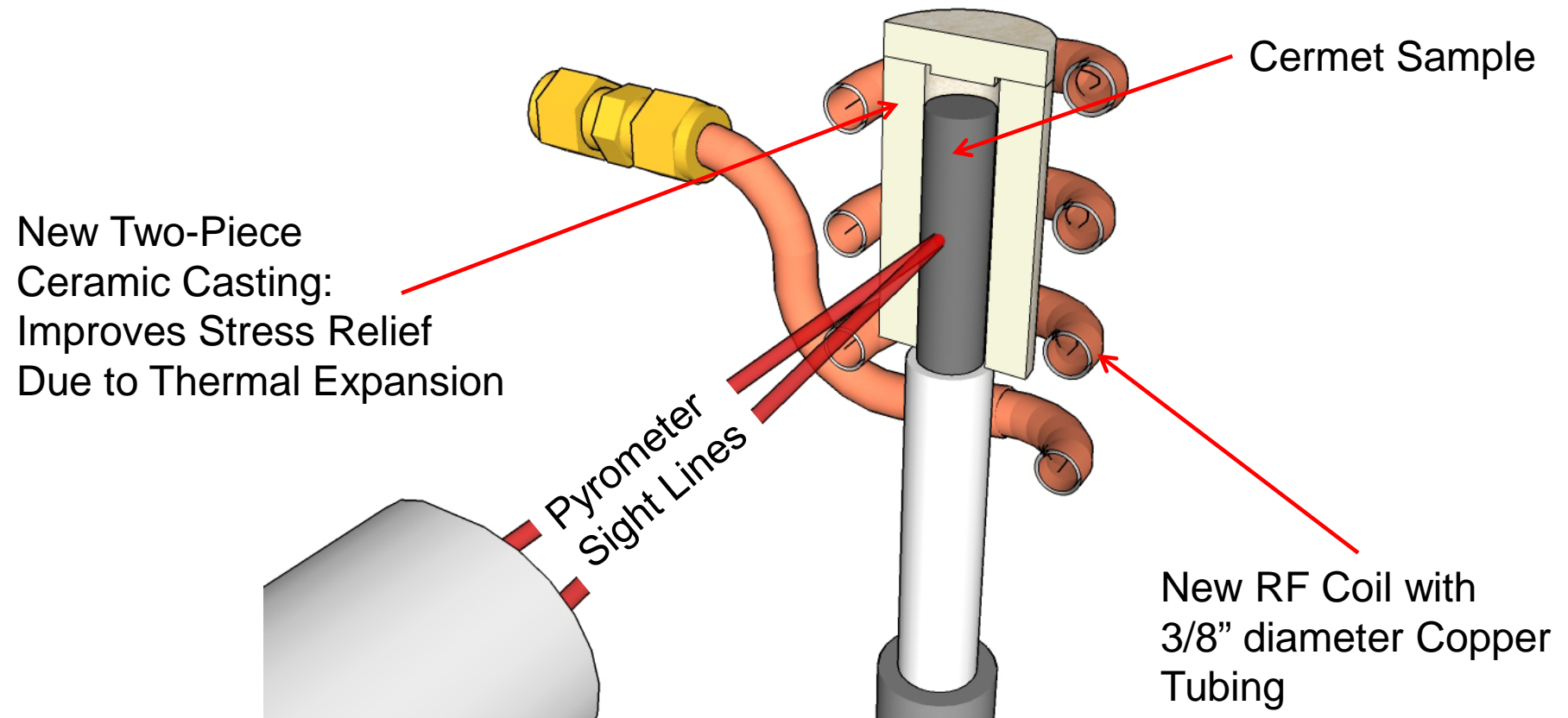

Upcoming Future Work

- Integrate new and upgraded components into system.
- Install thermocouples on vacuum chamber outer wall.
- Run system check-out and ceramic bake-out tests using stainless steel sample.
- Run identical heating power profiles with all available combinations of insulation/shielding.
- Install Tungsten/Rhenium/Hafnium sample in chamber.
- Bake-out ceramics pulling active vacuum.
- Hard bolt chamber top flange, pull deepest possible vacuum and isolate pumps (observe vacuum decay).
- Test to highest possible fuel sample temperature or to system failure whichever comes first.

BACKUP CHARTS

RF Power Supply Specs

- Radyne Flexitune +15 2-255750-001
- 15kW, 150 VAC, 2400A, 20-60kHz



FAR Full Spectrum Pyrometer Specs

- **Temperature range**
 - FMP2: 800 - 2500°C nominal; lower limit is dependent upon the absorption of the optical path and emissivity of the target.
 - FMP2x: 2000 - 4000°C nominal.
- **Resolution: 0.1°C**
- **Repeatability: 0.015%**
- **Accuracy: 0.15% on gray targets; typically better than 0.75% on targets with nongray or changing emissivity or with absorbing atmospheres**
- **Wavelength range**
 - 500 - 1000 nanometers

Mikron M770S Pyrometer Specs

- **Temperature Range, 600 – 1400°C**
- **Accuracy: $\pm 0.5\%$ of full scale span**
- **Repeatability: 0.1% of full scale span**
- **Temperature Resolution: 1 °C/°F**
- **Spectral Response: One or two narrow bands near infrared**