

Autonomous Flight Safety System

**Prepared for
41st Space Congress, 2004
April 27, 2004**

**Bob Ferrell
NASA KSC
M/S YA-D7
Kennedy Space Center, FL 32899
Bob.A.Ferrell@nasa.gov**

**Steve Santuro
NASA KSC
M/S YA-D7
Kennedy Space Center, FL 32899
Steven.A.Santuro@nasa.gov**

**James Simpson
NASA KSC
M/S YA-D7
Kennedy Space Center, FL 32899
James.C.Simpson@nasa.gov**

**Roger Zoerner
ASRC KSC
M/S ASRC-10
Kennedy Space Center, FL 32899
Roger.Zoerner-1@ksc.nasa.gov**

**Barton Bull
NASA GSFC/WFF
M/S 598.W
Wallops Island, VA 23337
James.B.Bull@nasa.gov**

**Jim Lanzi
NASA GSFC/WFF
M/S 598.W
Wallops Island, VA 23337
Raymond.J.Lanzi@nasa.gov**

Abstract

Autonomous Flight Safety System (AFSS) is an independent flight safety system designed for small to medium sized expendable launch vehicles launching from or needing range safety protection while overlying relatively remote locations. AFSS replaces the need for a man-in-the-loop to make decisions for flight termination. AFSS could also serve as the prototype for an autonomous manned flight crew escape advisory system.

AFSS utilizes onboard sensors and processors to emulate the human decision-making process using rule-based software logic and can dramatically reduce safety response time during critical launch phases. The Range Safety flight path nominal trajectory, its deviation allowances, limit zones and other flight safety rules are stored in the onboard computers. Position, velocity and attitude data obtained from onboard global positioning system (GPS) and inertial navigation system (INS) sensors are compared with these rules to determine the appropriate action to ensure that people and property are not jeopardized. The final system will be fully redundant and independent with multiple processors, sensors, and dead man switches to prevent inadvertent flight termination.

AFSS is currently in Phase III which includes updated algorithms, integrated GPS/INS sensors, large scale simulation testing and initial aircraft flight testing.

Introduction

Public safety risk from hazards associated with the flight of expendable launch vehicles (ELV) is currently mitigated through the use of ground-commanded flight termination systems. During a typical mission, vehicle time-space-position-information (TSPI) from tracking radar and onboard navigation sensor telemetry data is collected at the launch site and remote downrange sites. The data is relayed via a communications network to flight safety decision makers located in a range control center. These personnel monitor the progress of the flight against a set of mission rules using a sophisticated network of ground-based data processors and range-graphics display systems. When necessary, onboard destruct charges are initiated by commands sent from the range control center to the active ground transmitters which relay the commands to the vehicle via radio frequency uplink. To ensure adequate command coverage for the duration of the ascent trajectory, multiple transmitters are used at geographically separated sites necessitating a reliable data communications network to coordinate switching between sites and for relaying commanded functions from a control center to the active transmitter site.

Reducing the costs of this launch vehicle range infrastructure and expanding the areas where launches may occur is a continuing effort to broaden space access markets. One element of the cost reduction strategy focuses upon elimination of the vehicle tracking radar by utilizing an existing space-based launch vehicle tracking network—Global Positioning Satellites (GPS). This paper describes a NASA proof-of-concept project that seeks to exploit the advantages of a non-traditional range safety system by utilizing this technique to allow the launch vehicle to “know” its own position very precisely.

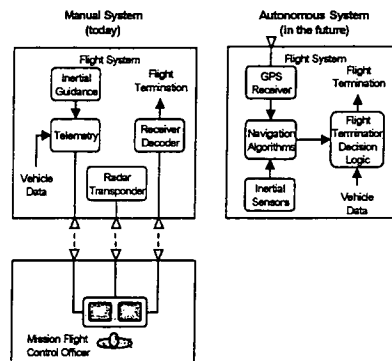

Figure 1. Possible Future Range Safety Concept

NASA's Range Systems Design and Development Branch at Kennedy Space Center (KSC) and Guidance, Navigation, and Control Systems Engineering Branch at Wallops Flight Facility (WFF), are currently designing and building a prototype AFSS which is intended to be a real-time onboard hardware and software system for tracking and possible flight termination. AFSS is being designed primarily for small expendable vehicles at remote launch sites where traditional ground-based range safety infrastructure, including RF communication and command links, radar stations, data processing, display facilities, and trained operators would be extremely expensive. Advantages of AFSS include global coverage and decreased costs during remote launch site operations. The system may also be useful as a training aid and as a backup system for other types of vehicles. GPS receivers in conjunction with Inertial Navigational Systems (INS) provide tracking data. Onboard processors compare the current position, velocity, and attitude with the nominal trajectory and predetermined flight safety rules in order to autonomously implement flight termination when appropriate (see Figure 1). A feasibility study (Phase I) was completed in 2000, and an initial proof-of-concept hardware system (Phase II) was successfully tested in 2002. NASA is currently in Phase III of AFSS development, which is a 3 year effort to produce a flight qualifiable system.

Phase I Development (Historical)

Phase I of AFSS was a Research and Design Feasibility Demonstration performed by Lockheed Martin Space Systems Company under contract NAS10-99051. This was awarded to them in response to Amendment 4, NASA Research Announcement 8-21 and was managed by KSC personnel. During this phase of the project, the technical feasibility of performing a range function autonomously was verified. Phases of the rocket's liftoff and ascent were defined as shown in Figure 2.

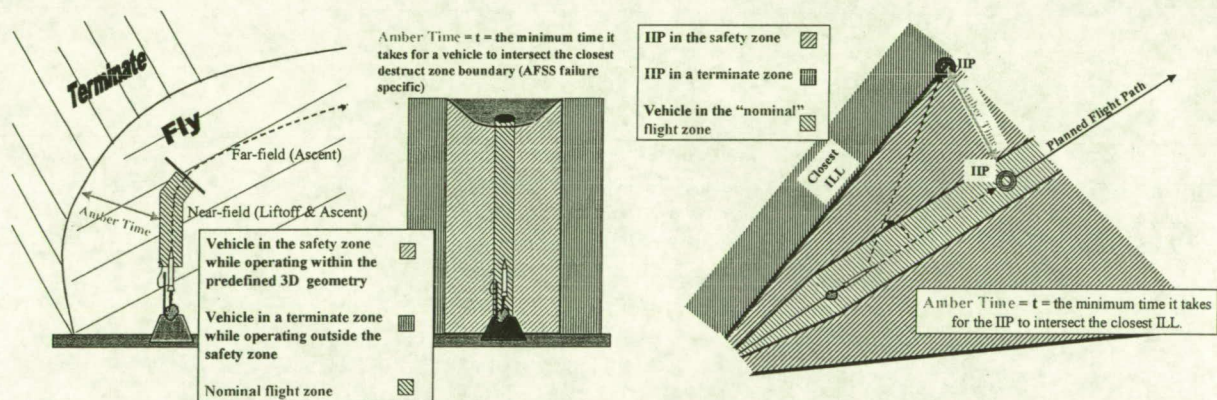

Figure 2. Liftoff/Ascent Phases for AFSS Phase I Simulations

Phase I simulations were performed on a PC using a JAVA development environment. Although a limited subset of flight algorithms and destruct rules were utilized during the simulation, verification of the approach was successful and the subsequent phase II, which was contingent upon phase I outcomes, was given the go ahead.

Phase II Development (Historical)

Phase II efforts were performed by both WFF and KSC Civil Service personnel with direct support from their engineering contractors. In addition, Lockheed Martin Space Systems Company continued their support from Phase I through a Defense MicroElectronics Activity (DMEA) contract managed by WFF. Phase II expanded on the algorithms developed in Phase I and implemented them on a Single Board Computer (SBC). The implemented solution for Phase II was a VME Radstone PPC4A-750

SBC with VxWorks Real Time Operating System (RTOS). The configuration also included two Ashtech G12 GPS receivers (see Figure 3).

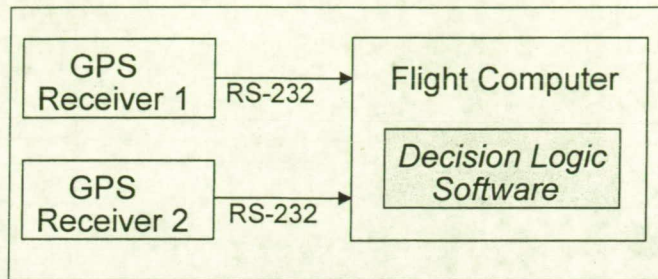

Figure 3. Phase II AFSS Configuration

Implementation of the software algorithms was continued from Phase I and utilized a Grid Structure Mapping Technique for Instantaneous Impact Point/Prediction (IIP) Limit Zones (see Figure 4). This approach made Graphical User Interaction (GUI) development minimal and also ensured easier readability of the results. However, it also meant more required resources for larger and/or more detailed ground areas.

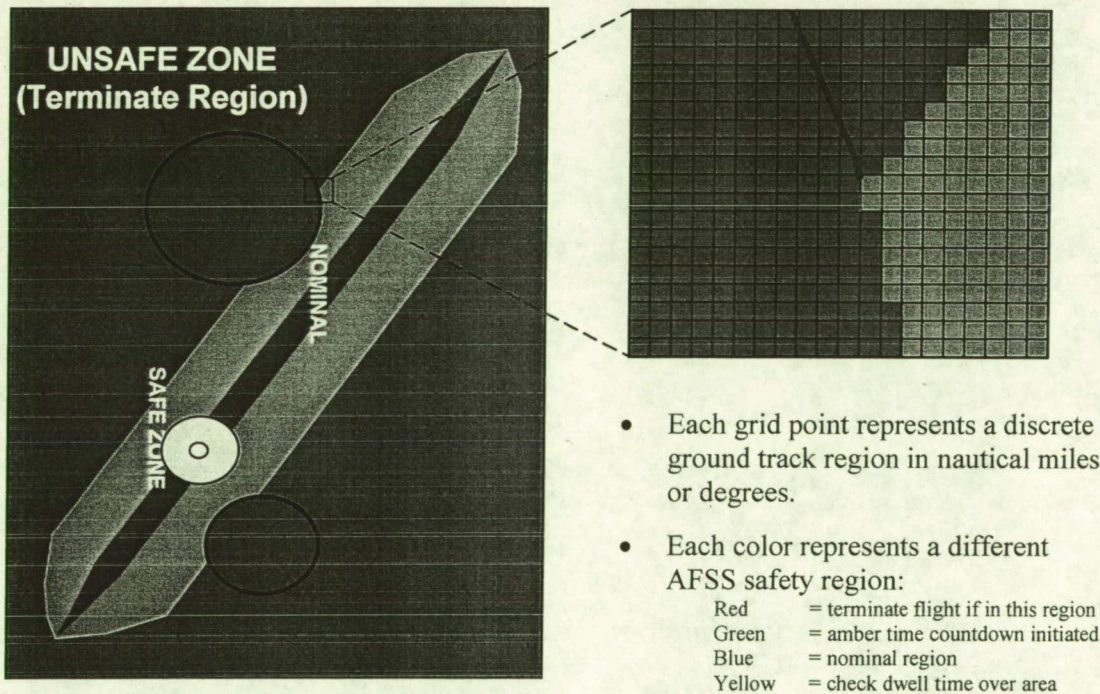

Figure 4. IIP Limit Zones Grid Structure Mapping Technique

As an example of the type of GUIs developed in Phase II, see Figure 5.

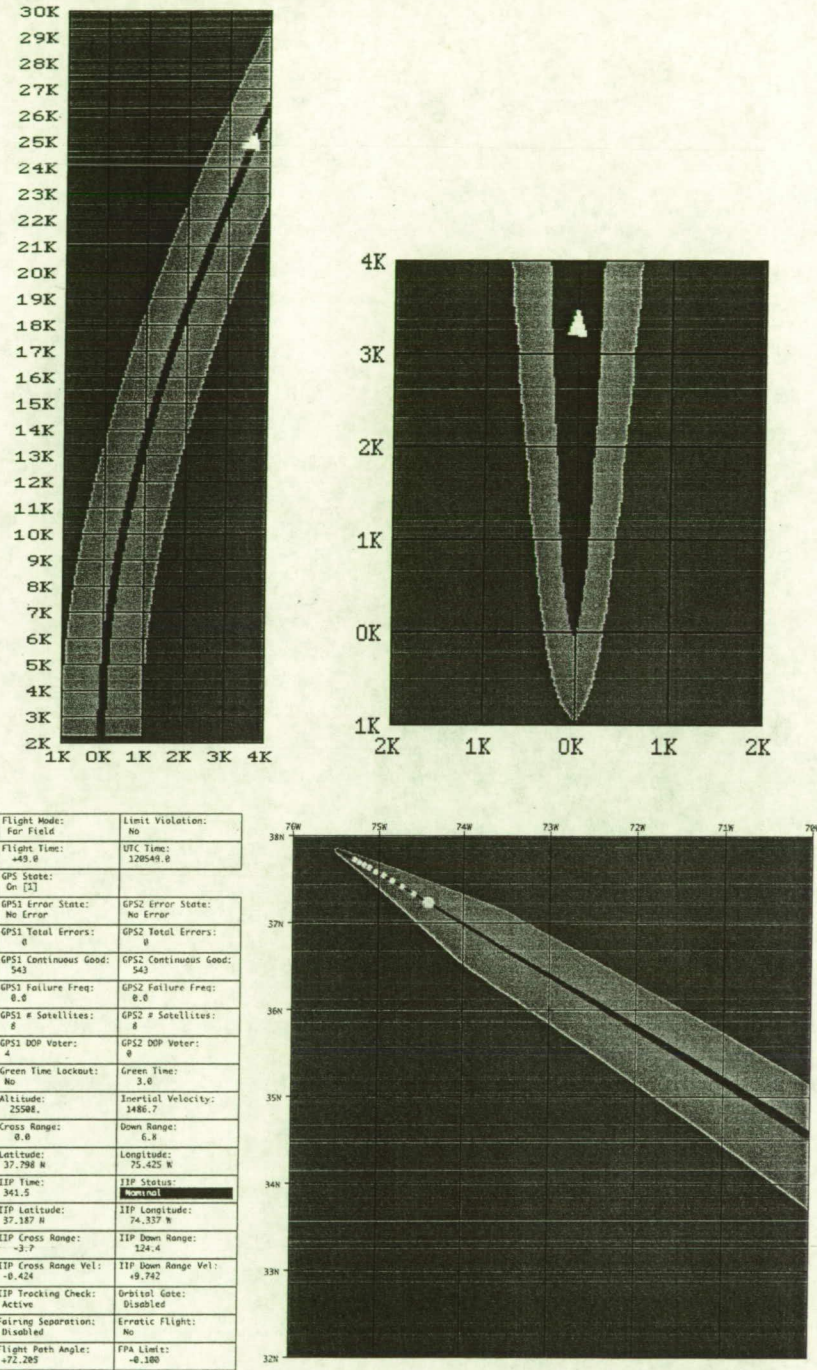

Figure 5. AFSS Phase II Ascent/Liftoff Displays

Phase II Testing (Historical)

As part of the Phase II AFSS development, high fidelity testing was performed at the WFF GPS Simulation Lab utilizing GPS simulators on a fully integrated lab/bench version AFSS system. The primary objective of this testing was to evaluate the AFSS decision logic software. WFF personnel developed two baseline missions for testing. The first one was based on an actual Athena launch out of Kodiak, Alaska (see Figure 6). The second was a custom designed trajectory, based on a hypothetical

surplus motor 3-stage to orbit ELV, which was referred to as Wallops Express (see Figure 6. Kodiak Star Baseline Mission Figure 7. Wallops Express Baseline Mission).

Elapsed Time (sec)	Event
L+0	S1 Ignition
L+4	Begin Pitch Profile
L+91	S1 Burnout
L+177	Fairing Separation
L+183	S1 Separation
L+185	S2 Ignition
L+322	Orbit Gate Decision Point
L+332	S2 Burnout

Figure 6. Kodiak Star Baseline Mission

Elapsed Time (sec)	Event
L+0	S1 Ignition
L+4	Begin Pitch Profile
L+12	Begin Gravity Turn Steering
L+64	S1 Burnout
L+154	S2 Ignition
L+222	S2 Burnout
L+441	Fairing Separation
L+442	S3 Ignition
L+500	S3 Burnout

Figure 7. Wallops Express Baseline Mission

WFF personnel then generated 20 test scenarios and associated flight trajectory simulations based on these baseline trajectories. These scenarios and trajectories were than played back through a GPS simulator at WFF’s GPS Simulation Lab as shown in Figure 8 to test AFSS during Phase II.

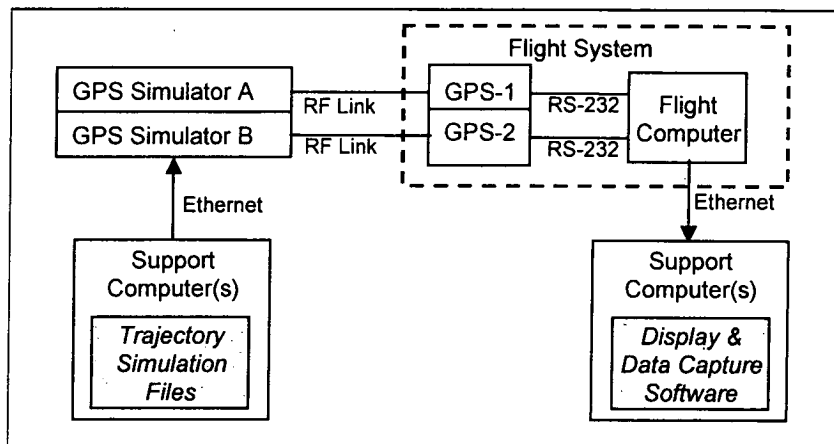

Figure 8. Phase II WFF Simulation Lab Test Configuration

Although there were several failures of the AFSS system (both Decision Logic and SBC RTOS I/O based), the primary test objective of verifying this type of system’s feasibility was met during the testing of 28 unique and different scenarios (20 initial and 8 additional). In addition, valuable lessons learned were acquired. Significant programmatic and AFSS system changes for Phase III were based on these lessons learned.

Phase III Development (Current)

The most significant programmatic change for AFSS Phase III development was the agreement between NASA's KSC and WFF. Both of these Centers have assumed responsibility for AFSS with support from existing on-site engineering support contractors. The project also became a 3-year effort to produce a flight qualifiable system with extensive testing. The Grid Structure Mapping Technique utilized in Phase II was abandoned in place of a vector-mapped technique. Additional navigational sensors in the form of a Rockwell Collins GNP-10 GPS/INS Navigational Sensor are being employed in Phase III. A typical GPS/INS configuration and its advantages are shown in Figure 9. Coupling the GNP-10 with an Inertial Measurement Unit (IMU) such as a Honeywell HG1700 Laser Ring Gyro or Litton LN200 Fiber Optic Gyro results in a synergistic GPS/INS combined system.

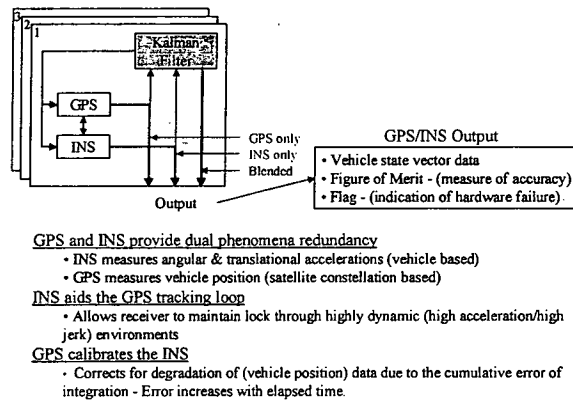

Figure 9. Typical GPS/INS Configuration

Preliminary system requirements and Concept of Operations (Con-Ops) documents have been released and reviewed by various interested range parties. This has resulted in numerous discussions with significant insight into the range world by AFSS participants. In particular, the Air Force Range Safety community has been very responsive and helpful, always willing to answer questions and to support reviews and demonstrations.

Changes in the algorithmic software approach on AFSS have resulted in four main types of missions rules. The four fundamental types of mission rules are:

1. The Parameter Threshold Rule allows the user to specify one or more threshold conditions that will trigger a destruct condition. It can be used to implement mission rules for erratic flight, no pitch program, no stage ignition, and low performance.
2. The Map Boundary Rule possesses support functions for evaluating whether or not a specified set of vehicle coordinates is inside or outside of a simple closed curve described in an associated boundary entity.
3. The Gate Rule possesses support algorithms for evaluating whether or not a specified set of vehicle coordinates has advanced beyond a line described in an associated gate entity.
4. The Green-Time Rule possesses support functions for evaluating whether or not a flight containment rule could be violated during a period of time within which the AFSS software has received no valid navigation solution data.

The flexibility of this proposed architecture results from the rich set of system modes and state variables made available for various mission rules. Therefore, it is expected that this modest library of rule types will accommodate virtually any ELV mission. Successful regression testing of the new algorithms with sensors and scenarios/trajectories from Phase II has been successful.

A change on the hardware side from a VME form factor SBC to a PC104 form factor SBC has significantly reduced the footprint and power requirements of an AFSS (currently utilizing MPL MIP405 PC104 SBCs). Like any highly reliable system (range requires 0.999 at 95%), redundancy is a key issue to a full up AFSS. It is envisioned that AFSS will have multiple navigational sensors that are cross-strapped to at least 3 flight processors. Current work is being performed on developing the capability of testing a “single string processor” AFSS subset as shown shaded in green in Figure 10 below. The Command Switching Logic and Interlock Circuit (CSLIC) interfaces between the flight processors and the FTS’s ordnance train. This section provides a means of arming and disarming the FTS safe/arm units for both ground and flight operations.

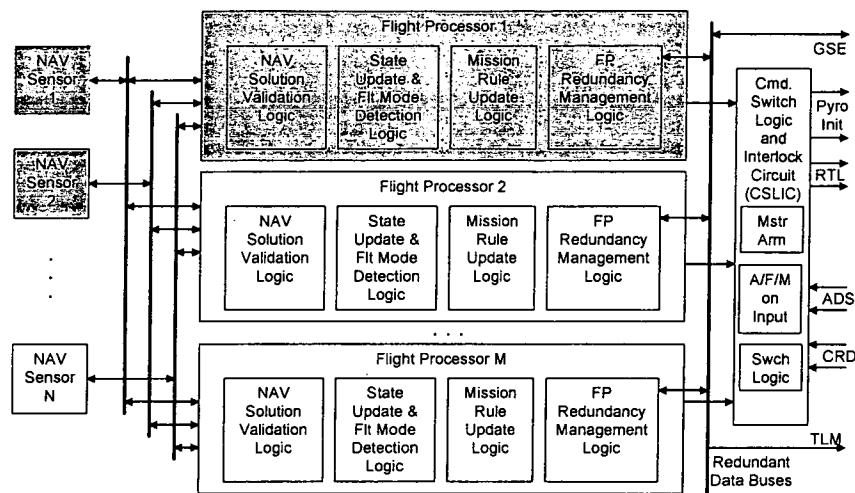

Figure 10. Phase III AFSS Hardware Configuration

An aircraft flight test is currently planned for the “single string processor” AFSS once formal bench lab testing at WFF’s GPS Simulation Lab has been successfully passed. In addition, extensive Monte Carlo simulation testing is planned for AFSS.

Conclusion

This project is an example of the “One NASA” initiative by providing resources from multiple locations to develop new technologies in space flight. Funding is currently provided by NASA Headquarters, Office of Space Flight, and Office of Safety and Mission Assurance. Wallops Flight Facility is providing project management, systems engineering, sensors, flight algorithms, software support, and testing. Kennedy Space Center is providing flight computer and sensor interface, software development and process management, flight algorithm support and systems engineering support.

The switch from a man-in-the-loop to an autonomous FTS is a significant undertaking that impacts both public safety and mission success. The current AFSS initiative visualizes that an interim period will exist in which AFSS will be interfaced with current systems. To achieve this, the AFSS architecture will have the capability of interfacing with one or more traditional Range Safety Command Destruct Receivers to enable a human override, or to enable a hybrid mode of operation when desirable.

2nd and 3rd Generation Reusable Launch Vehicle strategies envision order-of-magnitude improvements in launch vehicle safety and life cycle costs. A prerequisite for achieving these goals is to streamline and simplify the launch range(s) infrastructure. AFSS has the potential for removing all dependence on launch range infrastructure for flight safety. The AFSS concept requires none of the RF communication and command links, radar stations, data processing, display facilities, and trained operators needed by current land-based systems. Instead, it relies on an on-board GPS/INS system for its metric data source and on-board logic to emulate human decision processes.