

Experimental Investigation of Ice Phase Change Material Heat Exchangers

Thomas O. Leimkuehler¹

Paragon Space Development Corporation, Houston, Texas, 77058

and

Ryan A. Stephan²

NASA-Johnson Space Center, Houston, Texas, 77058

Phase change materials (PCM) may be useful for spacecraft thermal control systems that involve cyclical heat loads or cyclical thermal environments. Thermal energy can be stored in the PCM during peak heat loads or in adverse thermal environments. The stored thermal energy can then be released later during minimum heat loads or in more favorable thermal environments. This can result in a decreased turndown ratio for the radiator and a reduced system mass. The use of water as a PCM rather than the more traditional paraffin wax has the potential for significant mass reduction since the latent heat of formation of water is approximately 70% greater than that of wax. One of the potential drawbacks of using ice as a PCM is its potential to rupture its container as water expands upon freezing. In order to develop a space qualified ice PCM heat exchanger, failure mechanisms must first be understood. Therefore, a methodical experimental investigation has been undertaken to demonstrate and document specific failure mechanisms due to ice expansion in the PCM. A number of ice PCM heat exchangers were fabricated and tested. Additionally, methods for controlling void location in order to reduce the risk of damage due to ice expansion were investigated. This paper presents an overview of the results of this investigation from the past three years.

I. Introduction

FUTURE spacecraft thermal control systems may include a Phase Change Material (PCM) heat exchanger to ensure that the system maintains the required setpoint temperature throughout the mission profile. This setpoint temperature must be maintained despite radical changes in the vehicle's heat rejection requirement and ambient thermal environment throughout the mission.

A rapidly changing thermal environment can occur throughout the solar system. One such example of a quickly varying thermal environment is that encountered by a spacecraft in Low Lunar Orbit (LLO). Figure 1 shows the spatial distribution of the Lunar surface temperature. Because the moon does not have an atmosphere, the Lunar surface temperature varies from approximately 400 Kelvin to less than 100 Kelvin. The hottest portion of the lunar surface corresponds to the point directly aligned with the sun. This large variation in Lunar surface temperature results in rapid changes in the incident infrared heat flux on a spacecraft's radiator panels throughout a low beta angle orbit. The resultant variation in sink temperature leads to cyclic

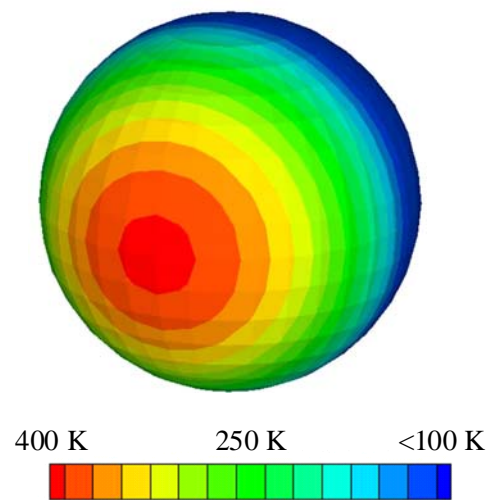

Figure 1. Lunar surface temperatures.

¹ Senior Aerospace Engineer, 1120 NASA Parkway, Suite 505, Houston, TX 77058, AIAA Member.

² Principal Investigator, Office of the Chief Technologist, *Mailing Address, AIAA Member.*

fluctuations in the radiator capability as shown by the red curve in Figure 2.

The radiator capability shown in this curve is representative of a 100 km circular orbit with a beta angle of zero degrees. In addition to the radiator capability, the vehicle heat rejection requirement is depicted by the blue curve. For this example, the vehicle heat rejection requirement is assumed to be a constant 4800 Watts. For the majority of the two-hour orbit, the radiator capability exceeds the heat rejection requirement. However, there are several times during the orbit, where the radiators are not capable of rejecting the full vehicle heat load. It is during these times, that a Supplemental Heat Rejection Device (SHReD) is required. The SHReD requirement is simply the difference between the heat rejection requirement and the radiator capability (shown as the green curve in Figure 2).

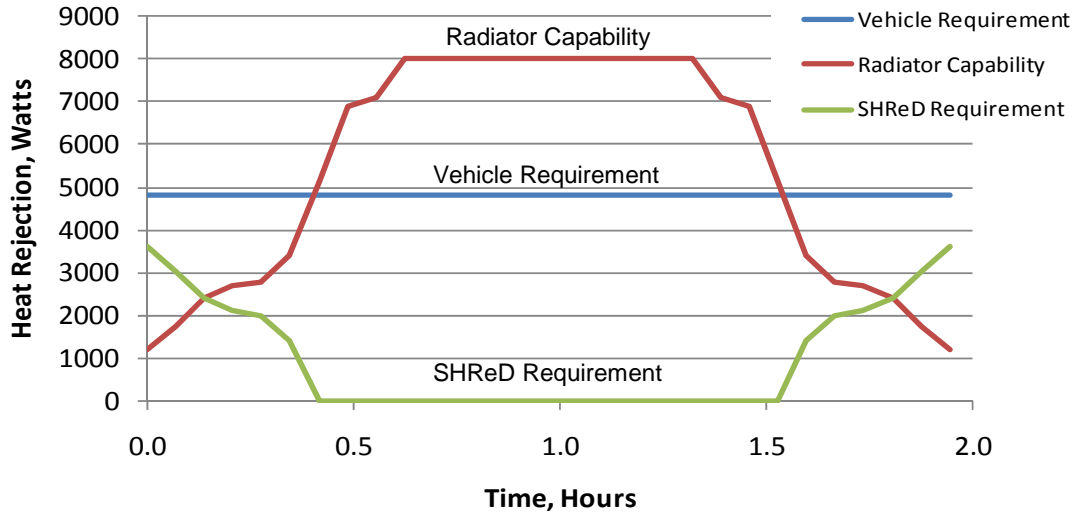

Figure 2. SHReD Requirements

Proper selection of the SHReD technology depends on the duration of the mission phase requiring a SHReD. For short missions, an evaporative heat sink may prove to be most mass effective. The rationale for this conclusion can be demonstrated by considering Eq. (1).

$$Mass = \frac{E}{H_f} \quad (1)$$

In the preceding equation, E represents the energy requirement which is given by the integral of the green curve in Figure 2, and H_f is the change in enthalpy of the fluid medium in the SHReD. For an evaporator using water as the evaporant, the change in enthalpy is approximately 2500 kJ/kg. Using water as a solid-liquid phase change material results in a change of enthalpy of 333 kJ/kg. However, because an evaporator relies on a consumable fluid, it can become mass prohibitive for long duration missions. Therefore, a liquid-solid PCM heat exchanger is often chosen for long duration missions because it does not require a consumable.

The current state-of-the-art for PCM heat exchangers¹ uses a paraffin wax as the phase change material. This project is investigating the use of water as a PCM due to water's significantly higher heat of fusion. Equation (1) can also be used to compare two separate phase change materials. A PCM with a high heat of fusion is desirable as it will reduce the mass of the vehicle's SHReD. The heat of fusion for n-pentadecane (a commonly chosen paraffin wax) is approximately 200 kJ/kg whereas the heat of fusion for water is 333 kJ/kg as mentioned above. The use of water as the phase change material has the potential to reduce the heat exchanger mass by approximately 70%.

The use of water is not without challenges, however. Unlike most materials, water expands as it freezes leading to concerns regarding structural integrity of the hardware. The objective of the current task is to assess the feasibility of replacing the commonly used paraffin-based material with water to realize the potential mass benefits associated with this change.

In previous testing,² a series of water PCM test articles were procured and tested at Johnson Space Center (JSC) for the purpose of better understanding and documenting the technical issues associated with the expansion of water within a PCM heat sink. One of these test articles was the Replicative Ice PCM (RIP), owing its name to the fact that it replicates the 450 kJ latent energy storage capacity of the baseline wax PCM unit. Two other test articles were each referred to as a Small Heatsink of Replicative Ice Material for Phase change (SHRIMP). These smaller

units had a 40 kJ latent energy storage capacity. Both SHRIMP's and the RIP included a 20% air gap for the purpose of accommodating the expansion of water upon freezing. A photograph of these test articles is shown in Figure 3.

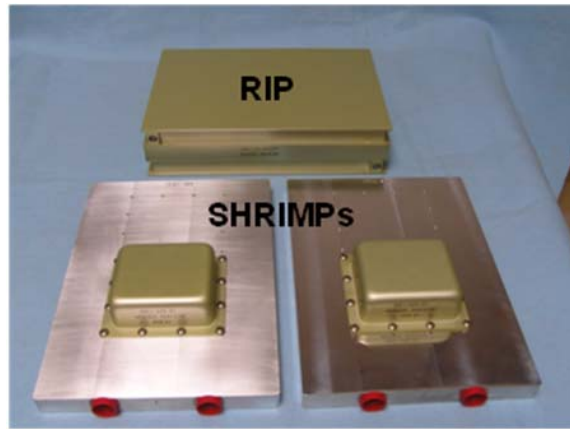
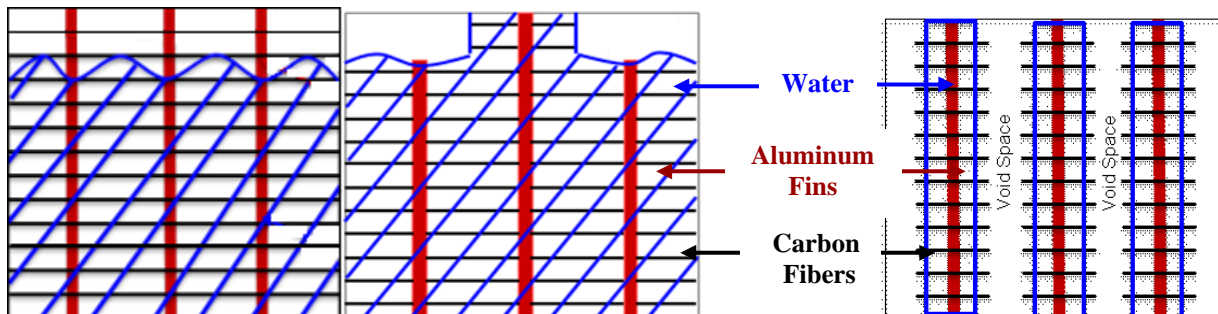

Figure 3. RIP and SHRIMP hardware.

Five additional heatsink test articles (HS01-HS05) were evaluated to help validate theories explaining why the RIP and SHRIMPs experienced structural integrity issues, as described in last year's paper³. Subsequent additional testing was desired in order to gain further understanding of the mechanisms causing damage to the PCMs. This paper documents the testing of additional test articles that were assembled from coldplates and untested PCM units from previous years.

II. Test Articles

The test articles used in this investigation encompassed various combinations of interstitial arrangements, cold plates, and size. There are three types of interstitial arrangements, two of which were evaluated this year. The Gen 1 arrangement, used in the original RIP and SHRIMP-1 test articles, is shown in Figure 4-A. It consists of carbon fibers attached to aluminum fins, with the fibers from neighboring fins touching. Water is filled to 80% capacity, with the remaining 20% as an air-filled void space. In Figure 4-A, the water is shown at the bottom and the void space is shown near the top. There were concerns about the Gen 1 design because if capillary effects dominate gravity effects, there is no preferred location of the water and voids. In this case freezing water may be unable to "reach" the void space when necessary. A Gen 2 design was made to address this situation and tested in previous years. In this design, the carbon fibers on separate aluminum fins did not contact each other, as shown in Figure 5-C below. The Gen 2 arrangement was not tested this year. The Gen1A core was also created and tested this year to address the Gen 1 design issue of water unable to "reach" void space when necessary. Its interstitial arrangement, displayed in Figure 5-B, is identical to Gen 1's except notches are cut into fins at the PCM's top. The notches are distributed to create relief channels to help aid in controlling freezing expansion. With liquid water preferentially located among the carbon fibers, the notches reserve void space farthest from the coldplate for the last bit of water to freeze and expand into. In the following discussion, it will be stated which interstitial arrangement was used in the test articles.



A

B

C

Figure 4: Interstitial Configurations.

(A) Gen 1 (original SHRIMP-1 and RIP). (B) Gen 1 A (HS06 & HS08). (C) Gen 2 (original SHRIMP-2).

The test articles were tested horizontally in either a favorable or adverse orientation with respect to gravity. The favorable gravity orientation, depicted in Figure 5, represents a test article positioned such that the PCM is above the coldplate. With this orientation, freezing occurs from the bottom to the top. Assuming gravity causes liquid water to be preferentially located at the bottom, the directional freezing from the bottom to the top pushes remaining liquid water into the available void space at the top of the PCM.

The adverse gravity orientation, depicted in Figure 6, represents a test article positioned such that the PCM is beneath the coldplate. With this orientation, freezing occurs from the top to the bottom. Assuming that gravity causes liquid water to be preferentially located at the bottom, the directional freezing from the top to the bottom results in an ice layer that separates remaining liquid water from the void space at the top. As the remaining liquid water freezes and expands, it must push the ice layer up into the void space, break through the ice layer into the void space, or push out on the PCM container and possibly cause damage.

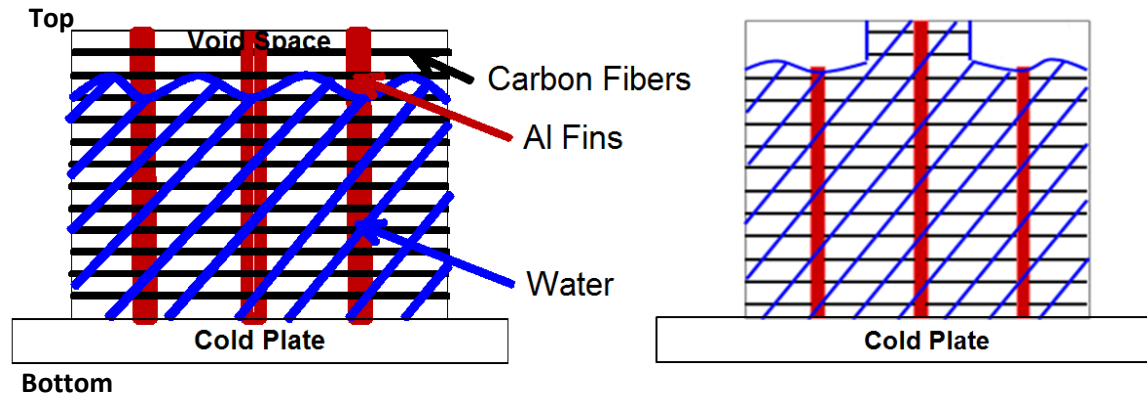

Figure 5: Favorable Gravity Testing Orientation

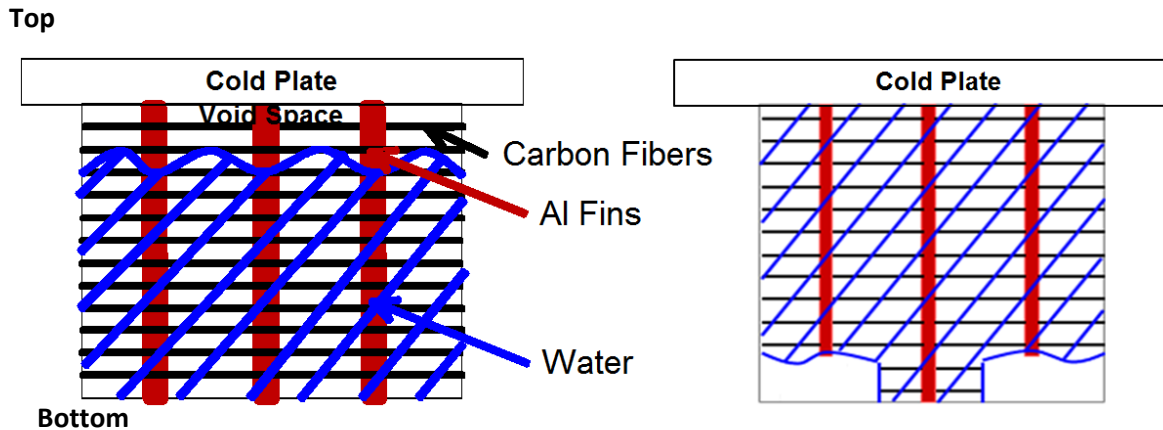

Figure 6: Adverse Gravity Testing Orientation

The following is a description of each heat sink tested during this year’s investigation. The heat sinks are listed in the order they were tested. Each of the heat sinks used a Thompson Industries single-pass cold plate (Figure 9). Previous years’ testing also used a CP-30 Lytron coldplate (Figure 8), which provides a less uniform heat flux between the PCM and its coldplate, and is referenced in the results section of this paper.

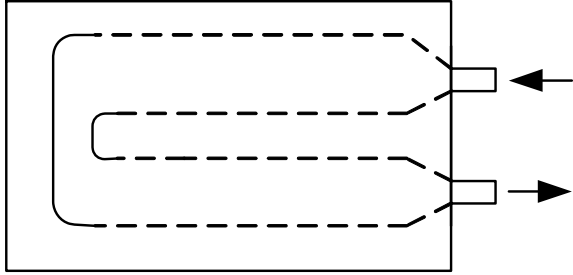

Figure 7: CP-30 Lytron Coldplate

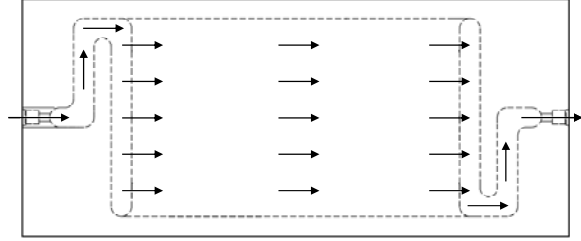

Figure 8: Thompson Industries Coldplate

A. Heat Sink 06 (HS06)

HS06 is a Gen 1A SHRIMP attached to the outlet side of a single-pass coldplate with screws (Figures 9 & 10). The SHRIMP is made from a machined aluminum base, with a drawn aluminum can and a laminate aluminum/carbon fiber core. Its Gen 1A core (Figure 11) has a larger number and distribution of relief channels than the Gen 1 design. These channels help to control freezing expansion.

HS06 was developed to both validate why the RIP and SHRIMP heat exchangers failed during previous testing and evaluate how well the Gen1A's additional relief channels control freezing expansion.

HS06 is directly comparable to last year's HS03, which has a Gen 1 core. The SHRIMP unit was in metal to metal contact with the coldplate; no thermal interface material was used. The SHRIMP was attached directly to the coldplate with screws using the same torque values as HS03. The flow-through coldplate for HS06, like HS03, does not have any no-flow regions in its SHRIMP footprint. Therefore, it should have a more uniform heat flux than articles tested on the CP-30 Lytron coldplate. However, reduced thermal contact resistance in the areas near the SHRIMP's screws may cause outside-in directional freezing in the PCM. Previous testing with SHRIMPs on the single-pass coldplates support this hypothesis because damage was always observed in the middle of the PCM.

It should be noted that HS06's SHRIMP came with a curved top instead of a flat top like the other shrimps, which can be seen in Figures 10 and 11 below. ESLI indicates that pre-shipment photos confirm the top was flat when it was fabricated, so it is not clear how the top became curved.

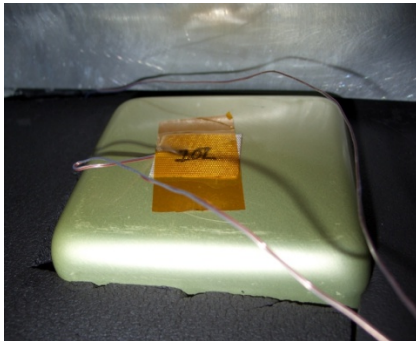

Figure 9: Heat Sink 06 (HS06)

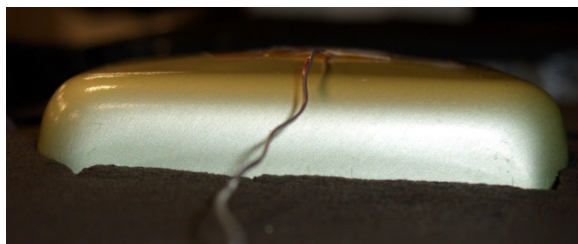

Figure 10: Initial Bulge on Heat Sink 06 (HS06)

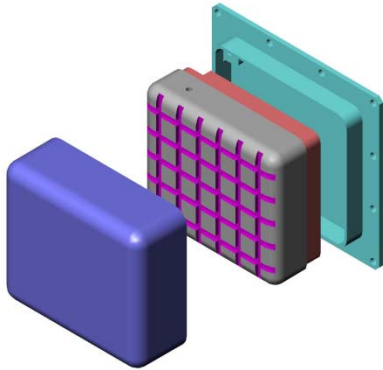

Figure 11: Gen 1A, Modified (420A) SHRIMP

B. Heat Sink 07 (HS07)

HS07 is similar to last year's HS03. Both heat sinks use the same single-pass coldplate and have Gen 1 interstitial arrangements (Figure 4-A). However, unlike any other PCM tested, HS07 is attached to the coldplate via double sided tape instead of screws.

HS07 was intended not only to validate theories on why RIP and SHRIMP heat exchangers failed during previous test cycles; it also was created to investigate how directional freezing might be prevented. Theoretically the double sided tape will provide a uniform contact resistance across the PCM. Prior to each test cycle, it was verified that the double sided tape had not pulled away from the coldplate and loosened its attachment to the PCM. It was hypothesized that the double sized tape would prevent directional freezing that may have occurred in the PCMs attached to coldplates via screws causing damage in the PCMs centers. Preventing directional freezing would provide additional control of void space and reduce or eliminate damage. Any occurring damage was not expected to be located in the center of the PCM.

C. Heat Sink 08 (HS08)

HS08 is identical to HS06 with a Gen 1A SHRIMP attached to the outlet side of a single-pass coldplate with screws. Its sole purpose was to validate the results of HS06 because HS06 had a slightly bulged top prior to testing, where all other SHRIMPs have not. There was concern that the bulge on HS06 may have provided additional void space and an unfair comparison to the other test articles.

III. Test Setup

The ice PCM test cart was designed to accommodate up to four test articles (see Fig. 12). The test cart consists of two chiller carts arranged to provide both a hot loop and a cold loop, which were used to thaw and freeze the phase change material, respectively. A mixture of propylene glycol and water was used as the working fluid in each of the pumped fluid loops. Test article flow rates could be varied by computer control or by adjusting isolation valves located immediately upstream and downstream of the test articles as shown in Fig. 12. Most of the test points were executed using a test article flowrate of approximately 100 lb/hr.

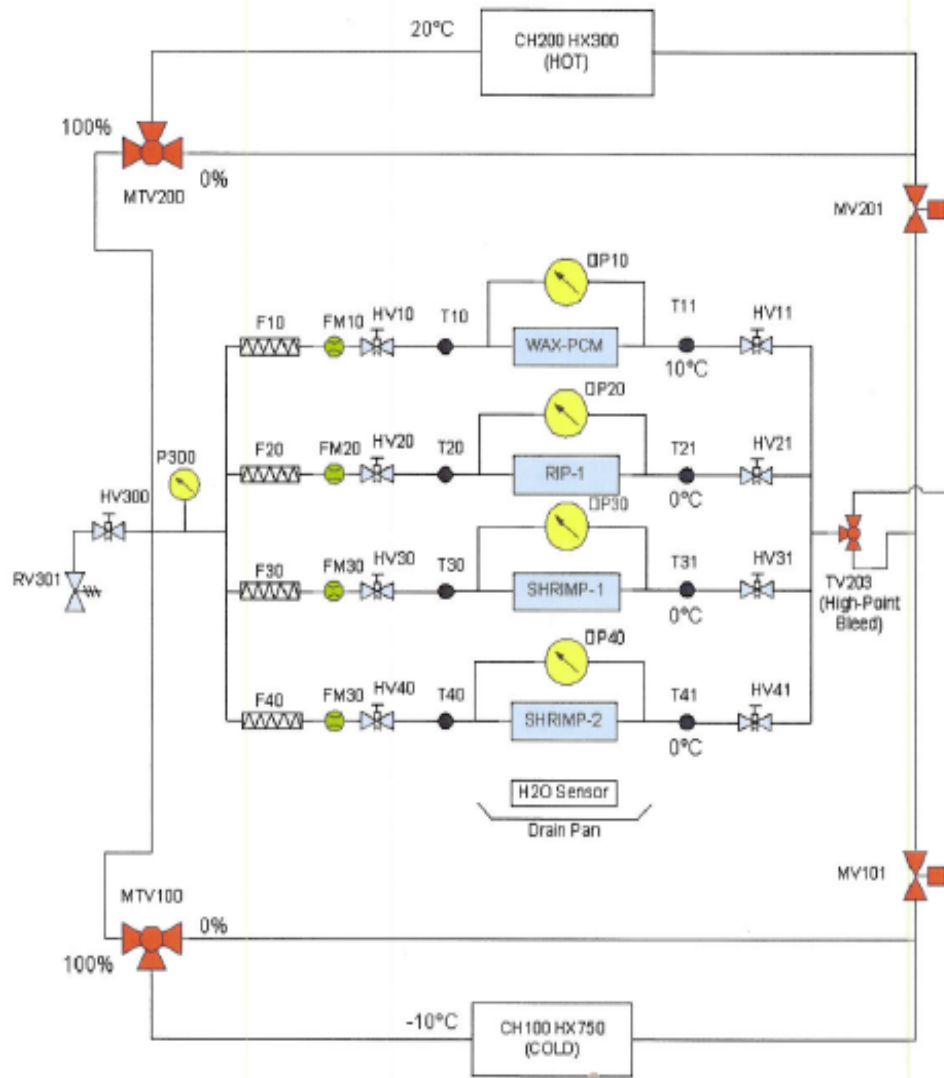

Figure 12. Test schematic.

Each test point began with an initial phase where the test article was cooled to 20°C. After an isothermal temperature was achieved, the freeze cycle was started. Once an isothermal temperature was achieved throughout the test article (typically between -4°C and -8°C) hot flow was started and the test article was again warmed to 20°C. Again, after an isothermal temperature was achieved at 20°C, the test cycle ended or was followed by another cold cycle.

IV. Test Parameters

Each heat sink was tested according to its own test plan document. Listed below are individual test parameters for each heat sink. Coolant flow rate and inlet temperatures were the same for all heat sinks at 100 lb/hr, 20°C and -10°C.

A. HS06

- A total of 87 cycles were run on HS06: 43 cycles were run in the favorable gravity orientation and 44 cycles were run in the adverse gravity orientation.
- The first 10 cycles were completed daily in the favorable gravity orientation.
- Test cycles 11-24 were completed twice daily in the favorable gravity condition.
- After cycle 24, HS06 was cycled continuously within an 8 hour time period for the following 5 work days.
- The same process was repeated for the adverse gravity orientation.

- HS06 was inspected after each cycle.
- HS06 was encased in Armaflex insulation.
- HS06 torque values the same as HS02 and HS03's.

B. HS07

- A total of 69 cycles were run on HS07: 39 cycles were run in the favorable gravity orientation and 30 cycles were run in the adverse gravity orientation.
- The first 10 cycles were completed daily in the favorable gravity orientation.
- Test cycles 11-24 were completed twice daily in the favorable gravity condition.
- After cycle 24, HS07 was cycled continuously within an 8 hour time period for the following 5 work days.
- The same process was repeated for the adverse gravity orientation until visible damage was observed.
- After damage was observed, 15 additional back to back cycles were performed to observe any possible change in the damage.
- HS07 was inspected after each test cycle.
- HS07 was encased in Armaflex insulation.
- HS07 was attached to the coldplate with double sided tape. Prior to each adverse gravity cycle it was verified that the SHRIMP was firmly attached to the coldplate.

C. HS08

- A total of 88 cycles were run on HS08: 44 cycles were run in the favorable gravity orientation and 44 cycles were run in the adverse gravity orientation.
- The first 10 cycles were completed daily in the favorable gravity orientation.
- Test cycles 11-24 were completed twice daily in the favorable gravity condition.
- After cycle 24, HS08 was cycled continuously within an 8 hour time period for the following 5 work days.
- The same process was repeated for the adverse gravity orientation.
- HS08 was inspected after each test cycle.
- HS08 was encased in Armaflex insulation.
- HS08 torque values the same as HS02 and HS03's.

V. Test Results

A. Test Article Damage

Damage to the heat sink housing was the major item of interest for this testing, along with the mechanisms for such failures. In this context, the term failure refers to bulging of the test articles due to the ice expansion. Table 1 is a summary of when the heat sinks failed in the favorable and adverse gravity test positions.

Table 1: Test Article Damage Summary

Orientation	HS06	HS07	HS08
	SHRIMP	SHRIMP	SHRIMP
Favorable	No damage after 43 test cycles	No damage after 39 test cycles	No damage after 44 test cycles
Adverse	No damage after 44 test cycles	Visible damage after 15 th test cycle	No damage after 44 test cycles

1. HS06

HS06 was expected to perform as good if not better than the Gen 1 PCMs due to the advantages of the Gen 1A interstitial arrangement. Damage was anticipated to be more likely in the adverse gravity position since most of the previously tested PCMs failed in the adverse orientation.

HS06 never failed after 43 favorable orientation cycles and 44 adverse orientation cycles. This result suggests that the Gen 1A core is effective in controlling the expanding water as it freezes. However, HS06's top bulged slightly outward prior to testing, as seen in Figures 9 and 10. Since none of the other SHRIMPs had this

characteristic, there was concern that the curved top provided more void space and thus prevented damage. Therefore, this test was repeated with HS08, which had a flat top.

2. HS07

Because of previous Gen 1 PCM test results, HS07 was expected to fail either in the favorable or shortly into the adverse gravity cycles. The double sided tape was predicted to create a constant contact pressure between the coldplate and the PCM. The more uniform contact would make a more constant thermal resistance and heat flux between the coldplate and the PCM. Theoretically, this should prevent the freezing front from pushing liquid water to specific locations in the PCM as it was thought to do with the SHRIMPs whose damage appeared in the center of the PCM. It was thought that by preventing directional freezing within the SHRIMP the water would expand to the desired void space and the article may not damage. If HS07 damaged, it would not necessarily be in the center of the PCM.

HS07 showed no damage on the top side after 39 favorable gravity cycles. It failed in the adverse gravity orientation after the 15th test cycle. Unexpectedly, HS07's damage appeared near the center of the PCM. The bump was not completely circular; it was slightly elongated in the direction perpendicular to the fluid flow. With additional cycles the bump appeared to slightly increase in both circumference and height. This result indicates either (a) uniform heat flux does not prevent ice expansion damage in the adverse orientation, (b) uniform heat flux was not established since heat is still conducted through the flanges and up the sidewalls of the PCM container, or (c) directional freezing is not responsible for the central location of the bulge as much as the middle just being the weakest location on the container.

It is also interesting to note that the double sided tape not only provided a more uniform heat flux, it also provided an overall increased thermal resistance between the PCM and the coldplate. This resulted in a lower overall heat transfer rate and slightly increased cycle times for HS07.



Figure 13: HS07 Damage (after 15th adverse gravity cycle)



Figure 14: HS07 Damage (after 30th adverse gravity cycle)

3. HS08

HS08 was predicted to perform similar to HS06 because these heat sinks were identical, except that HS06 had a slight bulge on its top prior to testing. The testing for HS06 was repeated for HS08, which had a flat top. No damage was observed for HS08 during its 44 favorable gravity test cycles and 44 adverse orientation cycles. The

results from HS06 and HS08 suggest that the Gen 1A core is effective in controlling the expanding water as it freezes.

B. Overall Heat Sink Comparisons

To aid in understanding the relationships among the various test articles, a summary of all articles tested over the last three years is provided in Table 2A and B. There are several levels of grouping in this table. The top row contains test articles with the larger size heat sinks (RIP's) and the bottom row contains test articles with the smaller size heat sinks (SHRIMP's). The type of interstitial arrangement is indicated across the top of the table as either "Gen 1" (see Figure 4-A), "Gen 1A" (see Figure 4-B), "Gen 2" (see Figure 4-C), or "Gen 2 (with gel)". Each grouping of interstitial arrangements is further subdivided by the type of coldplate. "CP-30" refers to the Lytron CP-30 coldplate with the PCM heatsinks centered on the coldplate. "CP-30 array" refers again to a Lytron CP-30 coldplate, but with an array of SHRIMP's that are positioned directly above the flowpaths in the coldplate. (Note that this designation is not applicable to the larger size heatsinks, and is therefore grayed out in the corresponding sections of the table.) "Single-Pass" refers to the single-pass Thompson Industries coldplate. Finally, each test article is represented in the appropriate location of the table by a sketch showing the appearance of the test article as well as a sketch depicting the interstitial material arrangement.

Additionally, a summary of the damage observed for each test article is provided in Table 3A and B. These tables are arranged in the same manner as Table 2A and B, but with the rows further subdivided into favorable and adverse orientations with respect to gravity. A red-yellow-green scheme is used to help visually depict how well the various test articles performed relative to each other in terms of susceptibility to damage from ice expansion. Red is used where damage was observed within the first 5 cycles, yellow is used where damage was observed after the first 5 cycles, and green is used where damage was not observed during any of the testing completed so far.

General pre-test predictions were that performance was expected to generally improve as you move to the right in these tables. At the top level, Gen 1A articles were expected to perform better than Gen 1 test articles. Furthermore, moving to the right within a given generation of interstitial materials was expected to result in increasing uniformity of heat fluxes and improved performance. Whether these predictions were realized during the testing will be discussed next.

The rest of this section discusses observations from the testing across various logical groupings of the test articles.

Table 2A: Summary of Gen 1 and Gen 1A Test Articles

		Gen 1				Gen 1A	
		CP-30	CP-30 array	Single-Pass	Single-Pass (Attached with Tape)	Single-Pass	
Large		RIP	N/A	HS01			
							
Small		SHRIMP-1	HS02	HS03	HS07	HS06	HS08
							

Table 2B: Summary of Gen 2 Test Articles

	Gen 2			Gen 2 (with gel)		
	CP-30	CP-30 array	Single-Pass	CP-30	CP-30 array	Single-Pass
Large	HS04	N/A		HS05	N/A	
						
Small	SHRIMP-2					
						

Table 3A: Summary of Gen 1 and Gen 1A Test Article Damage

		Number of cycles until damage					
		Gen 1			Single-Pass (Attached with Tape)	Gen 1A	
		CP-30	CP-30 array	Single-Pass		Single-Pass	
Large	Orientation	RIP	N/A	HS01			
	Favorable (top)	≤2		2			
	Adverse (bottom)	≤2		1			
Small	Orientation	SHRIMP-1	HS02	HS03	HS07	HS06	HS08
	Favorable (top)	No damage after 25 cycles	11-25	22	No damage after 39 cycles	No damage after 43 cycles	No damage after 44 cycles
	Adverse (bottom)	1	1	1	1	No damage after 44 cycles	No damage after 44 cycles

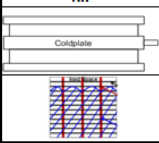
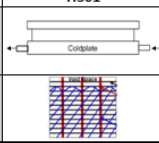
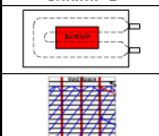
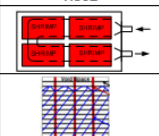
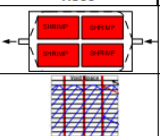
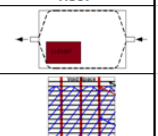
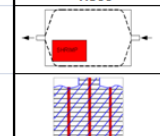
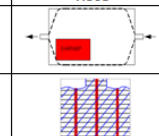
Table 3B: Summary of Gen 2 Test Article Damage

		Number of cycles until damage					
		Gen 2			Gen 2 (with gel)		
		CP-30	CP-30 array	Single-Pass	CP-30	CP-30 array	Single-Pass
Large	Orientation	HS04	N/A		HS05	N/A	
	Favorable (top)	No damage after 25 cycles			No damage		
	Adverse (bottom)	1			No damage		
Small	Orientation	SHRIMP-2					
	Favorable (top)	No damage after 25 cycles					
	Adverse (bottom)	≤20					

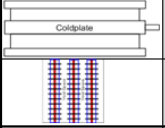
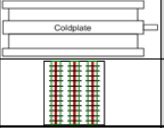
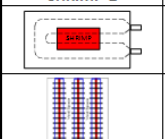
1. *HS07 and HS03*

HS07 and HS03 use Gen 1 SHRIMPs and Thompson Industries single-pass coldplates. HS07 differs from HS03 by using double sided tape to attach its SHRIMP to its coldplate. The double sided tape both adds additional thermal contact resistance between the PCM and the coldplate and provides for a more uniform heat flux than screws.

HS03's PCMs failed sooner than HS07's. HS03 had failed during favorable gravity and the first adverse gravity cycle, while there was no visible damage on HS07 until after the 15th adverse gravity cycle.

The damage to HS07 and HS03 also differed. Both of HS03's SHRIMPs have noticeably larger and longer bulges with skinny oval-shaped peaks orientated perpendicular to the direction of fluid flow under the PCM.

HS07's bulge, although also located near the center of the PCM, has a much more circular peak, and expands less across the SHRIMP's.

HS07's damage occurring later as well as its smaller more circular size is likely due to the more uniform heat flux between it and the cold plate. However, it is unclear why HS07 also damaged in the center of the PCM. This result indicates either (a) uniform heat flux does not prevent ice expansion damage in the adverse orientation, (b) uniform heat flux was not established since heat is still conducted through the flanges and up the sidewalls of the PCM container, or (c) directional freezing is not responsible for the central location of the bulge as much as the middle just being the weakest location on the container.

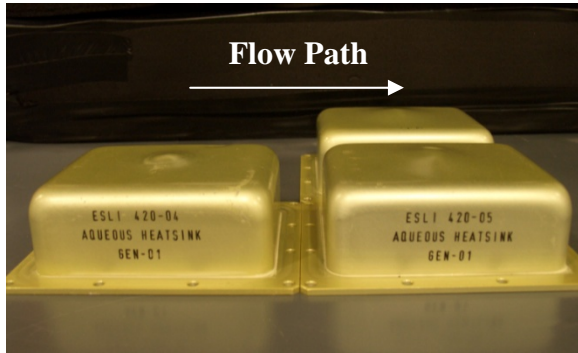

Figure 15: HS07 (left) HS03 (right)

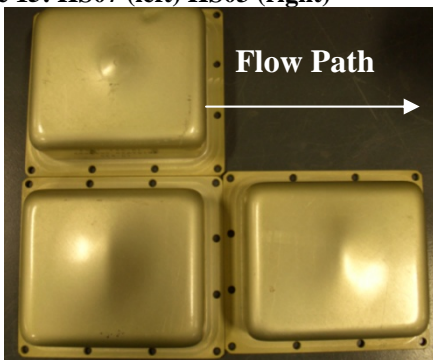

Figure 16: HS07 (top) HS03 (bottom)

2. *HS06, HS08 and HS03*

HS06 and HS08 both have Gen 1A SHRIMPs while HS03 used Gen 1 SHRIMPS. Each heat sink attached its SHRIMP(s) to the outlet side of a single-pass cold plate with screws. The torque values of each screw were the same, so the only difference between the articles would be the type of core it had.

HS06 and HS08 never failed, while HS03's PCMs failed in both favorable and adverse gravity orientations. This supports the hypothesis that the Gen 1A interstitial arrangement may do a better job at reducing susceptibility to ice expansion damage by reserving void space for the last bit of water to freeze and expand into.

3. *HS06, HS08 and SHRIMP-2*

HS06 and HS08 both have Gen 1A SHRIMPs while SHRIMP-2 has a Gen 2 SHRIMP. Their coldplates and the torque values of the screws fastening the PCMs to the coldplates differ. The effects of the different screw torques and coldplates are assumed to be negligible. Therefore it appears that the Gen 1A interstitial arrangement performs better than the Gen 2 interstitial arrangement.

The following comparisons are between articles tested prior to this year; however they are included for completeness.

4. *SHRIMP-1, HS02 and HS03*

SHRIMP-1 and HS02 use a Lytron coldplate, while HS03 is mounted on a single-pass Thompson Industries coldplate. Each heat sink has the same Gen 1 interstitial arrangement (see Figure 4-A). All three of these test articles showed damage after the first cycle in an adverse orientation, which shows the deficiency of the Gen 1 interstitial arrangement. It is unclear why SHRIMP-1 did not show any damage during testing in the favorable orientation while HS02 and HS03 did. If anything, the opposite trend may have been expected due to the potentially more uniform heat flux associated with the location of the HS02 and HS03 SHRIMPs on their respective coldplates.

5. *RIP and HS01*

RIP and HS01 both have the large PCM heat sink and the Gen 1 interstitial arrangement. The only difference between these two test articles is the coldplate. Both test articles showed damage on both the top and the bottom (both favorable and adverse orientations) within the first 2 cycles, which shows the deficiency of the Gen 1 interstitial arrangement. It is unclear why the locations of the bulges seen on HS01 appeared to be randomly located.

6. *SHRIMP-1 and SHRIMP-2*

SHRIMP-1 and SHRIMP-2 are both the smaller size heat sinks mounted in the middle of a CP-30 coldplate. The only difference between these two test articles is the interstitial arrangement. Both of these test articles showed no damage after 25 cycles in the favorable orientation. This is likely due to the favorability of the orientation since it results in freezing from the bottom to the top, with any void space always available for the remaining liquid water on top to expand into as it freezes.

The Gen 2 interstitial arrangement did show some improvement over the Gen 1 interstitial arrangement for the adverse orientation tests. This seems to support the hypothesis that the Gen 2 interstitial arrangement may do a better job at maintaining a more even distribution of void space and reduced susceptibility to ice expansion damage.

7. *RIP, HS04, and HS05*

All three of these test articles have the larger size heat sinks mounted on a CP-30 coldplate. The only differences are the interstitial arrangement and whether gel has been added to the water. On the top side, the Gen 2 interstitial arrangement showed significant improvement over the Gen 1 arrangement, with HS04 and HS05 showing no damage after 25 cycles while RIP showed damage within the first two cycles. On the bottom side, it appears that the gel was necessary to help the Gen 2 interstitial arrangement show improved performance, with HS05 still showing no damage on the bottom after 25 cycles while RIP and HS04 showed damage within the first two cycles. As

pointed out earlier, a potential caveat to this observation may be the possibility that the reduced charge of water in HS05 could have provided more void space for ice expansion than the other test articles.

It is a little surprising that the bottom side of HS04 showed damage already after the first cycle. It was anticipated that the Gen 2 interstitial arrangement would have provided some degree of improvement over the Gen 1 arrangement in the RIP, but this was not the case in the adverse orientation.

8. *RIP and SHRIMP-1*

RIP and SHRIMP-1 both have the Gen 1 interstitial arrangement and are mounted on CP-30 coldplates. The only difference between these two test articles is the size of the PCM heat sinks. Both of these test articles showed damage on the bottom side (adverse orientation) within the first two cycles. On the top side (favorable orientation), however, RIP showed damage within the first two cycles, but SHRIMP-1 did not show any damage after 25 cycles. Again, the only difference between these two is the size of the heatsinks, with the smaller SHRIMP-1 performing better than the larger RIP. The difference in performance between these two test articles contributes to the hypothesis that directional freezing may push water around inside of the heatsink, and this effect may be more pronounced in the larger heatsinks since there is more room to push the water around.

9. *HS01 and HS03*

HS01 and HS03 both have the Gen 1 interstitial arrangement and both are mounted on a single-pass Thompson Industries coldplate. The only difference between these two test articles is the size of the PCM heat sinks. Both of these test articles showed damage in the adverse orientation on the first cycle. In the favorable orientation, however, HS01 showed damage on the second cycle, but HS03 did not show any damage until cycle 22. Again, the only difference between these two is the size of the heatsinks (similar to the previous paragraph), with the smaller HS03 PCM heat sinks performing better than the larger HS01. The difference in performance between these two test articles contributes to the hypothesis that directional freezing may push water around inside of the heatsink, and this effect may be more pronounced in the larger heatsinks since there is more room to push the water around.

10. *HS04 and SHRIMP-2*

HS04 and SHRIMP-2 both have the Gen 2 interstitial arrangement and both are mounted on a CP-30 coldplate. The only difference between these two test articles is the size of the PCM heat sinks. Both of these test articles showed no damage on the top (favorable orientation) after 25 cycles. On the bottom (adverse orientation), however, HS04 showed damage on the first cycle, but SHRIMP-2 did not show any damage until a number of cycles (less than 20) later. Again, the only difference between these two is the size of the heatsinks (similar to the previous two paragraphs), with the smaller SHRIMP-2 performing better than the larger HS04. The difference in performance between these two test articles contributes to the hypothesis that directional freezing may push water around inside of the heatsink, and this effect may be more pronounced in the larger heatsinks since there is more room to push the water around.

VI. Conclusion

Testing over the past year continued to investigate the failure mechanisms of ice PCM heat exchangers. Specifically this year's testing focused on evaluating both the Gen 1A interstitial arrangement and the effects of a uniform heat flux between a SHRIMP and its coldplate. HS06 and HS08 were created to be directly comparable to HS03 so the performance of the Gen 1A and Gen 1 cores could be contrasted. Their results could also be compared with HS02's and SHRIMP-2's, who had Gen 2 cores despite their different coldplates and screw torque values. HS07 presumably had a much more uniform heat flux between its SHRIMP and coldplate than the other heat sinks because it used double sided tape to fasten its SHRIMP and coldplate together. HS07 otherwise had the same parameters as HS03 so the effect of only the more uniform heat flux would be observed in the results.

The following summarizes the observations from the past three years in four categories:

A. Gen 1A vs. Gen 1 and Gen 2 Interstitial Arrangements

From FY2010 it was determined that the Gen 2 interstitial arrangement appears to provide better void control than the Gen 1 interstitial arrangement. **Error! Reference source not found.** However from testing HS06 and HS08 it appears that the Gen 1A arrangement performs the best because it never had any visible damage.

With the Gen 1 interstitial arrangement, assuming surface tension dominates over gravity, water and voids can be located anywhere in the PCM housing with equal likelihood. Therefore, the relative distribution of water and voids cannot be controlled, so encapsulation of voids during freezing and isolation from the remaining liquid water cannot be avoided with any degree of certainty. The Gen 1A and Gen 2 interstitial arrangements do a better job of maintaining a desired distribution of water and voids, with the Gen 1A interstitial arrangement apparently doing a better job keeping the liquid water in contact with the coldplate while reserving void space for the last bit of freezing water.

B. Gel

The addition of polyacrylamide gel to the water in HS05 may have helped improve wicking and void control.

C. Directional Freezing Pushing Water

Because large PCMs showed evidence of directional freezing pushing water from the cold to hot sides of the PCM, it is unclear why all the SHRIMPs that damaged exhibited a bulge in their center. Prior to testing HS07 it was hypothesized that either the non uniform contact resistance between each SHRIMP and its coldplate caused water to be pushed to the SHRIMP's middle, or something other than freezing direction may determine the location of the damage. If the first hypothesis were true, then the outside-in freezing for the smaller SHRIMP test articles would be due more to reduced contact resistance at the fasteners around the periphery of the test article rather than to flow and no-flow areas of the coldplate. Assuming the double sided tape created a uniform contact resistance between HS07's SHRIMP and coldplate, it appears that something other than freezing direction is determining the location of damage. This result indicates either (a) uniform heat flux does not prevent ice expansion damage in the adverse orientation, (b) uniform heat flux was not established since heat is still conducted up the sidewalls of the PCM container, or (c) directional freezing is not responsible for the central location of the bulge as much as the middle just being the weakest location on the container. In the favorable gravity orientation, conduction along the side walls may result in a layer of ice forming across the top of the water similar to how ice spikes form in an ice cube tray, with something like an ice spike pushing up in the middle of the SHRIMP.

D. Size

Smaller test articles performed as well as or better than their larger counterparts with respect to the number of cycles endured before damage occurred. This may be due to larger test articles having more room for water to get pushed around.

VII. Recommendations for Future Work

The following recommendations are made for future work with ice PCM heatsinks:

- Investigate the relative effects of gravity and surface tension on the distribution of water and voids in the test articles. In the above discussions, assumptions have to be made regarding which force dominates in each test article, but it is not clear what the actual situation is in each. Furthermore, developing an optimal design for actual requirements may result in different PCM thicknesses that may be larger than the capillary height supported by the current interstitial arrangements.
- Fabricate and test full-scale Gen 1A test articles to see if the successful results from the smaller HS06 and HS08 scale to a larger size.
- Investigate different PCM housing material thicknesses.
- Consider additional methods for avoiding encapsulation of voids by freezing water and whether these methods offer any improvements over surface tension.
- Eventually microgravity testing would be useful since successful performance in microgravity is not always guaranteed by gravity orientation independence in 1-g.

Acknowledgments

The authors would like to thank Timothy Knowles and Mike Carpenter at Energy Science Laboratories, Inc. (ESLI) for fabricating the test articles for this investigation and for sharing their expertise and insight into the design and operation of these phase change material heatsinks.

References

¹Lillibridge, S., and Stephan, R., “Phase Change Material Heat Exchanger Life Test,” SAE Paper 2009-01-2589, 39th International Conference on Environmental Systems (ICES), Savannah, GA, July 2009.

²Leimkuehler, T. O., Stephan, R. A., and Hansen, S., “Development, Testing, and Failure Mechanisms of a Replicative Ice Phase Change Material Heat Exchanger,” AIAA-2010-6138, 40th International Conference on Environmental Systems (ICES), Barcelona, Spain, July 2010.

³Leimkuehler, T. O., Stephan, R. A., and Hawkins-Reynolds, E., “Testing and Failure Mechanisms of Ice Phase Change Material Heat Exchangers,” AIAA-2011-5207, 41st International Conference on Environmental Systems (ICES), Portland, Oregon, July 2011.