

NASA/TM–2012-208641 / Vol 5



ICESat (GLAS) Science Processing Software Document Series

**The Algorithm Theoretical Basis Document for
Level 1A Processing**

Peggy Jester and David Hancock

National Aeronautics and
Space Administration

**Goddard Space Flight Center
Greenbelt, Maryland 20771**

June 2012

NASA STI Program ... in Profile

Since its founding, NASA has been dedicated to the advancement of aeronautics and space science. The NASA scientific and technical information (STI) program plays a key part in helping NASA maintain this important role.

The NASA STI program operates under the auspices of the Agency Chief Information Officer. It collects, organizes, provides for archiving, and disseminates NASA's STI. The NASA STI program provides access to the NASA Aeronautics and Space Database and its public interface, the NASA Technical Report Server, thus providing one of the largest collections of aeronautical and space science STI in the world. Results are published in both non-NASA channels and by NASA in the NASA STI Report Series, which includes the following report types:

- **TECHNICAL PUBLICATION.** Reports of completed research or a major significant phase of research that present the results of NASA Programs and include extensive data or theoretical analysis. Includes compilations of significant scientific and technical data and information deemed to be of continuing reference value. NASA counterpart of peer-reviewed formal professional papers but has less stringent limitations on manuscript length and extent of graphic presentations.
- **TECHNICAL MEMORANDUM.** Scientific and technical findings that are preliminary or of specialized interest, e.g., quick release reports, working papers, and bibliographies that contain minimal annotation. Does not contain extensive analysis.
- **CONTRACTOR REPORT.** Scientific and technical findings by NASA-sponsored contractors and grantees.
- **CONFERENCE PUBLICATION.** Collected papers from scientific and technical conferences, symposia, seminars, or other meetings sponsored or co-sponsored by NASA.
- **SPECIAL PUBLICATION.** Scientific, technical, or historical information from NASA programs, projects, and missions, often concerned with subjects having substantial public interest.
- **TECHNICAL TRANSLATION.** English-language translations of foreign scientific and technical material pertinent to NASA's mission.

Specialized services also include organizing and publishing research results, distributing specialized research announcements and feeds, providing help desk and personal search support, and enabling data exchange services. For more information about the NASA STI program, see the following:

- Access the NASA STI program home page at <http://www.sti.nasa.gov>
 - E-mail your question via the Internet to help@sti.nasa.gov
 - Fax your question to the NASA STI Help Desk at 443-757-5803
 - Phone the NASA STI Help Desk at 443-757-5802
 - Write to:
NASA STI Help Desk
NASA Center for AeroSpace Information
7115 Standard Drive
Hanover, MD 21076-1320
-



ICESat (GLAS) Science Processing Software Document Series

**The Algorithm Theoretical Basis Document for
Level 1A Processing**

Peggy L. Jester
SGT, Inc., Wallops Island, VA

David W. Hancock III
Sigma Space Corporation, Wallops Island, VA

National Aeronautics and
Space Administration

Goddard Space Flight Center
Greenbelt, Maryland 20771

Notice for Copyrighted Information

This manuscript has been authored by employees of *SGT/GGSG* under contract #NNG11HP14C and the *Sigma Space Corporation* under contract #NNG09HP18C with the National Aeronautics and Space Administration. The United States Government has a non-exclusive, irrevocable, worldwide license to prepare derivative works, publish, or reproduce this manuscript, and allow others to do so, for United States Government purposes. Any publisher accepting this manuscript for publication acknowledges that the United States Government retains such a license in any published form of this manuscript. All other rights are retained by the copyright owner.

Trade names and trademarks are used in this report for identification only. Their usage does not constitute an official endorsement, either expressed or implied, by the National Aeronautics and Space Administration.

Level of Review: This material has been technically reviewed by technical management

Available from:
NASA Center for AeroSpace Information
7115 Standard Drive
Hanover, MD 21076-1320

National Technical Information Service
5285 Port Royal Road
Springfield, VA 22161 Price Code: A17

Foreword

The GEOSCIENCE LASER ALTIMETER SYSTEM (GLAS) is a part of the EOS program. This laser altimetry mission will be carried on the spacecraft designated EOS ICESat (Ice, Cloud, and Land Elevation Satellite). The GLAS laser is a frequency-doubled, cavity-pumped, solid state Nd:YAG laser. The GLAS instrument will provide both surface laser altimetry and atmospheric lidar data. The science goals and requirements are documented in the GLAS Science Requirements Document which is listed in the Bibliography. This document provides the algorithms to convert the instrument data from raw counts into engineering units suitable for input to the science algorithms described in further ATBDs.

This document was prepared by the Observational Science Branch at NASA GSFC/WFF, Wallops Island, VA, in support of Bob E. Schutz, GLAS Science Team Leader for the GLAS Investigation. The information in this document was collected by Peggy L. Jester, SGT, Inc., Instrument Support Facility Lead, in support of the GLAS Instrument Team. This work was performed under the direction of David W. Hancock, III, who may be contacted at (757) 824-1238, hancock@osb.wff.nasa.gov (e-mail), or (757) 824-1036 (FAX).

Table of Contents

Foreword.....	v	
Table of Contents	vii	
List of Tables	xi	
Section 1	Introduction	
Section 2	Algorithm Description	
2.1	Level 0 to Level 1A Conversions	2-1
2.2	Quality Assurance.....	2-6
2.3	Browse Products	2-12
Section 3	Implementation Considerations	
3.1	Standards.....	3-1
3.2	Ancillary Inputs	3-1
3.3	Accuracy	3-1
3.4	Computational: CPU and Disk Storage	3-1
3.5	Software Validation	3-2
Section 4	Constraints, Limitations, and Assumptions	
4.1	Constraints and Limitations	4-1
4.2	Assumptions	4-1
Section 5	Bibliography	
Appendix A	Conversion Tables	
A.1	Conversion Description for Each APID	A-1
A.2	Telemetry Pseudo Engineering Unit Conversion	A-1
A.3	Laser and OTS Enable readbacks	A-36
A.4	FET Switch Bank	A-36
A.5	Optical Sensor Status	A-36
A.6	Status Command Telemetry	A-36
A.7	CD Status Flags	A-36
A.8	DC Status Flags	A-38
A.9	PC Status Flags.....	A-38
A.10	CT Task Mode	A-39
A.11	Subsystem Present Flags.....	A-40
A.12	CS Status Flag.....	A-41
A.13	SM Table Operations Flag	A-41
A.14	BCRT Control Register Word	A-41
A.15	CD Raw A/D Output Data	A-42
A.16	CD Interrupt Status	A-42
A.17	DC Interrupt Mask Register	A-42
A.18	DC FIFO Flags Register.....	A-43
A.19	DC LPA Gain Register	A-43

A.20	DC LPA Packet Count Register	A-43
A.21	PC Hardware Mode Status	A-44
A.22	MD Enable / Disable Flag	A-45
A.23	CT Suppressed Event Message Error Flag	A-45
A.24	CT Loop Heat Pipe Control State	A-46
A.25	GP Task Status Bits	A-46
A.26	AD Software Enable Flags	A-47
A.27	AD DSP Trouble Indicator Status Word	A-47
A.28	DEM Minimum and Maximum Bytes	A-48
A.29	Range Window Status	A-48
A.30	AD Target Status and Mode Flags	A-49
A.31	Etalon Flags	A-49
A.32	Time Tagging Algorithm	A-50
Appendix B GLAS Telemetry Description		
B.1	GLAS Housekeeping and Diagnostic Telemetry Description	B-2
B.2	Science Packet Descriptions	B-38
Appendix C Background Information for Time Tagging Algorithm		
C.1	Information	C-1
C.2	Problems to Consider:	C-3
C.3	Telemetry Definitions	C-4
Appendix D GLAS Science Packets Synchronization and Alignment Information		
Appendix E Laser Energy Calibration		
	Abbreviations & Acronyms	AB-1
	Glossary	GL-1

List of Tables

Table 1-1	GLAS Telemetry Packets	1-1
Table 1-2	The GLAS Level 1A Data Products	1-3
Table A-1	Conversion Description for GLAS Telemetry Data	A-2
Table A-2	Pseudo-Telemetry Conversions	A-34
Table A-3	Laser and OTS Readback Interpretation.	A-36
Table A-4	FET Switch Bank Interpretation	A-36
Table A-5	Optical Sensor Status Interpretation	A-37
Table A-6	Command Status Interpretation	A-37
Table A-7	CD Status Flag Interpretation	A-38
Table A-8	DC Status Flag Interpretation	A-39
Table A-9	PC Status Flag Interpretation	A-39
Table A-11	Subsystem Present Flag Interpretation	A-40
Table A-10	CT Task Mode Interpretation	A-40
Table A-12	CS Status Flag Interpretation	A-41
Table A-15	CD Raw A/D Output Data Interpretation	A-42
Table A-16	CD Interrupt Status Interpretation	A-42
Table A-13	SM Table Operations Flag Interpretation.	A-42
Table A-14	BCRT Register Control Word Interpretation	A-42
Table A-18	DC FIFO Flags Register Interpretation	A-43
Table A-19	DC LPA Gain Register Interpretation	A-43
Table A-17	DC Interrupt Mask Register Interpretation.	A-43
Table A-21	PC Hardware Mode Status Interpretation.	A-44
Table A-20	DC LPA Packet Count Register Interpretation.	A-44
Table A-22	MD Enable /Disable Flag Interpretation.	A-45
Table A-23	CT Suppressed Event Message Error Flag Interpretation	A-45
Table A-24	CT LHP Control State Interpretation	A-46
Table A-25	GP Task Status Bits Interpretation	A-46
Table A-26	AD Software Enable Flag Interpretation	A-47
Table A-27	AD DSP Trouble Indicator Status Word Interpretation	A-47
Table A-28	Range Window Status Interpretation	A-48

Table A-29	AD Target Status and Mode Flag Word Interpretation	A-49
Table A-30	Etalon Flags Word Interpretation	A-49
Table C-1	APIDs used by Normal I-SIPS Processing	C-1
Table C-2	Format of PRAP	C-4
Table C-3	Time and Position Message Packet Description.	C-5

Section 1
Introduction

The first process of the Geoscience Laser Altimeter System (GLAS) Science Algorithm Software converts the Level 0 data into the Level 1A Data Products. The Level 1A Data Products are the time ordered instrument data converted from counts to engineering units. This document defines the equations that convert the raw instrument data into engineering units. Required scale factors, bias values, and coefficients are defined in this document. Additionally, required quality assurance and browse products are defined in this document.

The GLAS Level 0 data consists of a number of different instrument packet types, each type having its own application identifier (APID). Each packet type generally contains data relative to one of the prime GLAS measurements or subsystems. The EOS Data and Operations System (EDOS) delivers the instrument packets to the ICESat Science Investigator-led Processing System (I-SIPS) in Production Data Sets (PDS). Each PDS is a time-ordered set of packets received during a telemetry dump for a particular APID. At EDOS, the packets are Reed-Solomon decoded; redundant packets associated with previous dumps are removed; and some frame error checking is done. The Level 0 APIDs are listed in Table 1-1 "GLAS Telemetry Packets". The level 0 data is described in Appendix B.

Table 1-1 GLAS Telemetry Packets

Packet Name	APID
Altimeter Digitizer Data-Large	12
Altimeter Digitizer Data-Small	13
Altimeter Digitize Engineering Mode	14
Photon Counter (PC) Science	15
PC Engineering	16
Cloud Digitizer (CD) Science	17
CD Engineering	18
Ancillary Science	19
Laser Profiler Array Data	26
Command History	39
Laser Monitor Board, Temperature Controller Module, Motor Control System & High Voltage Power Supply Housekeeping Telemetry	20
PDU Housekeeping Telemetry	21
Housekeeping Temperatures #1 Telemetry	22
Housekeeping Temperatures #2 Telemetry	23

Table 1-1 GLAS Telemetry Packets (Continued)

Packet Name	APID
Small Software #1 Telemetry	24
Small Software #2 Telemetry	50
Large Software Telemetry #1	25
Large Software Telemetry #2	55
DSP Code Memory Dump	31
DSP Data Memory Dump	32
C&T Dwell	33
Memory Dwell #1	27
Memory Dwell #2	28
Event Message	34
Memory Dump	35
Table Dump	36
Etalon Calibration	37
Boresight Calibration	38

The Level 1A Data Products produced by the algorithms described in this document are listed in Table 1-2 "The GLAS Level 1A Data Products". The Level 1A Data Products contents and format are defined in the *Level 1A Data Product Specification*; listed in the Bibliography in Section 5. Prior to storage in the Level 1A products the Level 1A data in engineering units are scaled to integer. The scale factors are defined in this document. The Level 0 and Level 1A detailed descriptions are not repeated in this document.

Table 1-2 The GLAS Level 1A Data Products

Product ID and Name	Description
GLA01 - Altimetry Data Product	Contains the waveforms and the altimeter and timing data required to produce higher level range and elevation products.
GLA02 - Atmosphere Data Product	Contains the normalized backscatter, photon counter, cloud digitizer, timing, and location data required to produce the higher level atmosphere data products.
GLA03 - Engineering Data Product	Contains the GLAS instrument's engineering and housekeeping data.
GLA04 - SRS and GPS Data Product	Contains the Global Positioning System data, Stellar Reference System data, and other instrument and spacecraft position and attitude data required to produce the precision orbit and precision attitude data.

Algorithm Description

2.1 Level 0 to Level 1A Conversions

Generally, each measurement in an APID will have a calibration equation determined during GLAS system testing that will be used to convert the measured counts into engineering units. The conversions of the counts to engineering units will be one or more of several types: straight polynomial conversion based on the measurement counts; multi-variable conversions with dependence on additional measurements such as temperature; special conversions based on a complex dependence of several measurements, interpretation of data, table look-up, and geophysical based conversions. Some data will not require conversion and will be retained in counts. The Stellar Reference System (SRS) attitude and position data and the GPS data will be from standard existing systems similar to those used on other spacecraft. The SRS and GPS data along with the laser pointing monitor data will be packaged into the GLA04 data product and provided to the GLAS Science Team. This document will specify the algorithms that process the GLAS altimeter, lidar and housekeeping level 0 packets and the position and attitude data. Appendix B contains tables listing the GLAS instrument telemetry.

2.1.1 Polynomial Expansion Conversions

Most of the GLAS data will be converted by simple polynomial equations of fifth degree or less. Temperature, voltage, and current telemetry data are in this category.

The form for the conversion will be

$$A*(X**5) + B*(X**4) + C*(X**3) + D*(X**2) + E*(X) + F$$

where X is the raw measured value and A, B, C, D, E and F are constant coefficients.

The polynomial conversion factors for the telemetry data are defined in Appendix A. The table lists the telemetry data that is converted through polynomial expansion, the source APID, the conversion factors, and the resulting units.

2.1.2 Multi-variable Conversions

Multi-variable conversions will primarily be used to apply instrument temperature and voltage corrections to data. Below is a generic example of this type of correction.

$$X_{eu} = X_{ct} * (A * (T1)**2 + B * (T1)) + C$$

where

X_{eu} = The telemetry value in engineering units

X_{ct} = The raw telemetry value in counts

T1 = telemetry value upon which X_{ct} is dependent

A, B, C = conversion coefficients

Some measurements may require more than one such type correction or are dependent on more than one temperature or other telemetry value.

For the PDU housekeeping data, the engineering unit conversions are dependent upon monitor calibration values that are telemetered within the PDU packet (APID=21). The conversion for the monitor calibration values and the conversion for the telemetry based on these values is contained in Appendix A, Section A.2.

2.1.3 Special Conversions

There are some conversions that will require special forms based on the analysis of instrument test data or simulations.

2.1.3.1 Bit Interpretation

The interpretation of flags and status words does not usually depend on conversion factors or biases. It is usually a matter of evaluating bits or bit patterns. Appendix A defines those telemetry values which require interpretation and explains how the values are to be interpreted.

2.1.3.1.1 Instrument State Flag

This flag describes the hardware state of the instrument. It describes which of the instrument's redundant systems is operating. The flag is stored in the data product headers and it is composed from the bit interpretation of several telemetered status words. The detailed description including source information is in Appendix A.24.

2.1.3.2 1064 nm Transmitted and Received Pulse Energy

To calculate the 1064 nm transmitted and received pulse energies, the telemetry data for the transmitted and received waveforms is inspected. For each, from the peak location, the waveform is searched (in both directions) until reaching 3% or less of the peak value. The waveform data between the two points is summed. The pulse energies are the product of the sum of the waveform data and a calibration constant. For now, the constant is set to 1.0.

2.1.3.3 Background Mean and Standard Deviation for all Filters

The background mean and standard deviation for the 4 nanosecond (ns) filter are given in telemetry.

The background mean for the other five filters (8 ns, 16 ns, 32 ns, 64 ns, 128 ns) equals the mean for the 4 ns filter. The standard deviation for each of the other filters is computed as shown in the following equation:

$$\begin{aligned} \text{standard deviation for filter } i = \\ \text{standard deviation for filter } (i-1) / (\text{square root } (2)) \text{ for } (i=2,3,4,5,6) \end{aligned}$$

where $i=1$ is the 4ns filter whose mean and standard deviation is downlinked, $i=2$ is the 8ns filter, etc.

2.1.3.4 Table Look-up

Some conversions will be table lookup, based on single or multiple parameters. On past projects it was found that for multiple single byte telemetry values requiring the same conversion factors (temperatures, for example) it was more efficient to use a lookup table to obtain the engineering unit value based on the telemetry counts rather than executing the equation. Table

lookup will be implemented for the conversion of one byte telemetry values to engineering units, when that conversion is by polynomial expansion.

2.1.3.5 L1A Time Tagging

The L1A time tagging algorithm computes the exact UTC time for each laser shot and the UTC time for all associated data in order to process the GLAS data into L1A granules. See the report, *ICESat Observatory Timing and Event Time Reconstruction*, which is listed in the Bibliography in Section 5 for a description of the timing scheme used by the ICESat observatory. This report discusses how the precise times of events on the observatory can be reconstructed from the downlinked telemetry.

The time tagging algorithm requirements are listed in this section. The algorithm specification is contained in Appendix A. Background information for the data alignment and time tagging algorithm are contained in Appendix C.

Algorithm Requirements - General

- 1) GPS time is to be used as the prime time reference. If GPS is not available spacecraft time as determined from the spacecraft vehicle time code word (BVTCW) shall be used as the time reference.
- 2) The shot time (time of altimeter digitizer bin one (or zero)) in UTC is computed from the Fire Command Time in the ancillary science packet. The UTC time tag for each shot shall be computed by referencing its fire command time word to GPS or spacecraft time.
- 3) Oscillator frequency offsets and drift between various subsystems will be properly handled.
- 4) If the ancillary science packet is missing but other packets are present the expected, i.e. predicted, time tag will be assigned to those shots.
- 5) Time computed for an Expedited Data Set (EDS) will be the same for that data on its Production Data Set (PDS).
- 6) Alignment must be made to the SRS (LRS, IST, Gyro) data by assigning proper shot number and shot time.
- 7) Shot and data UTC times will be computed from the reference time that occurs prior to the time of the data, e.g. times will not be backwards interpolated.

Algorithm Requirements - GPS is available

- 8) GPS can reset and must be handled properly. It takes 10 minutes to recover and provide new position data. During this period the GPS does not provide the once per 10 second pulse, so there is no updated GPS reference time. The previous GPS reference time should be used. This condition can span across PDSs.
- 9) A record must be kept relating the GPS time used to every time computed.
- 10) Leapseconds shall be added to the GPS Time to get UTC. The leapseconds correction will be stored in a GPS to UTC Leapseconds file.

- 11) A constant shall be defined that is the GPS time of midnight January 1, 2000 (the UTC reference time). This constant will be negative because it used to remove from the laser shot GPS time the amount of GPS time occurring from the GPS time reference time (January 6, 1980) to the UTC reference time.

Algorithm Requirements - GPS is not available

- 12) Spacecraft time in UTC (as computed from BVTCW) will be used as the reference time if GPS is not available.
- 13) The time tagging algorithm will not automatically switch to the BVTCW time reference upon detection of missing GPS.
- 14) The BVTCW of the 10 Hz LRS Data shall be aligned to the correct shot and its fire command time. The 10 Hz shot time shall then be computed based on the UTC of the BVTCW. The 40 Hz shot times and any other data times can be interpolated from the 10 Hz UTC BVTCW shot times.

2.1.3.6 GPS Black Jack to RINEX Format Conversion

A program will be provided from the GLAS Science Team that will convert the downlinked GPS data from the Black Jack format to the RINEX format. The RINEX is a standard ASCII format for the GPS data and is described at the following website: <ftp://igsb.jpl.nasa.gov/igsb/data/format/rinex2.txt>. The GPS data is stored in the GLA04 Data Product.

2.1.3.7 Position and Attitude Telemetry Data Storage in GLA04

The position and attitude data will be telemetered in a spacecraft packet known as the Position, Rate, and Attitude Packet (PRAP). The position and attitude data is collected from the following systems on-board the spacecraft:

- spacecraft star tracker (2), also known as Ball Star Tracker 1 (BST1) and Ball Star Tracker 2 (BST2),
- instrument star tracker (IST),
- gyro, also known as the IRU, and
- Laser Reference System (LRS).

The Laser Profiling Array (LPA) data will be telemetered via the instrument. The data from each system will be stored in a separate file in the GLA04 product. The PRAP data conversions are defined in the *Data Interface Control Document between the ICESat Spacecraft and the EOS Ground System (EGS)*, referenced in Section 5, the Bibliography.

2.1.4 Geophysical Conversions

Conversions for the Photon Counter and Cloud Digitizer LIDAR data and backgrounds are found in the *GLAS Atmospheric Data Products ATBD*, referenced in Section 5.

2.1.5 Laser Energy Calculation

The GLAS instrument does not monitor or report the GLAS 1064nm transmitted or received energy. Through ground testing, an algorithm was developed to compute the energy during post-processing of the science data. The energy equation is

$$\text{laser_energy}(i) = (\text{delta_T} * \text{area_txp}(i)) / (\text{n_circuit} * \text{n_optical_new} * \text{r_detector} * \text{gain_norm} * \text{a_cal})$$

where

i = current shot

$\text{delta_T} = 1.0\text{E-}09$

$\text{n_circuit} = 0.923$

$\text{n_optical_new} = x(\text{depending on laser})$

2.9650E-14 (LASER 1)

2.7868E-14 (LASER 2)

2.7937E-14 (LASER 3)

$\text{r_detector} = 2.28\text{E+}07$

gain = transmitted gain (from telemetry)

$\text{gain_normal} = \text{gain} / 255\text{D}0$

gain_adj (for laser 1) = 1.0 (was not used)

gain_adj (for laser 2) = $-2.5616417\text{E-}08 * \text{gain}^3 + 1.1939701\text{E-}05 * \text{gain}^2 - 2.2665959\text{E-}03 * \text{gain} + 1.0746249\text{E+}00$

gain_adj (for laser 3) = $-4.0666979\text{D-}08 * \text{gain}^3 + 1.8456647\text{D-}05 * \text{gain}^2 - 3.0427996\text{D-}03 * \text{gain} + 1.096532\text{D}00$

$\text{a_cal} = 1.12$

To compute $\text{area_txp}(i)$ (area under the transmit waveform for each shot):

1. Convert the counts (txwf_count) in each bin (47 bins) to volts (txwf_volt):

IF ($\text{txwf_count} \text{ LE } 127$) THEN

$\text{txwf_volt} = \text{a1} * \text{txwf_count} + \text{b1}$

ELSE $\text{txwf_volt} = \text{a2} * \text{txwf_count} + \text{b2}$

where:

$\text{a1} = 0.006675$

$\text{b1} = -0.1953$

$\text{a2} = 0.006198$

$\text{b2} = -0.1344$

2. Compute the mean (mean_txp) of the first 9 bins of the waveform.

3. Compute the area as the sum of all bins after subtracting the mean from each bin:

$\text{area_txp}(i) = \text{TOTAL}(\text{txwf_volt}(i, 1:47) - \text{mean_txp})$

Detailed discussion of the laser energy calibration and gain correction is contained in Appendix E.

2.2 Quality Assurance

This section shall describe the quality assurance data for the Level 1A granules.

2.2.1 Altimetry Product (GLA01)

- 1) Expected number of Ancillary Science packets (APID 19) based on time span of data.
- 2) Actual number of Ancillary Science packets based on number read.
- 3) Percentage missing Ancillary Science packets: $[1 - (\text{item 2} / \text{item 1})] * 100$.
- 4) Expected number of waveform packets (APIDs 12 and 13) based on time span of data.
- 5) Actual number of waveform packets based on number read.
- 6) Percentage missing waveform packets: $[1 - (\text{item 5} / \text{item 4})] * 100$.
- 7) Percentage of total actual waveform packets that is:
 - long waveform data (based on number of APID 12 packets read),
 - short waveform data (based on number of APID 13 packets read),
 - no signal acquired (from threshold crossing flag in APID 12) for long waveform data,
 - no signal acquired (from threshold crossing flag in APID 13) for short waveform data,
- 8) Granule statistics (Maximum, Minimum, Average, Standard Deviation, Number of Points) for:
 - transmit peak location,
 - difference between last and next to last threshold crossing locations of the received waveform,
 - background mean for 4 ns filter,
 - background standard deviation for each filter,
 - 4 ns filter peak value,
 - peak value for each filter (based on when filters are selected by on-board algorithm),
 - 1064 nm laser transmit energy,
 - 1064 nm laser received energy,
 - time between each shot, and

- A/D receiver gain setting.
- 9) Once per 16 second statistics (Maximum, Minimum, Average) for:
 - 1064 nm laser transmit energy,
 - 1064 nm laser received energy,
 - peak value for selected filter, and
 - difference between last and next to last threshold crossing locations of the received waveform.
 - 10) Track the number of times each filter is selected for long waveform data (where signal is detected) over the period of the granule.
 - 11) Track the number of times each filter is selected for short waveform data (where signal is detected) over the period of the granule.
 - 12) Compute the average filter number and average surface type over 16 seconds (it can be a fraction) over the time of the granule. Set a flag indicating during the 16 seconds, whether the waveform type is predominately long or short.

2.2.2 Atmosphere Product (GLA02)

- 1) Expected number of photon counter packets (APID 15)
- 2) Actual number of photon counter packets (APID 15)
- 3) Percentage missing photon counter packets (APID 15)
- 4) Expected number of cloud digitizer packets (APID 17)
- 5) Actual number of cloud digitizer packets (APID 17)
- 6) Percentage missing cloud digitizer packets (APID 17)
- 7) Expected number of ancillary science packets (APID 19)
- 8) Actual number of ancillary science packets (APID 19)
- 9) Percentage missing ancillary science packets (APID 19)
- 10) Percentage saturated bins for 10 to -1 km profile
- 11) Percentage saturated bins for 20 to 10 km profile
- 12) Percentage saturated bins for 40 to 20 km profile
- 13) Granule statistics (Maximum, Minimum, Average, Number of Points) for:
 - 532 nm laser transmit energy at 40 Hz,
 - 1064 nm laser transmit energy at 40 Hz,
 - 532 nm Backgrounds (4) at 40 Hz,
 - 1064 nm Backgrounds (4) at 40 Hz,
 - Cloud Return Peak Signal,
 - Ground Return Peak Signal,

- Ground Return Peak location, and
 - Dual Pin A / 532 transmit energy at 40 Hz.
- 14) Average 532 integrated return over 16 seconds.
 - 15) Number of 532 laser transmit energy values at 40 Hz from 0 to 10 mJ
 - 16) Number of 532 laser transmit energy values at 40 Hz from 10 to 20 mJ
 - 17) Number of 532 laser transmit energy values at 40 Hz from 20 to 30 mJ
 - 18) Number of 532 laser transmit energy values at 40 Hz from 30 to 40 mJ
 - 19) Number of 532 laser transmit energy values at 40 Hz from above 40 mJ
 - 20) Number of 1064 laser transmit energy values at 40 Hz from 0 to 10 mJ
 - 21) Number of 1064 laser transmit energy values at 40 Hz from 10 to 20 mJ
 - 22) Number of 1064 laser transmit energy values at 40 Hz from 20 to 30 mJ
 - 23) Number of 1064 laser transmit energy values at 40 Hz from 30 to 40 mJ
 - 24) Number of 1064 laser transmit energy values at 40 Hz from above 40 mJ

2.2.3 Engineering Data Product (GLA03)

- 1) Expected number of records per APID (for all APIDs) based on time.
- 2) Actual number of records per APID based on number read for each APID.
- 3) Percentage missing data per APID: $[1 - (\text{item 2} / \text{item 1})] * 100$.
- 4) Change in instrument configuration and time of change.
- 5) Final instrument configuration.
- 6) Granule statistics (Maximum, Minimum, Average, Standard Deviation, Number of points, Number of Times Out of Limits) for each temperature, voltage, and current.
- 7) Once per hour (3600 seconds) statistics (Maximum, Minimum, Average, Standard Deviation, Number of Points) for each temperature, voltage and current.
- 8) For each status indicator over the granule, compute number of times status changed, and final status.
- 9) Granule statistics (Maximum, Minimum, Average, Standard Deviation, Number of Points) for:
 - the difference between the laser fire command time and the laser fire acknowledge time,
 - the difference between the spacecraft time (BVTWC) of the spacecraft time and position packet and the GLAS MET of the spacecraft time and position packet,
 - sum of Post-Delay pulse waveform bin values (32 bins); average and standard deviation only,
 - the peak of the Post-Delay Laser pulse,

- the pulse width of the Post-Delay Laser pulse,
- the peak of the four OTS laser pulse, and
- the pulse width of the four OTS laser pulses.

10) Etalon tuning QA - TBD

2.2.4 Global Stellar Reference and Global Positioning System Data Product (GLA04)

- 1) Expected number of records of LPA data (APID 26) based on time.
- 2) Actual number of records of LPA data based on number read.
- 3) Percentage missing LPA data: $[1 - (\text{item 2} / \text{item 1})] * 100$.
- 4) Expected number of records of PRAP data (APID 1984) based on time.
- 5) Actual number of records of PRAP data based on number read.
- 6) Percentage missing PRAP data: $[1 - (\text{item 5} / \text{item 4})] * 100$.
- 7) For the LPA data, store the following data to arrays:
 - Computed centroid location statistics over 60 seconds (Maximum, Minimum, Average, Number of Points).
 - Area above noise of Transmit waveform statistics over 60 seconds (Maximum, Minimum, Average, Number of Points). Noise = 30 counts; area is equivalent to sum of data from each bin (48) where data is greater than 30 counts. Note: Subtract off the 30 counts of noise prior to summing the data.
 - Time of Transmit waveform peak statistics over 60 seconds (Maximum, Minimum, Average, Number of Points).
 - Sample time: time of first shot in the first and last frames included in the average. These will be the only times stored in the along-track record.
- 8) For the LPA data for each granule, store:
 - First and last LPA 20x20 image.
 - Mean and standard deviation of the LPA 20x20 image.
- 9) For the first valid star for each virtual tracker in the LRS data, store the following data to arrays:
 - Encircled energy statistics over 60 seconds (Maximum, Minimum, Average, Number of Points).
 - Background bias statistics over 60 seconds (Maximum, Minimum, Average, Number of Points).
 - Centroid row statistics over 60 seconds (Maximum, Minimum, Average, Number of Points).
 - Centroid column statistics over 60 seconds (Maximum, Minimum, Average, Number of Points).

-
- Sample time: time of first shot in the first and last frames included in the average. These will be the only times stored in the along-track record.
- 10) First and last valid LRS laser images of the granule with the start and end times of the record in which they occur.
 - 11) For the LRS data, collect once per granule data for:
 - Number of points processed
 - Number of shot numbers that are zero
 - Number of messages incomplete
 - Number of time tag rollovers
 - Number of valid and invalid stars by tracker: star, laser, and CRS.
 - Number of stars by star tracker by magnitude from 0 to 6.3 with .5 magnitude categories.
 - For each valid virtual tracker for the laser and CRS (Maximum, Minimum, Mean, Standard Deviation, and Number of Points): Encircled energy, Background bias, Centroid row, and Centroid column
 - CCD temperature (Minimum, Maximum, Mean, Standard Deviation, and Number of Points)
 - Lens Cell temperature (Minimum, Maximum, Mean, Standard Deviation, and Number of Points)
 - 12) Once per 60 seconds statistics (Maximum, Minimum, Mean, Standard Deviation, Number of points) on each valid Gyro's (A, B, C, D) integrated angle data. Also report the number of invalid integrated angles for each Gyro.
 - 13) For the first valid star for each virtual tracker in the Instrument Star Tracker (IST) data, store the following data to arrays at 60 second intervals:
 - Sample time
 - Encircled energy
 - Background bias
 - Star magnitude
 - Boresight H
 - Boresight V
 - 14) For the Instrument Star Tracker (IST) data, collect the once per granule data for:
 - Number of points processed
 - Number of shot numbers that are zero
 - Number of messages incomplete
 - Number of time tag rollovers

- Number of valid and invalid stars by tracker: star, laser, and CRS.
 - Number of stars by magnitude from 0 to 6.3 with .5 magnitude categories.
 - CCD temperature (Minimum, Maximum, Mean)
 - Lens Cell temperature (Minimum, Maximum, Mean)
- 15) For the first valid star for each virtual tracker in the Ball Star Tracker (BST) data (two BSTs), store the following data to arrays at 60 second intervals:
- Sample time
 - Star position X and Y
 - Star intensity
- 16) For both BSTs, collect once per granule data of:
- Number of points processed
 - Number of commands received and rejected
 - For each tracker, the number of stars by magnitude from 0 to 6.3 with .5 magnitude categories.
 - CCD temperature (Minimum, Maximum, Mean)
 - Lens Cell temperature (Minimum, Maximum, Mean)
 - +8 Volt supply voltage (Minimum, Maximum, Mean)
 - Background reading (Minimum, Maximum, Mean)
- 17) For the spacecraft data, for the first valid point, store the following data to arrays at 60 second intervals:
- Sample time
 - Solar array 1 position
 - Solar array 2 position
 - Solar Array 1 autonomous flag
 - Solar Array 2 autonomous flag
 - Quaternions 1 through 4
- 18) For the spacecraft data, compute for the granule:
- Number of times solar array 1 is in fixed position and total time in fixed position
 - Number of times solar array 2 is in fixed position and total time in fixed position
 - Number of times solar arrays are in fixed position simultaneously and total time in fixed position
 - Number of times GPS time changes

2.3 Browse Products

This section defines the browse products for the Level 1A granules.

2.3.1 Altimetry Product (GLA01)

- 1) Table (for the granule) showing:
 - percent missing waveform packets,
 - percent missing ancillary science packets,
 - percent data is long waveform data,
 - percent data is short waveform data,
 - percent of long waveform data where no signal was acquired, and
 - percent of short waveform data where no signal was acquired.
- 2) Statistics table (for the granule) which includes the Maximum, Minimum, Average, Standard Deviation, and Number of Points for:
 - transmit peak location,
 - sum of transmit waveform bins (average and standard deviation only),
 - difference between last and next to last threshold crossing locations,
 - background mean for 4 ns filter,
 - background standard deviation for each filter,
 - 4 ns filter peak value,
 - peak value for each filter (based on when filters are selected by on-board algorithm),
 - 1064 nm laser transmit energy,
 - 1064 nm laser received energy,
 - time between each shot, and
 - A/D receiver gain setting.
- 3) Color coded plot of the ground track, with colors indicating whether the flight algorithms selected long or short waveforms for a location,
- 4) Histogram of 1064 nm laser transmit energy averaged n per second,
- 5) Histogram of 1064 nm laser received energy averaged n per second,
- 6) Histogram of the received waveform average peak value per selected filter per second,
- 7) Histogram of the difference between last and next to last threshold crossing locations averaged n per second,
- 8) Color coded plot of the ground track, with colors indicating the average selected filter number for a location,

- 9) Color coded plot of the ground track, with colors indicating the average transmitted and received energy for a location,
- 10) Histogram of the long waveform data selected filter numbers, and
- 11) Histogram of the short waveform data selected filter numbers.

2.3.2 Atmosphere Product (GLA02)

- 1) Table (for the granule) showing:
 - percent missing photon counter packets,
 - percent missing cloud digitizer packets,
 - percent missing ancillary science packets,
 - percentage of saturated bins for the 10 to -1 km profile,
 - percentage of saturated bins for the 20 to 10 km profile, and
 - percentage of saturated bins for the 40 to 20 km profile.
- 2) Statistics table (for the granule) which includes the Maximum, Minimum, Average, and Number of Points for:
 - 532 laser transmit energy at 40 Hz,
 - 1064 laser transmit energy at 40 Hz,
 - 532 backgrounds (4) at 40 Hz,
 - 1064 backgrounds (4) at 40 Hz,
 - cloud return peak signal,
 - ground return peak signal,
 - ground return peak location, and
 - Dual pin A /532 transmit energy at 40 Hz.
- 3) Color coded plot of the ground track, with colors indicating 532 integrated return value for a location
- 4) Histograms of 532 and 1064 transmit energy
 - Number of 532 laser transmit energy values at 40 Hz from 0 to 10 mJ,
 - Number of 532 laser transmit energy values at 40 Hz from 10 to 20 mJ,
 - Number of 532 laser transmit energy values at 40 Hz from 20 to 30 mJ,
 - Number of 532 laser transmit energy values at 40 Hz from 30 to 40 mJ,
 - Number of 532 laser transmit energy values at 40 Hz from above 40 mJ,
 - Number of 1064 laser transmit energy values at 40 Hz from 0 to 10 mJ,
 - Number of 1064 laser transmit energy values at 40 Hz from 10 to 20 mJ,
 - Number of 1064 laser transmit energy values at 40 Hz from 20 to 30 mJ,

- Number of 1064 laser transmit energy values at 40 Hz from 30 to 40 mJ, and
- Number of 1064 laser transmit energy values at 40 Hz from above 40 mJ.

2.3.3 Engineering Data Product (GLA03)

- 1) Plots of average temperatures per hour,
- 2) Plots of average voltages per hour,
- 3) Plots of average currents per hour,
- 4) Table of operating laser, detector, digitizer, oscillator and time instrument configuration changed during granule,
- 5) Table of granule statistics, and
- 6) Etalon tuning - TBD.

2.3.4 Global Stellar Reference and Global Positioning System Data Product (GLA04)

- 1) Table and bar chart (for the granule) showing:
 - Percentage and number missing LPA data.
 - Percentage and number missing PRAP data.
- 2) Statistics table/bar chart (for the granule) which includes:
 - LRS CCD temperature (Minimum, Maximum, Mean)
 - LRS Lens Cell temperature (Minimum, Maximum, Mean)
 - IST CCD temperature (Minimum, Maximum, Mean)
 - IST Lens Cell temperature (Minimum, Maximum, Mean)
 - BST1 and BST2 CCD temperature (Minimum, Maximum, Mean)
 - BST1 and BST2 Lens Cell temperature (Minimum, Maximum, Mean)
 - BST1 and BST2 +8 Volt supply voltage (Minimum, Maximum, Mean)
 - BST1 and BST2 Background reading (Minimum, Maximum, Mean)
 - Mean and standard deviation of the LPA 20x20 images
- 3) Star magnitude histogram for the LRS, IST, BST1, and BST2 indicating for each tracker, the number of stars by magnitude from 0 to 6.3 with .5 magnitude categories.
- 4) First and last laser and LPA images in the granule. The SRS images in the granule cannot be tied unequivocally to a shot or frame number. Instead, the first and last good images in the granule should be labelled with the times of the first and last shots in the frames in which they are found.
- 5) Number of times solar array 1 is in fixed position and total time in fixed position for the granule.

- 6) Number of times solar array 2 is in fixed position and total time in fixed position for the granule.
- 7) Number of times solar arrays are in fixed position simultaneously and total time in fixed position for the granule.
- 8) Number of times GPS time changes for the granule.
- 9) Color coded plots of the granule timeline, with colors indicating when Solar Array 1 autonomous flag is set to auto (1) or off (0).
- 10) Color coded plots of the granule timeline, with colors indicating when Solar Array 2 autonomous flag is set to auto (1) or off (0).
- 11) Histograms of:
 - Computed centroid location
 - Area above noise of Transmit waveform.
 - Time of Transmit waveform peak.

Implementation Considerations

The GLAS data level 1A conversion does not require any complicated or interactive processing. The data rate is 500 kbps.

3.1 Standards

The GLAS Level 1A algorithm implementation will follow the software development process defined in the *GLAS Science Software Management Plan* listed in Section 5.

3.2 Ancillary Inputs

3.2.1 Predict (Operational) orbit

The best available orbit predicts will be used to append location to the level 1 A data. No corrections will be applied to the data based on the predicted location data. This position data will be replaced on higher level products with the precision orbit data. The predicted location will be used to help with the QA and any quick look analysis of the GLAS data.

3.2.2 GLAS Coefficients and Constants File

Provides the coefficients and constants that are subject to modification based on: pre-flight testing, on-orbit performance, or electronic component aging. To avoid creating and delivering new versions of software due to changes in operating parameters, the GLAS Coefficients and Constants File provides a location to store those software parameters.

Include in the GLAS Coefficients and Constants File, the QA statistical sampling rate in seconds for each L1A product. Therefore, if the sampling rates are modified, the L1A Code will not have to be changed. A CR will be written to update this ATBD and the value(s) in the GLAS Coefficients and Constants File.

3.3 Accuracy

All level 1A data conversions will be designed to meet the accuracy of the science requirements. Where the capability to invert from the level 1A data back to the level 0 raw counts is needed, there will not be any loss of accuracy. GLAS measurement capabilities will not be degraded during the creation of the level 1A product.

3.4 Computational: CPU and Disk Storage

GLAS level 1A processing can be done easily within the capabilities of a large workstation. A processing load has been estimated by using the TOPEX Radar Altimeter SDR processing resources and scaling them by the ratio of the data rate. This is considered to be a worst case analysis. Disk storage space has been estimated based on the design of the level 1A data product.

3.5 Software Validation

The validation of the software will be from processing known data from the GLAS instrument testing or the GLAS simulator into a level 1 A product. This product will be compared to the GLAS Instrument team results from ground testing or simulator outputs.

QA processes to automatically provide data product quality information are defined in Section 2.

Constraints, Limitations, and Assumptions

4.1 Constraints and Limitations

The following is a list of the constraints and limitations that will exist on this algorithm.

- 1) The GLAS level 1A data products should be ready within 24 hours of the availability of the level 0.
- 2) The implementation of this algorithm will follow the software development life cycle described in the *GLAS Science Software Management Plan*, listed in the Bibliography in Section 6.
- 3) The Engineering Data Product (GLA03) should be produced first since data on that product may be used to further correct or calibrate the altimeter or lidar data.

4.2 Assumptions

The following are assumptions made for the definition, development and use of this algorithm.

- 1) Level 0 data will be time ordered and contain no duplicate data.
- 2) GLAS instrument data will be within the ground tested limits for the data to be valid. However, checks will be made on the data and flags set indicating data anomalies.

Section 5

Bibliography

- 1) *GLAS Level 0 Instrument Data product Specification*, Version 2.2, March 1998, NASA Goddard Space Flight Center, Wallops Flight Facility.
- 2) *GLAS Standard Data Products Specification - Level 1*, Version 2.0, December 1998, NASA Goddard Space Flight Center, Wallops Flight Facility.
- 3) *GLAS Science Software Management Plan*, Version 3.0, August 1998, NASA Goddard Space Flight Center, Wallops Flight Facility.
- 4) *GLAS Science Data Management Plan (GLAS SDMP)*, Version 4.0, June 1999, NASA Goddard Space Flight Center Wallops Flight Facility, GLAS-DMP-1200.
- 5) *NASA Earth Observing System Geoscience Laser Altimeter System GLAS Science Requirements Document*, Version 2.01, October 1997, Center for Space Research, University of Texas at Austin.
- 6) *GLAS Atmospheric Data Products ATBD*, Version 3.0, July 1999, NASA Goddard Space Flight Center.
- 7) *ICESat Observatory Timing and Event Time Reconstruction*, Rev. G, February 2001
- 8) *I-SIPS Version 2 Delivery Package*, TBD
- 9) *Data Interface Control Document between the ICESat Spacecraft and the EOS Ground System (EGS)*, TBD

Appendix A

Conversion Tables

A.1 Conversion Description for Each APID

Table A-1 "Conversion Description for GLAS Telemetry Data" lists each telemetry value for all the GLAS APIDs, the conversion type, the conversion description, resulting units, and destination L1A product ID. The conversion type can be

- Interpretation (I)- Evaluates the values of a bit or bits in a telemetry word to determine the value. All flags and status words are assumed to be converted in this manner. The description of the bit values is in the Conversion Description column;
- Polynomial (P)- A polynomial equation for the conversion from raw counts to engineering units. The polynomial equation looks like:
$$Y = A + B*(X) + C*(X**2) + \dots$$
where
Y is the resulting instrument value in engineering units
X is the raw instrument value in counts
and A, B, C,... are the polynomial coefficients.

In the tables the coefficients are listed in the order A, B, C... in the Coefficient Description column;

- Multi-variable (M) - the conversion for a raw telemetry value requires additional telemetry values (raw or in engineering units), such as temperatures or voltages. Depending on the complexity of the algorithm, the Conversion Description column will include the algorithm or will reference another section containing the algorithm;
- Table-lookup (T) - Using the raw counts as an index to a table, the converted value is obtained;
- Geophysical (G) -;
- None (N) - No conversion is required; and
- Unknown (U) - the conversion algorithm is currently unknown or not documented.

A.2 Telemetry Pseudo Engineering Unit Conversion

Table A-1 Conversion Description for GLAS Telemetry Data

APID	Name	Conv. Type	Conversion Description	Units	LIA Product ID
ALL	Primary Header	I			GLA03
ALL	Secondary Header (time stamp)	U			GLA03
20	LMB Laser 1 Reference Temperature	P	-33.84,5.368E-1, -1.622E-5,3.155E-6	Deg C	GLA03
20	Laser 1 Doubler Temperature	P	20.84,1.032E-1, -2.879E-5,1.446E-7	Deg C	GLA03
20	Laser 1 Oscillator Temperature	P	20.84,1.032E-1, -2.879E-5,1.446E-7	Deg C	GLA03
20	Laser 1 Electronics Temperature (MEU)	P	-33.84,5.368E-1, -1.622E-5,3.155E-6	Deg C	GLA03
20	LMB Laser 2 Reference Temperature	P	-33.84,5.368E-1, -1.622E-5,3.155E-6	Deg C	GLA03
20	Laser 2 Doubler Temperature	P	20.84,1.032E-1, -2.879E-5,1.446E-7	Deg C	GLA03
20	Laser 2 Oscillator Temperature	P	20.84,1.032E-1, -2.879E-5,1.446E-7	Deg C	GLA03
20	Laser 2 Electronics Temperature (MEU)	P	-33.84,5.368E-1, -1.622E-5,3.155E-6	Deg C	GLA03
20	LMB Laser 3 Reference Temperature	P	-33.84,5.368E-1, -1.622E-5,3.155E-6	Deg C	GLA03
20	Laser 3 Doubler Temperature	P	20.84,1.032E-1, -2.879E-5,1.446E-7	Deg C	GLA03
20	Laser 3 Oscillator Temperature	P	20.84,1.032E-1, -2.879E-5,1.446E-7	Deg C	GLA03
20	Laser 3 Electronics Temperature (MEU)	P	-33.84,5.368E-1, -1.622E-5,3.155E-6	Deg C	GLA03
20	Laser Osc Current	M	$1.898 + 0.4878 * (\text{Laser Osc Current counts}) - 1.406E-2 * (\text{Laser Monitor Board Temperature counts})$	Amps	GLA03
20	Laser Amp Current	M	$2.062 + 0.4865 * (\text{Laser Amp Current counts}) - 1.406E-2 * (\text{Laser Monitor Board Temperature counts})$	Amps	GLA03
20	Laser Dr Pulse Width	P	131.08,0.512	pulse width in usec	GLA03

Table A-1 Conversion Description for GLAS Telemetry Data (Continued)

APID	Name	Conv. Type	Conversion Description	Units	L1A Product ID
50	OTS Level 1 readback	P	40, -0.15625	micro Amps	GLA03
50	OTS Level 2 readback	P	40, -0.15625	micro Amps	GLA03
50	OTS Level 3 readback	P	40, -0.15625	micro Amps	GLA03
50	OTS Level 4 readback	P	40, -0.15625	micro Amps	GLA03
50	OTS Trigger Count 1 readback	P	0.0,0.256	micro-seconds	GLA03
50	OTS Trigger Count 2 readback	P	0.0,0.256	micro-seconds	GLA03
20	AD Detector Outgoing Gain readback	P	-1, 0.0078125	Volts	GLA03
20	AD Detector Return Gain readback	P	-1, 0.0078125	Volts	GLA03
20	Laser and OTS Enable readbacks	I	See Section A.3	n/a	GLA03
20	Dual Pin A	M	$0.5609 + 0.3823 * (\text{Dual Pin A counts}) + 3.848E-5 * (\text{Dual Pin A counts}^2) - 5.737E-3 * (\text{Laser Monitor Board Temperature counts})$	%	GLA03
20	Dual Pin B	M	$1.108 + 0.4143 * (\text{Dual Pin B counts}) - 8.671E-5 * (\text{Dual Pin B counts}^2) - 1.159E-3 * (\text{Laser Monitor Board Temperature counts})$	%	GLA03
20	532 Energy	M	$-0.969 + 0.4095 * (\text{532 Energy counts}) - 6.601E-5 * (\text{532 Energy counts}^2) + 8.765E-3 * (\text{Laser Monitor Board Temperature counts})$	%	GLA03
20	Primary Altimeter Detector 550 V	P	0.0, 3.581	Volts	GLA03
20	Secondary Altimeter Detector 550 V	P	0.0, 3.581	Volts	GLA03
20	SPCM Detector #1 550 V	P	0.0, 3.581	Volts	GLA03
20	SPCM Detector #2 550 V	P	0.0, 3.581	Volts	GLA03
20	SPCM Detector #3 550 V	P	0.0, 3.581	Volts	GLA03
20	SPCM Detector #4 550 V	P	0.0, 3.581	Volts	GLA03
20	SPCM Detector #5 550 V	P	0.0, 3.581	Volts	GLA03
20	SPCM Detector #6 550 V	P	0.0, 3.581	Volts	GLA03

Table A-1 Conversion Description for GLAS Telemetry Data (Continued)

APID	Name	Conv. Type	Conversion Description	Units	L1A Product ID
20	SPCM Detector #7 550 V	P	0.0, 3.581	Volts	GLA03
20	SPCM Detector #8 550 V	P	0.0, 3.581	Volts	GLA03
20	Internal Temp #1	P	- 50.0, 0.781	Deg C	GLA03
20	C&T Positive Rail	P	9.0, 0.031	Volts	GLA03
20	Internal Temp #3	P	-50.0, 0.781	Deg C	GLA03
20	VC Motor Current	P	-100.0, 0.048828125	mAmps	GLA03
20	VC Motor Current	P	-100.0, 0.048828125	mAmps	GLA03
20	X Position	P	-10.0, 0.0048828125	Volts	GLA03
20	Y Position	P	-10.0, 0.0048828125	Volts	GLA03
21	Primary Monitor Calibration, Upper Byte	M	Pseudo Telemetry Eqn 7		GLA03
21	Primary Monitor Calibration, Lower Byte	M	Pseudo Telemetry Eqn 7/8		GLA03
21	+28V Bus A Instrument Voltage	M	Pseudo Telemetry Eqn 9	Volts	GLA03
21	Hybrid Supplies Current	M	Pseudo Telemetry Eqn 10	Amps	GLA03
21	HVPS Detector Supplies Current	M	Pseudo Telemetry Eqn 11	Amps	GLA03
21	Operational Heaters Current	M	Pseudo Telemetry Eqn 12	Amps	GLA03
21	Mechanical System Current	M	Pseudo Telemetry Eqn 13	Amps	GLA03
21	+28V Bus B Laser 1 Voltage	M	Pseudo Telemetry Eqn 14	Volts	GLA03
21	+28V Bus B Laser 1 Current	M	Pseudo Telemetry Eqn 15	Amps	GLA03
21	+28V Bus C Laser 2 Voltage	M	Pseudo Telemetry Eqn 16	Volts	GLA03
21	+28V Bus C Laser 2 Current	M	Pseudo Telemetry Eqn 17	Amps	GLA03
21	+28V Bus D Laser 3 Voltage	M	Pseudo Telemetry Eqn 18	Volts	GLA03
21	+28V Bus D Laser 3 Current	M	Pseudo Telemetry Eqn 19	Amps	GLA03
21	Secondary Monitor Calibration, Upper Byte	M	Pseudo Telemetry Eqn 20	n/a	GLA03
21	Secondary Monitor Calibration, Lower Byte	M	Pseudo Telemetry Eqn 20/21	n/a	GLA03
21	+ 5 V Hybrid # 1 Voltage	M	Pseudo Telemetry Eqn 22	Volts	GLA03
21	+ 5 V Hybrid # 1 Current	M	Pseudo Telemetry Eqn 23	Amps	GLA03
21	+12 V Hybrid # 2 Voltage	M	Pseudo Telemetry Eqn 24	Volts	GLA03
21	+ 12 V Hybrid # 2 Current	M	Pseudo Telemetry Eqn 25	Amps	GLA03
21	- 12 V Hybrid # 3 Voltage	M	Pseudo Telemetry Eqn 26	Volts	GLA03

Table A-1 Conversion Description for GLAS Telemetry Data (Continued)

APID	Name	Conv. Type	Conversion Description	Units	L1A Product ID
21	- 12 V Hybrid # 3 Current	M	Pseudo Telemetry Eqn 27	Amps	GLA03
21	+ 5 V Hybrid # 4 Voltage	M	Pseudo Telemetry Eqn 28	Volts	GLA03
21	+ 5 V Hybrid # 4 Current	M	Pseudo Telemetry Eqn 29	Amps	GLA03
21	- 5 V Hybrid # 5 Voltage	M	Pseudo Telemetry Eqn 30	Volts	GLA03
21	- 5 V Hybrid # 5 Current	M	Pseudo Telemetry Eqn 31	Amps	GLA03
21	- 5 V Hybrid # 6 Voltage	M	Pseudo Telemetry Eqn 32	Volts	GLA03
21	- 5 V Hybrid # 6 Current	M	Pseudo Telemetry Eqn 33	Amps	GLA03
21	+ 15 V Boost Post Register Voltage	M	Pseudo Telemetry Eqn 34	Volts	GLA03
21	- 15 V Boost Post Register Voltage	M	Pseudo Telemetry Eqn 35	Volts	GLA03
21	+12 V Prim Osc Thermal Control Current	M	Pseudo Telemetry Eqn 36	Amps	GLA03
21	+12 V Sec Osc Thermal Control Current	M	Pseudo Telemetry Eqn 37	Amps	GLA03
21	-2 V Discrete Voltage	M	Pseudo Telemetry Eqn 38	Volts	GLA03
21	Hybrid Heatsink Temperature	M	Pseudo Telemetry Eqn 39	Deg C	GLA03
21	FET Switch Bank Heatsink Temperature	M	Pseudo Telemetry Eqn 40	Deg C	GLA03
21	FET Switch Bank	I	See Section A.4	n/a	GLA03
21	HVPS +0 Volts Reference	P	0.0, 0.026	Volts	GLA03
21	HVPS +5 V Reference	P	0.0, 0.052	Volts	GLA03
21	MCS Mux Counter (4-bits)	N		Counts	GLA03
21	Optical Sensor Status	I	See Section A.5	n/a	GLA03
21	Status Cmd Telemetry	I	See Section A.6	n/a	GLA03
22	Housekeeping Board Temperature	P	-20.4, 0.3984	Deg C	GLA03
22	Instrument Processor System Board Temperature	P	-23.5, 0.3984	Deg C	GLA03
22	Photon Counter Board Temperature	P	-21.6, 0.3984	Deg C	GLA03
22	Cloud Digitizer/Frequency & Time Board Temperature	P	-21.6, 0.3984	Deg C	GLA03
22	Altimeter Digitizer 1 DSP Temperature	P	-21.0, 0.3984	Deg C	GLA03
22	Altimeter Digitizer 2 DSP Temperature	P	-21.0, 0.3984	Deg C	GLA03
22	Data Collection & Handling Board Temp	P	-20.7, 0.3984	Deg C	GLA03
22	Laser Monitor Board Temperature	P	-21.0, 0.3984	Deg C	GLA03

Table A-1 Conversion Description for GLAS Telemetry Data (Continued)

APID	Name	Conv. Type	Conversion Description	Units	L1A Product ID
22	Temperature Controller Monitor Board Temperature	P	-21.0, 0.3984	Deg C	GLA03
22	Oven-crystal-controlled Oscillator (OXCO)1 Board Temperature	P	-21.0, 0.3984	Deg C	GLA03
22	OXCO 2 Board Temperature	P	-21.0, 0.3984	Deg C	GLA03
22	Oscillator Board Temperature	P	-21.0, 0.3984	Deg C	GLA03
22	OTS Board Temperature	P	-21.0, 0.3984	Deg C	GLA03
22	LPA Temperature 1	P	-21.0, 0.3984	Deg C	GLA03
22	LPA Temperature 2	P	-21.0, 0.3984	Deg C	GLA03
22	AD 1 ECLA Temperature	P	-21.0, 0.3984	Deg C	GLA03
22	AD 2 ECLA Temperature	P	-21.0, 0.3984	Deg C	GLA03
22	AD 1 ECLB Temperature	P	-21.0, 0.3984	Deg C	GLA03
22	AD 2 ECLB Temperature	P	-21.0, 0.3984	Deg C	GLA03
22	AD 1 ADC Temperature	P	-21.0, 0.3984	Deg C	GLA03
22	AD 2 ADC Temperature	P	-21.0, 0.3984	Deg C	GLA03
22	SPCM Temperature	P	-18.113, 0.3083	Deg C	GLA03
22	Telescope Mount Temperature	P	-18.113, 0.3083	Deg C	GLA03
22	Telescope Baffle Temperature	P	-18.113, 0.3083	Deg C	GLA03
22	AD 1 Temperature	P	-18.113, 0.3083	Deg C	GLA03
22	AD 2 Temperature	P	-18.113, 0.3083	Deg C	GLA03
22	Face 1 LTR to SRS Temperature	P	-18.113, 0.3083	Deg C	GLA03
22	Face 2 LTR to SRS Temperature	P	-18.113, 0.3083	Deg C	GLA03
22	Fiber Delay Line Temperature	P	-18.113, 0.3083	Deg C	GLA03
22	Fiber Box Temperature	P	-18.113, 0.3083	Deg C	GLA03
22	Face 1 Fold Around Bench Temperature	P	-18.113, 0.3083	Deg C	GLA03
22	Face 2 Fold Around Bench Temperature	P	-18.113, 0.3083	Deg C	GLA03
22	Face 1 LTR CRS Temperature	P	-18.113, 0.3083	Deg C	GLA03
22	Face 2 LTR CRS Temperature	P	-18.113, 0.3083	Deg C	GLA03
22	SRS Parabola Temperature	P	-18.113, 0.3083	Deg C	GLA03
22	PRT Cal Low	P	-18.113, 0.3083	Deg C	GLA03
22	PRT Cal High	P	-18.113, 0.3083	Deg C	GLA03
22	Pin Diode Bias Voltage	P	0,0.2949	Volts	GLA03
22	AD1 High Speed Ram Temperature	P	-21.0, 0.3984	Deg C	GLA03

Table A-1 Conversion Description for GLAS Telemetry Data (Continued)

APID	Name	Conv. Type	Conversion Description	Units	L1A Product ID
22	Spares	N		n/a	GLA03
23	Laser Select Mechanism 1 Temperature	P	-1456.13,0.5664055703	Deg C	GLA03
23	Laser Select Mechanism 2 Temperature	P	-1456.13,0.5664055703	Deg C	GLA03
23	Altimeter Digitizer Select Mechanism Temperature	P	-1456.13,0.5664055703	Deg C	GLA03
23	Laser Beam Select Mechanism Electronics Temperature	P	-1456.13,0.5664055703	Deg C	GLA03
23	Laser Beam Select Mechanism Mirror Temperature	P	-1456.13,0.5664055703	Deg C	GLA03
23	HOP1 Actuator Current - Heater 1	P	-2.0,976.5625E-6	Amps	GLA03
23	HOP1 Actuator Current - Heater 2	P	-2.0,976.5625E-6	Amps	GLA03
23	HOP2 Actuator Current - Heater 1	P	-2.0,976.5625E-6	Amps	GLA03
23	HOP2 Actuator Current - Heater 2	P	-2.0,976.5625E-6	Amps	GLA03
23	HOP3 Actuator Current - Heater 1	P	-2.0,976.5625E-6	Amps	GLA03
23	HOP3 Actuator Current - Heater 2	P	-2.0,976.5625E-6	Amps	GLA03
23	LHP 1 and 2 Heater Status	I	LHP 1 Heater Status, Mask=0x01, 0=Off, 1=On; LHP 2 Heater Status, Mask=0x02, 0=Off, 1=On	n/a	GLA03
23	Telescope Prim Mirror Heater Enable Readback	I	0=Disabled, 0xFF=Enabled	n/a	GLA03
23	Telescope Prim Mirror Heater Temp Setpoint Readback	P	0.1586, 0.1027, -4.253E-05, 3.833E-07	Deg C	GLA03
23	spares	N		n/a	GLA03
23	Telescope Tower Heater Enable Readback	I	0=Disabled, 0xFF=Enabled	n/a	GLA03
23	Telescope Tower Heater Temp Setpoint Readback	P	0.1392, 0.104, -5.962E-05, 4.304E-07	Deg C	GLA03
23	Etalon Heater Enable Readback	I	0=Disabled, 0xFF=Enabled	n/a	GLA03
23	Etalon Heater Temp Setpoint Readback	P	29.27, 0.09251, 9.919E-06, 1.022E-07	Deg C	GLA03
23	LHP 1 Enable Readback	I	0=Disabled, 0xFF=Enabled	n/a	GLA03
23	LHP 1 Temp Setpoint Readback	P	0.02609, 0.1173, -6.871E-05, 2.629E-07	Deg C	GLA03
23	LHP 2 Enable Readback	I	0=Disabled, 0xFF=Enabled	n/a	GLA03

Table A-1 Conversion Description for GLAS Telemetry Data (Continued)

APID	Name	Conv. Type	Conversion Description	Units	L1A Product ID
23	LHP 2 Temp Setpoint Readback	P	-7.696, 0.11, -5.1E-05, 2.007E-07	Deg C	GLA03
23	Thermistor Select - Tscope Prim Mirror - Status Readback	I	0=Thermistor 1, 0xFF=Thermistor 2	n/a	GLA03
23	Thermistor Select - Tscope Sec Mirror - Status Readback	I	0=Thermistor 1, 0xFF=Thermistor 2	n/a	GLA03
23	Thermistor Select Tscope Sec Support Structure Status Readback	I	0=Thermistor 1, 0xFF=Thermistor 2	n/a	GLA03
23	Thermistor Select LHP1(lasers) Status Readback	I	0=Thermistor 1, 0xFF=Thermistor 2	n/a	GLA03
23	Thermistor Select LHP2(rest of instrument) Status Readback	I	0=Thermistor 1, 0xFF=Thermistor 2	n/a	GLA03
23	Thermistor Select Etalon Status Readback	I	0=Thermistor 1, 0xFF=Thermistor 2	n/a	GLA03
23	Spare	N		n/a	GLA03
50	Telescope Primary Mirror Temperature	P	0.1586, 0.1027, -4.253E-05, 3.833E-07	Deg C	GLA03
50	Telescope Secondary Mirror Temperature	P	0.02506,0.1051, -6.469E-05,4.376E-07	Deg C	GLA03
50	Telescope Tower Temperature	P	0.1392, 0.104, -5.962E-05, 4.304E-07	Deg C	GLA03
50	Etalon Temperature	P	29.27, 0.09251, 9.919E-06, 1.022E-07	Deg C	GLA03
50	LHP 1 Temperature	P	0.02609, 0.1173, -6.871E-05, 2.629E-07	Deg C	GLA03
50	LHP 2 Temperature	P	-7.696, 0.11, -5.1E-05, 2.007E-07	Deg C	GLA03
50	Telescope Primary Mirror Heater drive current	P	0.0008, 0.003678	Amps	GLA03
50	Telescope Secondary Mirror Heater drive current	P	0.0008, 0.003113	Amps	GLA03
50	spares	N		n/a	GLA03
50	Etalon Drive Heater Current	P	1.35E-3, 0.003468	Amps	GLA03
50	Delay Line All Temperature	P	-33.84, 0.5368, -1.622E-3, 3.155E-6	Deg C	GLA03
50	Delay Line Mid Temperature	P	-2.406, 0.06459, -7.58E-6, 5.591E-8	Deg C	GLA03

Table A-1 Conversion Description for GLAS Telemetry Data (Continued)

APID	Name	Conv. Type	Conversion Description	Units	L1A Product ID
50	Delay Line Hi Temperature	P	13.33, 0.06518, -5.261E-6, 4.076E-8	Deg C	GLA03
50	Spares	N		n/a	GLA03
24	HS Task Cmd Processed Counter	N		n/a	GLA03
24	HS Task Cmd Rejected (or Error) Counter	N		n/a	GLA03
24	CS Task Cmd Processed Counter	N		n/a	GLA03
24	CS Task Cmd Rejected (or Error) Counter	N		n/a	GLA03
24	TC Task Cmd Processed Counter	N		n/a	GLA03
24	TC Task Cmd Rejected (or Error) Counter	N		n/a	GLA03
24	SB Task Cmd Processed Counter	N		n/a	GLA03
24	SB Task Cmd Rejected (or Error) Counter	N		n/a	GLA03
24	SM Task Cmd Processed Counter	N		n/a	GLA03
24	SM Task Cmd Rejected (or Error) Counter	N		n/a	GLA03
24	RT Task Cmd Processed Counter	N		n/a	GLA03
24	RT Task Cmd Rejected (or Error) Counter	N		n/a	GLA03
24	RT Task RCH3 (SA22-25, CSA 26) Commands Received	N		n/a	GLA03
24	RT Task RCH3 (SA22-25, CSA 26) Commands Rejected	N		n/a	GLA03
24	MD Task Cmd Processed Counter	N		n/a	GLA03
24	MD Task Cmd Rejected (or Error) Counter	N		n/a	GLA03
24	AD Task Cmd Processed Counter	N		n/a	GLA03
24	AD Task Cmd Rejected (or Error) Counter	N		n/a	GLA03
24	AD Target Status and Mode Flags	I	See Section A.30	n/a	GLA03
24	CD Task CMD Processed Counter	N		n/a	GLA03
24	CD Task CMD Rejected (or Error) Counter	N		n/a	GLA03
24	CD Status Flags	I	See Section A.7	n/a	GLA03

Table A-1 Conversion Description for GLAS Telemetry Data (Continued)

APID	Name	Conv. Type	Conversion Description	Units	L1A Product ID
24	DC Task Cmd Processed Counter	N		n/a	GLA03
24	DC Task Cmd Rejected (or Error) Counter	N		n/a	GLA03
24	DC Status flag	I	See Section A.8	n/a	GLA03
24	GP Task Cmd Processed Counter	N		n/a	GLA03
24	GP Task Cmd Rejected (or Error) Counter	N		n/a	GLA03
24	GP Status Bits	I	See Section A.25	n/a	GLA03
24	GP Spare	N		n/a	GLA03
24	PC Task Cmd Processed Counter	N		n/a	GLA03
24	PC Task Cmd Rejected (or Error) Counter	N		n/a	GLA03
24	PC Status Flag	I	See Section A.9	n/a	GLA03
24	CT Task Cmd Processed Counter	N		n/a	GLA03
24	CT Task Cmd Rejected (or Error) Counter	N		n/a	GLA03
24	CT Task Mode	I	See Section A.10	n/a	GLA03
25	HS Processor Previous Mode	I	0,1,4=Unknown, 2=PROM, 3=EEPROM	n/a	GLA03
25	HS Processor Current Mode	I	0,1,4=Unknown, 2=PROM, 3=EEPROM	n/a	GLA03
25	Subsystem Present Flags	I	See Section A.11	n/a	GLA03
25	HS Warm Restart Count	N		n/a	GLA03
25	HS Cold Restart Count	N		n/a	GLA03
25	HS Max Warm Restart Count	N		n/a	GLA03
25	HS Cold-Warm Flag	N		n/a	GLA03
25	HS OS Caused Reset Flag	N		n/a	GLA03
25	HS OS Tick Count	N		n/a	GLA03
25	HS HS Exec Count	N		n/a	GLA03
25	HS CS Exec Count	N		n/a	GLA03
25	HS TC Exec Count	N		n/a	GLA03
25	HS SB Exec Count	N		n/a	GLA03
25	HS SM Exec Count	N		n/a	GLA03
25	HS RT Exec Count	N		n/a	GLA03

Table A-1 Conversion Description for GLAS Telemetry Data (Continued)

APID	Name	Conv. Type	Conversion Description	Units	L1A Product ID
25	HS MD Exec Count	N		n/a	GLA03
25	HS AD Exec Count	N		n/a	GLA03
25	HS CD Exec Count	N		n/a	GLA03
25	HS DC Exec Count	N		n/a	GLA03
25	HS GP Exec Count	N		n/a	GLA03
25	HS PC Exec Count	N		n/a	GLA03
25	HS CT Exec Count	N		n/a	GLA03
25	HS FPU Underflow Count	N		n/a	GLA03
25	HS Timer 2 ISR Count	N		n/a	GLA03
25	HS FP ISR Count	N		n/a	GLA03
25	HS TC Fire Cmd ISR Count	N		n/a	GLA03
25	HS RT ISR Count - Low Priority	N		n/a	GLA03
25	HS Spare ISR Count	N		n/a	GLA03
25	HS CT ISR Count	N		n/a	GLA03
25	HS PCI Initiator ISR Count	N		n/a	GLA03
25	HS GPS UART ISR Count	N		n/a	GLA03
25	HS GPS 10 Sec ISR Count	N		n/a	GLA03
25	HS DC ISR Count	N		n/a	GLA03
25	HS PC ISR Count	N		n/a	GLA03
25	HS WD ISR Count	N		n/a	GLA03
25	HS AD ISR Count	N		n/a	GLA03
25	HS CD ISR Count	N		n/a	GLA03
25	HS OS Event Sequence Number	N		n/a	GLA03
25	HS Peak CPU Utilization	N		n/a	GLA03
25	HS Last CPU Utilization	N		n/a	GLA03
25	HS OS PCI Bus Target Enable and Interrupt status	N		n/a	GLA03
25	HS OS Performance Log Enable Flag	I	0x01; 0=Disabled, 1=Enabled	n/a	GLA03
25	HS OS Performance Log Item Count	N		n/a	GLA03
25	HS OS Performance Log Filter Start Address	N		n/a	GLA03
25	HS OS Performance Log Filter Mask	N		n/a	GLA03
25	Spares	N		n/a	GLA03

Table A-1 Conversion Description for GLAS Telemetry Data (Continued)

APID	Name	Conv. Type	Conversion Description	Units	L1A Product ID
25	CS Status Flags	I	See Section A.12	n/a	GLA03
25	CS Code Segment Error Count	N		n/a	GLA03
25	CS EEPROM Segment Error Count	N		n/a	GLA03
25	CS Table Ram Segment Error Count	N		n/a	GLA03
25	CS Table ID of last Code Error	N		n/a	GLA03
25	CS Table ID of last EEPROM Error	N		n/a	GLA03
25	CS Table ID of last Table RAM Error	N		n/a	GLA03
25	CS Code Segment Master Checksum	N		n/a	GLA03
25	CS Table RAM Master Checksum	N		n/a	GLA03
25	CS EEPROM Master Checksum	N		n/a	GLA03
25	CS Checksum of EEPROM Boot Memory	N		n/a	GLA03
25	CS Checksum of EEPROM Memory	N		n/a	GLA03
25	CS Checksum of PROM Memory	N		n/a	GLA03
25	CS Spare	N		n/a	GLA03
25	TC GLAS MET Upper 2 bytes	U	0xFF0000		GLA03
25	TC GLAS MET Lower 4 bytes	U	0x00FFFF		GLA03
25	TC Fire Command Time Increment Upper 2 bytes	U			GLA03
25	TC Fire Command Time Increment Lower 4 bytes	U			GLA03
25	TC GLAS MET Working Time seconds	U			GLA03
25	TC GLAS MET Working Time microseconds	U			GLA03
25	Spare	N		n/a	GLA03
25	SB Send Error Count	N		n/a	GLA03
25	SB Receive Error Count	N		n/a	GLA03
25	SB OS Error Count	N		n/a	GLA03
25	SB Queue Full Error Count	N		n/a	GLA03
25	SB Buffer overrun Error Count	N		n/a	GLA03
25	SB last buffer overrun - Stream Id	N		n/a	GLA03
25	SB last buffer overrun - Pipeline Id	N		n/a	GLA03
25	SB last buffer overrun - Sender Task ID	N		n/a	GLA03

Table A-1 Conversion Description for GLAS Telemetry Data (Continued)

APID	Name	Conv. Type	Conversion Description	Units	L1A Product ID
25	SB last queue full - Stream Id	N		n/a	GLA03
25	SB last queue full - Pipeline Id	N		n/a	GLA03
25	SB last queue full - Sender Task ID	N		n/a	GLA03
25	SB Spare	N		n/a	GLA03
25	SM number of remaining copies to be dumped	N		n/a	GLA03
25	SM table/memory dump in progress flag	I	0=False, 1=True	n/a	GLA03
25	SM table operations flag	I	See Section A.13	n/a	GLA03
25	SM table operations from image type	I	0=None, 1=EEPROM, 2=RAM, 3=NULL	n/a	GLA03
25	SM table id selected	N		n/a	GLA03
25	SM currently selected table size in words	N		n/a	GLA03
25	SM currently selected table checksum	N		n/a	GLA03
25	SM table commit success count	N		n/a	GLA03
25	SM table commit failure count	N		n/a	GLA03
25	SM table num. of words loaded	N		n/a	GLA03
25	SM FSW build number	N		n/a	GLA03
25	SM FSW version number	N		n/a	GLA03
25	SM spares	N		n/a	GLA03
25	BCRT CONTROL REGISTER WORD	I	See Section A.14	n/a	GLA03
25	BCRT Status Register	I	0=RT Mode Disabled, 1=RT Mode Enabled	n/a	GLA03
25	BCRT INTERRUPT STATUS REGISTER	N		n/a	GLA03
25	RT 1553 MESSAGE ERRORS	N		n/a	GLA03
25	RT 1553 RETRY COUNT	N		n/a	GLA03
25	RT 1553 INVALID COMMANDS	N		n/a	GLA03
25	RT 1553 INVALID BROADCAST CMDS	N		n/a	GLA03
25	RT MODE CODES RECEIVED	N		n/a	GLA03
25	SPARE	N		n/a	GLA03
25	RT PACKETS RECEIVED ON RCH1	N		n/a	GLA03
25	RT PACKETS Rejected ON RCH1	N		n/a	GLA03

Table A-1 Conversion Description for GLAS Telemetry Data (Continued)

APID	Name	Conv. Type	Conversion Description	Units	L1A Product ID
25	RT PACKETS SENT ON XCH1	N		n/a	GLA03
25	RT PACKETS SENT ON XCH2	N		n/a	GLA03
25	RT Number of Command History Packets Sent	N		n/a	GLA03
25	RT Checksum Status	I	0=Cmd CS Disabled, 1=Cmd CS Enabled	n/a	GLA03
25	Spares	N		n/a	GLA03
25	MD Enable/Disable Flag	I	See Section A.22	n/a	GLA03
25	MD Table 1 Address Count	N		n/a	GLA03
25	MD Table 2 Address Count	N		n/a	GLA03
25	MD Table 1 Rate	P	0.0,0.125	seconds	GLA03
25	MD Table 2 Rate	P	0.0,0.125	seconds	GLA03
25	MD spare	N		n/a	GLA03
55	AD Software Error Count	N		n/a	GLA03
55	AD Hardware Error Count	N		n/a	GLA03
55	AD Shot Count Value	N		n/a	GLA03
55	AD Shot Count Skip Detected	I	0= no skip, 1=skip	n/a	GLA03
55	AD Synchronized Flag	I	0=not in sync, 1=in sync	n/a	GLA03
55	AD Spare	N		n/a	GLA03
55	AD DSP Laser Fire Count	N		n/a	GLA03
55	AD DSP Alive Count	N		n/a	GLA03
55	AD Ancillary Packets Sent	N		n/a	GLA03
55	AD Engineering Packets Sent	N		n/a	GLA03
55	AD Science Small Packets Sent	N		n/a	GLA03
55	AD Science Large Packets Sent	N		n/a	GLA03
55	AD DSP Load Packets Processed Count	N		n/a	GLA03
55	AD DSP Memory Dump Packets Sent	N		n/a	GLA03
55	AD Memory Load Command Errors	N		n/a	GLA03
55	AD Memory Dump Command Errors	N		n/a	GLA03
55	AD DSP Checksum Rate	N		n/a	GLA03
55	AD DSP Checksum S/W Valid Status	I	0=Not Valid, 1=Valid	n/a	GLA03
55	AD DSP # of times all of memory has been checksummed	N		n/a	GLA03

Table A-1 Conversion Description for GLAS Telemetry Data (Continued)

APID	Name	Conv. Type	Conversion Description	Units	L1A Product ID
55	AD DSP Bootstrap Checksum Lower 16 bits	N		n/a	GLA03
55	AD DSP EPROM Checksum Lower 16 bits	N		n/a	GLA03
55	AD DSP RAM Checksum Lower 16 bits	N		n/a	GLA03
55	AD DSP Bootstrap Checksum Upper 32 bits	N		n/a	GLA03
55	AD DSP EPROM Checksum Upper 32 bits	N		n/a	GLA03
55	AD DSP RAM Checksum Upper 32 bits	N		n/a	GLA03
55	AD DSP S/W Build Number	N		n/a	GLA03
55	AD DSP S/W Version Number	N		n/a	GLA03
55	AD GPS Range Window Packets received	N		n/a	GLA03
55	AS DSP Patch Checksum bits 15..0	N		n/a	GLA03
55	AS DSP Patch Checksum bits 47...16	N		n/a	GLA03
55	AD Auto Reset DSP Flag	I	0=False; 1=True	n/a	GLA03
55	AD Software Enable Flag	I	See Section A.26	n/a	GLA03
55	AD DSP Trouble Indicator Status Word	I	See Section A.27	n/a	GLA03
55	AD DSP Memory Table Load Error Counter	N		n/a	GLA03
55	AD Fixed Return Gain Setting	N		n/a	GLA03
55	AD Spares	N		n/a	GLA03
55	CD Software Error Count	N		n/a	GLA03
55	CD Shot Count	N		n/a	GLA03
55	CD Science Mode Packets Sent	N		n/a	GLA03
55	CD Engineering Mode Packets Sent	N		n/a	GLA03
55	CD Ancillary Packet Sent	N		n/a	GLA03
55	CD Range Gate Packets Received	N		n/a	GLA03
55	CD 40-bit Counter Packets Sent	N		n/a	GLA03
55	Spare	N		n/a	GLA03
55	CD Background #1 Delay	P	0.0,128.0	nanoseconds	GLA03

Table A-1 Conversion Description for GLAS Telemetry Data (Continued)

APID	Name	Conv. Type	Conversion Description	Units	L1A Product ID
55	CD Background #2 Delay	P	0.0,128.0	nanoseconds	GLA03
55	CD Range Gate Delay	P	0.0,128.0	nanoseconds	GLA03
55	Spare	N		n/a	GLA03
55	CD Raw A/D Output Data	I	See Section A.15	n/a	GLA03
55	CD GPS 40 bit Latch Value 32 lsb	U			GLA03
55	CD Fire Acknowledge 40 bit Latch Value 32 lsb	U			GLA03
55	CD Fire Cmd 40 bit Latch Value 32 lsb	U			GLA03
55	Spare	N		n/a	GLA03
55	CD Fire Cmd 40 bit Latch Value 8 msb	U			GLA03
55	CD Fire Acknowledge 40 bit Latch Value 8 msb	U			GLA03
55	CD GPS 40 bit Latch Value 8 msb	U			GLA03
55	CD Data Ready Counter	I	CD Fire Acknowledge Counter mask 0x0000FF00; CD Data Ready Counter mask 0x000000FF	n/a	GLA03
55	CD Interrupt Status	I	See Section A.16	n/a	GLA03
55	Spare	N		n/a	GLA03
55	DC Software Fail Count	N		n/a	GLA03
55	DC Shot Count	N		n/a	GLA03
55	DC X Position	N		n/a	GLA03
55	DC Y Position	N		n/a	GLA03
55	DC LPA Packets Sent	N		n/a	GLA03
55	DC Test Mode Rate	N		n/a	GLA03
55	DC Packets Sent	N		n/a	GLA03
55	DC Bytes Sent	N		n/a	GLA03
55	DC Output bit rate in BPS	N		n/a	GLA03
55	DC Interrupt register	N		n/a	GLA03
55	DC Control latch register	N		n/a	GLA03
55	DC Interrupt Mask Register	I	See Section A.17	n/a	GLA03
55	DC fifo flags register	I	See Section A.18	n/a	GLA03

Table A-1 Conversion Description for GLAS Telemetry Data (Continued)

APID	Name	Conv. Type	Conversion Description	Units	L1A Product ID
55	DC LPA gain register	I	See Section A.19	n/a	GLA03
55	DC LPA packet count register	I	See Section A.20	n/a	GLA03
55	DC Spares	N		n/a	GLA03
55	GP GPS 10 second Interrupt Count	N		n/a	GLA03
55	GP Number of Position Packets received	N		n/a	GLA03
55	GP Number of Housekeeping packets sent	N		n/a	GLA03
55	GP Number of Ancillary Packets sent	N		n/a	GLA03
55	GP GPS 10 second Pulse 40-Bit Counter Requests sent	N		n/a	GLA03
55	GP GPS 10 sec. Pulse 40-Bit Counter Packets Received	N		n/a	GLA03
55	GP Packets with bad X,Y,Z position data	N		n/a	GLA03
55	GP Packets with X,Y,Z position data below tolerance	N		n/a	GLA03
55	GP Number of range packets sent	N		n/a	GLA03
55	GP Spares	N		n/a	GLA03
55	PC Software Error Count	N		n/a	GLA03
55	PC Shot Counter	N		n/a	GLA03
55	PC SCIENCE MODE PACKETS SENT	N		n/a	GLA03
55	PC ENGINEERING MODE PACKETS SENT	N		n/a	GLA03
55	PC ANCILLARY MODE PACKETS SENT	N		n/a	GLA03
55	PC RANGE GATE DELAY PACKETS RECEIVED	N		n/a	GLA03
55	PC SPCM Gate Delay	P	0.0,128.0	nanoseconds	GLA03
55	PC Background 1 Delay	P	0.0,128.0	nanoseconds	GLA03
55	PC Background 2 Delay	P	0.0,128.0	nanoseconds	GLA03
55	PC Range Gate Delay	P	0.0,128.0	nanoseconds	GLA03

Table A-1 Conversion Description for GLAS Telemetry Data (Continued)

APID	Name	Conv. Type	Conversion Description	Units	L1A Product ID
55	PC Hardware Mode Status Word	I	See Section A.21	n/a	GLA03
55	PC SPCM STATUS	I	Bits indicate which SPCM are enabled; 0=Enabled, 1=Disabled.: SPCM 1: mask 0x00000100; SPCM 2: mask 0x00000200; SPCM 3: mask 0x00000400; SPCM 4: mask 0x00000800; SPCM 5: mask 0x00001000; SPCM 6: mask 0x00002000; SPCM 7: mask 0x00004000; SPCM 8: mask 0x00008000	n/a	GLA03
55	PC Data Ready Counter	I	PC Fire Acknowledge Counter: mask 0x00FF00 PC Data Ready Counter: mask 0x0000FF		GLA03
55	PC SPCM 1 THROUGH 4 RAW COUNTS	I	SPCM Raw Counts; SPCM 1: mask 0x000000FF SPCM 2: mask 0x0000FF00 SPCM 3: mask 0x00FF0000 SPCM 4: mask 0xFF000000	counts	GLA03
55	PC SPCM 5 THROUGH 8 RAW COUNTS	I	SPCM Raw Counts; SPCM 5: mask 0x000000FF SPCM 6: mask 0x0000FF00 SPCM 7: mask 0x00FF0000 SPCM 8: mask 0xFF000000	counts	GLA03
55	PC SPCM Duty Cycle	N			GLA03
55	PC Coarse Boresite Calibration X Start Pos	N			GLA03
55	PC Coarse Boresite Calibration Y Start Pos	N			GLA03
55	PC Fine Boresite Calibration X Start Pos	N			GLA03
55	PC Fine Boresite Calibration Y Start Pos	N			GLA03
55	PC Coarse Boresite Calibration X Increment	N			GLA03
55	PC Coarse Boresite Calibration Y Increment	N			GLA03
55	PC Fine Boresite Calibration X Increment	N			GLA03

Table A-1 Conversion Description for GLAS Telemetry Data (Continued)

APID	Name	Conv. Type	Conversion Description	Units	L1A Product ID
55	PC Fine Boresite Calibration Y Increment	N			GLA03
55	PC Coarse Boresite Calibration Integration Seconds	N			GLA03
55	PC Fine Boresite Calibration Integration Seconds	N			GLA03
55	PC Boresite Calibration Best X Position	N			GLA03
55	PC Boresite Calibration Best Y Position	N			GLA03
55	PC Boresite Calibration Seconds Remaining	N			GLA03
55	Spares	N		n/a	GLA03
55	CT State Machine Current State	I	0=Unknown, 1=Reset, 2=Timeout, 3=Acquire Sync, 4=Wait for Muxes, 5=Process Telemetry, 6=Unknown	n/a	GLA03
55	CT COMMAND ECHO ERRORS	N		n/a	GLA03
55	CT LM BOARD CMDS RECEIVED	N		n/a	GLA03
55	CT TM BOARD CMDS RECEIVED	N		n/a	GLA03
55	CT MC BOARD CMDS RECEIVED	N		n/a	GLA03
55	CT HK BOARD CMDS RECEIVED	N		n/a	GLA03
55	CT HVPS Ccmds Received	N		n/a	GLA03
55	CT PDU Ccmds Received	N		n/a	GLA03
55	CT HW TLM 1 PACKETS SENT	N		n/a	GLA03
55	CT HW TLM 2 PACKETS SENT	N		n/a	GLA03
55	CT HW TLM 3 PACKETS SENT	N		n/a	GLA03
55	CT HW TLM 4 PACKETS SENT	N		n/a	GLA03
55	CT HW TLM 5 PACKETS SENT	N		n/a	GLA03
55	CT DWELL PACKETS SENT	N		n/a	GLA03
55	CT ANCILLARY PACKETS SENT	N		n/a	GLA03
55	CT TIMEOUT COUNT	N		n/a	GLA03
55	CT INTERRUPT COUNT	N		n/a	GLA03
55	CT Shot Counter Errors	N		n/a	GLA03
55	CT Dwell Mode	I	0=None, 1=LMB, 2=HK, 4=TCM, 8=MCS, 16=PDU, 32=HVPS	n/a	GLA03

Table A-1 Conversion Description for GLAS Telemetry Data (Continued)

APID	Name	Conv. Type	Conversion Description	Units	L1A Product ID
55	CT Dwell Channel	N		n/a	GLA03
55	CT Laser Monitor Board Mux Error Counter	N		n/a	GLA03
55	CT Housekeeping Board Mux Error Counter	N		n/a	GLA03
55	CT Housekeeping Board Submux Error Counter	N		n/a	GLA03
55	CT Temperature Controller Board Mux Error Counter	N		n/a	GLA03
55	CT Mechanism Controller Board Mux Error Counter	N		n/a	GLA03
55	CT High Voltage Power Supply Mux Error Counter	N		n/a	GLA03
55	CT Power Distribution Unit Mux Error Counter	N		n/a	GLA03
55	CT Command Echo Success Count	N		n/a	GLA03
55	CT Suppressed Event Message Error Flags	I	See Section A.23	n/a	GLA03
55	CT LHP1 Temperature Control State	I	See Section A.24	n/a	GLA03
55	CT LHP2 Temperature Control State	I	See Section A.24	n/a	GLA03
55	CT LHP1 Temperature Setpoint	N		n/a	GLA03
55	CT LHP2 Temperature Setpoint	N		n/a	GLA03
55	CT LHP1 Temperature Control Counter	N		n/a	GLA03
55	CT LHP2 Temperature Control Counter	N		n/a	GLA03
55	CT LHP1 Minimum Temperature	N		n/a	GLA03
55	CT LHP2 Minimum Temperature	N		n/a	GLA03
55	CT LHP1 Temperature Change	N		n/a	GLA03
55	CT LHP2 Temperature Change	N		n/a	GLA03
55	CT LHP1 Temperature Control Cycle Time	N		n/a	GLA03
55	CT LHP2 Temperature Control Cycle Time	N		n/a	GLA03
55	CT Misc Status Flags	I	0=HK SubMUX Paused 1=OK	n/a	GLA03
55	CT Spares	N		n/a	GLA03

Table A-1 Conversion Description for GLAS Telemetry Data (Continued)

APID	Name	Conv. Type	Conversion Description	Units	L1A Product ID
31	Dump Packet CRC Error	I	0 = No Errors 1 = CRC Error Detected	n/a	*
31	Start address	N			*
31	Number of 48-bit words in packet	N		n/a	*
31	Type	I	0=data memory, 1=program memory	n/a	*
31	Data	I	100 48 bit-words. Every 2 consecutive 32-bit words contain a 48-bit word. The first 32-bit word contains the most significant 32 bits and the second contains the least significant 16-bits with the upper 16 bits zero filled.		*
32	Dump Packet CRC Error	I	0 = No Errors 1 = CRC Error Detected	n/a	*
32	Start address	N			*
32	Number of 32-bit words in packet	N	For Altimeter Digitizer one shot mode, multiply this number by 4 to get the number of waveform bins contained in the packet.	n/a	*
32	Type	I	0=data memory, 1=program memory	n/a	*
32	Data	N		n/a	*
33	C&T Board where telemetry point is being dwelled on	I	1=LMB, 2=HK, 4=TCM, 8=MCS, 16=PDU, 32=HVPS	n/a	*
33	Telemetry channel (or point) to dwell on	N		n/a	*
33	Data from 1st second (older)	N		n/a	*
33	Data from 2nd second	N		n/a	*
33	Data from 3rd second	N		n/a	*
33	Data from 4th second	N		n/a	*
27/28	The number of words currently used by Dwell Table 1 or 2	N		n/a	*
27/28	The dwell rate for Table 1 or 2	P	$[(rate+1)*(1/8) \text{ sec}]$, must be greater than 1/2 second, Polynomial coeff=(0.125, 0.125)		*
27 /28	The stored values sampled by Memory Dwell Table 1 or 2	N		n/a	*

Table A-1 Conversion Description for GLAS Telemetry Data (Continued)

APID	Name	Conv. Type	Conversion Description	Units	L1A Product ID
27/28	Spare	N		n/a	*
34	Event Message Characters	N	66 bytes that contain a ASCII text message to be displayed on GLAS operator console (may have to be byte swapped)		*
35	Processor ID	N		n/a	*
35	Current Dump Copy Number	N		n/a	*
35	Memory Address of First Word in this Packet	N		n/a	*
35	Num. of Words Dumped in this Packet	N		n/a	*
35	Dumped Data Words	N		n/a	*
36	Table Id Number	N		n/a	*
36	Current Table Dump Copy Number	N		n/a	*
36	Table Offset	N		n/a	*
36	Num. of Words Dumped in this Packet	N		n/a	*
36	Table Source Type	I	1 = EEPROM; 2 = RAM; 4 = BUFFER	n/a	*
36	Dumped Table Data Words	N		n/a	*
48	Data Types Packet Fixed Pattern	N		n/a	*
12/13/ 14	Spare	N		n/a	*
12/13/ 14	Shot Counter	N		n/a	GLA01
12/13/ 14	Transmit Pulse Waveform	N		n/a	GLA01, GLA04
12/13/ 14	Transmit Pulse Waveform Peak Time	N		ns	GLA01, GLA04
12/13/ 14	Transmit Pulse Waveform Peak Threshold Flag	I	Bit 0: Software Error Bit 1: Search Failure (below threshold) Bit 2: Search Failure Latch. Value of 0 = False, 1 = True. Note: once set to true, Bit 2 can only be cleared by a DSP reset or by a ground command.	n/a	GLA01, GLA04
12/13/ 14	Starting Address of Transmit Pulse Sample	N		ns	GLA01, GLA04

Table A-1 Conversion Description for GLAS Telemetry Data (Continued)

APID	Name	Conv. Type	Conversion Description	Units	L1A Product ID
12/13/14	Ending Address of Range Response Surface Echo Dump	N		ns	GLA01
12/13/14	Last Threshold Crossing Time(Trailing Edge)	N		ns	GLA01
12/13/14	Next to Last Threshold Crossing Time(Leading Edge)	N		ns	GLA01
12/13/14	4ns Filter Peak Value	N		counts	GLA01
12/13/14	8ns Filter Peak Value	N		counts	GLA01
12/13/14	Peak Value for the selected filter	N		counts	GLA01
12/13/14	Time of the Peak Value for the selected filter	N		ns	GLA01
12/13/14	Filter Selected	I	0 = 4 ns filter 1 = 8 ns filter 2 = 16 ns filter 3 = 32 ns filter 4 = 64 ns filter 5 = 128 ns filter	n/a	GLA01
12/13/14	Threshold Value	N		counts	GLA01
12/13/14	Background Noise Mean Value for 4 ns filter	N			GLA01
12/13/14	Background Noise Standard Deviation Value for the 4 ns filter	N			GLA01
12/13/14	Range Window Status Word	I	See Section A.29	n/a	GLA01
12/13/14	Calculated Weights for all Filters	U			GLA01
12/13/14	Altimeter Digitizer Gain Setting	U			GLA01
12/13/14	Surface Echo Sample Padding	N		n/a	GLA01
12/13/14	Surface Echo Compress Type	N	0=N, p & q 1=r	n/a	GLA01
12/13/14	Surface Echo Data Samples (may have been averaged)	N		counts	GLA01
15	Shot Counter	N			GLA02

Table A-1 Conversion Description for GLAS Telemetry Data (Continued)

APID	Name	Conv. Type	Conversion Description	Units	L1A Product ID
15	-1 km to 10 km Data	N		n/a	GLA02
15	Background	N		n/a	GLA02
15	error flags	N		n/a	GLA02
15	spares	N		n/a	GLA02
15	10 km to 20 km data	N		n/a	GLA02
15	20 km to 40 km data	N		n/a	GLA02
16	Shot Counter	N		n/a	*
16	40 km to 20 km data	N		n/a	*
16	20 km to 10 km data	N		n/a	*
16	10 km to -1km data	N		n/a	*
17	Shot Counter	N		n/a	GLA02
17	-1 km to 10 km Data	N		n/a	GLA02
17	Background	N		n/a	GLA02
17	10 km to 20 km data	N		n/a	GLA02
18	Shot Counter	N		n/a	*
18	20 km to 10 km data	N		n/a	*
18	10 km to -1 km data	N		n/a	*
19	Shot counter	N		n/a	GLA03
19	Check-In Flags	I	1= tlm in ancillary packet, 0=tlm NOT in ancillary packet; AD Checkin Flag:Mask=0x01 PC Checkin Flag: Mask 0x02 CD Checkin Flag: Mask 0x04 GP Checkin Flag: Mask 0x08 CT Checkin Flag: Mask 0x10	n/a	GLA03
19	Shot Counter	N		n/a	GLA03
19	Altimeter Dig. Range Window Rmin	N		ns	GLA01
19	Altimeter Dig. Range Window Rmax	N		ns	GLA01
19	RMS Noise calculation start time offset	N		ns	GLA01

Table A-1 Conversion Description for GLAS Telemetry Data (Continued)

APID	Name	Conv. Type	Conversion Description	Units	L1A Product ID
19	Filter Selection Mask	I	0=Filter Disabled, 1=Filter Enabled. 4 ns: Mask=0x0001 8 ns: Mask=0x0002 16 ns: Mask=0x0004 32 ns: Mask=0x0008 64 ns: Mask=0x0010 128 ns: Mask=0x0020	n/a	GLA01
19	Shot Counter for PDL waveform	N		n/a	GLA03
19	Post Delay Laser Pulse Response Start Address	N		ns	GLA03
19	Sampled Post Delay Pulse Waveform	N		n/a	GLA03
19	OTS Laser Pulse Response Start Address	N		ns	GLA03
19	Shot Counter for OTS	N		n/a	GLA03
19	Sampled OTS Pulse Waveform	N		n/a	GLA03
19	Location of transmit pulse search window (start)	N		ns	GLA03
19	Number of No Threshold Crossing Shots for Error Condition	N		n/a	GLA03
19	Spare Telemetry Byte	N		n/a	GLA03
19	Surface Echo Land Type	I	0=sea, 1=land, 2=sea/ice, 3=land/ice	n/a	GLA01
19	Value of 'p' used for frame	N		n/a	GLA01
19	Value of 'q' used for frame	N		n/a	GLA01
19	Value of 'N' used for frame	N		n/a	GLA01
19	Value of 'r' used for frame	N		n/a	GLA01
19	Transmit Pulse Threshold Value	N		counts	GLA03
19	Filter Weight Param C0 for 4 ns filter	N		n/a	GLA03
19	Filter Weight Param C1 for 4 ns filter	N		n/a	GLA03
19	Filter Weight Param C2 for 4 ns filter	N		n/a	GLA03
19	Filter Weight Param C3 for 4 ns filter	N		n/a	GLA03
19	Filter Weight Param C0 for 8 ns filter	N		n/a	GLA03
19	Filter Weight Param C1 for 8 ns filter	N		n/a	GLA03
19	Filter Weight Param C2 for 8 ns filter	N		n/a	GLA03
19	Filter Weight Param C3 for 8 ns filter	N		n/a	GLA03

Table A-1 Conversion Description for GLAS Telemetry Data (Continued)

APID	Name	Conv. Type	Conversion Description	Units	L1A Product ID
19	Filter Weight Param C0 for 16 ns filter	N		n/a	GLA03
19	Filter Weight Param C1 for 16 ns filter	N		n/a	GLA03
19	Filter Weight Param C2 for 16 ns filter	N		n/a	GLA03
19	Filter Weight Param C3 for 16 ns filter	N		n/a	GLA03
19	Filter Weight Param C0 for 32 ns filter	N		n/a	GLA03
19	Filter Weight Param C1 for 32 ns filter	N		n/a	GLA03
19	Filter Weight Param C2 for 32 ns filter	N		n/a	GLA03
19	Filter Weight Param C3 for 32 ns filter	N		n/a	GLA03
19	Filter Weight Param C0 for 64 ns filter	N		n/a	GLA03
19	Filter Weight Param C1 for 64 ns filter	N		n/a	GLA03
19	Filter Weight Param C2 for 64 ns filter	N		n/a	GLA03
19	Filter Weight Param C3 for 64 ns filter	N		n/a	GLA03
19	Filter Weight Param C0 for 128 ns filter	N		n/a	GLA03
19	Filter Weight Param C1 for 128 ns filter	N		n/a	GLA03
19	Filter Weight Param C2 for 128 ns filter	N		n/a	GLA03
19	Filter Weight Param C3 for 128 ns filter	N		n/a	GLA03
19	Background Noise A1 Coefficient for 4ns Filter	N		n/a	GLA03
19	Background Noise A2 Coefficient for 4ns Filter	N		n/a	GLA03
19	Background Noise A3 Coefficient for 4ns Filter	N		n/a	GLA03
19	Background Noise A1 Coefficient for 8ns Filter	N		n/a	GLA03
19	Background Noise A2 Coefficient for 8ns Filter	N		n/a	GLA03
19	Background Noise A3 Coefficient for 8ns Filter	N		n/a	GLA03
19	Background Noise A1 Coefficient for 16ns Filter	N		n/a	GLA03
19	Background Noise A2 Coefficient for 16ns Filter	N		n/a	GLA03
19	Background Noise A3 Coefficient for 16ns Filter	N		n/a	GLA03

Table A-1 Conversion Description for GLAS Telemetry Data (Continued)

APID	Name	Conv. Type	Conversion Description	Units	L1A Product ID
19	Background Noise A1 Coefficient for 32ns Filter	N		n/a	GLA03
19	Background Noise A2 Coefficient for 32ns Filter	N		n/a	GLA03
19	Background Noise A3 Coefficient for 32ns Filter	N		n/a	GLA03
19	Background Noise A1 Coefficient for 64ns Filter	N		n/a	GLA03
19	Background Noise A2 Coefficient for 64ns Filter	N		n/a	GLA03
19	Background Noise A3 Coefficient for 64ns Filter	N		n/a	GLA03
19	Background Noise A1 Coefficient for 128ns Filter	N		n/a	GLA03
19	Background Noise A2 Coefficient for 128ns Filter	N		n/a	GLA03
19	Background Noise A3 Coefficient for 128ns Filter	N		n/a	GLA03
19	Spare Telemetry Bytes	N		n/a	GLA03
19	Enable/Disable Auto Gain Calculation	N	0 = fixed; 1 = Auto	n/a	GLA03
19	Enable/Disable Use of 8ns Filter for Auto Gain Calculation	N	0 = Selected Filter; 1 = 8 ns Filter	n/a	GLA03
19	Return Gain Value	N		n/a	GLA03
19	Auto Gain Calculation A1 Parameter	N		n/a	GLA03
19	Auto Gain Calculation A2 Parameter	N		n/a	GLA03
19	Auto Gain Calculation A3 Parameter	N		n/a	GLA03
19	Auto Gain Calculation A4 Parameter	N		n/a	GLA03
19	Auto Gain Calculation B1 Parameter	N		n/a	GLA03
19	Auto Gain Calculation B2 Parameter	N		n/a	GLA03
19	Auto Gain Calculation B3 Parameter	N		n/a	GLA03
19	Auto Gain Calculation B4 Parameter	N		n/a	GLA03
19	Auto Gain Calculation C0 parameter	N		n/a	GLA03
19	Auto Gain Calculation C1 parameter	N		n/a	GLA03
19	Auto Gain Calculation Vref Parameter	N		n/a	GLA03
19	Auto Gain Calculation Zmin Parameter	N		n/a	GLA03

Table A-1 Conversion Description for GLAS Telemetry Data (Continued)

APID	Name	Conv. Type	Conversion Description	Units	L1A Product ID
19	Auto Gain Calculation Zmax Parameter	N		n/a	GLA03
19	Auto Gain Calculation Vmin Parameter	N		n/a	GLA03
19	Auto Gain Calculation Ginit Parameter	N		n/a	GLA03
19	Auto Gain Calculation Gmin Parameter	N		n/a	GLA03
19	Auto Gain Calculation Gmax Parameter	N		n/a	GLA03
19	Tolerance for Coincidence of Filters	N		ns	GLA03
19	Range Window Dump (waveform time) Offset for 4 ns filter	N		ns	GLA03
19	Range Window Dump (waveform time) Offset for 8 ns filter	N		ns	GLA03
19	Range Window Dump (waveform time) Offset for 16 ns filter	N		ns	GLA03
19	Range Window Dump (waveform time) Offset for 32 ns filter	N		ns	GLA03
19	Range Window Dump (waveform time) Offset for 64 ns filter	N		ns	GLA03
19	Range Window Dump (waveform time) Offset for 128 ns filter	N		ns	GLA03
19	Surface (Pulse) Return Threshold Values for All Filters	N	2 spare bytes; 6 threshold values - one for each filter.	n/a	GLA03
19	FIR Filter Coefficients	N		n/a	GLA03
19	Filter Weight Min Standard Deviation	N		n/a	GLA03
19	Filter Noise Minimum thresholds for 4 ns filter	N		counts	GLA03
19	Filter Noise Minimum thresholds for 8 ns filter	N		counts	GLA03
19	Filter Noise Minimum thresholds for 16 ns filter	N		counts	GLA03
19	Filter Noise Minimum thresholds for 32 ns filter	N		counts	GLA03
19	Filter Noise Minimum thresholds for 64 ns filter	N		counts	GLA03
19	Filter Noise Minimum thresholds for 128 ns filter	N		counts	GLA03
19	Filter Reject Mask for Leading Edge Failures	N		counts	GLA03

Table A-1 Conversion Description for GLAS Telemetry Data (Continued)

APID	Name	Conv. Type	Conversion Description	Units	L1A Product ID
19	Filter Reject Mask for Trailing Edge Failures	N		counts	GLA03
19	Spare Telemetry Bytes	N		n/a	GLA03
19	Spare	N		n/a	GLA03
19	SPCM 1-4 Raw Counts	N		counts	GLA02
19	SPCM 5-8 Raw Counts	N		counts	GLA02
19	SPCM Gate Delay and Background #1 Delay	N		counts	GLA02
19	Background #2 Delays and Range Gate Delay	N		counts	GLA02
19	SPCM status	N		counts	GLA02
19	Spare	N		counts	GLA02
19	A/D output and CD Amplifier Attenuation (gain) setting	N		counts	GLA02
19	Background #1 Delay	N		counts	GLA02
19	Background #2 and Range Gate Delay	N		counts	GLA02
19	Detector status	N		counts	GLA02
19	Spare	N		n/a	GLA03
19	Shot Counter for start of Frame	N		n/a	GLA03
19	Shot Counter	N		counts	GLA03
19	Fire Acknowledge Time (from Freq and Time Bd)	M			GLA03
19	Fire Command Time (from Freq and Time Bd)	M	See Section A.32 for shot time tag specification. The raw value will be stored on GLA03. The shot times will be stored on GLA01 and GLA04		GLA03, GLA01, GLA04
19	Latitude	N		degrees	GLA03
19	Longitude	N		degrees	GLA03
19	Height (Hsat)	P	0.0, 1000.0	meters	GLA02, GLA03
19	Rsat	P	0.0, 1000.0	meters	GLA01
19	Rmin	P	0.0, 1000.0	meters	GLA01
19	Rmax	P	0.0, 1000.0	meters	GLA01
19	Wmin	P	0.0, 1000.0	meters	GLA01

Table A-1 Conversion Description for GLAS Telemetry Data (Continued)

APID	Name	Conv. Type	Conversion Description	Units	L1A Product ID
19	Wmax	P	0.0, 1000.0	meters	GLA01
19	Hoffmin (DEM uncertainty + bias)	P	0.0, 1000.0	meters	GLA01, GLA02
19	Hoffmax (DEM uncertainty - bias)	P	0.0, 1000.0	meters	GLA01, GLA02
19	Rbmin	P	0.0, 1000.0	meters	GLA01
19	Rbmax	P	0.0, 1000.0	meters	GLA01
19	PC Range Bias	P	0.0, 1000.0	meters	GLA02
19	CD Range Bias	P	0.0, 1000.0	meters	GLA02
19	Surface Type	I	0=ocean & no ice 1=land & no ice 2=ocean & ice 3=land & ice	n/a	GLA01
19	Position data valid flag	I	0 = no errors detected during position data processing otherwise non-zero.	n/a	GLA03
19	Spacecraft time & position packet data	N	Format is defined in spacecraft ICD.	n/a	GLA03
19	Shot Count for 1553 Spacecraft Position and command packet.	N	Only lower 8 bits valid	n/a	GLA03
19	GLAS MET for 1553 Spacecraft Position and command packet.	U			GLA03
19	DEM minimum byte	I, P	See Section A.28	meters	GLA01, GLA02, GLA03
19	DEM maximum byte	I, P	See Section A.28	meters	GLA01, GLA02, GLA03
19	Range data source	I	0=s/c time & pos packet 1=uplinked DEM bytes 2=uplinked Rmin/Rmax	n/a	GLA01, GLA03
19	GPS 10 Sec Pulse 40 bit count value	N		n/a	GLA03
19	GLAS MET for GPS 0.1 Hz Pulse	N		n/a	GLA03
19	Spare Bytes	N		n/a	GLA03
19	Etalon Calibration - Current mode	I	0 = off, 1 = Acquire, 2 = Tracking	n/a	GLA03

Table A-1 Conversion Description for GLAS Telemetry Data (Continued)

APID	Name	Conv. Type	Conversion Description	Units	L1A Product ID
19	Etalon State	I	0 = Idle, 1 = Init, 2 = Set Temperature, 3 = Settle, 4 = Average, 5 = Open Loop, 6 = Modified	n/a	GLA03
19	Etalon Temperature Settle Time	N		sec	GLA02, GLA03
19	Etalon Flags	I	See Section A.31	n/a	GLA02, GLA03
19	Etalon Averaged On-Axis Transmission	N		n/a	GLA02, GLA03
19	Etalon Averaged Off-Axis Transmission	N		n/a	GLA02, GLA03
19	Etalon Temperature Error	N		C	GLA02, GLA03
19	Etalon Tracking Loop Filter Output	N		n/a	GLA02, GLA03
19	Etalon Tracking Failure Average	N		n/a	GLA02, GLA03
19	Etalon Start Temperature for Acquire Command	N		C	GLA02, GLA03
19	Etalon Stop Temperature for Acquire Command	N		C	GLA02, GLA03
19	Etalon Temperature Step for Acquire Command	N		Deg C	GLA02, GLA03
19	Etalon Averaging Time for Acquire Command	N		sec	GLA02, GLA03
19	Etalon Temperature Settle Time for Acquire Command	N		sec	GLA02, GLA03
19	Etalon Averaging Update Counter	I	0=off, 1=on	n/a	GLA02, GLA03
19	Spare Bytes	N		n/a	GLA02, GLA03
19	Dual Pin A (Etalon Feedback Monitor Value)	N		n/a	GLA02, GLA03
19	Dual Pin B (Etalon Feedback Monitor Value)	N		n/a	GLA02, GLA03
19	Etalon 532 Energy	N		n/a	GLA02, GLA03
26	Spare	N		n/a	GLA03

Table A-1 Conversion Description for GLAS Telemetry Data (Continued)

APID	Name	Conv. Type	Conversion Description	Units	L1A Product ID
26	Shot Counter	N		counts	GLA04
26	X Position of Box	N		pixel number	GLA04
26	Y Position of Box	N		pixel number	GLA04
26	LPA Data	N			GLA04
49	Valid Commands in Packet	N		counts	*
49	GLAS Time of Command	U			*
49	Command (first 20 bytes)	U			*
126	Shot Counter	N		n/a	*
126	LPA Data	N		n/a	*
38	Calibration Type	I	0 = Coarse, 1 = Fine	n/a	*
38	X Position Of The Mirror	U			*
38	Y Position Of The Mirror	U			*
38	Integration Result	U			*

Several more complicated conversion equations and conversion equations that are based on telemetered calibration values are titled by the flight software team to be Pseudo equations. These equations are defined in Table A-2 "Pseudo-Telemetry Conversions". Table A-1 references the appropriate equation by the equation number. In Table A-2, the terms TLM_raw and TLM_proc, refer to the raw telemetry data in counts and the processed telemetry data in engineering units respectively.

Table A-2 Pseudo-Telemetry Conversions

Eqn. No.	APID / Telemetry Data	Pseudo Equation
7	21 / Primary Monitor Calibration, Upper Byte; Primary Monitor Calibration, Lower Byte	$SLOPE1 = 5.0 / (GPDMONICALUB - GPDMONICALLB)$ note: used in equations 8 - 19
8	21 / Primary Monitor Calibration, Upper Byte	$INTERCEPT1 = 5.0 - (SLOPE1 * GPDMONICALUB)$ note: used in equations 9 - 19
9	21 / +28V Bus A Instrument	$TLM_proc = ((SLOPE1 * TLM_raw) + INTERCEPT1) * 9.22$
10	21 / Hybrid Supplies	$TLM_proc = ((SLOPE1 * (TLM_raw - 10.0)) + INTERCEPT1) * 1.52$
11	21 / HVPS Detector Supplies	$TLM_proc = ((SLOPE1 * (TLM_raw - 4.0)) + INTERCEPT1) * 0.408$

Table A-2 Pseudo-Telemetry Conversions (Continued)

Eqn. No.	APID / Telemetry Data	Pseudo Equation
12	21 / Operational Heaters	$TLM_proc = ((SLOPE1 * (TLM_raw - 2.0)) + INTERCEPT1) * 0.41$
13	21 / Mechanical System	$TLM_proc = ((SLOPE1 * (TLM_raw - 3.0)) + INTERCEPT1) * 0.407$
14	21 / +28V Bus B Laser 1	$TLM_proc = ((SLOPE1 * TLM_raw) + INTERCEPT1) * 9.2$
15	21 / +28V Bus B Laser 1	$TLM_proc = ((SLOPE1 * (TLM_raw - 8.0)) + INTERCEPT1) * 1.25$
16	21 / +28V Bus C Laser 2	$TLM_proc = ((SLOPE1 * TLM_raw) + INTERCEPT1) * 9.25$
17	21 / +28V Bus C Laser 2	$TLM_proc = ((SLOPE1 * (TLM_raw - 10.0)) + INTERCEPT1) * 1.25$
18	21 / +28V Bus D Laser 3	$TLM_proc = ((SLOPE1 * TLM_raw) + INTERCEPT1) * 9.25$
19	21 / +28V Bus D Laser 3	$TLM_proc = ((SLOPE1 * (TLM_raw - 13.0)) + INTERCEPT1) * 1.25$
20	21 / Secondary Monitor Calibration, Upper Byte; Secondary Monitor Calibration, Lower Byte	$SLOPE2 = 5.0 / (GPDMON2CALUB - GPDMON2CALLB)$ note: used in equations 21 - 40
21	21 / Secondary Monitor Calibration, Upper Byte	$INTERCEPT2 = 5.0 - (SLOPE2 * GPDMON2CALUB)$ note: used in equations 22 - 40
22	21 / + 5 V Hybrid # 1	$TLM_proc = ((SLOPE2 * TLM_raw) + INTERCEPT2) * 1.514$
23	21 / + 5 V Hybrid # 1	$TLM_proc = ((SLOPE2 * TLM_raw) + INTERCEPT2) * 1.91$
24	21 / +12 V Hybrid # 2	$TLM_proc = ((SLOPE2 * TLM_raw) + INTERCEPT2) * 3.52$
25	21 / + 12 V Hybrid # 2	$TLM_proc = ((SLOPE2 * TLM_raw) + INTERCEPT2) * 0.66$
26	21 / - 12 V Hybrid # 3	$TLM_proc = ((SLOPE2 * TLM_raw) + INTERCEPT2) * (-3.515)$
27	21 / - 12 V Hybrid # 3	$TLM_proc = ((SLOPE2 * TLM_raw) + INTERCEPT2) * 0.63$
28	21 / + 5 V Hybrid # 4	$TLM_proc = ((SLOPE2 * TLM_raw) + INTERCEPT2) * 1.515$
29	21 / + 5 V Hybrid # 4	$TLM_proc = ((SLOPE2 * TLM_raw) + INTERCEPT2) * 1.91$
30	21 / - 5 V Hybrid # 5	$TLM_proc = ((SLOPE2 * TLM_raw) + INTERCEPT2) * (-1.532)$
31	21 / - 5 V Hybrid # 5	$TLM_proc = ((SLOPE2 * TLM_raw) + INTERCEPT2) * 1.49$
32	21 / - 5 V Hybrid # 6	$TLM_proc = ((SLOPE2 * TLM_raw) + INTERCEPT2) * (-1.52)$
33	21 / - 5 V Hybrid # 6	$TLM_proc = ((SLOPE2 * (TLM_raw - 3.0)) + INTERCEPT2) * 2.05$
34	21 / + 15 V Boost Post Reg	$TLM_proc = ((SLOPE2 * TLM_raw) + INTERCEPT2) * 4.05$
35	21 / - 15 V Boost Post Reg	$TLM_proc = ((SLOPE2 * TLM_raw) + INTERCEPT2) * (-4.078)$

Table A-2 Pseudo-Telemetry Conversions (Continued)

Eqn. No.	APID / Telemetry Data	Pseudo Equation
36	21 / +12 V Prim Osc Thermal Control	$TLM_proc = ((SLOPE2 * (TLM_raw - 3.0)) + INTERCEPT2) * 0.054$
37	21 / +12 V Sec Osc Thermal Control	$TLM_proc = ((SLOPE2 * (TLM_raw - 7.0)) + INTERCEPT2) * 0.052$
38	21 / -2 V Discrete Voltage	$TLM_proc = (((SLOPE2 * TLM_raw) + INTERCEPT2) * 2.0) - 5.0$
39	21 / Hybrid Heatsink Temperature	$TLM_proc = (((SLOPE2 * TLM_raw) + INTERCEPT2) * 30.2) - 30.0$
40	21 / FET Switch Bank Heatsink Temperature	$TLM_proc = (((SLOPE2 * TLM_raw) + INTERCEPT2) * 30.2) - 30.0$

A.3 Laser and OTS Enable readbacks

The interpretation of the Laser and OTS Readback telemetry word is in Table A-3 "Laser and OTS Readback Interpretation" on page -36.

Table A-3 Laser and OTS Readback Interpretation

Status	Mask	Possible Values
Laser 1 Enable/Disable Status	0x01	0=ENABLED, 1=DISABLED
Laser 2 Enable/Disable Status	0x02	0=ENABLED, 1=DISABLED
Laser 3 Enable/Disable Status	0x04	0=ENABLED, 1=DISABLED
OTS Enable/Disable Status	0x08	0=ENABLED, 1=DISABLED

A.4 FET Switch Bank

The interpretation of the FET Switch Bank telemetry word is in Table A-4 "FET Switch Bank Interpretation".

Table A-4 FET Switch Bank Interpretation

Flag	Mask	Possible Values
Primary Oscillator	0x01	0=off, 1=on
Secondary Oscillator	0x02	0=off, 1=on
Primary Altimeter Digitizer	0x10	0=off, 1=on
Secondary Altimeter Digitizer	0x20	0=off, 1=on

A.5 Optical Sensor Status

The interpretation of the Optical Sensor Status telemetry word is in Table A-5 "Optical Sensor Status Interpretation" on page -37.

Table A-5 Optical Sensor Status Interpretation

Status	Mask	Possible Values
Primary Sensor Position Laser Select Mechanism 1, HOP-1	0x0C00	0=In-Deployment, 1=Unknown, 2=Deployed, 3=Stowed
Primary Sensor Position Laser Select Mechanism 2, HOP-2	0x0300	0=In-Deployment, 1=Unknown, 2=Deployed, 3=Stowed
Primary Sensor Position Altimeter Digitizer Detector Select Mechanism, HOP-3	0x00C0	0=In-Deployment, 1=Unknown, 2=Detector 2, 3=Detector 1
Secondary Sensor Position Laser Select Mechanism 1, HOP-1	0x0030	0=In-Deployment, 1=Unknown, 2=Deployed, 3=Stowed
Secondary Sensor Position Laser Select Mechanism 2, HOP-2	0x000C	0=In-Deployment, 1=Unknown, 2=Deployed, 3=Stowed
Secondary Sensor Position Altimeter Digitizer Detector Select Mechanism, HOP-3	0x0003	0=In-Deployment, 1=Unknown, 2=Detector 2, 3=Detector 1

A.6 Status Command Telemetry

The interpretation of the Status Command telemetry word is in Table A-6 "Command Status Interpretation".

Table A-6 Command Status Interpretation

Status	Mask	Possible Values
HOP Temperature Status	0x0800	0=In Tolerance, 1=Out of Tolerance
ADC Pulse Status	0x0400	0=Not Received, 1= Received
Deployed optic diodes power status	0x0200	0=ON, 1=OFF
Stowed optic diodes power status	0x0100	0=ON, 1=OFF
HOP LED Turn Off	0x0080	0=Armed, 1=Triggered
HOP Temp Turn Off	0x0040	0=Armed, 1=Triggered

Table A-6 Command Status Interpretation (Continued)

Status	Mask	Possible Values
HOP Timer Turn Off	0x0020	0=Armed, 1=Triggered
HOP Command Trigger Status	0x0010	0=Not Received, 1= Received
Reset Latch relay command status	0x0008	0=Not Received, 1= Received
Set latch relay command status	0x0004	0=Not Received, 1= Received
DAC Initial Conversion Signal Status	0x0002	0=Not Sent, 1=Sent
DAC Latch Data Signal Status	0x0001	0=Not Sent, 1=Sent

A.7 CD Status Flags

The interpretation of the CD Status flag telemetry word is in Table A-7 "CD Status Flag Interpretation".

Table A-7 CD Status Flag Interpretation

Status	Mask	Possible Values
CD Timeout Occurred Flag	0x01	0 = no timeout 1 = timeout
CD Target Present Flag	0x02	0 = not configured 1 = configured
CD Event Messages Disable Flag	0x04	0=Enabled, 1=Disabled
CD Measurement Reference Source	0x08	0=Fire Acknowledge 1= Fire Command
CD 40Hz Interrupt	0x10	0=Enabled, 1=Disabled
CD AD Detector Selected	0x020	0= AD #1 Selected, 1=AD #2 Selected
CD Detector Selected	0x40	0= CD #1 Selected, 1=CD #2 Selected
CD AD Board Selected	0x80	0= AD #1 Selected, 1=AD #2 Selected
CD Hardware Mode	0x0F00	1=Idle, 2=Engineering, 4=Science, Other values invalid
CD Software Mode	0xF000	0=Idle, 1=Engineering, 2=Science, 3=Memory test, Other values invalid

A.8 DC Status Flags

The interpretation of the DC Status flag telemetry word is in Table A-8 "DC Status Flag Interpretation".

Table A-8 DC Status Flag Interpretation

Status	Mask	Possible Values
DC TimeoutStatus	0x01	0 = no timeout 1 = timeout
DC Target Present Flag	0x02	0 = not present 1 = target present
DC Event Messages Disable Flag	0x04	0=Enabled, 1=Disabled
DC Software Mode	0xFF00	0=SSR, 1=SSR_LPA, 2=TEST

A.9 PC Status Flags

The interpretation of the PC Status flag telemetry word is in Table A-9 "PC Status Flag Interpretation".

Table A-9 PC Status Flag Interpretation

Status	Mask	Possible Values
PC Timeout Status	0x01	0 = no timeout 1 = timeout
PC Target Present Flag	0x02	0 = not configured 1 = configured
PC Calibration Type	0x04	0=Coarse, 1=Fine
PC Event Messages Disable Flag	0x08	0=Enabled, 1=Disabled
PC Range Gate Dither Flag	0x10	0=Disabled, 1=Enabled
PC Measurement Reference Source	0x20	0=Fire Acknowledge 1= Fire Command

Table A-9 PC Status Flag Interpretation

Status	Mask	Possible Values
PC Hardware Mode	0x0F00	1=Idle, 2=Engineering, 4=Science, Other values invalid
PC Software Mode	0xF000	0=Idle, 1=Engineering, 2=Science, 3=Boresite Cal, 4=Memory test, Other values invalid

A.10 CT Task Mode

The interpretation of the CT Task Mode telemetry word is in Table A-10 "CT Task Mode Interpretation" on page -40.

Table A-10 CT Task Mode Interpretation

Status	Mask	Possible Values
CT Task Software Mode	0x0001	0=Manual, 1=Normal
CT Task C&T Control Hardware Mode Register bit	0x0002	0=Manual, 1=Normal
CT Task Startup Mode, Discrete cmd	0x0004	0=Manual, 1=Auto Power Up Osc/AD
CT Task Startup AD/OSC, Discrete cmd mask	0x0008	0=Primary, 1= Secondary
CT Etalon Mode	0x0070	0=Off, 1=Acquire, 2=Tracking, 4=Test, 5=Test/Acquire, 6=Test/Tracking
CT Etalon Tracking Active Flag	0x0080	0=Paused, 1=Active
CT Etalon Tracking Low Transmission Flag	0x0100	0=Good, 1=Low
CT Etalon Tracking Open-Loop Flag	0x0200	0=Normal, 1=Open-loop

A.11 Subsystem Present Flags

The interpretation of the Subsystem Present Flags is in Table A-11 "Subsystem Present Flag Interpretation" on page -40.

A.12 CS Status Flag

The interpretation of the CS Status Flag is in Table A-12 "CS Status Flag Interpretation".

Table A-11 Subsystem Present Flag Interpretation

Flag	Mask	Possible Values
HS Subsystem Present Flag	0x0001	0=No, 1=Yes Subsystem Telemetry is present in Small and Large Telemetry Packets
CS Subsystem Present Flag	0x0002	0=No, 1=Yes Subsystem Telemetry is present in Small and Large Telemetry Packets
TC Subsystem Present Flag	0x0004	0=No, 1=Yes Subsystem Telemetry is present in Small and Large Telemetry Packets
SB Subsystem Present Flag	0x0008	0=No, 1=Yes Subsystem Telemetry is present in Small and Large Telemetry Packets
SM Subsystem Present Flag	0x0010	0=No, 1=Yes Subsystem Telemetry is present in Small and Large Telemetry Packets
RT Subsystem Present Flag	0x0020	0=No, 1=Yes Subsystem Telemetry is present in Small and Large Telemetry Packets
MD Subsystem Present Flag	0x0040	0=No, 1=Yes Subsystem Telemetry is present in Small and Large Telemetry Packets
AD Subsystem Present Flag	0x0080	0=No, 1=Yes Subsystem Telemetry is present in Small and Large Telemetry Packets
CD Subsystem Present Flag	0x0100	0=No, 1=Yes Subsystem Telemetry is present in Small and Large Telemetry Packets
DC Subsystem Present Flag	0x0200	0=No, 1=Yes Subsystem Telemetry is present in Small and Large Telemetry Packets
GP Subsystem Present Flag	0x0400	0=No, 1=Yes Subsystem Telemetry is present in Small and Large Telemetry Packets
PC Subsystem Present Flag	0x0800	0=No, 1=Yes Subsystem Telemetry is present in Small and Large Telemetry Packets
CT Subsystem Present Flag	0x1000	0=No, 1=Yes Subsystem Telemetry is present in Small and Large Telemetry Packets

Table A-12 CS Status Flag Interpretation

Flag	Mask	Possible Values
CS Enable/Disabled Flag	0x03	0=Disabled, 1=Enabled
CS Code Memory Checksum Status	0x0C	0=Disabled, 1=Enabled, 2=Disabled and Recomputing, 3=Enabled and Recomputing

Table A-12 CS Status Flag Interpretation

Flag	Mask	Possible Values
CS Table Memory Checksum Status	0x30	0=Disabled, 1=Enabled, 2=Disabled and Recomputing, 3=Enabled and Recomputing
CS EEPROM Checksum status flag	0xC0	0=Disabled, 1=Enabled, 2=Disabled and Recomputing, 3=Enabled and Recomputing

A.13 SM Table Operations Flag

The interpretation of the SM Table Operations Flag is in Table A-13 "SM Table Operations Flag Interpretation".

Table A-13 SM Table Operations Flag Interpretation

Flag	Mask	Possible Values
SM Table Session Type	0x3F	0=None, 5=DUMP_ONLY, 6=REP_EEPROM, 7=REP_RAM, 8=APPD_ACTV
SM Table Operations Flag	0x40	0=Inactive, 1=Active

A.14 BCRT Control Register Word

The interpretation of the BCRT Control Register word is in Table A-14 "BCRT Register Control Word Interpretation".

Table A-14 BCRT Register Control Word Interpretation

Status	Mask	Possible Values
RT Channel A Select	0x0080	0=OFF, 1=ON
RT Channel B Select	0x0100	0=OFF, 1=ON

A.15 CD Raw A/D Output Data

The interpretation of the CD Raw A/D Output Data word is in Table A-15 "CD Raw A/D Output Data Interpretation".

Table A-15 CD Raw A/D Output Data Interpretation

Flag	Mask	Possible Values
CD Raw A/D Overflow Flag	0x0100	0=No overflow, 1=Overflow
CD Attenuation Settings	0x3E00	1=0.0, 2=1/1.77, 4=1/3.16, 8=1/5.6, 16=1/10

A.16 CD Interrupt Status

The interpretation of the CD Interrupt Status word is in Table A-16 "CD Interrupt Status Interpretation".

Table A-16 CD Interrupt Status Interpretation

Flag	Mask	Possible Values
CD Data Ready Interrupt	0x00000008	0=Enabled, 1=Disabled
CD Interrupt Source	0x00003000	1= Fire Command, 2= fire acknowledge

A.17 DC Interrupt Mask Register

The interpretation of the DC Interrupt Mask Register word is in Table A-17 "DC Interrupt Mask Register Interpretation".

Table A-17 DC Interrupt Mask Register Interpretation

Flag	Mask	Possible Values
DC Interrupt 1	0x00000001	0=Disabled, 1=Enabled
DC LPA Interrupt	0x00000002	0=Disabled, 1=Enabled
DC Output FIFO Full Interrupt	0x00000004	0=Disabled, 1=Enabled
DC Output FIFO Empty Interrupt	0x00000008	0=Disabled, 1=Enabled
DC RAM Busy Interrupt	0x00000010	0=Disabled, 1=Enabled
DC Interrupt 6	0x00000020	0=Disabled, 1=Enabled

A.18 DC FIFO Flags Register

The interpretation of the DC FIFO Flags Register is in Table A-18 "DC FIFO Flags Register Interpretation".

A.19 DC LPA Gain Register

The interpretation of the DC LPA Gain Register is in Table A-19 "DC LPA Gain Register Interpretation" on page -43.

Table A-18 DC FIFO Flags Register Interpretation

Flag	Mask	Possible Values
DC FIFO Full	0x00000001	0=True, 1=False
DC FIFO Almost Full	0x00000004	0=True, 1=False
DC FIFO Almost Empty	0x00000002	0=True, 1=False
DC FIFO Empty	0x00000008	0=True, 1=False

Table A-19 DC LPA Gain Register Interpretation

Flag	Mask	Possible Values
DC LPA Gain	0x00000007	0=4.00, 1=2.80, 2=2.15, 3=1.75, 4=1.47, 5=1.27, 6=1.12, 7=1.00
DC LPA Reset	0x00000008	0=In Reset, 1=Not in Reset

A.20 DC LPA Packet Count Register

The interpretation of the DC LPA Packet Count Register is in Table A-20 "DC LPA Packet Count Register Interpretation".

Table A-20 DC LPA Packet Count Register Interpretation

Flag	Mask	Possible Values
DC LPA Frame Byte Count	0x00003FFF	counter
DC LPA Packet (Frame) Count	0x00FF0000	counter

A.21 PC Hardware Mode Status

The interpretation of the PC Hardware Mode Status word is in Table A-21 "PC Hardware Mode Status Interpretation".

Table A-21 PC Hardware Mode Status Interpretation

Flag	Mask	Possible Values
PC Board Hardware Mode	0x00000007	1=Idle, 2=Engineering, 4=Science
PC Interrupt Source	0x00003000	1=Fire Command, 2=Fire Acknowledge
PC Measurement Source	0x00004000	0=Fire Acknowledge, 1=Fire Command

A.22 MD Enable / Disable Flag

The interpretation of the MD Enable/Disable Flag word is in Table A-22 "MD Enable /Disable Flag Interpretation".

Table A-22 MD Enable /Disable Flag Interpretation

Flag	Mask	Possible Values
MD Global Enable/Disable Flag	0x001	0=Disabled 1=Enabled
MD Table 1 Enable/Disable Flag	0x002	0=Disabled 1=Enabled
MD Table 2 Enable/Disable Flag	0x004	0=Disabled 1=Enabled

A.23 CT Suppressed Event Message Error Flag

The interpretation of the CT Suppressed Event Message Error Flag word is in Table A-23 "CT Suppressed Event Message Error Flag Interpretation".

Table A-23 CT Suppressed Event Message Error Flag Interpretation

Flag	Mask	Possible Values
CT Event Messages Enabled/Disabled Flag	0x0001	0=All Enabled 1=Some Disabled
CT Shot Count Error Flag	0x0002	0=OK 1=Error
CT Laser Monitor Board Mux Error Flag	0x0004	0=OK 1=Error
CT Housekeeping Board Mux Error Flag	0x0008	0=OK 1=Error
CT Housekeeping Board Submux Error Flag	0x0010	0=OK 1=Error
CT Temperature Controller Board Mux Error Flag	0x0020	0=OK 1=Error
CT Mechanism Controller Board Mux Error Flag	0x0040	0=OK 1=Error
CT Power Distribution Unit Mux Error Flag	0x0080	0=OK 1=Error

Table A-23 CT Suppressed Event Message Error Flag Interpretation (Continued)

Flag	Mask	Possible Values
CT High Voltage Power Supply Mux Error Flag	0x0100	0=OK 1=Error
CT Ancillary Packet Allocation Error FlagMD Global Enable/Disable Flag	0x0200	0=OK 1=Error

A.24 CT Loop Heat Pipe Control State

The interpretation of the CT Loop Heat Pipe (LHP) Control State words for LHP 1 and LHP 2 is in Table A-24 "CT LHP Control State Interpretation".

Table A-24 CT LHP Control State Interpretation

Flag	Mask	Possible Values
CT LHP Temperature Control Enabled Flag	0x0001	0=Off 1=On
CT LHP Temperature Control Active Flag	0x0002	0=Idle 1=Active

A.25 GP Task Status Bits

The interpretation of the GP Task Status Bits word is in Table A-25 "GP Task Status Bits Interpretation".

Table A-25 GP Task Status Bits Interpretation

Flag	Mask	Possible Values
Position Data Source	0x0003	0= spacecraft 1=Ground Hmin/Hmax 2=Ground Rmin/Rmax
Position Data Status Flag	0x000C	0=OK 1=No data 2=Calculation Error
GPS Pulse Received Flag	0x0010	0=Not Receiving Pulse 1=Receiving Pulse
GPS Pulse Select	0x0020	0=GPS1 1=GPS2

A.26 AD Software Enable Flags

The interpretation of the AD Software Enable Flags is in Table A-26 "AD Software Enable Flag Interpretation".

Table A-26 AD Software Enable Flag Interpretation

Flag	Mask	Possible Values
AD Auto Reset DSP Flag	0x0001	0=False, 1=True
AD Auto Gain Use 8ns Filter Flag	0x0010	0=Disabled, 1=Enabled
AD Auto Gain Enable Flag	0x0020	0=Disabled, 1=Enabled
AD Hardware Error Events Flag	0x0040	0=Disabled, 1=Enabled
AD Software Error Events Flag	0x0080	0=Disabled, 1=Enabled

A.27 AD DSP Trouble Indicator Status Word

The interpretation of the AD DSP Trouble Indicator Status word is in Table A-27 "AD DSP Trouble Indicator Status Word Interpretation".

Table A-27 AD DSP Trouble Indicator Status Word Interpretation

Flag	Mask	Possible Values
Invalid Search	0x0001	0=No problem 1=Invalid search
Laser Failure	0x0002	0=No problem 1=Laser Failure
Multiple Interrupts	0x0004	0=No problem 1=Multiple Interrupts
Buffer Full	0x0008	0=No problem 1=Buffer Ful
Invalid Mode	0x0010	0=No problem 1=Invalid Mode
Infinite Loop	0x0020	0=No problem 1=Infinite Loop
Invalid Range Window	0x0040	0=No problem 1=Invalid Range Window
Invalid Tournament	0x0080	0=No problem 1=Invalid Tournament
Noise Region Outside Acq Memory	0x0100	0=No problem 1=Noise Region Outside Acq Memory
Invalid Sample Size for Noise region	0x0200	0=No problem 1=Invalid Sample Size for Noise region

A.28 DEM Minimum and Maximum Bytes

The DEM Minimum (Min) and Maximum (Max) bytes are converted to Hmin and Hmax in meters by masking off bit 7 and multiplying the result by 125. Bit 7 of the DEM Min and Max bytes is the DEM surface type indicator. Bit 7 of the DEM Min byte indicates the surface is land (=1) or sea (=0). Bit 7 of the DEM Max byte indicates the surface is ice (=1) or no ice (=0). Bit 7 is the most significant bit.

A.29 Range Window Status

The interpretation of the Range Window Status word is in Table A-28 "Range Window Status Interpretation" on page -48.

Table A-28 Range Window Status Interpretation

Flag	Mask	Possible Values
No first crossing (rising edge) found on 4ns filter	0x00000001	0=False, 1=True
No first crossing (rising edge) found on 8ns filter	0x00000002	0=False, 1=True
No first crossing (rising edge) found on 16ns filter	0x00000004	0=False, 1=True
No first crossing (rising edge) found on 32ns filter	0x00000008	0=False, 1=True
No first crossing (rising edge) found on 64ns filter	0x00000010	0=False, 1=True
No first crossing (rising edge) found on 128ns filter	0x00000020	0=False, 1=True
No second crossing (falling edge) found on 4ns filter	0x00000040	0=False, 1=True
No second crossing (falling edge) found on 8ns filter	0x00000080	0=False, 1=True
No second crossing (falling edge) found on 16ns filter	0x00000100	0=False, 1=True
No second crossing (falling edge) found on 32ns filter	0x00000200	0=False, 1=True
No second crossing (falling edge) found on 64ns filter	0x00000400	0=False, 1=True
No second crossing (falling edge) found on 128ns filter	0x00000800	0=False, 1=True
First sample in range >= threshold for 4ns filter	0x00001000	0=False, 1=True
First sample in range >= threshold for 8ns filter	0x00002000	0=False, 1=True
First sample in range >= threshold for 16ns filter	0x00004000	0=False, 1=True
First sample in range >= threshold for 32ns filter	0x00008000	0=False, 1=True
First sample in range >= threshold for 64ns filter	0x00010000	0=False, 1=True
First sample in range >= threshold for 128ns filter	0x00020000	0=False, 1=True
All filters were rejected flag. True if bits 0 - 5 are true.	0x00040000	0=False, 1=True
No filters were ever selected; all previous selections failed. (Happens on DSP reset.)	0x00080000	0=False, at least one previous selection succeeded, 1=True

Table A-28 Range Window Status Interpretation

Flag	Mask	Possible Values
4ns filter failed	0x00100000	0=False, 1=True
8ns filter failed	0x00200000	0=False, 1=True
16ns filter failed	0x00400000	0=False, 1=True
32ns filter failed	0x00800000	0=False, 1=True
64ns filter failed	0x01000000	0=False, 1=True
128ns filter failed	0x02000000	0=False, 1=True
Return range is invalid	0x40000000	0=Range OK, 1=Failure
Science processing is incomplete	0x80000000	0=Ready, 1=Failure

A.30 AD Target Status and Mode Flags

The interpretation of the AD Target Status and Mode Flag word is in Table A-29 "AD Target Status and Mode Flag Word Interpretation".

Table A-29 AD Target Status and Mode Flag Word Interpretation

Flag	Mask	Possible Values
AD Target Present Flag	0x80	0=Not Present, 1=Target Present
AD Target Timeout Flag	0x40	0=No Timeout, 1=Timeout
AD Mode of Operations	0x38	0=Idle, 1=Science, 2=OneShot, 3=Load, 4=Dump
AD DSP Software Mode	0x07	0=Science, 1=Idle, 2=Load, 3=Dump

A.31 Etalon Flags

The interpretation of the Etalon Status Flags word is in Table A-30 "Etalon Flags Word Interpretation".

Table A-30 Etalon Flags Word Interpretation

Flag	Mask	Possible Values
Etalon Tracking Low Transmission Flag	0x01	0=Good, 1=Low
Etalon Tracking Active Flag	0x02	0=Paused, 1=Active
Etalon Tracking Test Mode Flag	0x04	0=Normal, 1=Test
Etalon Tracking Openloop Mode Flag	0x08	0=Normal, 1=Openloop
Etalon Tracking Openloop Update Toggle	0x10	

A.32 Time Tagging Algorithm

A.32.1 Definitions

The GLAS time tag on all products is the time in seconds from noon January 1, 2000 in Universal Time Code reference frame (includes leap seconds).

The GPS time in the packets received from the Backjack GPS flight receiver is time in seconds from the start of GPS time (January 1980). GPS time is continuous and does not include leap seconds. GPS ticks are always on integer seconds.

The GPS to UTC offset is a constant that shall be defined as the GPS time of Noon January 1, 2000 (the UTC reference time). This constant will be negative because it used to remove from the laser shot GPS time the amount of GPS time occurring from the GPS time reference time (January 1, 1980) to the UTC reference time.

A.32.2 Basic Algorithm with GPS

1) Determine the current leapsecond correction to use from the GPS to UTC Leapseconds File.

2) Compute the laser shot time in UTC:

- a) Find the largest GLAS GPS latch time (to the .1 Hz GPS pulse) from the frequency and time board (accounting for roll over) less then the first Fire Command Time of packet (note: both times are 40 bit counters found in GLAS APID 19).
- b) Until the first Fire Command Time of the packet is greater than the next GLAS GPS latch time compute the laser shot time in GPS. There is a delay between the fire command time and the start of digitization. This delay must be applied to the fire command time to get the correct laser shot time. Also the time from the start of the digitization to the time of the transmit pulse peak must be included in the algorithm to get to the time of the laser shot. Since the 1 Gigahertz oscillator does not operate perfectly the oscillator frequency must be computed and applied to the 40 bit counter time. Compute the laser shot time in GPS units by the equation:

$$\text{Laser Shot Time in GPS} = \{[(\text{Fire Command Time} - \text{GLAS GPS latchtime}) * \text{freqbrdscale}] + \text{time of transmit pulse peak}\} * \text{oscillator frequency} + \text{GPS time} + \text{digitizer delay}$$

Where freqbrdscale is the oscillator frequency scale factor to convert counts to seconds. The GPS time in GPS seconds is contained in the spacecraft time and position packet which is downlinked in GLAS APID 19. The format of the spacecraft time and position packet is contained in Appendix C. The digitizer delay and oscillator frequency are provided by the GLAS instrument operations team. The time of the transmit peak is provided in the GLAS waveform data (APIDs 12 and 13).

[Note: any 40 bit counter time from the GLAS frequency and time board can be converted by using the largest GLAS GPS latch time less then the 40 bit counter by the following equation:

$$40 \text{ bit counter time in GPS} = [(40 \text{ bit counter} - \text{GLAS GPS latch time}) * \text{freqbrdscale}] * \text{oscillator frequency} + \text{GPS time}$$

- c) For each shot, determine the correct leapsecond correction to use from the GPS to UTC Leapsecond File. Compute the laser shot time in UTC by the following equation:

$$\text{Laser Shot Time in UTC} = \text{Laser Shot Time in GPS} + \text{Leapseconds} + \text{GPStoUTCOffset}$$

Where, Leapseconds is the correction from the GPS to UTC Leapseconds File and GPStoUTCOffset is the offset from the GPS reference time to the UTC reference time.

3) Convert spacecraft time (Bvtcw) to UTC:

- a) Correct for the delay in the reported Bvtcw latched to the GPS .1 Hz pulse and the actual Bvtcw latched to the GPS .1 Hz pulse. The Bvtcw GPS latch time is reported in the spacecraft time and position packet contained in GLAS APID 19. To compute the corrected Bvtcw GPS latch time add a spacecraft time calibration offset (Btimeoffset):

$$\text{Corrected Bvtcw GPS latch time} = \text{Bvtcw GPS latch time} + \text{Btimeoffset}$$

- b) The Corrected Bvtcw GPS latch time corresponds directly to the GPS time in UTC that is in the spacecraft time and position packet.
- c) Any spacecraft time (Bvtcw) can be converted to UTC by using the largest Bvtcw GPS latch time less then the Bvtcw by the following equation:

$$\text{Bvtcw in UTC} = (\text{Bvtcw} - \text{Corrected Bvtcw GPS latch time}) * \text{BvtcwScale} + \text{GPS time in UTC}$$

where BvtcwScale is from the Bvtcw to UTC table.

4) Compute Laser Reference System (LRS) Time Tags:

- a) Compute the estimated 10 Hz LRS time of the GLAS laser fire command in UTC using the LRS Bvtcw, the LRS increment time tag, and the GPS time. The LRS increment time tag is latched upon the detection of a GLAS fire command signal and provides the precise timing of the LRS data. The LRS Bvtcw and increment time tag are in the spacecraft's Position, Rate, and Attitude Packet (PRAP). The equation is:

$$\text{estimated LRS fire command time tag in UTC} = (\text{LRS Bvtcw} - \text{Corrected Bvtcw GPS latch time}) * \text{BvtcwScale} + \text{GPS time in UTC} + \text{LRS increment time tag}$$

- b) Apply the delay from the recording of the time of the LRS 10 Hz data to the actual time of the 10 Hz data to get the corrected LRS fire command time. The delay (Lrs_bvtcw_delay) is constant. The equation is:

$$\text{corrected LRS fire command time in UTC} = \text{estimated LRS fire command time in UTC} + \text{Lrs_bvtcw_delay}$$

- c) Compute the actual 10 Hz LRS time of the GLAS laser fire command time. Find the nearest (within 12.5 millisecond) actual laser fire command time to the corrected LRS fire command time tag. The time of the LRS 10 Hz sample is the laser fire command time and the LRS Center of Integration (COI) time. The LRS COI time is found in the spacecraft's Position, Rate, and Attitude Packet (PRAP). The equation is:

LRS sample time in UTC = actual laser fire command time + LRS COI time

- d) Determine the corresponding GLAS laser shots for the LRS 10Hz data. Find the Laser Shot Time in UTC that is within 12.5 milliseconds of the LRS sample time in UTC for each LRS sample. Assign the LRS sample this shot number and time. Keep all times with the record.
- e) The LRS health data shall be assigned the shot and time of the first 10 Hz sample.
- f) The LRS star, laser, and Collimated Reference Source (CRS) images correspond to the shot and time for matching frame numbers of the LRS data samples.

5) Convert Instrument Star Tracker (IST) time tags to UTC:

- a) Compute the estimated 10 Hz IST time of the GLAS laser fire command in UTC using the IST Bvtcw, the IST increment time tag, and the GPS time. The IST increment time tag is latched upon the detection of a GLAS fire command signal and provides the precise timing of the IST data. The IST Bvtcw and increment time tag are in the spacecraft's Position, Rate, and Attitude Packet (PRAP). The equation is:

$$\text{estimated IST fire command time tag in UTC} = (\text{IST Bvtcw} - \text{Corrected Bvtcw GPS latch time}) * \text{BvtcwScale} + \text{GPS time in UTC} + \text{IST increment time tag} * \text{IST time scale}$$

- b) Apply the delay from the recording of the time of the IST 10 Hz data to the actual time of the 10 Hz data to get the corrected IST fire command time. The delay (Ist_bvtcw_delay) is constant. The equation is:

$$\text{corrected IST fire command time in UTC} = \text{estimated IST fire command time in UTC} + \text{Ist_bvtcw_delay}$$

- c) Compute the actual 10 Hz IST time of the GLAS laser fire command time. Find the nearest (within 12.5 millisecond) actual laser fire command time to the corrected IST fire command time tag. The time of the IST 10 Hz sample is the laser fire command time and the IST Center of Integration (COI) time. The IST COI time is found in the spacecraft's Position, Rate, and Attitude Packet (PRAP). The equation is:

$$\text{IST sample time in UTC} = \text{actual laser fire command time} + \text{IST COI time}$$

- d) Determine the corresponding GLAS laser shots for the IST 10Hz data. Find the Laser Shot Time in UTC that is within 12.5 milliseconds of the IST sample time in UTC for each IST sample. Assign the IST sample this shot number and time. Keep all times with the record.

6) Convert the 10 Hz IRU time tags to UTC by the method in step 3 above. The IRU Bvtcw is in the spacecraft's PRAP. Additionally, the IRU BVTWCW needs to be adjusted by the delay from the recording of the time of the IRU 10 Hz data to the actual time of the 10 Hz data. The delay (G_bvtcw_delay) is constant. The equation is:

$$\text{IRU Bvtcw in UTC} = (\text{IRU Bvtcw} - \text{Corrected Bvtcw GPS latch time}) * \text{BvtcwScale} + \text{G_bvtcw_delay} + \text{GPS time in UTC}$$

7) Convert the Ball Star Tracker (BST) time tags to UTC by the method in step 3 above. There

are two BSTs on the ICESat spacecraft. The BST1 and BST2 Bvtcw are in the spacecraft's PRAP. Additionally, the BST BVTWCW needs to be adjusted by the delay from the recording of the time of the BST 10 Hz data to the actual time of the 10 Hz data. Each BST has its own delay (B_bvtcw_delay) and the delays are constant. The equation is:

$$\text{BST Bvtcw in UTC} = (\text{BST Bvtcw} - \text{Corrected Bvtcw GPS latch time}) * \text{BvtcwScale} + \text{B_bvtcw_delay} + \text{GPS time in UTC}$$

8) Convert the spacecraft quaternion data time tags to UTC by the method in step 3 above. The quaternion data is time tagged by the ADCS Bvtcw found in the PRAP. The ADCS Bvtcw needs to be adjusted by the delay from the recording of the time of the PRAP to the actual time of the quaternion data. The delay (Q_bvtcw_delay) is constant. The equation is:

$$\text{Quaternion Data Bvtcw in UTC} = (\text{ADCS Bvtcw} - \text{Corrected Bvtcw GPS latch time}) * \text{BvtcwScale} + \text{Q_bvtcw_delay} + \text{GPS time in UTC}$$

9) The IRU and BST data will not be shot aligned to the GLAS data. Assign to the IRU and BST data the first laser shot time in UTC from the GLAS APID 19 that corresponds to that data.

10) If the GLAS APID 19 is missing, estimate the shot time for events by using the secondary header time from the Altimeter Digitizer science packet (GLAS APID 12 or 13 depending on the surface type). The secondary header time must be corrected such that it corresponds to the time of the first laser shot in the packet. For most of the GLAS packets, the secondary header time corresponds to the last shot in the packet. The nominal time between shots is 25 milliseconds. Use the following equation to estimate the time of a shot:

$$\text{Estimated Laser Shot Time in UTC} = (\text{estimated shot number} - 1) * 25 \text{ ms} * \text{freqbrdscale} + \text{Secondary header time corresponding to the first shot in the packet}$$

A.32.3 Basic Algorithm without GPS

1) Compute the LRS 10Hz sample time tags.

- a) Compute the time of each 10hz LRS Data pulse in UTC. The LRS data is contained in the spacecraft's PRAP. Convert the LRS Bvtcw (VTCW echo) to UTC using the Bvtcw to UTC table. The LRS Bvtcw must be corrected by the increment (LRS increment time tag) to the GLAS 10 Hz pulse to get the correct time of the latch. Additionally, the LRS BVTWCW needs to be adjusted by the delay from the recording of the time of the LRS 10 Hz data to the actual time of the 10 Hz data. The delay (Lrs_bvtcw_delay) is constant. The equation is for each pulse:

$$\text{LRS data pulse time in UTC} = (\text{LRS Bvtcw} - \text{Bvtcw from table}) * \text{BvtcwScale} + \text{Bvtcw from table in UTC} + \text{LRS increment time tag} * \text{LRS Time scale} + \text{Lrs_bvtcw_delay}$$

Where 'Bvtcw from table' is the largest Bvtcw in the Bvtcw to UTC table just less than the Bvtcw being converted and BvtcwScale is from the Bvtcw to UTC table.

- b) The time of the LRS 10 Hz sample is the sum of the LRS data pulse time tag and the LRS Center of Integration (COI) time. The LRS COI time is found in the spacecraft's Position, Rate, and Attitude Packet (PRAP). The equation is:

$$\text{LRS sample time in UTC} = \text{LRS data pulse time in UTC} + \text{LRS COI time}$$

2) Convert GLAS Mission Elapsed Time (MET) of spacecraft time and position packet (position and command packet) to UTC using the GLAS MET to UTC conversion table. The GLAS MET of the spacecraft time and position packet is in GLAS APID 19.

3) Compute the estimated fire command time in UTC for 40 shots. Use the fire command time (40 bit counter) of the shot corresponding to the spacecraft time and position packet as the reference point. Since the 1 Gigahertz oscillator is not perfect, the oscillator frequency must be computed and applied to the 40 bit counter data. For each shot the equation is:

$$\begin{aligned} \text{Estimated fire command time of shot in UTC} = & [(\text{fire command time of shot} - \text{fire} \\ & \text{command time of time and position packet}) * \text{freqbrdscale}] * \\ & \text{oscillator frequency} + \text{GLAS MET of time and position packet in UTC} \end{aligned}$$

Where freqbrdscale is the oscillator frequency scale factor that converts the counts to seconds. The oscillator frequency is provided by the GLAS instrument operations team.

[Note: Must take care of rollover of shot and fire command time counters]

4) Time align fire command times in UTC to LRS 10 Hz Data pulse times (prior to LRS COI time being applied).

- a) Compare estimated fire command times in UTC to the LRS data pulse time in UTC for each pulse. Align a laser shot to an LRS sample when the difference between the times are within a predetermined range of milliseconds. To start the range will be -9 to 24 milliseconds.
- b) Check that the shot numbers corresponding to the LRS samples increment by 4 and the LRS data pulse time in UTC increments by about 100 ms. Set error flag if these conditions are not met.

5) Compute the estimated laser shot time in UTC by referencing to the closest matched laser shot/LRS sample pair. The digitizer delay (delay between the fire command time and the start of digitization) and the time from the start of digitization to the transmit pulse peak must be applied. The digitizer delay is provided by the GLAS Instrument Operations team and the time of the transmit pulse peak is contained in the GLAS Altimeter Digitizer packets. The oscillator frequency must also be applied. For each shot:

$$\begin{aligned} \text{Corrected laser shot time in UTC} = & \{[(\text{fire command time of shot} - \\ & \text{fire command time of first match}) * \text{freqbrdscale}] + \text{transmit pulse peak}\} * \\ & \text{oscillator frequency} + \text{LRS data pulse time in UTC of match} + \text{digitizer delay} \end{aligned}$$

[Note: Must take care of rollover of shot and fire command time counters.]

6) Determine the corresponding GLAS laser shots for the LRS 10 Hz data and LRS star, laser, and CRS images by the same method used in "Basic Algorithm with GPS", Appendix A.32.2 steps 4.d, 4.e, and 4.f.

7) Compute the 10 Hz IST Data sample times in UTC. The IST data is contained in the spacecraft's PRAP.

- a) Convert the IST Bvtcw (VTCW echo) to UTC using the Bvtcw to UTC table. The IST Bvtcw must be corrected by the increment (IST increment time tag) to the GLAS 10 Hz pulse to get the correct time of the sample. Additionally, the IST BVTWCW needs to be adjusted by the delay from the recording of the time of the IST 10 Hz data to the actual time of the 10 Hz data and the IST Center of Integration (COI) time. The delay (Ist_bvtcw_delay) is constant. The IST COI time is found in the spacecraft's Position, Rate, and Attitude Packet (PRAP). The equation is for each sample:

$$\text{IST data sample times in UTC} = (\text{IST Bvtcw} - \text{Bvtcw from table}) * \text{BvtcwScale} + \text{Bvtcw from table in UTC} + \text{IST time tag} * \text{IST time scale} + \text{Ist_bvtcw_delay} + \text{IST COI time}$$

Where Bvtcw from table is the largest Bvtcw in the Bvtcw to UTC table just less than the Bvtcw being converted and BvtcwScale is from the Bvtcw to UTC table.

- b) Determine the corresponding GLAS laser shots for the IST 10 Hz data by the same method used in "Basic Algorithm with GPS", Appendix A.32.2 step 5.d.

8) Convert IRU Bvtcw to UTC using the Bvtcw to UTC table. Additionally, the IRU BVTWCW needs to be adjusted by the delay from the recording of the time of the IRU 10 Hz data to the actual time of the 10 Hz data. The delay (G_bvtcw_delay) is constant. The equation is:

$$\text{IRU Bvtcw in UTC} = (\text{IRU Bvtcw} - \text{Bvtcw from table}) * \text{BvtcwScale} + \text{G_bvtcw_delay} + \text{Bvtcw from table in UTC}$$

Where Bvtcw from table is the largest Bvtcw in the Bvtcw to UTC table just less than the Bvtcw being converted and BvtcwScale is from the Bvtcw to UTC table.

9) Convert BST Bvtcw to UTC using the Bvtcw to UTC table. Additionally, the BST BVTWCW needs to be adjusted by the delay from the recording of the time of the BST 10 Hz data to the actual time of the 10 Hz data. Each BST has its own delay (B_bvtcw_delay) and the delays are constant.:

$$\text{BST Bvtcw in UTC} = (\text{BST Bvtcw} - \text{Bvtcw from table}) * \text{BvtcwScale} + \text{B_bvtcw_delay} + \text{Bvtcw from table in UTC}$$

Where Bvtcw from table is the largest Bvtcw in the Bvtcw to UTC table just less than the Bvtcw being converted and BvtcwScale is from the Bvtcw to UTC table.

10) Convert spacecraft's quaternion data Bvtcw to UTC using the Bvtcw to UTC table. The quaternion data is time tagged by the Bvtcw from the spacecraft's PRAP secondary header. Additionally, the PRAP secondary header time (Bvtcw) needs to be adjusted by the delay from the recording of the time of the PRAP to the actual time of the quaternion data. The delay (Q_bvtcw_delay) is constant. The equation is:

$$\text{Quaternion Data Bvtcw in UTC} = (\text{PRAP Bvtcw} - \text{Bvtcw from table}) * \text{BvtcwScale} + \text{Q_bvtcw_delay} + \text{Bvtcw from table in UTC}$$

Where Bvtcw from table is the largest Bvtcw in the Bvtcw to UTC table just less than the Bvtcw being converted and BvtcwScale is from the Bvtcw to UTC table.

- 11) The IRU and BST data will not be shot aligned to the GLAS data. Assign to the IRU and BST data the first laser shot time in UTC from the GLAS APID 19 that corresponds to that data.
- 12) If the GLAS APID 19 is missing, compute the estimated laser shot time in UTC by the same method used in “Basic Algorithm with GPS”, Appendix A.32.2 step 10.

Appendix B

GLAS Telemetry Description

The format of the GLAS telemetry packets and their engineering unit conversions are defined in the following sections.

Appendix B.1 contains the housekeeping and diagnostic packet descriptions.

Appendix B.2 contains the science packet descriptions.

B.1 GLAS Housekeeping and Diagnostic Telemetry Description

Pkt Name	App Id	Size in bytes in (max)	Pkt Freq. in Hertz	Pkt Interval in seconds	Rate bps	Output to		Confidence	CCSDS Primary Header	Data uses SA Range	Output by Task
						SSR	1553 Bus				
CT HW Tim#1	20	56	0.25	4	112	Yes	No	High	# NAME ?	1	CT
CT HW Tim#2	21	56	0.25	4	112	Yes	No	High	# NAME ?	1	CT
CT HW Tim#3	22	56	0.0625	16	28	Yes	No	High	# NAME ?	1	CT
CT HW Tim#4	23	56	0.0625	16	28	Yes	No	High	# NAME ?	1	CT
CT HW Tim#5	50	56	0.03125	32	14	Yes	No	High	# NAME ?	1	CT
Small Software #1 Tim	24	56	0.25	4	112	Yes	No	High	# NAME ?	1	HS
Large Software Tim #1	25	300	0.25	4	600	Yes	No	High	# NAME ?	3..10	HS
Large Software Tim #2	55	376	0.25	4	752	Yes	No	High	# NAME ?	3..10	HS
DSP Code Memory Dump	31	828	Async ⁽¹⁾			Yes	No	High	# NAME ?	3..10	AD
DSP Data Memory Dump	32	828	Async ⁽¹⁾			Yes	No	High	# NAME ?	3..10	AD
C&T Dwell Packet	33	336	Async ⁽²⁾			Yes	Yes	High	# NAME ?	3..10	CT
Memory Dwell Packet #1	27	212	Async ⁽³⁾			Yes	No	High	# NAME ?	3..10	MD
Memory Dwell Packet #2	28	212	Async ⁽³⁾			Yes	No	High	# NAME ?	3..10	MD
Event Message	34	80	Async			Yes	No	High	# NAME ?	3..10	HS
Memory Dump	35	224	Async ⁽⁴⁾			Yes	No	High	# NAME ?	3..10	SM
Table Dump	36	224	Async ⁽⁵⁾			Yes	No	High	# NAME ?	3..10	SM
Etlon Calibration	37	2076	Async			Yes	No	High	# NAME ?	3..10	CT
GLAS Data Types Packet	48	72	Async			Yes	No	High	# NAME ?	3..10	DC
						Synchronous HK 1553 Bus Data Rate	406		448	bps	
						Synchronous DIAG 1553 Bus Data Rate	1352		11,808	bps	
(1) - These Packets are produced at a 4 pkts per second rate when AD is in Idle mode. (2) - This packet will be output at a 4 second interval when one of the C&T Boards is in dwell mode. (3) - During a Memory Dwell the rate for these packets is commandable. (4) - During memory or table dumps these packets will be output at a max 1 packets per second rate											

Filename: GLAS_HK_PKT.xls

Page 1 of 2

Worksheet: Summary

Notes	Bits	Word	Mask
1- The size of all packets must be a multiple of 4. This is because the SSR FIFO width is 32 bits and all packets go to the SSR			
2- Max Packet Size to SSR is 16 Kbytes. This is the size of the SSR interface FIFO			
3- 1553 Diag channel packets will be output to 1553 Bus interface and continually read by the Bus Controller, but only in GLAS Diagnostics mode (16 kbps) will they be telemetered to the Ground			
4- Mnemonics use only 'G' as prefix to indicate GLAS (instead of the GL)			
5- Mnemonics for the CCSDS header are not in spreadsheet, but			
Suggested Mnemonic names	Bits	Word	Mask
GPxxxPVNO	0..2	1st	0xE000
GPxxxPKT	3	1st	0x1000
GPxxxSHDF	4	1st	0x0800
GPxxxID	5..15	1st	0x07FF
GPxxxSEGF	0..1	2nd	0xC000
GPxxxSCNT	2..15	2nd	0x3000
GPxxxPLEN	0..15	3rd	0xFFFF
GPxxxSTIME		4th..7th	
where xxx is the app id in hex zero padded			
6- Telemetry Points which are at the same offset and have a mask associated with them indicate that the telemetry point consists of only the bits in the mask			
7- The Shot Counter is always a 8 bit counter, where depicted as an 2 or 4 byte entity there is padding in the upper bytes			

Filename: GLAS_HK_PKTs.xls

Page 2 of 2

Worksheet: Summary

Name	Date	Version	Change Description
			Changed mnemonic GLMOSCT to GLMLTOSCT
			Changed mnemonic GLMNET to GLML1ET
			Moved the 8 telemetry points starting at apid 20 offset 21 to apid 50 starting at offset 27 which are currently spares
			Moved mnemonic GLMOTSLV1 from apid 20 offset 21 to apid 50 offset 27
			Moved mnemonic GLMOTSLV2 from apid 20 offset 22 to apid 50 offset 28
			Moved mnemonic GLMOTSLV3 from apid 20 offset 23 to apid 50 offset 29
			Moved mnemonic GLMOTSLV4 from apid 20 offset 24 to apid 50 offset 30
			Moved mnemonic GLMOTSTC1UB from apid 20 offset 25 to apid 50 offset 31
			Moved mnemonic GLMOTSTC1LB from apid 20 offset 26 to apid 50 offset 32
			Moved mnemonic GLMOTSTC2UB from apid 20 offset 27 to apid 50 offset 33
			Moved mnemonic GLMOTSTC2LB from apid 20 offset 28 to apid 50 offset 34
			Add 8 new mnemonics for laser 2 and laser 3 temperatures (reference, doubler, oscillator and electronics)
			The new mnemonics are GLML2REF, GLML2DBT, GLML2OSCT, GLML2ET, GLML3REF, GLML3DBT, GLML3OSCT and GLML3ET. They have been added to apid 20 starting at offset 21 and they occupy the locations vacated by moved mnemonics
M.Maldonado	07-Dec-00	Rev B	Corrected Polynomial Conversion Factors for the following mnemonics in apid 23, starting at offset 14 GMCHOP1T, GMCHOP2T, GMCHOP3T, GMCVXCT, GMCVYCT, GMCHOP1HTR1, GMCHOP1HTR2, GMCHOP2HTR1, GMCHOP2HTR2, GMCVXCT and GMCVYCT from Volts to MilliAmps and modified conversion factors accordingly
M.Maldonado	14-Dec-00	Rev B	Changed GMCVXOS and GMCVPOS conversion factors to be more precise Added additional voltage and current descriptions to apid 21 mnemonics Added mnemonic GMCCADCPUL to GMCCADCPUL in apid 21 offset 54 Added additional laser monitor description to apid 50 offsets 24, 25 & 26 Changed GCTSTAT to GCTSTAT in apid 24 offset 54 Named a spare byte at apid24 offset 55GCTSPARE1
M.Maldonado	15-Dec-00	Rev B	Changed two discrete conversions from 1=Auto to 1=Normal at apid 24 offset 54, mnemonics GCTSWMODE and GCTHWMODE
M.Maldonado	05-Mar-01	Rev B	Changed mnemonic GCTANPS to GCTANPS in apid 55 offset 336 to be consistent Converted 2 bytes of spares in apid 55 offset 216 into a telemetry point mnemonic GGPBADXZ CCR-120, Changed mnemonics at apid 50 offsets 18 and 19. From GHKHP1T to GHKHP2T and GHKHP2T to GHKHPZCNTRLT
D. Molock S. Siegel P. Kutt	22-Jun-01 27-Jun-01 03-Jul-01	Rev B Rev B Rev B	Updated AD fast and slow telemetry packet to reflect changes made for build 3.3 Updated PC, CD, and DC Fast and Slow Telemetry Packet to reflect changes made for build 3.3 Updated CT fast and slow telemetry packet to reflect changes made for build 3.3 Replaced spare byte in CT fast telemetry with additional status bits for elaton. Replaced 12 spare bytes in CT slow telemetry with status bits for suppressed event messages. Replaced spare bytes in CT slow telemetry with mnemonics for LHP temperature control. Replaced spare byte in CT slow telemetry with status bits for telemetry updates.
K.Naylor M.Maldonado	10-Jul-01 09-Aug-01	Rev B Rev B	Updated the MD comments in the Summary. Added MD telemetry to Large SW #1. Updated MD Packet (27.28) information. Changed telemetry mnemonic from GHKFOLDT to GHKIFOLDT in apid 22 offset 42
J. Polk	26-Jun-02	Rev C	Changed telemetry mnemonic from GHKSPCMT to GHKLIDBOX1 in apid 22 offset 35 Updated "confidence status" of memory dwell packets from low to high, and elaton calibration from low to medium. Removed pseudo equations worksheet, and replaced all references to pseudo telemetry in the "conversion factors" column with the appropriate pseudo telemetry mnemonic. Corrected HVPS mnemonics by removing the "P". E.G., GHVPA0TIV to GHVADTIV Changed definition of GMCH3SPOS and GMCH3SPOS bits from 2="DEPLOYED", 3="STOWED" to 2="DET#2", 3="DET#1" Corrected mnemonics for GMCHOP1T, GMCHOP2T, GMCHOP3T, GMCVXCT, and GMCVYCT to GMCLSM1T, GMCLSM2T, GMCLSM3T, GMCLBSMET, and GMCLBSMMT. Revised TM mnemonics: GTMSMRHTR and GTMSMRTSP, and HK mnemonic GHKSMIRI Updated the order of TM mnemonics: GTMSMRHSEL and GTMSSTHSEL, and HK mnemonics GHKSMIRI and GHKTOWT. Updated polynomial for various mnemonics: GTMTOWTSP, GHKSMIRI, GMCLSM1T, GMCLSM2T, GMCLSM3T, GMCLBSMET, GHKTOWT Replaced single byte (UB) OTS trigger count values with 2 byte (UJ) values. GLMOTSTC1UB, UB with GLMOTSTC1 and GLMOTSTC2UB, UB with GLMOTSTC2. Added GP status bit mask definitions in packet 24, and corrected masks for AD, PC, DC, and CD software/hardware mode flags Added new (for Bld 3.8) Elaton Open-Loop flag (GCTEOLMODE) in the Large SW Tim #1 packet (pkt 25): (a) changed GHSWDISR to GHSCDISR, (b) changed names of unused ISRs to indicate that they are spares, (c) corrected mnemonic for GPS 10 sec ISR count (GHSCPSISR) to GHSCPSISR, (d) corrected mnemonic for "AD Subsystem Present Flag" from GHSDAPF to GHSDAPF, (e) corrected mask for "CS Enabled/Disabled Flag" from 0x01 to 0x03, (f) corrected mask for "SM Table Operations Flag" from 0x3F to 0x3F, (g) corrected "Fire Command Time Increment" mnemonic (changed GT CINCL4/GTCINRU2 to GT CINCL4/GTCINRU2). in the Large SW Tim #2 packet (pkt 55): (a) Increased the size of the CD AD Raw Data and Overflow flag from 2 to 4 bytes and removed the 2 spare bytes, (b) corrected the mask for the "DC Output FIFO Full/Empty Interrupt (the masks were reversed)", (c) Added GDCGAIN values, (d) removed GP status flags and added GGPBADXZCNT, GGPTOLERYZ, and GGPRANGEPKTS, (e) DC FIFO Almost Full/Almost Empty mnemonics were reversed (fixed this). Added mnemonic names in mnemonics column for packets 35 and 36 Changed size of Elaton Calibration packet (on summary page) from 492 to 2076, and added elaton calibration packet to "other pkts" spreadsheet Replaced polynomial conversion factors with pseudo tm mnemonic for the following: GLMOSCT, GLMAMP1, GLMAMP2, GLMAMP3, GLMAMP4, GLMAMP5, GLMAMP6, GLMAMP7, GLMAMP8, GLMAMP9, GLMAMP10, GLMAMP11, GLMAMP12, GLMAMP13, GLMAMP14, GLMAMP15, GLMAMP16, GLMAMP17, GLMAMP18, GLMAMP19, GLMAMP20, GLMAMP21, GLMAMP22, GLMAMP23, GLMAMP24, GLMAMP25, GLMAMP26, GLMAMP27, GLMAMP28, GLMAMP29, GLMAMP30, GLMAMP31, GLMAMP32, GLMAMP33, GLMAMP34, GLMAMP35, GLMAMP36, GLMAMP37, GLMAMP38, GLMAMP39, GLMAMP40, GLMAMP41, GLMAMP42, GLMAMP43, GLMAMP44, GLMAMP45, GLMAMP46, GLMAMP47, GLMAMP48, GLMAMP49, GLMAMP50, GLMAMP51, GLMAMP52, GLMAMP53, GLMAMP54, GLMAMP55, GLMAMP56, GLMAMP57, GLMAMP58, GLMAMP59, GLMAMP60, GLMAMP61, GLMAMP62, GLMAMP63, GLMAMP64, GLMAMP65, GLMAMP66, GLMAMP67, GLMAMP68, GLMAMP69, GLMAMP70, GLMAMP71, GLMAMP72, GLMAMP73, GLMAMP74, GLMAMP75, GLMAMP76, GLMAMP77, GLMAMP78, GLMAMP79, GLMAMP80, GLMAMP81, GLMAMP82, GLMAMP83, GLMAMP84, GLMAMP85, GLMAMP86, GLMAMP87, GLMAMP88, GLMAMP89, GLMAMP90, GLMAMP91, GLMAMP92, GLMAMP93, GLMAMP94, GLMAMP95, GLMAMP96, GLMAMP97, GLMAMP98, GLMAMP99, GLMAMP100.
	24-Sep-02		

Worksheet: Change History

Page 2 of 2

Filename: GLAS_HK_PK15.xls

Pkt Name App Id	CT HW TLM #1 20	Idx	Size in Octets	Mnemonics	Frequency Interval	Size 4,000	56 0.250 Hz	Octets Hz	Conversion Factors	Units
0	Primary Header		6							
6	Secondary Header (time stamp)		8					Time when packet is sent		
14	Laser 1 Reference Temperature	1	1	GLML1REFT				Pseudo Mnemonic GLML1REFTP		Counts
15	Laser 1 Doubler Temperature	2	1	GLML1DBT				Pseudo Mnemonic GLML1DBTP		Counts
16	Laser 1 Oscillator Temperature	3	1	GLML1OSCT				Pseudo Mnemonic GLML1OSCTP		Counts
17	Laser 1 Electronics Temperature	4	1	GLML1ET				Pseudo Mnemonic GLML1ETP		Counts
18	Laser Osc Current	6	1	GLMOSCI				Pseudo Mnemonic GLMOSCCDI		Counts
19	Laser Amp Current	7	1	GLMAMPI				Pseudo Mnemonic GLMAMPDCDI		Counts
20	Laser Dr Pulse Width	8	1	GLMDRPPW				POLY=(-131.08,0.512)		pulse width in usec
21	Laser 2 Reference Temperature	24	1	GLML2REFT				Pseudo Mnemonic GLML2REFTP		Counts
22	Laser 2 Doubler Temperature	25	1	GLML2DBT				Pseudo Mnemonic GLML2DBTP		Counts
23	Laser 2 Oscillator Temperature	26	1	GLML2OSCT				Pseudo Mnemonic GLML2OSCTP		Counts
24	Laser 2 Electronics Temperature	27	1	GLML2ET				Pseudo Mnemonic GLML2ETP		Counts
25	Laser 3 Reference Temperature	28	1	GLML3REFT				Pseudo Mnemonic GLML3REFTP		Counts
26	Laser 3 Doubler Temperature	29	1	GLML3DBT				Pseudo Mnemonic GLML3DBTP		Counts
27	Laser 3 Oscillator Temperature	30	1	GLML3OSCT				Pseudo Mnemonic GLML3OSCTP		Counts
28	Laser 3 Electronics Temperature	31	1	GLML3ET				Pseudo Mnemonic GLML3ETP		Counts
29	AD Detector Outgoing Gain readback	17	1	GLMADTOGGN				POLY=(-1,0.0078125)		Volts
30	AD Detector Return Gain readback	18	1	GLMADRTNGN				POLY=(-1,0.0078125)		Volts
31	Laser 1 Enable/Disable Status	19	1	GLML1ENST	0x01			0=ENABLED, 1=DISABLED		Volts
31	Laser 2 Enable/Disable Status	19	1	GLML2ENST	0x02			0=ENABLED, 1=DISABLED		Volts
31	Laser 3 Enable/Disable Status	19	1	GLML3ENST	0x04			0=ENABLED, 1=DISABLED		Volts
31	OTS Enable/Disable Status	19	1	GLMOTSENST	0x08			0=ENABLED, 1=DISABLED		Volts
31	Laser and OTS Enable readbacks	19	1	GLMLOTSENRB	0xFF					Volts
32	Dual Pin -A		1	GLMPINA				Pseudo Mnemonic GLMPPINACD		Counts
33	Dual Pin -B		1	GLMPINB				Pseudo Mnemonic GLMPPINBCD		Counts
34	532 Energy		1	GLM532NRG				Pseudo Mnemonic GLMP532NRGCD		Counts
35	Primary Altimeter Detector 550 V	1	1	GHVADT1V				POLY=(0.0, 3.581)		Volts
36	Secondary Altimeter Detector 550 V	2	1	GHVADT2V				POLY=(0.0, 3.581)		Volts
37	SPCM Detector #1 550 V	3	1	GHVSPCM1V				POLY=(0.0, 3.581)		Volts
38	SPCM Detector #2 550 V	4	1	GHVSPCM2V				POLY=(0.0, 3.581)		Volts
39	SPCM Detector #3 550 V	5	1	GHVSPCM3V				POLY=(0.0, 3.581)		Volts
40	SPCM Detector #4 550 V	6	1	GHVSPCM4V				POLY=(0.0, 3.581)		Volts
41	SPCM Detector #5 550 V	7	1	GHVSPCM5V				POLY=(0.0, 3.581)		Volts
42	SPCM Detector #6 550 V	8	1	GHVSPCM6V				POLY=(0.0, 3.581)		Volts
43	SPCM Detector #7 550 V	9	1	GHVSPCM7V				POLY=(0.0, 3.581)		Volts
44	SPCM Detector #8 550 V	10	1	GHVSPCM8V				POLY=(0.0, 3.581)		Volts
45	Internal Temp #1	11	1	GHVIN1T				POLY=(-.50, 0.781)		Deg C
46	Internal Temp #2	12	1	GHVIN2T				POLY=(9.0, 0.031)		Deg C
47	Internal Temp #3	13	1	GHVIN3T				POLY=(-50.0, 0.781)		Deg C

Pkt Name	App Id	Offset in Octets	Name	idx	Size in Octets	Mnemonics	Frequency Interval	Size	56 Octets	Octets	Conversion Factors	Units
	20							0.250	Hz			
								4.000	seconds			
								Mask	Description			
48			Voice Coil X Motor Current	7	2	GMCVCMTRI			MCS		POLY=(-100, 0.048828125)	milli Amps
50			Voice Coil Y Motor Current	8	2	GMCVCMTRI			MCS		POLY=(-100, 0.048828125)	milli Amps
52			Mirror X Position	9	2	GMCXPOS			MCS		POLY=(-10, 0.0048828125)	Volts
54			Mirror Y Position	10	2	GMCYPOS			MCS		POLY=(-10, 0.0048828125)	Volts

Worksheet : CT HW TLM #1

Page 2 of 2

Filename: GLAS_HK_PKT.xls

Pkt Name	CT HW TLM #2	idx	Size in Octets	Mnemonics	Frequency Interval	Size 56 Hz	Octets Hz	Conversion Factors	Units
App Id	21		6		0.250	4.000	seconds		
Offset in Octets	Name		Octets			Ident.#	Description		
0	Primary Header		6			Mask			
6	Secondary Header(time stamp)		8				Time when packet is sent		
14	Primary Monitor Calibration, Upper Byte	0	1	GPDMON1CALLB			PDU	Pseudo Mnemonic SLOPE1	Counts
15	Primary Monitor Calibration, Lower Byte	1	1	GPDMON1CALLB			PDU	Pseudo Mnemonic INTERCEPT1	Counts
16	+28V Bus A Instrument Voltage	2	1	GPDBAP28V			PDU	Pseudo Mnemonic GPDPBAP28V	Counts
17	Hybrid Supplies Current	3	1	GDPHYPSI			PDU	Pseudo Mnemonic GPDPHYPSI	Counts
18	HVPS Detector Supplies Current	4	1	GPDPHTVI			PDU	Pseudo Mnemonic GPDPDPHTVI	Counts
19	Operational Heaters Current	5	1	GPDPHTTRI			PDU	Pseudo Mnemonic SLOPE2	Counts
20	Mechanical System Current	6	1	GPDMSI			PDU	Pseudo Mnemonic INTERCEPT2	Counts
21	+28V Bus B Laser 1 Voltage	7	1	GPDBBL1P28V			PDU	Pseudo Mnemonic SLOPE1	Counts
22	+28V Bus B Laser 1 Current	8	1	GPDBBL1P28I			PDU	Pseudo Mnemonic SLOPE2	Counts
23	+28V Bus C Laser 2 Voltage	9	1	GPDBCL2P28V			PDU	Pseudo Mnemonic SLOPE1	Counts
24	+28V Bus C Laser 2 Current	10	1	GPDBCL2P28I			PDU	Pseudo Mnemonic SLOPE2	Counts
25	+28V Bus D Laser 3 Voltage	11	1	GPDBDL3P28V			PDU	Pseudo Mnemonic SLOPE1	Counts
26	+28V Bus D Laser 3 Current	12	1	GPDBDL3P28I			PDU	Pseudo Mnemonic SLOPE2	Counts
27	Secondary Monitor Calibration, Upper Byte	16	1	GPDMON2CALLB			PDU	Pseudo Mnemonic SLOPE1	Counts
28	Secondary Monitor Calibration, Lower Byte	17	1	GPDMON2CALLB			PDU	Pseudo Mnemonic SLOPE2	Counts
29	+5 V Hybrid # 1 Voltage	18	1	GDPHY1P5V			PDU	Pseudo Mnemonic SLOPE1	Counts
30	+5 V Hybrid # 1 Current	19	1	GDPHY1P5I			PDU	Pseudo Mnemonic SLOPE2	Counts
31	+12 V Hybrid # 2 Voltage	20	1	GDPHY2P12V			PDU	Pseudo Mnemonic SLOPE1	Counts
32	+12 V Hybrid # 2 Current	21	1	GDPHY2P12I			PDU	Pseudo Mnemonic SLOPE2	Counts
33	-12 V Hybrid # 3 Voltage	22	1	GDPHY3M12V			PDU	Pseudo Mnemonic SLOPE1	Counts
34	-12 V Hybrid # 3 Current	23	1	GDPHY3M12I			PDU	Pseudo Mnemonic SLOPE2	Counts
35	+5 V Hybrid # 4 Voltage	24	1	GDPHY4P5V			PDU	Pseudo Mnemonic SLOPE1	Counts
36	+5 V Hybrid # 4 Current	25	1	GDPHY4P5I			PDU	Pseudo Mnemonic SLOPE2	Counts
37	-5 V Hybrid # 5 Voltage	26	1	GDPHY5M5V			PDU	Pseudo Mnemonic SLOPE1	Counts
38	-5 V Hybrid # 5 Current	27	1	GDPHY5M5I			PDU	Pseudo Mnemonic SLOPE2	Counts
39	-5 V Hybrid # 6 Voltage	28	1	GDPHY6M5V			PDU	Pseudo Mnemonic SLOPE1	Counts
40	-5 V Hybrid # 6 Current	29	1	GDPHY6M5I			PDU	Pseudo Mnemonic SLOPE2	Counts
41	+15 V Boost Post Reg Voltage	30	1	GPDBTP15V			PDU	Pseudo Mnemonic SLOPE1	Counts
42	-15 V Boost Post Reg Voltage	31	1	GPDBTM15V			PDU	Pseudo Mnemonic SLOPE2	Counts
43	+12 V Prim Osc Thermal Control Current	32	1	GPDPHTC1P12I			PDU	Pseudo Mnemonic SLOPE1	Counts

Filename: GLAS_HK_PKTs.xls

Page 1 of 3

Worksheet: CT HW TLM #2

Pkt Name	CT HW TLM #2	idx	Size in Octets	Mnemonics	Frequency Interval	Size	Octets	Conversion Factors	Units
App Id	21				0.250 Hz	56			
Offset in Octets	Name				Ident.#		Description		
44	+12 V Sec Osc Thermal Control Current	33	1	GPDTHC2P12I			PDU	Pseudo GPDPTHC2P12I	Counts
45	-2 V Discrete Voltage	34	1	GPDIISM2V			PDU	Pseudo GPDPIISM2V	Counts
46	Hybrid Heatsink Temperature	35	1	GPDIYHST			PDU	Pseudo GPDPIYHST	Counts
47	FET Switch Bank Heatsink Temperature	36	1	GPDEFETSBHST			PDU	Pseudo GPDDEFETSBHST	Counts
48	Primary Oscillator Status	39		GPDOSC1ST	0x01		PDU	0=Off, 1=On	Counts
48	Secondary Oscillator Status	39		GPDOSC2ST	0x02		PDU	0=Off, 1=On	Counts
48	Primary AD Status	39		GPDAAD1ST	0x10		PDU	0=Off, 1=On	Counts
48	Secondary AD Status	39		GPDAAD2ST	0x20		PDU	0=Off, 1=On	Counts
48	FET Switch Bank Configuration	39	1	GPDEFETSB			PDU		Counts
49	HVPS +0 Volts Reference	14	1	GHVREFP0V			HVPS Bd	POLY=(0.0, 0.026)	Volts
50	HVPS +5 Volts Reference	15	1	GHVREFP5V			HVPS Bd	POLY=(0.0, 0.052)	Volts
51	MCS Mux Counter (4-bits)		1	GMCCTRINFO	0x0F		MCS Bd itlm	Commandable	Counts
52	Primary Sensor Position Laser Select Mechanism 1, HOP-1			GMCH1PPOS	0x0C00		MCS Bd itlm	Commandable 0=In-Deployment, 1=Unknown, 2=Deployed, 3=Stowed	
52	Primary Sensor Position Laser Select Mechanism 2, HOP-2			GMCH2PPOS	0x0300		MCS Bd itlm	Commandable 0=In-Deployment, 1=Unknown, 2=Deployed, 3=Stowed	
52	Primary Sensor Position Altimeter Digitizer Detector Select Mechanism, HOP-3			GMCH3PPOS	0x00C0		MCS Bd itlm	Commandable 0=In-Deployment, 1=Unknown, 2=DET#1, 3=DET#2	
52	Secondary Sensor Position Laser Select Mechanism 1, HOP-1			GMCH1SPOS	0x0030		MCS Bd itlm	Commandable 0=In-Deployment, 1=Unknown, 2=Deployed, 3=Stowed	
52	Secondary Sensor Position Laser Select Mechanism 2, HOP-2			GMCH2SPOS	0x000C		MCS Bd itlm	Commandable 0=In-Deployment, 1=Unknown, 2=Deployed, 3=Stowed	
52	Secondary Sensor Position Altimeter Digitizer Detector Select Mechanism, HOP-3			GMCH3SPOS	0x0003		MCS Bd itlm	Commandable 0=In-Deployment, 1=Unknown, 2=DET#1, 3=DET#2	
52	Optical Sensor Status		2	GMCOPTSST	0xFFFF		MCS Bd itlm	Commandable	

Worksheet: CT HW TLM #2

Page 2 of 3

Filename: GLAS_HK_PKT.xls

Pkt Name		CT HW TLM #2		56		Octets			
App Id	21	Frequency	0.250	Hz	seconds	Description			
Offset in Octets	Name	Mnemonics	4.000	Ident.#	Mask	Description	Conversion Factors	Units	
idx	Size in Octets								
54	HOP Temperature Status	GMCHOPT		0x0800		MCS Bd Commandable itlm	0=In Tolerance, 1=Out of Tolerance		
54	ADC Pulse Status	GMCADCPUL		0x0400		MCS Bd Commandable itlm	0=Not Received, 1= Received		
54	Deployed optic diodes power status	GMCDPLYOPTPWR		0x0200		MCS Bd Commandable itlm	0=ON, 1=OFF		
54	Stowed optic diodes power status	GMGSTOPTPWR		0x0100		MCS Bd Commandable itlm	0=ON, 1=OFF		
54	HOP LED Turn Off	GMCHOPLEDOF		0x0080		MCS Bd Commandable itlm	0=Armed, 1=Triggered		
54	HOP Temp Turn Off	GMCHOPTEMPOF		0x0040		MCS Bd Commandable itlm	0=Armed, 1=Triggered		
54	HOP Timer Turn Off	GMCHOPTIMOF		0x0020		MCS Bd Commandable itlm	0=Armed, 1=Triggered		
54	HOP Command Trigger Status	GMCHOPTRIG		0x0010		MCS Bd Commandable itlm	0=Not Received, 1= Received		
54	Reset Latch relay command status	GMCRSTLRLY		0x0008		MCS Bd Commandable itlm	0=Not Received, 1= Received		
54	Set latch relay command status	GMSETLRLY		0x0004		MCS Bd Commandable itlm	0=Not Received, 1= Received		
54	DAC Init Conversion Signal Status	GMCONSIG		0x0002		MCS Bd Commandable itlm	0=Not Sent, 1=Sent		
54	DAC Latch Data Signal Status	GMCDACLDSIG		0x0001		MCS Bd Commandable itlm	0=Not Sent, 1=Sent		
54	Status Cmd Telemetry	GMSTCM		0xFFFF		MCS Bd Commandable itlm			

Pkt Name App Id	CT HW TLM #3 22	idx	Size in Octets	Mnemonics	56 Frequency Interval	Octets Hz	Conversion Factors	Units
Offset in Octets								
0	Primary Header		6					
6	Secondary Header(time stamp)		8			Time when packet is sent		
14	Housekeeping Board Temperature	0	1	GHKHKT		HK	POLY=(-20.4, 0.3984)	Deg C
15	Instrument Processor System Board Temperature	1	1	GHK1PST		HK	POLY=(-23.5, 0.3984)	Deg C
16	Photon Counter Board Temperature	2	1	GHKPCT		HK	POLY=(-21.6, 0.3984)	Deg C
17	Cloud Digitizer/Frequency & Time Board Temperature	3	1	GHKCDT		HK	POLY=(-21.6, 0.3984)	Deg C
18	Altimeter Digitizer 1 DSP Temperature	4	1	GHKAD1DSPT		HK	POLY=(-21.0, 0.3984)	Deg C
19	Altimeter Digitizer 2 DSP Temperature	5	1	GHKAD2DSPT		HK	POLY=(-21.0, 0.3984)	Deg C
20	Data Collection & Handling Board Temp	6	1	GHKDCT		HK	POLY=(-20.7, 0.3984)	Deg C
21	Laser Monitor Board Temperature	7	1	GHKLMT		HK	POLY=(-21.0, 0.3984)	Deg C
22	Temperature Controller Monitor Board Temperature	8	1	GHKTMT		HK	POLY=(-21.0, 0.3984)	Deg C
23	Oven-crystal-controlled Oscillator(OXCO) 1 Board Temperature	9	1	GKXCO1T		HK	POLY=(-21.0, 0.3984)	Deg C
24	Oven-crystal-controlled Oscillator(OXCO) 2 Board Temperature	10	1	GKXCO2T		HK	POLY=(-21.0, 0.3984)	Deg C
25	Oscillator Board Temperature	11	1	GKOSCT		HK	POLY=(-21.0, 0.3984)	Deg C
26	Optical Test Source (OTS) Board Temperature	12	1	GKOTST		HK	POLY=(-21.0, 0.3984)	Deg C
27	Laser Profiler Array (LPA) Temperature 1	13	1	GKLPAT1T		HK	POLY=(-21.0, 0.3984)	Deg C
28	Laser Profiler Array (LPA) Temperature 2	14	1	GKLPAT2T		HK	POLY=(-21.0, 0.3984)	Deg C
29	Altimeter Digitizer 1 ECLA Temperature	15	1	GHKAD1ECLAT		HK	POLY=(-21.0, 0.3984)	Deg C
30	Altimeter Digitizer 2 ECLA Temperature	16	1	GHKAD2ECLAT		HK	POLY=(-21.0, 0.3984)	Deg C
31	Altimeter Digitizer 1 ECLB Temperature	17	1	GHKAD1ECLBT		HK	POLY=(-21.0, 0.3984)	Deg C
32	Altimeter Digitizer 2 ECLB Temperature	18	1	GHKAD2ECLBT		HK	POLY=(-21.0, 0.3984)	Deg C
33	Altimeter Digitizer 1 ADC Temperature	19	1	GHKAD1ADCT		HK	POLY=(-21.0, 0.3984)	Deg C
34	Altimeter Digitizer 2 ADC Temperature	20	1	GHKAD2ADCT		HK	POLY=(-21.0, 0.3984)	Deg C
35	Lidar Box Temperature	21	1	GKLDDBOX		HK-PRT	POLY=(-18.113, 0.3083)	Deg C
36	Telescope Mount Temperature	22	1	GKTELMNT		HK-PRT	POLY=(-18.113, 0.3083)	Deg C
37	Telescope Baffle Temperature	23	1	GKTELBFT		HK-PRT	POLY=(-18.113, 0.3083)	Deg C
38	Altimeter Detector 1 Temperature	24	1	GHKADT1T		HK-PRT	POLY=(-18.113, 0.3083)	Deg C
39	Altimeter Detector 2 Temperature	25	1	GHKADT2T		HK-PRT	POLY=(-18.113, 0.3083)	Deg C
40	Face 1 LTR to SRS Temperature	26	1	GKFL1TRT		HK-PRT	POLY=(-18.113, 0.3083)	Deg C
41	Face 2 LTR to SRS Temperature	27	1	GKFL2LRT		HK-PRT	POLY=(-18.113, 0.3083)	Deg C
42	SRS First Fold Optics Temperature	28	1	GK1FOLDT		HK-PRT	POLY=(-18.113, 0.3083)	Deg C
43	Fiber Box Temperature	29	1	GKFBBOX		HK-PRT	POLY=(-18.113, 0.3083)	Deg C

Pkt Name		CT HW TLM #3											
App Id	22			Size		56		Octets					
Offset	Name	idx	Size in Octets	Frequency Interval	Mnemonics	Ident.#	Description	Conversion Factors	Units				
44	Face 1 Fold Around Bench Temperature	30	1		GHKF1FABT		HK-PRT	POLY=(-18.113, 0.3083)	Deg C				
45	Face 2 Fold Around Bench Temperature	31	1		GHKF2FABT		HK-PRT	POLY=(-18.113, 0.3083)	Deg C				
46	Face 1 LTR CRS Temperature	32	1		GHKF1CRST		HK-PRT	POLY=(-18.113, 0.3083)	Deg C				
47	Face 2 LTR CRS Temperature	33	1		GHKF2CRST		HK-PRT	POLY=(-18.113, 0.3083)	Deg C				
48	Stellar Reference System (SRS) Parabola Temperature	34	1		GHKRSRSP		HK-PRT	POLY=(-18.113, 0.3083)	Deg C				
49	PRT Cal Low	35	1		GHKCALLO		HK-PRT	POLY=(-18.113, 0.3083)	Deg C				
50	PRT Cal High	36	1		GHKCALHI		HK-PRT	POLY=(-18.113, 0.3083)	Deg C				
51	Pin Diode Bias Voltage	38	1		GHKBIASV		HK	POLY=(0.0, 0.2949)	Volts				
52	AD1 High Speed Ram Temperature	39	1		GHKAD1HSRT		HK	POLY=(-21.0, 0.3984)	Deg C				
53	Spare		1		GHKSPR1								
54	Spare		1		GHKSPR2								
55	Spare		1		GHKSPR3								

Filename: GLAS_HK_PKTs.xls

Page 2 of 2

Worksheet: CT HW TLM #3

Pkt Name	CT HW TLM #4	idx	Size in Octets	Mnemonics	Frequency Interval	56 Hz	Octets	Conversion Factors	Units
App Id	23					0.0625	Hz		
Offset in Octets	Name					16.000	seconds		
						Ident.#	Description		
						Mask			
0	Primary Header		6						
6	Secondary Header(time stamp)		8				Time when packet is sent		
14	Laser Select Mechanism #1 Temperature	0-0	2	GMCLSM1T			MCS	POLY=(-1456.13, 0.5664055703)	Deg C
16	Laser Select Mechanism #2 Temperature	0-1	2	GMCLSM2T			MCS	POLY=(-1456.13, 0.5664055703)	Deg C
18	Altimeter Detector Select Mechanism Temp.	0-2	2	GMCAJDSMT			MCS	POLY=(-1456.13, 0.5664055703)	Deg C
20	Laser Beam Select Mech Electronics Temp	0-3	2	GMCLBSMET			MCS	POLY=(-1456.13, 0.5664055703)	Deg C
22	Laser Beam Select Mechanism Mirror Temp	0-4	2	GMCLBSMMT			MCS	POLY=(-909.090909, 0.4438920455)	Deg C
24	HOP 1 Actuator Current - Heater 1	1	2	GMCHOP1HTR1I			MCS	POLY=(-2.0, 976.5625E-6)	Amps
26	HOP 1 Actuator Current - Heater 2	2	2	GMCHOP1HTR2I			MCS	POLY=(-2.0, 976.5625E-6)	Amps
28	HOP 2 Actuator Current - Heater 1	3	2	GMCHOP2HTR1I			MCS	POLY=(-2.0, 976.5625E-6)	Amps
30	HOP 2 Actuator Current - Heater 2	4	2	GMCHOP2HTR2I			MCS	POLY=(-2.0, 976.5625E-6)	Amps
32	HOP 3 Actuator Current - Heater 1	5	2	GMCHOP3HTR1I			MCS	POLY=(-2.0, 976.5625E-6)	Amps
34	HOP 3 Actuator Current - Heater 2	6	2	GMCHOP3HTR2I			MCS	POLY=(-2.0, 976.5625E-6)	Amps
36	Loop Heat Pipe 1 Heater Status, Mask=0x01	0		GTMLHP1		0x01	TCM	0=Off, 1=On	
36	Loop Heat Pipe 2 Heater Status, Mask=0x02	0		GTMLHP2		0x02	TCM	0=Off, 1=On	
37	Telescope Prim Mirror Heater Enable Readback	1	1	GTMPMTRHTR			TCM	0=Disabled, 0xFF=Enabled	
38	Telescope Prim Mirror Heater Temp Setpoint Readback	2	1	GTMPMLRTSP			TCM	POLY=(0.16, 0.1027, -4.253E-05, 3.833E-07)	Deg C
39	Telescope Tower Heater Enable Readback	5	1	GTMTOWHTR			TCM	0=Disabled, 0xFF=Enabled	
40	Telescope Tower Heater Temp Setpoint Readback	6	1	GTMTOWTSP			TCM	POLY=(0.03, 0.1051, -6.469E-05, 4.376E-07)	Deg C
41	Spare		1	GTMSPR3			TCM		
41	Spare		1	GTMSPR4			TCM		
41	Etalon Heater Enable Readback	7	1	GTMEHTR			TCM	0=Disabled, 0xFF=Enabled	
42	Etalon Heater Temp Setpoint Readback	8	1	GTMETTSP			TCM	POLY=(29.27, 0.09251, 9.19E-06, 1.022E-07)	Deg C
43	Loop Heat Pipe 1 Enable Readback	9	1	GTMLHP1HTR			TCM	0=Disabled, 0xFF=Enabled	
44	Loop Heat Pipe 1 Temp Setpoint Readback	10	1	GTMLHP1TSP			TCM	POLY=(0.03, 0.1173, -6.871E-05, 2.629E-07)	Deg C
45	Loop Heat Pipe 2 Enable Readback	11	1	GTMLHP2HTR			TCM	0=Disabled, 0xFF=Enabled	
46	Loop Heat Pipe 2 Temp Setpoint Readback	12	1	GTMLHP2TSP			TCM	POLY=(-7.7, 0.11, -5.1E-05, 2.007E-07)	Deg C
47	Thermister Select - Tscope Prim Mirror - Status Readback	13	1	GTMPMTRHSEL			TCM	0=Thermistor 1, 0xFF=Thermistor 2	
50	Thermister Select - Tscope Sec Support Structure Status Readback	15	1	GTMSSTHSEL			TCM	0=Thermistor 1, 0xFF=Thermistor 2	

Pkt Name App Id	CT HW TLM #4 23		idx	Size in Octets	Mnemonics	Frequency Interval	Size 0.0625 16.000	56 Ident. #	Octets Hz seconds	Description	Conversion Factors	Units
	Name	Mask										
51	Thermister Select - Iscope Sec Mirror - Status Readback	14	1	GTMSMIRTHSEL		TCM				0=Thermistor 1, 0xFF=Thermistor 2		
52	Thermister Select LHP1 (lasers) Status Readback	16	1	GTMLHP1THSEL		TCM				0=Thermistor 1, 0xFF=Thermistor 2		
53	Thermister Select LHP2 (rest of instrument) Status Readback	17	1	GTMLHP2THSEL		TCM				0=Thermistor 1, 0xFF=Thermistor 2		
54	Thermister Select Etalon Status Readback	18	1	GTMETHSEL		TCM				0=Thermistor 1, 0xFF=Thermistor 2		
55	Spare		1	GHW4SPR1								

Filename: GLAS_HK_PKT.xls

Page 2 of 2

Worksheet: CT HW TLM #4

Pkt Name	CT HW TLM #5	Idx	Size in Octets	Mnemonics	Frequency Interval	Size 56	Octets	Conversion Factors	Units
App Id	50				Hz	32.000	seconds		
Offset in Octets	Name				Description	Ident.#			
0	Primary Header		6			Mask			
6	Secondary Header(time stamp)		8				Time when packet is sent		
14	Telescope Primary Mirror Temperature	37a	1	GHKPMIRT			POLY=(0.16, 0.1027, -4.253E-05, 3.833E-07)		Deg C
15	Telescope Tower Temperature	37b	1	GHKTOWT			POLY=(0.03, 0.1051, -6.469E-05, 4.376E-07)		Deg C
16	Telescope Secondary Mirror Temperature	37c	1	GHKSMIRT			POLY=(0.14, 0.104, -5.962E-05, 4.304E-07)		Deg C
16	Etalon Temperature	37d	1	GHKETT			POLY=(29.27, 0.09251, 9.19E-06, 1.022E-07)		Deg C
17	Loop Heat Pipe 1 Controller Temperature	37e	1	GKHLHP1CTRILT			POLY=(0.03, 0.1173, -6.871E-05, 2.629E-07)		Deg C
18	Loop Heat Pipe 2 Controller Temperature	37f	1	GKHLHP2CTRILT			POLY=(-7.7, 0.11, -5.1E-05, 2.007E-07)		Deg C
19	Telescope Primary Mirror Heater drive current	37g	1	GHKPMIRI			POLY=(0.0008, 0.00368)		Amps
21	Telescope Tower Heater drive current	37h	1	GHKTOWI			POLY=(0.0008, 0.00311)		Amps
22	HK Spare	37i	1	GHKSPRS			POLY=(-0.0002, 0.00347)		Amps
22	Etalon Drive Heater Current	37j	1	GKRETHRI			POLY=(-33.84, 0.5368, -1.622E-3, 3.155E-6)		Deg C
23	Laser Monitor Delay Line All Temperature	21	1	GLMDLYALLT			POLY=(2.406, 0.06459, -7.58E-6, 5.591E-8)		Deg C
24	Laser Monitor Delay Line Mid Temperature	22	1	GLMDLYMIDT			POLY=(13.33, 0.06618, -5.261E-6, 4.076E-8)		Deg C
25	Laser Monitor Delay Line Hi Temperature	23	1	GLMDLYHIT			POLY=(40, -0.15625)		micro Amps
26	OTS Level 1 readback	9	1	GLMOTSLVL1			POLY=(40, -0.15625)		micro Amps
27	OTS Level 2 readback	10	1	GLMOTSLVL2			POLY=(40, -0.15625)		micro Amps
28	OTS Level 3 readback	11	1	GLMOTSLVL3			POLY=(40, -0.15625)		micro Amps
29	OTS Level 4 readback	12	1	GLMOTSLVL4			POLY=(40, -0.15625)		micro Amps
30	OTS Trigger Count 1 readback	13	2	GLMOTSTFC1			POLY=(0.0, 0.256)		micro secs
32	OTS Trigger Count 2 readback	14	2	GLMOTSTFC2			POLY=(0.0, 0.256)		micro secs
34	Spares		21	GHWSPPR[21]					

Worksheet: CT HW TLM #5

Page 1 of 1

Filename: GLAS_HK_PKTs.xls

Pkt Name App Id	Small Software #1 Tlm 24		idx	Size in Octets	Size		Octets	Description
	Name				Frequency Interval	56 0.250 4.000 seconds		
Offset in Octets	Name				Mnemonics	Ident.# Mask		
0	Primary Header			6				
6	Secondary Header(time stamp)			8				Time when packet is sent
14	HS Task Cmd Processed Counter		1	1	GHSCMDPC			
15	HS Task Cmd Rejected(or Error) Counter		2	1	GHSCMDEC			
16	CS Task Cmd Processed Counter		1	1	GCSCMDPC			
17	CS Task Cmd Rejected(or Error) Counter		2	1	GCSCMDEC			
18	TC Task Cmd Processed Counter		1	1	GTCMDPC			
19	TC Task Cmd Rejected(or Error) Counter		2	1	GTCMDEC			
20	SB Task Cmd Processed Counter		1	1	GSBCMDPC			
21	SB Task Cmd Rejected(or Error) Counter		2	1	GSBCMDEC			
22	SM Task Cmd Processed Counter		1	1	GSMCMDPC			
23	SM Task Cmd Rejected(or Error) Counter		2	1	GSMCMDEC			
24	RT Task Cmd Processed Counter		1	1	GRTCMDPC			
25	RT Task Cmd Rejected(or Error) Counter		2	1	GRTCMDEC			
26	RT Task RCH3 (SA22-25, CSA 26) Commands Received		3	1	GRTRCH3RX			Does not count spacecraft position and command packet
27	RT Task RCH3 (SA22-25, CSA 26) Commands Rejected		4	1	GRTRCH3RJ			Commands are rejected for Checksumm problems
28	MD Task Cmd Processed Counter		1	1	GMDCMDPC			
29	MD Task Cmd Rejected(or Error) Counter		2	1	GMDCMDEC			
30	AD Task Cmd Processed Counter		1	1	GADCMDPC			
31	AD Task Cmd Rejected(or Error) Counter		2	1	GADCMDEC			
32	AD Target Present Flag				GADTGTPLG	0x80		0=Not Present, 1=Target Present
32	AD Target Timeout Flag				GADTGTTOFLG	0x40		0=No Timeout, 1=Timeout
32	AD DSP Software Mode				GADSWMODE	0x38		0=Idle, 1=Science, 2=OneShot, 3=Load, 4=Dump
32	AD Target Status and Mode Flags				GADSPSWMODE	0x07		0=Science, 1=Idle, 2=Load, 3=Dump
32	AD Spare Telemetry		3	1	UNION AD_TLM_U			
36	CD Task CMD Processed Counter		4	3	GADSPARE[3]			AD Spare Telemetry
37	CD Task CMD Rejected(or Error) Counter		1	1	GDCMDPC			
38	CD Timeout Occurred Flag		2	1	GCDTIMEOUT	0x01		0=No Timeout, 1=Timeout
38	CD Target Present Flag				GCDTARCONF	0x02		0=Not Configured, 1=Configured
38	CD Event Messages Disabled Flag				GCDVMTMFLG	0x04		0=Enabled, 1=Disabled
38	CD Measurement Reference Source				GCDMSMTSRC	0x08		0=Fire Ack, 1=Fire Cmd
38	CD 40Hz Interrupt				GCD40HZINT	0x10		0=Enabled, 1=Disabled

Worksheet: Small SW #1

Page 1 of 3

Filename: GLAS_HK_PKTs.xls

Pkt Name	Small Software #1 Tim	idx	Size in Octets	Mnemonics	Frequency Interval	Size	56	Octets	Description
App Id	24				Hz	seconds	Ident.#	seconds	
Offset in Octets	Name		Octets				Mask		
38	CD AD Detector Select			GCDADDET			0x20	0=AD #1, 1=AD #2	
38	CD Detector Select			GDCDDDET			0x40	0=CD #1, 1=CD #2	
38	CD AD Board Select			GCDADBRD			0x80	0=AD #1, 1=AD #2	
38	CD Hardware Mode			GCDHWMODE			0x0F00	1=Idle, 2=Engineering, 4=Science, Other values invalid	
38	CD Software Mode			GCDSWMODE			0xF000	0=Idle, 1=Engineering, 2=Science, 3=Mem Tst, Other values invalid	
38	CD Status Flags		2						
40	DC Task Cmd Processed Counter	1	1	GDCCMDPC					
41	DC Task Cmd Rejected(or Error) Counter	2	1	GDCCMDEC					
42	DC Timeout Status			GDCTIMEOUT			0x01	0=No Timeout, 1=Timeout	
42	DC Target Present Status			GDCGTTPRES			0x02	0=Not Present, 1=Target Present	
42	DC Event Message Disabled Flag			GDCEVTMFLG			0x04	0=Enabled, 1=Disabled	
42	DC Software Mode			GDCSWMODE			0xFF00	0=SSR, 1=SSR_LPA, 2=TEST	
42	DC Status Flags		2						
44	GP Task Cmd Processed Counter	1	1	GGFCMDPC					
45	GP Task Cmd Rejected(or Error) Counter	2	1	GGFCMDEC					
46	GP GPS Pulse Select			GGPPULSEBIT			0x0020	0=GPS1, 1=GPS2	
46	GP Receiving GPS Pulse Flag			GGPRVCPUS			0x0010	0=Not receiving pulse, 1=Receiving pulse	
46	GP Position Data Status Flag			GGPPOSFLG			0x000C	0=OK, 1=No Data, 2=Data Calculation Err	
46	GP Source of Position Data			GGPSRCDAT			0x0003	0=S/C, 1=Grd Hmin/Hmax, 2=Grd Rmin/Rmax	
46	GP Status Flags		2				0x003F	GP status word, see bit mask above	
48	PC Task Cmd Processed Counter	1	1	GPCCMDPC					
49	PC Task Cmd Rejected(or Error) Counter	2	1	GPCCMDEC					
50	PC Timeout Status			GPCTIMEOUT			0x01	0=No Timeout, 1=Timeout	
50	PC Target Present Status			GPCTARCONF			0x02	0=Not Configured, 1=Configured	
50	PC Calibration Type			GPCCALTYPE			0x04	0=Coarse, 1=Fine	
50	PC Event Messages Disabled			GPCEVTMFLG			0x08	0=Enabled, 1=Disabled	
50	PC Range Gate Dither Flag			GPCRGDIPLG			0x10	0=Disabled, 1=Enabled	
50	PC Measurement Reference Source			GPCMSITSRC			0x20	0=Fire Ack, 1=Fire Cmd	
50	PC Hardware Mode			GPCHWMODE			0x0F00	1=Idle, 2=Engineering, 4=Science, Other values invalid	
50	PC Software Mode			GPSCSWMODE			0xF000	0=Idle, 1=Engineering, 2=Science, 3=Boresite Cal, 4=Mem Tst, Other values invalid	
50	PC Status Flags		2						

Pkt Name	Small Software #1 Tim				Size	56	Octets
App Id	24			Frequency Interval	0.250	Hz	
Offset in Octets	Name	idx	Size in Octets	Mnemonics	Ident.#	seconds	Description
52	CT Task Cmd Processed Counter	1	1	GCTCMDPC	Mask		
53	CT Task Cmd Rejected(or Error) Counter	2	1	GCTCMDPC			
54	CT Task Software Mode			GCTSWMODE	0x01	0=Manual, 1=Normal	
54	CT Task C&T Control Hardware Mode, Register bit			GCTHWMODE	0x02	0=Manual, 1=Normal	
54	CT Task Startup Mode, Discrete cmd			GCTSUMODE	0x04	0=Manual, 1=Auto Power Up Osc/AD	
54	CT Task Startup AD/OSC, Discrete cmd			GCTSUAO	0x08	0=Primary, 1= Secondary	
54	CT Etalon Tracking Mode			GCTETMODE	0x70	0=Off, 1=Acquire, 2=Tracking, 4=Test, 5=Test/Acquire, 6=Test/Tracking	
54	CT Etalon Tracking Active Flag			GCTETRACK	0x80	0=Paused, 1=Active	
54	CT Etalon Tracking Low Transmission Flag			GCTELOWTR	0x100	0=Good, 1=Low	
54	CT Etalon Tracking Open-Loop Flag			GCTEOLMODE	0x200	0=Normal, 1=OpenLoop	
54	CT Task Mode		2	GCTMSTAT		All bits together	

Filename: GLAS_HK_PKTs.xls

Page 3 of 3

Worksheet: Small SW #1

Pkt Name App Id	Large Software TIm #1 25	Name	Idx	Size in Octets	Size		Description
					Frequency Interval	300 4,000	
Offset in Octets					Mnemonics	Ident.# Mask	Octets Hz seconds
0		Primary Header		6			
6		Secondary Header(time stamp)		8			Time when packet is sent
14		HS Processor Previous Mode		1	GHSPMODE		0,1,4=Unknown, 2=PROM, 3=EEPROM
15		HS Processor Current Mode		1	GHSCMODE		0,1,4=Unknown, 2=PROM, 3=EEPROM
16		Subsystem Present Flags				0xFFFF	0=No, 1=Yes Subsystem Telemetry is present in Small and Large Telemetry Packets
16		HS Subsystem Present Flag				0x0001	0=No, 1=Yes
16		CS Subsystem Present Flag				0x0002	0=No, 1=Yes
16		TC Subsystem Present Flag				0x0004	0=No, 1=Yes
16		SB Subsystem Present Flag				0x0008	0=No, 1=Yes
16		SM Subsystem Present Flag				0x0010	0=No, 1=Yes
16		RT Subsystem Present Flag				0x0020	0=No, 1=Yes
16		MD Subsystem Present Flag				0x0040	0=No, 1=Yes
16		AD Subsystem Present Flag				0x0080	0=No, 1=Yes
16		CD Subsystem Present Flag				0x0100	0=No, 1=Yes
16		DC Subsystem Present Flag				0x0200	0=No, 1=Yes
16		GP Subsystem Present Flag				0x0400	0=No, 1=Yes
16		PC Subsystem Present Flag				0x0800	0=No, 1=Yes
16		CT Subsystem Present Flag		2	GHSCTPF	0x1000	0=No, 1=Yes
18		HS Warm Restart Count		2	GHSWRC		
20		HS Cold Restart Count		2	GHSCRC		
22		HS Max Warm Restart Count		2	GHSMAXWR		
24		HS Cold-Warm Flag		2	GHSCWF		
26		HS OS Caused Reset Flag		2	GHOSRST		
28		HS OS Tick Count		2	GHOSSTICK		
30		HS HS Exec Count		4	GHSHSEX		
34		HS CS Exec Count		2	GHSCSEX		
36		HS TC Exec Count		2	GHSTCEX		
38		HS SB Exec Count		2	GHSSBEX		
40		HS SM Exec Count		2	GHSSMEX		
42		HS RT Exec Count		2	GHSTRTEX		
44		HS MD Exec Count		2	GHSMDEX		
46		HS AD Exec Count		2	GHSADEX		
48		HS CD Exec Count		2	GHSCDEX		
50		HS DC Exec Count		2	GHSDCEX		

Pkt Name App Id	Large Software TIm #1 25	Name	Idx	Size in Octets	Size		Description
					Frequency Interval	300 0.250 4.000 seconds	
Offset in Octets		Mnemonics	Ident.#	Mask			
52		HS GP Exec Count		2	GHSGPX		
54		HS PC Exec Count		2	GHSPCX		
56		HS CT Exec Count		2	GHSCTX		
58		HS FPU Underflow Count		4	GHSFPUUF		
62		HS Spare ISR Count 1		4	GHSI2ISR		
66		HS Spare ISR Count 2		2	GHSFPIISR		
68		HS TC Fire Cmd ISR Count		2	GHSFCFISR		
70		HS RT ISR Count - Low Priority		2	GHSRTISR		
72		HS Spare ISR Count 3		2	GHSFPIISR		
74		HS CT ISR Count		2	GHSCTISR		
76		HS Spare ISR Count 4		2	GHSFPIISR		
78		HS Spare ISR Count 5		2	GHSFPIISR		
80		HS GPS 10 Sec ISR Count		2	GHSGPS1ISR		
82		HS DC ISR Count		2	GHSDCISR		
84		HS PC ISR Count		2	GHSPCISR		
86		HS CD ISR Count		2	GHSCDISR		
88		HS AD ISR Count		2	GHSADISR		
90		HS Spare ISR Count 6		2	GHS6ISR		
92		HS OS Event Seq Number		2	GHSOSESN		
94		HS Peak CPU Utilization		1	GHSFPCPU		
95		HS Last CPU Utilization		1	GHSLCPU		
96		HS OS PCI Bus Target Enable and Interrupt status		1	GHSPCIFLAGS		
97		HS OS Performance Log Enable Flag		1	GHSOSLOG	0x01	0=Disabled, 1=Enabled
98		HS OS Performance Log Item Count		2	GHSOSLOGCNT		
100		HS OS Performance Log Filter Start Address		4	GHSLOGADDR		
104		HS OS Performance Log Filter Mask		4	GHSOSLOGFM		
108		Spare		6	GHSSPARE[6]		
114		CS Enable/Disabled Flag			GCSSENFLG	0x03	0=Disabled, 1=Enabled
114		CS Code Memory Checksum Status			GCSMSTFLG	0x0C	0=Disabled, 1=Enabled, 2=Disabled and Recompiling, 3=Enabled and Recompiling
114		CS Table Memory Checksum Status			GCSMSTFLG	0x30	0=Disabled, 1=Enabled, 2=Disabled and Recompiling, 3=Enabled and Recompiling
114		CS EEPROM Checksum status flag			GCSSESTFLG	0xC0	0=Disabled, 1=Enabled, 2=Disabled and Recompiling, 3=Enabled and Recompiling
114		CS Status Flags		1	GCSSTATFLG	0xFF	

Pkt Name App Id	Large Software Tlm #1 25	Name	Idx	Size in Octets	Size		Description
					Frequency Interval	300 0.250 4.000 seconds	
Offset in Octets					Mnemonics	Ident.# Mask	
115		CS Code Segment Error Count		1	GCSERRCNT		
116		CS EEPROM Segment Error Count		1	GCSEERRCNT		
117		CS Table Ram Segment Error Count		1	GCSRERRCNT		
118		CS Table ID of last Code Error		2	GCSIDCODEERR		
120		CS Table ID of last EEPROM Error		2	GCSIDDEERR		
122		CS Table ID of last Table RAM Error		2	GCSIDRAMERR		
124		CS Code Segment Master Checksum		2	GCSSEGMSCS		
126		CS Table RAM Master Checksum		2	GCSRAMMSCS		
128		CS EEPROM Master Checksum		2	GCSEEMSCS		
130		CS Checksum of EEPROM Boot Memory		2	GCSEEBTMEM		
132		CS Checksum of EEPROM Memory		2	GCSEEMEM		
134		CS Checksum of PROM Memory		2	GCSPROMMEM		
136		CS Spare		18	GCSSPARE [18]		
154		TC GLAS MET Upper 2 bytes			GTCMETU2	0xFF0000	
154		TC GLAS MET Lower 4 bytes			GTCMETL4	0x00FFFF	
154		TC GLAS MET		6	GTCMET		
160		TC Fire Command Time Increment Upper 2 bytes		2	GTCINCRU2		
162		TC Fire Command Time Increment Lower 4 bytes		4	GTCINCLR4		
166		TC GLAS MET Working Time seconds		4	GTCWMETSEC		
170		TC GLAS MET Working Time micro-seconds		4	GTCWMETMSEC		
174		Spare		18	GTCSPARE [18]		
192		SB Send Error Count		1	GSBSNDEC		
193		SB Receive Error Count		1	GSBRVCVEC		
194		SB OS Error Count		1	GSBOSEC		
195		SB Queue Full Error Count		1	GSBQFEC		
196		SB Buffer overrun Error Count		2	GSBBOVEC		
198		SB last buffer overrun - Stream Id		2	GSBOVSID		
200		SB last buffer overrun - Pipeline Id		2	GSBOVPID		
202		SB last buffer overrun - Sender Task ID		2	GSBOVTID		
204		SB last queue full - Stream Id		2	GSBQFSID		
206		SB last queue full - Pipeline Id		2	GSBOFPID		
208		SB last queue full - Sender Task ID		2	GSBOFTID		
210		SB Spare		8	GSBSFAPARE [8]		
218		SM num of remaining copies to be dumped		1	GSMDMPCR		
219		SM tbl/mem dump in progress flag		1	GSMDMPFLG	0=False, 1=True	

Pkt Name App Id	Large Software TIm #1 25	Name	Idx	Size in Octets	Size		Mnemonics	300 0.250 4.000 Ident.# Mask	Octets Hz seconds	Description
					Frequency Interval	Mask				
Offset in Octets										
220		SM Table Session Type					GSMTSEST	0x3F		0=None, 5=DUMP_ONLY, 6=REP_EEPROM, 7=REP_RAM, 8=APPD_ACTV
220		SM Table Operations Flag					GSMTBOAF	0x40		0=Inactive, 1=Active
220		SM table operations flag		1			GSMTBLOPS	0x7F		
221		SM table operations from image type		1			GSMIMGTYP			0=None, 1=EEPROM, 2=RAM, 3=NULL
222		SM table id selected		2			GSMTBLLD			
224		SM currently selected tbl size in words		2			GSMTBLSZ			
226		SM currently selected table checksum		2			GSMTBLS			
228		SM table commit success count		1			GSMTCSCNT			
229		SM table commit failure count		1			GSMTCFCNT			
230		SM table num. of words loaded		2			GSMTBWLWD			
232		SM FSW build number		1			GSMWBUILD			
233		SM FSW version number		1			GSMWVERN			
234		SM spares		10			GSMSPARE[10]			
244		BCRT CONTROL REGISTER WORD					GRBRCRCW			
244		RT Channel A Select					GRTSELA	0x0080		0=OFF, 1=ON
244		RT Channel B Select		2			GRTSELB	0x0100		0=OFF, 1=ON
246		BCRT Status Register		2			GRBRCRTSR			0=Disabled, 1=Enabled
246		RT Status, RT Mode Enabled Flag		2			GRTACT			
248		BCRT INTERRUPT STATUS REGISTER		2			GRBRCRTISR			
250		RT 1553 MESSAGE ERRORS		2			GRTMSGERR			
252		RT 1553 RETRY COUNT		2			GRTRETRY			
254		RT 1553 INVALID COMMANDS		1			GRTINV			
255		RT 1553 INVALID BROADCAST CMDS		1			GRTINVBC			
256		RT MODE CODES RECEIVED		1			GRTMODE			
257		SPARE		1			GRTSP1			
258		RT PACKETS RECEIVED ON RCH1		2			GRTRCH1RX			
260		RT PACKETS Rejected ON RCH1		2			GRTRCH1RJ			
262		RT PACKETS SENT ON XCH1		2			GRTXCH1			HK Channel
264		RT PACKETS SENT ON XCH2		2			GRTXCH2			Diag Channel
266		RT Number of Command History Packets Sent		2			GRTCMDHIST			
268		RT Checksum Status		2			GRTCSSTAT			0=Cmd CS Disabled, 1=Cmd CS Enabled
270		Spares		8			GRTSPARE[8]			
278		MD Global Enable/Disable Flag					GMDWELL	0x01		0=Disabled, 1=Enabled
278		MD Table #1 Enable Flag					GMDTBL1	0x02		0=Disabled, 1=Enabled

Pkt Name App Id	Large Software Tlm #1 25	Name	Idx	Size in Octets	Size		Octets
					Frequency Interval	0.250 4.000	
Offset in Octets					Mnemonics	Ident.# Mask	Description
278		MD Table #2 Enable Flag		1	GMDTBL2	0x04	0=Disabled, 1=Enabled
279		MD Spare		1	GMDSPARE		
280		MD Table #1 Address Count		2	GMDADDRCNT1		
282		MD Table #2 Address Count		2	GMDADDRCNT2		
284		MD Table #1 Rate		2	GMDTBLRATE1		Number of 1/8 sec waits between dwell collections for Table #1. Polynomial coeff=(0.0, 0.125).
286		MD Table #2 Rate		2	GMDTBLRATE2		Number of 1/8 sec waits between dwell collections for Table #2. Polynomial coeff=(0.0, 0.125).
288		MD Spares		12	GMDSPARE2 [12]		

Filename: GLAS_HK_PKTts.xls

Page 5 of 5

Worksheet: Large SW #1

Pkt Name	Large Software Tim #2					376	Octets
App Id	55			Frequency	Interval	0.2500	Hz
Offset in Octets	Name	Idx	Size in Octets	Mnemonics		Ident.#	Description
0	Primary Header		6			Mask	
6	Secondary Header(time stamp)		8				Time when packet is sent
14	AD Software Error Count		2	GADSWEC			Software errors detected
16	AD Hardware Error Count		2	GADHWEC			Hardware errors detected
18	AD Shot Count Value		1	GADSHCNT			0= no skip, 1=skip
19	AD Shot Count Skip Detected		1	GADSHCNTSKIP			0=not in sync, 1=in sync
20	AD Synchronized Flag		1	GADSYNCFLG			
21	AD Spare Telemetry		1	GADSPARE2			
22	AD DSP Laser Fire Count		2	GADDSPLFCNT			Indicates the number of laser fire cmds detected.
24	AD DSP Alive Count		2	GADDSPLACNT			Increments once every 75ms when laser fire cmd fails
26	AD Ancillary Packets Sent		2	GADANCPKTCNT			
28	AD Engineering Packets Sent		2	GADENGPKTCNT			
30	AD Science Small Packets Sent		2	GADSFKTCNT			
32	AD Science Large Packets Sent		2	GADLFKTCNT			
34	AD DSP Load Packets Processed Count		2	GADDSPLPFCNT			
36	AD DSP Memory Dump Packets Sent		2	GADDSFMDPFCNT			
38	AD Memory Load Command Errors		2	GADDSFMDERR			
40	AD Memory Dump Command Errors		2	GADDSFMDERR			
42	AD DSP Checksum Rate		2	GADDSFCSRATE			# of 48-bit words checked in each of 3 memory types of DSP memory each shot (40 Hz)
44	AD DSP Checksum SW Enable Status		2	GADDSFCSW		0x0001	0=Disable, 1=Enable
46	AD DSP # of times all of memory has been checksummed		2	GADDSFCSW			
48	AD DSP Bootstrap Checksum Lower 16 bits		2	GADDSFBSLSB			
50	AD DSP EPROM Checksum Lower 16 bits		2	GADDSPEPLSB			
52	AD DSP RAM Checksum Lower 16 bits		2	GADDSFRAMLSB			
54	AD DSP Bootstrap Checksum Upper 32 bits		4	GADDSFBMSB			
58	AD DSP EPROM Checksum Upper 32 bits		4	GADDSFEFMSB			
62	AD DSP RAM Checksum Upper 32 bits		4	GADDSFRAMMSB			
66	AD DSP SW Build Number		1	GADDSFBNUM			
67	AD DSP SW Version Number		1	GADDSFVNUM			
68	AD GPS Range Window Packets received		2	GADGFSRWRVCV			
70	AS DSP Patch Checksum bits 15..0		2	GADPACSL			Lower 16 bits of a 48-bit address
72	AS DSP Patch Checksum bits 47..16		4	GADPACSM			Upper 32 bits of a 48-bit address
76	AD Auto Reset DSP Flag		1	GADARSTD		0x01	0=False, 1=True
77	AD SW Error Events Flag			GADSWEEV		0x80	0=Disabled, 1=Enabled
77	AD HW Error Events Flag			GADHWEV		0x40	0=Disabled, 1=Enabled
77	AD Auto Gain Enable Flag			GADGAINEN		0x20	0=Disabled, 1=Enabled
77	AD Auto Gain Use Raw Waveform Flag			GADGAINFE		0x10	0=Disabled, 1=Enabled
77	AD Software Enable Flags		1	UNION GAD_DSP_FLAGS			
78	Trouble Indicator: Invalid Search			GADTFB0		0x0001	0=No Problem 1=Invalid Search
78	Trouble Indicator: Laser Failure			GADTFB1		0x0002	0=No Problem 1=Laser Failure
78	Trouble Indicator: Multiple Interrupts			GADTFB2		0x0004	0=No Problem 1=Multiple Interrupts

Pkt Name	App Id	Large Software Tim #2	55	Idx	Size in Octets	Mnemonics	Frequency Interval	376 Hz	Octets	Description
Offset in Octets	Name						4.000 seconds	Ident.#	Mask	
78	Trouble Indicator: Buffer Full					GADTFB3		0x0008	0=No Problem 1=Buffer Full	
78	Trouble Indicator: Invalid Mode					GADTFB4		0x0010	0=No Problem 1=Invalid Mode	
78	Trouble Indicator: Infinite Loop					GADTFB5		0x0020	0=No Problem 1=Infinite Loop	
78	Trouble Indicator: Invalid Range Window					GADTFB6		0x0040	0=No Problem 1=Invalid Range Window	
78	Trouble Indicator: Invalid Tournament					GADTFB7		0x0080	0=No Problem 1=Invalid Tournament	
78	Trouble Indicator: Noise Region Outside Acq Mem					GADTFB8		0x0100	0=No Problem 1=Noise Region Outside Acquisition Memory	
78	Trouble Indicator: Invalid Sample Size for Noise Region					GADTFB9		0x0200	0=No Problem 1=Invalid Sample Size for Noise Region	
80	AD DSP Trouble Indicator Status Word			2		GADDSPTBLE				
80	AD DSP Memory Table Load Error Counter			2		GADMLTEC				
82	AD Fixed Return Gain Setting			1		GADFRGAIN				
83	AD Spares			5		GADSPARE1 [5]				
88	CD Software Error Count			2		GCDSWERRCNT				
90	CD Shot Count			2		GCDSHOTCNT				
92	CD Science Mode Packets Sent			2		GCDSCIPKPT				
94	CD Engineering Mode Packets Sent			2		GCDENGPKT				
96	CD Ancillary Packet Sent			2		GCDANCPKT				
98	CD Range Gate Pkts Received			2		GCDRGPTRV				
100	CD 40-bit Counter Packets Sent			2		GCDGPS40BPKT				
102	Spare			2						
104	CD Background #1 Delay			2		GCDDBG1DLY				Unit = nanoseconds Poly=(0.0,128)
106	CD Background #2 Delay			2		GCDDBG2DLY				Unit = nanoseconds Poly=(0.0,128)
108	CD Range Gate Delay			2		GCDRGLY				Unit = nanoseconds Poly=(0.0,128)
110	CD Raw A/D Output Data					GCDADRAWDATA		0x00FF		
110	CD Raw A/D Overflow Flag					GCDADRAWFLG		0x0100		0=No Overflow 1=Overflow
110	CD Attenuation Settings			4		GCDATTEN		0x3E00		1=0.0, 2=1/1.77, 4=1/3.16, 8=1/5.6, 16=1/10
114	CD GPS 40 bit Latch Value 32 lsb			4		GCDGPSLSB				
118	CD Fire Acknowledge 40 bit Latch Value 32 lsb			4		GCDFAKLSB				
122	CD Fire Cmd 40 bit Latch Value 32 lsb			4		GCDFCMDLSB				
126	Spare			1						
127	CD Fire Cmd 40 bit Latch Value 8 msb			1		GCDFCMDMSB				
128	CD Fire Acknowledge 40 bit Latch Value 8 msb			1		GCDFAKMSB				
129	CD GPS 40 bit Latch Value 8 msb			1		GCDGPSMSB				
130	CD FIRE ACKNOWLEDGE COUNTER					GCDFAKCTR		0x0000FFF0		
130	CD Data Ready Counter			4		GCDDRCTR		0x000000FF		
134	CD Data Ready Interrupt					GCDDATRDY		0x00000008		0=Enabled, 1=Disabled
134	CD Interrupt Source			4		GCDIDLESRC		0x000003000		1=Fire Command, 2=Fire Acknowledge
134	CD Pulse Width Limit Violation Accumulating Counter			4		GCDPWACCU				
142	CD Long Pulse Violation 4sec Counter			1		GCDPWLONG				
143	CD Short Pulse Violation 4sec Counter			1		GCDPWSHORT				
144	CD Pulse Width Most Significant Byte			1		GCDPWMSB				
145	Spare			1		GCDSPARE [1]				

Pkt Name App Id	Large Software Tlm #2 55	Name	Idx	Size in Octets	Mnemonics	Frequency Interval	Size	376 0.2500 4.000	Octets Hz seconds	Description
Offset in Octets								Ident.# Mask		
146		DC Software Fail Count		2	GDCSWFC					Counts internal errors like timeout, shot count skip and PCI read/write errors. Sometimes occur on power on initialization. System can work correctly even if they occur.
148		DC Shot Count		2	GDCSHOTCNT					
150		DC X Position		1	GDCXPOS					
151		DC Y Position		1	GDCYPOS					
152		DC LPA Packets Sent		2	GDCLPAPKTSNT					
154		DC Test Mode Rate		2	GDCMODERATE					
156		DC Packets Sent		2	GDCPKTSNT					
158		DC Spare 1		2	GDCSPARE1					
160		DC Bytes Sent		4	GDCBYTESNT					
164		DC Output bit rate in BPS		4	GDCOUTRATE					
168		DC Interrupt register		4	GDCINTRGS					
172		DC Control latch register		4	GDCCTRLTCH					
176		DC Interrupt 1		4	GDCINT1			0x00000001	0=Disabled, 1=Enabled	
176		DC LPA Interrupt		4	GDCLPAIN1			0x00000002	0=Disabled, 1=Enabled	
176		DC Output FIFO Full Interrupt		4	GDCOUTFIF1			0x00000004	0=Disabled, 1=Enabled	
176		DC Output FIFO Empty Interrupt		4	GDCOUTFEIN1			0x00000008	0=Disabled, 1=Enabled	
176		DC RAM Busy Interrupt		4	GDCRAMBINT			0x00000010	0=Disabled, 1=Enabled	
176		DC Interrupt 6		4	GDCINT6			0x00000020	0=Disabled, 1=Enabled	
176		DC intr mask register		4	GDCINTMASK			0xFFFFFFFF		
180		DC FIFO Full		4	GDCFF			0x00000001	0=True, 1=False	
180		DC FIFO Almost Full		4	GDCFAF			0x00000004	0=True, 1=False	
180		DC FIFO Almost Empty		4	GDCFAE			0x00000002	0=True, 1=False	
180		DC FIFO Empty		4	GDCFE			0x00000008	0=True, 1=False	
180		DC fifo flags register		4	GDCFIFOLG			0xFFFFFFFF		
184		DC LPA Gain		4	GDCGAIN			0x00000007	0=4.00, 1=2.80, 2=2.15, 3=1.75, 4=1.47, 5=1.27, 6=1.12, 7=1.00	
184		DC LPA Reset		4	GDCRST			0x00000008	0=In Reset, Not in Reset	
184		DC LPA gain register		4	GDCLPAGAIN			0xFFFFFFFF		
188		DC LPA Frame Byte Count		4	GDCLPABYCNT			0x00003FFF		
188		DC LPA Packet (Frame) Count		4	GDCLPAPKTCNT			0x00FF0000		
188		DC LPA packet count register		4	GDCLPACNT			0xFFFFFFFF		
192		DC Spares		8	GDCSPARE2 [8]					
200		GP GPS 10 second Interrupt Count		2	GGPISRINT					
202		GP Number of Position Packets received		2	GGP153PKTS					
204		GP Number of Housekeeping packets sent		2	GGPHSPKTS					
206		GP Number of Ancillary Packets sent		2	GGPANPKTS					
208		GP Number of 40-bit Counter Pkts Requested		2	GGP40BPKTSS					
210		GP GPS 10 sec Pulse 40-Bit Counter Packets Received		2	GGP40BPKTSR					
212		GP Packets with bad X,Y,Z Position Data		2	GGPBADXYZCNT					This count increments any time the GP task encounters a position packet with a badly formatted or out of range (32768 < x,y,z < -32768) X, Y, Z in the s/c position packet
214		GP Packets with X,Y,Z Position Data Below Tolerance		2	GGPTOLERXYZ					

Pkt Name	Large Software Tim #2	Idx	Size in Octets	Mnemonics	Size Frequency Interval	376 Hz	Octets	Description
App Id	55					0.2500	seconds	
Offset in Octets	Name					Ident.#		
						Mask		
216	GP Number of Range Packets Sent		2	GGPRANGEPKT5				
218	GP Spares		22	GGSPARE [22]				
240	PC Software Error Count	4	2	GPCSWERRCNT				Counts internal errors like timeout, shot count skip and PCI read/write errors. Sometimes occur on power on initialization. System can work correctly even if they occur.
242	PC Shot Counter		2	GPCSHOTCNT				
244	PC SCIENCE MODE PACKETS SENT		2	GPCSCIPKT				
246	PC ENGINEERING MODE PACKETS SENT		2	GPCENGPKT				
248	PC ANCILLARY MODE PACKETS SENT		2	GPCANCPKT				
250	PC RANGE GATE DELAY PACKETS RECEIVED		2	GPCRGDPKTRV				
252	PC Spare 1		2	GPCSPARE1				
254	PC SPCM Gate Delay		2	GPCSPCMDLY				Units = Nanoseconds Poly=(0.0,128)
256	PC Background 1 Delay		2	GPCBGD1DLY				Units = Nanoseconds Poly=(0.0,128)
258	PC Background 2 Delay		2	GPCBGD2DLY				Units = Nanoseconds Poly=(0.0,128)
260	PC Range Gate Delay		2	GPCRGDLY				Units = Nanoseconds Poly=(0.0,128)
262	PC Board Hardware Mode			GPCHWMODE		0x00000007		1=Idle, 2=Engineering, 4=Science
262	PC Interrupt Source			GPCINTSRC		0x00003000		1=Fire Command, 2=Fire Acknowledge
262	PC Measurement Source			GPCMSMTRC		0x00004000		0=Fire Acknowledge, 1= Fire Command
262	PC Hardware Mode Status Word		4	GPCMODESTAT		0xFFFFFFFF		
266	PC SPCM 1 Enable/Disable			GPCSPCM1		0x00000100		0=Enabled, 1=Disabled
266	PC SPCM 2 Enable/Disable			GPCSPCM2		0x00000200		0=Enabled, 1=Disabled
266	PC SPCM 3 Enable/Disable			GPCSPCM3		0x00000400		0=Enabled, 1=Disabled
266	PC SPCM 4 Enable/Disable			GPCSPCM4		0x00000800		0=Enabled, 1=Disabled
266	PC SPCM 5 Enable/Disable			GPCSPCM5		0x00001000		0=Enabled, 1=Disabled
266	PC SPCM 6 Enable/Disable			GPCSPCM6		0x00002000		0=Enabled, 1=Disabled
266	PC SPCM 7 Enable/Disable			GPCSPCM7		0x00004000		0=Enabled, 1=Disabled
266	PC SPCM 8 Enable/Disable			GPCSPCM8		0x00008000		0=Enabled, 1=Disabled
266	PC SPCM STATUS		4	GPCSPCMSTAT		0xFFFFFFFF		
270	PC FIRE ACKNOWLEDGE COUNTER			GPCFACRCTR		0x0000FF00		
270	PC Data Ready Counter		4	GPCDRCNT		0x000000FF		
274	PC SPCM 1 Raw Counts			GPCSPCM1RAW		0x000000FF		
274	PC SPCM 2 Raw Counts			GPCSPCM2RAW		0x0000FF00		
274	PC SPCM 3 Raw Counts			GPCSPCM3RAW		0x00FF0000		
274	PC SPCM 4 Raw Counts			GPCSPCM4RAW		0xFF000000		
274	PC SPCM 1 THROUGH 4 RAW COUNTS		4	GPCSPCM1TO4		0xFFFFFFFF		
278	PC SPCM 5 Raw Counts			GPCSPCM5RAW		0x000000FF		
278	PC SPCM 6 Raw Counts			GPCSPCM6RAW		0x0000FF00		
278	PC SPCM 7 Raw Counts			GPCSPCM7RAW		0x00FF0000		
278	PC SPCM 8 Raw Counts			GPCSPCM8RAW		0xFF000000		
278	PC SPCM 5 THROUGH 8 RAW COUNTS		4	GPCSPCM5TO8		0xFFFFFFFF		
282	PC SPCM Duty Cycle		4	GPCDUTYCYCLE		0xFFFFFFFF		
286	PC Coarse Borehole Calibration X Start Pos		2	GPCSTARTX				

Pkt Name App Id	Large Software Tim #2 55	Name	idx	Size in Octets	Mnemonics	Frequency Interval	376 0.2500 4.000	Octets Hz seconds	Description
Offset in Octets									
288		PC Coarse BoreSite Calibration Y Start Pos		2	GPCSTARTY				
290		PC Fine BoreSite Calibration X Start Pos		2	GPCFSTARTX				
292		PC Fine BoreSite Calibration Y Start Pos		2	GPCFSTARTY				
294		PC Coarse BoreSite Calibration X Increment		2	GPCCINCX				
296		PC Coarse BoreSite Calibration Y Increment		2	GPCCINCY				
298		PC Fine BoreSite Calibration X Increment		2	GPCFINCX				
300		PC Fine BoreSite Calibration Y Increment		2	GPCFINCY				
302		PC Coarse BoreSite Cal Integration Seconds		2	GPCCINTSEC				
304		PC Fine BoreSite Cal Integration Seconds		2	GPCFINTSEC				
306		PC BoreSite Calibration Best X Position		2	GPCBPOSX				
308		PC BoreSite Calibration Best Y Position		2	GPCBPOSY				
310		PC BoreSite Cal Seconds Remaining		2	GPCSECREM				
312		Spares		10	GFCLRGSPR2 [10]				
322		CT State Machine Current State		1	GCTSTATE				0=Unknown, 1=Reset, 2=Timeout, 3=Acquire Sync, 4=Wait for Muxes, 5=Process Telemetry, 6=Unknown
323		CT COMMAND ECHO ERRORS		1	GCTCMDEERR				
324		CT LM BOARD CMDS RECEIVED		1	GCTLMCMDCRC				
325		CT TM BOARD CMDS RECEIVED		1	GCTTMCMDRC				
326		CT MC BOARD CMDS RECEIVED		1	GCTMCCMDRC				
327		CT HK BOARD CMDS RECEIVED		1	GCTHKCMDRC				
328		CT HVPS Ccmds Received		1	GCTHVCMDRC				
329		CT PDU Ccmds Received		1	GCTPDCMDRC				
330		CT HW TLM 1 PACKETS SENT		1	GCTHW1PS				
331		CT HW TLM 2 PACKETS SENT		1	GCTHW2PS				
332		CT HW TLM 3 PACKETS SENT		1	GCTHW3PS				
333		CT HW TLM 4 PACKETS SENT		1	GCTHW4PS				
334		CT HW TLM 5 PACKETS SENT		1	GCTHW5PS				
335		CT DWELL PACKETS SENT		1	GCTDWLPS				
336		CT ANCILLARY PACKETS SENT		1	GCTANPS				
337		CT TIMEOUT COUNT		1	GCTTOCNT				
338		CT INTERRUPT COUNT		1	GCTINTCNT				
339		CT Shot Counter Errors		1	GCTSCNTER				
340		CT Dwell Mode		1	GCTDWELL				0=None, 1=LMB, 2=HK, 4=TCM, 8=MCS, 16=PDU, 32=HVPS
341		CT Dwell Channel		1	GCTDWLCH				
342		CT Laser Monitor Board Mux Error Counter		1	GCTLMMXER				
343		CT Housekeeping Board Mux Error Counter		1	GCTHMMXER				
344		CT Housekeeping Board Submux Error Counter		1	GCTHKSMMXER				
345		CT Temperature Controller Board Mux Error Counter		1	GCTTMMXER				
346		CT Mechanism Controller Board Mux Error Counter		1	GCTMCMXER				
347		CT High Voltage Power Supply Mux Error Counter		1	GCTHVMXER				
348		CT Power Distribution Unit Mux Error Counter		1	GCTPDMXER				
349		CT Command Echo Success Count		1	GCTCESCNT				

Pkt Name App Id	Large Software Tim #2 55	idx	Size in Octets	Mnemonics	Frequency Interval	Size Interval	376 0.2500 Hz	Octets seconds	Description
Offset In Octets	Name						Ident:# Mask		
350	CT Event Messages Enabled/Disabled Flag			GCTEVTMF1FLG			0x0001	0=All Enabled, 1=Some Disabled	
350	CT Shot Count Error Flag			GCTSHCTEF			0x0002	0=OK, 1=Error	
350	CT Laser Monitor Board Mux Error Flag			GCTLMX1XEF			0x0004	0=OK, 1=Error	
350	CT Housekeeping Board Mux Error Flag			GCTHRMXEF			0x0008	0=OK, 1=Error	
350	CT Housekeeping Board Submux Error Flag			GCTHKSMBEF			0x0010	0=OK, 1=Error	
350	CT Temperature Controller Board Mux Error Flag			GCTTMX1XEF			0x0020	0=OK, 1=Error	
350	CT Mechanism Controller Board Mux Error Flag			GCTMCX1XEF			0x0040	0=OK, 1=Error	
350	CT Power Distribution Unit Mux Error Flag			GCTPDMXEF			0x0080	0=OK, 1=Error	
350	CT High Voltage Power Supply Mux Error Flag			GCTHVX1XEF			0x0100	0=OK, 1=Error	
350	CT Ancillary Packet Allocation Error Flag		2	GCTANPKTEF			0x0200	0=OK, 1=Error	
350	CT Suppressed Event Message Error Flags			UN_GCTERRFLG					
352	CT LHP1 Temperature Control Enabled Flag			GCTLHP1ENAB			0x01	0=Off, 1=On	
352	CT LHP1 Temperature Control Active Flag			GCTLHP1ACT			0x02	0=Idle, 1=Active	
352	CT LHP1 Temperature Control State		1	UN_GCTLHP1STATE					
353	CT LHP2 Temperature Control Enabled Flag			GCTLHP2ENAB			0x01	0=Off, 1=On	
353	CT LHP2 Temperature Control Active Flag			GCTLHP2ACT			0x02	0=Idle, 1=Active	
353	CT LHP2 Temperature Control State		1	UN_GCTLHP2STATE					
354	CT LHP1 Temperature Setpoint		1	GCTLHP1TSET					
355	CT LHP2 Temperature Setpoint		1	GCTLHP2TSET					
355	CT LHP1 Temperature Control Counter		1	GCTLHP1CCT					
357	CT LHP2 Temperature Control Counter		1	GCTLHP2CCT					
358	CT LHP1 Minimum Temperature (Tmin)		1	GCTLHP1TMIN					
359	CT LHP2 Minimum Temperature (Tmin)		1	GCTLHP2TMIN					
360	CT LHP1 Temperature Change (Delta)		1	GCTLHP1DELTA					
361	CT LHP2 Temperature Change (Delta)		1	GCTLHP2DELTA					
362	CT LHP1 Temperature Control Cycle Time		1	GCTLHP1CYCLE					
363	CT LHP2 Temperature Control Cycle Time		1	GCTLHP2CYCLE					
364	CT Housekeeping Board Submux Telemetry Update Flag			GCTHKSUPD			0x01	0=Paused, 1=OK	
364	CT Misc Status Flags		1	UN_GCTLMFLG					
365	CT Spares		11	GCTSPARE2 [11]					

Pkt Name	DSP Code Memory Dump				828	Octets
App Id	31					
Offset in Octets	Name	idx	Size in Octets	Mnemonics	Ident.#	Description
0	Primary Header		6			
6	Secondary Header(time stamp)		8			Time when packet is sent
14	Dump Packet CRC Error		2			0=No Errors 1=CRC Error Detected
16	Start address		4			DSP processor address
20	Number of 48-bit words in packet		4			
24	Type		4			0=data memory, 1=program memory
						100 48 bit-words. Every 2 consecutive 32-bit words contain a 48-bit word. The first 32-bit word contains the most significant 32 bits and the second contains the least significant 16-bits with the upper 16 bits zero filled.
28	Data		800			

Filename: GLAS_HK_PKTs.xls

Page 1 of 8

Worksheet: Other Pkts

Pkt Name	DSP Data Memory Dump				Size	828	Octets
App Id	32						
Offset in Octets	Name	idx	Size in Octets	Mnemonics	Ident.#	Description	
0	Primary Header		6				
6	Secondary Header(time stamp)		8			Time when packet is sent	
14	Dump Packet CRC Error		2			0=No Errors 1=CRC Error Detected	
16	Start address		4			DSP processor address	
20	Number of 32-bit words in packet		4				
24	Type		4			0=data memory, 1=program memory	
28	Data		800			200 32-bit words	

Filename: GLAS_HK_PKTs.xls

Page 2 of 8

Worksheet: Other Pkts

Pkt Name	C&T Dwell Packet				Size	336	Octets
App Id	33						
Offset in Octets	Name	idx	Size in Octets	Mnemonics	Ident.#	Description	
0	Primary Header		6				
6	Secondary Header(time stamp)		8			Time when packet is sent	
14	C&T Board where telemetry point that is being dwelled on		1			0=invalid, 1= HK, 2=TCM, 3=MCS, 4=PDU, 5=HVPS, 6=LMB	
15	Telemetry channel(or point) to dwell on		1			Mux value from Register	
16	Data from 1st second(older)		80			8 or 12 bit data from C&T Telemetry Register	
96	Data from 2nd second		80				
176	Data from 3rd second		80				
256	Data from 4th second		80				

Filename: GLAS_HK_PKTts.xls

Page 3 of 8

Worksheet: Other Pkts

Pkt Name App Id	Memory Dwell Packets 1 & 2 27,28	idx	Size in Octets	Mnemonics	Size	212	Octets	Description
Offset in Octets	Name							
0	Primary Header		6					
6	Secondary Header(time stamp)		8					Time when packet is sent
14	The number of addresses currently dwelled on by Dwell Table 1 or 2		2	GMDADDRPKT1 GMDADDRPKT2				
16	The dwell rate for Table 1 or 2		2	GMDRATEPKT1 GMDRATEPKT2				$[(rate) * (1/8) \text{ sec}]$, must be 1/2 second or greater, Polynomial coeff=(0.0, 0.125)
18	The values sampled by Memory Dwell Table 1 or 2		192	GMDDATA1[48] GMDDATA2[48]				Data stored as 48 'UJINT32' values
210	Spare		2	GMDSPARE3 GMDSPARE4				Spare to make packet divisible by 4
Note:	There are 2 copies of this packet one for each memory dwell table.							

Pkt Name	Event Message Packet				Size	80	Octets
App Id	34						
Offset in Octets	Name	idx	Size in Octets	Mnemonics	Ident.#	Description	
0	Primary Header		6				
6	Secondary Header(time stamp)		8			Time when packet is sent	
14	Event Message Characters		66			66 bytes that contain a ASCII text message to be displayed on GLAS operator console.	

Filename: GLAS_HK_PKTS.xls

Page 5 of 8

Worksheet: Other Pkts

Pkt Name	Memory Dump Packet				Size	224	Octets
App Id	35	idx	Size in Octets	Mnemonics	Ident.#	Description	
Offset in Octets	Name	idx	Size in Octets	Mnemonics	Ident.#	Description	
0	Primary Header		6				
6	Secondary Header(time stamp)		8			Time when packet is sent	
14	Processor ID		2	GSMPRCID			
16	Current Dump Copy Number		2	GSMCPNUM1			
18	Memory Address of First Word in this Packet		4	GSMSRCADD			
22	Num. of Words Dumped in this Packet		2	GSMNUMWDS1			
24	Dumped Data Words		200	GSMDDPDATA1[100]			

Filename: GLAS_HK_PKTIs.xls

Page 6 of 8

Worksheet: Other Pkts

Pkt Name		Table Dump Packet		Size		224		Octets	
App Id	36								
Offset in Octets	Name	idx	Size in Octets	Mnemonics	Ident.#	Description			
0	Primary Header		6						
6	Secondary Header(time stamp)		8			Time when packet is sent			
14	Table Id Number		2	GSMtblID1					
16	Current Table Dump Copy Number		2	GSMCPNUM					
18	Table Offset		2	GSMtblOS					
20	Num. of Words Dumped in this Packet		2	GSMNUMWDS					
22	Table Source Type		2	GSMtblSRC		1=EEPROM, 2=RAM,3=BUFFER			
24	Dumped Table Data Words		200	GSMIDPDATA[100]					
<hr/>									
Pkt Name		GLAS Data Types Packet		Size		72		Octets	
App Id	48								
Offset in Octets	Name	idx	Size in Octets	Mnemonics	Ident.#	Description			
0	Primary Header		6						
6	Secondary Header(time stamp)		8			Time when packet is sent			
14	Data Types Packet Fixed Pattern		58						
<hr/>									
Pkt Name		Etfalon Calibration Packet		Size		2076		Octets	
App Id	37								

Offset in Octets	Name	idx	Size in Octets	Mnemonics	Ident.#	Description
0	Primary Header		6			
6	Secondary Header(time stamp)		8			Time when packet is sent
14	Spare byte in GLAS time field		1			
15	Etalon Calibration Starting Time		6	GCTECSTIME		
21	Spare byte in GLAS time field		1			
22	Etalon Calibration Start Temperature		1	GCTECSTRTT		
23	Etalon Calibration Stop Temperature		1	GCTECSTOPT		
24	Etalon Calibration Temperature Step		1	GCTECTSTEP		
25	Etalon Calibration Averaging Time		1	GCTECAVGTIM		
26	Etalon Calibration Settle Time		2	GCTECSTLTIM		
28	Etalon Calibration Measured On-Axis Trans.		1024	GCTELECTRONI[256]		
1052	Etalon Calibration Measured Off-Axis Trans.		1024	GCTECTROFF[256]		

Worksheet: Other Pkts

Page 8 of 8

Filename: GLAS_HK_PKTts.xls

B.2 Science Packet Descriptions

Pkt Name	App Id	Size in bytes	Pkt Freq. in Hertz	Pkt Interval in seconds	Rate bps	Output to		Confidence	CCSDS Primary Header
						SSR	1553 Bus		
	decimal					HK	Diag	H, M, L	hex
Altimeter Digitizer Data-Large	12	6856	4	0.25	219392.0	No	No	High	080C C000 1AC1
Altimeter Digitizer Data-Small	13	3416	4	0.25	109312.0	Yes	No	High	080D C000 0D51
AD Eng Mode - One Shot	14	700	1	1		Yes	No	High	080E C000 02B5
Photon Counter (PC) Science Pkt	15	8112	1	1	64896.0	Yes	No	High	080F C000 1FA9
PC Eng Pkt	16	8236	1	1		Yes	No	High	0810 C000 2025
Cloud Digitizer (CD) Science Pkt	17	7576	1	1	60608.0	Yes	No	High	0811 C000 1D91
CD Eng Pkt	18	5616	1	1		Yes	No	High	0812 C000 15E9
Ancillary Science Pkt	19	1368	1	1	10944.0	Yes	No	High	0813 C000 0551
LPA Data Pkt	26	4056	4	0.25	129792.0	Yes	No	High	081A C000 0FD1
Command History Packet	49	296	Async			Yes	No		0831 C000 0121
Spare	40								
LPA 80x80 Test Data Pkt	126	6416	Async			Yes	No	High	087E C000 1909
Bore-site Calibration Results Pkt	38	1816	Async			Yes	No	High	0826 C000 0711
* This total assumes a 55%-45% distribution between Alt. Digitizer Large and Small Data Packets						Total Rate* 436096.0 bps			
and does NOT include 1553. Asynchronous Data Packets, Gyro or LRS Data									
Notes: 1- The size of all packets going to the SSR must be a multiple of 4. This is because the FIFO width is 32 bits									
2- Max Packet Size to SSR is 16 Kbytes. This is the size of the FIFO									
3- LPA 80x80 Test Packet is not use during Flight, but only for integration									
1- Mnemonics use only 'G' as prefix to indicate GLAS (instead of the GL)									
2- Mnemonics for the CCSDS header are not in spreadsheet.									
Suggested Mnemonic names are:									
GPxxxPVNO	0..2	1st	Mask						
GPxxxPCKT	3	1st	Word						
GPxxxSHDF	4	1st							
GPxxxID	5..15	1st							
GPxxxSEGF	0..1	2nd							
GPxxxSCNT	2..15	2nd							
GPxxxPLEN	0..15	3rd							
GPxxxSTIME		4th...7th							
where xxx is the app id in hex									
3- The shot counter is only a 8 bit counter. Where it is depicted as a two or four octet entity it contains padding in the upper bytes.									

Filename: GLAS_SCI_PKT.s.xls

Page 1 of 1

Worksheet: Summary

Change History			
Name	Date	Version	Change Description
M. Maldonado	22-Jan-99	1.0	Initial Creation
M. Maldonado	25-Jan-99	1.1	Added Button fro Print all, Changed heading and footer on Ancillary data packet, Removed not applicable notes
J.Firer	25-Jan-99	1.1	Added calculated weight field, fixed sizes
M.Maldonado	13-May-99	2.0	Added CD engineering, PC Engineering, moved OTS stuff to ancillary, added gain setting
M.Maldonado	17-May-99	2.0	Added 40 instances of 532 energy in ancillary
M.Maldonado	21-May-99	2.0	Changes per Jenny Geigers review. Corrected number of samples in CD Science Data. And reordered Fire Command and Fire Acknowledge 40 bit count in Ancillary data packet.
M.Maldonado	17-Sep-99	2.0	Corrected ancillary byte offset 358 detector status to be 2 bytes per Dave Hancock suggestions
M.Maldonado	19-Nov-99	2.0	This make it even number of bytes in that section.
M.Maldonado, D. Molock	08-Dec-99	2.0	Added Command History packet
M.Maldonado	19-Jan-00	3.0	Added spares for CD Science to be aligned at 4-byte boundaries per Jenny Geigers Instructions
Steve Siegel	21-Jan-00	3.0	Corrected AD large and small and AD ancillary data per meeting with David Hancock and others
Dwaine Molock	24-Jan-00	3.0	Removed 532 energy from PC Science Packet, left spare in its place
M. Maldonado	23-Feb-00	3.0	Converted CD and PC Ancillary data not used into spares
			Corrected size of spacecraft position and gps time packet to not include CCSDS header
			Corrected CD Eng packet to be every other shot instead of the first 20 shots
			Corrected spelling of shot counter in PC Science packet definition
			Replaced LIDAR Delay with Range Gate Delay for PC task ancillary data
			Modified the AD large, small & ancillary science packets according to comments received from David Hancock.
			Modified comments on PC Science and Ancillary Packet per Steve Palms comments
			Corrected size of CD shot sample to match PC
			Additional Changes to descriptions in AD pkts
			Changed CD Eng packet to be every other shot of unaveraged data
			Added Tolerance for Coincidence of Filter to Ancillary tim
			Modified Ancillary GPS/DEM Section
			Modified Ancillary C&T Section
			Added valid number of commands to cmd history packet and corrected print areas in ancillary
			Corrected LPA Comment that said x, y window starting position range was 1 to 80 to say 0 to 79
			and moved spare in LPA packet to after secondary header from end of packet
			Changed all headers to say Rev A and spelled out Telemetry
M.Maldonado, Robert McGraw	28-Apr-00	Rev A	Added to ancillary ilm pkt checkin flags and start of frame shot counter
M.Maldonado, Dwaine Molock	8-May-00	Rev A	Added spare bytes to make packet sizes divisible by 4
Dwaine Molock	10-May-00	Rev A	Updated AD large and small and AD ancillary data per Dwaine Molock comments
M.Maldonado	10-Jul-00	Rev A	Realignment for DWORDS
			Corrected incorrect offset calculation in app ids 12 and 14 after the CCSDS header

PKT Name App Id	Allmeter Digifilter - Large SCI PKT 1Z	Idx	Size in Octets	Frequency Mnemonics	6856 0x760 Ident # Mask	Octets Hz seconds	Description	Type	Data Range/Formula	DSP Address
0	Primary Header	6	8			Time when sent from AD task				
14	Secondary Header (time stamp)	8	2			Spare bytes				
16	Shot #/ Data in Packet	4	2			Corresponds to the data that follows. Unit=shots			1-200	
AD Land Pkt Shot Count		1	4	GADLSHC		Peak of Transmit Pulse stored within 48 samples. Unit=counts			0-255	0300h to 030bh
AD Land Pkt Transmit Waveform		2	48	GADLXW						
AD Land Pkt Transmit Pulse Time		3	4	GADLXPT		Address in nanoseconds resolution of the Transmit Pulse Peak as measured from the start of Acquisition Memory, i.e. start of digitization.			0 - 500000	030ch
Transmit Peak Internal SW Failure		5	6	GADLXSWF	0x0001	0=No Problem; 1=Internal software failure				
Transmit Peak Search Failure (below threshold)		6	6	GADLXPF	0x0002	0=No Problem; 1=Peak Below Threshold				
Transmit Peak Search Failure Latch		7	6	GADLXPL	0x0004	0=No Problem; 1=Peak Never Found (latch)				
AD Land Pkt Transmit Peak Failure Bits		4	4	GADLXPAIL		Starting Address in nanosecond resolution of the Transmit Pulse sample relative to the start of digitization.				
Starting Address of Transmit Pulse Sample		8	4	GADLXWST		Address (in nanosecond resolution) of the 2000-byte surface echo data dump (as measured from the start of Acquisition Memory, i.e. Start of digitization). Last in time.			0 - 500000	030eh
Ending Address of Range Response		9	4	GADLRWET		Address (in nanosecond resolution) of the 2000-byte surface echo data dump (as measured from the start of Acquisition Memory, i.e. Start of digitization). Last in time.			0 - 5100000	030fh
Last Threshold Crossing Location for Selected Filter		10	4	GADLSFTET		Address (in nanosecond resolution) of the detected next to last threshold crossing (as measured from the start of Acquisition Memory, i.e. Start of digitization). Last in time.			0 - 5100000	0310h
Next to Last Threshold Crossing Location for Selected Filter		11	4	GADLSFLET		Address (in nanosecond resolution) of the detected next to last threshold crossing (as measured from the start of Acquisition Memory, i.e. Start of digitization). Next to last in time). Also called the leading edge. Set to 0 if a threshold crossing was NOT detected.			0 - 5100000	0311h
4ns Filter Peak Height		12	2	GADLF4PH		Peak value returned by the FIR filter engine for the 4ns Filter. Unit=counts			0 - 255	0312h
8ns Filter Peak Height		13	2	GADLF8PH		Peak value for the selected filter returned by the FIR filter engine. Set to 0 if a threshold crossing was not detected. Unit=counts			0 - 255	0312h
Peak Value for the selected filter		14	4	GADLSFPH		Address (in nanosecond resolution) of the detected peak value (as measured from the start of Acquisition Memory, i.e. Start of digitization). Set to 0 if a threshold crossing was NOT detected. Filter with the highest weight (0 for 4 nsec filter; 1 for 8 nsec filter; 2 for 16 nsec filter; 3 for 32 nsec filter; 4 for 64 nsec filter; 5 for 128 nsec filter). May or may not be selectable! If no selectable filter can be chosen, then the last successful filter, selectable or NOT, is chosen.			0 - 255	0316h
Peak Value Location for the selected filter		15	4	GADLSFPT		Threshold crossing values used to find the last threshold crossings for the selected filter. Unit=counts				
Filter Selected		16	4	GADLSFNUM		Calculated Mean value for the 4ns filter.				
Threshold Value		17	4	GADLSFTHR		Calculated Standard Deviation for the 4ns filter.			0.01 - 10.000.0	0317h
Mean Value of the Background Noise Mean for 4 ns filter		18	4	GADLNMLU		Peak failure word. Bit masks are defined below.			0.01 - 10.000.0	0318h
Standard Deviation of the Background Noise for the 4 ns filter		19	4	GADLNSIG4 GADLRFCF	0x0000003F 0x00000001	0=No Problem; 1=No first crossing found on 4-nsec filter				
AD Land Pkt Return Peak Failure Word		20			0x00000002	0=No Problem; 1=No first crossing found on 8-nsec filter				
No first crossing (rising edge) on 4-nsec filter flag		21			0x00000004	0=No Problem; 1=No first crossing found on 16-nsec filter				
No first crossing (rising edge) on 8-nsec filter flag		22			0x00000008	0=No Problem; 1=No first crossing found on 32-nsec filter				
No first crossing (rising edge) on 16-nsec filter flag		23			0x00000010	0=No Problem; 1=No first crossing found on 64-nsec filter				
No first crossing (rising edge) on 32-nsec filter flag		24			0x00000020	0=No Problem; 1=No second crossing found on 128-nsec filter				
No first crossing (rising edge) on 64-nsec filter flag		25			0x00000040	0=No Problem; 1=No second crossing found on 256-nsec filter				
No second crossing (falling edge) on 4-nsec filter flag		26			0x00000080	0=No Problem; 1=No second crossing found on 8-nsec filter				
No second crossing (falling edge) on 8-nsec filter flag		27			0x00000100	0=No Problem; 1=No second crossing found on 16-nsec filter				
No second crossing (falling edge) on 16-nsec filter flag		28			0x00000200	0=No Problem; 1=No second crossing found on 32-nsec filter				
No second crossing (falling edge) on 32-nsec filter flag		29			0x00000400	0=No Problem; 1=No second crossing found on 64-nsec filter				
No second crossing (falling edge) on 64-nsec filter flag		30			0x00000800	0=No Problem; 1=No second crossing found on 128-nsec filter				
No second crossing (falling edge) on 128-nsec filter flag		31			0x000000FC	Leading Edge Failure Mask. Bit masks are defined below.				
AD Land Pkt Leading Edge Failure Mask		120			GADLLEF					
First Sample in range >= to threshold for 4 ns filter		120			0x00001000	0=No Problem; 1=First sample in range greater than or equal to threshold for 4 nsec filter				
First Sample in range >= to threshold for 8 ns filter		120			0x00002000	0=No Problem; 1=First sample in range greater than or equal to threshold for 8 nsec filter				
First Sample in range >= to threshold for 16 ns filter		120			0x00004000	0=No Problem; 1=First sample in range greater than or equal to threshold for 16 nsec filter				

Pkt Name App Id	Altimeter Digitizer - Large Sci Pkt		Size Interval Mnemonics	6856 4 0.250 Ident # Mask	Octets Hz	Description	Type	Data Range/Formula	DSP Address
	Offset	Name							
120	120	First Sample in range >= to threshold for 32 ns filter		0x00008000		0- No Problem; 1- First sample in range greater than or equal to threshold for 32 nsec filter			
120	120	First Sample in range >= to threshold for 64 ns filter		0x00010000		0- No Problem; 1- First sample in range greater than or equal to threshold for 64 nsec filter			
120	120	First Sample in range >= to threshold for 128 ns filter		0x00020000		0- No Problem; 1- First sample in range greater than or equal to threshold for 128 nsec filter			
120	120	AD Land Pkt Training Edge Failure Mask		0x00030000		Training Edge Failure Mask 0- All filters were not rejected; 1- All filters were rejected. This flag will be set to true (1) if bits 0 through 5 in Range Status are set.	UINT_32		
120	120	AD Land Pkt Selection Failure		0x00040000		0- Select; 1- Fail	UINT_32		
120	120	AD Land Pkt Previous Selection Failure		0x00080000		Land packet filter failure mask. Individual filter bit masks are defined below.	UINT_32		
120	120	4 NS Filter Failure		0x00100000		0- OK; 1- Failure	UINT_32		
120	120	8 NS Filter Failure		0x00200000		0- OK; 1- Failure	UINT_32		
120	120	16 NS Filter Failure		0x00400000		0- OK; 1- Failure	UINT_32		
120	120	32 NS Filter Failure		0x00800000		0- OK; 1- Failure	UINT_32		
120	120	64 NS Filter Failure		0x01000000		0- OK; 1- Failure	UINT_32		
120	120	AD Land Pkt Return Range Failure		0x02000000		0- OK; 1- Failure	UINT_32		
120	120	AD Land Pkt Science Processing Ready Flag		0x04000000		0- Ready; 1- Failure	UINT_32		
120	120	Range Window Status Word		0x60000000		Bits 0 through 5 indicate if there was a first rising (SCANNING BACKWARDS) above the threshold for each of the various filters. Note that if there is no first rising, there CANNOT be a first falling value, so the appropriate "no second crossing" bit (bits 6 through 11) is also set. Bit 0 corresponds to bit 6, bit 1 corresponds to bit 7 and so on.	Bit Field (UINT_32)	N/A	0319h
148	148	Calculated Weights for all Filters	4	GADLFWGT		Results of weight formulas for all FFR filters.	UINT_32		0319h to 031fh
149	149	Altimeter Digitizer Raw Peak	24	GADLRWPH		Land packet raw waveform peak height	UINT_8	0 - 255	N/A
150	150	Altimeter Digitizer Selected Filter Coincidences	43	GADLSFNC		Land packet selected filter number of coincidences	UINT_8	0 - 255	N/A
150	150	Altimeter Digitizer Status Byte	43	GADLSTAT		Land packet gain status byte	UINT_8	0 - 255	N/A
150	150	Altimeter Digitizer Bypass Flag	43	GADLGBTYP	0x00000001	0- OK; 1- BYPASS	UINT_8	0 - 255	N/A
150	150	Altimeter Digitizer Bypass Timeout Flag	43	GADLBTNO	0x00000002	0- OK; 1- TIMEOUT	UINT_8	0 - 255	N/A
152	152	Surface Echo Data Sampling	44	GADLNDAP		Results of Gain Algorithm that was written to the hardware on the previous shot	UINT_32	0 - 544	N/A
154	154	Surface Echo Data Samples (may have been averaged)	45	GADLCOAMP		Indicates the type of Compression performed (0=N, 1=D, 2=T, 3=I) 544 bytes of digitized data averaged according to P/N:1 in inverse time order. (From latest in time to earliest in time)	UINT_32	0 - 1	N/A
700	700	Shot #2 Data in Packet	544	GADLRW		These 684 bytes of data have the same definition as the first 684 bytes in the packet	UINT_8	0 - 255	N/A
1384	1384	Shot #3 Data in Packet	684			These 684 bytes of data have the same definition as the first 684 bytes in the packet			
2068	2068	Shot #4 Data in Packet	684			These 684 bytes of data have the same definition as the first 684 bytes in the packet			
2752	2752	Shot #5 Data in Packet	684			These 684 bytes of data have the same definition as the first 684 bytes in the packet			
3436	3436	Shot #6 Data in Packet	684			These 684 bytes of data have the same definition as the first 684 bytes in the packet			
4120	4120	Shot #7 Data in Packet	684			These 684 bytes of data have the same definition as the first 684 bytes in the packet			
4804	4804	Shot #8 Data in Packet	684			These 684 bytes of data have the same definition as the first 684 bytes in the packet			
5488	5488	Shot #9 Data in Packet	684			These 684 bytes of data have the same definition as the first 684 bytes in the packet			
6172	6172	Shot #10 Data in Packet	684			These 684 bytes of data have the same definition as the first 684 bytes in the packet			

Pkt Name App Id	Altimeter Digitizer - Small Sci Pkt 13	Size Frequency Interval	3416 4 0.250	Octets Hz seconds	Description	Type	Data Range/Formula	DSP Address
Offset	Name	Idx, Size in Octets	Ident # Mask	seconds				
0	Primary Header	6		Time when sent from AD task	UINT_16			
6	Secondary Header (time stamp)	8		Spare bytes	UINT_16			
14	Spare	2						
16	Shot # Data In Packet	1		Corresponds to the data that follows	UINT_32			
20	Shot Counter	2		Peak of Transmit Pulse stored within 48 samples.	UINT_8		1-200 0-255	0300h to 030bh
20	Transmit Pulse	48		Address in nanosecond resolution of the Transmit Pulse start of digitization.				
68	Transmit Pulse Peak Location	3		Peak as measured from the start of Acquisition Memory, i.e. start of digitization.	UINT_32		0 - 500000	030ch
72	Transmit Peak Internal SW Failure	4	0x0001	0-No Problem; 1=Peak Not Found				
72	Transmit Peak Failure (below threshold)	4	0x0002	0-No Problem; 1=Peak Below Threshold				
72	Transmit Peak Failure (high)	4	0x0004	0-No Problem; 1=Peak Never Found				
72	AD Sea Pkt Transmit Peak Failure Word	4		Indicates the status of the Transmit Pulse.	Bit Field (UINT_32)	N/A		030dh
76	Starting Address of Transmit Pulse Sample	5		Starting Address in nanosecond resolution of the Transmit Pulse sample relative to the start of digitization.	UINT_32		0 - 500000	030eh
80	Ending Address of Range Response	6		Address (in nanosecond resolution) of the 2000-byte surface echo data dump (as measured from the start of Acquisition Memory, i.e. Start of digitization). Last in time.	UINT_32		0 - 5100000	030fh
84	Last Threshold Crossing Location for Selected Filter	7		Address, in nanosecond resolution, of the detected last threshold crossing (as measured from the start of Acquisition Memory, i.e. Start of digitization, that is, last in time). Also called the trailing edge. Set to 0 if threshold crossing was NOT detected.	UINT_32		0 - 5100000	0310h
88	Next to Last Threshold Crossing Location for Selected Filter	8		Address (in nanosecond resolution) of the detected next to last threshold crossing (as measured from the start of Acquisition Memory, i.e. Start of digitization. Next to last in time). Also called the leading edge. Set to 0 if a threshold crossing was NOT detected.	UINT_32		0 - 5100000	0311h
92	4ns Filter Peak Height	9		Peak value returned by the FIR filter engine for the 4ns Filter.	UINT_16		0 - 255	0312h
94	8ns Filter Peak Height	10		Peak value for the selected filter returned by the FIR filter engine. Set to 0 if a threshold crossing was not detected.	UINT_16		0 - 255	0312h
96	Peak Value for the selected filter	11		Address (in nanosecond resolution) of the detected peak value (as measured from the start of Acquisition Memory, i.e. Start of digitization). Set to 0 if a threshold crossing was NOT detected.	UINT_32		0 - 255	0313h
100	Peak Value Location for the selected filter	12		Filter with the highest weight (0 for 4 nsec filter; 1 for 8 nsec filter; 2 for 16 nsec filter; 3 for 32 nsec filter; 4 for 64 nsec filter; 5 for 128 nsec filter). May or may not be selectable! If no selectable filter can be chosen, then the last successful filter, selectable or NOT, is chosen.	UINT_32		0 - 5100000	0314h
104	Filter Selected	13		Threshold crossing values used to find the last threshold crossings for the selected filter.	UINT_32		0 - 5	0315h
108	Threshold Value	14		Calculated Mean value for the 4ns filter.	UINT_32		0 - 255	0316h
112	Mean Value of the Background Noise Mean for 4 ns filter	15		Calculated Standard Deviation for the 4ns filter.	UINT_32		0 - 255	0317h
116	Standard Deviation of the Background Noise for the 4 ns filter	16		Calculated Standard Deviation for the 4ns filter.	UINT_32		0 - 255	0318h
120	AD Sea Pkt Return Peak Failure Word	16		Sea packet return peak failure word. Individual bit masks are defined below.	UINT_32		0.0 - 10,000.0	
120	Threshold Crossing Failure Mask	16		Threshold crossing failure mask. Individual bit masks are defined below.	UINT_32		0.0 - 10,000.0	
120	No first crossing (rising edge) on 4-nsec filter flag	20	0x0000003F	0-No Problem; 1=No first crossing found on 4-nsec filter	UINT_32			
120	No first crossing (rising edge) on 8-nsec filter flag	21	0x00000001	0-No Problem; 1=No first crossing found on 8-nsec filter	UINT_32			
120	No first crossing (rising edge) on 16-nsec filter flag	22	0x00000002	0-No Problem; 1=No first crossing found on 16-nsec filter	UINT_32			
120	No first crossing (rising edge) on 32-nsec filter flag	23	0x00000008	0-No Problem; 1=No first crossing found on 32-nsec filter	UINT_32			
120	No first crossing (rising edge) on 64-nsec filter flag	24	0x00000010	0-No Problem; 1=No first crossing found on 64-nsec filter	UINT_32			
120	No first crossing (rising edge) on 128-nsec filter flag	25	0x00000020	0-No Problem; 1=No first crossing found on 128-nsec filter	UINT_32			
120	Leading Edge Failure Mask	26	0x000000C0	Leading edge failure. Individual bit masks are defined below.	UINT_32			
120	No second crossing (falling edge) on 4-nsec filter flag	26	0x00000040	0-No Problem; 1=No second crossing found on 4-nsec filter	UINT_32			
120	No second crossing (falling edge) on 8-nsec filter flag	27	0x00000080	0-No Problem; 1=No second crossing found on 8-nsec filter	UINT_32			
120	No second crossing (falling edge) on 16-nsec filter flag	28	0x00000100	0-No Problem; 1=No second crossing found on 16-nsec filter	UINT_32			
120	No second crossing (falling edge) on 32-nsec filter flag	29	0x00000200	0-No Problem; 1=No second crossing found on 32-nsec filter	UINT_32			
120	No second crossing (falling edge) on 64-nsec filter flag	30	0x00000400	0-No Problem; 1=No second crossing found on 64-nsec filter	UINT_32			

Worksheet: Alt Dig-Small

Page 1 of 2

Filename: GLAS_SCI_PKT.XIS

Pkt Name App Id	Allimeter Digitizer - Small Sci Pkt 13	Idx	Size in Octets	Frequency Interval	3416 Hz	Octets seconds	Description	Type	Data Range/Formula	DSP Address
Offset	Name			Mnemonics	Ident # Mask					
120	No second crossing(falling edge) on 128-nsec filter flag	31			0x00000800		0=No Problem; 1=No second crossing found on 128-nsec filter			
120	Trailing Edge Failure Mask			GADSTEF	0x0003F000		Trailing edge failure. Individual bit masks are defined below. 0=No Problem; 1=First sample in range greater than or equal to threshold for 4 nsec filter	UINT_32		
120	First Sample in range >= to threshold for 4 ns filter flag	32			0x00001000		0=No Problem; 1=First sample in range greater than or equal to threshold for 4 nsec filter			
120	First Sample in range >= to threshold for 8 ns filter flag	33			0x00002000		0=No Problem; 1=First sample in range greater than or equal to threshold for 8 nsec filter			
120	First Sample in range >= to threshold for 16 ns filter flag	34			0x00004000		0=No Problem; 1=First sample in range greater than or equal to threshold for 16 nsec filter			
120	First Sample in range >= to threshold for 32 ns filter flag	35			0x00008000		0=No Problem; 1=First sample in range greater than or equal to threshold for 32 nsec filter			
120	First Sample in range >= to threshold for 64 ns filter flag	36			0x00010000		0=No Problem; 1=First sample in range greater than or equal to threshold for 64 nsec filter			
120	First Sample in range >= to threshold for 128 ns filter flag	37			0x00020000		0=No Problem; 1=First sample in range greater than or equal to threshold for 128 nsec filter			
120	Sea Packet Selection Failure			GADSSSELF	0x00040000		Sea packet selection failure. 0=Select. 1=Fail	UINT_32		
120	Sea Packet Previous Selection Failure			GADSPSELF	0x00080000		Sea packet previous selection failure. 0=Select. 1=Fail	UINT_32		
120	Sea Packet Filter Failure Mask			GADSFFF	0x03F00000		Sea packet filter failure mask. Individual filter bit masks are defined below.	UINT_32		
120	4 NS Filter Failure			GADSF4F	0x00100000		0=OK 1=Failure	UINT_32		
120	8 NS Filter Failure			GADSF8F	0x00200000		0=OK 1=Failure	UINT_32		
120	16 NS Filter Failure			GADSF16F	0x00400000		0=OK 1=Failure	UINT_32		
120	32 NS Filter Failure			GADSF32F	0x00800000		0=OK 1=Failure	UINT_32		
120	64 NS Filter Failure			GADSF64F	0x01000000		0=OK 1=Failure	UINT_32		
120	128 NS Filter Failure			GADSF128F	0x02000000		0=OK 1=Failure	UINT_32		
120	AD Sea PRI Return Range Failure			GADSRANF	0x40000000		0=Range OK 1=Failure	UINT_32		
120	AD Sea PRI Science Processing Ready Flag			GADSRDYF	0x80000000		0=Ready 1=Failure	UINT_32		
120	Range Window Status Word	41	4				Bits 0 through 3 indicate if there was a first rising (SCANNING BACKWARDS) above the threshold for each of the various filters. Note that if there is no first rising, there CANNOT be a first falling value, so the appropriate "no second crossing" bit (bits 6 through 11) is also set. Bit 0 corresponds to bit 6, bit 1 corresponds to bit 7 and so on.	Bit Field (UINT_32)	0319h	
124	Calculated Weights for all Filters	42	24	GADSRWGT			Results of weight formulas for all FIR filters.	(INT_32) x 6	N/A	
148	Allimeter Digitizer Raw Peak	43	1	GADSRWPH			Sea packet raw waveform peak height	UINT_8	0 - 255	N/A
149	Allimeter Digitizer Selected Filter Coincidences	43	1	GADSRFNC			Sea packet selected filter number of coincidences	UINT_8	0 - 255	N/A
150	Allimeter Digitizer Status Byte	43	1	GADSGSTAT	0x00000001		Sea packet gain status byte	UINT_8	0 - 255	N/A
150	Allimeter Digitizer Bypass Flag	43	1	GADSLBTP	0x00000002		0=OK 1=TIMEOUT	UINT_8	0 - 255	N/A
150	Allimeter Digitizer Bypass Timeout Flag	43	1	GADSLTMO			Result of Gain Algorithm that was written to the hardware on the previous shot	UINT_8	0 - 255	N/A
151	Allimeter Digitizer Gain Setting	43	1	GADSGAIN			The 21 items here have the same definition as the first 21 items in this packet			
1036	Shot #4 Data in Packet		340				The 21 items here have the same definition as the first 21 items in this packet			
1376	Shot #5 Data in Packet		340				The 21 items here have the same definition as the first 21 items in this packet			
1716	Shot #6 Data in Packet		340				The 21 items here have the same definition as the first 21 items in this packet			
2056	Shot #7 Data in Packet		340				The 21 items here have the same definition as the first 21 items in this packet			
2396	Shot #8 Data in Packet		340				The 21 items here have the same definition as the first 21 items in this packet			
2736	Shot #9 Data in Packet		340				The 21 items here have the same definition as the first 21 items in this packet			
3076	Shot #10 Data in Packet		340				The 21 items here have the same definition as the first 21 items in this packet			

Pkt Name App Id	Altimeter Digitizer Eng Pkt - One Shot 14	Size Frequency	700 1	Octets Hz	Description	Type	Data Range/Formula	DSP Address
Offset	Name	Mnemonics	Ident.# Mask	idx	Size in Octets			
0	Primary Header				6			
6	Secondary Header (time stamp)				8			
14	Spare	GADESSPARE		1	2			
16	Shot Counter	GADESHC		1	4		1-200	0300h to 030bh
20	Transmit Pulse	GADEXW		2	48		0-255	
68	Transmit Pulse Peak Location	GADEXPT		3	4		0 - 500000	030ch
72	Transmit Pulse Internat SW Failure	GADEXSWF	0x0001	4	4			
72	Transmit Pulse Search Failure (below threshold)	GADEXF	0x0002	4	4			
72	Transmit Pulse Search Failure (Latch)	GADEXFL	0x0004	4	4			
72	AD Eng Pkt Transmit Pulse Status Word	GADEXFAL		4	4		N/A	030dh
76	Starting Address of Transmit Pulse Sample	GADEXWST		5	4		0 - 500000	030eh
80	Ending Address of Range Response	GADERWET		6	4		0 - 5100000	030fh
84	Last Threshold Crossing Location for Selected Filter	GADESFTET		7	4		0 - 5100000	0310h
88	Next to Last Threshold Crossing Location for Selected Filter	GADESFLET		8	4		0 - 5100000	0311h
92	4ns Filter Peak Height	GADEF4PH		12	2		0 - 255	0312h
94	8ns Filter Peak Height	GADEF8PH		13	2		0 - 255	0312h
96	Peak Value for the selected filter	GADESFPH		14	4		0 - 255	0313h
100	Peak Value Location for the selected filter	GADESFPPT		15	4		0 - 5100000	0314h
104	Filter Selected	GADESFNUM		16	4		0 - 5	0315h
108	Threshold Value	GADESFTHR		17	4		0 - 255	0316h
112	Mean Value of the Background Noise Mean for 4 ns filter	GADESNMU4		18	4		FLOAT (IEEE754) 0.0 - 10,000.0	0317h
116	Standard Deviation of the Background Noise for the 4 ns filter	GADENSIG4		19	4		FLOAT (IEEE754) 0.0 - 10,000.0	0318h

Pkt Name App Id	Altimeter Digitizer Eng Pkt - One Shot 14	Size Frequency	700 Hz	Octets	Type	Data Range/Formula	DSP Address
Offset	Name	Mnemonics	Ident.# Mask	Description	Type	Data Range/Formula	DSP Address
120	AD Eng Pkt Return Peak Failure Word	GADERFAIL		Eng packet return peak failure word. Individual bit masks are defined below.	UINT_32		
120	Threshold Crossing Failure Mask	GADETCF	0x0000003F	Threshold crossing failure mask. Individual bit masks are defined below.	UINT_32		
120	No first crossing(rising edge) on 4-nsec filter flag		0x00000001	0=No Problem; 1=No first crossing found on 4-nsec filter			
120	No first crossing(rising edge) on 8-nsec filter flag		0x00000002	0=No Problem; 1=No first crossing found on 8-nsec filter			
120	No first crossing(rising edge) on 16-nsec filter flag		0x00000004	0=No Problem; 1=No first crossing found on 16-nsec filter			
120	No first crossing(rising edge) on 32-nsec filter flag		0x00000008	0=No Problem; 1=No first crossing found on 32-nsec filter			
120	No first crossing(rising edge) on 64-nsec filter flag		0x00000010	0=No Problem; 1=No first crossing found on 64-nsec filter			
120	No first crossing(rising edge) on 128-nsec filter flag		0x00000020	0=No Problem; 1=No first crossing found on 128-nsec filter			
120	Leading Edge Failure Mask	GADELEF	0x00000FC0	Leading edge failure. Individual bit masks are defined below.	UINT_32		
120	No second crossing(falling edge) on 4-nsec filter flag		0x00000040	0=No Problem; 1=No second crossing found on 4-nsec filter			
120	No second crossing(falling edge) on 8-nsec filter flag		0x00000080	0=No Problem; 1=No second crossing found on 8-nsec filter			
120	No second crossing(falling edge) on 16-nsec filter flag		0x00000100	0=No Problem; 1=No second crossing found on 16-nsec filter			
120	No second crossing(falling edge) on 32-nsec filter flag		0x00000200	0=No Problem; 1=No second crossing found on 32-nsec filter			
120	No second crossing(falling edge) on 64-nsec filter flag		0x00000400	0=No Problem; 1=No second crossing found on 64-nsec filter			
120	No second crossing(falling edge) on 128-nsec filter flag		0x00000800	0=No Problem; 1=No second crossing found on 128-nsec filter			
120	Trailing Edge Failure Mask	GADETEF	0x0003F000	Trailing edge failure. Individual bit masks are defined below.	UINT_32		
120	First Sample in range >= to threshold for 4 ns filter flag		0x00001000	0=No Problem; 1=First sample in range greater than or equal to threshold for 4 nsec filter			
120	First Sample in range >= to threshold for 8 ns filter flag		0x00002000	0=No Problem; 1=First sample in range greater than or equal to threshold for 8 nsec filter			
120	First Sample in range >= to threshold for 16 ns filter flag		0x00004000	0=No Problem; 1=First sample in range greater than or equal to threshold for 16 nsec filter			
120	First Sample in range >= to threshold for 32 ns filter flag		0x00008000	0=No Problem; 1=First sample in range greater than or equal to threshold for 32 nsec filter			
120	First Sample in range >= to threshold for 64 ns filter flag		0x00010000	0=No Problem; 1=First sample in range greater than or equal to threshold for 64 nsec filter			
120	First Sample in range >= to threshold for 128 ns filter flag		0x00020000	0=No Problem; 1=First sample in range greater than or equal to threshold for 128 nsec filter			
120	Eng Packet Selection Failure	GADESELF	0x00040000	Eng packet selection failure. 0=Select 1=Fail	UINT_32		
120	Eng Packet Previous Selection Failure	GADEPSELF	0x00080000	Previous selection failure. 0=Select 1=Fail	UINT_32		
120	Eng Packet Filter Failure Mask	GADEFF	0x03F00000	Eng packet filter failure mask. Individual filter bit masks are defined below.	UINT_32		
120	4 NS Filter Failure	GADEF4F	0x00100000	0=OK 1=Failure	UINT_32		
120	8 NS Filter Failure	GADEF8F	0x00200000	0=OK 1=Failure	UINT_32		
120	16 NS Filter Failure	GADEF16F	0x00400000	0=OK 1=Failure	UINT_32		
120	32 NS Filter Failure	GADEF32F	0x00800000	0=OK 1=Failure	UINT_32		
120	64 NS Filter Failure	GADEF64F	0x01000000	0=OK 1=Failure	UINT_32		
120	128 NS Filter Failure	GADEF128F	0x02000000	0=OK 1=Failure	UINT_32		

Pkt Name App Id	Altimeter Digitizer Eng Pkt - One Shot 14	Size Frequency	700 1	Octets Hz	Description	Type	Data Range/Formula	DSP Address
Offset	Name	Mnemonics	Ident.# Mask	idx	Size in Octets			
120	AD Eng Pkt Return Range Failure	GADERANF	0x40000000			UINT_32		
120	AD Eng Pkt Science Processing Ready Flag	GADERDYF	0x80000000			UINT_32		
120	Range Window Status Word			41	4	Bit Field (UINT_32)	N/A	0319h to 031ah to 031fh
124	Calculated Weights for all Filters	GADERFWGT		42	24	UINT_32		N/A
148	Altimeter Digitizer Raw Peak	GADERWPH		43	1	UINT_8	0 - 255	N/A
149	Altimeter Digitizer Selected Filter Coincidences	GADEFNC		43	1	UINT_8	0 - 255	N/A
150	Altimeter Digitizer Status Byte	GADEGSTAT		43	1	UINT_8	0 - 255	N/A
150	Altimeter Digitizer Bypass Flag	GADEGLBYP	0x00000001	43	1	UINT_8	0 - 255	N/A

Worksheet: AD Eng

Page 3 of 3

Filename: GLAS_SCI_PKTs.xls

Pkt Name	Photon Counter Sci Pkt	8112	Octets	Type	Data Range/Formula
App Id	15	1	Hz		
Offset	Name	Frequency Interval	seconds	Type	Data Range/Formula
		Mnemonics			
		Ident.#	Description		
		Mask			
0	Primary Header		Time when sent from PC task		
6	Secondary Header(time stamp)		Corresponds to the first data sample		
14	Shot Counter	GPCSSHOTC	0-DISABLED, 1-ENABLED	UINT_8	1-200
15	Dithering Enabled	GPCDITHER		UINT_8	0-1
16	(-1 km to 10 km Data, plus Background)		148 8-bit Digitizer Samples from the enabled SPCMs plus 2 16-bit Background Measurements plus 4 spare bytes.		
16	8-bit Digitizer Samples for Shot 1.	GPCSCIBINS		UINT_8 [148]	0-255
16	Elevation Bin (Highest -3)		1st 32-bit hardware read		
17	Elevation Bin (Highest -2)				
18	Elevation Bin (Highest -1)				
19	Elevation Bin (Highest)				
20	Elevation Bin (Highest -7)				
21	Elevation Bin (Highest -6)				
22	Elevation Bin (Highest -5)				
23	Elevation Bin (Highest -4)				
24				
160	Elevation Bin (Highest -147)		37th (last) bit h/w read		
161	Elevation Bin (Highest -146)				
162	Elevation Bin (Highest -145)				
163	Elevation Bin (Highest -144)				
164	Background Measurement 1	GPCSCIBKGN1		UINT_16	0-65535
166	Background Measurement 2	GPCSCIBKGN2		UINT_16	0-65535
168	Spare Bytes	GPCSCIERRSP		UINT_32	NA
172	The previous 156 bytes are repeated 39 more times to correspond to Shots 2-40 for the -1km to 10km data.				

Worksheet: PC Sci

Page 1 of 2

Filename: GLAS_SCI_PKT's.xls

Pkt Name App Id	Photon Counter Sci Pkt		Size Frequency Interval	8112 Hz	Octets	Description	Type	Data Range/Formula
	15 Name	idx						
6256	10 km to 20 km data. Sums for shots 1-8	1	GPCSCI18SEC		132 (16-bit) sums of 1st eight samples in the frame (1 sec) for the enabled SPCMs.	UINT_16 [132]	0-65535	
6256	16-bit sum for (Highest Elevation bin - 1)	1		1st 32-bit h/w read				
6258	16-bit sum for (Highest Elevation bin)	1			The 16-bit sums are read as 32-bit words starting from HW address 0xB1020888. The byte order of the 32-bit word is: [h-2][h-3][h-1], where h represents the highest elevation sample.	UINT_32[66]	0-65535	
6260	16-bit sum for (Highest Elevation bin - 3)	1		2nd 32-bit h/w read				
6262	16-bit sum for (Highest Elevation bin - 2)	1						
6264	1		66th (last) 32-bit h/w read				
6516	16-bit sum for (Highest Elevation bin - 131)	1						
6518	16-bit sum for (Highest Elevation bin - 130)	1						
6520	10 km to 20 km data. Sums for shots 9-16	2			Same format as sums for shots 1 through 8	UINT_32[66]		
6784	10 km to 20 km data. Sums for shots 17-24	3			Same format as sums for shots 1 through 8	UINT_32[66]		
7048	10 km to 20 km data. Sums for shots 25-32	4			Same format as sums for shots 1 through 8	UINT_32[66]		
7312	10 km to 20 km data. Sum for shots 33-40	5			Same format as sums for shots 1 through 8	UINT_32[66]		
7576	20 km to 40 km data.	1	GPCSCI40_20		268 (16-bit) sums of forty samples in the frame (1 sec) for the enabled SPCMs.	UINT_16 [268]	0-65535	
7576	16-bit sum for (Highest Elevation bin - 1)	1		1st 32-bit h/w read				
7578	16-bit sum for (Highest Elevation bin)	1			The 16-bit sums are read as 32-bit words starting from HW address 0xB1020670. The byte order is: [h-2][h-3][h-1], where h is the high order byte.	UINT_32[134]	0-65535	
7580	16-bit sum for (Highest Elevation bin - 3)	1		2nd 32-bit h/w read				
7582	16-bit sum for (Highest Elevation bin - 2)	1						
7584	1		134th (last) 32-bit h/w read				
8108	16-bit sum for (Highest Elevation bin - 267)	1						
8110	16-bit sum for (Highest Elevation bin - 266)	1						

Worksheet: PC Sci

Page 2 of 2

Filename: GLAS_SCI_PKT1s.xls

PKT Name App Id	Photon Counter Engineering Pkt 16	Name	idx	Size in Octets	Mnemonics	Frequency Interval 1,000 seconds	Size 8236 Octets Hz	Description	Type	Data Range/Formula
0		Primary Header		6						
6		Secondary Header(time stamp)		8						
14		Shot Counter		1	GPESHOTC			Corresponds to the first data sample	UJINT_8	1-200
15		Dithering Enabled		1	GPCEIDITHER			0=DISABLED, 1=ENABLED	UJINT_8	0-1
16		40 km to 20 km data	1	268	GPCE20_40			268 8 bit values, 1st shot in frame. Read from HW address 0xB1020800. Data is read as 32-bit words and the order of samples is high altitude to low altitude.	UJINT_8 [268]	0-255
284		20 km to 10 km data	1	132	GPCE10_20			132 8 bit values, 1st shot in frame. Read from HW address 0xB102090C. Data is read as 32-bit words and the order of samples is high altitude to low altitude.	UJINT_8 [132]	0-255
416		10 km to -1km data	1	148	GPCE1_10			148 8 bit values, 1st shot in frame. Read from HW address 0xB1020990. Data is read as 32-bit words and the order of samples is high altitude to low altitude.	UJINT_8 [148]	0-255
<p>The previous 3 fields are repeated for every odd numbered shot in the frame starting from the shot count specified at offset 14, with 29 being the maximum shot count. For example, if the shot specified at offset 14 is 5, then shots 5,7,9,.....,29,3,1 (15 total) would be sampled. Note: The data is written as 32-bit words with the byte order as follows; [h-3]h-2[h-1]h where h is the highest elevation sample.</p>										
564		40 km to 20 km data	2	268				3rd shot in frame		
832		20 km to 10 km data	2	132				3rd shot in frame		
964		10 km to -1km data	2	148				3rd shot in frame		
1112		40 km to 20 km data	3	268				5th shot in frame		
1380		20 km to 10 km data	3	132				5th shot in frame		
1512		10 km to -1km data	3	148				5th shot in frame		
1660		40 km to 20 km data	4	268				7th shot in frame		
1928		20 km to 10 km data	4	132				Note: All this data is from the enabled SPCM		
2060		10 km to -1km data	4	148				9th shot in frame		
2208		40 km to 20 km data	5	268						
2476		20 km to 10 km data	5	132						
2608		10 km to -1km data	5	148						
2756		40 km to 20 km data	6	268				11th shot in frame		
3024		20 km to 10 km data	6	132						
3156		10 km to -1km data	6	148						
3304		40 km to 20 km data	7	268				13th shot in frame		
3572		20 km to 10 km data	7	132						
3704		10 km to -1km data	7	148						
3852		40 km to 20 km data	8	268				15th shot in frame		
4120		20 km to 10 km data	8	132						
4252		10 km to -1km data	8	148						
4400		40 km to 20 km data	9	268				17th shot in frame		
4668		20 km to 10 km data	9	132						
4800		10 km to -1km data	9	148						
4948		40 km to 20 km data	10	268				19th shot in frame		
5216		20 km to 10 km data	10	132						

Pkt Name App Id	Photon Counter Engineering Pkt 16	Name	idx	Size in Octets	Size		Octets Hz	Description	Type	Data Range/Formula
					Frequency Interval	1.000 seconds				
Offset					Mnemonics	Ident.#	Mask			
5348		10 km to -1km data	10	148						
5496		40 km to 20 km data	11	268						
5764		20 km to 10 km data	11	132						
5896		10 km to -1km data	11	148						
6044		40 km to 20 km data	12	268						
6312		20 km to 10 km data	12	132						
6444		10 km to -1km data	12	148						
6592		40 km to 20 km data	13	268						
6860		20 km to 10 km data	13	132						
6992		10 km to -1km data	13	148						
7140		40 km to 20 km data	14	268						
7408		20 km to 10 km data	14	132						
7540		10 km to -1km data	14	148						
7688		40 km to 20 km data	15	268						
7956		20 km to 10 km data	15	132						
8088		10 km to -1km data	15	148						

Filename: GLAS_SCI_PKTIs.xls

Page 2 of 2

Worksheet: PC Eng

Pkt Name	Cloud Digitizer Science Pkt	Idx	Size in Octets	Mnemonics	Frequency Interval	Size	7576 Hz	Octets	Description	Type	Data Range/Formula
App Id	17					1.000	1				
Offset	Name					Ident.#					
0	Primary Header		6			Mask					
6	Secondary Header (time stamp)		8								
14	Shot Counter		2							UINT_16	1-200
16	148 8-bit Digitizer Samples from the enabled SPCMs plus background for -1 km to 10 km data.										
16	8-bit Digitizer Samples for Shot 1.	1									
16	Elevation Bin (Highest -3)	1	1			1st 32-bit hardware read					
17	Elevation Bin (Highest -2)	1	1								
18	Elevation Bin (Highest -1)	1	1								
19	Elevation Bin (Highest)	1	1								
20	Elevation Bin (Highest -7)	1	1			2nd 32-bit hardware read					
21	Elevation Bin (Highest -6)	1	1								
22	Elevation Bin (Highest -5)	1	1								
23	Elevation Bin (Highest -4)	1	1								
24	1	136			37th (last) bit h/w read					
160	Elevation Bin (Highest -147)	1	1								
161	Elevation Bin (Highest -146)	1	1								
162	Elevation Bin (Highest -145)	1	1								
163	Elevation Bin (Highest -144)	1	1								
164	Background Measurement 1	1	2								
166	Background Measurement 2	1	2								
168	spare bytes	1	4								
172	The previous 156 bytes are repeated 39 more times to correspond to Shots 2-40 for the -1km to 10km data.	2..40	6084								

Filename: GLAS_SCI_PKTs.xls

Page 1 of 2

Worksheet: CD Sci

Pkt Name	Cloud Digitizer Science Pkt	Offset	App Id	17	Size	Frequency	Interval	7576	Octets	Description	Type	Data Range/Formula
Offset	Name	idx	Size in	Mnemonics	Ident.#	Mask	seconds					
		Otets										
6256	10 km to 20 km data. Sums for shots 1-8	1	2				132 (16-bit) sums of 1st eight samples in the frame (1 sec) for the enabled SPCMs.		UINT_16 [132]		0-65535	
6256	16-bit sum for (Highest Elevation bin - 1)	1	2			1st 32-bit h/w read						
6258	16-bit sum for (Highest Elevation bin)	1	2									
6260	16-bit sum for (Highest Elevation bin - 3)	1	2									
6262	16-bit sum for (Highest Elevation bin - 2)	1	2			2nd 32-bit h/w read						
6264	1	252									
6516	16-bit sum for (Highest Elevation bin - 131)	1	2			66th (last) 32-bit h/w read						
6518	16-bit sum for (Highest Elevation bin - 130)	1	2									
6520	10 km to 20 km data. Sums for shots 9-16	2	264									
6784	10 km to 20 km data. Sums for shots 17-24	3	264									
7048	10 km to 20 km data. Sums for shots 25-32	4	264									
7312	10 km to 20 km data. Sum for shots 33-40	5	264									

Filename: GLAS_SCI_PKTs.xls

Page 2 of 2

Worksheet: CD Sci

Pkt Name App Id	Cloud Digitizer Engineering Pkt 18	Name	idx	Size in Octets	Mnemonics	Size Interval 1,000 seconds	5616 Hz	Octets	Description	Type	Data Range/Formula
0		Primary Header		6							
6		Secondary Header (time stamp)		8							
14		Shot Counter		2						UJINT_16	1-200
16		20 km to 10 km data	1	132					Corresponds to the first data sample 132 8 bit values, 1st shot in frame. Read from HW address 0xB202090C. Order of samples is high altitude to low altitude.	UJINT_8 [132]	0-255
148		10 km to -1 km data	1	148					148 8 bit values, 1st shot in frame. Read from HW address 0xB2020990. Order of samples is high altitude to low altitude.	UJINT_8 [148]	0-255
									The previous 2 fields are repeated for every odd numbered shot in the frame starting from the shot counter specified at offset 14. For example, if shot specified at offset 14 is 5, then shots 5,7,9 etc. (up to 20 shots) would be sampled. Note: The data is written as 32-bit words with the byte order as follows; h-3 h-2 h-1 h where h is the high elevation sample.		
296		20 km to 10 km data	2	132					3rd shot in frame		
428		10 km to -1 km data	2	148					3rd shot in frame		
576		20 km to 10 km data	3	132					5th shot in frame		
708		10 km to -1 km data	3	148					5th shot in frame		
856		20 km to 10 km data	4	132					7th shot in frame		
988		10 km to -1 km data	4	148					7th shot in frame		
1136		20 km to 10 km data	5	132					9th shot in frame		
1268		10 km to -1 km data	5	148					9th shot in frame		
1416		20 km to 10 km data	6	132					11th shot in frame		
1548		10 km to -1 km data	6	148					11th shot in frame		
1696		20 km to 10 km data	7	132					13th shot in frame		
1828		10 km to -1 km data	7	148					13th shot in frame		
1976		20 km to 10 km data	8	132					15th shot in frame		
2108		10 km to -1 km data	8	148					15th shot in frame		
2256		20 km to 10 km data	9	132					17th shot in frame		
2388		10 km to -1 km data	9	148					17th shot in frame		
2536		20 km to 10 km data	10	132					19th shot in frame		
2668		10 km to -1 km data	10	148					19th shot in frame		
2816		20 km to 10 km data	11	132					21st shot in frame		
2948		10 km to -1 km data	11	148					21st shot in frame		
3096		20 km to 10 km data	12	132					23rd shot in frame		
3228		10 km to -1 km data	12	148					23rd shot in frame		
3376		20 km to 10 km data	13	132					25th shot in frame		
3508		10 km to -1 km data	13	148					25th shot in frame		
3656		20 km to 10 km data	14	132					27th shot in frame		
3788		10 km to -1 km data	14	148					27th shot in frame		
3936		20 km to 10 km data	15	132					29th shot in frame		
4068		10 km to -1 km data	15	148					29th shot in frame		
4216		20 km to 10 km data	16	132					31st shot in frame		
4348		10 km to -1 km data	16	148					31st shot in frame		
4496		20 km to 10 km data	17	132					33rd shot in frame		
4628		10 km to -1 km data	17	148					33rd shot in frame		
4776		20 km to 10 km data	18	132					35th shot in frame		
4908		10 km to -1 km data	18	148					35th shot in frame		
5056		20 km to 10 km data	19	132					37th shot in frame		
5188		10 km to -1 km data	19	148					37th shot in frame		

Pkt Name	App Id	Cloud Digitizer Engineering Pkt	18	Size	5616	Octets	Frequency	1	Hz	Interval	1,000	seconds	Mnemonics	Ident.#	Description	Type	Data Range/Formula
Offset	Name	Idx	Size in Octets														
5336	20 km to 10 km data	20	132												39th shot in frame		
5468	10 km to -1 km data	20	148												39th shot in frame		

Filename: GLAS_SCI_PkTs.xls

Page 2 of 2

Worksheet: CD Eng

Pkt Name App Id	Ancillary Science Pkt 19	Size Frequency Interval	1368 Hz	Octets seconds	Type	Data Range/Formula	Shared Memory Address
Offset	Name	Mnemonics	Ident.# Mask	Description	Type	Data Range/Formula	Shared Memory Address
	Idx	Size In Octets					
0	Primary Header	6		Time when sent from task			
6	Secondary Header (time stamp)	8		First shot of frame	UINT_8		
14	Shot counter	1		1=AD lim in ancillary pkt, 0=lim NOT in ancillary pkt			
15	AD Checkin Flag, Mask=0x01	GANDPRESF	0x01	1=PC lim in ancillary pkt, 0=lim NOT in ancillary pkt			
15	PC Checkin Flag, Mask 0x02	GANDPRESF	0x02	1=CD lim in ancillary pkt, 0=lim NOT in ancillary pkt			
15	GD Checkin Flag, Mask 0x04	GANDPRESF	0x04	1=GP lim in ancillary pkt, 0=lim NOT in ancillary pkt			
15	GP Checkin Flag, Mask 0x08	GANDPRESF	0x08	1=CT lim in ancillary pkt, 0=lim NOT in ancillary pkt			
15	CT Checkin Flag, Mask 0x10	GANDPRESF	0x10	Flags described above	UINT_8		
15	Task Data Present in Ancillary Flags	GANKTPRES	0x1F				
16	Altimeter Digitizer Task Section						
16	Shot Counter	1		As recorded for the data that follows	UINT_16	1-200	N/A
18	Altimeter Dig. Range Window Rmin	4		Address in nanosecond resolution measured from the location of the Transmit Pulse Peak	UINT_32	0 - 5100000	0015h
22	Altimeter Dig. Range Window Rmax	4		Address in nanosecond resolution measured from the location of the Transmit Pulse Peak	UINT_32	0 - 5100000	0016h
26	Background Noise Search Offset Startpoint	4		Address in nanoseconds resolution of the start of the 1km Background Noise search area measured from the end of the transmit pulse	INT_32	0 - 5000000	0002h
30	4 ns Filter Enable Mask	GANDF4EN	0x0001	0=Disable, 1=Enable			
30	8 ns Filter Enable Mask	GANDF8EN	0x0002	0=Disable, 1=Enable			
30	16 ns Filter Enable Mask	GANDF16EN	0x0004	0=Disable, 1=Enable			
30	32 ns Filter Enable Mask	GANDF32EN	0x0008	0=Disable, 1=Enable			
30	64 ns Filter Enable Mask	GANDF64EN	0x0010	0=Disable, 1=Enable			
30	128 ns Filter Enable Mask	GANDF128EN	0x0020	0=Disable, 1=Enable			
30	Filter Enable Mask	GANDFEMASK	0x003F	Indicates filters selected used for this frame. This parameter is commandable	Bit Field (UINT_32)	0x0 - 0x3F	003ch
34	Shot Counter for PDL waveform	4		As recorded for the data that follows	UINT_32	1-200	N/A
38	Post Delay Laser Pulse Response Start Address	4		Start Address of Post Laser Pulse in nanosecond resolution relative to first sample of the waveform.	UINT_32	0 - 500000	0320h
42	Sampled Post Delay Pulse Waveform	32		32 8-bit data samples. Note: the offset for this data is from Transmit Pulse Peak	UINT_8	0 - 255	0321h to 0328h
74	OTS Laser Pulse Response Start Address	4		Start Address of the following four OTS Laser Pulse waveforms in nanosecond resolution relative to first sample of the waveform.	UINT_32	0 - 500000	0330h
78	Shot Counter for OTS #1	4		Corresponds to the data that follows	UINT_32	1-200	N/A
82	Sampled OTS Pulse Waveform #1	32		32 8-bit data samples. Note: the offset for this data is from laser fire (location 0).	UINT_8	0 - 255	0331h to 0338h
114	Shot Counter for OTS #2	4		Corresponds to the data that follows	UINT_32	1-200	N/A
118	Sampled OTS Pulse Waveform #2	32		32 8-bit data samples. Note: the offset for this data is from laser fire (location 0).	UINT_8	0 - 255	0331h to 0338h
150	Shot Counter #3	4		Corresponds to the data that follows	UINT_32	1-200	N/A
154	Sampled OTS Pulse Waveform #3	32		32 8-bit data samples. Note: the offset for this data is from laser fire (location 0).	UINT_8	0 - 255	0331h to 0338h
188	Shot Counter for OTS #4	4		Corresponds to the data that follows	UINT_32	1-200	N/A
190	Sampled OTS Pulse Waveform #4	32		32 8-bit data samples. Note: the offset for this data is from laser fire (location 0).	UINT_8	0 - 255	0331h to 0338h
222	Location of transmit pulse search window (start)	4		Reflects commanded value	UINT_32	0 - 300000	0000h
226	Number of No Threshold Crossing Shots for Error	4		Reflects commanded value	UINT_32	0 - 255	N/A
230	Spare Telemetry Byte	1		Reflects commanded value	UINT_8	0-3	N/A
231	Surface Echo Land Type for Compression	2		0=sea, 1=land, 2=sea/ice, 3=land/ice	UINT_16	1, 2, 4, 8	N/A
232	Value of 'p' used for frame	2		AD compression factor P	UINT_16	1, 2, 4, 8	N/A
234	Value of 'q' used for frame	2		# of samples to compress by P	UINT_16	1, 2, 4, 8	N/A
236	Value of 'r' used for frame	2		AD compression factor R	UINT_16	1, 2, 4, 8	N/A
238	Value of 't' used for frame	2		Reflects commanded value or default	UINT_16	0 - 255	0001h
240	Transmit Pulse Threshold Value	4		Reflects commanded value or default	UINT_16	0.000 to +100.000	001dh
242	Range Window Weighting Scale Factor A1 Coefficient for 4 ns filter	4		Reflects commanded value or default	UINT_16	0.000 to +100.000	001eh
246	Range Window Weighting Scale Factor A2 Coefficient for 4 ns filter	4		Reflects commanded value or default	UINT_16	-100.000 to 0.000	001fh
250	Range Window Weighting Scale Factor A3 Coefficient for 4 ns filter	4		Reflects commanded value or default	UINT_16	-1000.000 to 0.000	001fh

254	Range Window Weighting Scale Factor A4 Coefficient for 4 ns filter	40	4	GANADWPF4		Reflects commanded value or default	FLOAT (IEEE754)	0.000 to +100.000	0020h
258	Range Window Weighting Scale Factor A1 Coefficient for 8 ns filter	41	4	GANADWPF5		Reflects commanded value or default	FLOAT (IEEE754)	0.000 to +100.000	0021h
262	Range Window Weighting Scale Factor A2 Coefficient for 8 ns filter	42	4	GANADWPF6		Reflects commanded value or default	FLOAT (IEEE754)	-100.000 to 0.000	0022h
266	Range Window Weighting Scale Factor A3 Coefficient for 8 ns filter	43	4	GANADWPF7		Reflects commanded value or default	FLOAT (IEEE754)	-1000.000 to 0.000	0023h
270	Range Window Weighting Scale Factor A4 Coefficient for 8 ns filter	44	4	GANADWPF8		Reflects commanded value or default	FLOAT (IEEE754)	0.000 to +100.000	0024h
274	Range Window Weighting Scale Factor A1 Coefficient for 16 ns filter	45	4	GANADWPF9		Reflects commanded value or default	FLOAT (IEEE754)	0.000 to +100.000	0025h
278	Range Window Weighting Scale Factor A2 Coefficient for 16 ns filter	46	4	GANADWPF10		Reflects commanded value or default	FLOAT (IEEE754)	-100.000 to 0.000	0026h
282	Range Window Weighting Scale Factor A3 Coefficient for 16 ns filter	47	4	GANADWPF11		Reflects commanded value or default	FLOAT (IEEE754)	-1000.000 to 0.000	0027h
286	Range Window Weighting Scale Factor A4 Coefficient for 16 ns filter	48	4	GANADWPF12		Reflects commanded value or default	FLOAT (IEEE754)	0.000 to +100.000	0028h
290	Range Window Weighting Scale Factor A1 Coefficient for 32 ns filter	49	4	GANADWPF13		Reflects commanded value or default	FLOAT (IEEE754)	0.000 to +100.000	0029h
294	Range Window Weighting Scale Factor A2 Coefficient for 32 ns filter	50	4	GANADWPF14		Reflects commanded value or default	FLOAT (IEEE754)	-100.000 to 0.000	002ah
298	Range Window Weighting Scale Factor A3 Coefficient for 32 ns filter	51	4	GANADWPF15		Reflects commanded value or default	FLOAT (IEEE754)	-1000.000 to 0.000	002bh
302	Range Window Weighting Scale Factor A4 Coefficient for 32 ns filter	52	4	GANADWPF16		Reflects commanded value or default	FLOAT (IEEE754)	0.000 to +100.000	002ch
306	Range Window Weighting Scale Factor A1 Coefficient for 64 ns filter	53	4	GANADWPF17		Reflects commanded value or default	FLOAT (IEEE754)	0.000 to +100.000	002dh
310	Range Window Weighting Scale Factor A2 Coefficient for 64 ns filter	54	4	GANADWPF18		Reflects commanded value or default	FLOAT (IEEE754)	-100.000 to 0.000	002eh
314	Range Window Weighting Scale Factor A3 Coefficient for 64 ns filter	55	4	GANADWPF19		Reflects commanded value or default	FLOAT (IEEE754)	-1000.000 to 0.000	002fh
318	Range Window Weighting Scale Factor A4 Coefficient for 64 ns filter	56	4	GANADWPF20		Reflects commanded value or default	FLOAT (IEEE754)	0.000 to +100.000	0030h
322	Range Window Weighting Scale Factor A1 Coefficient for 128 ns filter	57	4	GANADWPF21		Reflects commanded value or default	FLOAT (IEEE754)	0.000 to +100.000	0031h
326	Range Window Weighting Scale Factor A2 Coefficient for 128 ns filter	58	4	GANADWPF22		Reflects commanded value or default	FLOAT (IEEE754)	-100.000 to 0.000	0032h
330	Range Window Weighting Scale Factor A3 Coefficient for 128 ns filter	59	4	GANADWPF23		Reflects commanded value or default	FLOAT (IEEE754)	-1000.000 to 0.000	0033h
334	Range Window Weighting Scale Factor A4 Coefficient for 128 ns filter	60	4	GANADWPF24		Reflects commanded value or default	FLOAT (IEEE754)	0.000 to +100.000	0034h
338	Background Noise A1 Coefficient for 4ns Filter	61	4	GANADNPF1		Reflects commanded value or default	FLOAT (IEEE754)	0.000 to 10.000	0003h
342	Background Noise A2 Coefficient for 4ns Filter	62	4	GANADNPF2		Reflects commanded value or default	FLOAT (IEEE754)	-10.000 to +10.000	0004h
346	Background Noise A3 Coefficient for 4ns Filter	63	4	GANADNPF3		Reflects commanded value or default	FLOAT (IEEE754)	-10.000 to +10.000	0005h
350	Background Noise A1 Coefficient for 8ns Filter	64	4	GANADNPF4		Reflects commanded value or default	FLOAT (IEEE754)	0.000 to 10.000	0006h
354	Background Noise A2 Coefficient for 8ns Filter	65	4	GANADNPF5		Reflects commanded value or default	FLOAT (IEEE754)	-10.000 to +10.000	0007h
358	Background Noise A3 Coefficient for 8ns Filter	66	4	GANADNPF6		Reflects commanded value or default	FLOAT (IEEE754)	-10.000 to +10.000	0008h
362	Background Noise A1 Coefficient for 16ns Filter	67	4	GANADNPF7		Reflects commanded value or default	FLOAT (IEEE754)	0.000 to 10.000	0009h
366	Background Noise A2 Coefficient for 16ns Filter	68	4	GANADNPF8		Reflects commanded value or default	FLOAT (IEEE754)	-10.000 to +10.000	000ah
370	Background Noise A3 Coefficient for 16ns Filter	69	4	GANADNPF9		Reflects commanded value or default	FLOAT (IEEE754)	-10.000 to +10.000	000bh
374	Background Noise A1 Coefficient for 32ns Filter	70	4	GANADNPF10		Reflects commanded value or default	FLOAT (IEEE754)	0.000 to 10.000	000ch
378	Background Noise A2 Coefficient for 32ns Filter	71	4	GANADNPF11		Reflects commanded value or default	FLOAT (IEEE754)	-10.000 to +10.000	000dh
382	Background Noise A3 Coefficient for 32ns Filter	72	4	GANADNPF12		Reflects commanded value or default	FLOAT (IEEE754)	-10.000 to +10.000	000eh
386	Background Noise A1 Coefficient for 64ns Filter	73	4	GANADNPF13		Reflects commanded value or default	FLOAT (IEEE754)	0.000 to 10.000	000fh
390	Background Noise A2 Coefficient for 64ns Filter	74	4	GANADNPF14		Reflects commanded value or default	FLOAT (IEEE754)	-10.000 to +10.000	0010h
394	Background Noise A3 Coefficient for 64ns Filter	75	4	GANADNPF15		Reflects commanded value or default	FLOAT (IEEE754)	-10.000 to +10.000	0011h
398	Background Noise A1 Coefficient for 128ns Filter	76	4	GANADNPF16		Reflects commanded value or default	FLOAT (IEEE754)	0.000 to 10.000	0012h
402	Background Noise A2 Coefficient for 128ns Filter	77	4	GANADNPF17		Reflects commanded value or default	FLOAT (IEEE754)	-10.000 to +10.000	0013h
406	Background Noise A3 Coefficient for 128ns Filter	78	4	GANADNPF18		Reflects commanded value or default	FLOAT (IEEE754)	-10.000 to +10.000	0014h
410	Spare Telemetry Byte	79	1				UINT 8	N/A	N/A
411	Enable/Disable Auto Gain Calculation	80	1	GANADAGENAB		0=Fixed, 1=Auto; Reflects commanded value or default	UINT 8	N/A	N/A
412	Enable/Disable Use of 4ns Filter for Auto Gain Calculation	81	1	GANADAGFIL		0=Select, 1=Raw; Reflects commanded value or default	UINT 8	N/A	N/A
413	Return Gain Value	82	4	GANADAGAIN		Reflects commanded value or default	UINT 8	0 - 200	N/A
414	Auto Gain Calculation A1 Parameter	83	4	GANADAGAP1		Reflects commanded value or default	FLOAT (IEEE754)		N/A
418	Auto Gain Calculation A2 Parameter	84	4	GANADAGAP2		Reflects commanded value or default	FLOAT (IEEE754)		N/A
422	Auto Gain Calculation A3 Parameter	85	4	GANADAGAP3		Reflects commanded value or default	FLOAT (IEEE754)		N/A
426	Auto Gain Calculation A4 Parameter	86	4	GANADAGAP4		Reflects commanded value or default	FLOAT (IEEE754)		N/A

Worksheet: Ancillary Sci

Filename: GLAS_SCI_PKTs.xls

430	Auto Gain Calculation B1 Parameter	87	4	GANADGGBR[1]	Reflects commanded value or default	Float (IEEE754)	N/A
434	Auto Gain Calculation B2 Parameter	88	4	GANADGGBR[2]	Reflects commanded value or default	Float (IEEE754)	N/A
438	Auto Gain Calculation B3 Parameter	89	4	GANADGGBR[3]	Reflects commanded value or default	Float (IEEE754)	N/A
442	Auto Gain Calculation B4 Parameter	90	4	GANADGGBR[4]	Reflects commanded value or default	Float (IEEE754)	N/A
446	Auto Gain Calculation C0 Parameter	91	4	GANADGGBR[1]	Reflects commanded value or default	Float (IEEE754)	N/A
450	Auto Gain Calculation C1 Parameter	92	4	GANADGGBR[2]	Reflects commanded value or default	Float (IEEE754)	N/A
454	Auto Gain Calculation Vnef Parameter	93	4	GANADGGBR[3]	Reflects commanded value or default	Float (IEEE754)	N/A
458	Auto Gain Calculation Zmin Parameter	94	4	GANADGGBR[4]	Reflects commanded value or default	Float (IEEE754)	N/A
462	Auto Gain Calculation Zmax Parameter	95	4	GANADGGBR[1]	Reflects commanded value or default	Float (IEEE754)	N/A
466	Auto Gain Calculation Vmin Parameter	96	1	GANADGGBR[2]	Reflects commanded value or default	UINT_8	0 - 255
467	Auto Gain Calculation Vmax Parameter	97	1	GANADGGBR[3]	Reflects commanded value or default	UINT_8	0 - 255
468	Auto Gain Calculation Gmin Parameter	98	1	GANADGGBR[4]	Reflects commanded value or default	UINT_8	0 - 255
469	Auto Gain Calculation Gmax Parameter	99	1	GANADGGBR[1]	Reflects commanded value or default	UINT_8	0 - 255
470	Tolerance for Coincidence of Filters	100	4	GANADGGBR[2]	Reflects commanded value or default	UINT_32	0 - 2000
474	Range Window Dump (waveform time) Offsets for 4 ns filter	101	4	GANADRWTO[1]	Reflects commanded value or default	INT_32	0-500
478	Range Window Dump (waveform time) Offsets for 8 ns filter	102	4	GANADRWTO[2]	Reflects commanded value or default	INT_32	0-500
482	Range Window Dump (waveform time) Offsets for 16 ns filter	103	4	GANADRWTO[3]	Reflects commanded value or default	INT_32	0-500
486	Range Window Dump (waveform time) Offsets for 32 ns filter	104	4	GANADRWTO[4]	Reflects commanded value or default	INT_32	0-500
490	Range Window Dump (waveform time) Offsets for 64 ns filter	105	4	GANADRWTO[5]	Reflects commanded value or default	INT_32	0-500
494	Range Window Dump (waveform time) Offsets for 128 ns filter	106	4	GANADRWTO[6]	Reflects commanded value or default	INT_32	0-500
498	Spare bytes	108	2		Reflects commanded value or default	UINT_8	
500	Surface (Pulse) Return Threshold Values for All Filters (4 ns through 128 ns filters)	107	6	GANADRTHR[1..6]	Reflects commanded value or default. 6 bytes total; byte 1 represents 4ns filter, byte 2 = 8ns, etc.	UINT_8	0035h to 003ah to 003bh to 003ch
506	FIR Filter Coefficients	109	8	GANADFFIR[1..8]	Reflects commanded value or default. Total of 8 bytes	UINT_8	
514	Filter Weight Min Std Deviation	110	4	GANADWMINSTD	Reflects commanded value or default	Float (IEEE754)	0.0001 - 1.0
518	Filter Noise Minimum Thresholds for 4 ns filter	111	4	GANADNMN[1]	Reflects commanded value or default	Float (IEEE754)	0-255
522	Filter Noise Minimum Thresholds for 8 ns filter	112	4	GANADNMN[2]	Reflects commanded value or default	Float (IEEE754)	0-255
526	Filter Noise Minimum Thresholds for 16 ns filter	113	4	GANADNMN[3]	Reflects commanded value or default	Float (IEEE754)	0-255
530	Filter Noise Minimum Thresholds for 32 ns filter	114	4	GANADNMN[4]	Reflects commanded value or default	Float (IEEE754)	0-255
534	Filter Noise Minimum Thresholds for 64 ns filter	115	4	GANADNMN[5]	Reflects commanded value or default	Float (IEEE754)	0-255
538	Filter Noise Minimum Thresholds for 128 ns filter	116	4	GANADNMN[6]	Reflects commanded value or default	Float (IEEE754)	0-255
542	Filter reject mask for leading edge	117	4	GANADFRLEF	Reflects commanded value or default	UINT_32	
546	Filter reject mask for trailing edge	118	4	GANADFRTEF	Reflects commanded value or default	UINT_32	
550	Spare Telemetry Bytes	119	22		Spare telemetry	UINT_8	N/A
572	Photon Counter Task Section						
574	SPCM 1 RAW Counts Mask	1	2		Spare	UINT_16	NA
574	SPCM 2 RAW Counts Mask	3		GANSPCMRG[1]	0x000000FF		0-255
574	SPCM 3 RAW Counts Mask	4		GANSPCMRG[2]	0x0000FF00		0-255
574	SPCM 4 RAW Counts Mask	5		GANSPCMRG[3]	0x00FF0000		0-255
574	SPCM 5 RAW Counts Mask	6		GANSPCMRG[4]	0xFF000000		0-255
574	SPCM 1-4 Raw Counts	2	4	GANSPCMRC	Photon Counter Bd address 0xB1800018	UINT_32	0-4294867295
578	SPCM 5 RAW Counts Mask	8		GANSPCMRG[1]	0x000000FF		0-255
578	SPCM 6 RAW Counts Mask	9		GANSPCMRG[2]	0x0000FF00		0-255
578	SPCM 7 RAW Counts Mask	10		GANSPCMRG[3]	0x00FF0000		0-255
578	SPCM 8 RAW Counts Mask	11		GANSPCMRG[4]	0xFF000000		0-255
578	SPCM 5-8 Raw Counts	7	4	GANSPCMRC1	Photon Counter Bd address 0xB180001C	UINT_32	0-4294867295
582	SPCM Gate Delay	12	2	GANFCSPCM	Photon Counter Bd address 0xB1000004	UINT_16	0-65535
584	PC Background #1 Delay	13	2	GANFCBKGN1	Photon Counter Bd address 0xB1000004	UINT_16	0-65535
586	PC Background #2 Delay	14	2	GANFCBKGN2	Photon Counter Bd address 0xB1000008	UINT_16	0-65535
588	PC Range Gate (Lidar) Delay	15	2	GANFCBKGN2	Photon Counter Bd address 0xB1000008	UINT_16	0-65535
590	SPCM 1 Mask			GANFCMBLID			
590	SPCM 2 Mask				0x0100		
590	SPCM 3 Mask				0x0200		
590	SPCM 4 Mask				0x0400		
590	SPCM 5 Mask				0x0800		
590	SPCM 6 Mask				0x1000		
590	SPCM 7 Mask				0x2000		
590	SPCM 8 Mask				0x4000		
590	SPCM status	16	2	GANSPCMSTAT	0xFF00	UINT_16	0-65535
592	Spare				Photon Counter Bd address 0xB1800004	UINT_16	0-65535
594	Attenuation = 0.		2		Spare	UINT_16	0-65535

1217	Etabon State	1	GANCSTATE		Idle=0, InE=1, Sat Temp=2, Settles=3, Average=4, 5=Openloop, 6=Modified in seconds	UINT 8		
1218	Etabon Temperature Settle Time	1	GANCTEMPSET		in seconds	UINT 8		
1219	Etabon tracking lock transmission flag		GANCLOCKTR	0x01	0 = Good 1 = Low			
1219	Etabon tracking error flag		GANCLOCKTR	0x02	0 = Raised 1 = Active			
1219	Etabon tracking test mode flag		GANCLOCKTR	0x04	0 = Normal 1 = Test			
1219	Etabon tracking openloop mode flag		GANCLOCKTR	0x08	0 = Normal 1 = Openloop			
1219	Etabon tracking openloop update toggle		GANCLOCKTR	0x10				
1219	Etabon Flags	1	GANCFLAGS		Etabon status flags	UINT 8		
1220	Etabon Averaged on-axis transmission	4	GANCETROF		in degrees	UINT 8		
1220	Etabon Averaged off-axis transmission	4	GANCETROF		in degrees	UINT 8		
1220	Etabon temperature error	4	GANCETEMP		in degrees	UINT 8		
1220	Etabon tracking loop filter output	4	GANCETOUT			UINT 8		
1220	Etabon tracking failure average	4	GANCETAVG			UINT 8		
1236	Etabon start temperature for acquire command	1	GANCETSTRT			UINT 8		
1241	Etabon stop temperature for acquire command	1	GANCETSTPT			UINT 8		
1242	Etabon temperature stop for acquire command	1	GANCETSTPT			UINT 8		
1243	Etabon averaging time for acquire command	1	GANCETAVGTIME		in seconds	UINT 16		
1244	Etabon temperature settle time for acquire cmd	2	GANCETSETLTIME		in seconds	UINT 16		
1246	Etabon averaging update counter	1	GANCETAVGUP			UINT 8		
1247	Spare byte	1	GANCETASPARE			UINT 8		
1248	Etabon FBack Mon val (Pin Diode A)	40	GANCETDPA		From LMB. Each corresponds to one of the 40 shots in the frame	UINT 8		
1288	Etabon FBack Mon val (Pin Diode B)	40	GANCETDPB		From LMB. Each corresponds to one of the 40 shots in the frame	UINT 8		
1328	Etabon 532 Energy	40	GANCETES52		From LMB. Each corresponds to one of the 40 shots in the frame	UINT 8		

Worksheet: Ancillary Sci

Page 5 of 5

Filename: GLAS_SCI_PKTS.xls

Pkt Name App Id	LPA Data Pkt 26		idx	Size in Octets	Frequency Interval	Size Interval	4056 Hz	Octets	Description	Type	Data Range/Formula
	Offset	Name									
0	Primary Header			6							
6	Secondary Header(time stamp)			8							
14	Spare		2	2				Spare	UINT_16	NA	
16	Shot Counter		1	2				Corresponding to LPA Data	UINT_16	1-200	
18	X Position of Box		1	1				X Coordinate where LPA Data starts	UINT_8	0-79	
19	Y Position of Box		1	1				Y Coordinate where LPA Data starts	UINT_8	0-79	
20	LPA Data		1	400				20x20 box of LPA pixel intensity data. Pixel = 8 bits. The pixel order is row major: [row,col]; [1,1],[1,2],...,[2,1],[2,2],.....	UINT_8 [400]	0-255, 20 bytes X 20 rows	
420	Shot Counter		2	2				Corresponding to LPA Data			
422	X Position of Box		2	1				X Coordinate where LPA Data starts			
423	Y Position of Box		2	1				Y Coordinate where LPA Data starts			
424	LPA Data		2	400				20x20 box of LPA pixel intensity data			
824	Shot Counter		3	2				Corresponding to LPA Data			
826	X Position of Box		3	1				X Coordinate where LPA Data starts			
827	Y Position of Box		3	1				Y Coordinate where LPA Data starts			
828	LPA Data		3	400				20x20 box of LPA pixel intensity data			
1228	Shot Counter		4	2				Corresponding to LPA Data			
1230	X Position of Box		4	1				X Coordinate where LPA Data starts			
1231	Y Position of Box		4	1				Y Coordinate where LPA Data starts			
1232	LPA Data		4	400				20x20 box of LPA pixel intensity data			
1632	Shot Counter		5	2				Corresponding to LPA Data			
1634	X Position of Box		5	1				X Coordinate where LPA Data starts			
1635	Y Position of Box		5	1				Y Coordinate where LPA Data starts			
1636	LPA Data		5	400				20x20 box of LPA pixel intensity data			
2036	Shot Counter		6	2				Corresponding to LPA Data			
2038	X Position of Box		6	1				X Coordinate where LPA Data starts			
2039	Y Position of Box		6	1				Y Coordinate where LPA Data starts			
2040	LPA Data		6	400				20x20 box of LPA pixel intensity data			
2440	Shot Counter		7	2				Corresponding to LPA Data			
2442	X Position of Box		7	1				X Coordinate where LPA Data starts			
2443	Y Position of Box		7	1				Y Coordinate where LPA Data starts			
2444	LPA Data		7	400				20x20 box of LPA pixel intensity data			
2844	Shot Counter		8	2				Corresponding to LPA Data			
2846	X Position of Box		8	1				X Coordinate where LPA Data starts			
2847	Y Position of Box		8	1				Y Coordinate where LPA Data starts			
2848	LPA Data		8	400				20x20 box of LPA pixel intensity data			
3248	Shot Counter		9	2				Corresponding to LPA Data			
3250	X Position of Box		9	1				X Coordinate where LPA Data starts			
3251	Y Position of Box		9	1				Y Coordinate where LPA Data starts			
3252	LPA Data		9	400				20x20 box of LPA pixel intensity data			
3652	Shot Counter		10	2				Corresponding to LPA Data			
3654	X Position of Box		10	1				X Coordinate where LPA Data starts			
3655	Y Position of Box		10	1				Y Coordinate where LPA Data starts			
3656	LPA Data		10	400				20x20 box of LPA pixel intensity data			

LPA data for all 40 shots is sent down each second. There are 10 shots per packet and 4 packets per second.

Pkt Name App Id	Command History		idx	Size in Octets	Size		296 Async	Octets Hz	seconds	Description
	Name	Size in Octets			Frequency Interval	Mnemonics				
49	Command History									
0	Primary Header	6								
6	Secondary Header(time stamp)	8								
14	Valid Commands in Packet			2						Number of valid commands in this command history packet
16	GLAS Time of Command #1	8	1	8						
24	Command #1 (first 20 bytes)	20	1	20						Only the middle 6 bytes are used for the time.
44	Command #2	8	2	8						The first and last byte (bytes 0 & 7) are spares.
52	Command #2 (first 20 bytes)	20	2	20						First 20 bytes of CCSDS packet
72	GLAS Time of Command #3	8	3	8						
80	Command #3 (first 20 bytes)	20	3	20						
100	GLAS Time of Command #4	8	4	8						
108	Command #4 (first 20 bytes)	20	4	20						
128	GLAS Time of Command #5	8	5	8						
136	Command #5 (first 20 bytes)	20	5	20						
156	GLAS Time of Command #6	8	6	8						
164	Command #6 (first 20 bytes)	20	6	20						
184	GLAS Time of Command #7	8	7	8						
192	Command #7 (first 20 bytes)	20	7	20						
212	GLAS Time of Command #8	8	8	8						
220	Command #8 (first 20 bytes)	20	8	20						
240	GLAS Time of Command #9	8	9	8						
248	Command #9 (first 20 bytes)	20	9	20						
268	GLAS Time of Command #10	8	10	8						
276	Command #10 (first 20 bytes)	20	10	20						

Worksheet: Cmd History

Page 1 of 1

Filename: GLAS_SCI_PKTs.xls

PKT Name	App Id	Offset	Name	idx	Size in Octets	Mnemonics	Frequency Interval	Size	6416	Octets	Description	Type	Data Range/Formula
									1	Hz			
									1	seconds			
									Ident.#				
									Mask				
0			Primary Header		6								
6			Secondary Header(time stamp)		8								
14			Shot Counter		2							UINT_16	1-200
16			LPA Data		6400						Corresponding to LPA Data 80X80 box of LPA pixel intensity data. Pixel = 8 bits. The pixel order is row major: [row,col]; [1,1],[1,2],...,[2,1],[2,2],.....	UINT_8 [6400]	0-255. 80 bytes X 80 columns

Worksheet: LPA Test

Page 1 of 1

Filename: GLAS_SCI_PKTs.xls

Pkt Name	BoreSite Calibration Results Pkt		1816	Octets				
App Id	38		Async	Hz				
Offset	Name	idx	Size in Octets	seconds	Description	Type	Data Range/Formula	
			Mnemonics					
			Ident.#					
			Mask					
0	Primary Header		6					
6	Secondary Header(time stamp)		8					
14	Calibration Type		2					
16	X Position Of The Mirror	1	2		0 = Coarse, 1 = Fine	UINT_16	0-1	
18	Y Position Of The Mirror	1	2		Position X	UINT_16	0-4095	
20	Integration Result	1	4		Position Y	UINT_16	0-4095	
24	Rest of Packet consisting of 224 X and Y mirror positions and the integration result	2-224	1792		Integration Result For The Current Position There are 224(for a total of 225) X and Y Position and Integration results. Each is 8 bytes long. 1792=224x8	UINT_32	0-4294967295	

Worksheet: BoreSite Cal

Page 1 of 1

Filename: GLAS_SCI_PKTs.xls

Appendix C

Background Information for Time Tagging Algorithm

C.1 Information

- 1) There are 2 data types or streams downlinked from the GLAS instrument: science and engineering. The science data contain the science measurements recorded by GLAS and the parameters calculated by the flight software algorithm. Also, included in the science data are commanded flight software parameters. The GPS packet and the spacecraft Position, Rate, and Attitude Packet (PRAP) are science data collected and downlinked directly by the spacecraft. The engineering data contain the instrument health and status data including temperatures, currents, and software status indicators. There are several types of packets within each data type. These packets are defined by their APID (Application ID). The raw ICESat telemetry dumps are processed by EDOS to remove redundant packets and create data files on even 6 hour boundaries for each APID. Table C-1 "APIDs used by Normal I-SIPS Processing" lists the science and engineering data that is normally ingested by the I-SIPS to perform the GLAS data processing. As shown in the table, the Altimeter Digitizer has two different APIDs (12 and 13) but during any one second only one APID will exist.

Table C-1 APIDs used by Normal I-SIPS Processing

APID	Packet Name	Data Type	Frequency (/ = per)	Secondary Header Time
19	Ancillary Science	Science	1 per second	MET
12	Altimeter Digitizer (AD)-Large	Science	4 per second	MET
13	Altimeter Digitizer-Small	Science	4 per second	MET
14	AD Engineering	Science	1 per second*	MET
15	Photon Counter (PC) Science	Science	1 per second	MET
16	PC Engineering	Science	1 per second*	MET
17	Cloud Digitizer (CD) Science	Science	1 per second	MET
18	CD Engineering	Science	1 per second*	MET
26	LPA Data	Science	4 per second	MET
1088	GPS	Science	1 per 10 seconds	BVTCW
1984	PRAP	Science	1 per second	BVTCW
20	CT HW 1	Engineering	1 per 4 seconds	MET
21	CT HW 2	Engineering	1 per 4 seconds	MET
22	CT HW 3	Engineering	1 per 16 seconds	MET

Table C-1 APIDs used by Normal I-SIPS Processing (Continued)

APID	Packet Name	Data Type	Frequency (/ = per)	Secondary Header Time
23	CT HW 4	Engineering	1 per 16 seconds	MET
24	Small Software	Engineering	1 per 4 seconds	MET
25	Large Software 1	Engineering	1 per 4 seconds	MET
50	CT HW 5	Engineering	1 per 32 seconds	MET
55	Large Software 2	Engineering	1 per 4 seconds	MET
* When particular board is commanded to engineering mode				

- 2) The Ancillary Science packet is always output from GLAS, but for AD, CD, and PC either science or engineering exists but not both. However at any time any packet may be lost from the telemetry stream during data transmission.
- 3) A number of diagnostic packets from the engineering data stream will need to be accommodated. The diagnostic packets are sent upon request and will not appear regularly in the stream.
- 4) GLAS packets contain the GLAS Mission Elapsed Time (MET) in their secondary header. GLAS science packets are synchronized.
- 5) As part of the initial telemetry data processing (GL0P - GLAS Level 0 Processing) by the I-SIPS, an index number is assigned for each received ancillary science packet. All other GLAS APIDs that correspond time-wise (using the secondary header) to that ancillary science packet will be assigned the same index number. Subsequent processing can align the data by the index number.
- 6) GLAS science packets also contain the shot counter in order to exactly align the data, however this counter rolls over every 5 seconds (200 shots) so the secondary header time must be used for initial alignment.
- 7) GLAS engineering packets occur at various rates as shown in Table C-1. These are considered asynchronous to the science packets but are output on fixed shot counts. The initial telemetry processing assigns to the GLAS engineering data the index number of the GLAS APID 19 record that has a MET that is greater than the MET of the engineering data (less than 1, 4, 16, or 32 seconds before).
- 8) GPS and PRAP packets are asynchronous.
- 9) The latched BVTCW at GPS time and the GPS time are provided in the PRAP (Position, Rate, and Attitude Packet) and in the spacecraft time and position packet which is contained in the GLAS APID 19 (Ancillary science).
- 10) In addition to secondary header time, GLAS APID 19 contains: shot counter, Fire command time and fire acknowledge time (40 bit counters), GPS time, GLAS frequency and time board time latched to GPS time (40 bit counter), BVTCW at GPS

time, BVTWCW of spacecraft position and time packet, GLAS MET near spacecraft position and time packet, and shot near spacecraft position and time packet.

- 11) In the spacecraft position and time packet (contained in GLAS APID 19) the GPS time and Bvtcw at GPS time pair are repeated for about 10 packets (~10 seconds). The other position packet parameters (Bvtcw for the position packet, GLAS MET and shot number near the position packet) update each second. The Bvtcw of the position packet has a small delay offset. The GLAS MET and shot number near the position packet are not absolute; these values are the latest available when the packet is received.
- 12) The GLAS frequency and time board time latched to GPS time appears in the GLAS APID 19 after the GPS pulse. It will be repeated for about 10 times (~10 seconds). This time must be matched to the correct GPS time of the pulse in order to convert the 40 bit counter to UTC.
- 13) The correct GPS time (and its latched Bvtcw) will appear in the position and time packet, contained in GLAS APID 19, approximately 10 seconds after the pulse (the Bvtcw of the position and time packet is about 10 seconds past Bvtcw latched to the GPS time).
- 14) The GPS/DEM information contained in GLAS APID19 is used for data collection in the next frame. Therefore, the time of this data is one second later than the time of the altimeter digitizer task data contained in GLAS APID19. See Appendix D for packet timing details.
- 15) The LRS and IST receive a 10 hz signal from the GLAS that requires alignment to the exact laser shot. The LRS And IST are contained in the spacecraft's PRAP. The time of the PRAP is not synchronized to the 1/second GLAS data. The index number assigned to the PRAP during initial telemetry processing provides alignment to GLAS APID 19 within two (three?) records (seconds).
- 16) The ISF will maintain the GLAS MET close to the spacecraft time (Bvtcw).
- 17) The Bvtcw will be maintained by the ICESat Mission Operations Center (MOC) to be close to continuous during the mission. MOC will reset Bvtcw after power off and for drift to maintain spacecraft time to about 3 milliseconds.

C.2 Problems to Consider:

- 1) For a second, some packet types may be missing when others are available.
- 2) At the start of a PDS or EDS any packet type may be the earliest UTC and the 4hz AD science packet set may be separated (1,2, or 3 packets at the beginning or end).
- 3) After time gap of all packets, any packet type may be present first.
- 4) ISF provides the correction table for GLAS MET. MET is a software counter therefore it increments the exact number of counts for each laser shot for a perfect 40 hz timing. It therefore will not be true time that accounts for any oscillator drift. The correction table will account for MET losses during:

- GLAS processor resets - The MET will lose some “ticks” during a reset.
 - GLAS warm reboots - the MET counter attempts to keep the time (counter) but will lose a few pulse interrupts (ticks) so will “miss” time (for example if two pulses are missed the time will increment by 25 msec but really 75 ms will have really elapsed).
- 5) Since GLAS engineering packets occur asynchronously to the science packets are there any issues with assigning the index number to the engineering packets? (Need to determine if any smoothing needed on engineering).

C.3 Telemetry Definitions

For the GLAS Science Telemetry Definition and GLAS Engineering Telemetry Definition, see Appendix B. A high level description of the spacecraft’s Position, Rate, and Attitude Packet is contained in Table C-2 "Format of PRAP". The detailed description of the PRAP is contained in the Details of the PRAP contents are defined in the *Data Interface Control Document between the ICESat Spacecraft and the EOS Ground System (EGS)*, listed in Section 5. The format of the spacecraft’s position and time packet is shown in Table C-3 "Time and Position Message Packet Description" on page C-5.

Table C-2 Format of PRAP

Item	Size (Bytes)	Samples/Sec	# Bytes	Cumulative Bytes
VTCW	6	1	6	6
VTCW IRU Time Tag	6	10	60	66
IRU Data	14	10	140	206
VTCW BST1 Time Tag	6	10	60	266
BST1 Data	60	10	600	866
VTCW BST2 Time Tag	6	10	60	926
BST2 Data	60	10	600	1526
IST VTCW Echo	6	10	60	1586
IST Data	64	10	640	2226
IST Health	10	10	100	2326
LRS VTCW Echo	6	10	60	2386
LRS Data	64	10	640	3026
LRS Health	4	1	4	3030
LRS Star Image	512	5	2560	5590
LRS Laser Image	512	4	2048	7638
LRS CRS Image	512	1	512	8150

Table C-2 Format of PRAP (Continued)

Item	Size (Bytes)	Samples/Sec	# Bytes	Cumulative Bytes
Estimated Quaternion	8	1	8	8158
Estimated Position (x,y,z) - 4xf32	6	1	6	8164
Estimated Rate (x,y,z) - 3xf32	6	1	6	8170
Solar Array Position - 2xf32	4	1	4	8174
GPS Receiver Time	4	1	4	8178
VTCW latched to GPS	6	1	6	8184

Table C-3 Time and Position Message Packet Description

Description	Word
CCSDS Header (hex value = 180F)	0
CCSDS Header (hex value = C000)	1
CCSDS Header (hex value = 002B)	2
CCSDS Header (hex value = 0A00)	3
BVTCW - Most Significant Word (us)	4
BVTCW - Mid Significant Word (us)	5
BVTCW - Least Significant Word (us)	6
ECEF Position (Km) – Vector 1 –X - double	7
ECEF Position (Km) – Vector 1–X – double	8
ECEF Position (Km) – Vector 1–X – double	9
ECEF Position (Km) – Vector 1–X – double	10
ECEF Position (Km) – Vector 2–Y - double	11
ECEF Position (Km) – Vector 2–Y – double	12
ECEF Position (Km) – Vector 2–Y – double	13
ECEF Position (Km) – Vector 2–Y – double	14
ECEF Position (Km) – Vector 3–Z - double	15
ECEF Position (Km) – Vector 3–Z – double	16
ECEF Position (Km) – Vector 3–Z – double	17
ECEF Position (Km) – Vector 3–Z - double	18
GPS Rcvr Time (Seconds) - unsigned long int	19

Table C-3 Time and Position Message Packet Description (Continued)

Description	Word
GPS Rcvr Time (Seconds) – unsigned long int	20
BVTCW@ 0.1 Hz pulse - Most Significant Word (us)	21
BVTCW@ 0.1 Hz pulse - Mid Significant Word (us)	22
BVTCW@ 0.1 Hz pulse - Least Significant Word (us)	23
Note1: This message is time-tagged when sent, which is within 300 msec of when the position data is valid. Note2: The position message in GLAS APID 19 does not include the CCSDS header.	

Appendix D

GLAS Science Packets

Synchronization and Alignment Information



NATIONAL AERONAUTICS AND SPACE ADMINISTRATION
GODDARD SPACE FLIGHT CENTER



ICESAT GLAS Flight Software

GLAS Science Packets

Synchronization and Alignment

Prepared by
Steven Slegel

December 5, 2001

Author:

Steven Slegel/ GLAS Flight Software Engineer
Date

Approvals:

Kris Naylor/Build/Acceptance Test Lead
Date

Eleanor Ketchum/GLAS Systems Engineer
Date

Peggy Jester/ICESAT Science Processing Engineer
Date

David Hancock/ICESAT Science Ground System Manager
Date

Manuel Maldonado/GLAS Software Lead Engineer
Date

Joseph Polk/ GLAS Flight Software Engineer
Date

Dwaine Molock/GLAS Flight Software Engineer
Date

Peter Kutt/ GLAS Flight Software Engineer
Date

Overview

This document describes when and how often Science and Ancillary data is collected and how this data correlates with each other. For more information regarding the contents of each packet see the GLAS SCIENCE TELEMETRY PACKETS DEFINITION DOCUMENT (GLAS-582-SPEC-002).

GLAS Science Packets

The following Science packets are generated by the GLAS flight software.

Photon Counter Science Packet

The Photon Counter task generates 1 Photon Counter Science Packet per second while the task is in Science Mode. This packet contains 40 shots of data. The Science packet is time stamped when the packet is sent; on the 40th shot. The shot counter is recorded on the first shot of the frame.

Photon Counter Engineering Packet

The Photon Counter task generates 1 Photon Counter Engineering Packet per second while the task is in Engineering Mode. This packet contains 15 shots of data. The Engineering packet is time stamped when the packet is sent; on the 40th shot. The shot counter is recorded on the first shot of the frame.

Cloud Digitizer Science Packet

The Cloud Digitizer task generates 1 Cloud Digitizer Science Packet per second while the task is in Science Mode. This packet contains 40 shots of data. The Science packet is time stamped when the packet is sent; on the 40th shot. The shot counter is recorded on the first shot of the frame.

Cloud Digitizer Engineering Packet

The Cloud Digitizer task generates 1 Cloud Digitizer Engineering Packet per second while the task is in Engineering Mode. This packet contains 20 shots of data. The Engineering packet is time stamped when the packet is sent; on the 40th shot. The shot counter is recorded on the first shot of the frame.

Altimeter Digitizer Science Packet

The Altimeter Digitizer task generates four Altimeter Digitizer Science packets per second while the task is in Science mode. Each science packet contains 10 shots of science data. Each shot of science data contains the shot counter value indicating the shot in which the data was sampled. The Altimeter Digitizer science packets are time stamped when the packet is sent; on the 10th, 20th, 30th, and 40th shots.

LPA Data Packet

The DC&H task generates four LPA Data packets per second while the task is in SSR_LPA mode. The LPA packet is time stamped when the packet is sent; on the 10th, 20th, 30th, and 40th shots. There are ten shots of LPA data per packet and the shot count is recorded separately for each shot in the packet.

Ancillary Data Packet

The Ancillary packet is generated once per second by the CT Task while the task is in NORMAL mode. The Ancillary packet is time stamped when it is sent; on the 40th shot. The Ancillary packet is a combination of data collected by various tasks. Each task that contributes to the ancillary packet will send its portion of the ancillary data to the CT task every second. The CT task will then collect the various pieces of ancillary data and combine them together into one packet. Not all tasks will provide ancillary data all the time. That will depend on the current mode of the task. A flag in the ancillary packet indicates which tasks have contributed data to the current combined ancillary packet. The following table describes in what mode each task generates ancillary telemetry.

Task	Mode	Generates Ancillary Data
Photon Counter	Idle	No
	Science	Yes
	Engineering	Yes
	Boresite Cal	No
	Memory Test	No
Altimeter Digitizer	Idle	No
	Science	Yes
	1-Shot	Yes (Only 1 packet)
	Load	No
	Dump	No
Cloud Digitizer	Idle	Yes
	Science	Yes
	Engineering	Yes
	Memory Test	No
DC&H	SSR	No
	SSR LPA	No
	Test	No
CT	Manual	No
	Normal	Yes
GP	N/A	Always sends when requested by CT

Timing Relationship Between Different Science Packets

The diagram below shows graphically the relationship between when each science packet is generated.

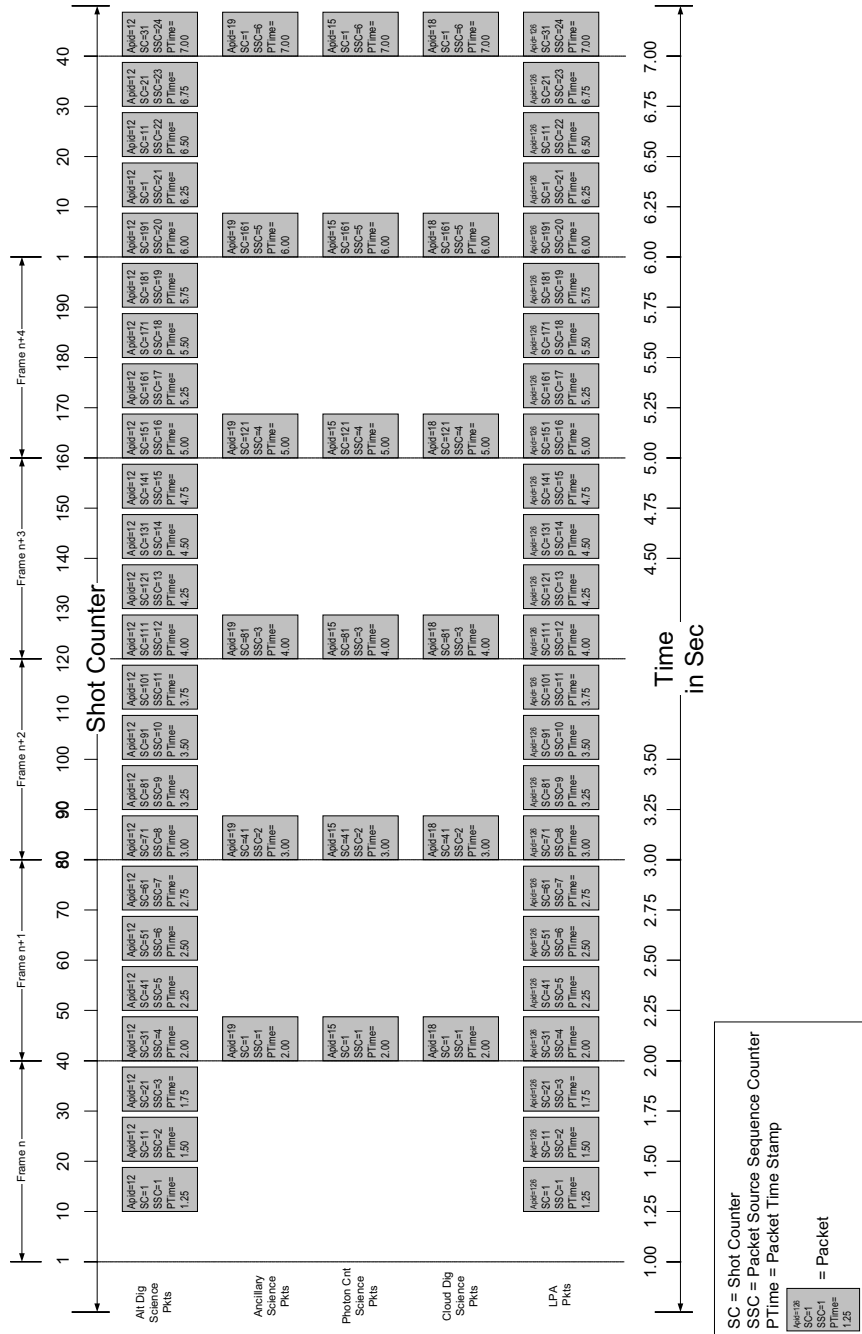

Synchronizing the Ancillary packet with its corresponding Science packets can be confusing because Science Data is collected at different rates and the Ancillary Packet is output at a different time than its corresponding Science Packets. The diagram below shows graphically when each task collects its portion of the ancillary in relation to when the ancillary packet is output by the CT task.

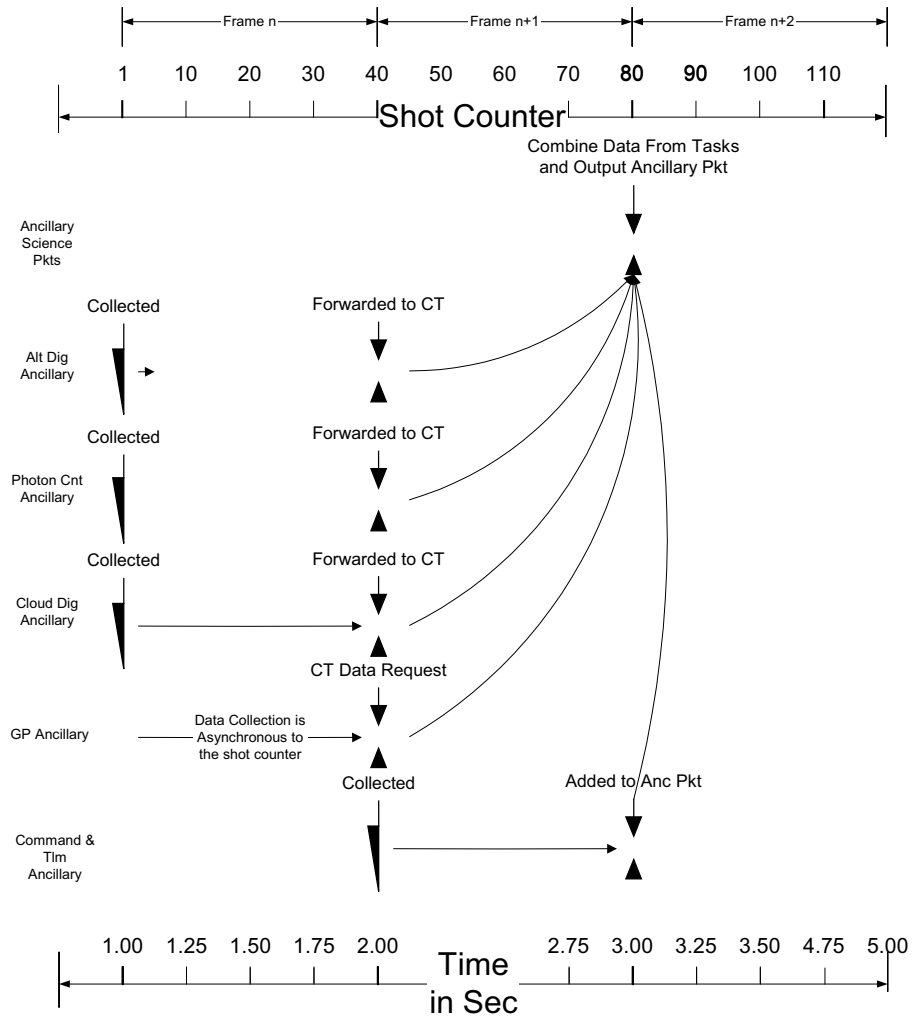

Notes:**Altimeter Digitizer Ancillary:**

- Ancillary telemetry is collected during the first 4 shots of the frame.
- Ancillary telemetry is stamped with the shot count value for the first shot in the frame where the data is collected.
- Ancillary telemetry is collected during the first shot of the frame in 1-Shot mode.
- Only one ancillary telemetry packet is generated in 1-Shot mode.
- Ancillary data is forwarded to CT on the 40th shot.

Photon Counter Ancillary:

- Collected on shot 1 in Science and Engineering modes.
- Ancillary telemetry is stamped with the shot count value for the first shot in the frame where the data is collected.
- Ancillary data is forwarded to CT on the 40th shot.

Cloud Digitizer Ancillary:

- Fire Cmd, Fire Ack, and GPS 10 Second Pulse forty bit counters are collected on every shot in all modes.
- The rest of the CD ancillary data is collected on shot 1 in Science and Engineering modes.
- Ancillary telemetry is stamped with the shot count value for the first shot in the frame where the data is collected.
- Ancillary data is forwarded to CT on the 40th shot.

GP Ancillary:

- GPS collects the GPS 40 bit counter from the CD task every 10 seconds upon the receipt of the GPS 10 second pulse. This 40 bit counter corresponds to the last 10 second GPS pulse and is included as part of GP's ancillary telemetry.
- Position/Range data is also part of GP's ancillary telemetry and is updated every second.
- GP will only send ancillary data to the CT task when it receives a ancillary telemetry request packet from CT.

CT Ancillary:

- Etalon status information is collected on shot 1.
- Dual pin A, B and 532 energy data is collected on every shot.
- CT requests ancillary data from the GP task on the 40th shot. All other tasks automatically forward the data to CT on the 40th shot.
- CT adds the new ancillary data from the other tasks to the combined ancillary packet on the 20th shot.
- CT adds it's own piece of the ancillary data to the combined ancillary packet on the 40th shot.
- Since CT is the sender of the ancillary packet it's own ancillary data is collected on the current frame where the other tasks data is collected on the previous frame.

DC&H does not contribute to the ancillary telemetry

Appendix E

Laser Energy Calibration

The Laser Energy GLAS Instruments Measurements Summary and the GLAS Laser Gain Correction are discussed in the assigned sub-Appendices.

E.1 Laser Energy GLAS Instruments Measurements Summary - Discussion of Laser Energy Calibration

E.2 GLAS Laser Gain Correction - Discussion of Gain Correction to be applied within the Laser Energy Calculation.

Appendix E.1

Laser Energy GLAS Instruments Measurements Summary

GLAS BCE Group

H.Riris, P.Liiva, J.Hirs, J.Schafer, J.Nissley

10/8/2003

Measurements Summary

- Average power and laser energy measurements during GLAS instrument testing at GSFC - Comparison with SLTC average power measurements before delivery to GLAS
- Laser energy measurements at observatory
- Altimeter Detector laser energy calibration
- *Relative* Laser energy measurements during instrument TVAC - Comparison with Altimeter Detector laser energy
- *Relative* Laser energy during observatory TVAC - Comparison with Altimeter Detector laser energy
- Correlation of Laser energy measurements with LPA
- Correlation of Laser energy measurements with LRS

Average power and energy measurements
during GLAS instrument testing at GSFC
Comparison with SLTC average power
measurements before delivery to GLAS

Average laser power measurement at GSFC (similar to SLTC method)

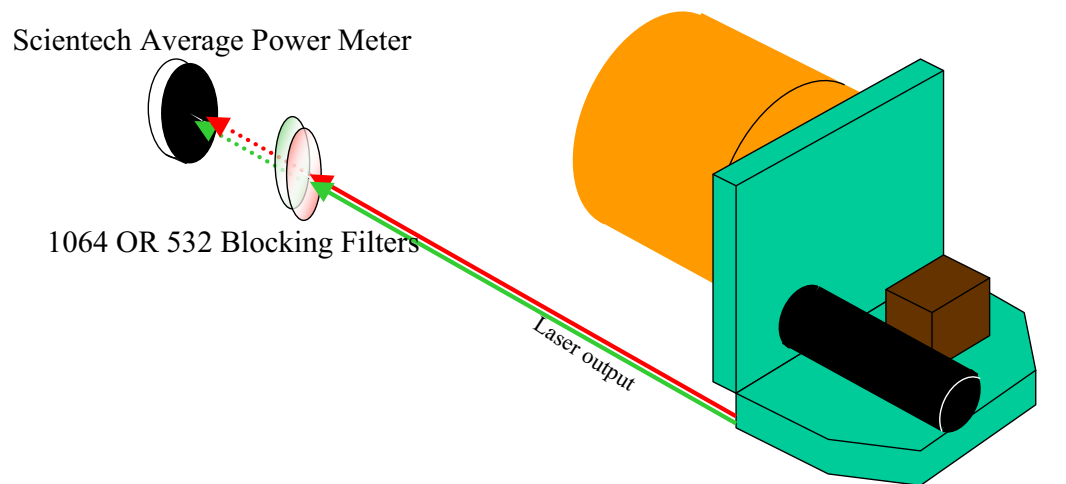

Average Power data collected on 2002 Day 94 and 101

GLAS

Average Power Measurements Comparison with SLTC

		GLAS			GLAS		Delta	Delta	SLTC Measurements*			Delta GLAS-SLTC			Delta GLAS-SLTC				
		Measured Power (W)			Actual Power (W)			ABS	%	Power (W)			ABS	ABS	ABS	%	%	%	
Laser	Date	532	1064	Total	532	1064	Total			Laser	532	1064	Total	532	1064	Total	532	1064	Total
Laser 1	4/11/2002	1.11	2.81	4.3	1.41	2.88	4.29	0.01	0.3%	SN2	1.36	2.80	4.16	0.05	0.08	0.13	3.5%	2.8%	3.0%
Laser 2	4/11/2002	1.01	3.12	4.45	1.28	3.20	4.48	-0.03	-0.7%	SN3	1.29	3.10	4.39	-0.01	0.10	0.09	-0.7%	3.1%	2.0%
Laser 3	4/4/2002	0.78	3.2	4.27	0.99	3.28	4.27	0.00	0.0%	SN1	1.18	3.26	4.43	-0.19	0.02	-0.16	-19.2%	0.8%	-3.9%

**From SLTC delivery package 3/26/02*

GLAS Energy		SLTC Energy	
Derived Energy (mJ)	Derived Energy (mJ)	Derived Energy (mJ)	Derived Energy (mJ)
532	1064	532	1064
35.2	72.0	34.0	70.0
32.0	79.9	32.3	77.5
24.7	82.0	29.5	81.4

Derived Energy (mJ) = Average Power(W)/40 Hz

Explanation of Terms

Measured Power (W)		GLAS
532		Power Measured with 1064 blocking filters in place
1064		Power Measured with 532 blocking filters in place
Total		Power Measured with no blocking filters in place
Actual Power (W)		GLAS
532		Power adjusted for 1064 blocking filters loss
1064		Power adjusted for 532 blocking filters loss
Total		Sum of Actual Power 532 + 1064; should equal Measured Power Total
Delta ABS		Absolute Difference between Measured Power - Actual Power (should be zero if filter attenuation is correct)
Delta %		Percentage Difference between Measured Power - Actual Power (should be zero if filter attenuation is correct)
Delta GLAS-SLTC		Difference between GLAS Actual Power and SLTC Power (Absolute or percentage)

5

Laser Energy measurement using high energy optical detectors

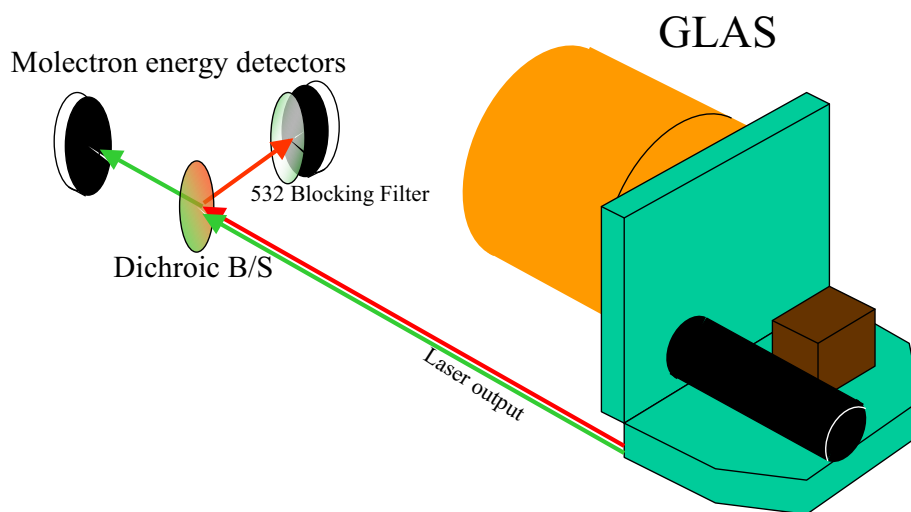

*Energy data collected on 2002 Day 156
No Laser 1 data were collected*

Laser 2 - at nominal Temperature

Data have been corrected for B/S and filter Transmittance

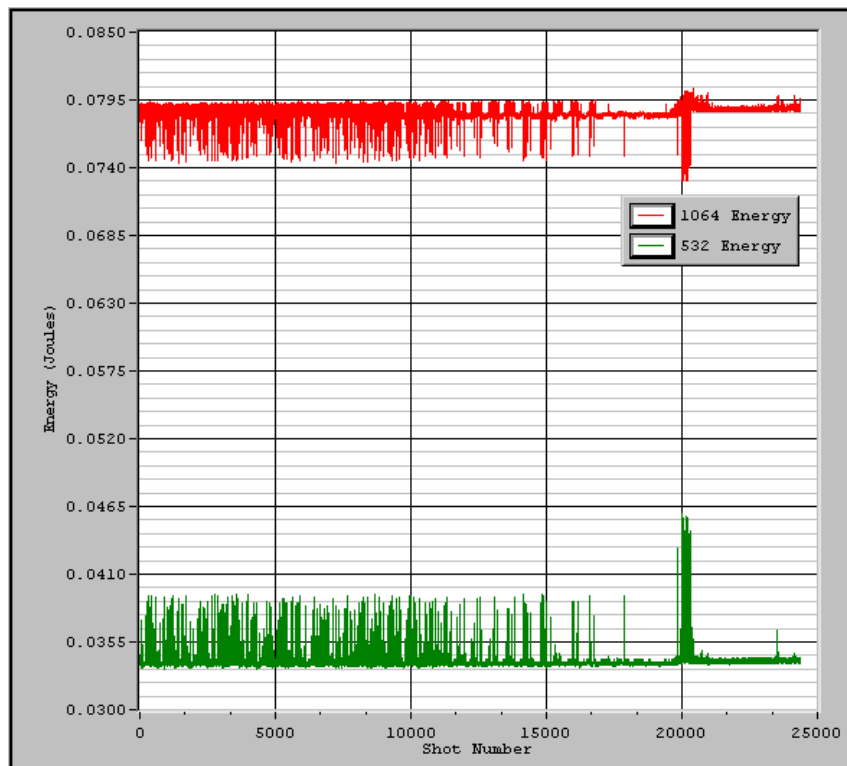

Laser 3 - at nominal Temperature

Data have been corrected for B/S and filter Transmittance

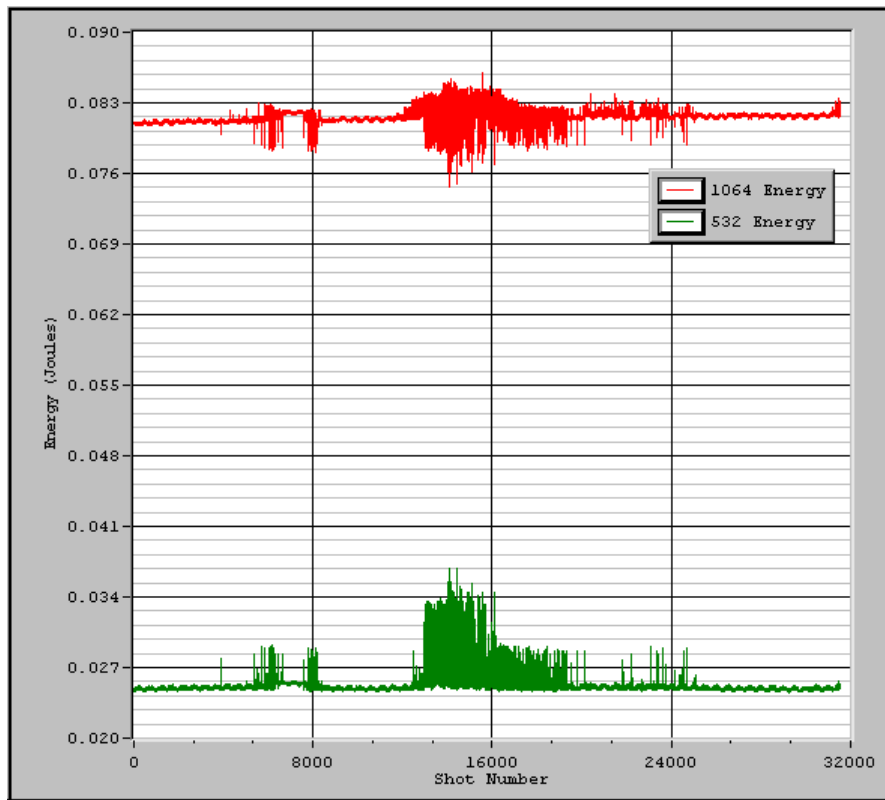

Laser Energy Summary

June 5 2002

	GSFC High Energy Molelectron Measurements						GLAS Derived Energy*		SLTC Derived Energy	
	Min. Energy (mJ)		Max. Energy (mJ)		Aver. Energy (mJ)		Derived Energy (mJ)		Derived Energy (mJ)	
Laser	532	1064	532	1064	532	1064	532	1064	532	1064
Laser 1	Not Measured		Not Measured		Not Measured		35.2	72.0	34.0	70.0
Laser 2*	33.0	72.9	45.9	84.0	33.9	78.5	32.0	79.9	32.3	77.5
Laser 3**	24.5	74.6	36.8	86.0	25.2	81.7	24.7	82.0	29.5	81.4

*Derived Energy = Average Power/40 Hz
(From Slide 5)

	GSFC High Energy Molelectron Measurements						Molelectron - GLAS Derived		Molelectron - GLAS Derived	
	Min. Energy (mJ)		Max. Energy (mJ)		Aver. Energy (mJ)		ABS	ABS	%	%
Laser	532	1064	532	1064	532	1064	532	1064	532	1064
Laser 1	Not Measured		Not Measured		Not Measured		Not Measured		Not Measured	
Laser 2*	33.0	72.9	45.9	84.0	33.9	78.5	1.9	-1.4	5.5%	-1.8%
Laser 3**	24.5	74.6	36.8	86.0	25.2	81.7	0.5	-0.3	1.8%	-0.4%

	GSFC High Energy Molelectron Measurements						Molelectron- SLTC		Molelectron- SLTC	
	Min. Energy (mJ)		Max. Energy (mJ)		Aver. Energy (mJ)		ABS	ABS	%	%
Laser	532	1064	532	1064	532	1064	532	1064	532	1064
Laser 1	Not Measured		Not Measured		Not Measured		Not Measured		Not Measured	
Laser 2*	33.0	72.9	45.9	84.0	33.9	78.5	1.7	1.0	4.9%	1.3%
Laser 3**	24.5	74.6	36.8	86.0	25.2	81.7	-4.3	0.3	-17.0%	0.4%

*Statistics on 24393 points
**Statistics on 31531 points

Laser energy measurements at observatory

Laser Energy measurement using high energy optical detectors at Observatory level

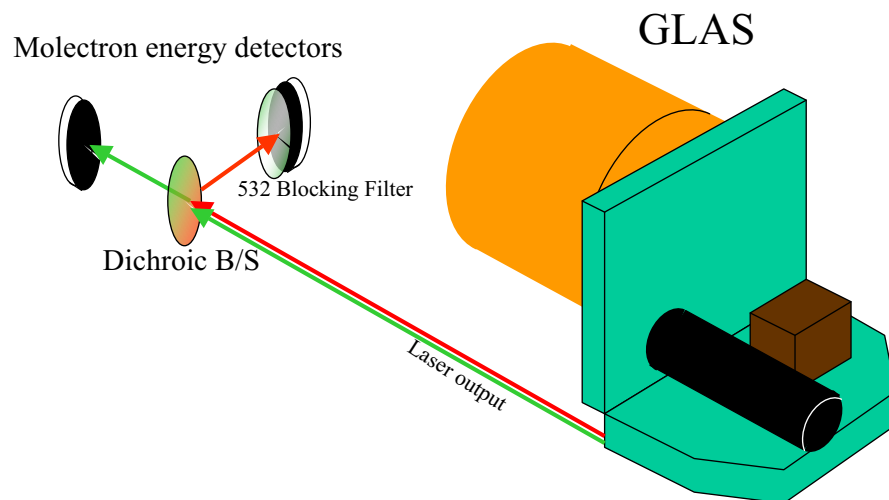

Energy data collected on 2002 Day 281

Laser 1 Energy - at nominal Temperature

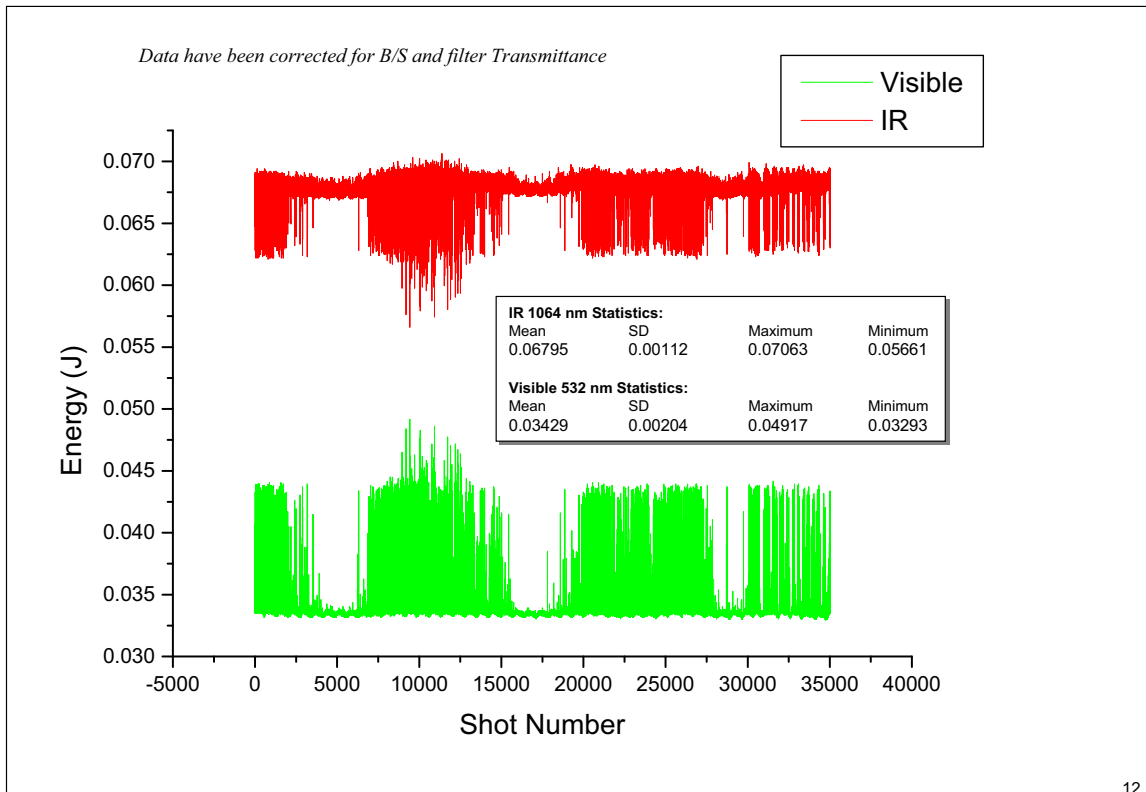

Laser 1 Energy Distributions

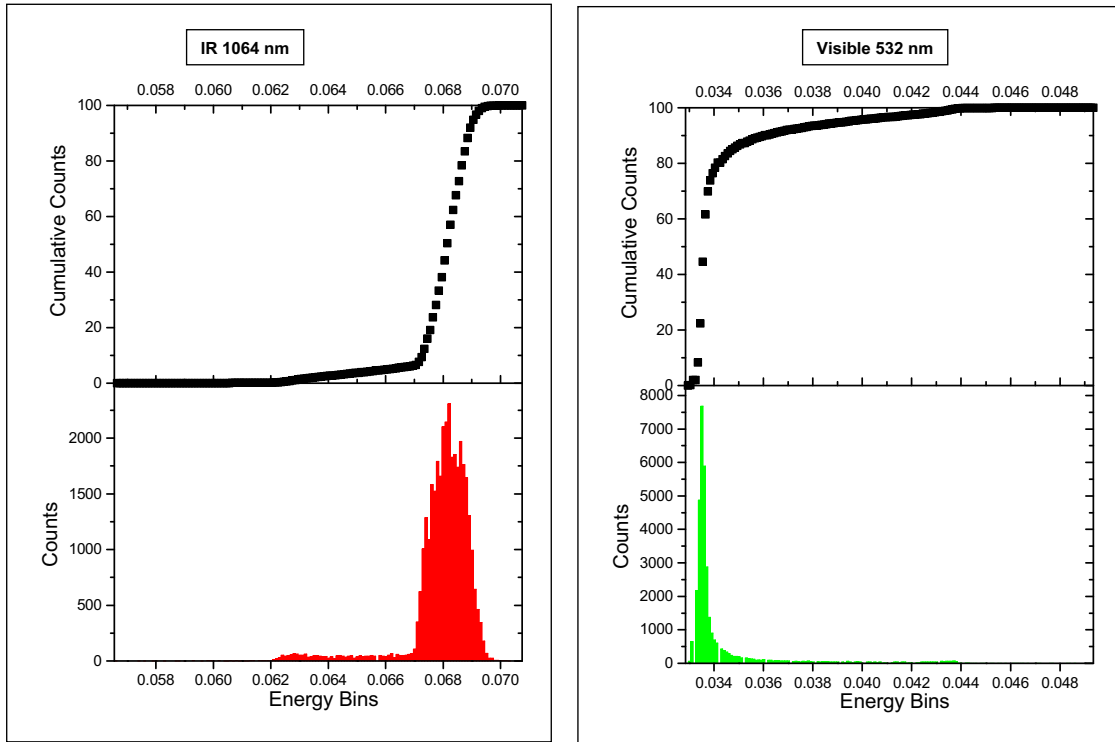

Laser 1 Total Energy - at nominal Temperature

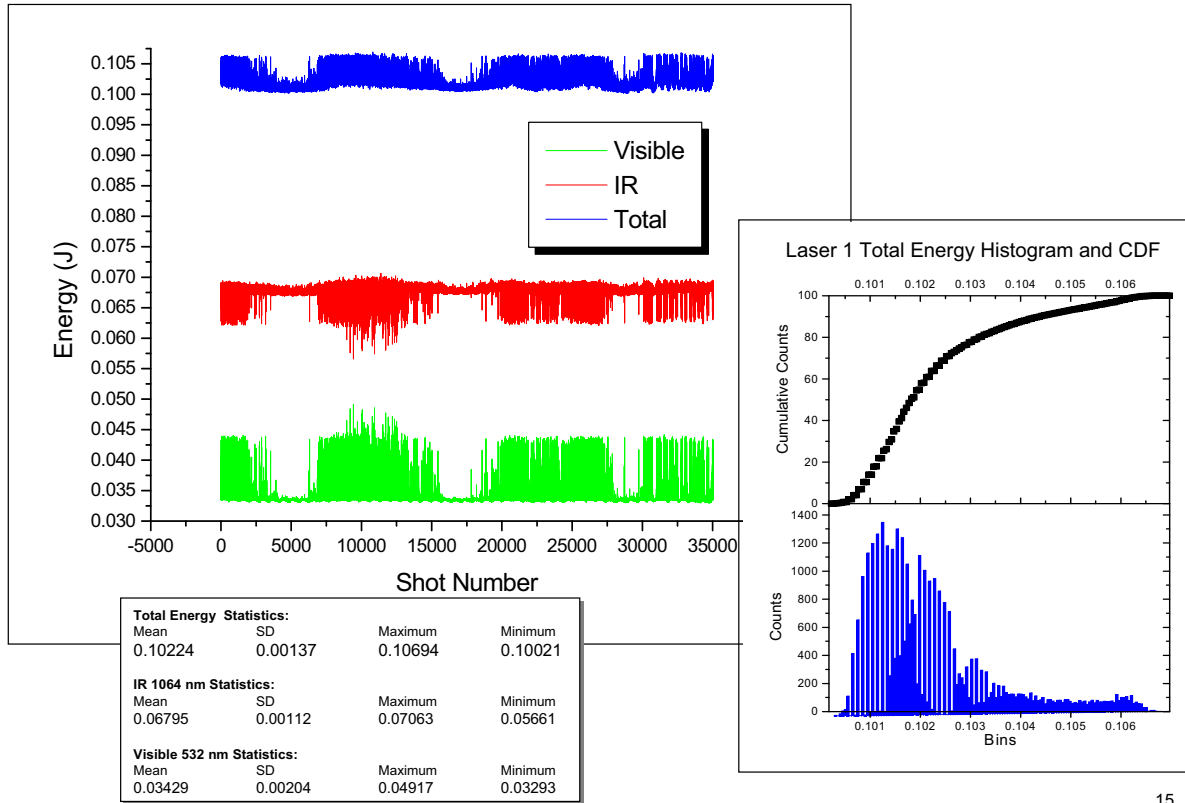

Comparison of “Quiet” with “Noisy” Data Statistics

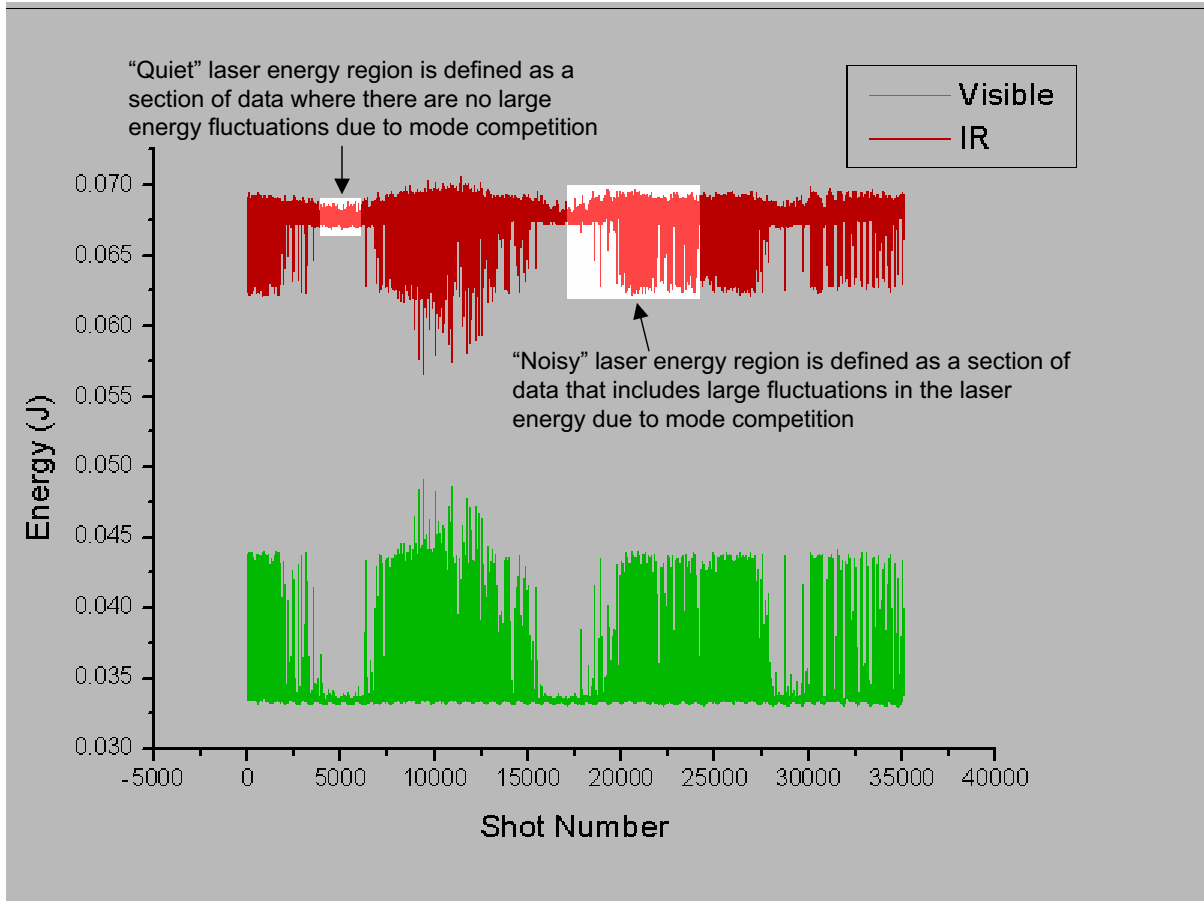

Laser 1 “Quiet Energy Region”

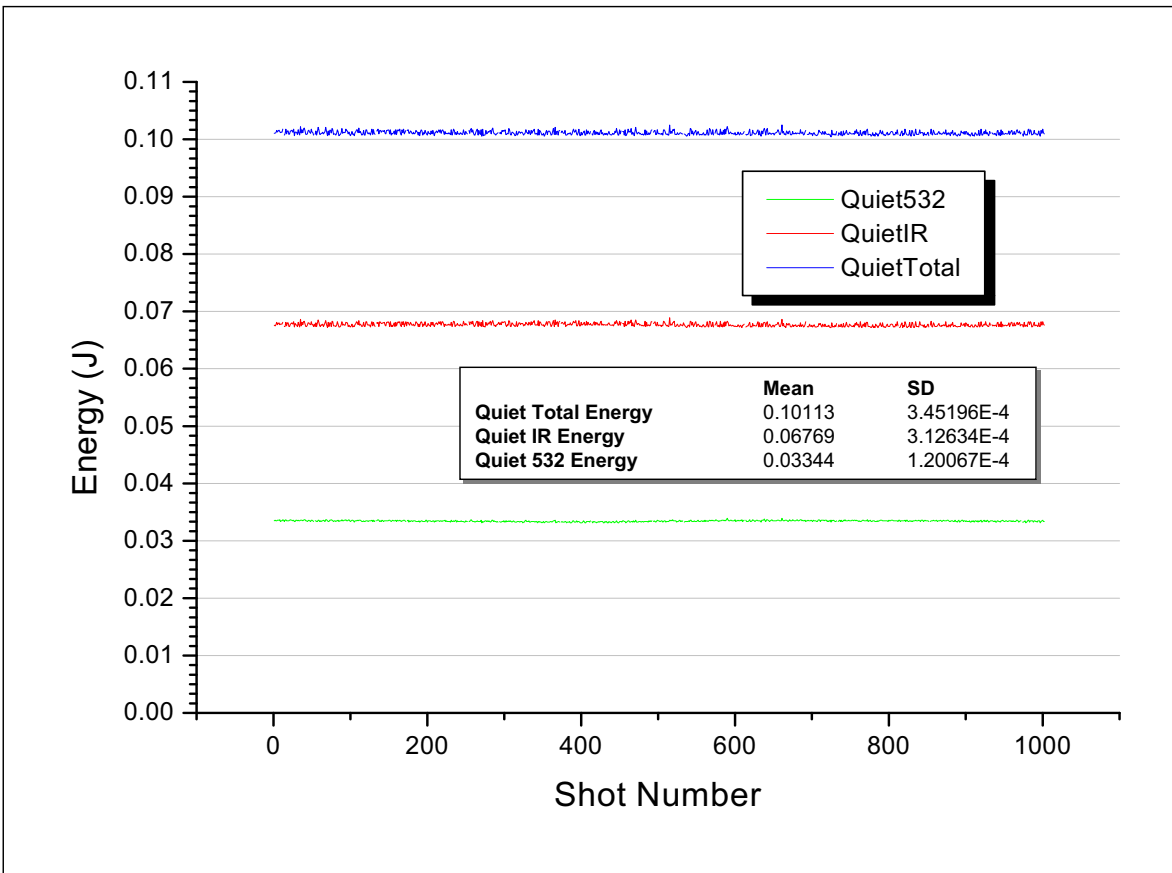

Laser 1 Noisy Data and Quiet Energy Data Comparison

	Noisy Data		Quiet Data		Noisy - Quiet
	Average	St Dev	Average	St Dev	Delta Average
Total Energy (mJ)	102.24	1.37	101.13	0.345	1.11
1064 nm Energy (mJ)	67.95	1.12	67.69	0.312	0.26
532 nm Energy (mJ)	34.29	2.04	33.44	0.12	0.85

Conclusion:

In this example, when comparing arbitrary sections of “quiet” and “noisy” data, the mean value of the total laser energy can change by 1.11 mJ (or ~ 1%).

The mean of the 1064 and 532 nm (Green) energies can change by 0.26 mJ and 0.85 mJ (or 0.38% and 2.47% respectively).

Thus, any laser energy measurement will have a small error (~1%) depending on the sampling time (region) and the number of “noisy” data included in the sample.

Laser 2 Energy - All data including laser turn on

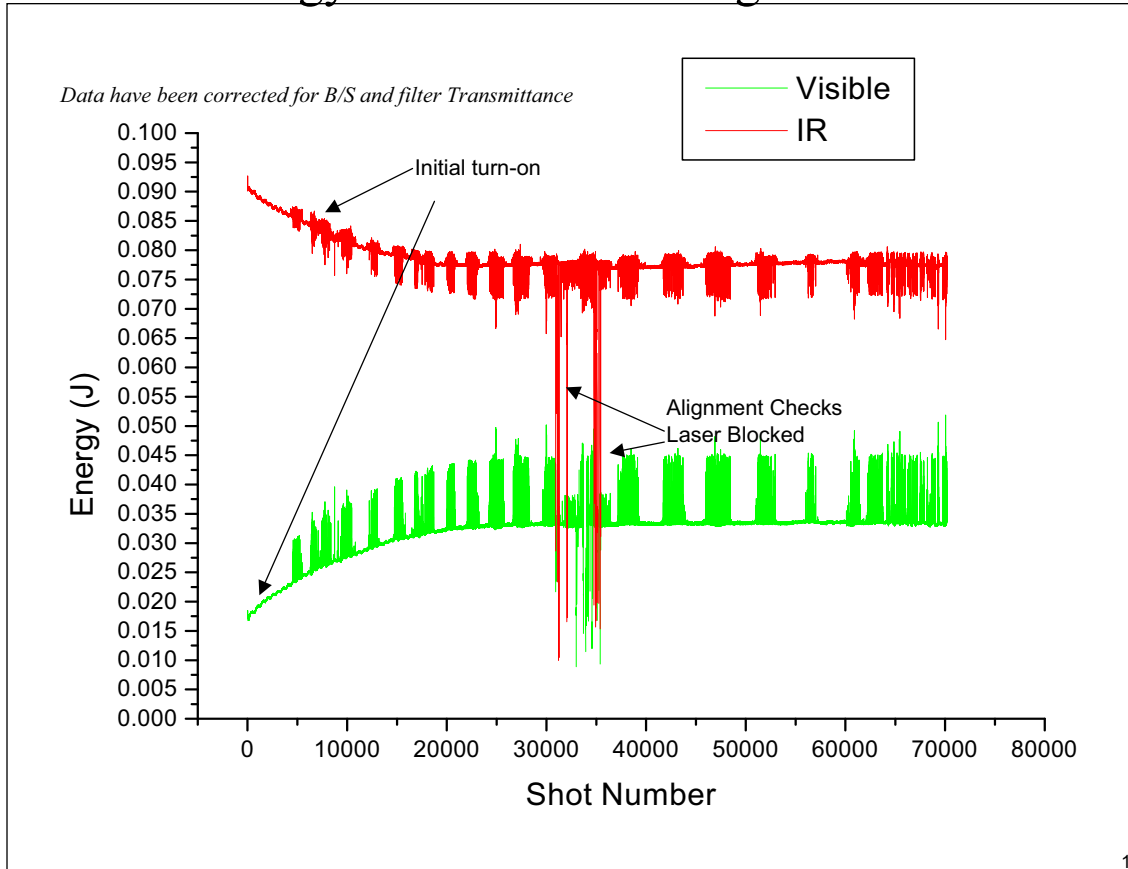

19

Laser 2 Energy - at nominal Temperature

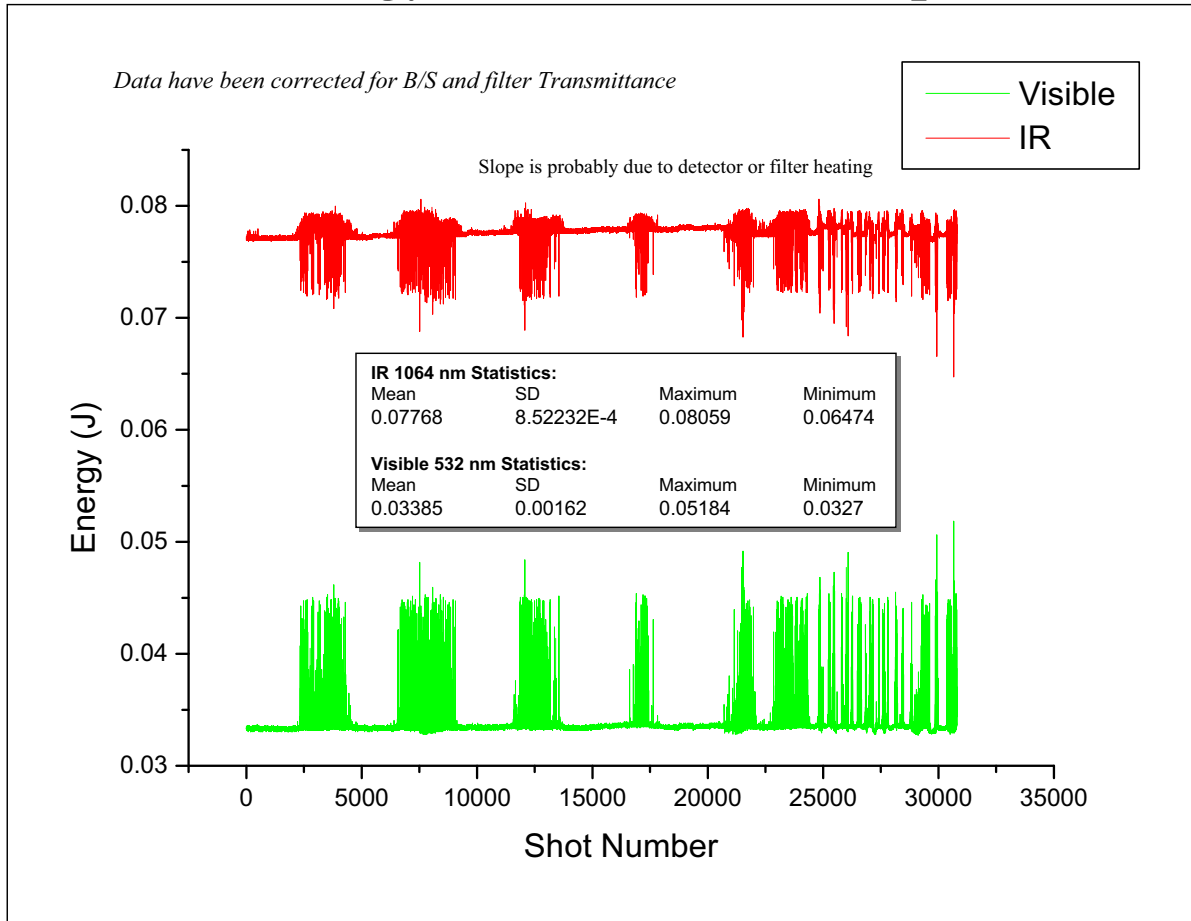

Laser 2 Energy Distributions

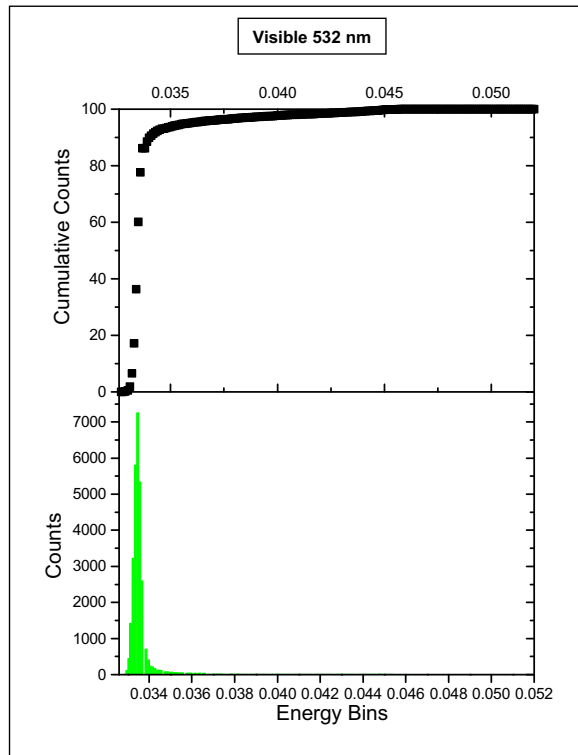
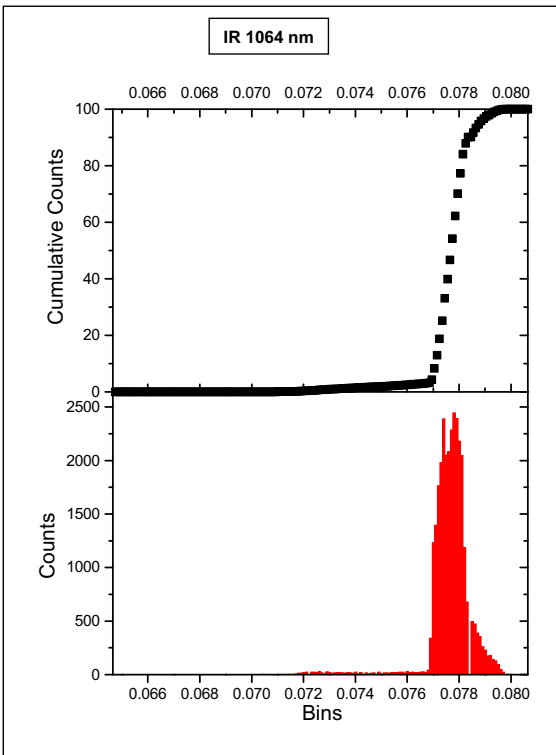

Laser 2 Energy - Normalized Deviation from the Mean

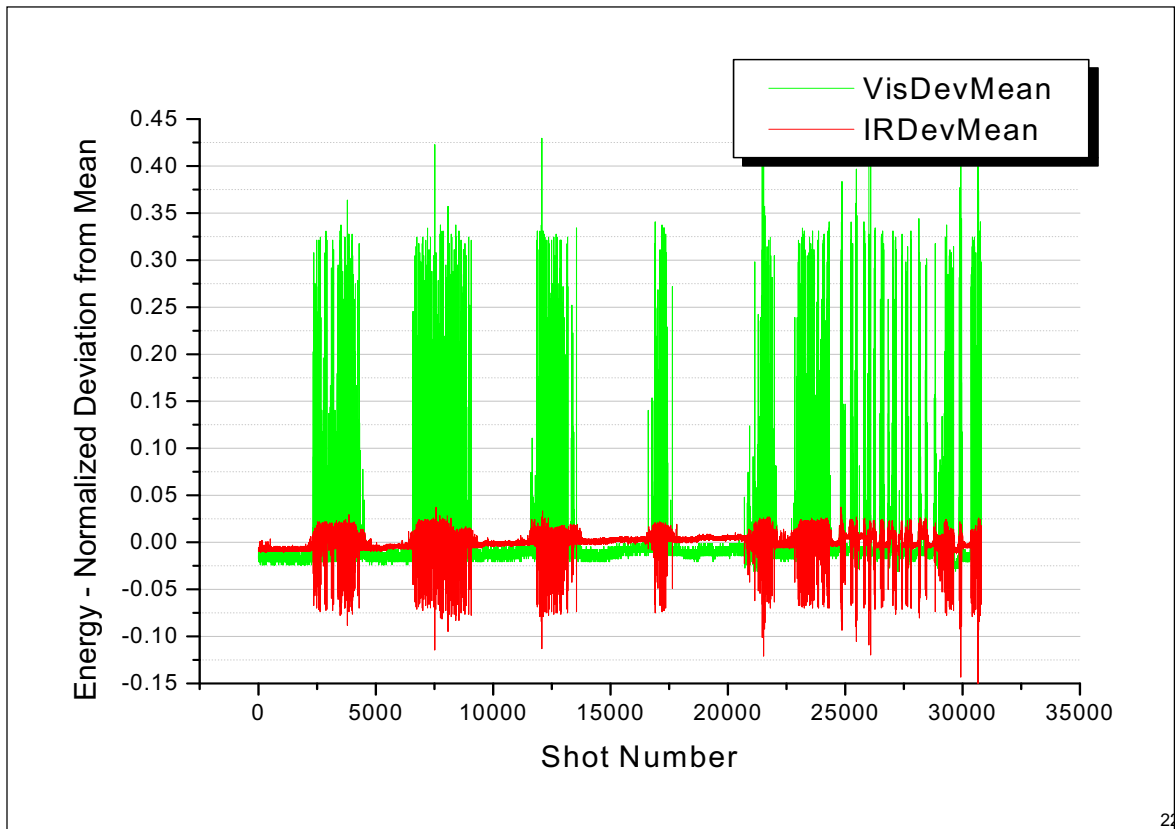

22

Laser 3 Energy - All data, including laser turn on

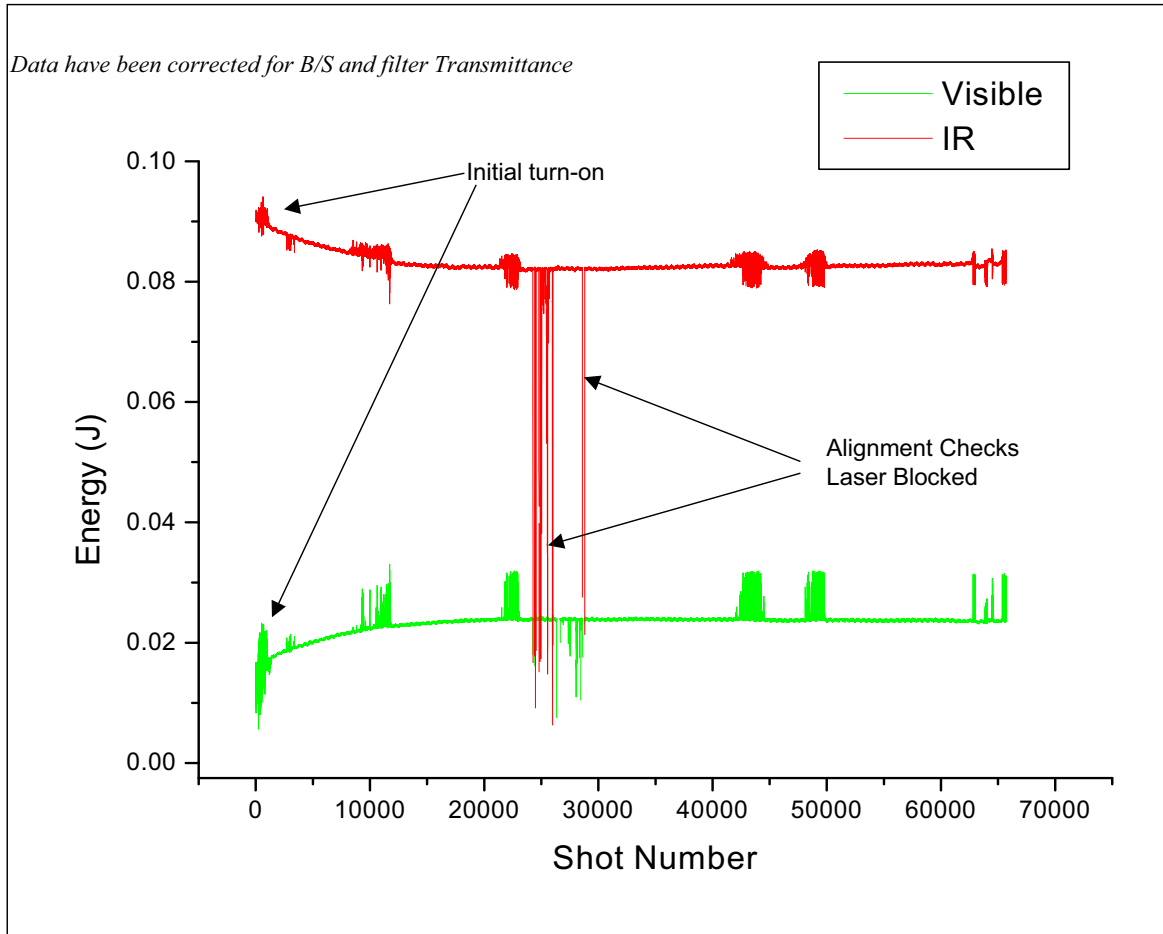

Laser 3 Energy - at nominal Temperature

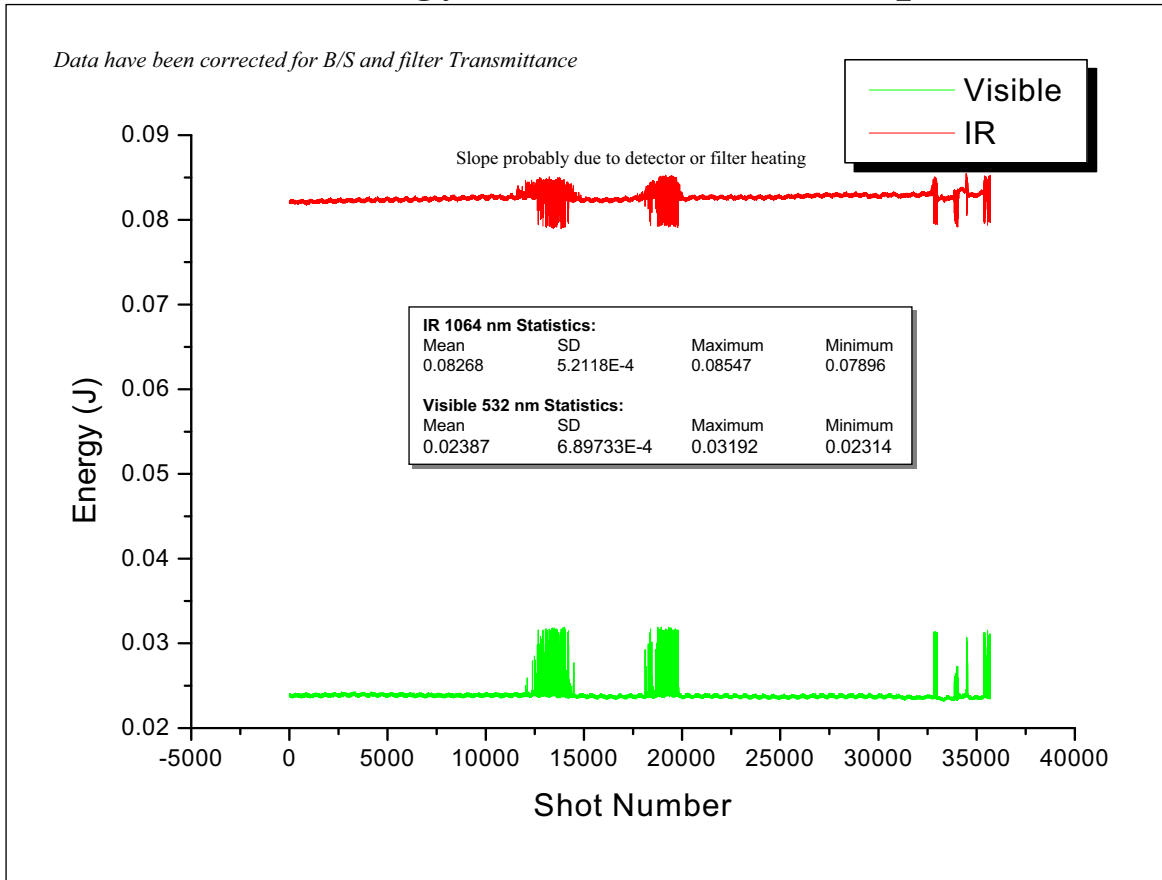

Laser 3 Energy Distributions

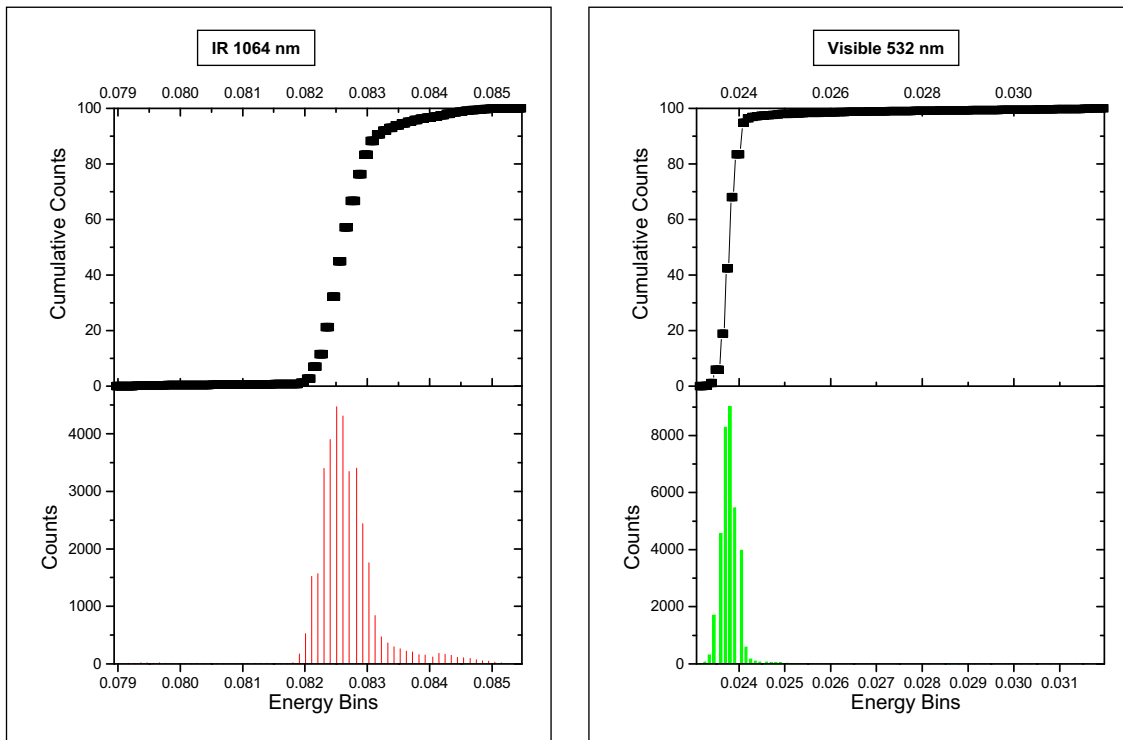

Laser 3 Energy - Normalized Deviation from the Mean

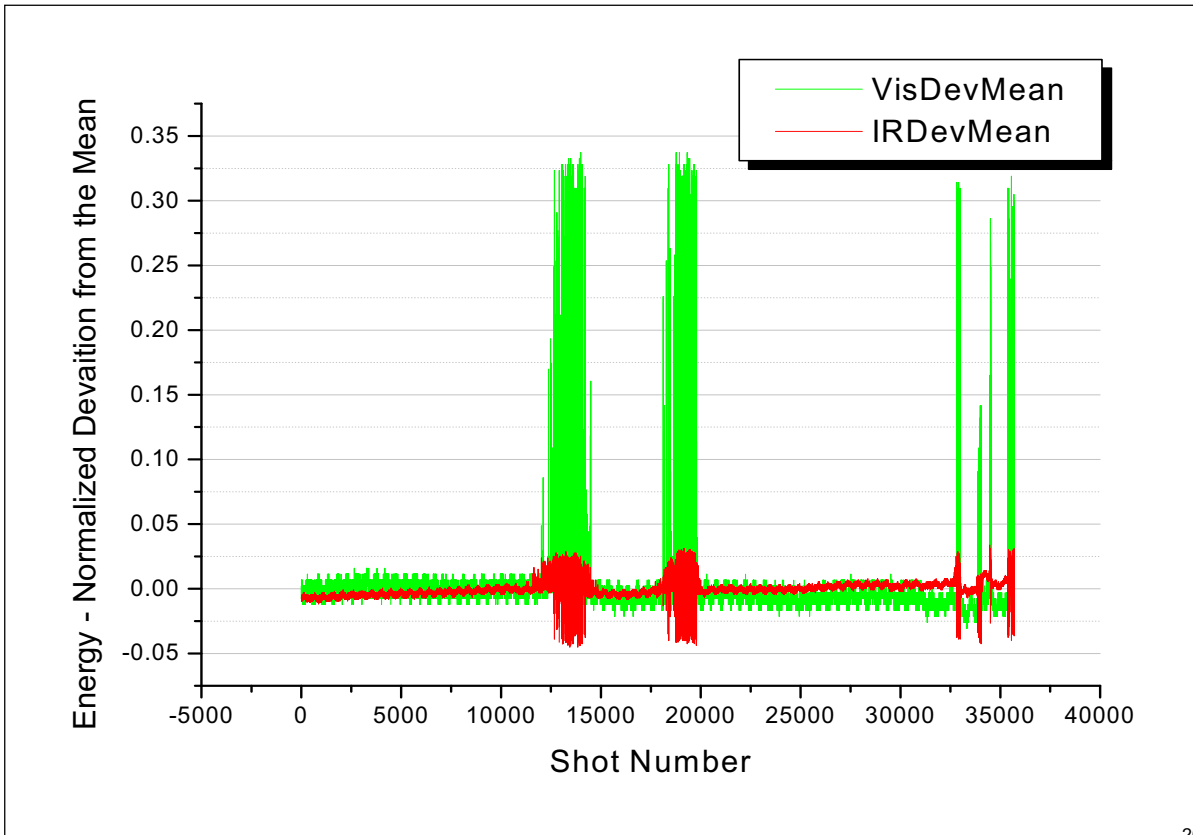

26

Laser Energy Summary

Oct 8 2002

	Observatory High Energy Molectron Measurements						Observatory - GSFC Delta			
	Min. Energy (mJ)		Max. Energy (mJ)		Aver. Energy (mJ)		ABS	ABS	%	%
Laser	532	1064	532	1064	532	1064	532	1064	532	1064
Laser 1	32.9	56.61	49.2	70.6	34.3	68.0	<i>Not Measured</i>		<i>Not Measured</i>	
Laser 2	32.7	64.7	80.6	80.6	33.9	77.7	0.0	-0.8	-0.1%	-1.1%
Laser 3	23.1	79.0	31.9	85.5	23.9	82.7	-1.33	1.0	-5.6%	1.2%

	GSFC High Energy Molectron Measurements					
	Min. Energy (mJ)		Max. Energy (mJ)		Aver. Energy (mJ)	
Laser	532	1064	532	1064	532	1064
Laser 1	<i>Not Measured</i>		<i>Not Measured</i>		<i>Not Measured</i>	
Laser 2*	33.0	72.9	45.9	84.0	33.9	78.5
Laser 3**	24.5	74.6	36.8	86.0	25.2	81.7

Altimeter Detector laser energy calibration

GLAS detector data collected on:

2002, Day 264 with Detector 1, Digitizer 1 (Tx Gain=41)

2002, Days 184, 201, and 247 with Detector 2, Digitizer 2 (Tx Gain=41)

Assumption: Nothing changed between Days 264, 184, 201, 247 and Day 281 when the detector 1, and 2, and the high energy Molectron measurements were taken

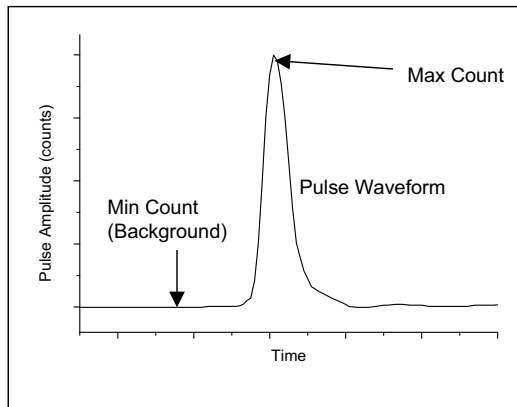

Estimate of GLAS Energy from Altimeter Detectors

$$\hat{E} = \frac{\Delta\tau \times \sum_0^{47} v(i)}{\eta_c \cdot \eta_{optical} \cdot R_{det} \cdot G_{VGA} \cdot \alpha_{cal}} \quad (5)$$

where

\hat{E} is the laser pulse energy in Joules corresponding to the waveform sample.

$\Delta\tau$ is the sampling interval = 1×10^{-9} secs.

$\eta_c = 92.3\%$ is the circuit throughput from the detector to the digitizer

$\eta_{optical}$ is the fiber box and fiber transmission for the transmitted pulse, per laser per detector/digitizer combination. $\eta_{optical}$ was estimated from ground testing data:

	Detector 1	Detector 2
Laser 1	2.965×10^{-14}	N/A
Laser 2	2.786×10^{-14}	2.257×10^{-14}
Laser 3	2.793×10^{-14}	2.336×10^{-14}

$R_{det} = 2.28e7$ Volts/Watts is the detector responsivity

α_{cal} is a calibration coefficient determined by system level test data to be 1.12

G_{VGA} is the normalized gain of the variable gain amplifier (VGA).

$$G_{VGA} = \frac{C_{gain}}{2^8 - 1}$$

with C_{gain} the integer valued detector gain in the telemetry. Nominal value for C_{gain} is 41.

Estimate of GLAS Energy from Altimeter Detectors

The relationship between the digitizer output and the input can be written as

$$y_i = f_{AD}[v_r(i) + \delta v_{DC}]$$

where

$f_{AD}(x)$ is the altimeter digitizer voltage to counts conversion function,

$v(i)$ is the i^{th} waveform sample in volts, $i = 0, 1, \dots, 47$

δv_{DC} is a random DC offset in volts.

To convert the integer valued waveform data, y_i , and integer valued DC offset, y_{DC_n} , to voltage, use the equations

$$v_r(i) = f_{AD}^{-1}(y_i) - f_{AD}^{-1}(y_{DC_n})$$

The conversion function, $f_{AD}^{-1}(x)$, is given by:

$$f_{AD}^{-1}(x) = \begin{cases} a_1 \cdot x_i + b_1 & \text{if } 0 \leq x_i \leq 127 \\ a_2 \cdot x_i + b_2 & \text{if } 127 < x_i \leq 255 \end{cases}$$

with the coefficient values given in the following table:

	a_1	b_1	a_2	b_2
Dig#1 (SN1)	0.006675	-0.195279	0.006198	-0.134420
Dig#2 (SN2)	0.006625	-0.193828	0.006128	-0.130443

y_{DC_n} is estimated by taking the *mean* value of the first nine ($i=0$ to 8) points in the transmit waveform.

$f_{AD}^{-1}(y_{DC_n})$ always uses the a_1, b_1 coefficients since it is always less than 127 counts.

y_{DC_n} is typically near 30 counts.

Altimeter Detector laser energy calibration
Detector1 Digitizer 1
Day 264

Laser 1 GLAS Detector1 - ALL data, including laser turn on

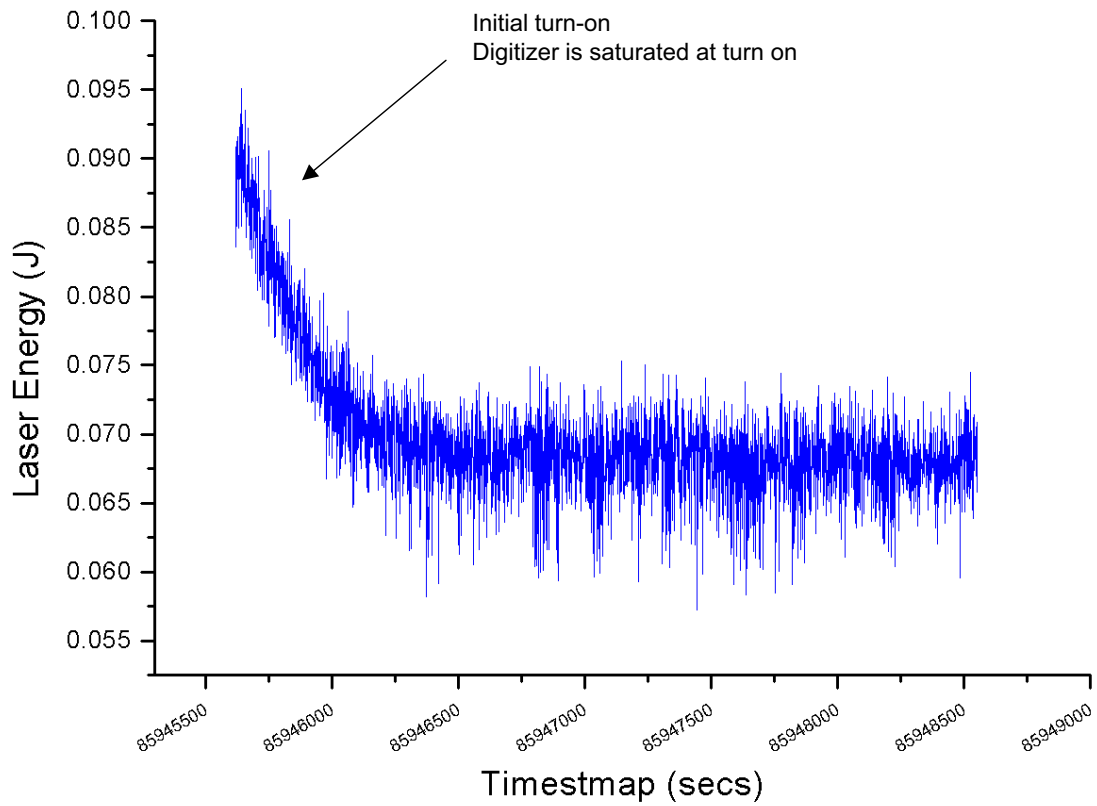

Laser 1 GLAS Detector1 - at nominal Temperature

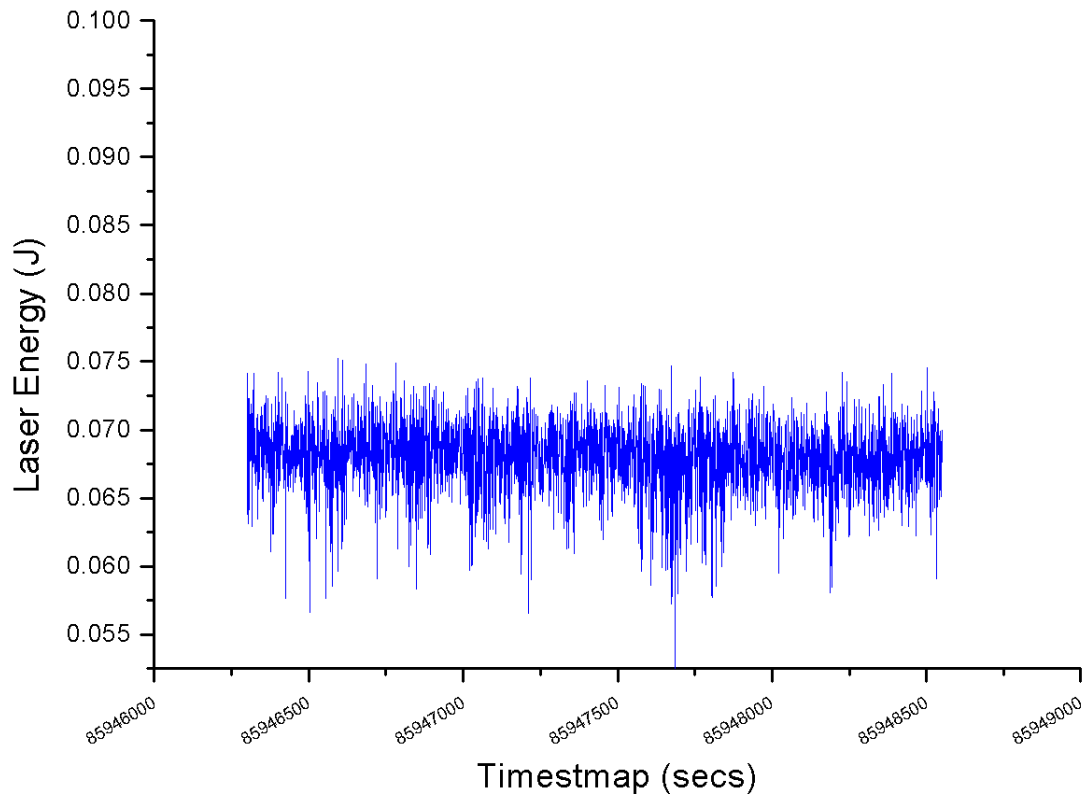

Laser 1 GLAS Detector1 Energy Statistics - at nominal Temperature

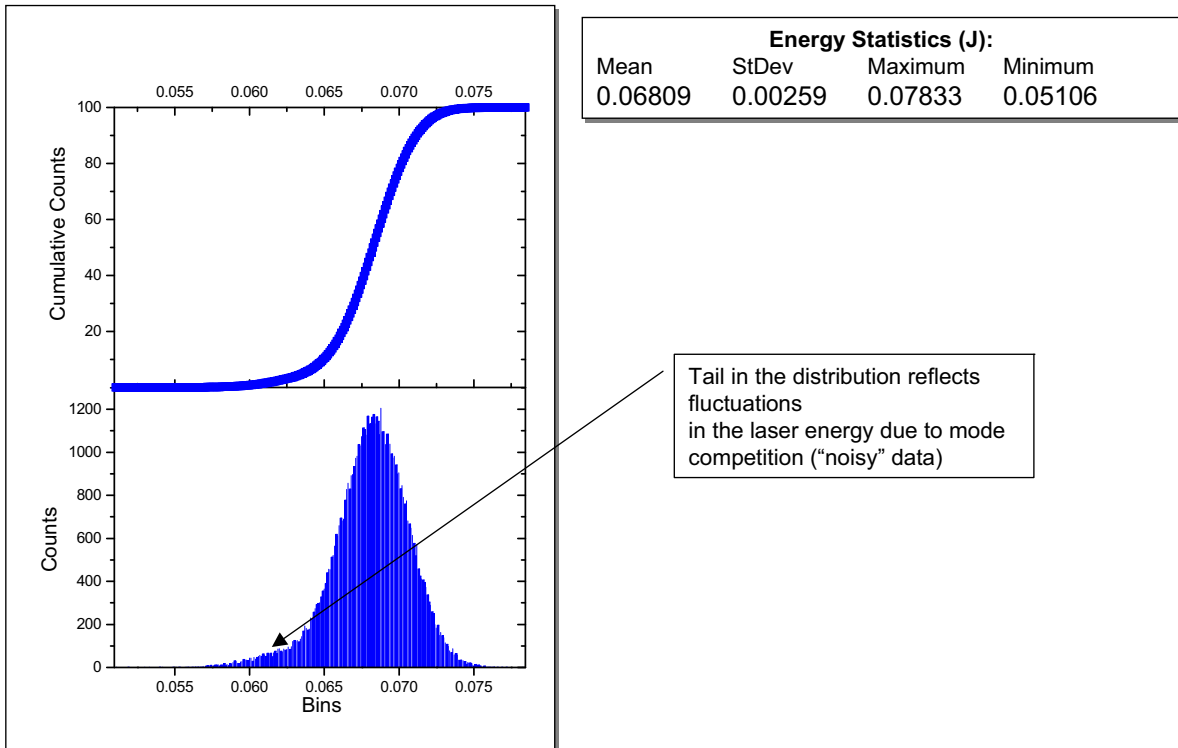

Laser 2 GLAS Detector1 - ALL data, including laser turn on

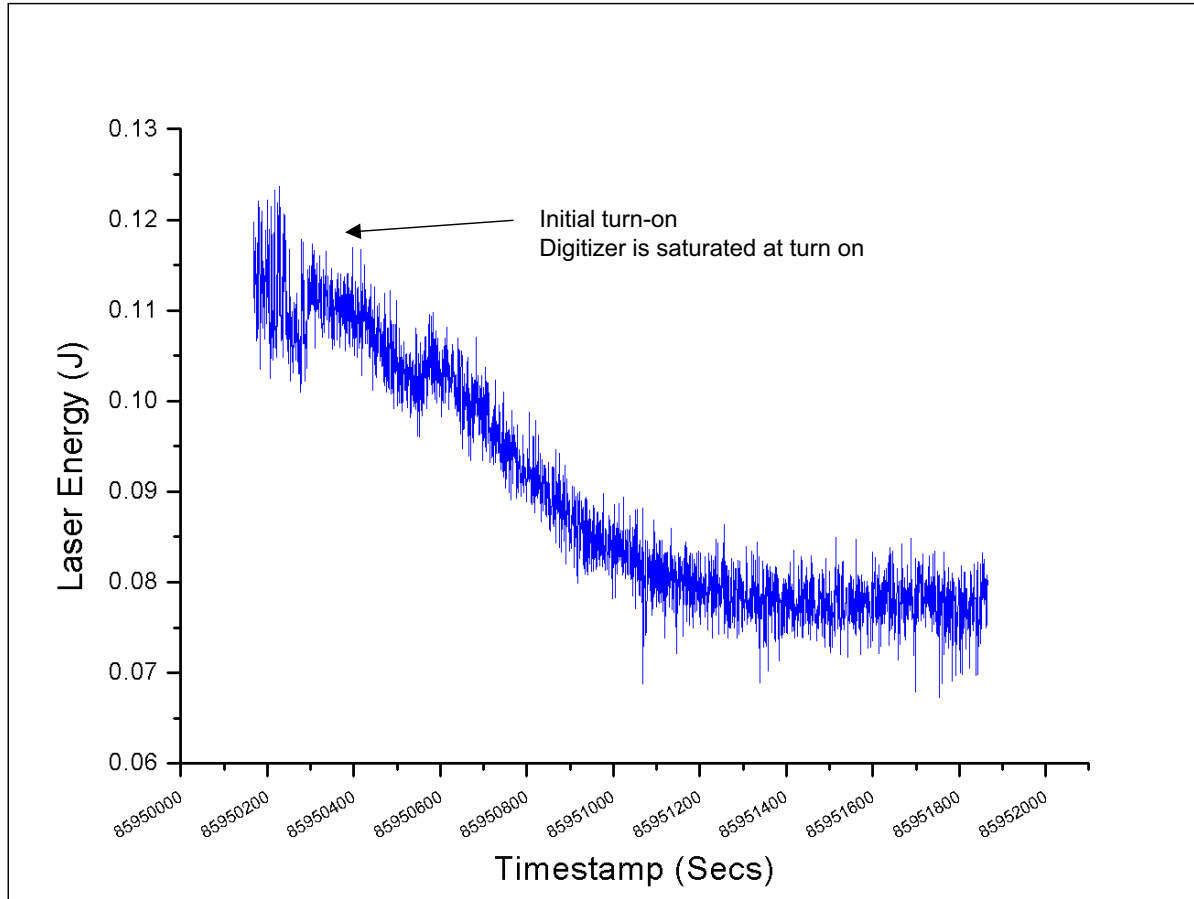

Laser 2 GLAS Detector1 - at nominal Temperature

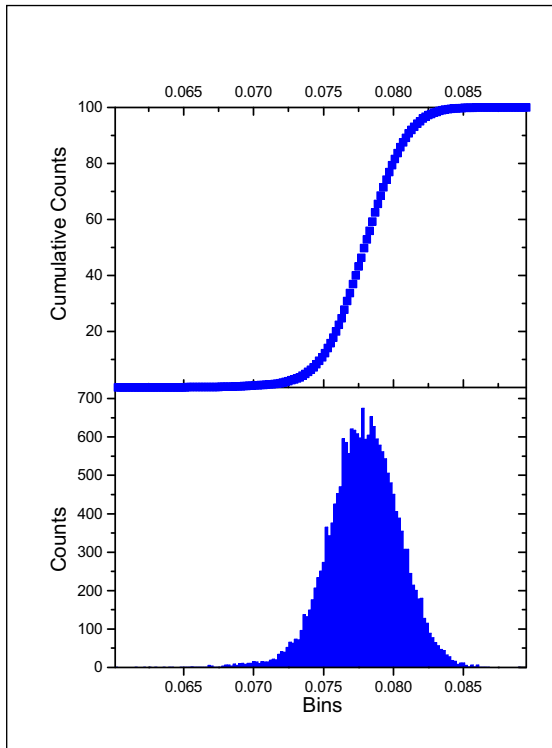

Energy Statistics (J):			
Mean	StDev	Maximum	Minimum
0.07787	0.00255	0.08904	0.06025

Laser 3 GLAS Detector1 - ALL data, including laser turn on

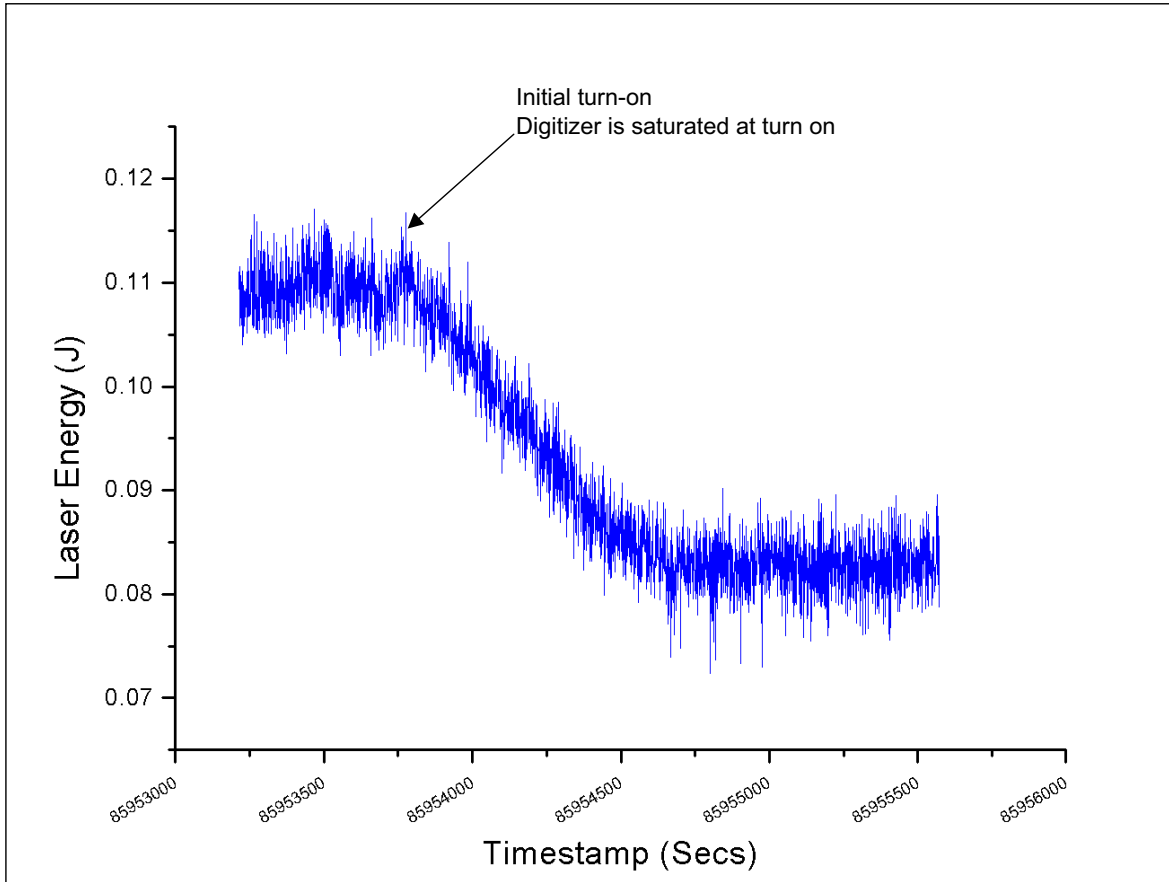

Laser 3 GLAS Detector1 - at nominal Temp.

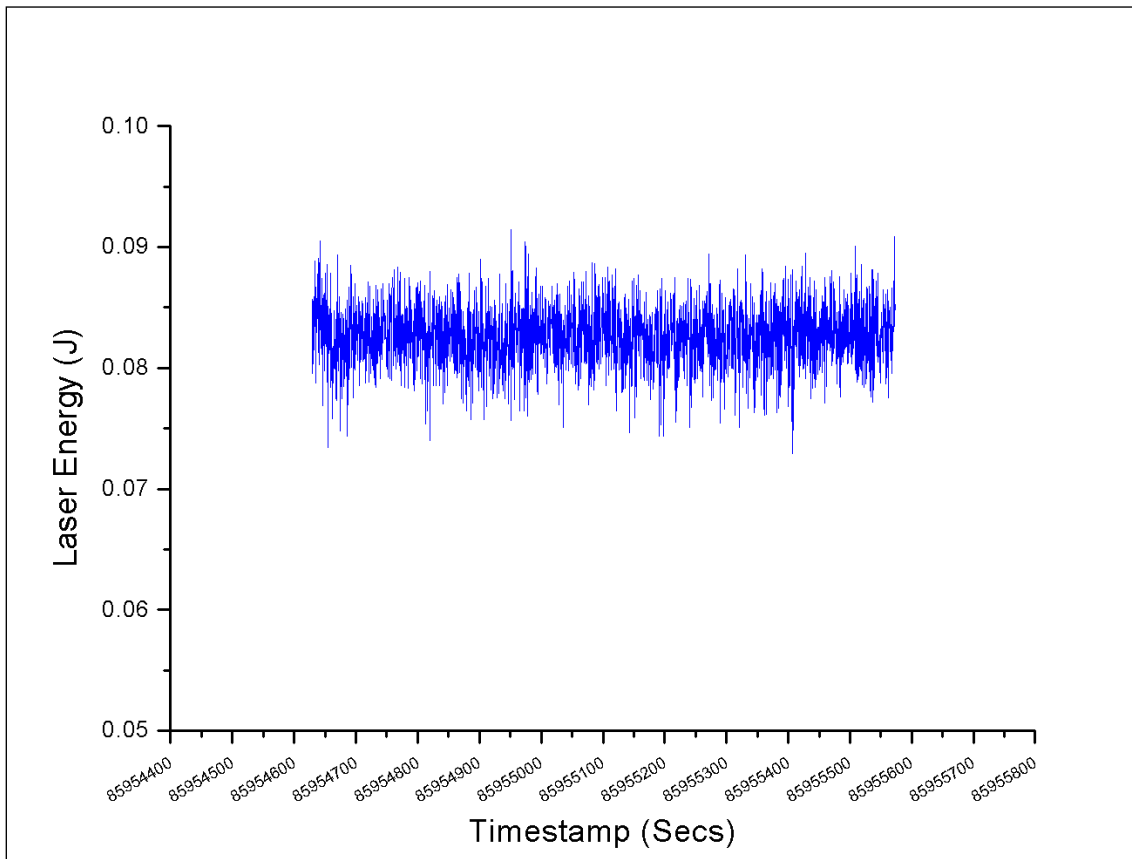

Laser 3 GLAS Detector1 Statistics- at nominal Temp

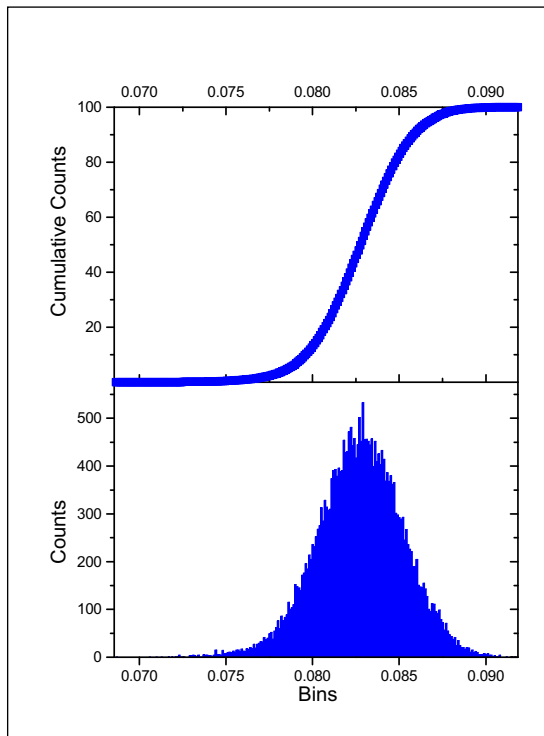

Energy Statistics (J):			
Mean	StDev	Maximum	Minimum
0.08272	0.0025	0.09174	0.06866

Relative Laser Energy Measurements during instrument and observatory TVAC

- All TVAC data are in air-vacuum.
- All BCE energy (Molectron) measurements are *relative*
- Adjustments to the BCE attenuation levels were needed during the test (highlighted in most plots)
- The altimeter detector energy values (1064 nm only) are derived using the same algorithm as in orbit
- Note that there will be a change in the altimeter detector energy when Tx gain adjustments were made

Relative Laser Energy Measurements during instrument TVAC with Main Target

- The 1064 and 532 nm energy measurements from the Main Target use two, low-energy detectors (Molelectron J3S-10) with fiber pick offs on an integrating sphere (see next slide).
- All Molelectron energies are ***relative not absolute***
- Adjustments to the attenuation levels were made during the test (highlighted in most plots)
- The altimeter detector energy values (1064 nm only) are derived using the same algorithm as in orbit
- Note that there will be a change in the altimeter detector energy when Tx gain adjustments were made.

Relative Laser Energy Measurements during Instrument TVAC using Main Target and BCE Laser Test System (LsrTS)

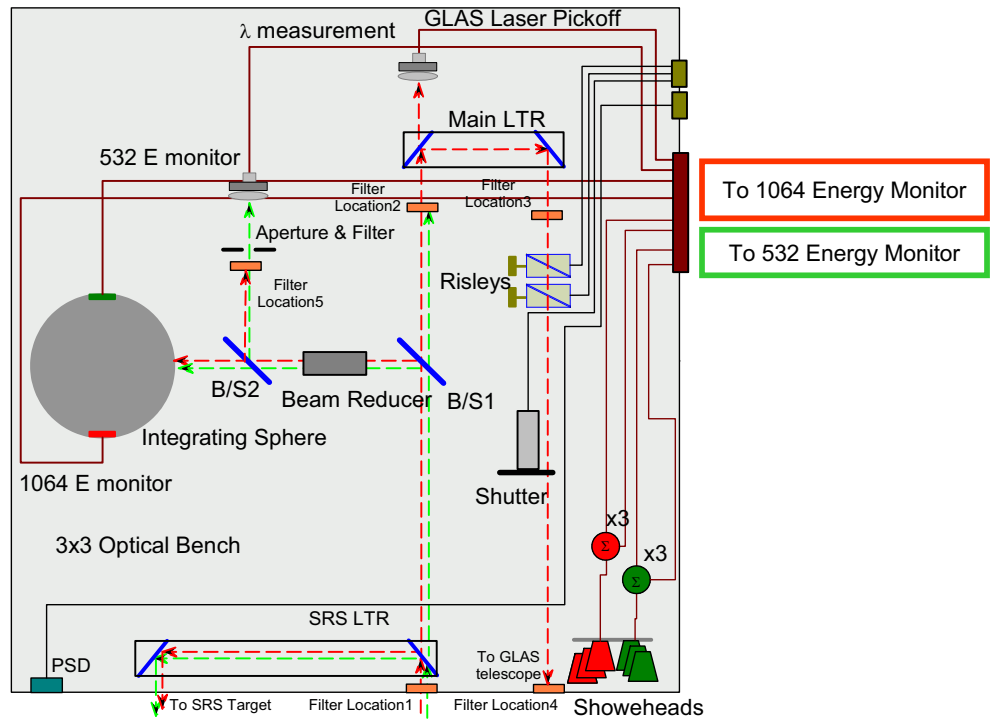

Drawing not to scale!

Laser 1

Laser 1 Detector and Moleclectron Relative Energies vs. Time (1 min averages)

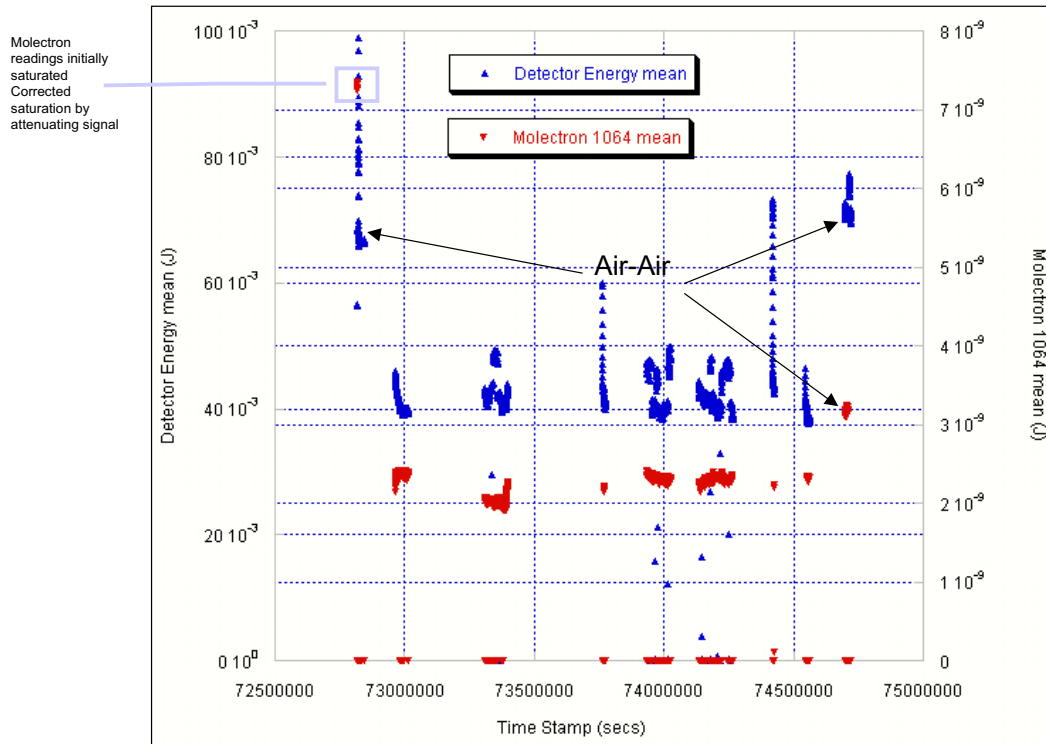

Laser 1 Energies (1 min averages) vs. Index

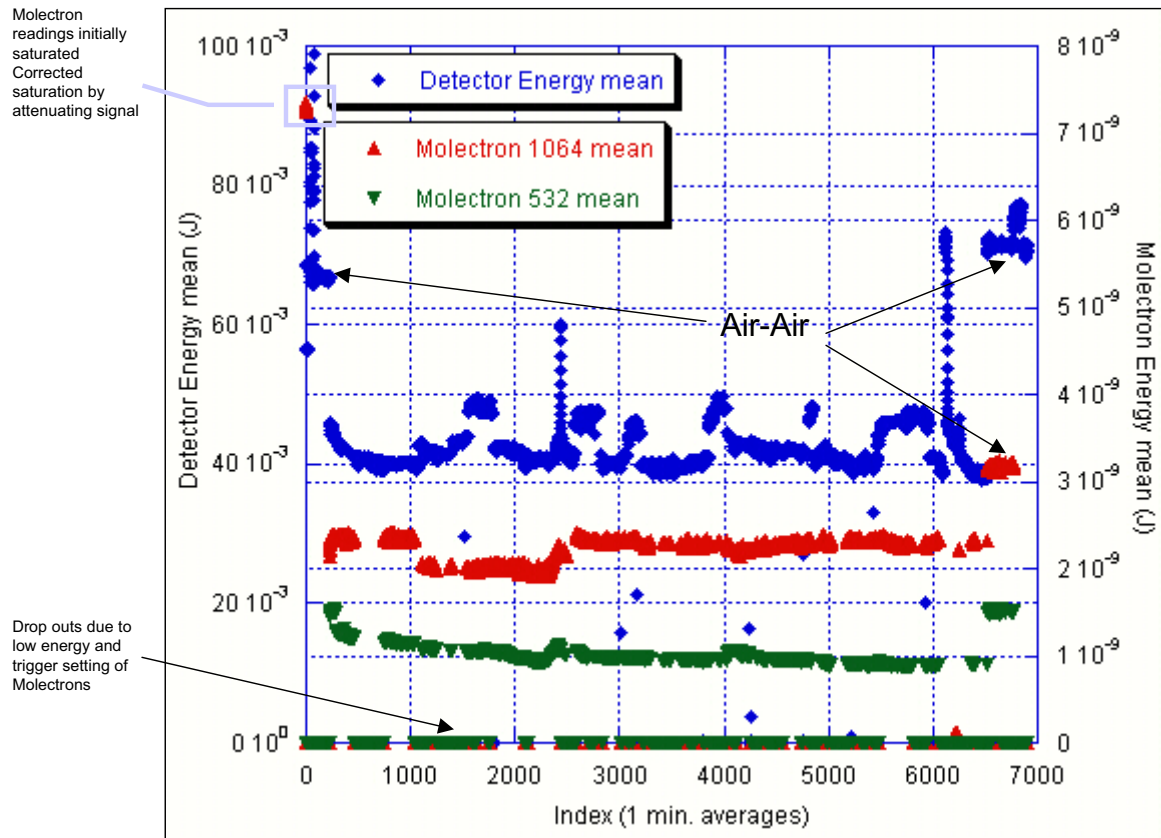

Laser 1 Osc. & Amp. Current (1 min averages) vs. Index

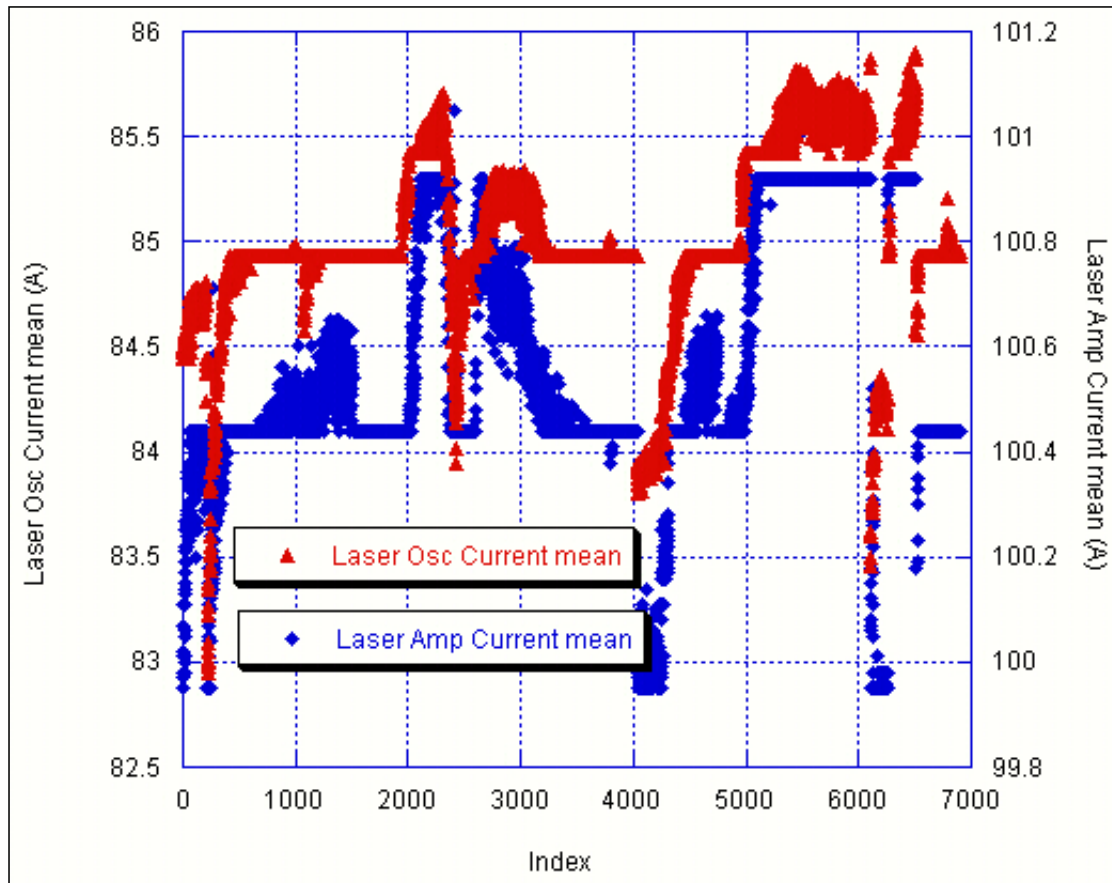

Laser 1 Temperatures (1 min averages) vs. Index

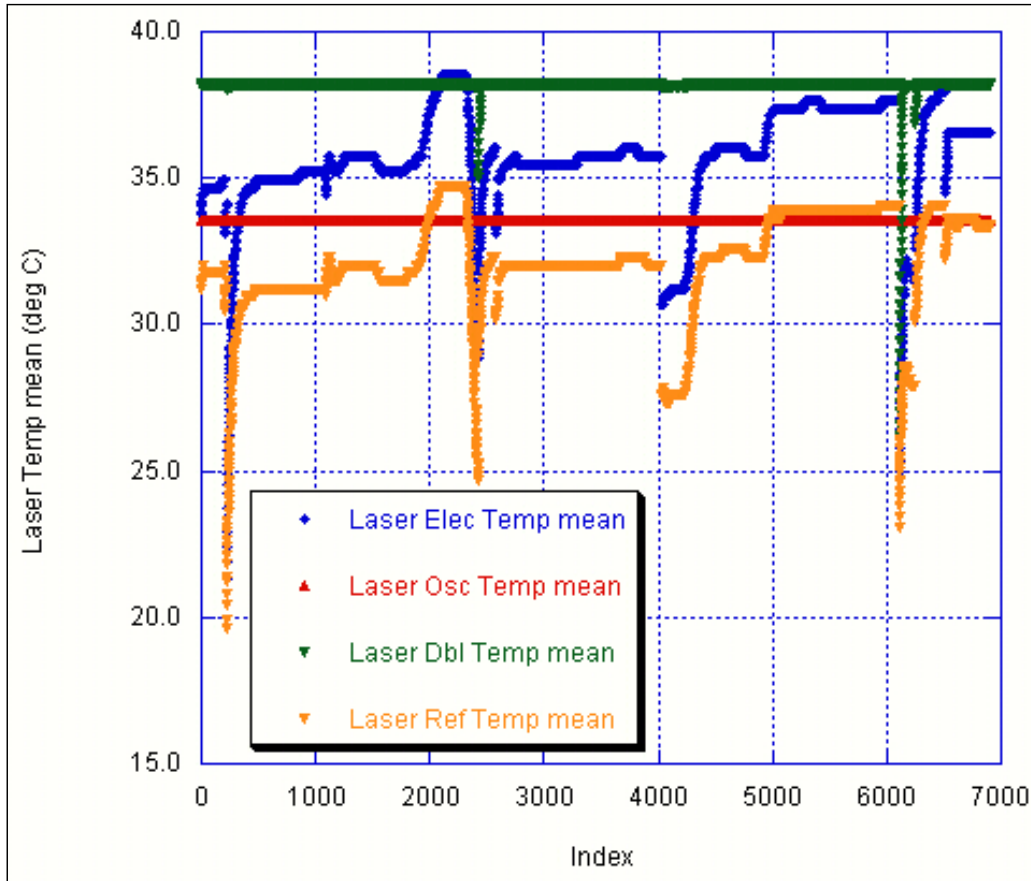

Laser 1 Energy and Drive Pulsewidth (1 min averages) vs. Index

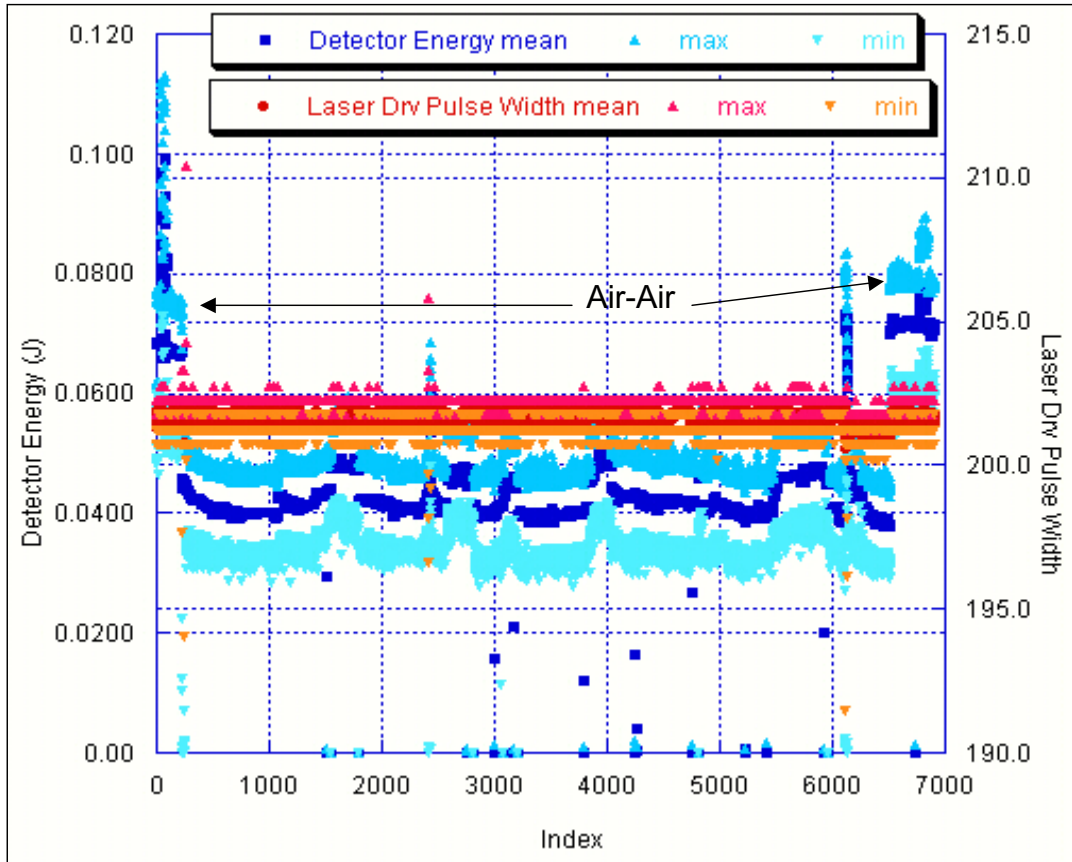

Laser 1 Drive Pulsewidth (1 min averages) vs. Index

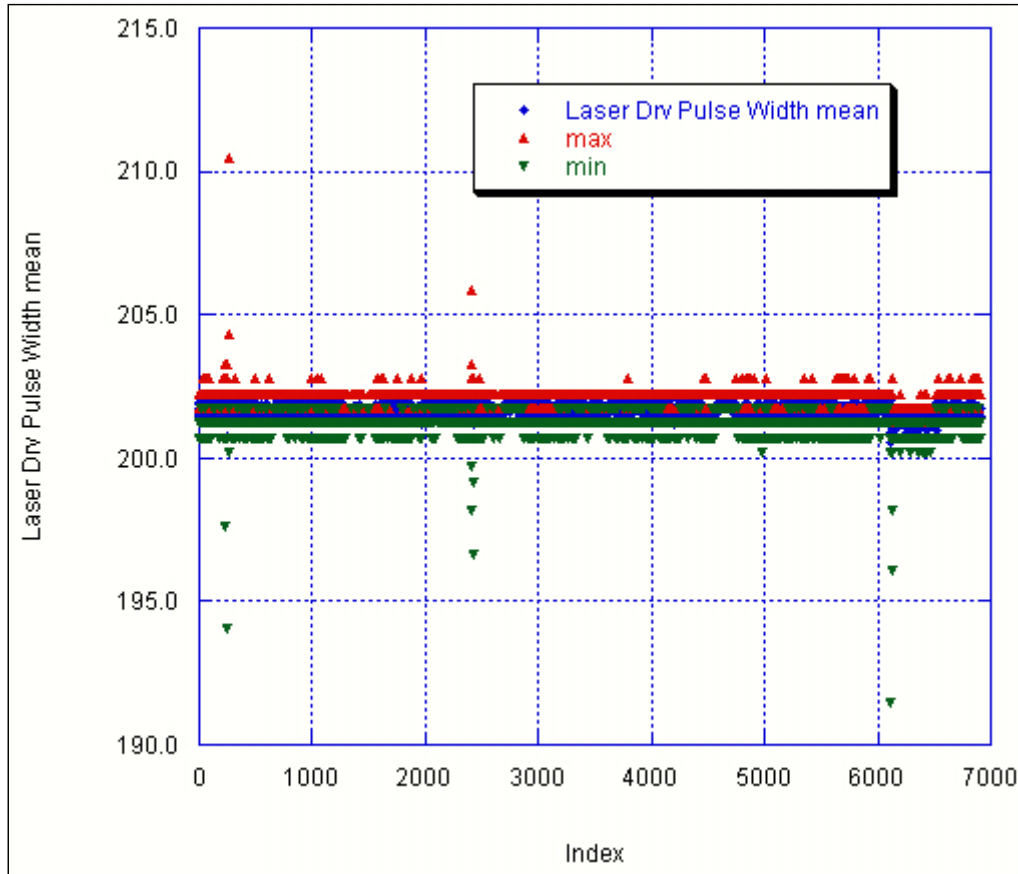

Laser 1 Drive Pulsewidth (1 min averages) vs. Index

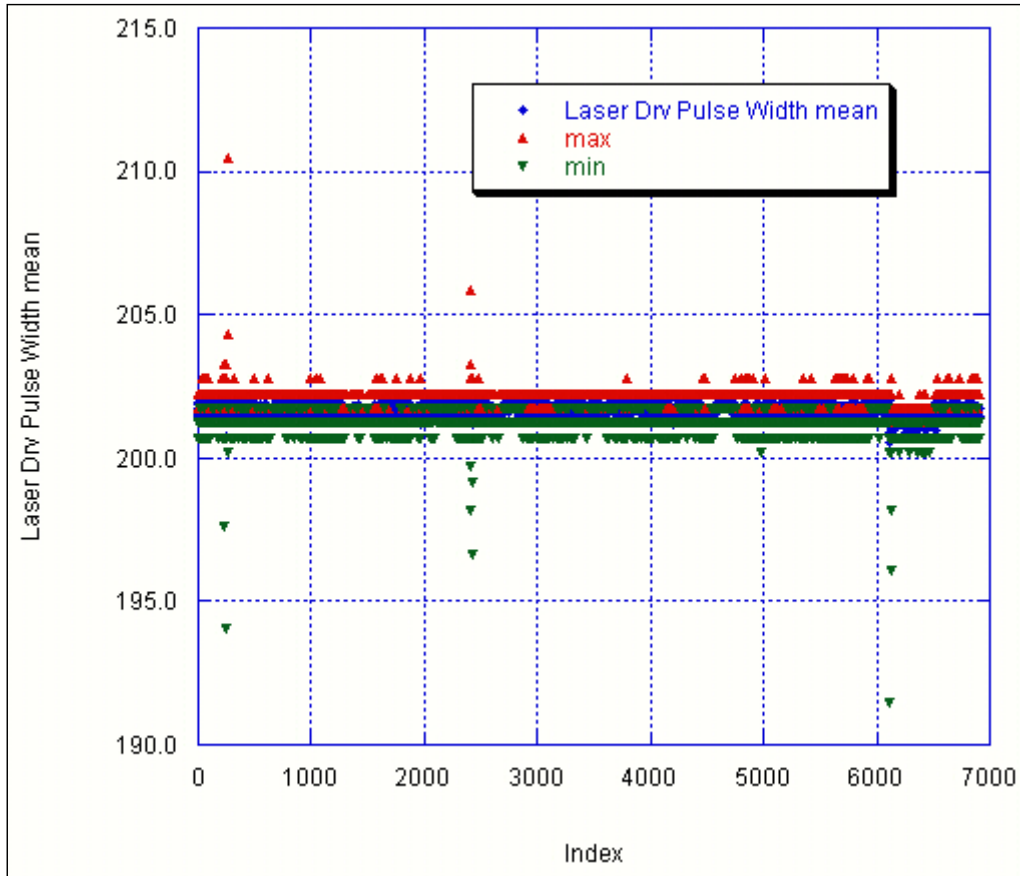

Laser 1 Drive Pulsewidth and Reference Temperature (1 min averages) vs. Time

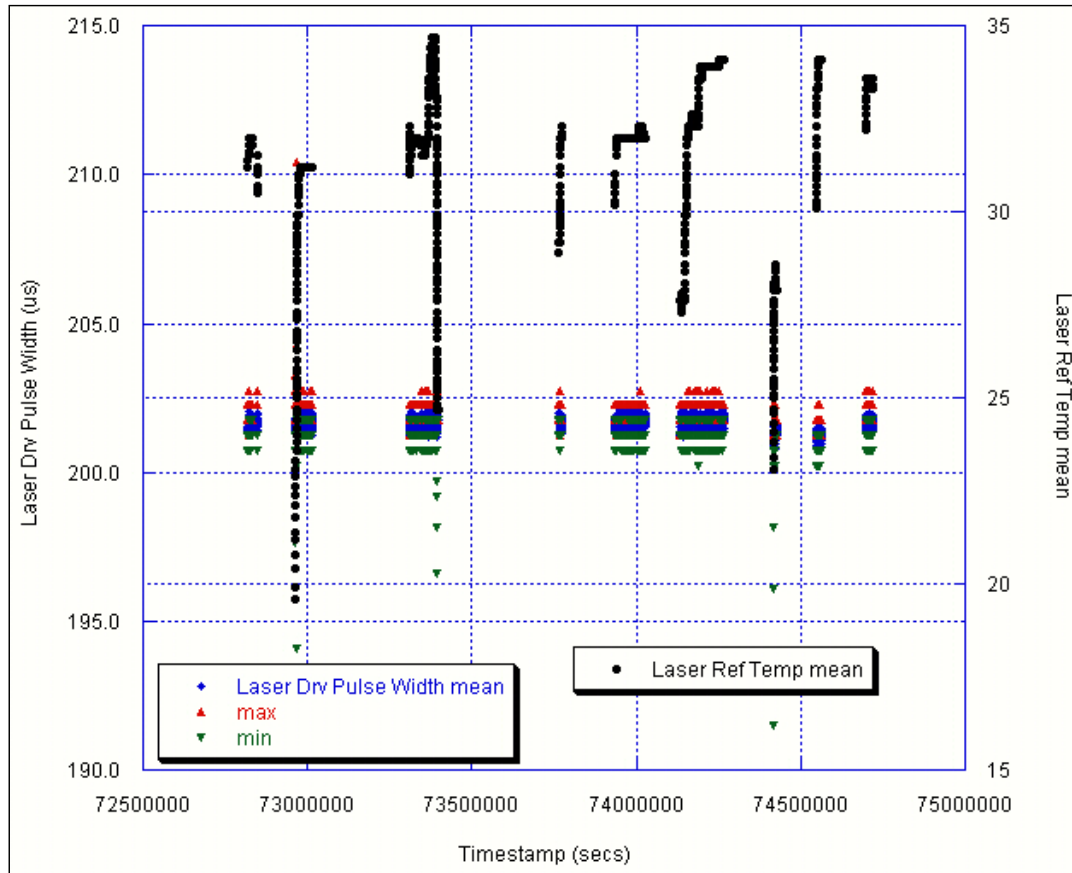

Laser 1 Energy and Gain (1 min averages) vs. Index

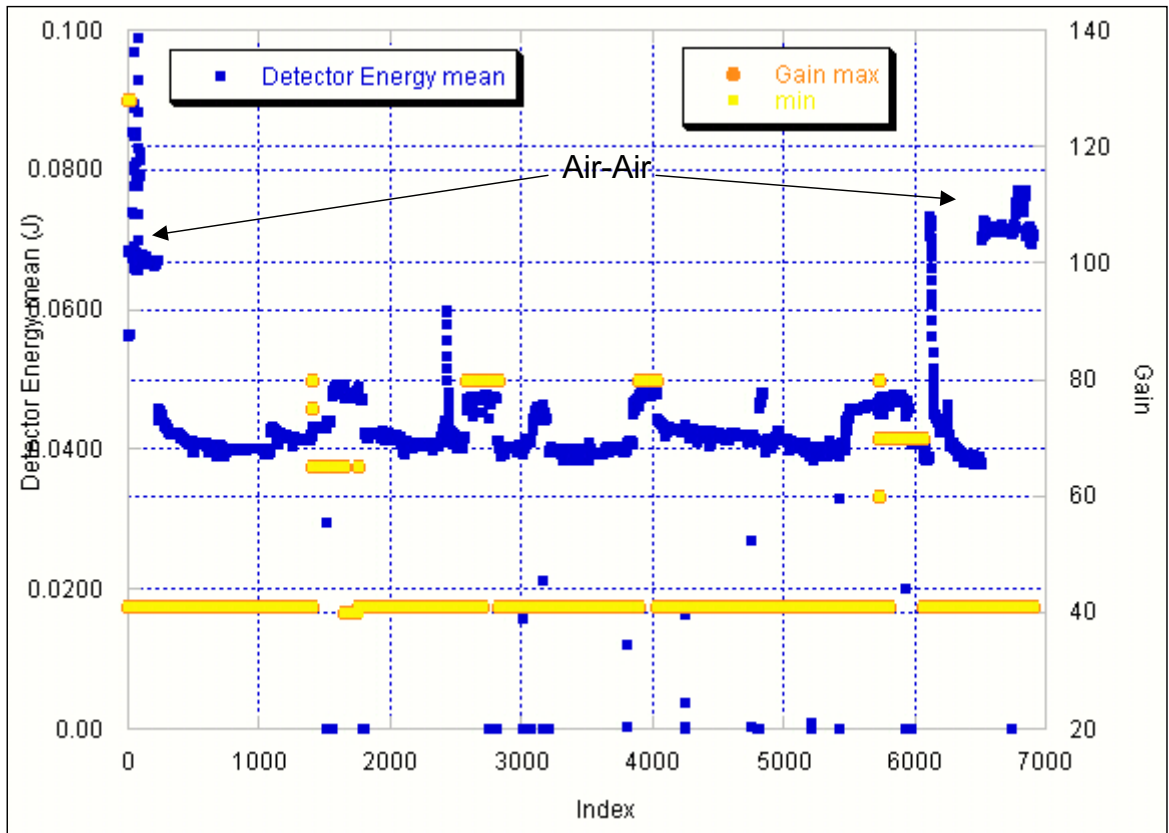

Laser 1 Energy and Ref. Temp. (1 min averages) vs. Index

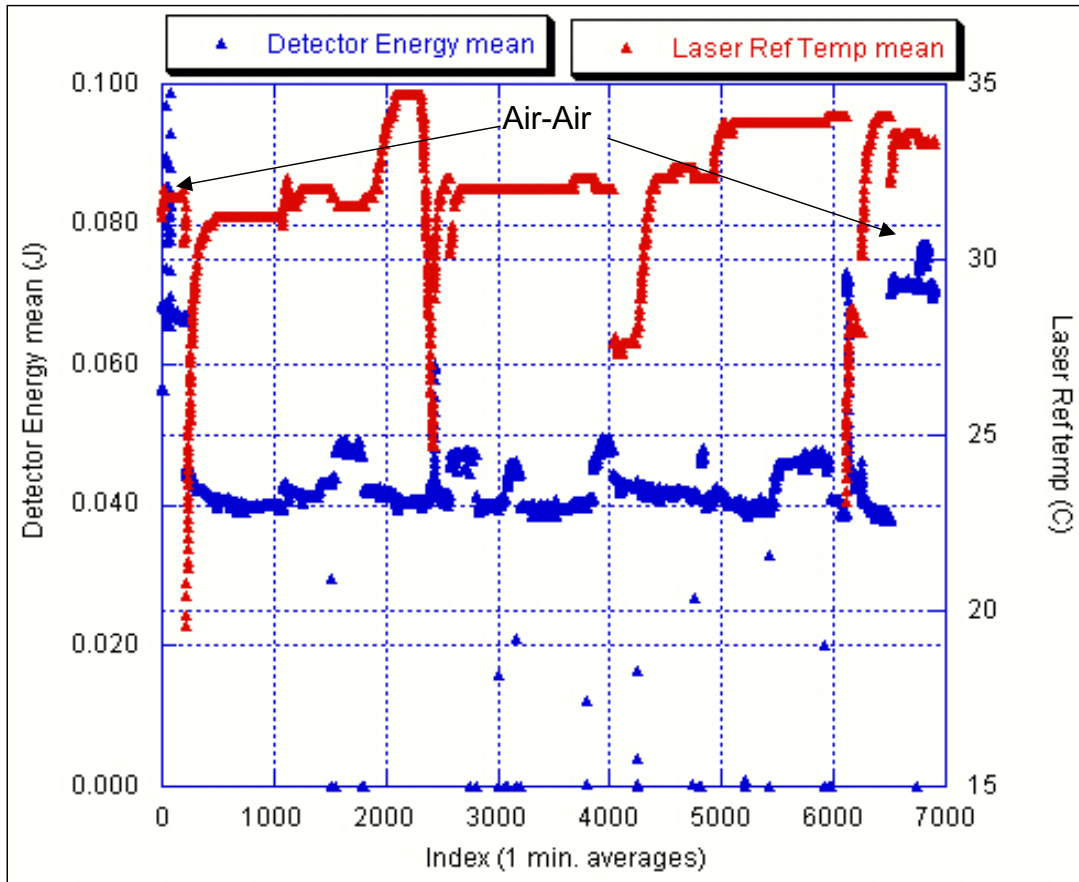

Laser 2

Laser 2 Detector and Moleclectron Relative Energies vs. Time (1 min averages)

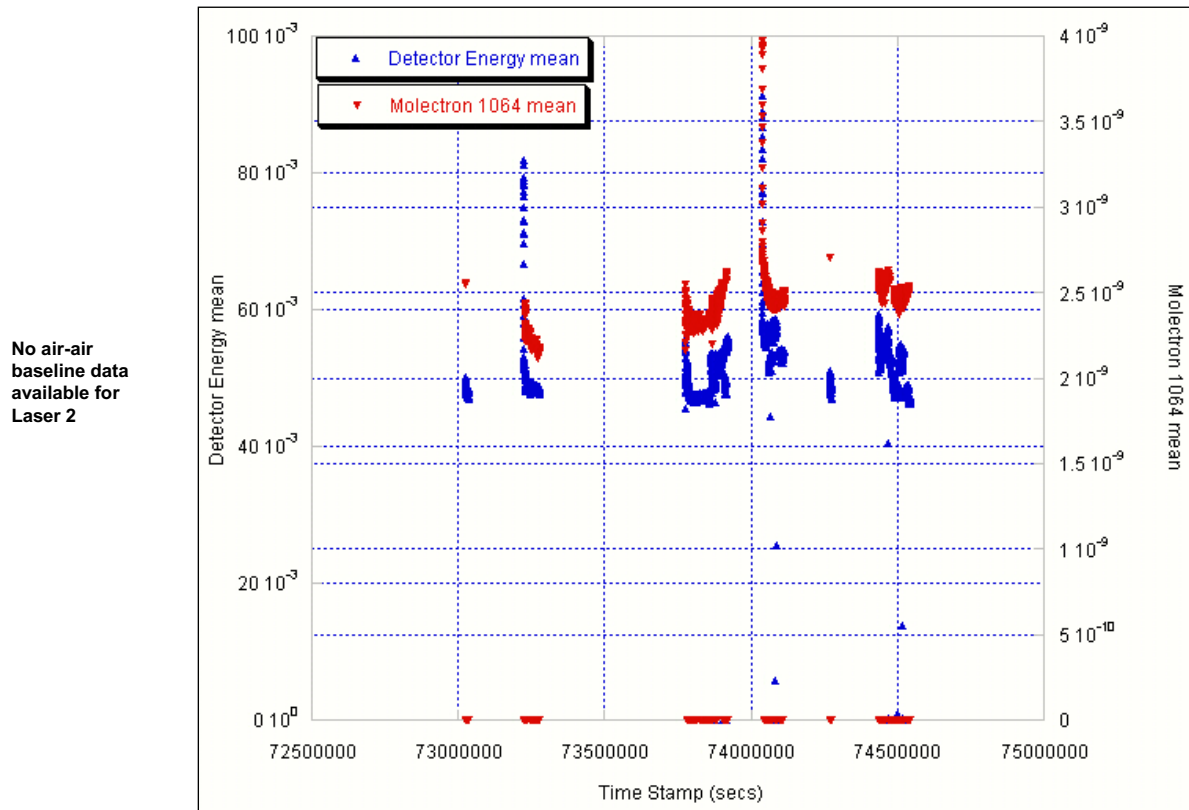

Laser 2 Energies (1 min averages) vs. Index

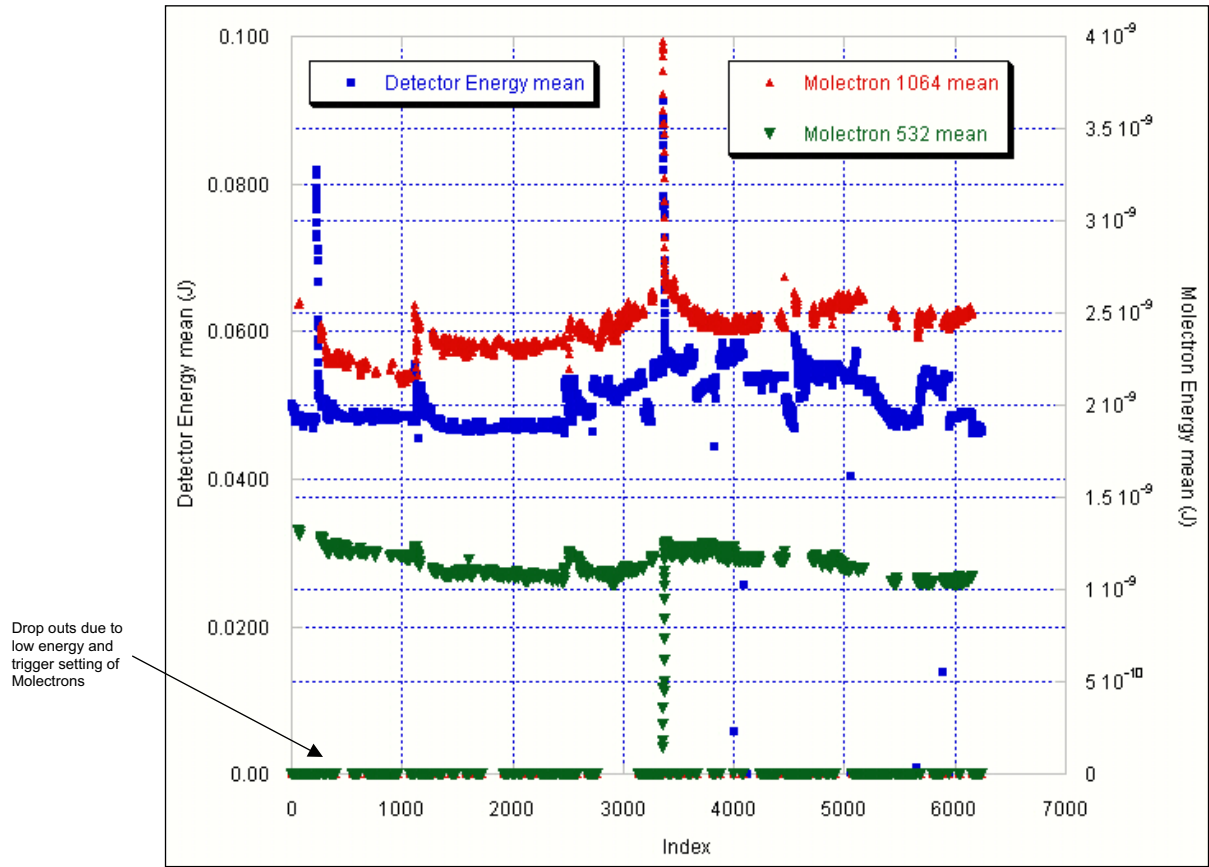

Laser 2 Temperatures (1 min averages) vs. Index

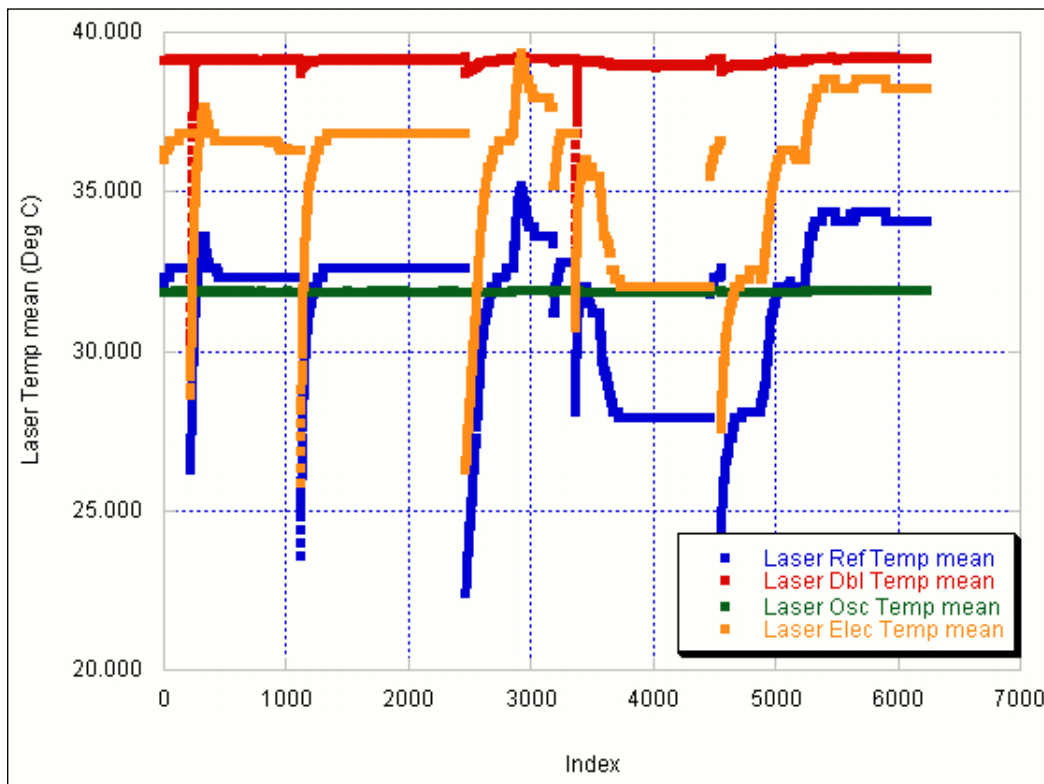

Laser 2 Drive Pulsewidth(1 min averages) vs. Index

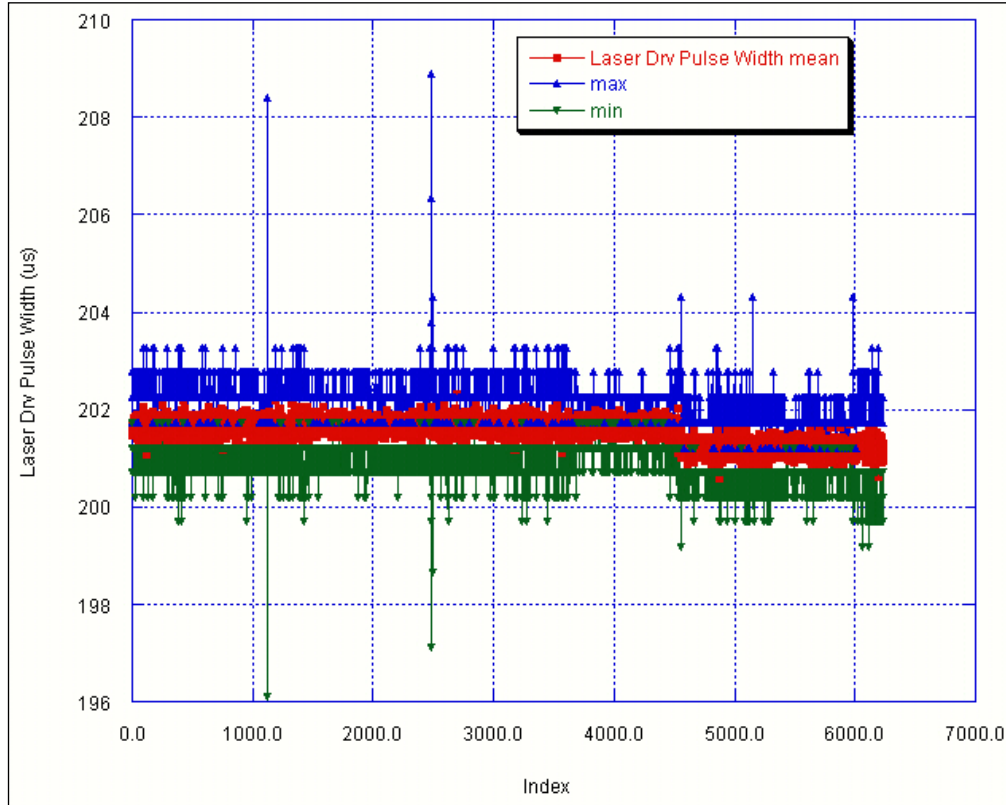

Laser 2 Drive Pulsewidth and Reference Temperature (1 min averages) vs. Time

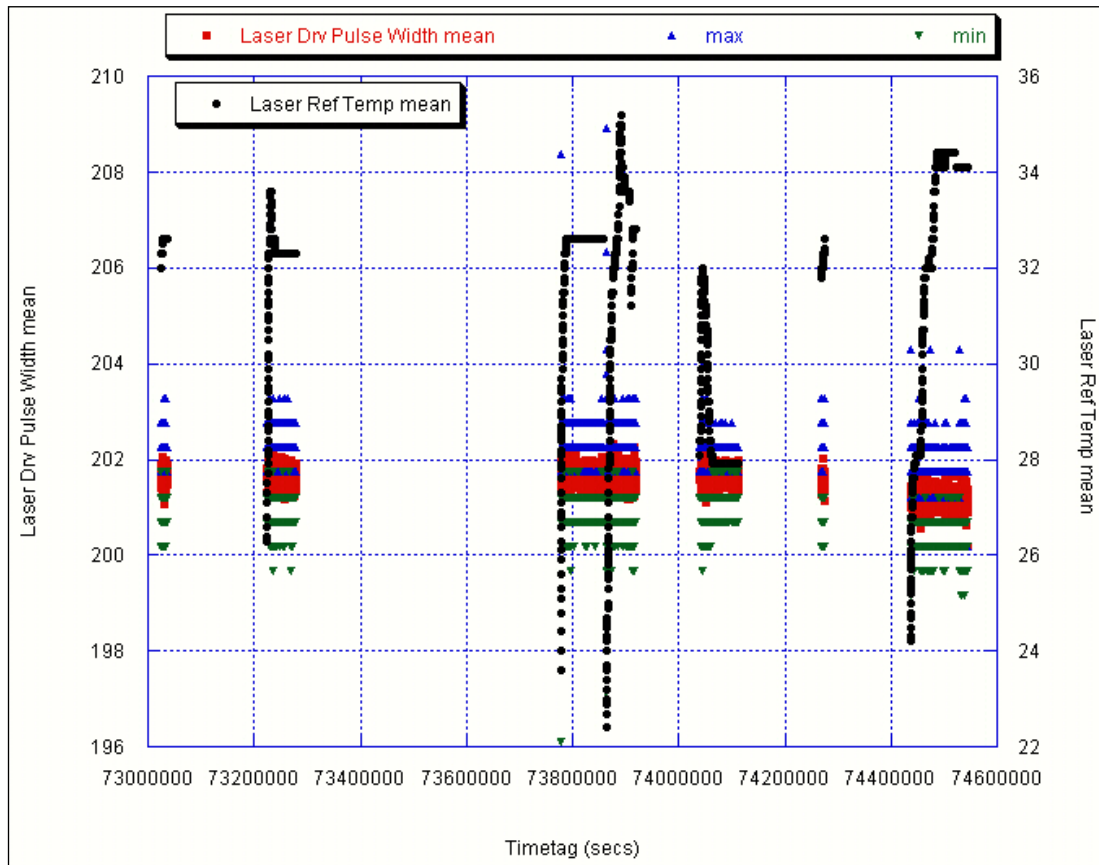

Laser 3

Laser 3 Detector and Molelectron Relative Energies vs. Time (1 min averages)

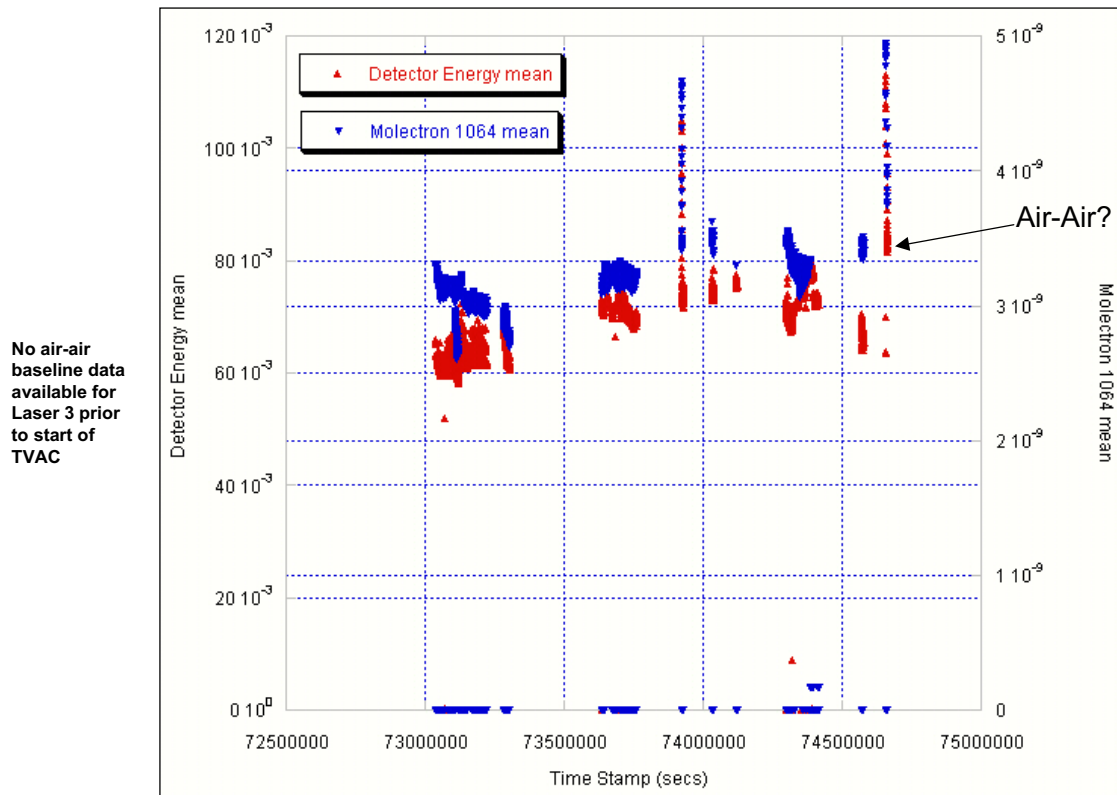

Laser 3 Energies (1 min averages) vs. Index

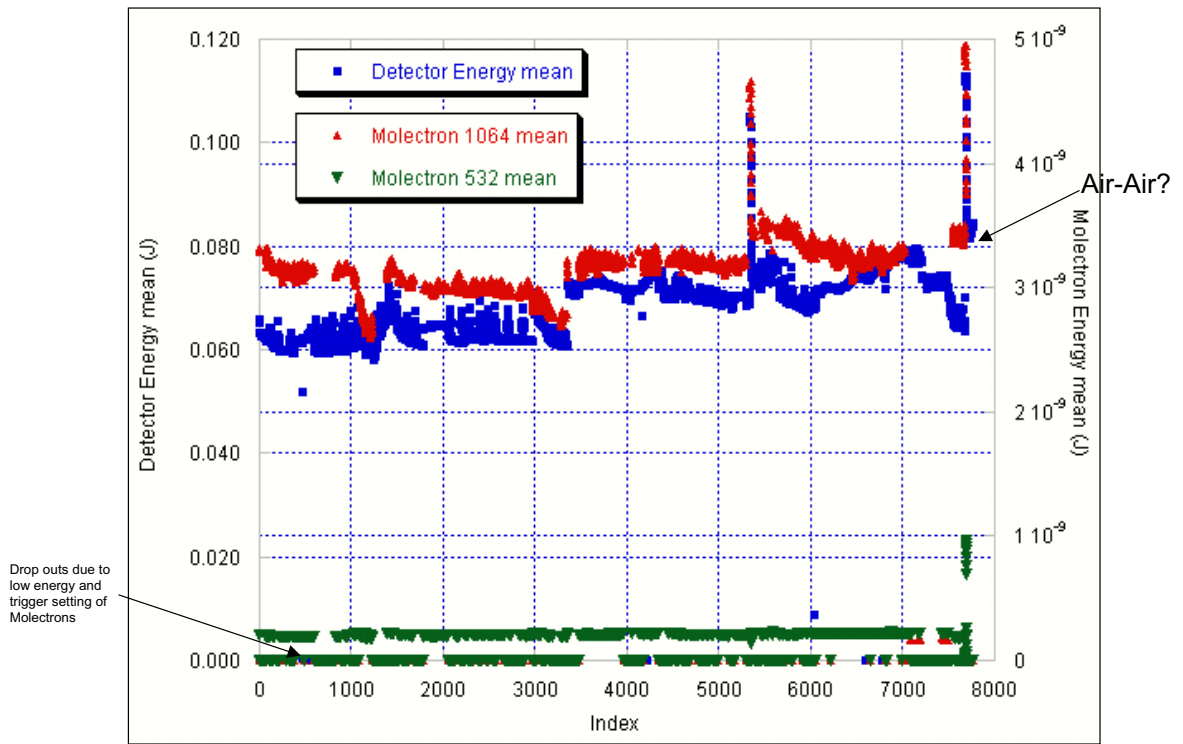

Laser 3 Temperatures (1 min averages) vs. Index

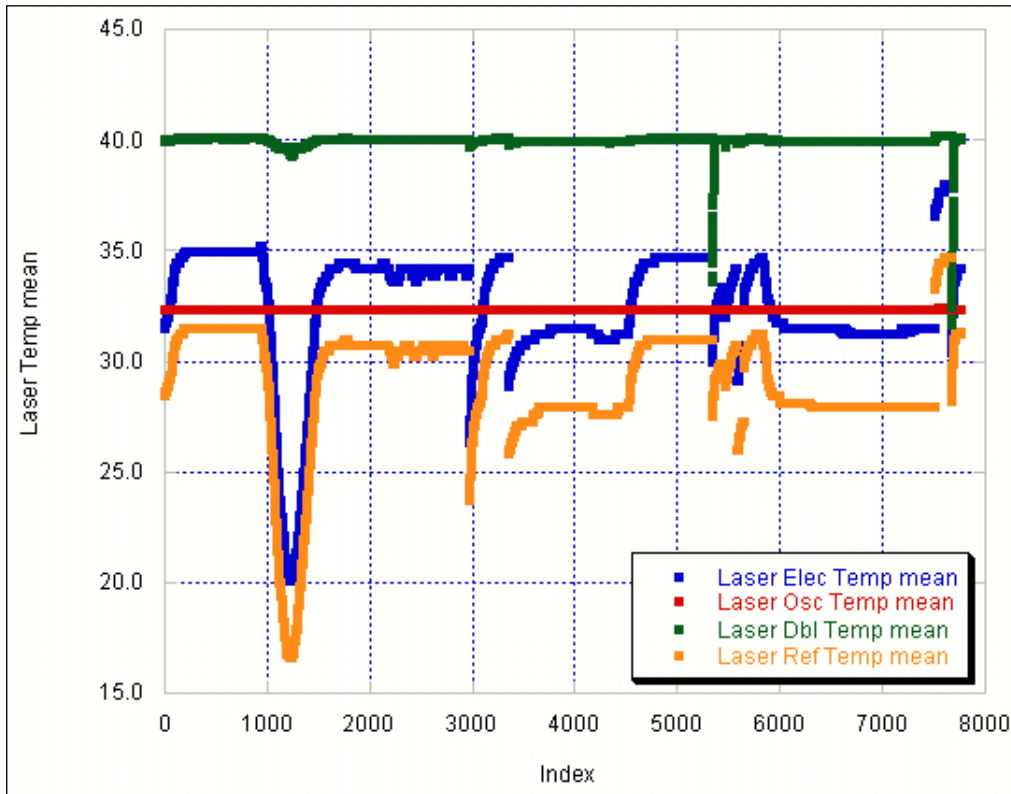

Laser 3 Drive Pulsewidth (1 min averages) vs. Index

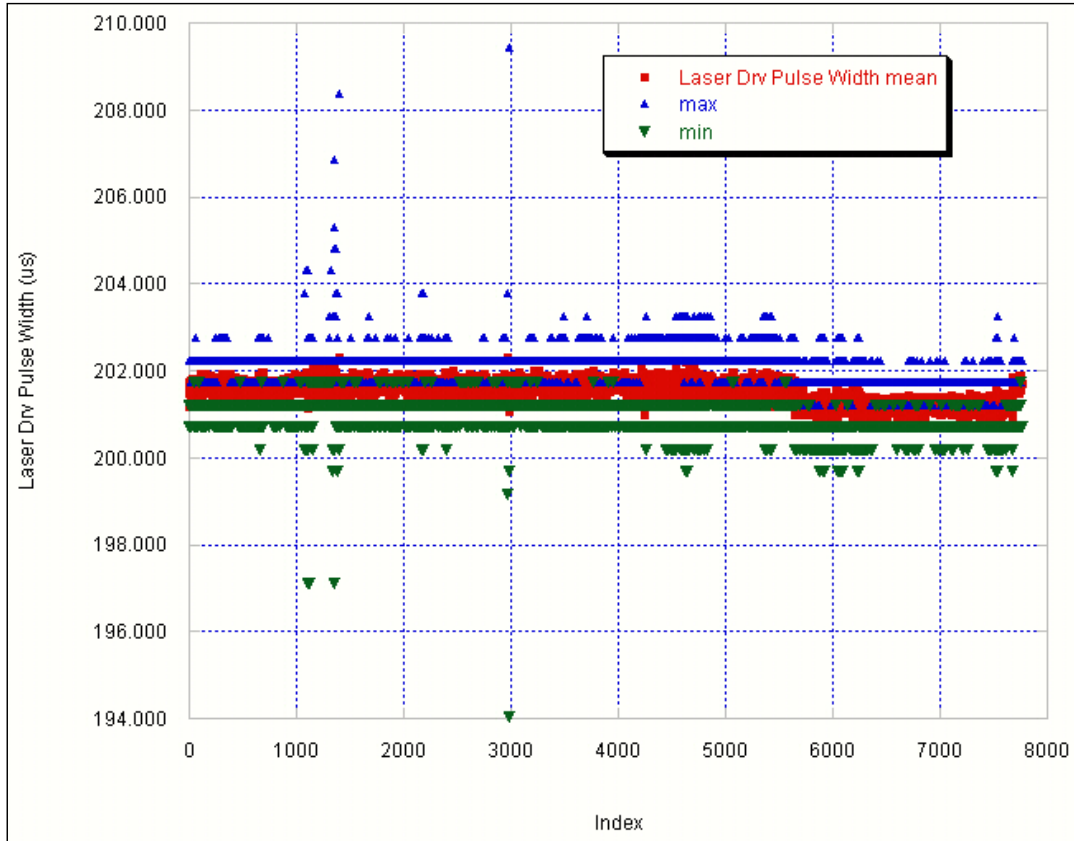

Laser 3 Drive Pulsewidth & Ref Temp (1 min averages) vs. Time

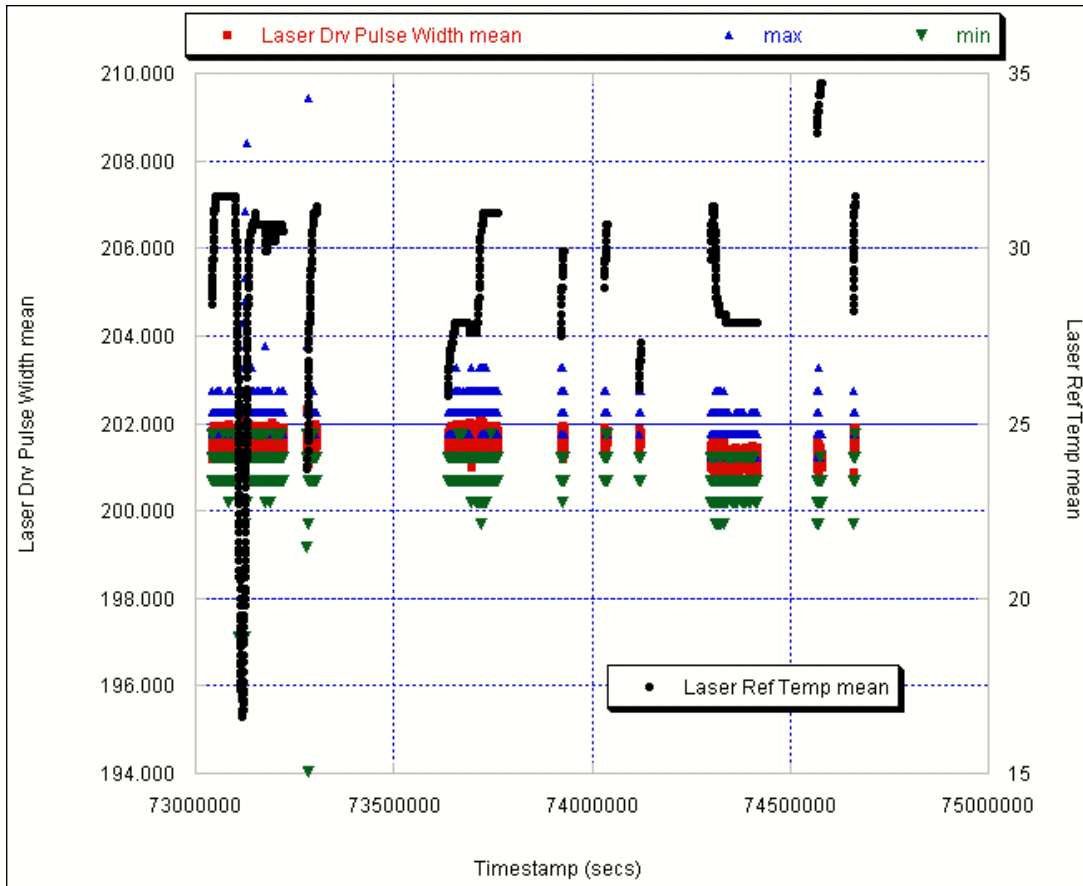

Relative Laser Energy Measurements
during instrument TVAC
Mini Target

All TVAC data are one minute averages

Relative Laser Energy Measurements during instrument TVAC with Mini Target

- The 1064 and 532 nm energy measurements from the Mini Target use two, low-energy detectors (Molelectron J3S-10) with a fiber pick off (see next slide).
- All Molelectron energies are *relative not absolute*
- Adjustments to the attenuation levels were made during the test (highlighted in plots)
- The altimeter detector energy values (1064 nm only) are derived using the same algorithm as in orbit
- Note that there will be a change in the altimeter detector energy when gain adjustments were made.

Relative Laser Energy Measurements during Instrument TVAC using Mini Target Beam Dump and BCE Laser Test System (LsrTS)

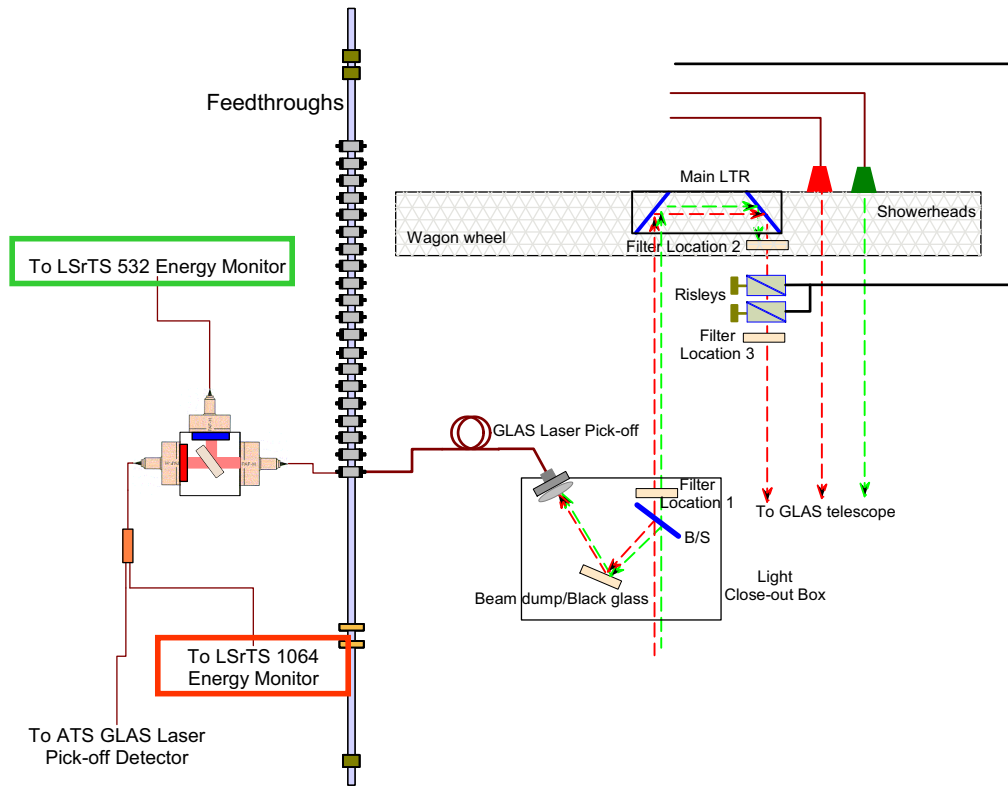

Laser 1

Laser 1 Detector and Molectron Relative Energies vs. Time

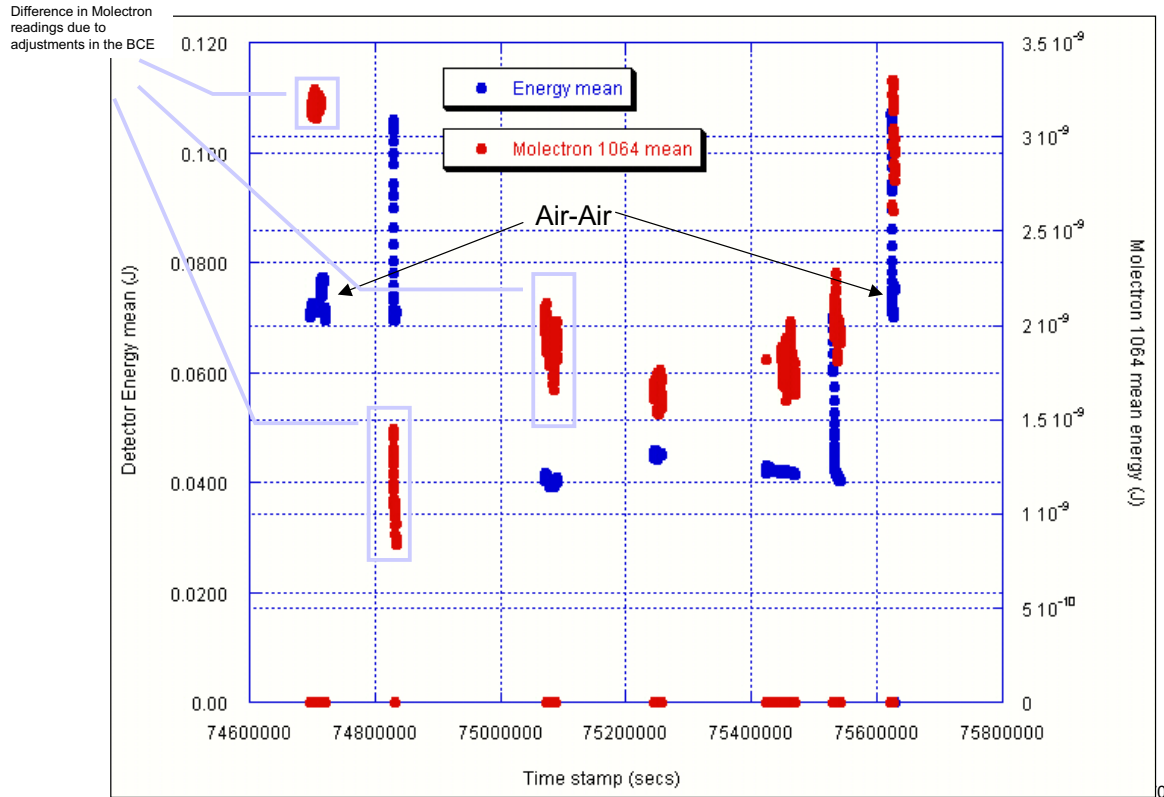

Laser 1 Energies vs. Index (1 min averages)

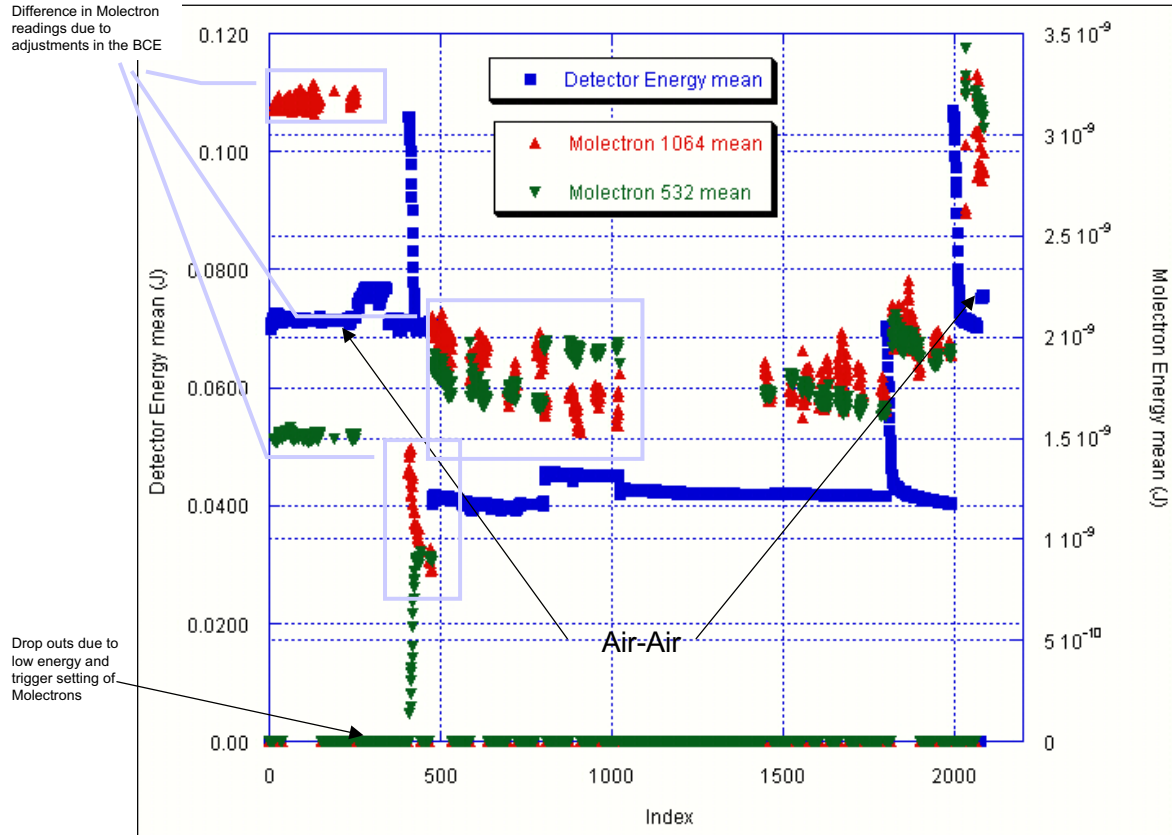

7

Laser 1 Energy and Gain (1 min averages) vs. Index

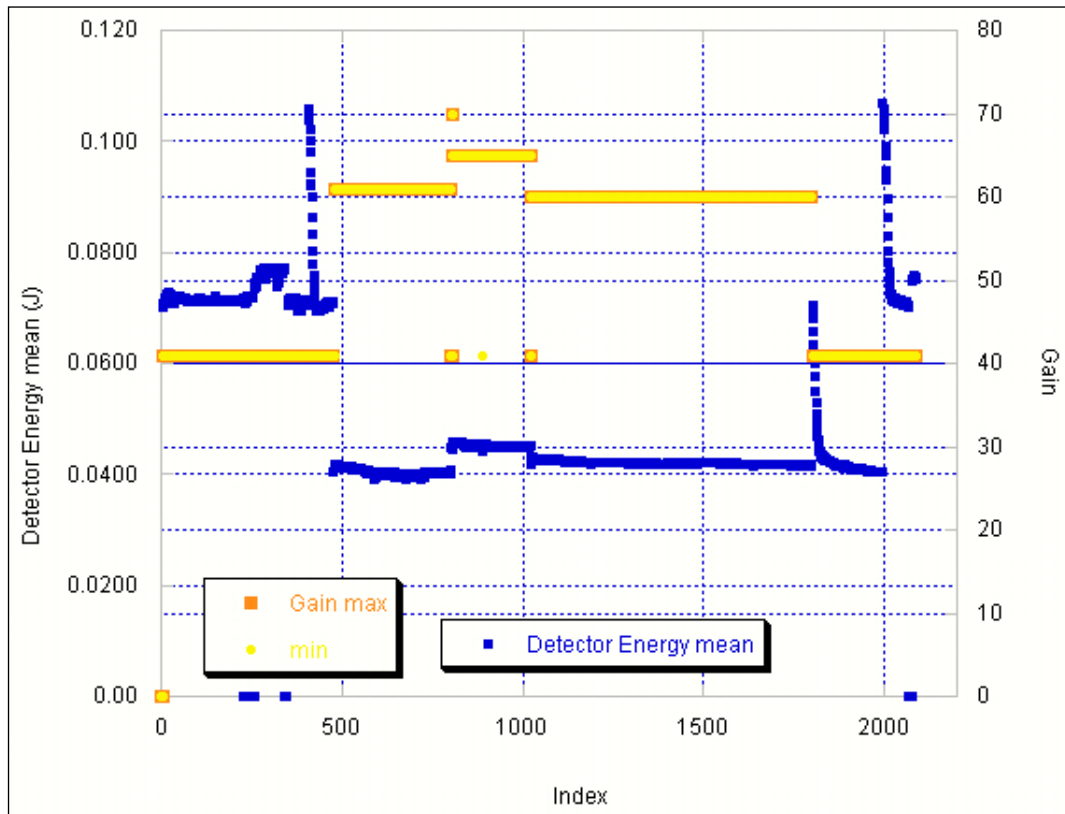

Laser 1 Energy and Ref. Temp. (1 min averages) vs. Index

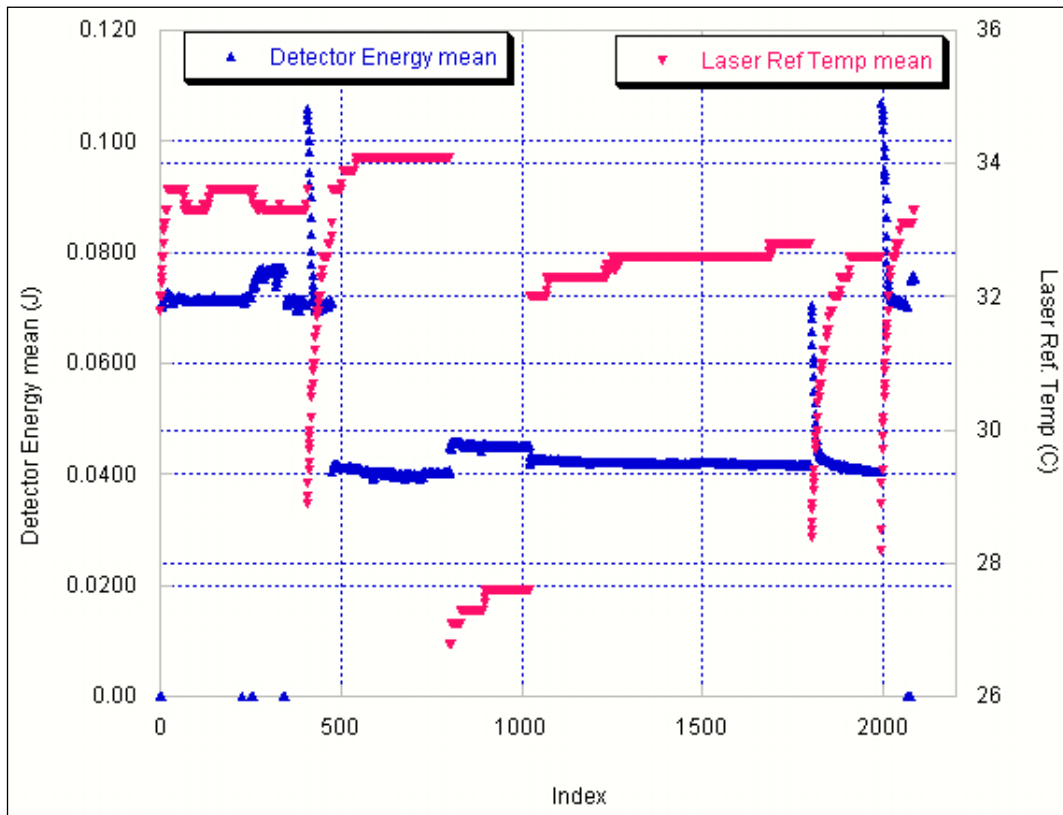

Laser 1 Osc. & Amp. Current (1 min averages) vs. Index

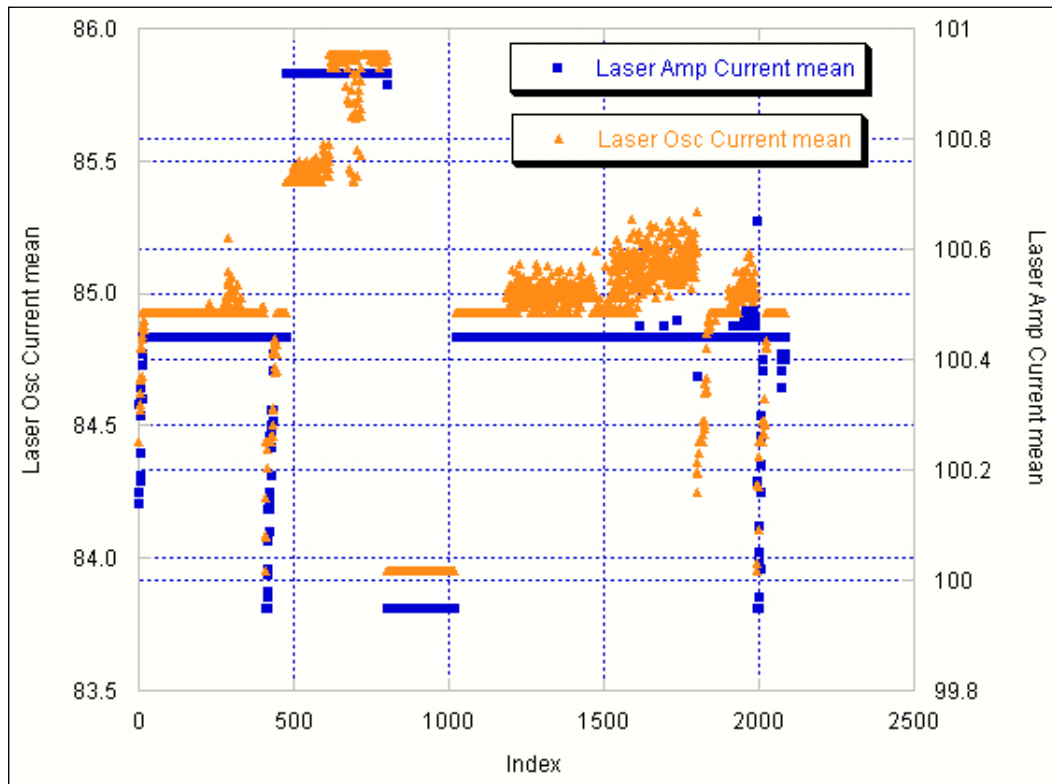

Laser 1 Temperatures vs. Index (1 min averages)

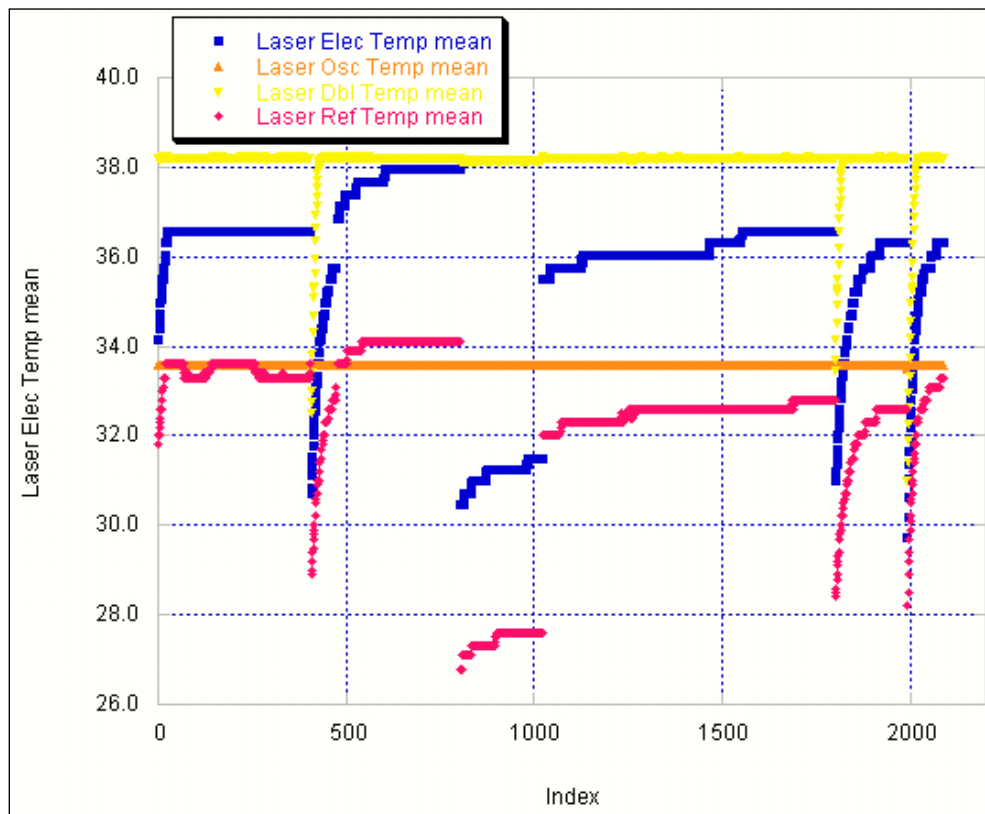

Laser 1 Energy and Drive Pulsewidth (1 min averages) vs. Index

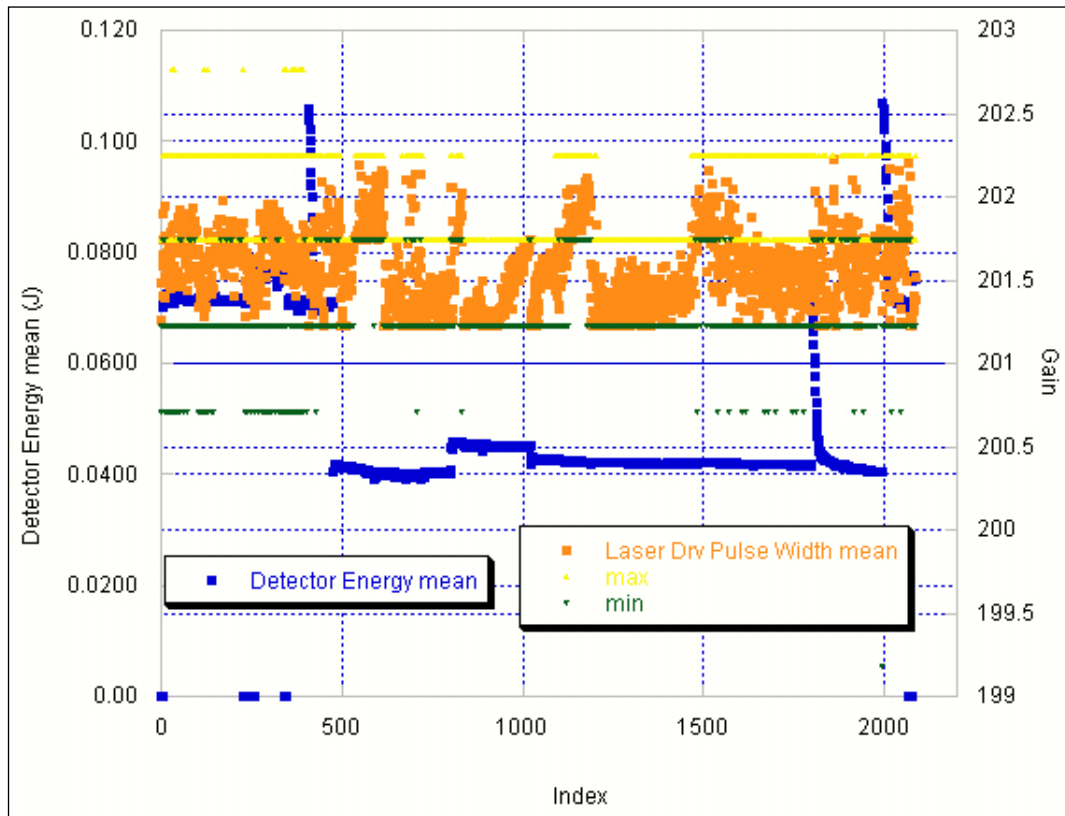

Laser 1 Reference Temperature and Drive Pulsewidth (1 min averages) vs. Index

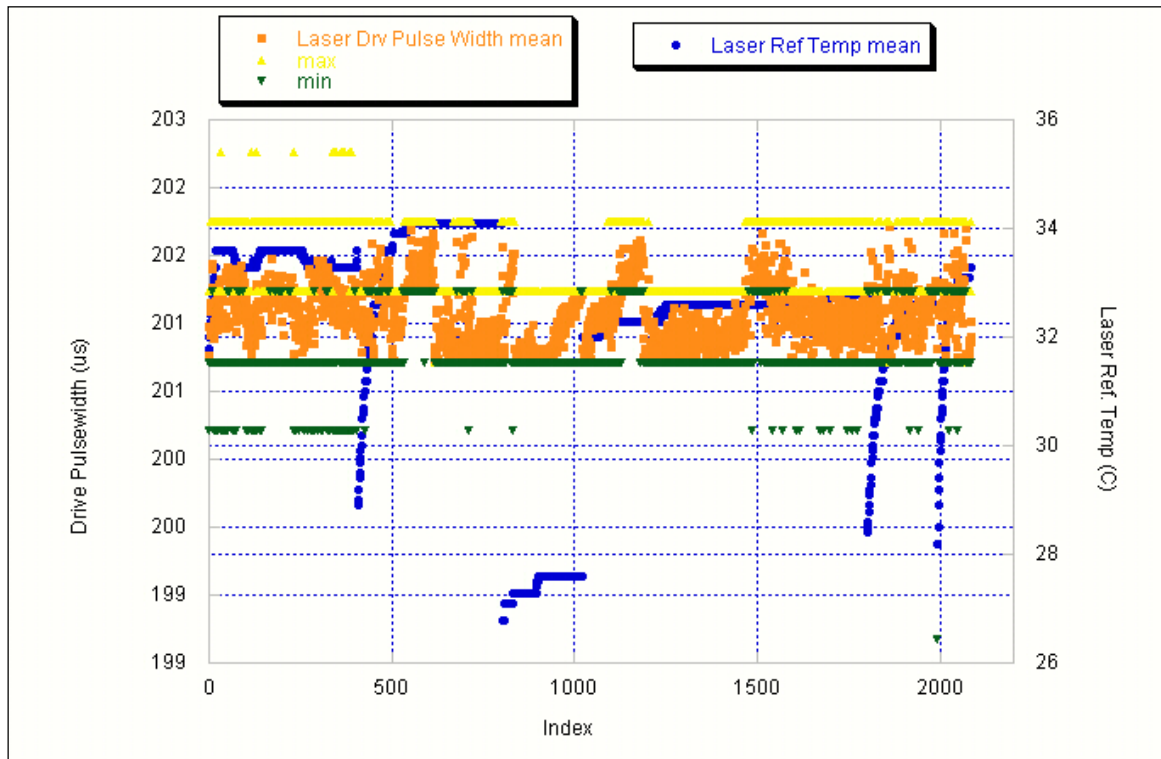

77

Laser 1 Reference Temperature and Drive Pulsewidth (1 min averages) vs. Time

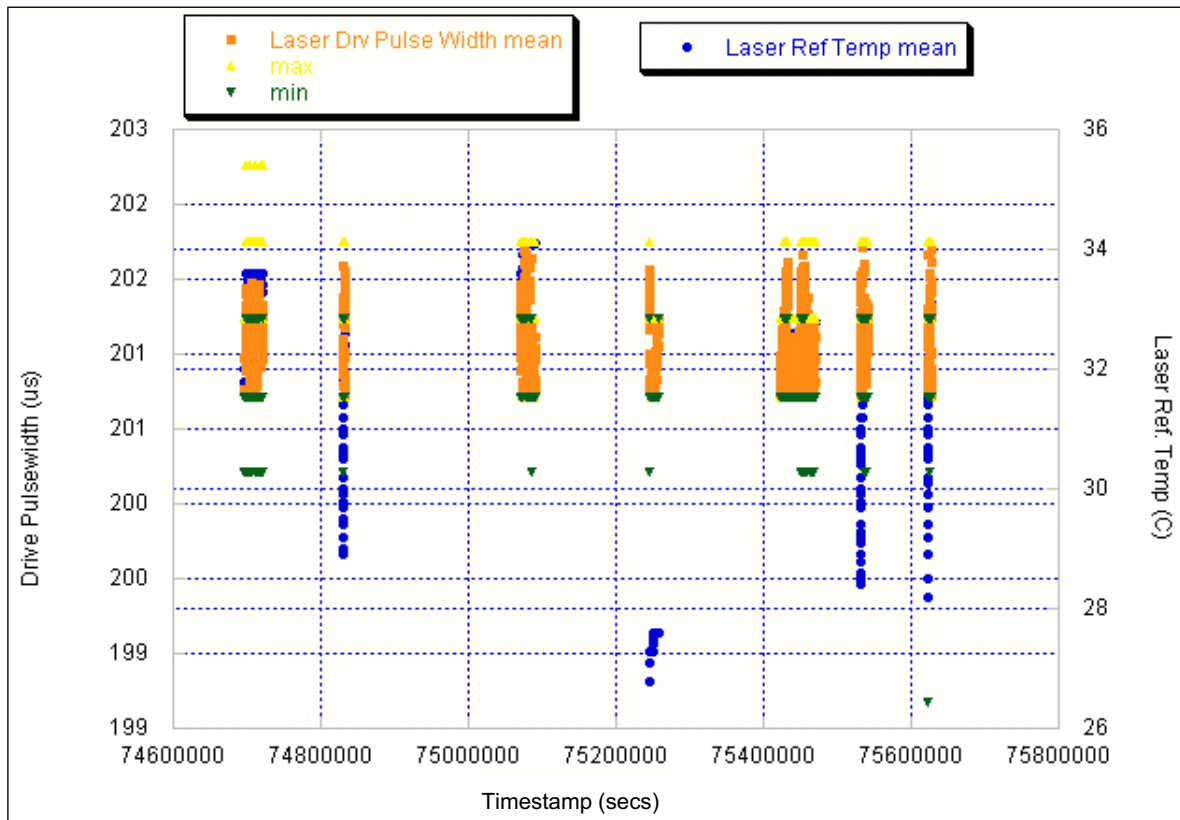

Laser 1 Drive Pulsewidth (1 min averages) vs. Index

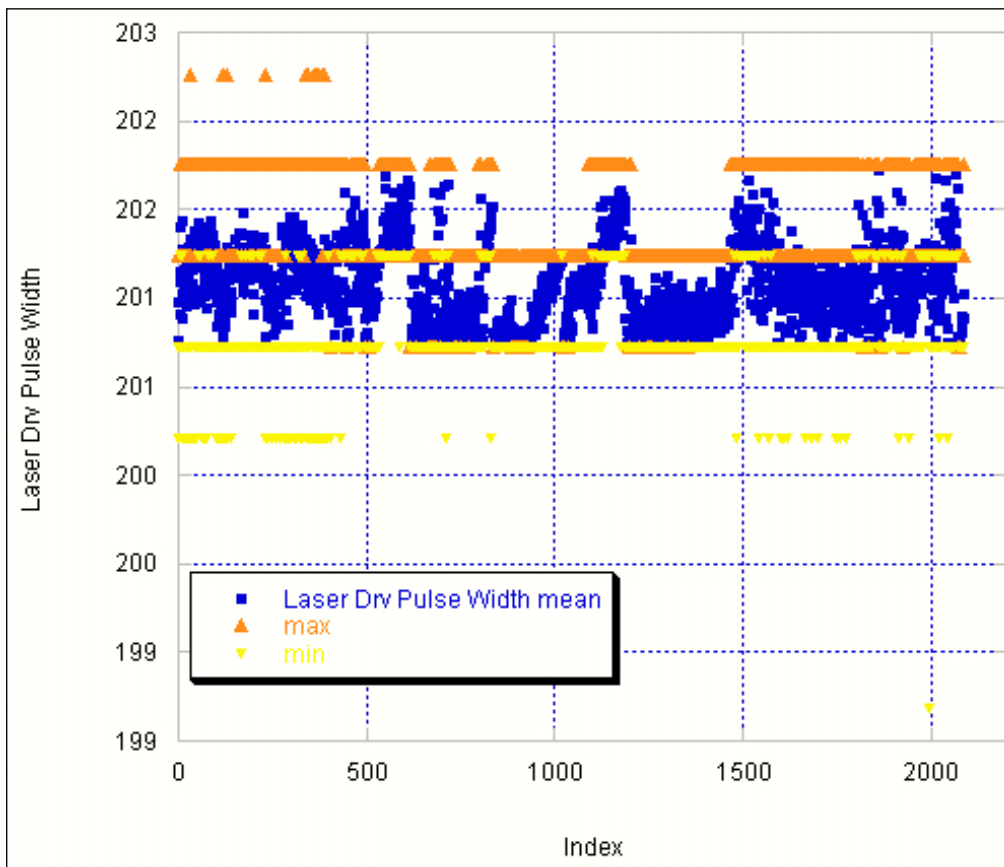

Laser 2

Laser 2 Detector and Moleclectron Relative Energies vs. Time (1 min averages)

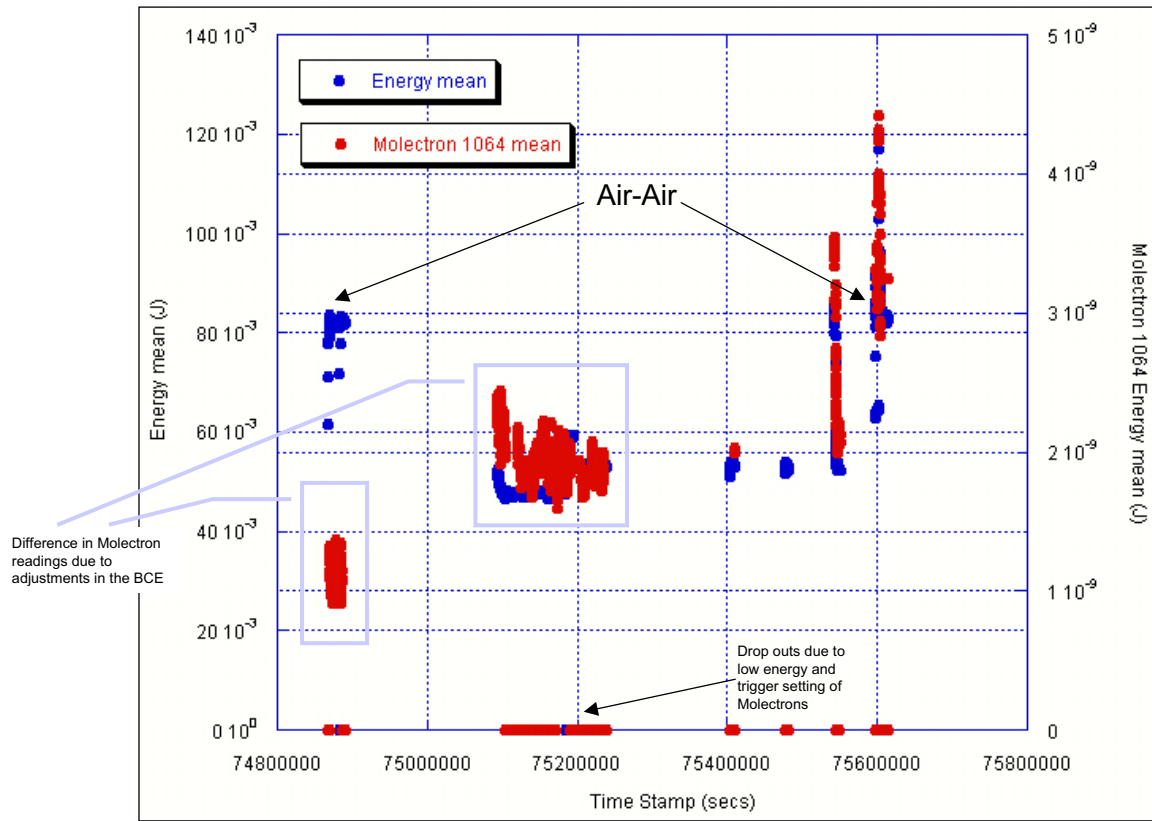

Laser 2 Energies vs. Index (1 min averages)

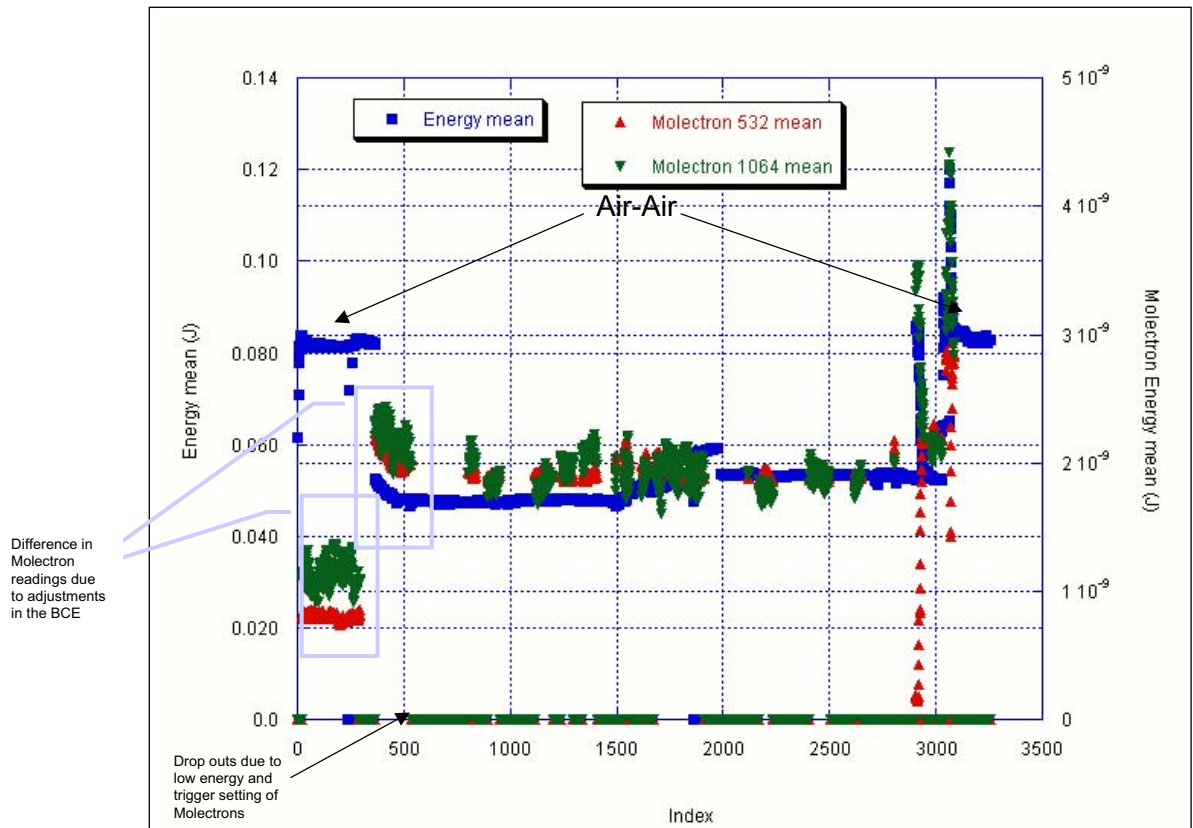

Laser 2 Reference Temperature and Drive Pulsewidth (1 min averages) vs. Index

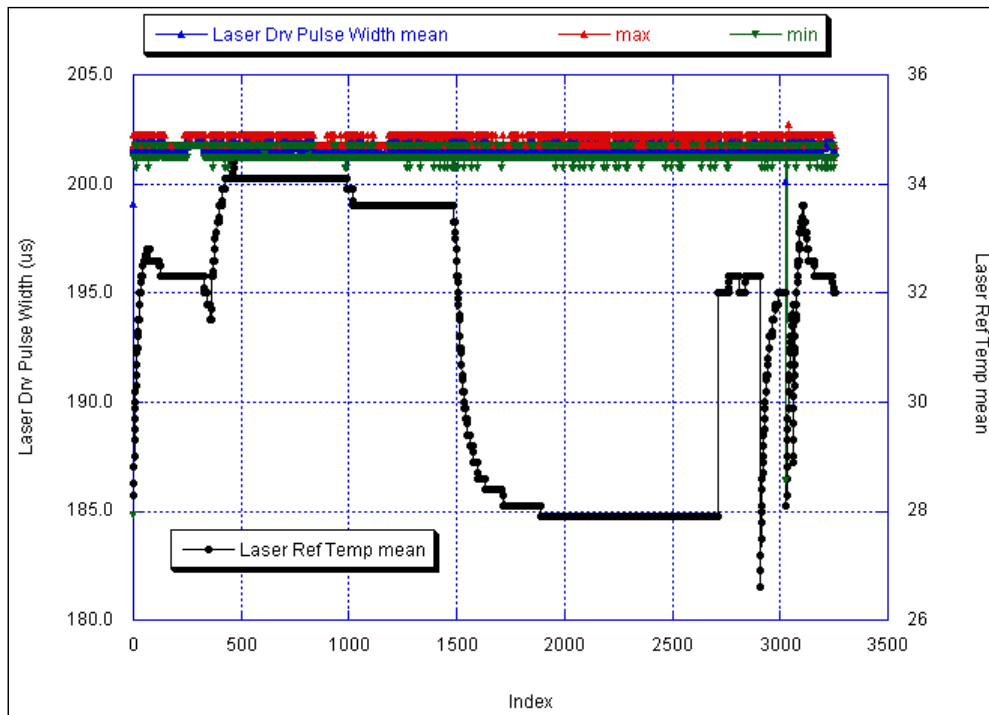

Laser 2 Reference Temperature and Drive Pulsewidth (1 min averages) vs. Time

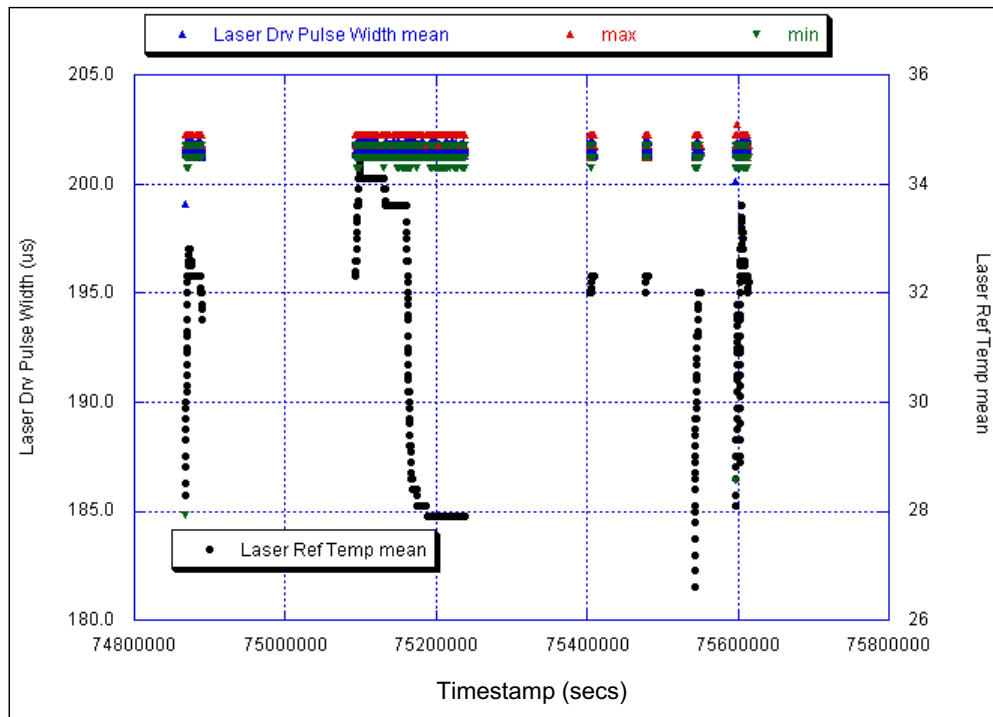

Laser 3

Laser 3 Detector and Molecron Relative Energies vs. Time (1 min averages)

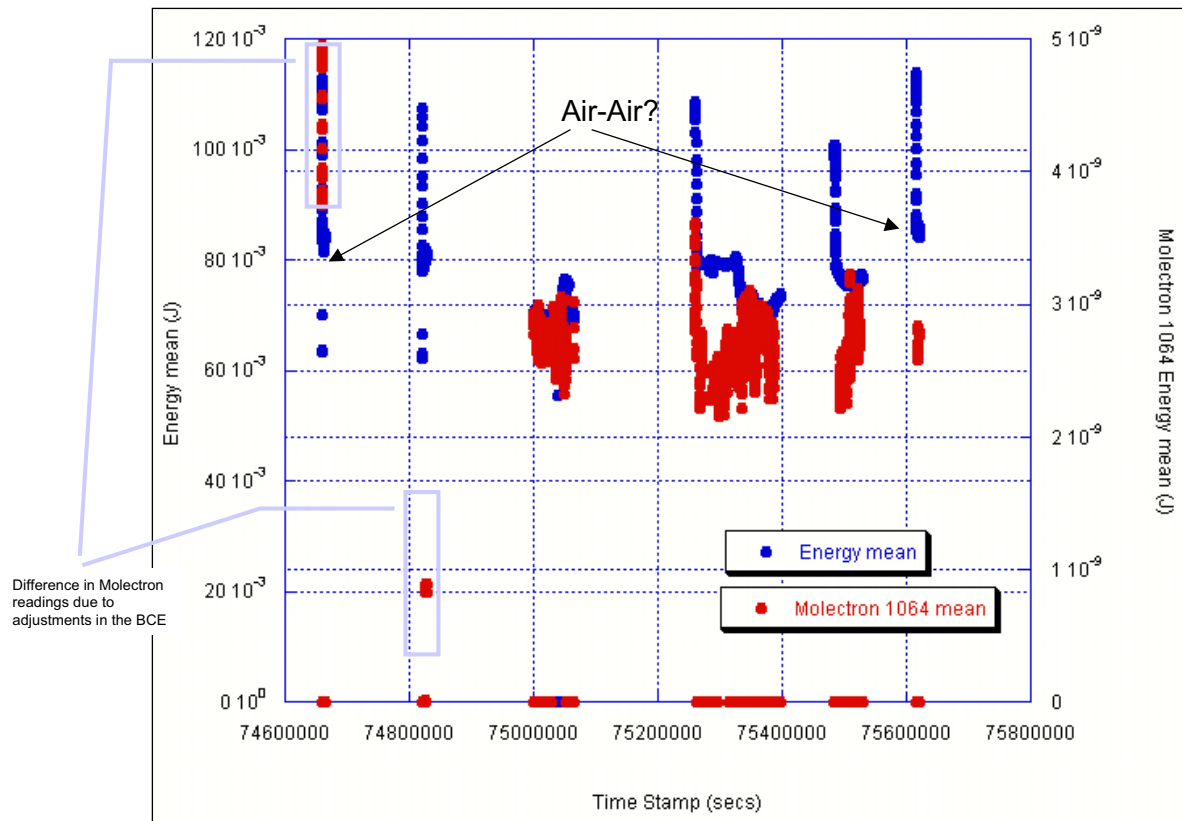

Laser 3 Energies vs. Index (1 min averages)

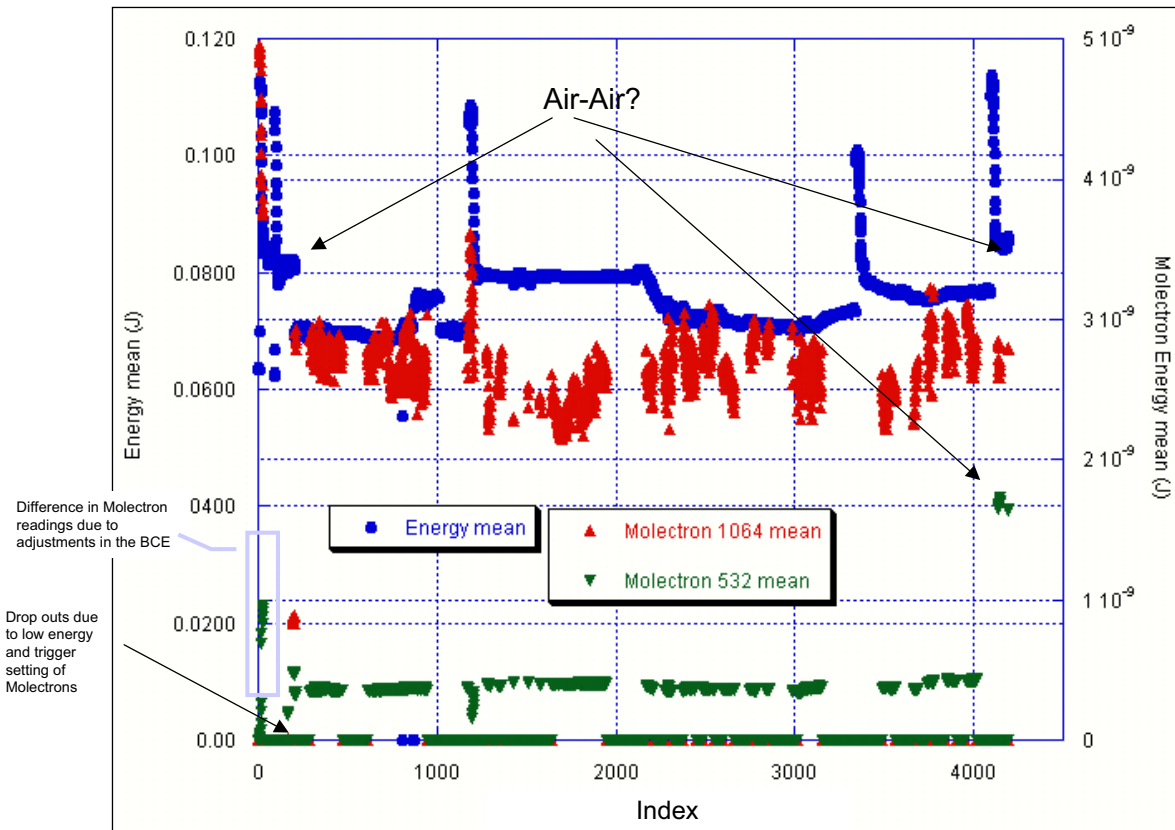

Laser 3 Reference Temperature and Drive Pulsewidth (1 min averages) vs. Index

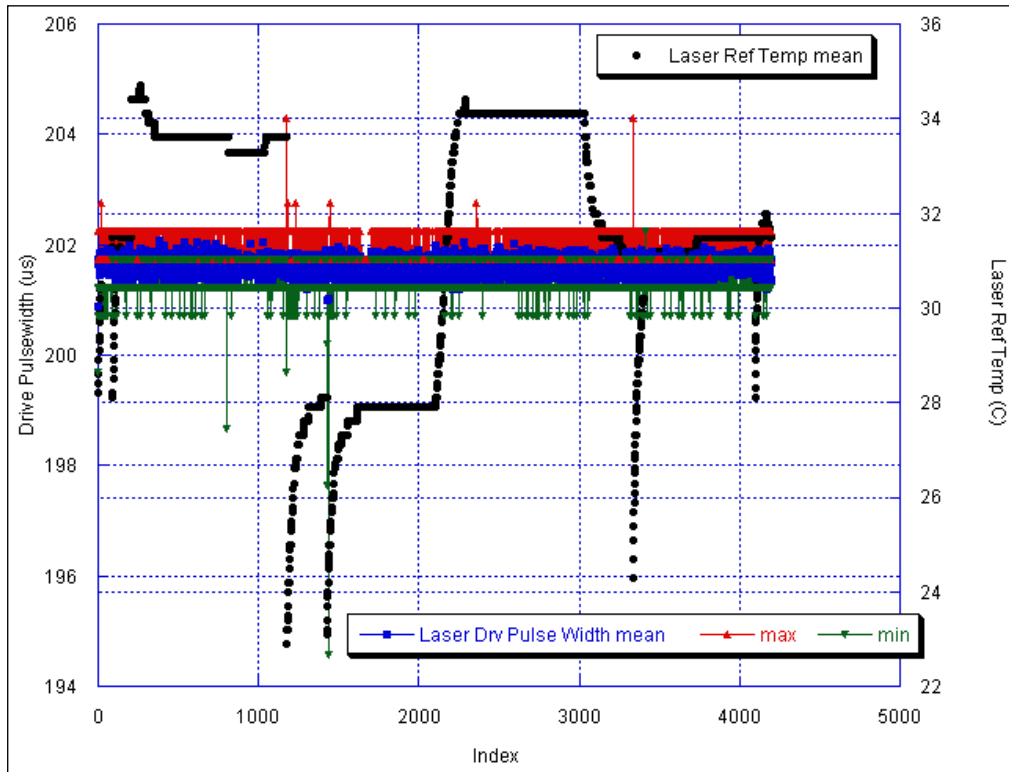

Laser 3 Reference Temperature and Drive Pulsewidth (1 min averages) vs. Time

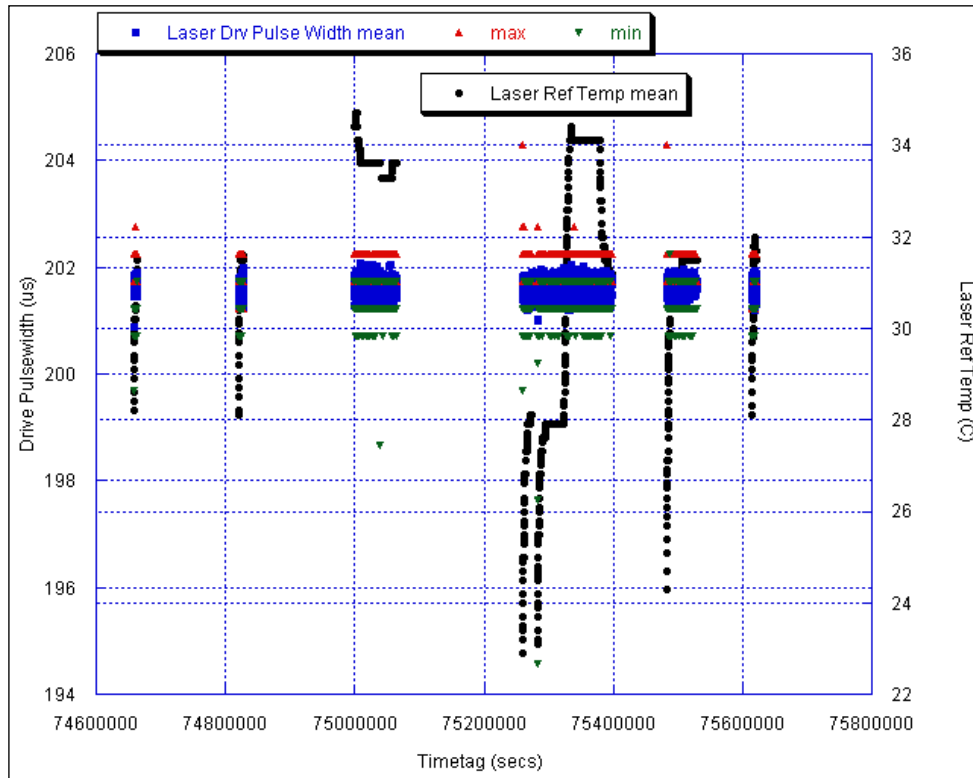

Relative Laser Energy Measurements during observatory TVAC

All TVAC data are one minute averages

Relative Laser Energy Measurements during observatory TVAC

The 1064 and 532 nm energy measurements from the Mini Target use two, low-energy detectors (Molelectron J3S-10) with fiber pick offs on an integrating sphere (see next slide).

All Molelectron energies are *relative not absolute*

Adjustments to the attenuation levels were made during the test (highlighted in plots)

The altimeter detector energy values (1064 nm only) are derived using the same algorithm as in orbit

Note that there will be a change in the altimeter detector energy when gain adjustments were made.

Relative Laser Energy Measurements during Observatory TVAC using Mini Target Beam Dump and BCE Laser Test System (LsrTS)

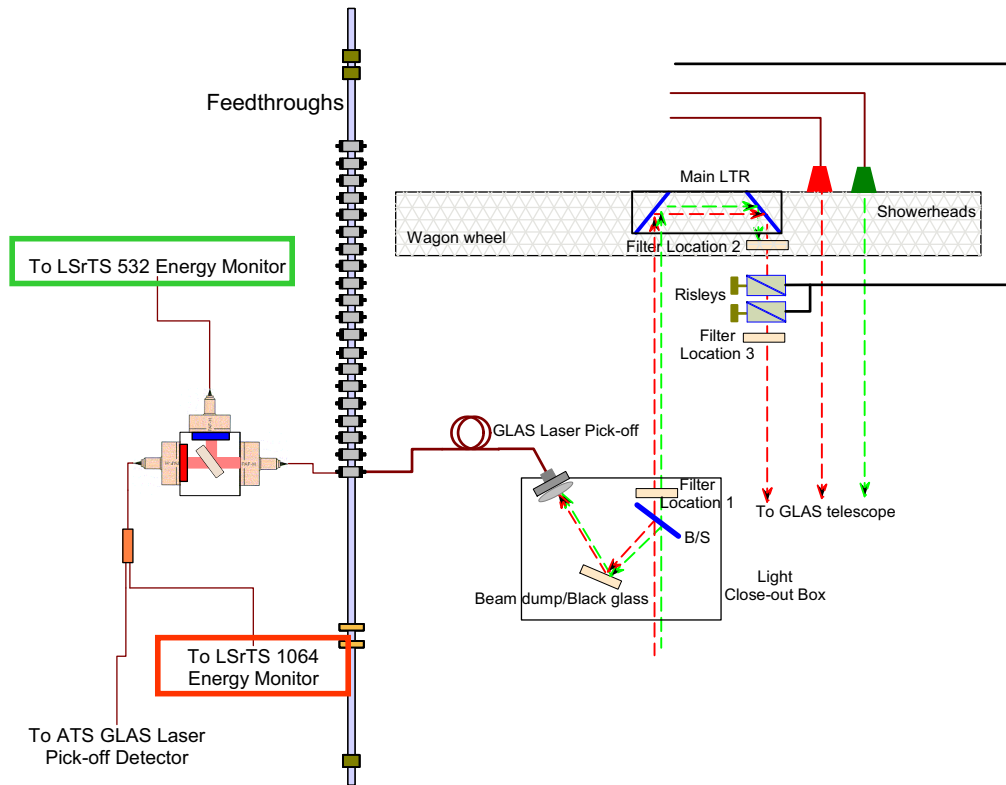

Laser 1

Laser 1 Detector and Molectron Relative Energies vs. Time

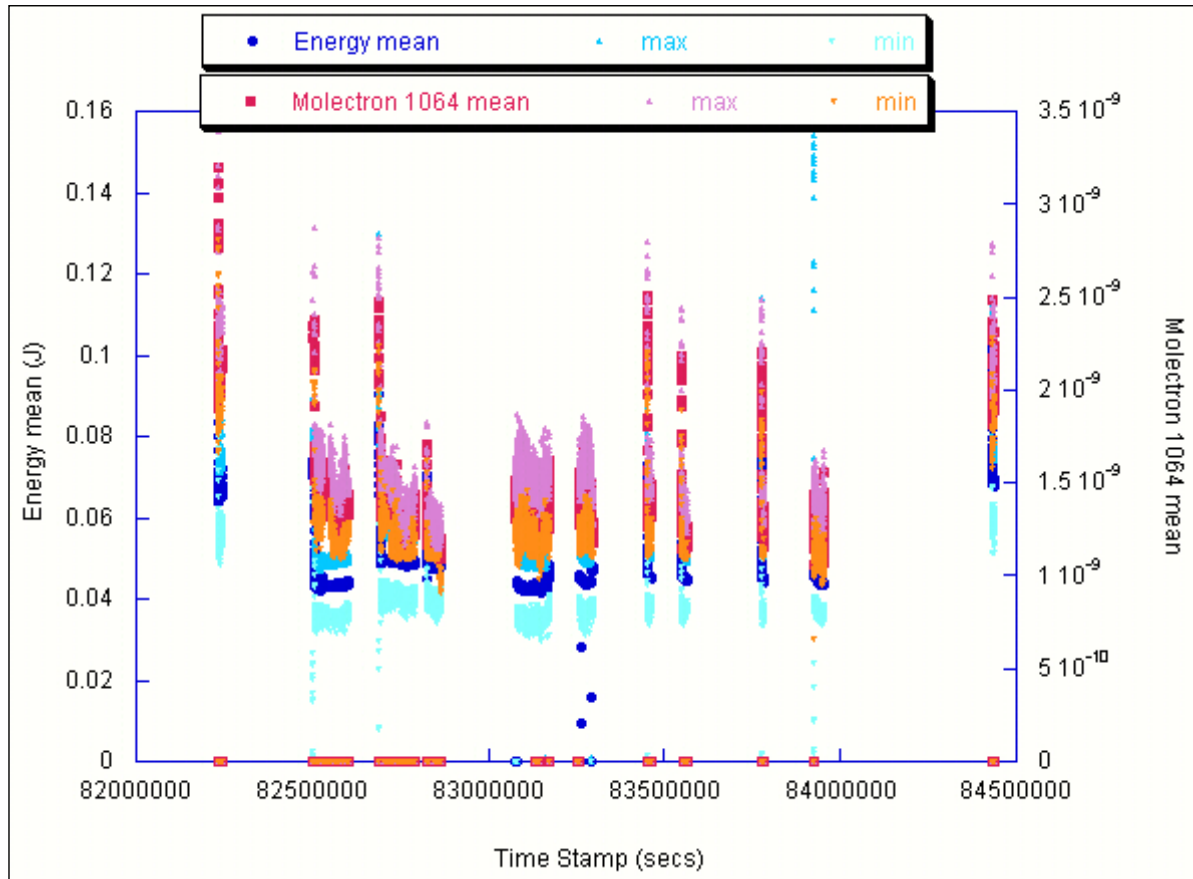

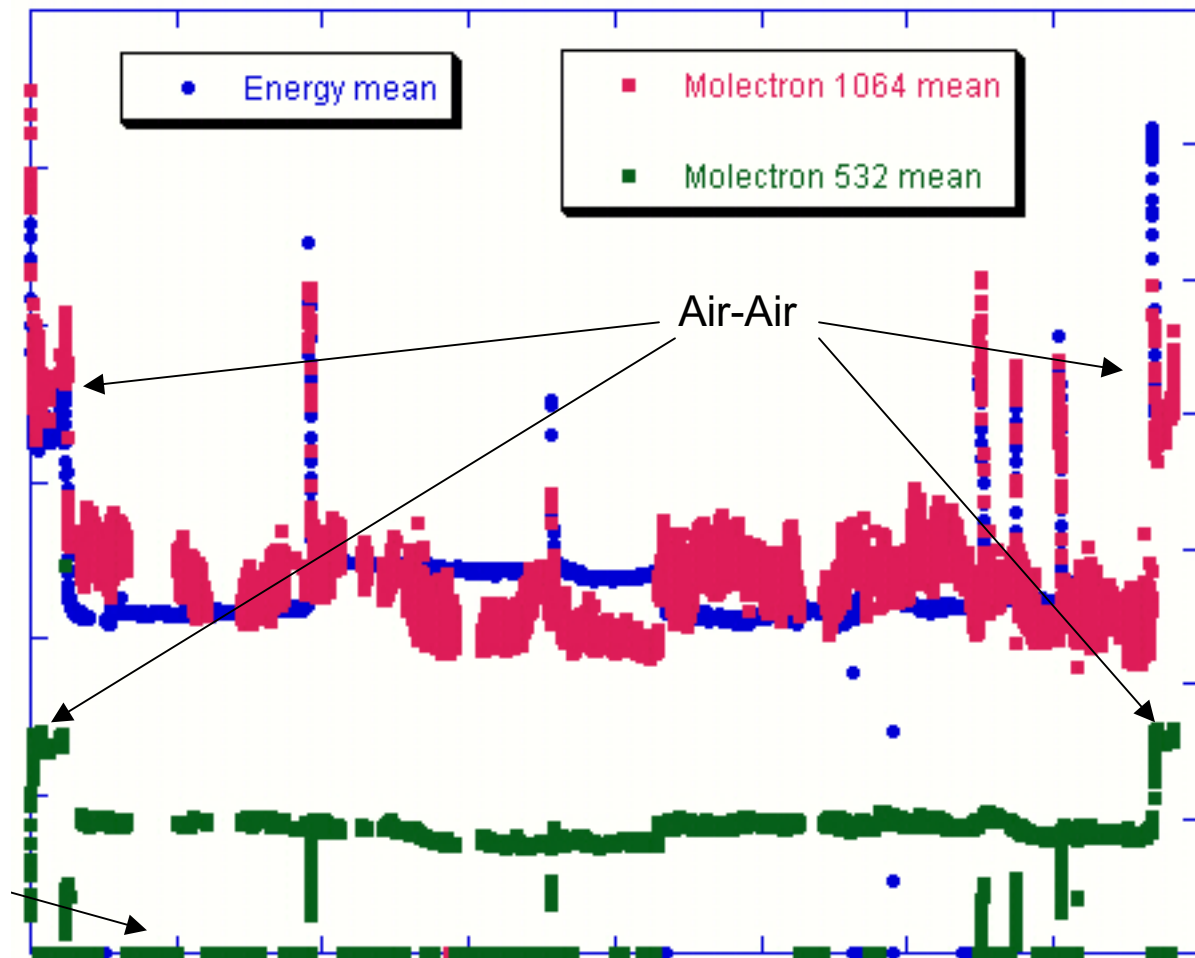

Laser 1 Energy and Gain (1 min averages) vs. Index

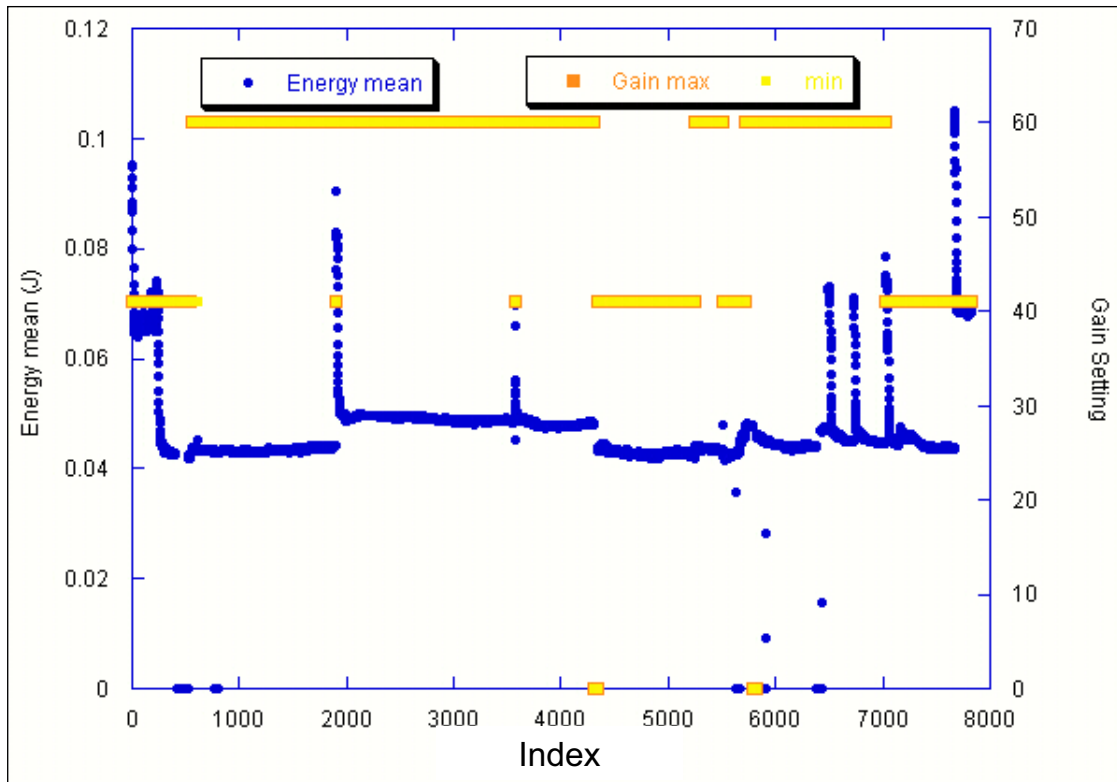

Laser 1 Energy and Ref. Temp. (1 min averages) vs. Index

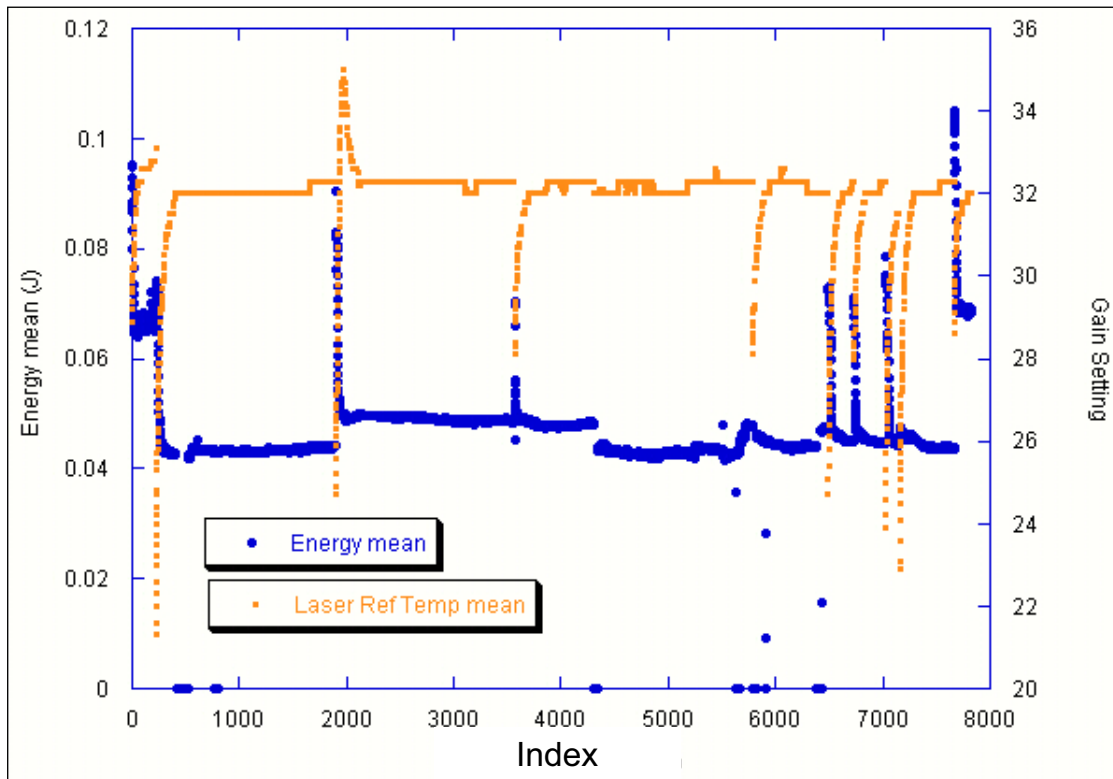

Laser 1 Osc. & Amp. Current (1 min averages) vs. Index

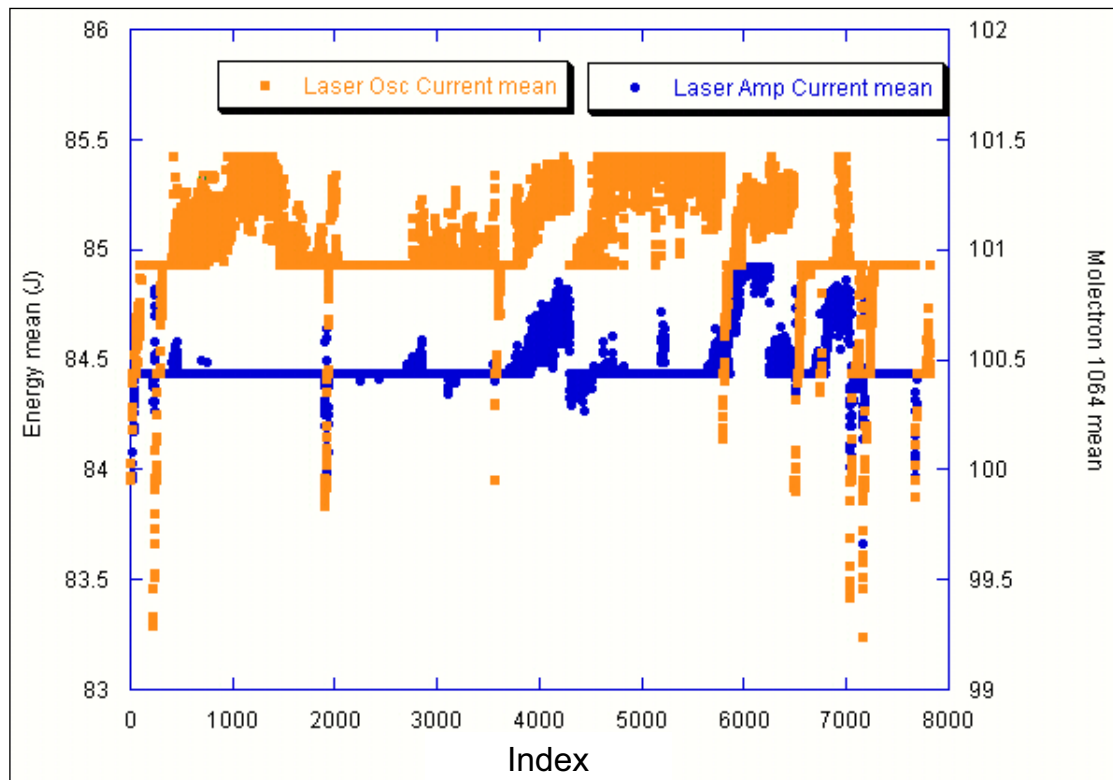

Laser 1 Temperatures vs. Index (1 min averages)

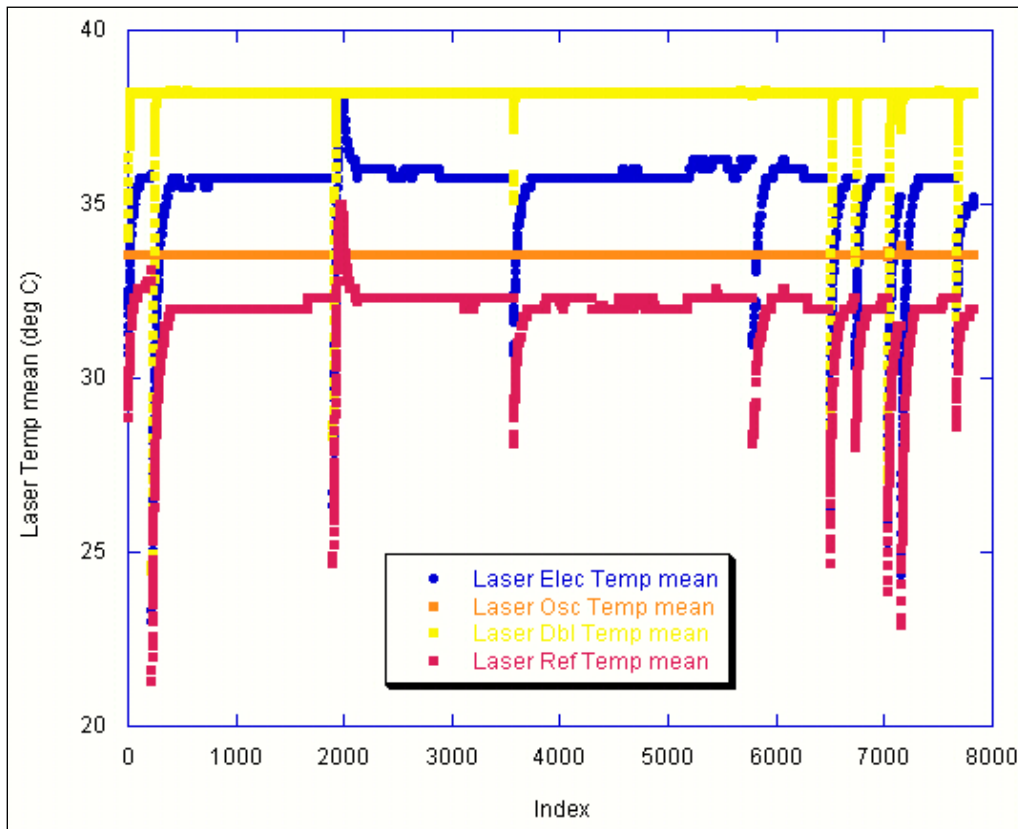

Laser 1 Drive Pulsewidth (1 min averages) vs. Index

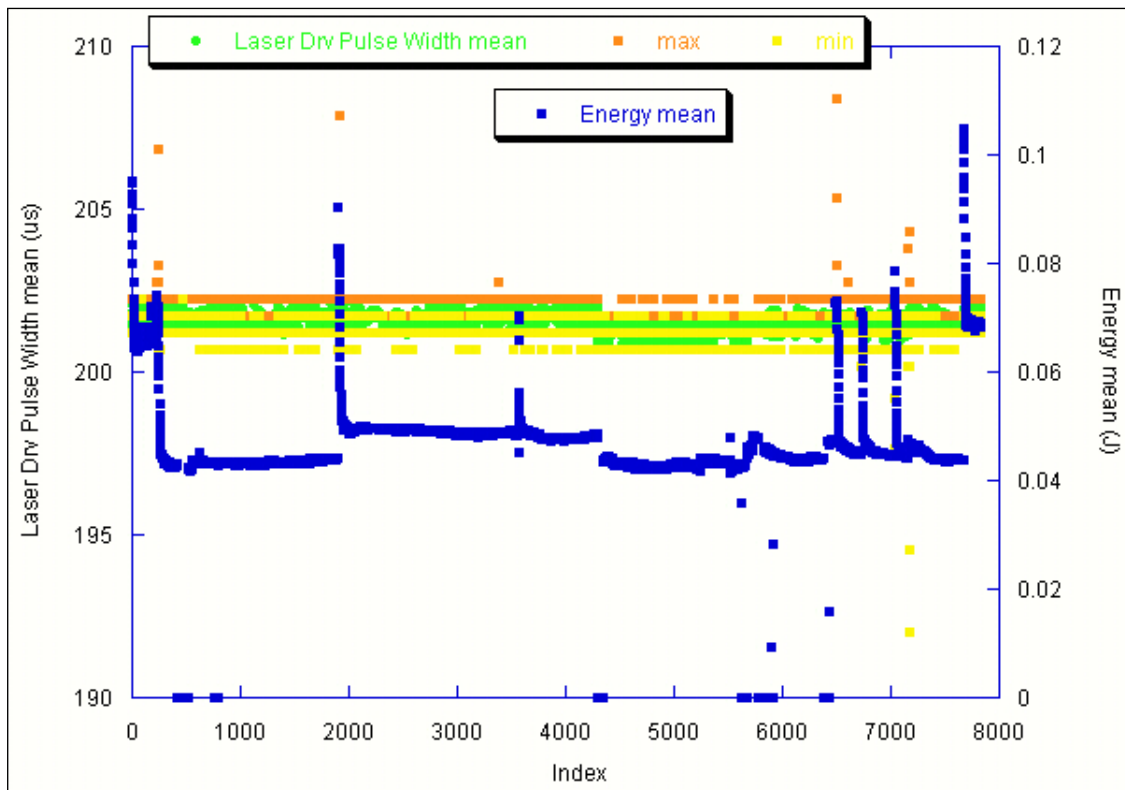

10

Laser 1 Drive Pulsewidth (1 min averages) and Reference Temperature vs. Index

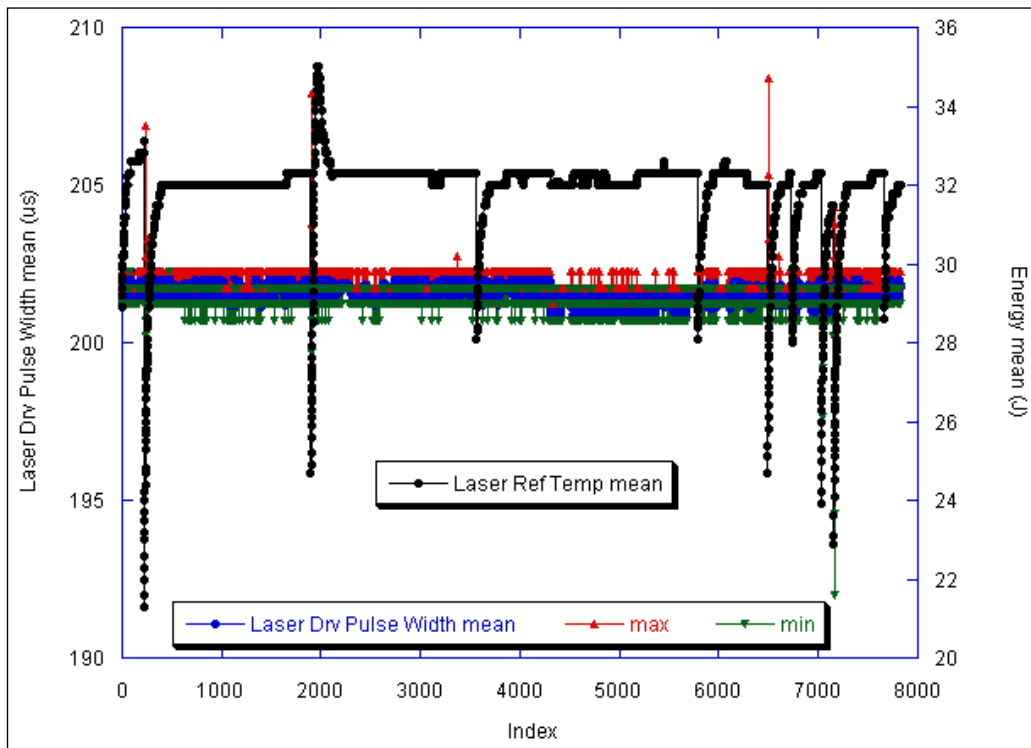

1

Laser 1 Drive Pulsewidth (1 min averages) and Reference Temperature vs. Time

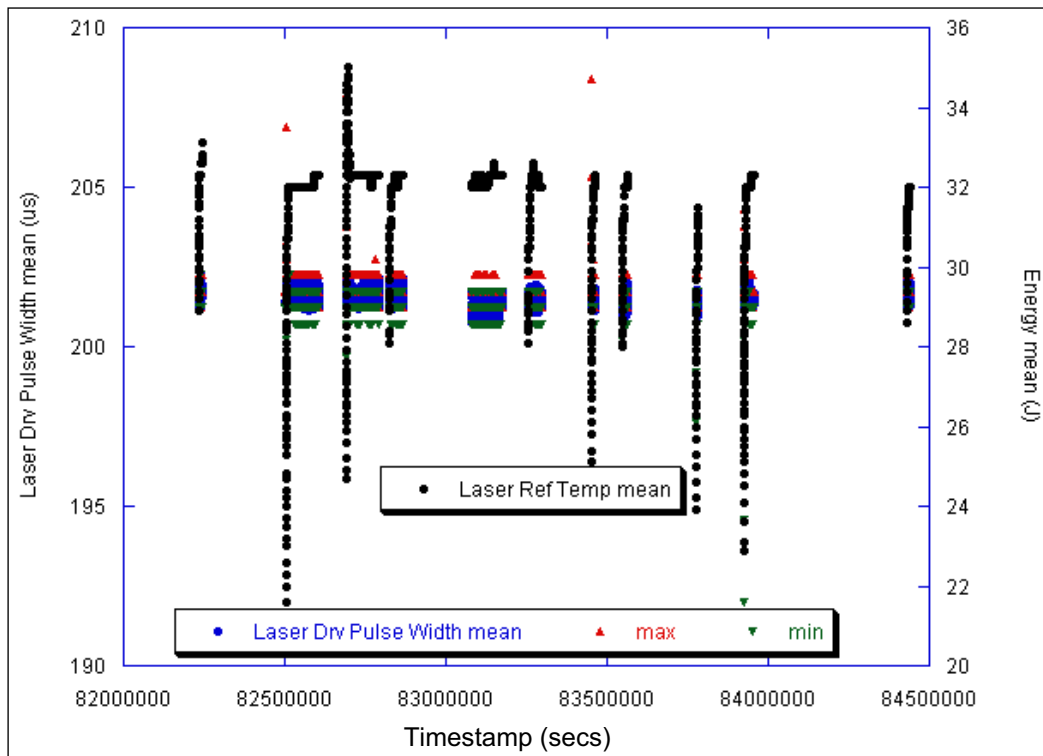

1

Laser 2

Laser 2 Detector and Molecron Relative Energies vs. Time (1 min averages)

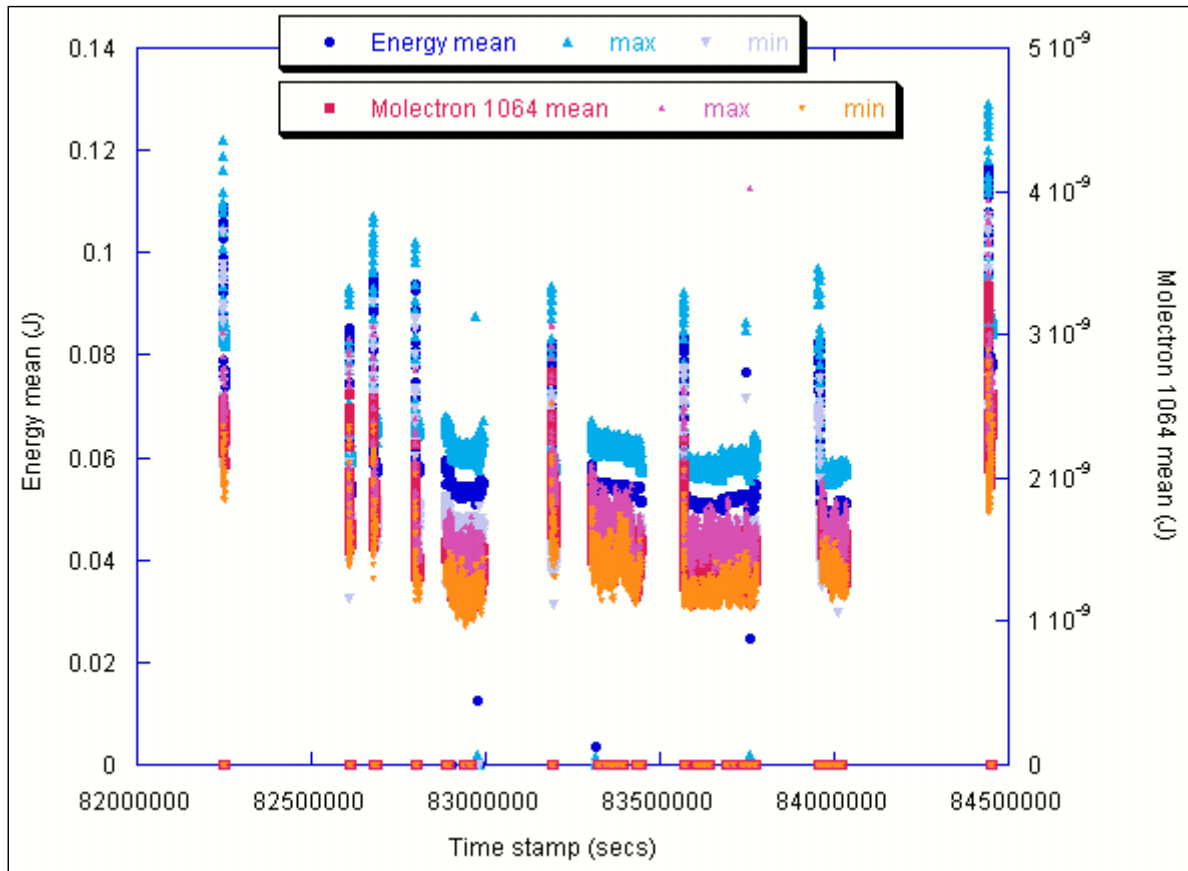

Laser 2 Energies vs. Index (1 min averages)

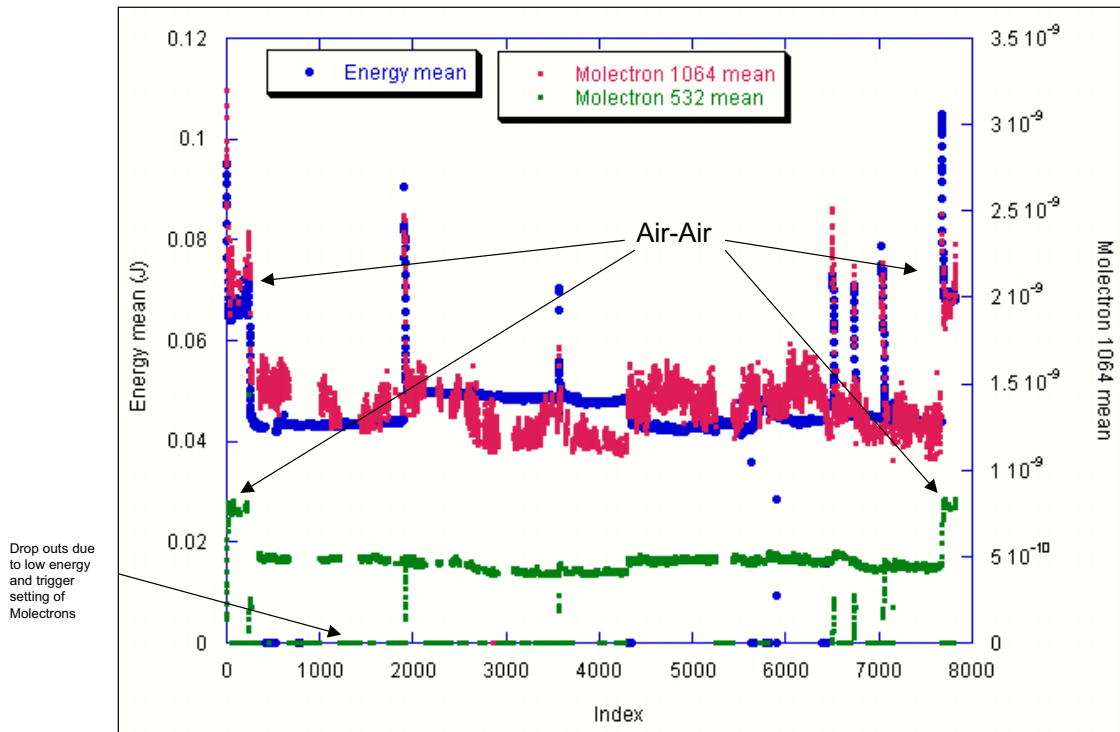

105

Laser 2 Drive Pulswidth (1 min averages) and Reference Temperature vs. Index

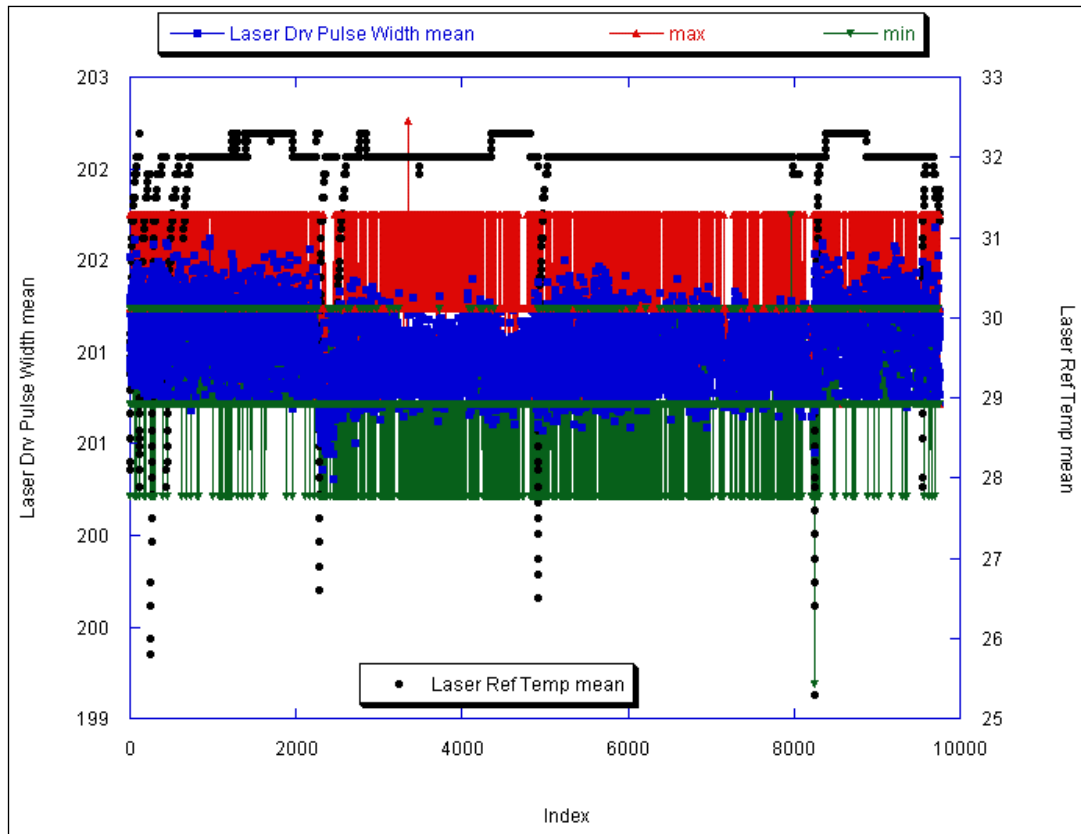

106

Laser 2 Drive Pulsewidth (1 min averages) and Reference Temperature vs. Time

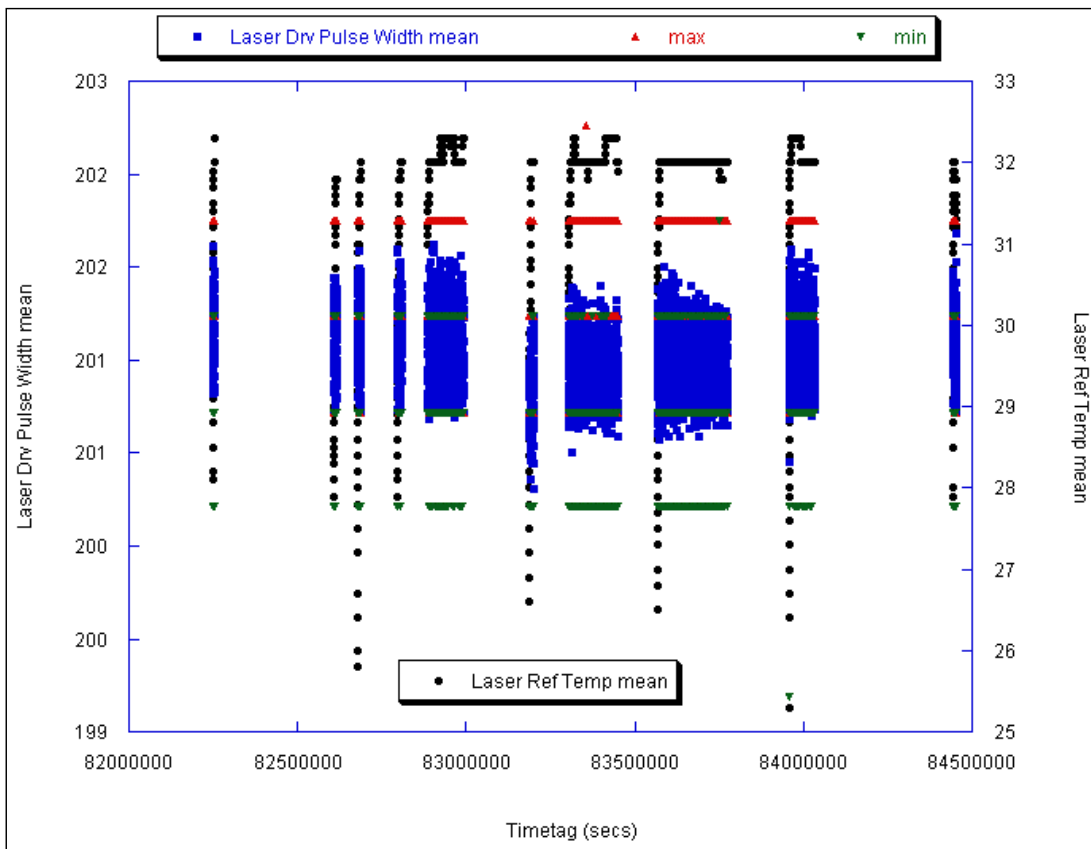

Laser 3

Laser 3 Detector and Molelectron Relative Energies vs. Time (1 min averages)

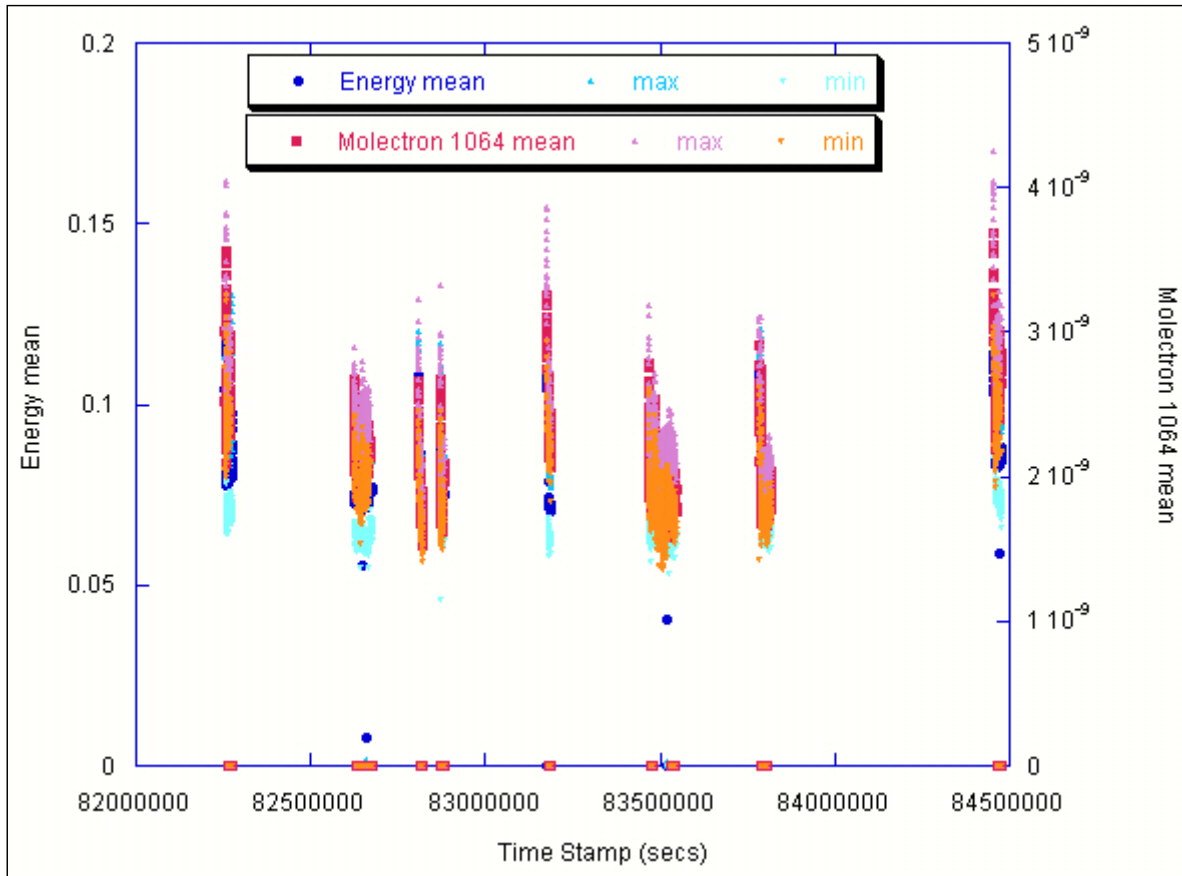

Laser 3 Energies vs. Index (1 min averages)

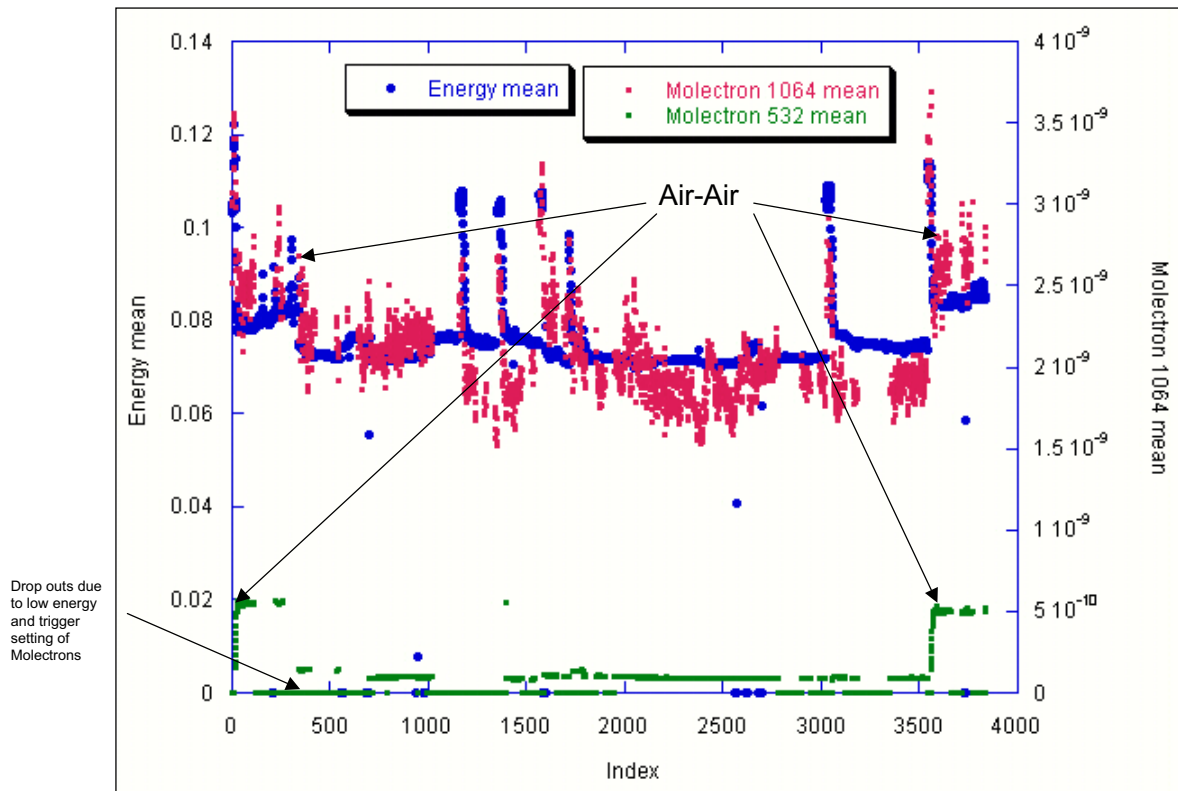

Laser 3 Drive Pulsewidth (1 min averages) and Reference Temperature vs. Index

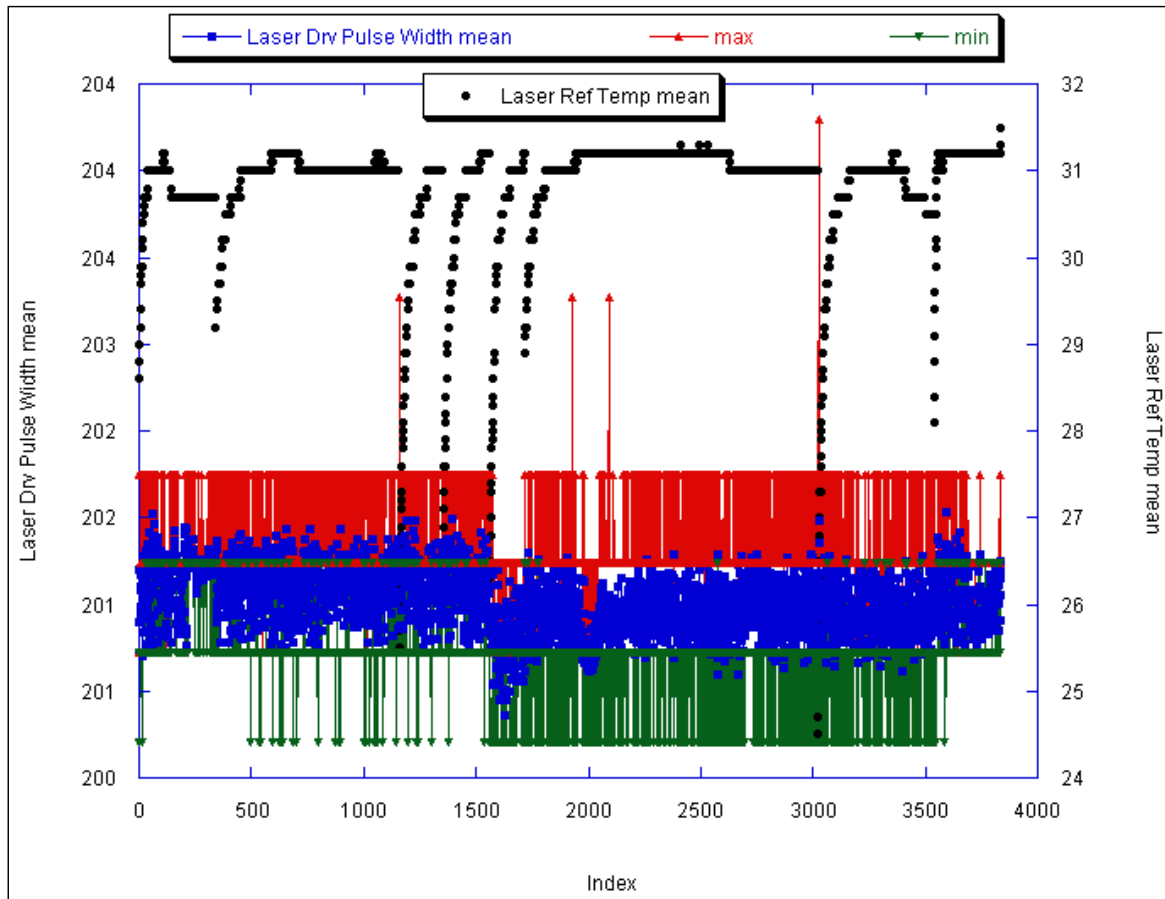

Laser 3 Drive Pulsewidth (1 min averages) and Reference Temperature vs. Time

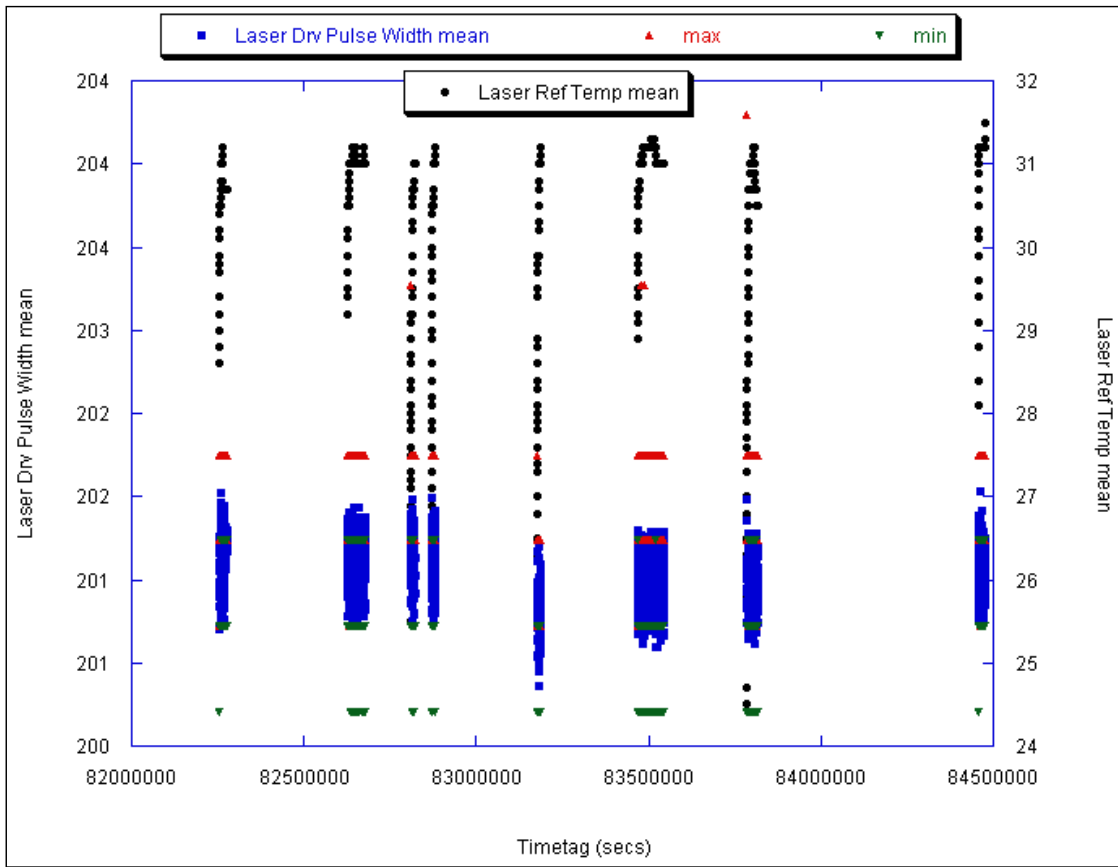

Number of Laser Shots Fired
from Laser Delivery to I&T until 2002 Day 278 (Oct 4)

Component	Total On Time (hours)	On/Off Cycles (or mechanism actuations)	Notes
Laser 1	656.07	133	Data as of 10/04/02 Shots Fired=86,816,480
Laser 2	533.32	93	Data as of 10/04/02 Shots Fired=72,178,760
Laser 3	420.01	72	Data as of 10/04/02 Shots Fired=55,825,360

Summary

- Average power measurements during GLAS instrument testing at GSFC
- Comparison with SLTC average power measurements before delivery to GLAS

	GLAS			SLTC Measurements			Delta GLAS-SLTC			Delta GLAS-SLTC			
	Average Power (W)			Average Power (W)			ABS	ABS	ABS	%	%	%	
Laser	532	1064	Total	Laser	532	1064	Total	532	1064	Total	532	1064	Total
Laser 1	1.41	2.88	4.29	SN2	1.36	2.80	4.16	0.05	0.08	0.13	3.5%	2.8%	3.0%
Laser 2	1.28	3.20	4.48	SN3	1.29	3.10	4.39	-0.01	0.10	0.09	-0.7%	3.1%	2.0%
Laser 3	0.99	3.28	4.27	SN1	1.18	3.26	4.43	-0.19	0.02	-0.16	-19.2%	0.8%	-3.9%

- Energy measurements during GLAS instrument testing at GSFC

Laser	High Energy Molelectron		GLAS Energy		SLTC Energy	
	Aver. Energy (mJ)		Derived Energy (mJ)		Derived Energy (mJ)	
Laser	532	1064	532	1064	532	1064
Laser 1	Not Measured		35.2	72.0	34.0	70.0
Laser 2	33.9	78.5	32.0	79.9	32.3	77.5
Laser 3	25.2	81.7	24.7	82.0	29.5	81.4

Derived Energy (mJ) = Average Power(W)/40 Hz

- Energy measurements at observatory - Comparison with GSFC Energy measurements

Laser	GSFC		Observatory		Observatory - GSFC Delta			
	Aver. Energy (mJ)		Aver. Energy (mJ)		ABS	ABS	%	%
Laser	532	1064	532	1064	532	1064	532	1064
Laser 1	Not Measured		34.3	68.0	Not Measured		Not Measured	
Laser 2	33.9	78.5	33.9	77.7	0.0	-0.8	-0.1%	-1.1%
Laser 3	25.2	81.7	23.9	82.7	-1.3	1.0	-5.6%	1.2%

- Altimeter Detector laser energy calibration

$$\hat{E} = \frac{\Delta\tau \sum v_r(i)}{\eta_{circuit} \cdot \eta_{optical} \cdot R_{det} \cdot G_{VGA} \cdot \alpha_{cal}}$$

All parameters known (calibrated) for each laser-detector/digitizer combination within ~ 12%

Summary - continued

- ***Relative* Laser energy during instrument TVAC**
- Comparison with Altimeter Detector laser energy
 - Parameters determined
- ***Relative* Laser energy during observatory TVAC**
- Comparison with Altimeter Detector laser energy
 - Parameters determined
- **Correlation with LRS**
 - See separate C. Field Report (attached)
- **Correlation with LPA**
 - See separate C. Field Report (attached)
- *Relative* Laser energy measurements during instrument TVAC - Comparison with Altimeter Detector laser energy

Conclusions

- 1064 nm laser energy:
 - No significant change since laser delivery to GLAS.
- 532 nm energy:
 - No significant change for lasers 1 and 2, since GSFC measurements
 - Declined by ~ 5.6% (1.3 mJ) for Laser 3 since GSFC measurements
- Altimeter detectors/digitizers calibrated to provide an on-orbit estimate of the laser energy
- Correlation with LPA - no strong correlation found
- Correlation with LRS - no strong correlation found

Appendix E.2

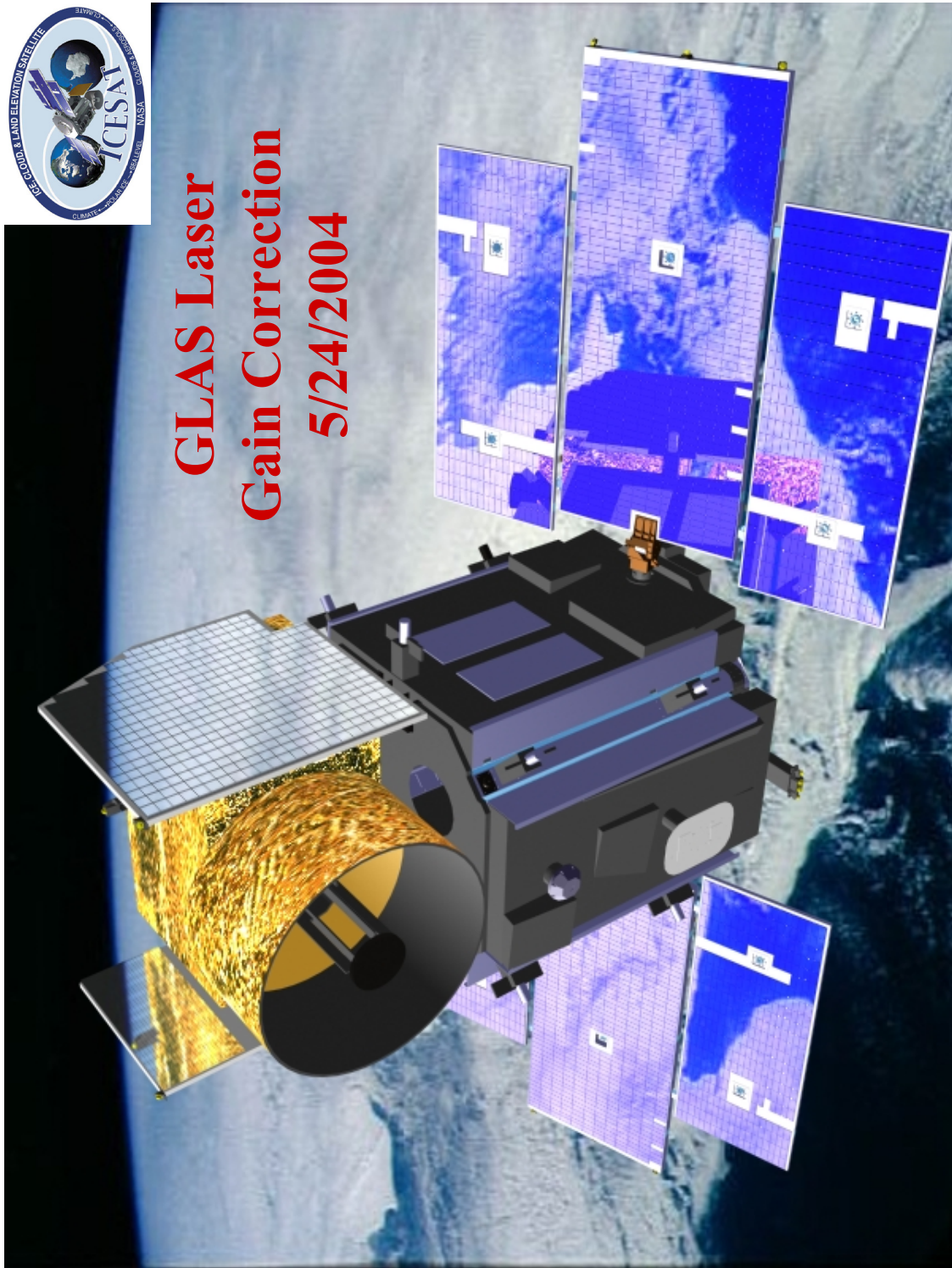



Energy Estimate from Altimeter Detector Start Pulse

$$\hat{E} = \frac{\Delta\tau \cdot \sum_0^47 v(i)}{\eta_c \cdot \eta_{optical} \cdot R_{det} \cdot G_{VGA} \cdot \alpha_{cal}}$$

where

\hat{E} is the laser pulse energy in Joules corresponding to the waveform sample.

$\Delta\tau$ is the sampling interval = 1×10^{-9} secs.

$v(i)$ is the i^{th} waveform sample in volts, $i = 0, 1, \dots, 47$

$\eta_c = 92.3\%$ is the circuit throughput from the detector to the digitizer

$\eta_{optical}$ is the fiber box and fiber transmission for the transmitted pulse, per laser per detector/digitizer combination. $\eta_{optical}$ was estimated from ground testing data.

	Detector 1	Detector 2
Laser 1	2.9650E-14	N/A
Laser 2	2.7868E-14	2.2572E-14
Laser 3	2.7937E-14	2.3357E-14

$R_{det} = 2.28e7$ Volts/Watts is the detector responsivity

α_{cal} is a calibration coefficient determined by system level test data to be 1.12

G_{VGA} is the normalized gain of the variable gain amplifier (VGA)

$$G_{VGA} = \frac{C_{gain}}{2^8 - 1}$$

with C_{gain} the integer valued detector gain in the telemetry. Nominal value for C_{gain} is 41.



Laser Campaign 2B Laser History

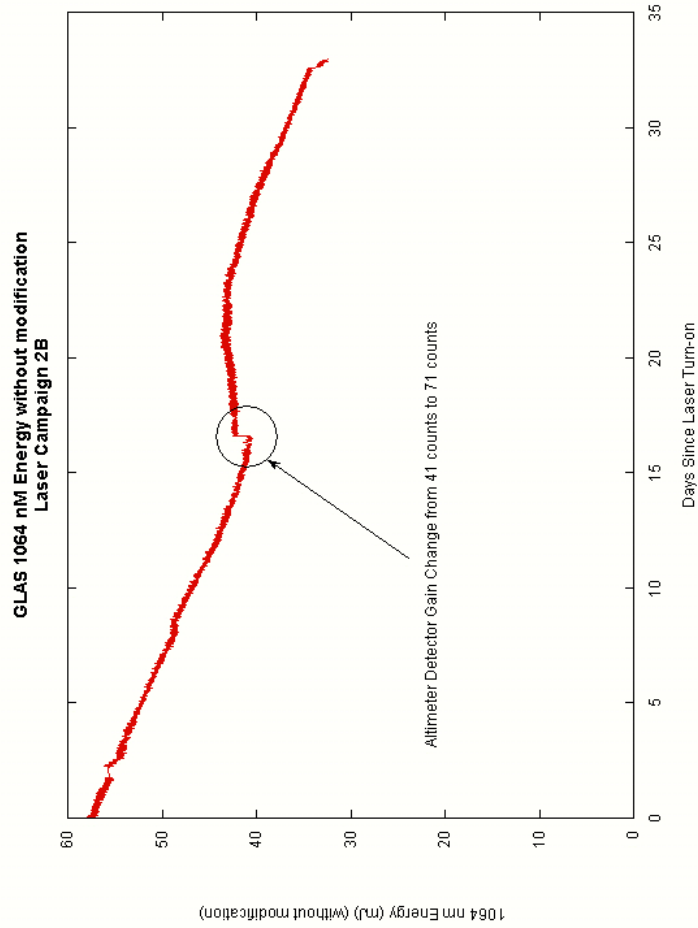

5/24/2004

NASA GSFC - Laser Remote Sensing Branch

pml - 3



Laser Campaign 2B Laser History Implications



- About a 1.6 mJ jump in estimated Laser Energy with original formula.
- “Quick and dirty” fix was to subtract 1.6 mJ from Laser Energy output.
- This subtractive offset has the problem that as the energy asymptotes to zero, the energy will eventually show as “negative” Laser energy, clearly non-representative.
- If a multiplicative factor of 0.96 is applied to the data after the gain change, the same smoothing effect of the discontinuity can be achieved.

5/24/2004

NASA GSFC - Laser Remote Sensing Branch

pml - 4

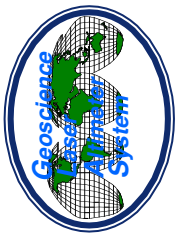

Gain Correction vs. Gain Setting Setting Correlation

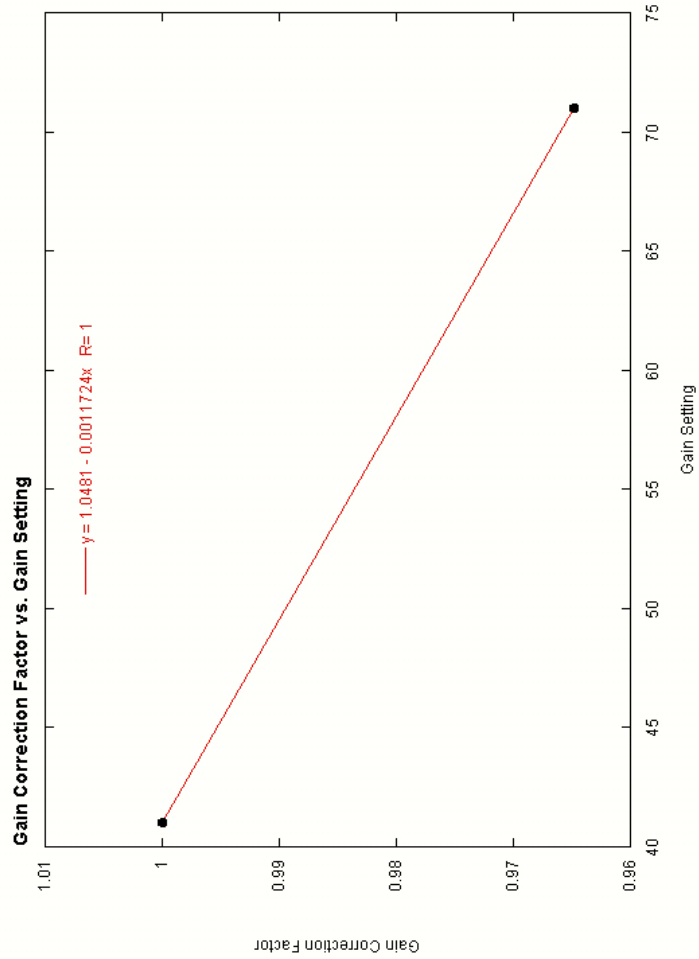



New Gain Formula



$$G_{VGA} = C_{\text{gain}} / ((2^8 - 1) * (1.0481 - (1.172 \times 10^{-3} * C_{\text{gain}})))$$

- At Gain = 41 (the gain at which all of our calibrations are based) formula output is unchanged from previous formula.
- At Gain = 71 (present setting) formula output decreases estimate by a factor of ~0.96, which smooths out the Laser Energy curve for the Laser Campaign 2B.
- At next gain change, the new offset can be checked against this formula. If it does not "fit" with a linear approximation, a 2nd order polynomial fit can be applied.

5/24/2004

NASA GSFC - Laser Remote Sensing Branch

pml - 6



Application of New Gain Formula

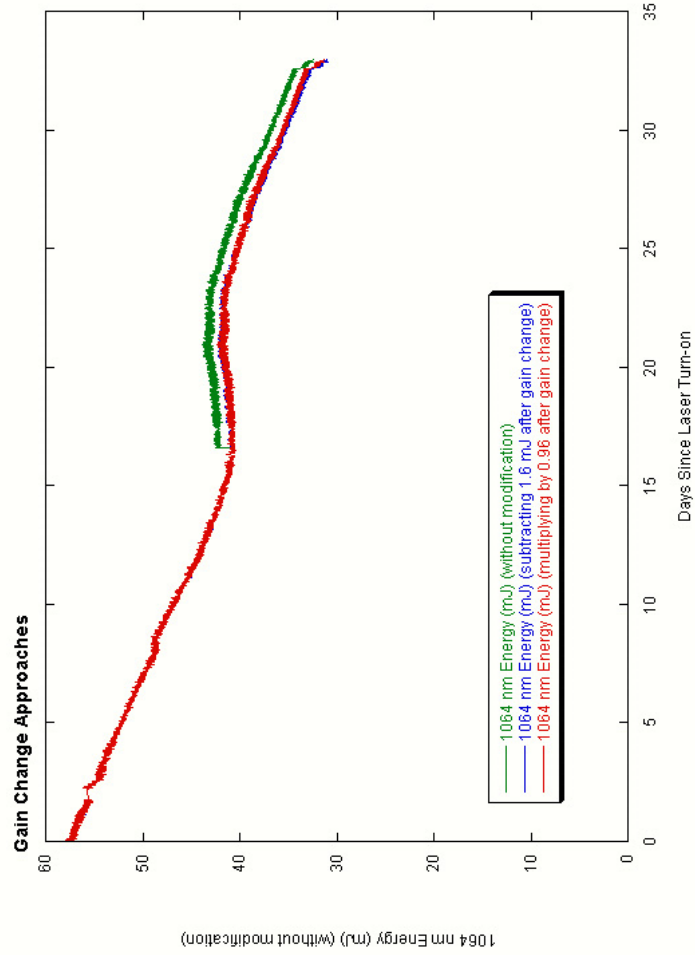



Application of New Gain Formula – Finer Scale

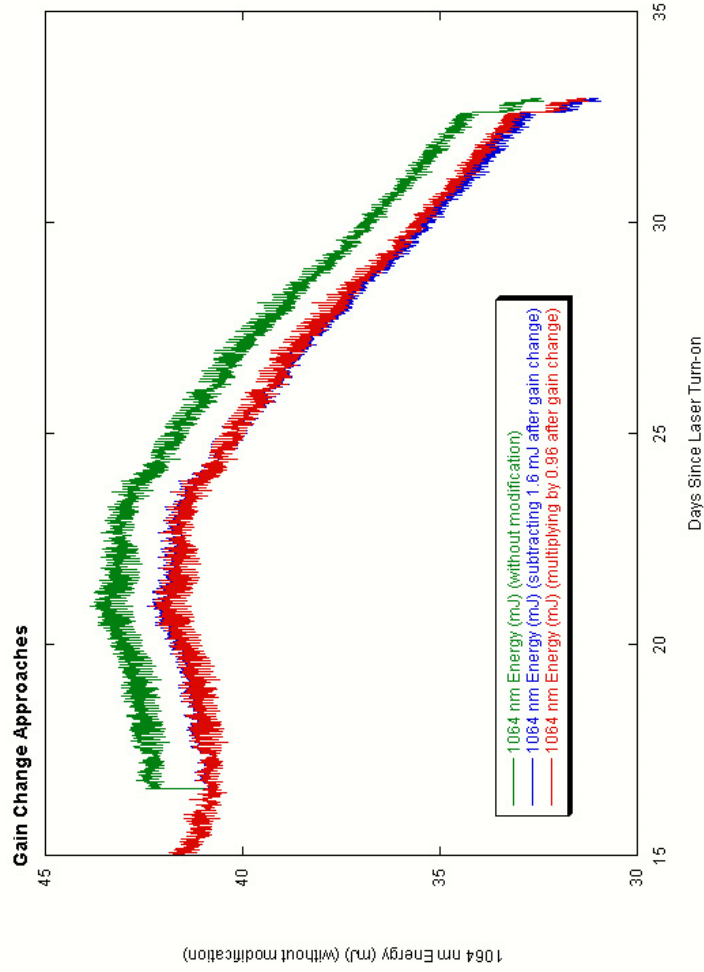

5/24/2004

NASA GSFC - Laser Remote Sensing Branch

pml - 8



Advantages/Disadvantages

- **Advantages**
 - New curve fit is a factor change instead of an applied offset.
 - Should be more accurate as energy asymptotes to zero.
 - Can be quickly modified when new gain changes occur as needed.
- **Disadvantages**
 - It will subtly change the already existing energy history (but should make it more accurate).
 - Slightly more complicated (but not overwhelmingly so – It has already been implemented as an option for the preparing of this presentation).



Summary



- A new gain formula for Laser Energy Estimation is proposed.
- New formula should increase the accuracy of past, present and future energy estimates.
- Easy to implement, but requires a re-reduction of all historical data since the gain change from 41 to 71 occurred during Laser Campaign 2B.

5/24/2004

NASA GSFC - Laser Remote Sensing Branch

pml - 10

Abbreviations & Acronyms

APID	Application Process Identifier. CCSDS Packets identify the APID as supplied by the Spacecraft Instrument; EDOS identifies the APID as a concatenation of Spacecraft Identification (SCID) and the APID.
CCSDS	Consultative Committee for Space Data Systems
EDOS	EOS Data and Operations System
EOS	NASA Earth Observing System Mission Program
EOSDIS	Earth Observing System Data and Information System
GLAS	Geoscience Laser Altimeter System instrument or investigation
GPS	Global Positioning System
GSFC	NASA Goddard Space Flight Center at Greenbelt, Maryland
GSFC/WFF	NASA Goddard Space Flight Center/Wallops Flight Facility at Wallops Island, Virginia
HK	Housekeeping
ID	Identification
LASER	Light Amplification by Stimulated Emission of Radiation
LIDAR	Light Detection and Ranging
LPA	LASER Profiler Array
N/A	Not (/) Applicable
NASA	National Aeronautics and Space Administration
NOAA	National Oceanic and Atmospheric Administration
PDS	Production Data Sets
POD	Precision Orbit Determination
PROD ID	Data Product Identification
SCF	GLAS investigation Science Computing Facility and workstation(s)
SRS	Stellar Reference System
TBD	to be determined, to be done, or to be developed
TLM	Telemetry
UNIX	the operating system jointly developed by the AT&T Bell Laboratories and the University of California-Berkeley System Division

Glossary

Level 0	The level designation applied to an EOS data product that consists of raw instrument data, recorded at the original resolution, in time order, with any duplicate or redundant data packets removed.
Level 1A	The level designation applied to an EOS data product that consists of reconstructed, unprocessed Level 0 instrument data, recorded at the full resolution with time referenced data records, in time order. The data are annotated with ancillary information including radiometric and geometric calibration coefficients, and georeferencing parameter data (i.e., ephemeris data). The included, computed coefficients and parameter data have not however been applied to correct the Level 0 instrument data contents.
Level 1B	The level designation applied to an EOS data product that consists of Level 1A data that have been radiometrically corrected, processed from raw data into sensor data units, and have been geolocated according to applied georeferencing data.
Level 2	The level designation applied to an EOS data product that consists of derived geophysical data values, recorded at the same resolution, time order, and georeference location as the Level 1A or Level 1B data.
Level 3	The level designation applied to an EOS data product that consists of geophysical data values derived from Level 1 or Level 2 data, recorded at a temporally or spatially resampled resolution.
Level 4	The level designation applied to an EOS data product that consists of data from modeled output or resultant analysis of lower level data that are not directly derived by the GLAS instrument and supplemental sensors.
product	Specifically, the Data Product or the EOS Data Product. This is implicitly the labeled data product or the data product as produced by software on the SDPS or SCF. A GLAS data product refers to the data file or record collection either prefaced with a product label or standard formatted data label or linked to a product label or standard formatted data label file. Loosely used, it may indicate a single pass file aggregation, or the entire set of product files contained in a data repository.
record	A specific organization or aggregate of data items. It represents the collection of EOS Data Parameters within a given time interval, such as a one-second data record. It is the first level decomposition of a product file.

REPORT DOCUMENTATION PAGE

*Form Approved
OMB No. 0704-0188*

The public reporting burden for this collection of information is estimated to average 1 hour per response, including the time for reviewing instructions, searching existing data sources, gathering and maintaining the data needed, and completing and reviewing the collection of information. Send comments regarding this burden estimate or any other aspect of this collection of information, including suggestions for reducing this burden, to Department of Defense, Washington Headquarters Services, Directorate for Information Operations and Reports (0704-0188), 1215 Jefferson Davis Highway, Suite 1204, Arlington, VA 22202-4302. Respondents should be aware that notwithstanding any other provision of law, no person shall be subject to any penalty for failing to comply with a collection of information if it does not display a currently valid OMB control number.

PLEASE DO NOT RETURN YOUR FORM TO THE ABOVE ADDRESS.

1. REPORT DATE (DD-MM-YYYY) 30-06-2012		2. REPORT TYPE Technical Memorandum		3. DATES COVERED (From - To)	
4. TITLE AND SUBTITLE ICESat (GLAS) Science Processing Software Document Series The Algorithm Theoretical Basis Document for Level 1A Processing, Volume 5				5a. CONTRACT NUMBER	
				5b. GRANT NUMBER	
				5c. PROGRAM ELEMENT NUMBER	
6. AUTHOR(S) Peggy L. Jester David W. Hancock III				5d. PROJECT NUMBER	
				5e. TASK NUMBER	
				5f. WORK UNIT NUMBER	
7. PERFORMING ORGANIZATION NAME(S) AND ADDRESS(ES) Goddard Space Flight Center Wallops Flight Facility Code 615/Cryospheric Sciences Laboratory Wallops Island, VA 23337				8. PERFORMING ORGANIZATION REPORT NUMBER	
9. SPONSORING/MONITORING AGENCY NAME(S) AND ADDRESS(ES) National Aeronautics and Space Administration Washington, DC 20546-0001				10. SPONSORING/MONITOR'S ACRONYM(S) NASA	
				11. SPONSORING/MONITORING REPORT NUMBER NASA/TM-2012-208641/Vol. 5	
12. DISTRIBUTION/AVAILABILITY STATEMENT Unclassified-Unlimited, Subject Category: 31 Report available from the NASA Center for Aerospace Information, 7115 Standard Drive, Hanover, MD 21076. (443)757-5802					
13. SUPPLEMENTARY NOTES					
14. ABSTRACT The first process of the Geoscience Laser Altimeter System (GLAS) Science Algorithm Software converts the Level 0 data into the Level 1A Data Products. The Level 1A Data Products are the time ordered instrument data converted from counts to engineering units. This document defines the equations that convert the raw instrument data into engineering units. Required scale factors, bias values, and coefficients are defined in this document. Additionally, required quality assurance and browse products are defined in this document.					
15. SUBJECT TERMS GLAS, quality assurance, data, conversion					
16. SECURITY CLASSIFICATION OF:			17. LIMITATION OF ABSTRACT Unclassified	18. NUMBER OF PAGES 302	19a. NAME OF RESPONSIBLE PERSON Dr. H. Jay Zwally
a. REPORT Unclassified	b. ABSTRACT Unclassified	c. THIS PAGE Unclassified			19b. TELEPHONE NUMBER (Include area code) 301.614.5643

