

JWST's Cryogenic Position Metrology System

Tony L. Whitman^a, Randolph P. Hammon^b, Joe Orndorff^b, Stephen Hope^b, Stephen A. Smee^b,
Thomas Scorse^a, Keith A. Havey, Jr^a

^aTTT Exelis Geospatial Systems, 400 Initiative Drive, P.O. Box 60488, Rochester, NY, USA 14606-0488; ^bJohns Hopkins University

ABSTRACT

The James Webb Space Telescope will undergo a full system test in the cryogenic vacuum chamber A at the Johnson Spaceflight Center in order to verify the overall performance of the combined telescope and instrument suite. This will be the largest and most extensive cryogenic test ever undertaken. Early in the test system development, it was determined that precise position measurements of the overall hardware would enhance the test results. Various concepts were considered before selecting photogrammetry for this metrology. Photogrammetry has been used in space systems for decades, however cryogenic use combined with the size and the optical/thermal sensitivity of JWST creates a unique set of implementation challenges. This paper provides an overview of the JWST photogrammetric system and mitigation strategies for three key engineering design challenges: 1) the thermal design of the viewing windows to prevent excessive heat leak and stray light to the test article 2) cost effective motors and mechanisms to provide the angle diversity required, and 3) camera-flash life and reliability sufficient for inaccessible use during the number and duration of the cryogenic tests.

Keywords: JWST, photogrammetry, cryogenic, metrology, optical test, infrared, telescope

INTRODUCTION

One of the key objectives of the ground test of JWST is the optical alignment of the telescope in the operational cryogenic environment. In particular all 18 primary mirror segment assemblies (PMSAs) and the secondary mirror assembly have actuators to align the telescope after being folded for the rocket launch. To achieve optical performance, the actuators align the mirrors with respect to the fixed position of the tertiary mirror of the three mirror anastigmat telescope and the fixed position of the Integrated Science Instrument Module (ISIM). The large size of the telescope and the cryogenic operating temperature prevents the ability to test simply with a single simulated star, or full size auto-collimated beam. Rather the optical performance is checked by a center-of-curvature interferometer and sub-aperture auto-collimating flat mirrors. As a result, not all alignment degrees of freedom can be determined unambiguously. The test needs an independent metrology method.

The metrology options evaluated included laser trackers, laser scanners, theodolites, networks of fringe-tracking beams and/or time-of-flight laser beams, mechanical methods, and photogrammetry. Given the cryogenic vacuum environment, photogrammetry was selected as the best solution to meet the needs of the test. The photogrammetry system used in the Space Environment Simulator (SES) for NASA's Wilkinson Microwave Anisotropy Probe (WMAP) provided a basis for an adaptation to measure JWST in Chamber A at the Johnson Space Center. As shown schematically in Figure 2, the system consists of four cameras on booms rotating about shafts attached to the chamber wall like windmills above the telescope. A canister encloses each camera in a room-temperature atmospheric-pressure enclosure with windows for the camera and flash.

Unlike the WMAP system, each camera includes pan and tilt capability at the end of each windmill boom for greater angular diversity. Furthermore, careful window design accommodates the infrared and thermal sensitivity of JWST – the window for each camera and the window for each flash light. The design of the flash bulb and housing were engineered for improved life to meet the durations of the tests and minimize the need for replacements at a height of 40 feet from the floor of the chamber.

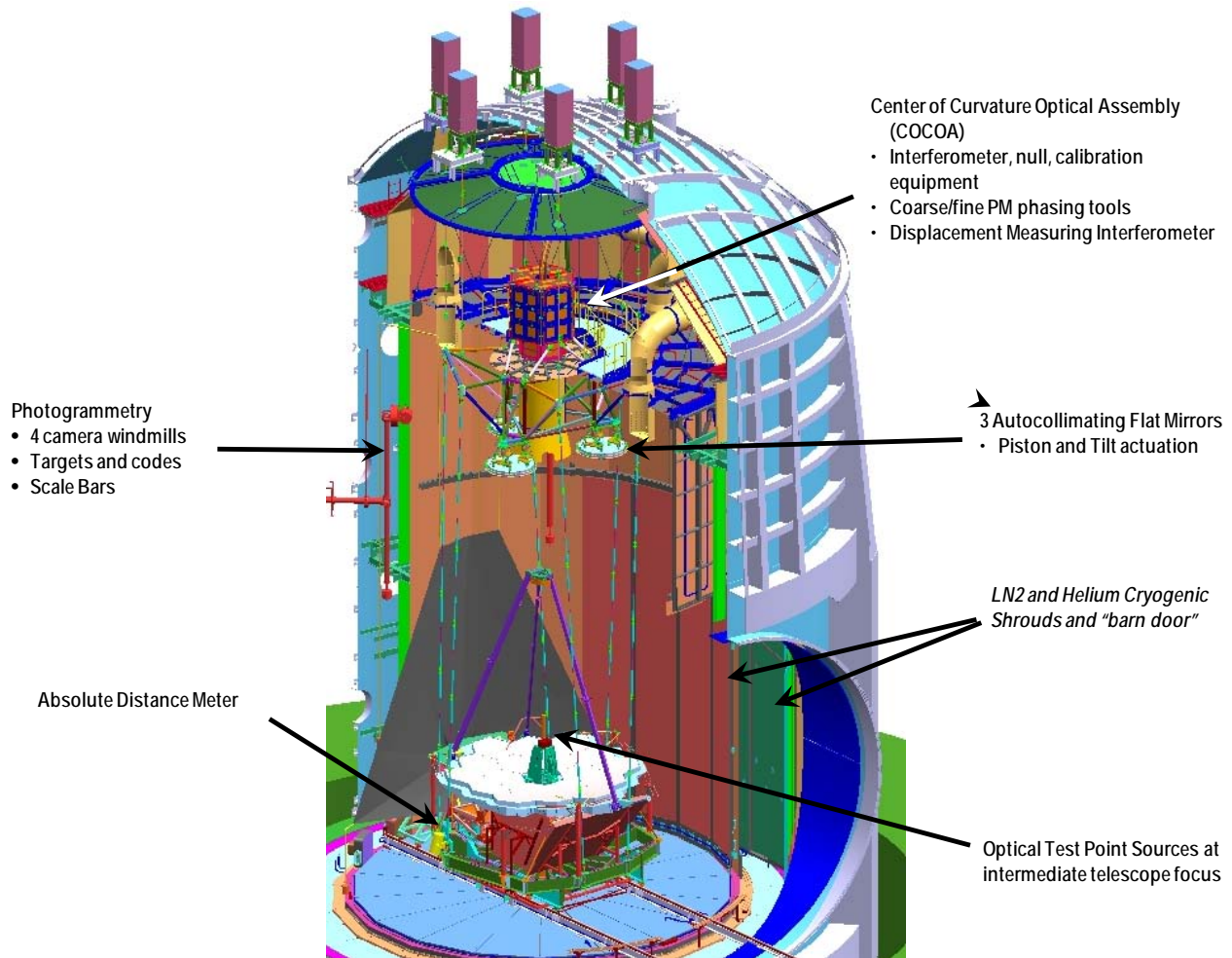

Figure 1 Cryogenic optical test configuraton of JWST

MOTION DESIGN

Each of the four identical boom systems used to survey the metrology field in Chamber A have four independent drive mechanisms; in this case, gear motors. A single large gear motor rotates the long drive shaft and boom arms shown in Figure 3. The three remaining gearmotors serve to actuate the pan and tilt axes of the canister as well as the rotation of the photogrammetry camera itself inside the pressure tight enclosure, i.e. the canister. Each of these drive mechanisms is described in some detail below.

Boom drive motor

The boom drive motor resides between the liquid nitrogen shroud and the gaseous helium shroud. A hexapod-strut support extends from the chamber wall through a penetration in the liquid nitrogen shroud to support the boom drive motor. Locating the drive motor between the shrouds simplifies access to the cold gaseous helium supply used to cool the system to 20 K. However, it does require that the drive motor be designed for use at cryogenic temperature (approximately 100 K). The design used here borrows largely from the photogrammetry system built for the Space Environmental Simulator at the Goddard Space Flight Center, which operates in a nearly identical thermal environment. It too is used for JWST testing.

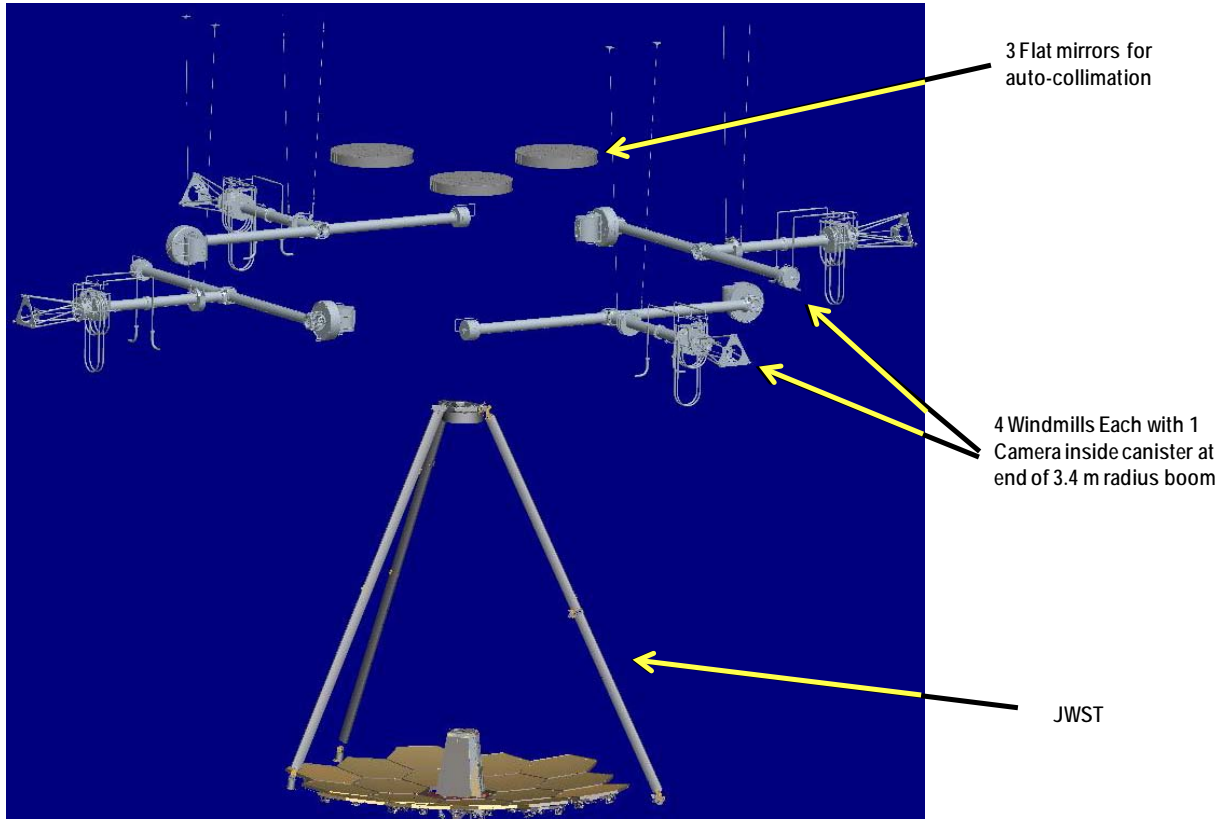

Figure 2 4 - camera cryogenic metrology of JWST

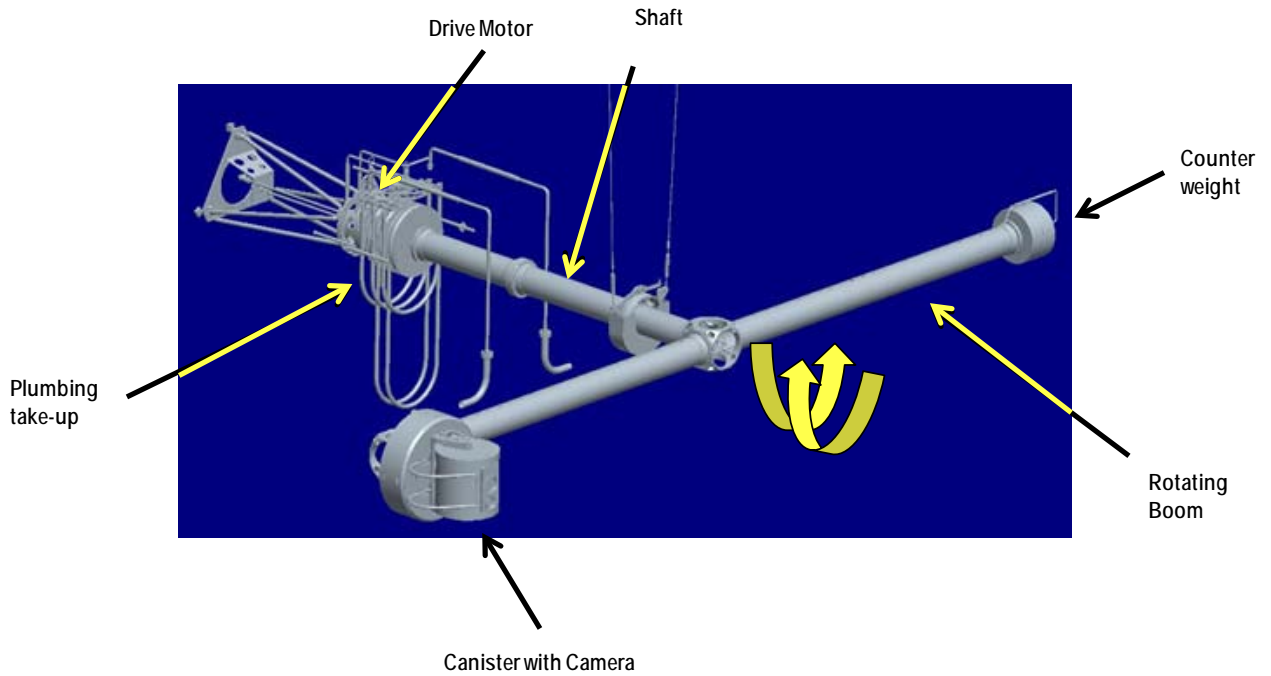

Figure 3 One camera / boom assembly

22 CFR 125.4(b)(13) applicable

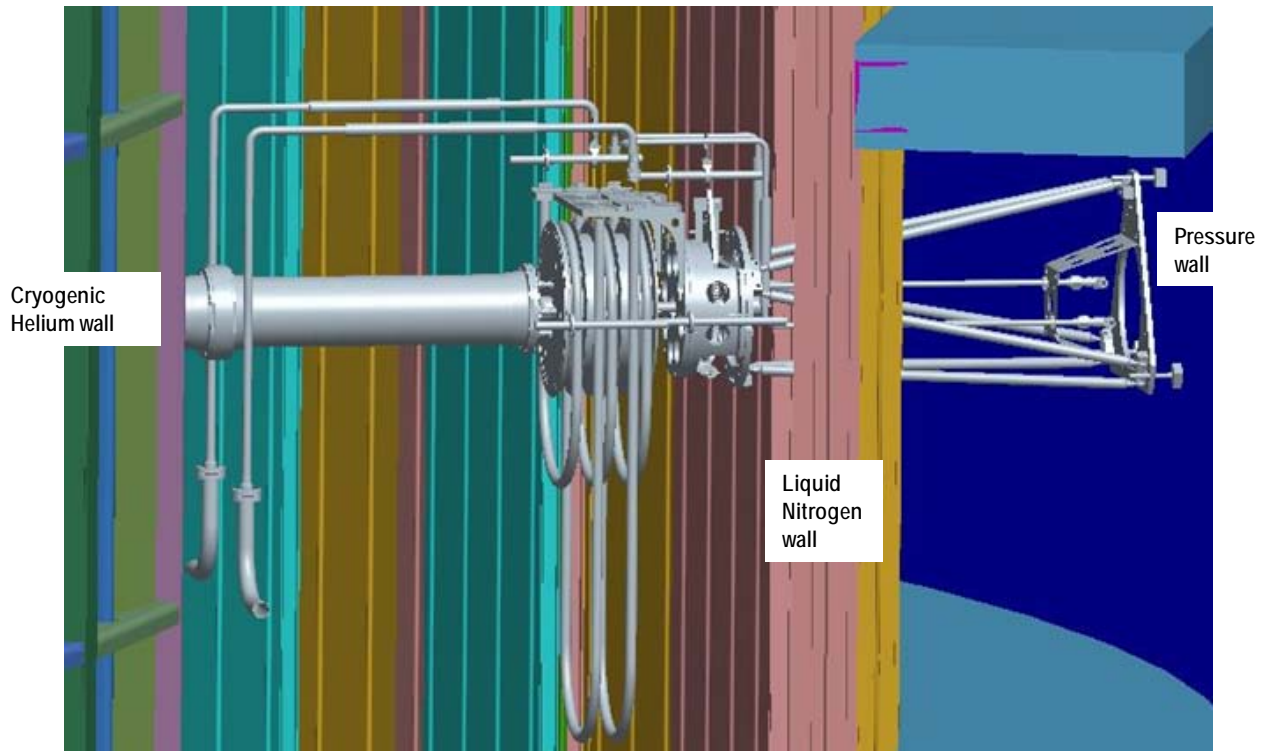

Figure 4 Shaft through walls

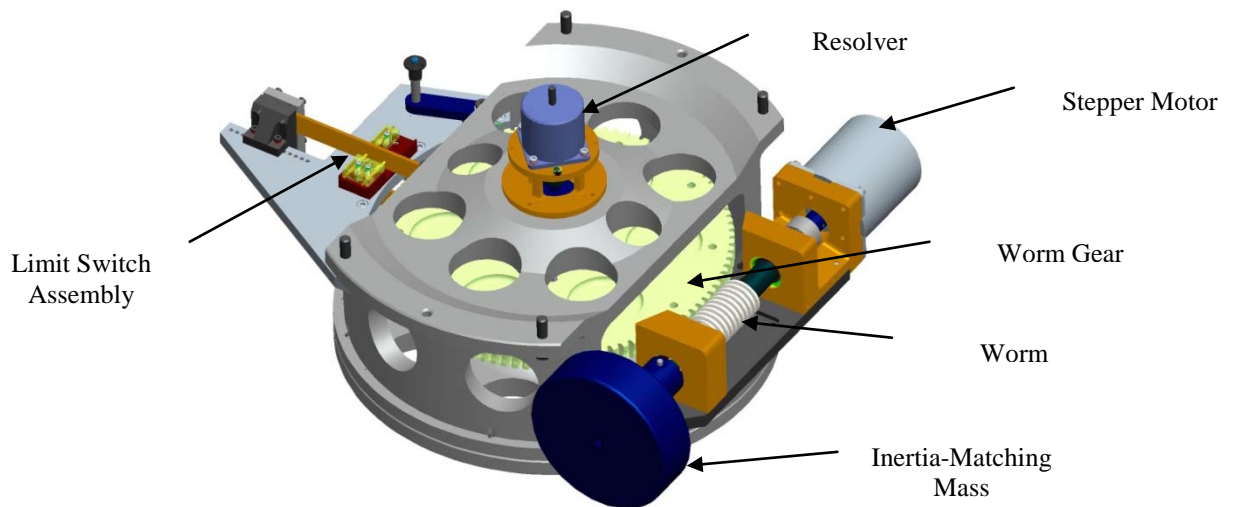

Figure 5 Isometric rendering of the boom drive gearmotor

Figure 5 shows a rendered image of the boom drive motor for the JSC photogrammetry system. The mechanism is a worm drive gearmotor that utilizes a Mission Research Corporation cryogenic stepper motor (model# MRC 12728) to drive a Vespel worm against a large aluminum worm gear at a ratio of 180:1. This reduction ratio is sufficient to

22 CFR 125.4(b)(13) applicable

overcome the inertia of the boom and the resistance of the plumbing take-up spool just downstream of the drive motor. The worm gear is coated with a PTFE-impregnated anodized coating to enhance wear resistance and to reduce friction. Attached to the axis of the worm gear is a large stainless steel shaft supported at each end by a hybridized bearing (silicon nitride balls, 440C stainless races, and a Vespel ball retainer) in the motor housing. Simple mechanical limit switches prevent over-travel in each direction, the travel range being set to 372.5 degrees, with hard stops just outside this range to halt motion should the switches fail. Limit switches are comprised of pogo pins that make electrical contact with a titanium flexure. The flexure then serves to both actuate the limits and, should a limit fail, provide a controlled arrest of the axis motion. An Empire Magnetics rotary resolver (model #EMR-57) meters the rotation at one end of the shaft. The other end of the shaft couples directly to the plumbing take-up spool, which in turn is connected to the boom drive shaft.

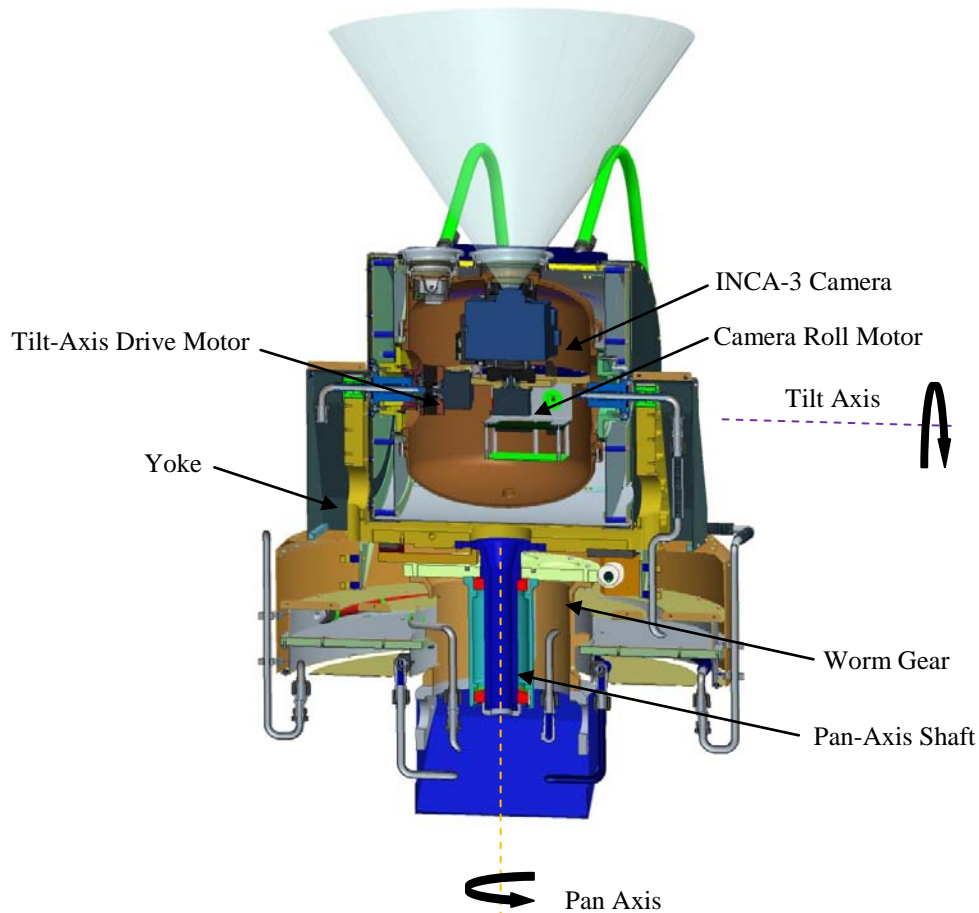

Figure 6 Cross section of canister and drive mechanism assembly.

Pan-axis drive motor

Pan motion is defined to be the rotation of the canister assembly about an axis perpendicular to the boom arm; see Figure 6. The required range of motion is +/- 60 degrees. The mechanism used here borrows largely from the boom drive motor design. In fact it uses an identical worm gear set. The stepper motor is a Phytron VSS-UHVC-57. The limit switch assembly and the hard stop design are nearly identical as well, the difference being that the titanium flexure is mounted inboard of the worm gear rather than outboard in the case of the boom drive.

What is somewhat different is the operating temperature. Unlike the boom drive motor, the pan-axis drive motor operates at 20 K. This, along with a variable gravity loading, complicates the design of the shaft bearing support. As with the boom drive motor, two large hybrid bearings are used to support the shaft. Like the boom motor, they are mounted in an aluminum housing; preferred so as to match the coefficient of thermal expansion (CTE) of the interface material. The issue is that the differential contraction between the aluminum housing and the steel bearings is sufficient to produce a sizable degree of “lash” between the worm and worm gear when operating at ambient temperature, provided the bearing bore diameter is sufficiently oversized to accommodate the difference in CTE. To mitigate this problem the bearings are centered in the aluminum housing by Delrin plugs located around the circumference of the outer bearing race. These plugs are integral to the housing and machined in-place to fit the bearing. The diameter of the plugs has been selected such that the differential thermal contraction of the aluminum housing and the Teflon plugs matches that of the steel race. In this way, the bearings are “snug” in the housing throughout the entire operating temperature range, warm-to-cold. It should be noted that the worm gear shaft is also aluminum, however the diameter is small enough that the lash contributed is not a concern.

Another notable difference between the designs is that the pan-axis motor does not have an encoder feedback, whereas the boom drive motor uses a resolver. This is due largely to the desire to run electrical wiring through a hole in the center of the shaft, which precludes a direct-drive resolver.

Tilt-axis drive motor

Tilt-axis motion is defined as rotation of the canister about an axis perpendicular to the camera optical axis; see Figure 6. The drive is a gearmotor consisting of a Sanyo Denki (model # 103H7821-5760) stepper motor and a Harmonic Drive 100:1 gearhead (model# CSD-17-100-2UF). The gearmotor is located inside the canister so as to avoid an additional cryogenic mechanism; see Figure 7. To achieve rotation, the gearmotor is coupled to a custom ferro-fluidic feedthrough from FerroTec Corp, which is coupled statically to the yoke that supports the canister. With the feedthrough housing coupled to the side of the canister, rotation of the gearmotor forces the canister to rotate relative to the yoke. Integral to the hardware making up the gearmotor assembly is a non-contact limit switch assembly to prevent travel beyond the +60 / -75 degree range of motion, with hard stops just outside that range to halt motion should the limits fail. A photograph of the gear motor assembly is shown in Figure 8.

A unique feature of this design is the use of the feedthrough shaft to flow the gaseous nitrogen purge into, and out of, the canister; an identical feedthrough is used on the opposite side of the canister to complete the tilt-axis support. Hence, gaseous nitrogen is fed through the hollow feedthrough shaft coupled to the gearmotor, and exits the opposite side of the canister through the hollow shaft of the second feedthrough. By porting the gas on the rotation axis, a stiff, and possibly complex, gaseous take-up system has been avoided. Additionally, the stiffness of such a system would certainly reduce the available torque margin that exists with the current gearmotor, or possibly, force the use of a large motor, which would require more space in the canister. Space within that region of the canister is limited.

Camera roll drive motor

Inside the canister, the photogrammetry camera, an INCA3 model from Geodetic Systems, Inc., is mounted on a rotation stage that allows roll motion of the camera about the camera’s optical axis. The 90 degree range of motion allows an image to be composed in both landscape and portrait formats, which facilitates correction for subtle scale and distortion errors induced by less-than-perfect optics. Motion is achieved by a gearmotor that uses the same major components as the tilt-axis drive, i.e. the same stepper motor and the same harmonic drive gearhead. In this configuration the motor and gearhead flank the faces of the bulkhead plate in the canister with the gearhead mounted on the forward face and the camera mounted to a bracket that attaches directly to the gearhead. Optical limit switches set the range of motion and cushioned hard stops preclude over travel in the event a switch fails. A photograph of the camera roll mechanism is shown in Figure 9.

Mechanism drive electronics

To minimize the number of cables penetrating the chamber wall, and the size of cable wraps through the system, a scheme was devised whereby the drive electronics and the telemetry electronics are housed in the canister. The exception is the boom drive motor. For the boom drive motor the drive electronics are located in the control rack outside Chamber A. Hence, only power and Ethernet traverse the span from the boom drive to the canister.

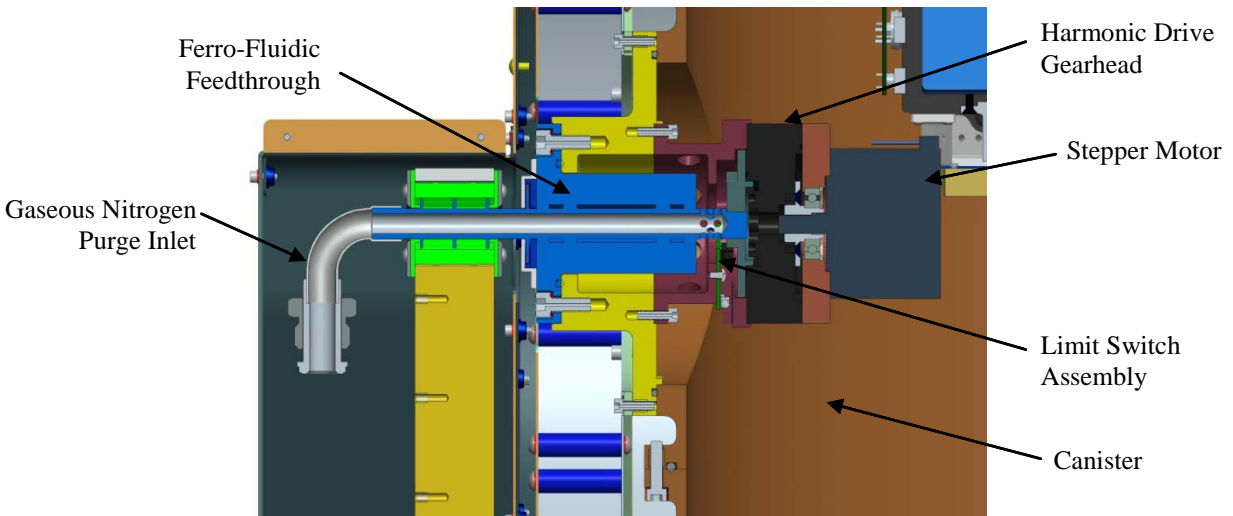

Figure 7 Detailed section view showing the components that make up the tilt-axis drive mechanism



Figure 8 Photograph of the tilt-axis gearmotor assembly

The canister electronics consist of three All Motion EZHR-23 motor drivers and two custom printed circuit boards: one for power distribution and data handling, and one for diode and thermistor readout. These electronics are neatly packaged on the back side of the bulkhead plate internal to the canister. The camera, and the two boards communicate with each other, and the outside world, via the Ethernet protocol. The motor drivers, one for each motion axis, receive power and RS485 bus commands from the power distribution board. The power distribution board acts as a portal for all data communication to the photogrammetry control computer.

System software

The control software and database employ a “distributed” hardware and software model. In the case of the hardware: the electronic subsystems between camera/boom assemblies only share power supplies and Ethernet connectivity, and are not reliant on one another for control signal interconnectivity. For the software: commands and telemetry are stored in a

SQL Server database that resides on a server computer located in the electronics rack. Each electronic subsystem only interacts with the database and is therefore, to an extent, autonomous.

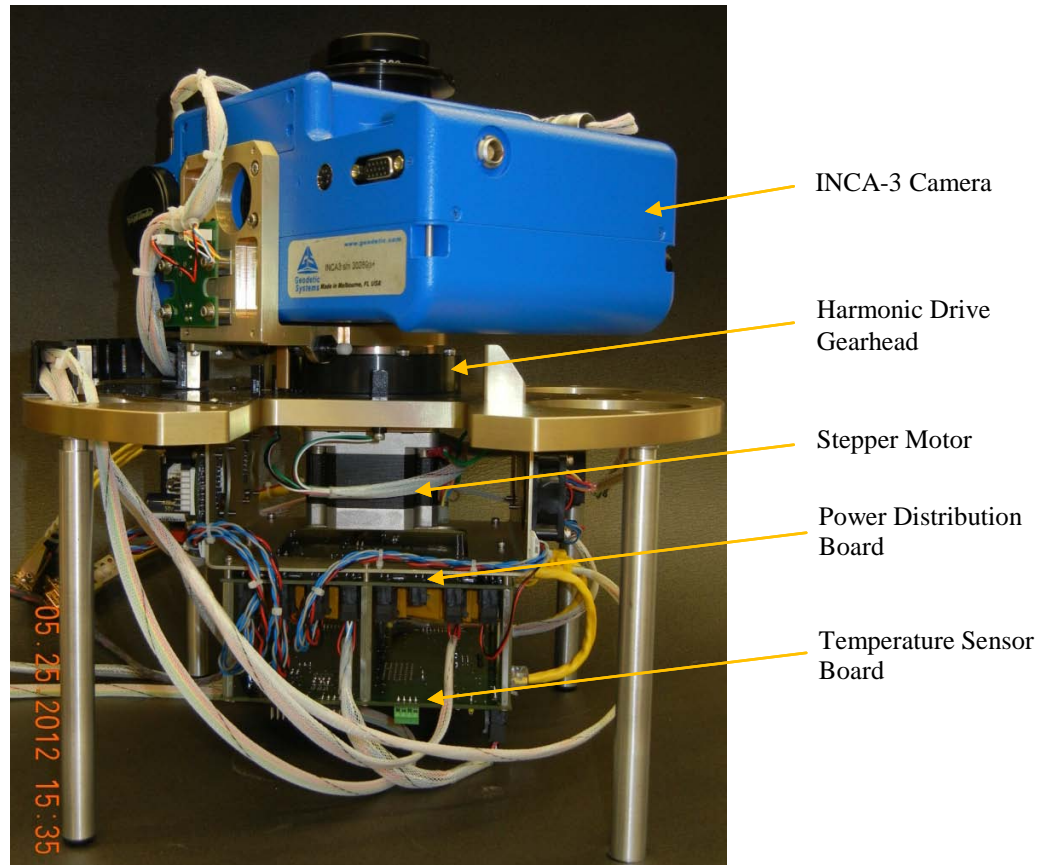

Figure 9 Photograph showing the camera roll mechanism assembly. The drive and telemetry electronics are seen prominently below the motor.

WINDOW DESIGN

The photogrammetry system uses a commercial off-the-shelf camera designed for room temperature and atmospheric pressure. A pressure tight and insulated canister contains the camera in the cryogenic vacuum chamber with room temperature nitrogen flowing into the canister from outside the chamber. Optical windows give a view for the camera lens and the flash. However, the windows must be engineered carefully because the JWST is designed to be as sensitive to light collecting and detecting as technically possible. Infrared light from a window of a room temperature source easily saturates the detectors. Furthermore, heat flows easily between the camera environment and the unit under test with the over 240 K difference in temperature.

These effects can be effectively negated by pointing the camera windows towards the shroud walls during JWST detection operations and during tests requiring to operation at the coldest temperatures. However, the risk remains where a mechanism failure prevents deliberate safe-pointing of the windows.

Specifically the window needs to pass the visible spectrum light of the flash while blocking the infrared light of the warm internal canister environment. Figure 10 illustrates the flash spectrum and the radiation spectrum of a 291 K black body. For the cryogenic vacuum test, the MIRI selects the 5.6 ± 0.6 micrometer wavelength filter with the passband shown in the graph

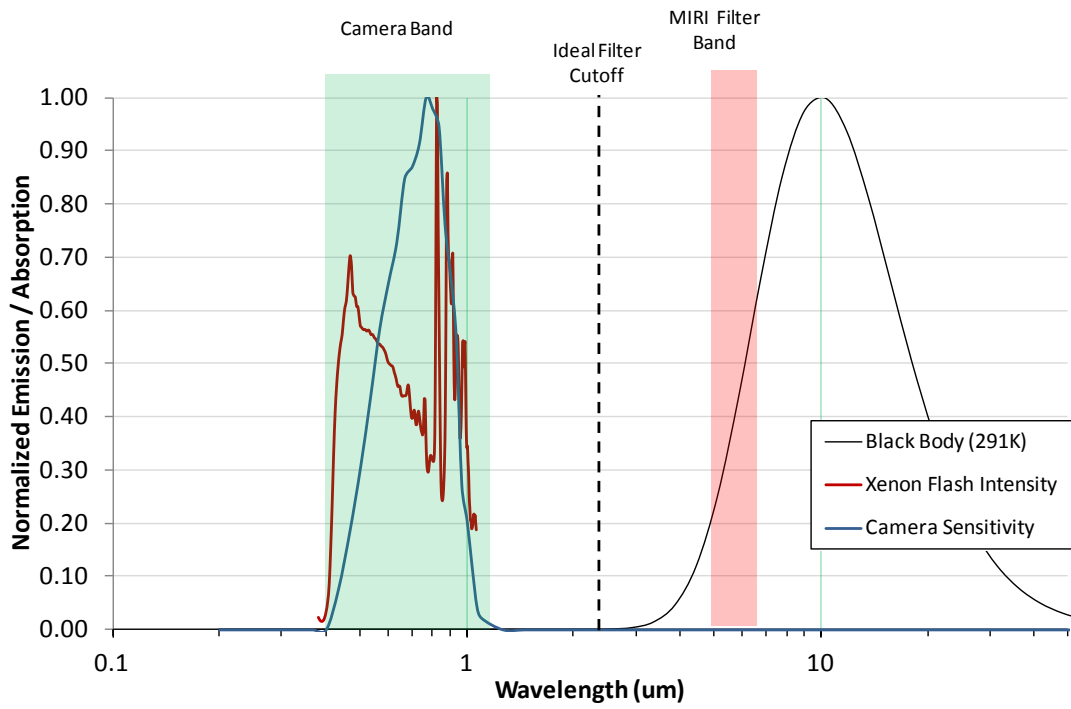

Figure 10 Ideal cutoff between PG spectra and heat radiation.

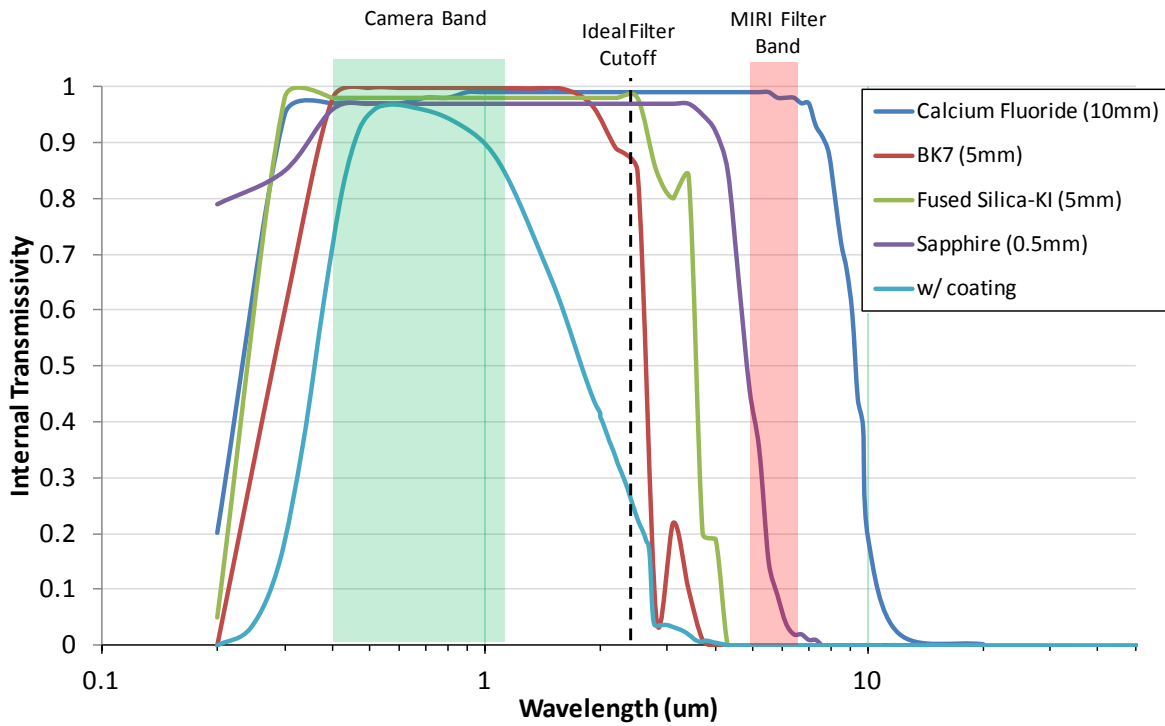

Figure 11 Comparison of window material transmission properties and reflective coating transmission.

22 CFR 125.4(b)(13) applicable

Given the window must be cold to prevent radiation of mid-infrared light, the window must be non-conductive with the internal warm environment of the canister. Therefore, two windows are required – a cold conductively-isolated outer window and an inner window to provide the pressure interface between the vacuum side and the atmosphere side. A combination of window material and interferometric coatings achieves the desired cutoff characteristics. Figure 11 shows the intrinsic spectrum transmission limit of BK7 with commercially available standard coatings as the best solution. In addition, the poor thermal conduction of BK7 prevents any heat absorption from propagating significantly into the outer window..

Figure 12 diagrams the window configuration. Anti-reflective coatings boost the visible transmission. A thermal model predicts a thermal emission under 1 milliwatt. The predicted emission in the MIRI pass band is less than 1 microwatt. And the measured transmission of a coated prototype is greater than 85% for the camera band.

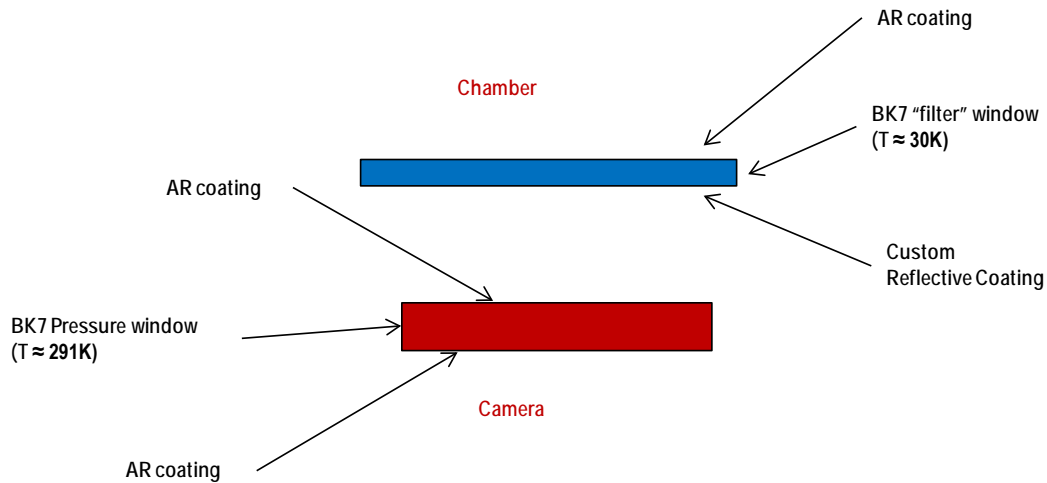

Figure 12 Diagram of window configuration.

FLASH IMPROVEMENTS AND TEST

Three important goals were identified in the flash design for JSC photogrammetry:

1. The flash must have sufficient intensity to overcome the 30% window transmission loss and yet still illuminate targets at up to 15 m distance.
2. The flash must have an expected lifetime that exceeds the anticipated 100k firings required for the entire test regimen.
3. Finally, in the event of a flash failure or the desire to prophylactically renew the flash, it must be possible to replace the unit without removing the camera canister from its boom support.

The INCA3 photogrammetry camera views targets through a series of two windows: a pressure window followed by a cold window. The targets are illuminated by a flash that acts through a similar serial set of windows. The flash must have adequate intensity to pass through two windows, illuminate a target up to 15m distance from the camera, and then return via two additional windows to the camera itself. Transmission through the windows is expected to be on order of 70%.

Qualification of the Nikon SB800 flash

The initial flash testing was concerned with the flash intensity itself. The flash assembly used for PG at the SES chamber at Goddard was a repackaged Nikon SB800 flash-head. This assembly was identified and qualified by Geodetic Systems Inc., the designer and manufacturer of the INCA3 PG camera. Based on the Goddard system, the initial JSC flash design used a similar repackaged Nikon SB800 unit. The Nikon-based flash-head is shown in Figure 13.



Figure 13 Repackaged Nikon-Derived Flash Head

Northrup Grumman, the JWST prime contractor, conducted a test in early 2008 to qualify the Nikon-derived flash-head. A neutral density filter was incorporated into the flash-head to simulate the 70% total transmission of the expected canister windows and coatings. The flash-head was driven by an INCA3 camera and targets were successfully illuminated at distances of 15m. Successful illumination was defined as a pixel light saturation value of greater than 200 (an INCA3 parameter) over the entire 3 to 15m expected target range. The Northrup Grumman test concluded that the Nikon-derived flash-head offered adequate power and adjustability to cover the entirety of PG needs at JSC.

Flash development and testing for JSC

The photogrammetry tests anticipated for Johnson will require a minimum of 100k flashes per unit - considerably more than the Goddard testing, estimated at 79k cycles per unit. After installation, the PG canisters will be extremely difficult to access within JSC chamber A, making flash-head renewal an awkward and expensive proposition. With this motivation, an effort was mounted to quantify the lifetime of the Nikon SB800 -derived flash-head prior to committing it to JSC service.

A test box was built using two INCA3 flash driver boards to conduct parallel testing of two flash heads. A photoelectric peak detector determined whether or not a flash occurred and provided a relative measurement of flash intensity. See Figure 14.

Flash power was set to a level of "16" (an internal Inca3 flash power parameter). The power level was chosen as slightly greater than the level "15" that the early Northrup Grumman testing determined to be adequate for all JSC photogrammetry needs. In keeping with the most rapid firing frequency anticipated at JSC, the flash drivers were programmed to fire each flash once every 10 seconds, staggered to avoid simultaneous firing of the two flashes. The test was designed to cycle the flashes until failure; in the absence of catastrophic failure, flash tube failure was defined in either one of two ways. The first failure mode consists of a 33% reduction in flash intensity (relative to a new tube). The second failure mode was defined as a 10% misfire rate, i.e. the tube fails to fire when commanded to do so 10% of the time.

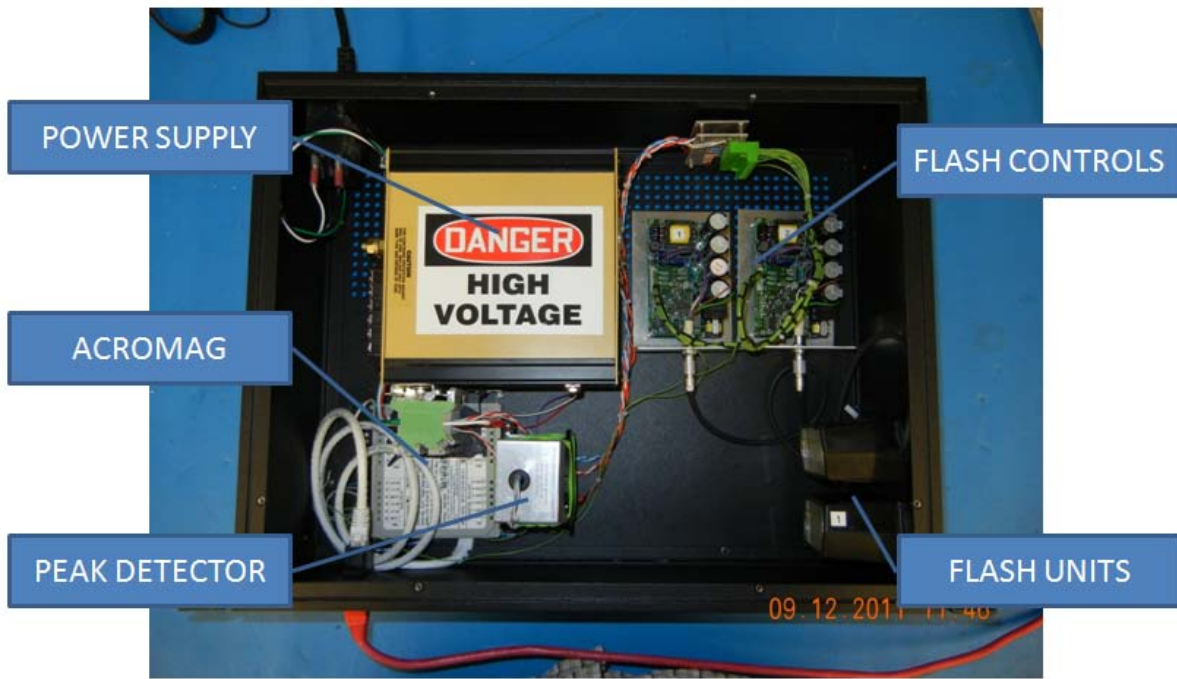

Figure 14 Flash Lifetime Test Assembly

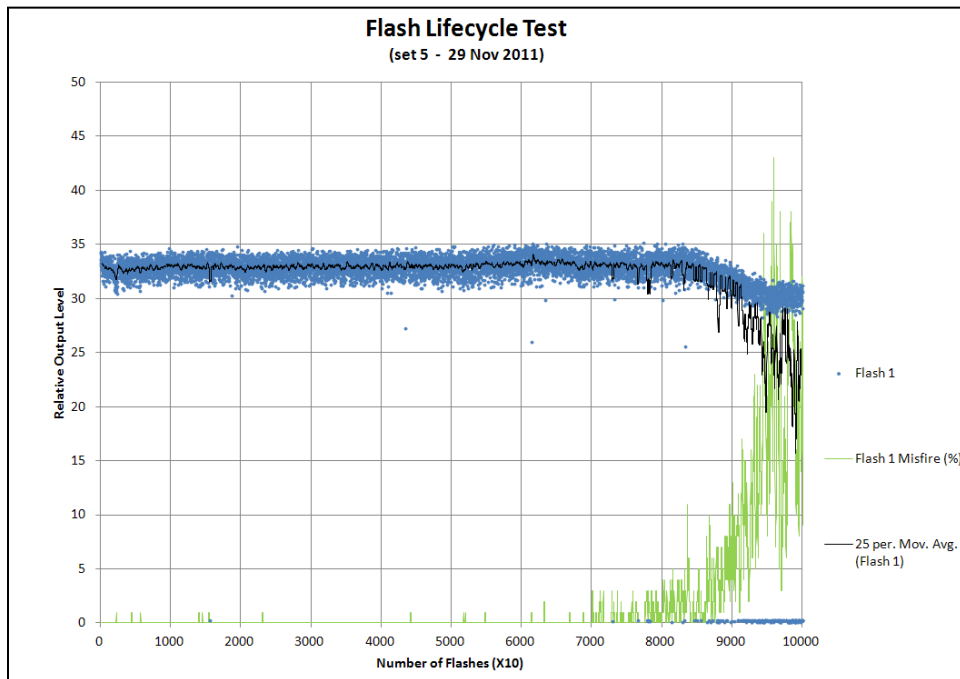

Figure 15 Nikon SB800-Derived Flash Lifetime

22 CFR 125.4(b)(13) applicable

Six Nikon flash lamps were tested: one lamp failed prematurely (5.3k cycles), one lamp suffered no degradation well past 100k cycles. Discarding the two outliers, the average lifetime of the remaining four Nikon-derived lamps, repackaged as in Figure 13, was determined to be 64k cycles. In each test, the 10% misfire rate criterion, rather than the degradation of flash intensity, determined tube failure. A chart showing the test progression of one of the lamps is presented below as Figure 15. Both relative light output and misfire rate, calculated on a moving average basis, are read on the ordinate axis.

The Nikon SB800 flash uses a xenon flash tube with a borosilicate envelope. During lifetime testing, small fissures and discoloration began to appear in the lamp envelope prior to failure. Figure 16 is a photograph of the flash tube charted above. The photograph details one end of the tube (electrode seen on the left) after 100k cycles and well after the lamp had surpassed the 10% misfire rate failure criterion.

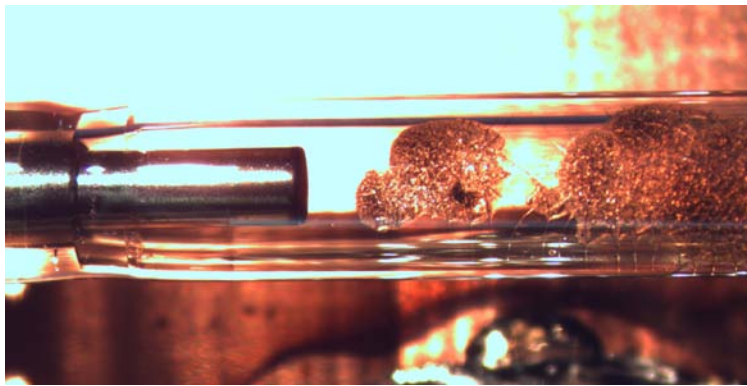

Figure 16 Nikon Tube at 100k cycles

The tested 64k cycle lifetime of the Nikon-derived flash head is inadequate for the JSC photogrammetry effort. Input from two custom flash lamp manufacturers suggested that quartz rather than borosilicate should be used for a long-life flash envelope. In addition, several lifetime tests were conducted on naked lamps, i.e. lamps removed from their housing. The naked lamps exhibited lifetimes from 90k to in excess of 100k cycles. They significantly outlasted the housed lamps and led to the conclusion that improved cooling should be one focus of a redesigned flash-head. Moving forward, a contract was awarded to Amglo Kemlite Laboratories, a flash lamp manufacturer, to develop a quartz-envelope flash lamp with a suitable footprint. Secondly, the flash-head was redesigned to include active cooling of the lamp.

Figure 17 shows the flash-head as redesigned to incorporate a fan to pull air directly past the flash tube. Note the designated cooling air path in the figure. Figure 18 shows the redesigned housing during fit check.

Throughout the development cycle of the quartz envelope flash lamp, the newly redesigned actively cooled housing was employed to further lifetime test the Nikon borosilicate lamps. The intent was to quantify the affect of the housing redesign. While the time available dictated that only two tests were conducted, the results were very encouraging in that an average lifetime of 165k cycles was observed. (Failure was, again, determined by the 10% misfire criterion.)

The newly designed quartz-envelope lamps are currently under test. One of the lamps is shown in Figure 19. To date, one lamp has surpassed 150k cycles with negligible misfires and a total degradation in relative light output of 6.5%. Testing will ultimately include both lifetime testing and photometric testing to guarantee that their light output is comparable to the already-qualified Nikon units. Between the actively cooled housing and the quartz-envelope flash tubes, it is hoped that a lifetime exceeding 200k cycles, 2X margin on the JSC photogrammetry needs will be achieved.

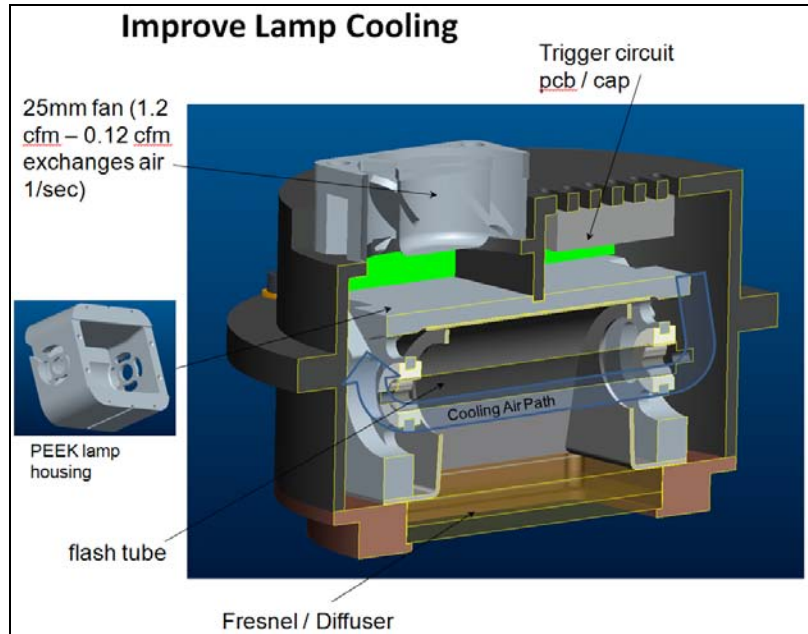

Figure 17 Cross-Section of Actively Cooled Flash-Head

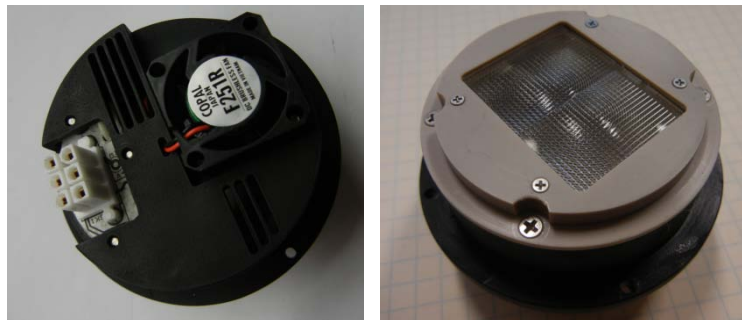

Figure 18 Realization of Actively Cooled Flash-Head



Figure 19 Custom Quartz Envelope Flash Lamp

22 CFR 125.4(b)(13) applicable

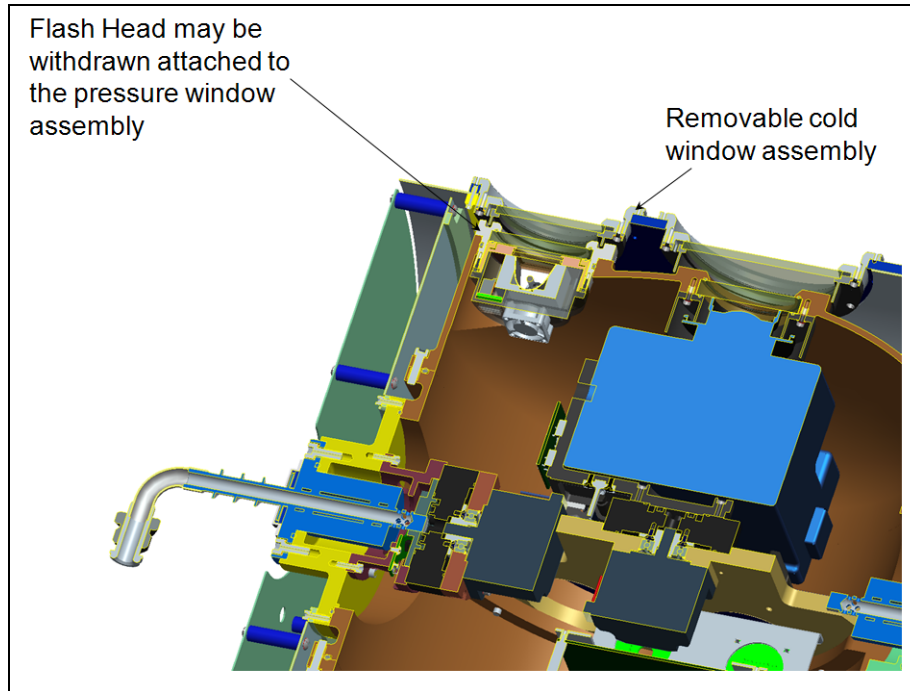

Figure 20 Cross Section of PG Canister and Demountable Flash-Head Implementation

Flash head replacement

While the ideal is that the flash-heads in the JSC testing will not have to be changed, the value of a mechanical design that allows in-situ renewal of the flash assembly was made apparent by the challenges faced in achieving adequate flash lifetimes. Therefore the PG canister was designed to allow the replacement of the flash-head from outside the canister. The intent is that the flash-head can be renewed while the canister is mounted to its transport boom within JSC chamber A, approximately forty feet above the chamber floor.

Figure 20 shows a cross-section of the canister with the new, actively cooled flash-head. Note that the cold window may be demounted from outside the assembly. The flash-head itself is integrated into the pressure window assembly. Electrical contacts are made through a blind-mate interface on the interior portion of the assembly. Upon removal of the cold window, the flash-head / pressure window assembly may be withdrawn through the void left by the cold window. A new flash-head assembly may then be installed. Again, the demountable mechanical design has been implemented as a form of insurance. The primary goal is that the lifetime of the flash-head assembly, actively cooled and with a quartz-enveloped tube, exceeds the number of flashes required to complete the JSC photogrammetry testing.

SUMMARY

A photogrammetry system within a cryogenic vacuum chamber has been designed and is currently in build with 11-foot radius booms, a pan range of +/- 60 degrees, and a tilt range of +60 / - 75 degrees; to survey the large Optical Telescope Element – Integrated Science Instrument Module (OTIS) of the JWST. The camera and flash windows have been engineered to reduce the heat flow under 1 milliwatt and infrared radiation under 1 microwatt. The flash bulb and cooling method has improved the average life of the flash from 64k cycles to 165k cycles to span the length of the testing planned for the OTIS with a more convenient replacement backup strategy.

ACKNOWLEDGEMENTS

The PG system design was supported by the JWST contract NNG11FD64C with NASA GSFC. The JWST system is a collaborative effort involving NASA, ESA, CSA, the Astronomy community and numerous principal investigators. Geometrical requirements, flash number and intensity requirements were developed with Northrop Grumman Aerospace Systems, the prime contractor for JWST.



JWST's Cryogenic Position Metrology System

Tony L. Whitman, Randolph P. Hammond, Joe Orndorff,
Stephen Hope, Stephen A. Smee, Thomas Scorse,
Keith A. Havey, Jr
SPIE 8442 – 91
July 6, 2012



Agenda

- Introduction
- Motion Design
- Window Design
- Flash Improvements





Cryogenic Optical Test Configuration of JWST



Photogrammetry
• 4 camera windmills
• Targets and codes
• Scale Bars

• Absolute Distance Meter

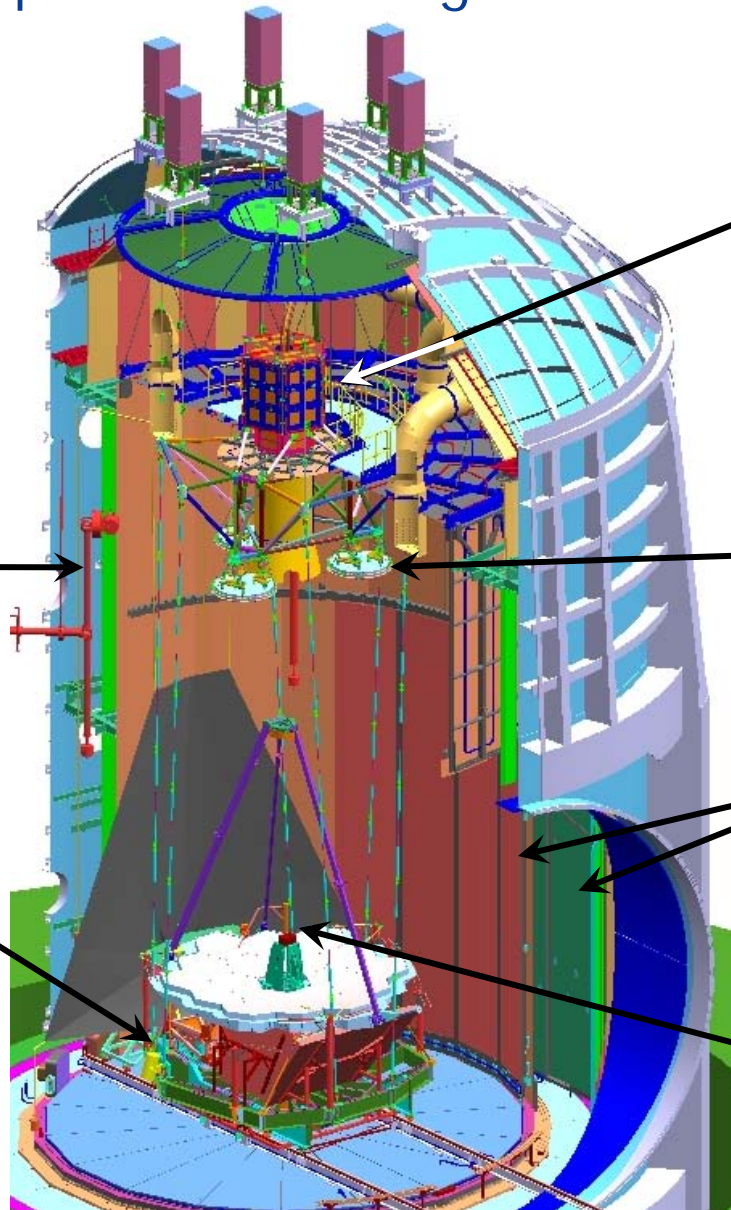

Center of Curvature Optical Assembly (COCOA)
• Interferometer, null, calibration equipment
• Coarse/fine PM phasing tools
• Displacement Measuring Interferometer

3 Autocollimating Flat Mirrors
• Piston and Tilt actuation

LN2 and Helium Cryogenic Shrouds and "barn door"

Optical Test Point Sources at intermediate telescope focus

Camera Windmill Configuration

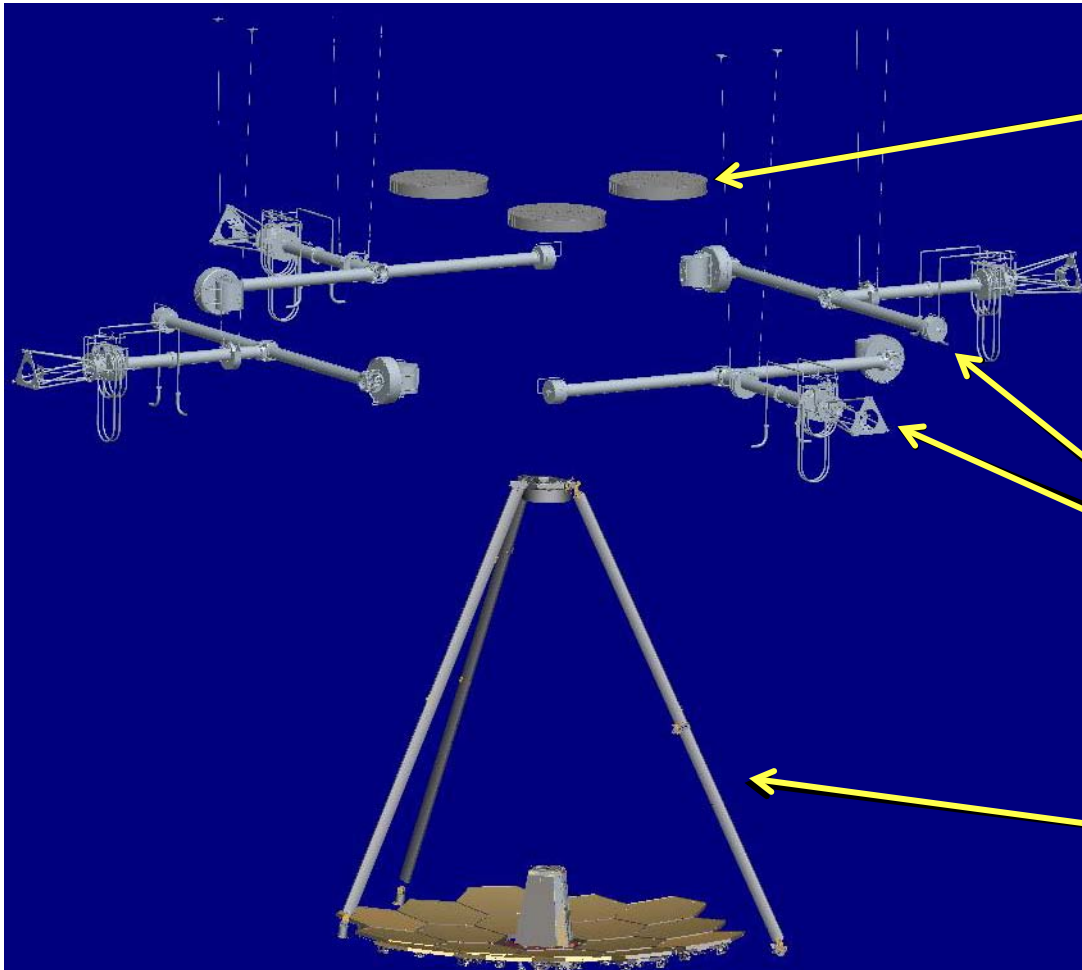

3 Flat mirrors for auto-collimation

4 Windmills Each with 1 Camera inside canister at end of 3.4 m radius boom

JWST

Windmill Assembly

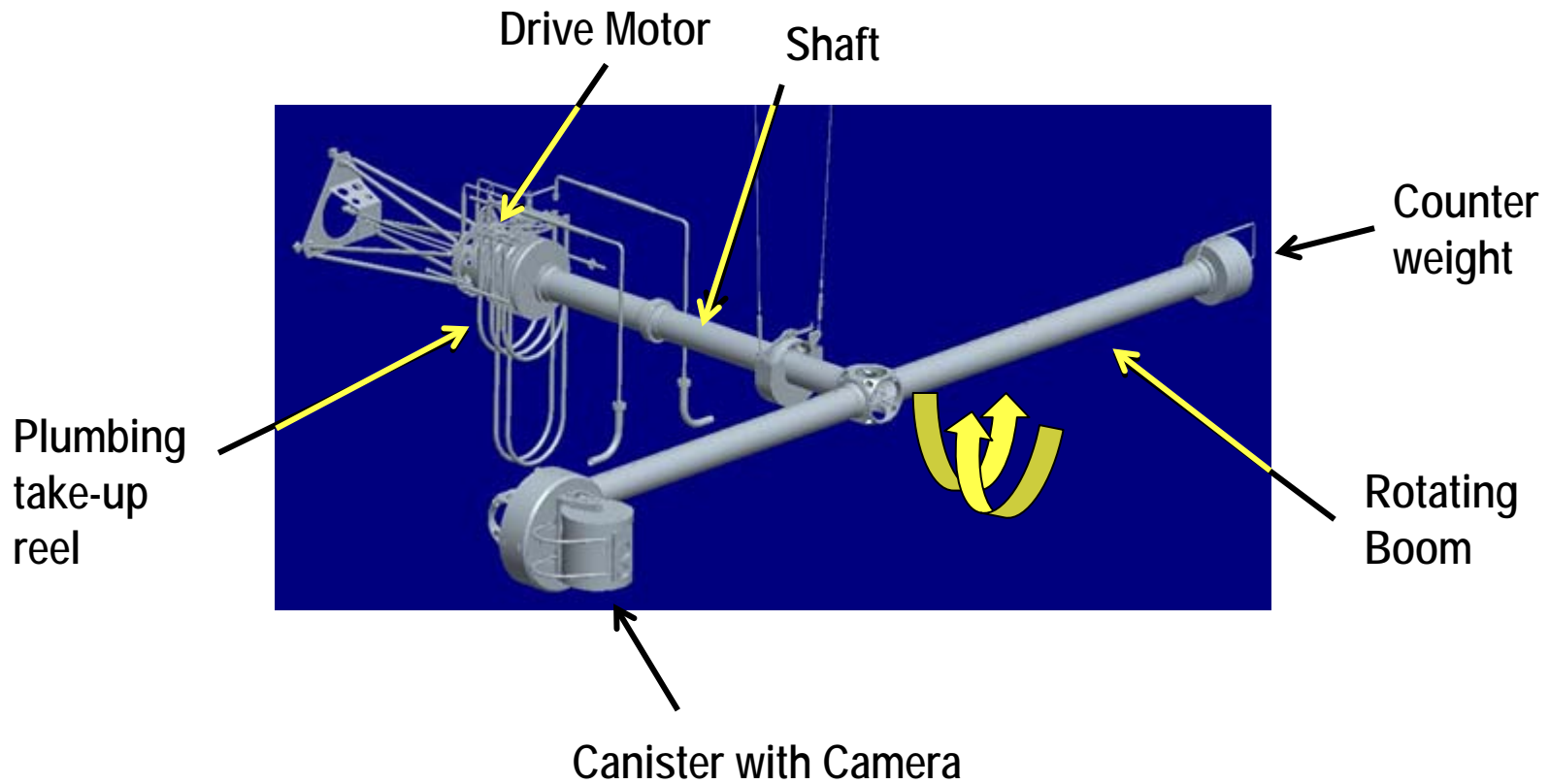



Relation to Cryogenic Walls

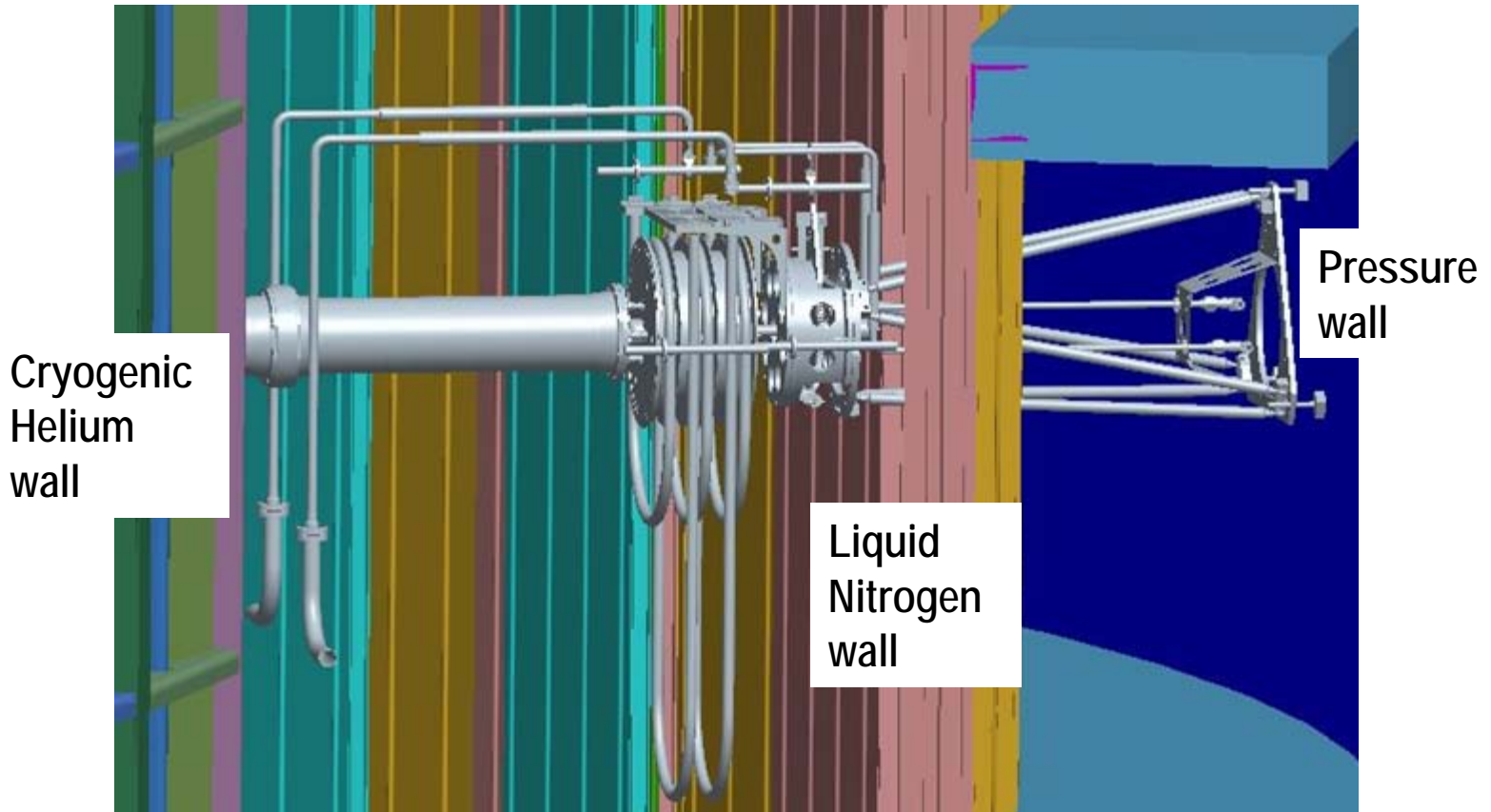

Boom Drive Gear Motor

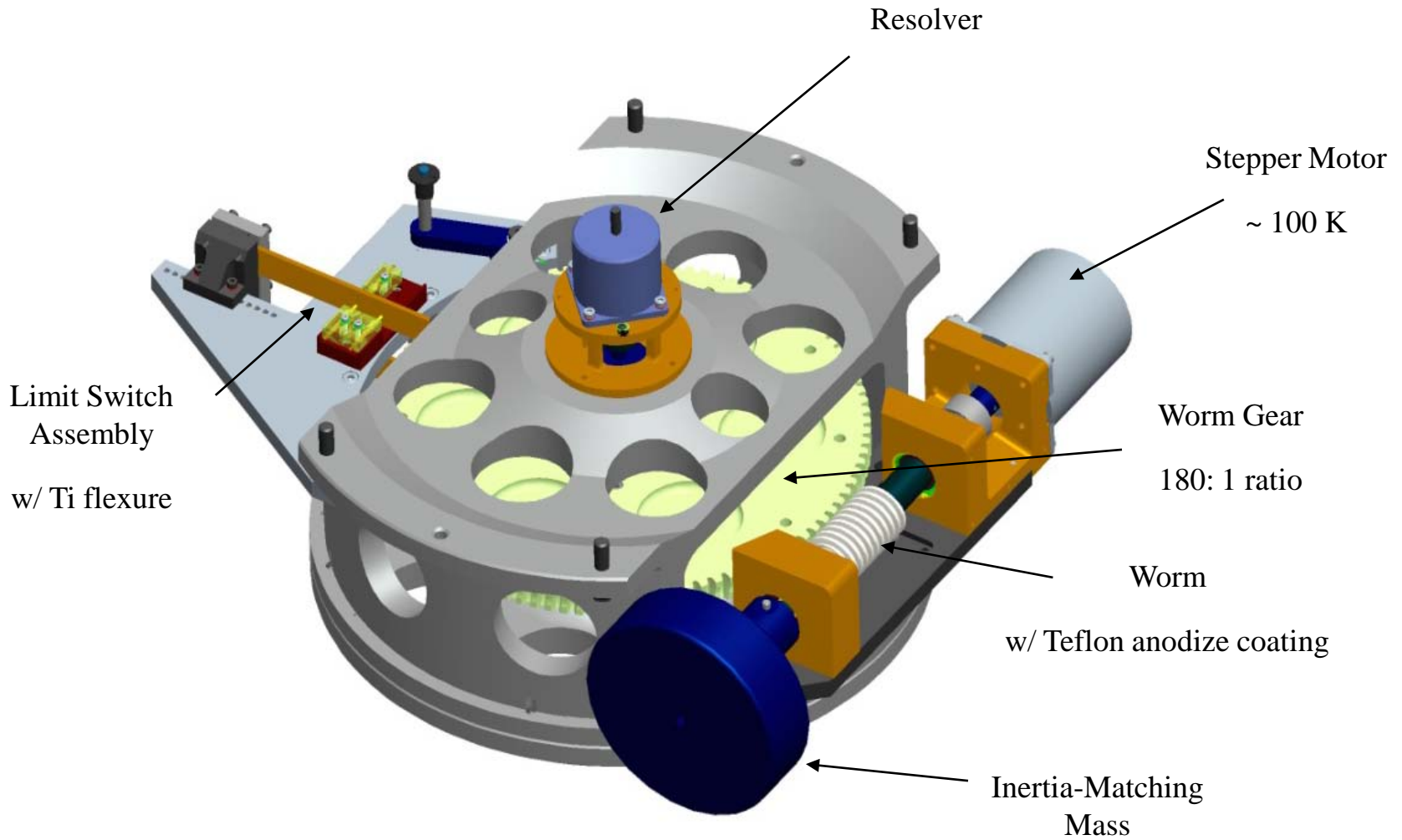

Canister Motions

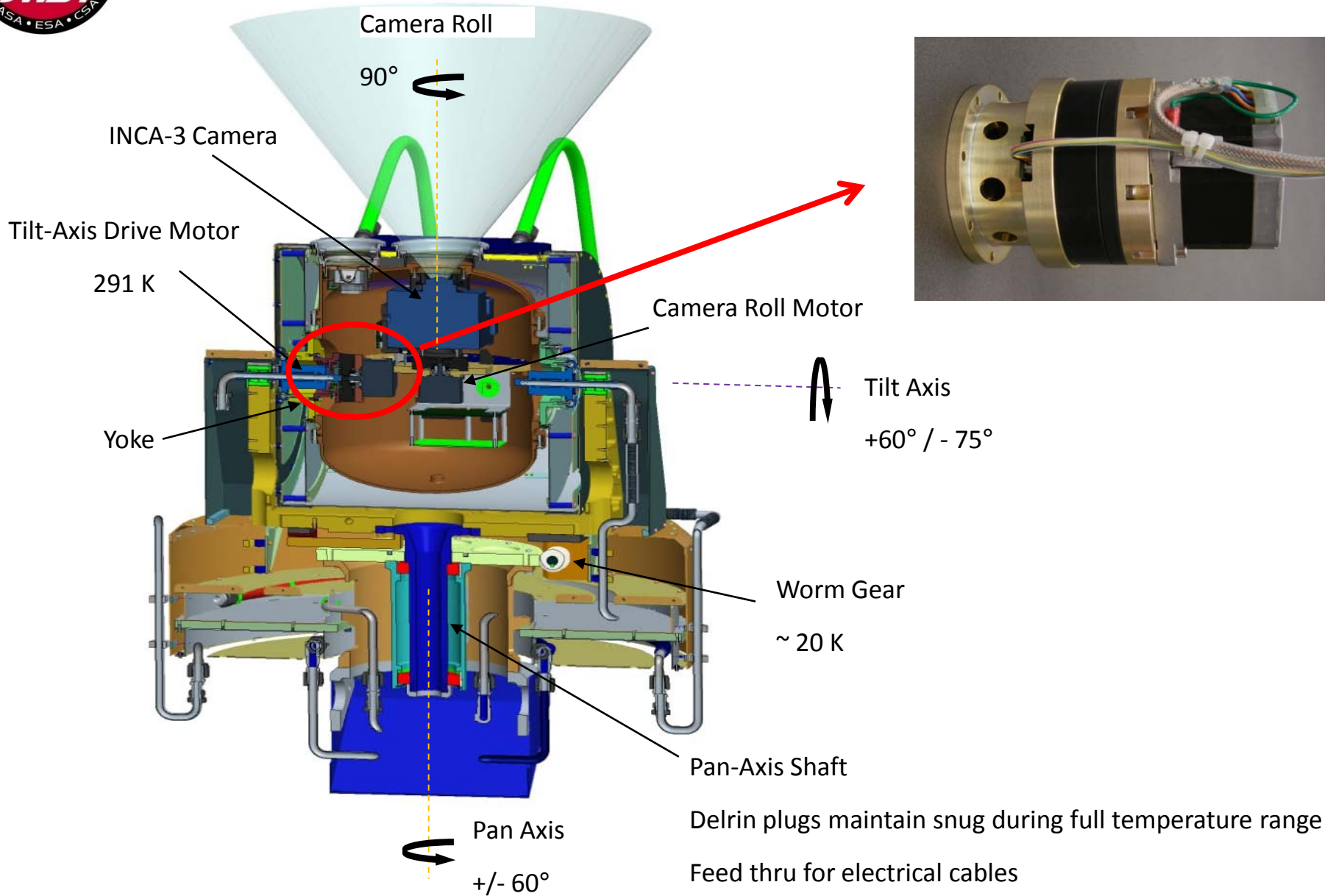

Tilt Drive



Ferro-Fluidic Feedthrough

Gaseous Nitrogen Purge Inlet

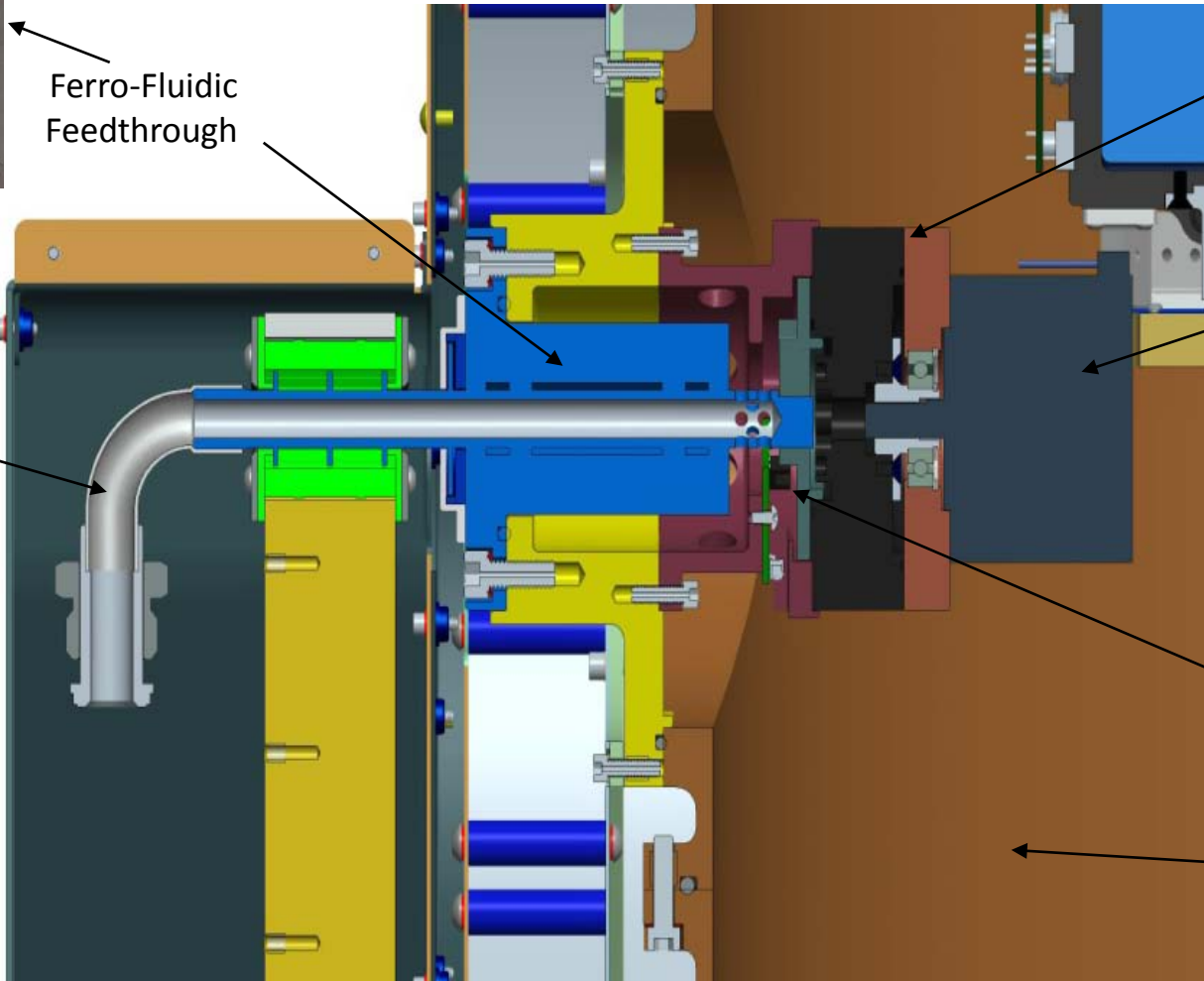

Harmonic Drive Gearhead

Stepper Motor (warm side)

Limit Switch Assembly

Canister

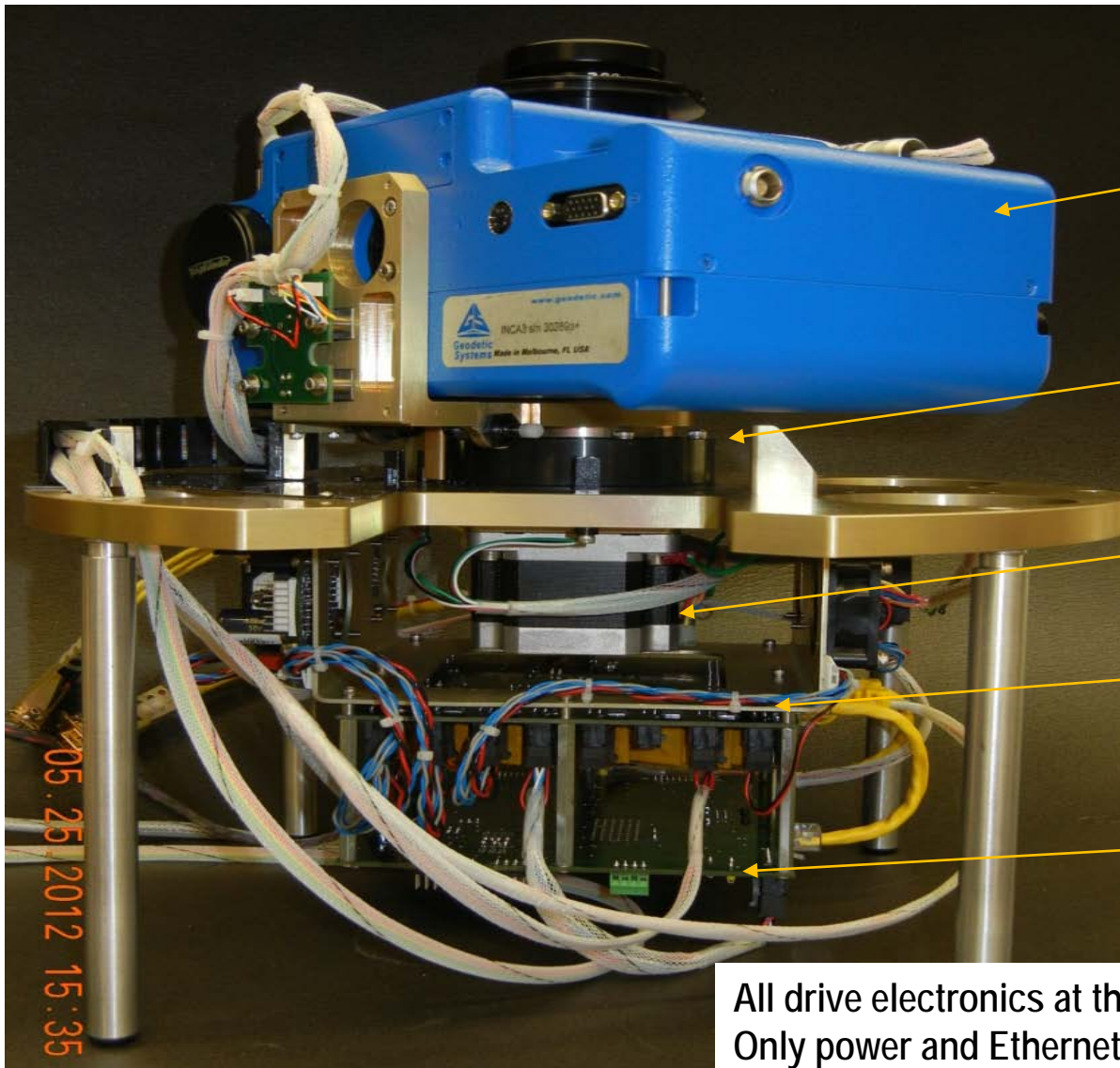

INCA-3 Camera

Harmonic Drive Gearhead

Stepper Motor

Power Distribution and Communication Board

Temperature Sensor Board

All drive electronics at this board level
Only power and Ethernet travel long boom distance



WINDOW DESIGN



Flash and Camera Spectral Ranges

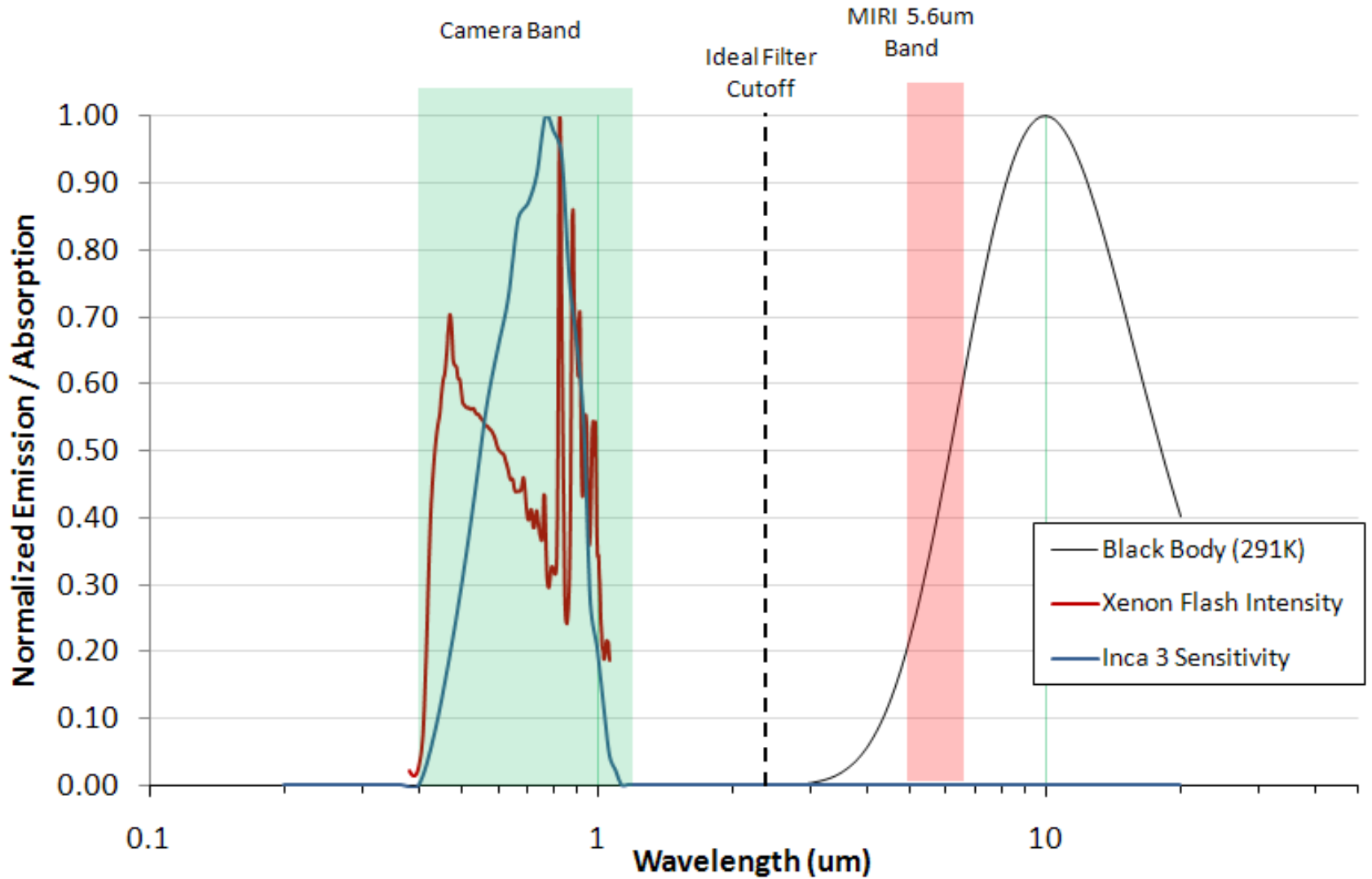



Material / Coatings Internal Transmissivity



- Sapphire and CaF₂ are not very effective FIR filters
- BK7, Fused Silica, and several commercially available optical coatings are effective

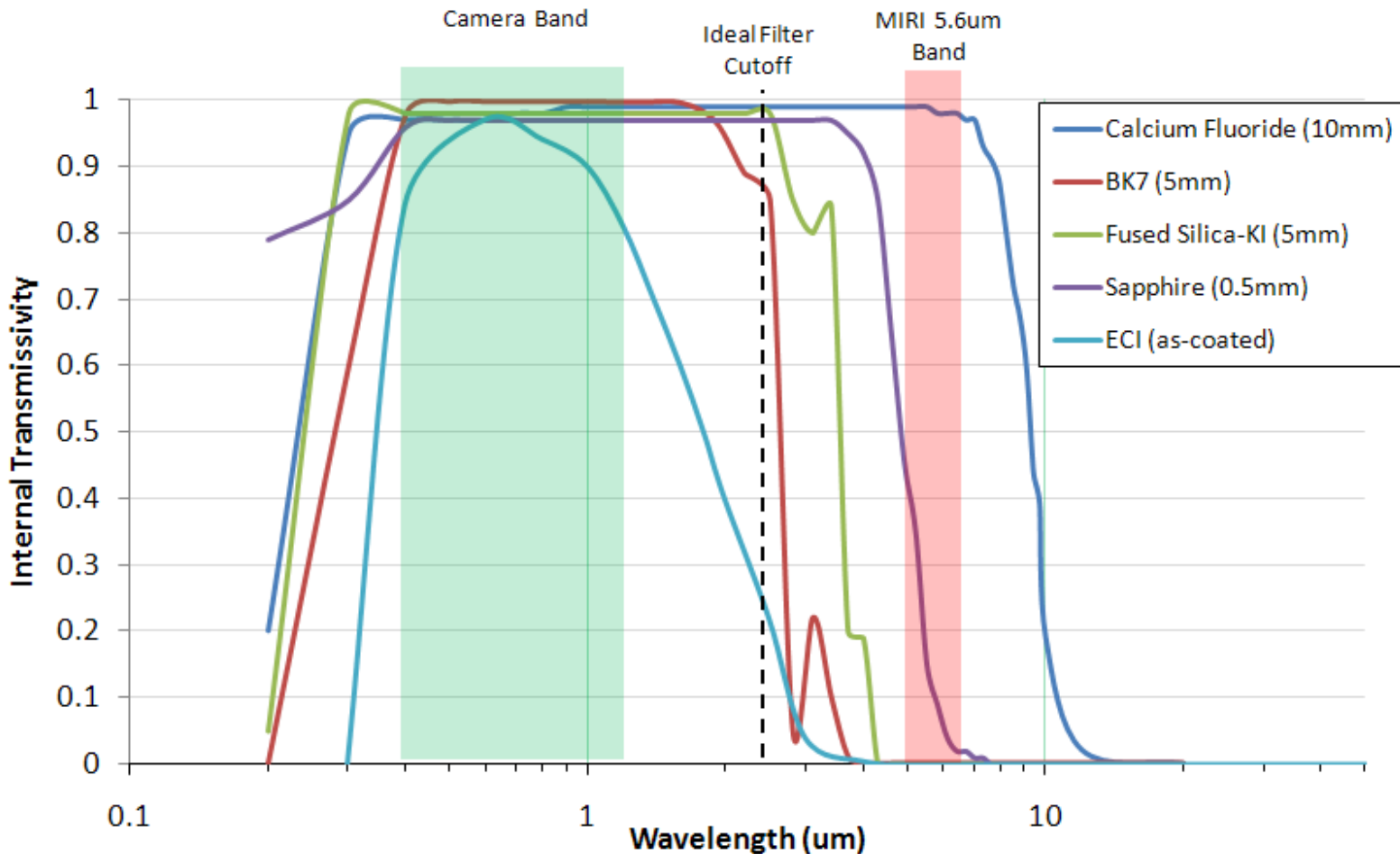

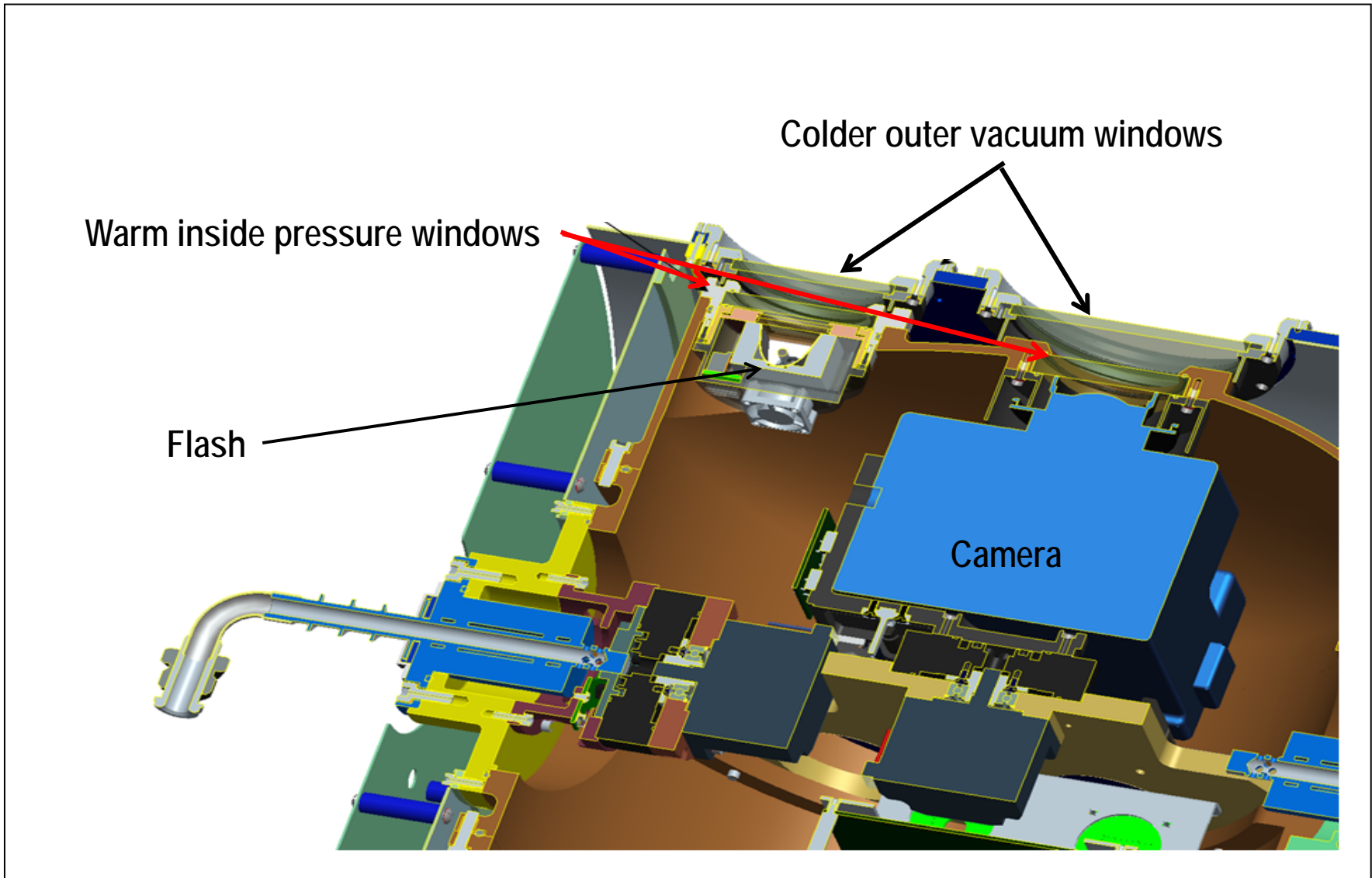



Window Material & Coatings



Chamber

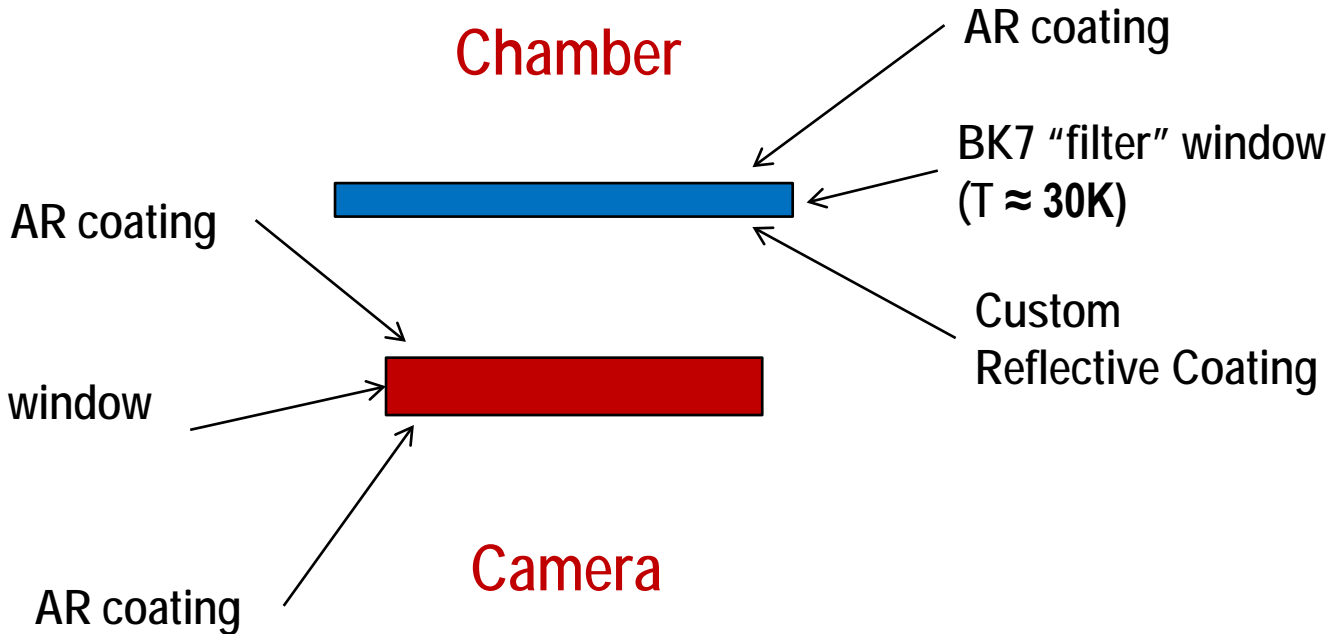

Transmission Stack-Up

BK7 window (w/ 2 sided AR coatings): 0.98

BK7 window (w/ 1 sided AR coating): 0.99

Reflectance / Absorption

Reflective Coating film is 85% reflective at wavelengths > 5μm

BK7 is 100% absorptive at wavelengths > 4μm



Stray Light and Thermal Performance



- Transmission rate above 4 μm for the cold window (BK7 w/ reflective coating) is essentially zero
- A small amount of radiant energy is emitted from the cold window itself
- Stray light emission rate estimates are:
 - NIRCam 0.6-2.3 μm = 0.16 μW
 - NIRCam 2.3-5.0 μm = 5.13 μW
 - MIRI 5-6.2 μm = 0.89 μW
 - MIRI 5-27 μm = 27.01 μW
- Thermal emission rate estimate:
 - Thermal 2-100 μm = 0.64 mW

Compare to 1.1 μW emission requirement

Compare to 6 mW emission requirement



FLASH



Example Flash Performance

100 k flashes planned for JWST Tests

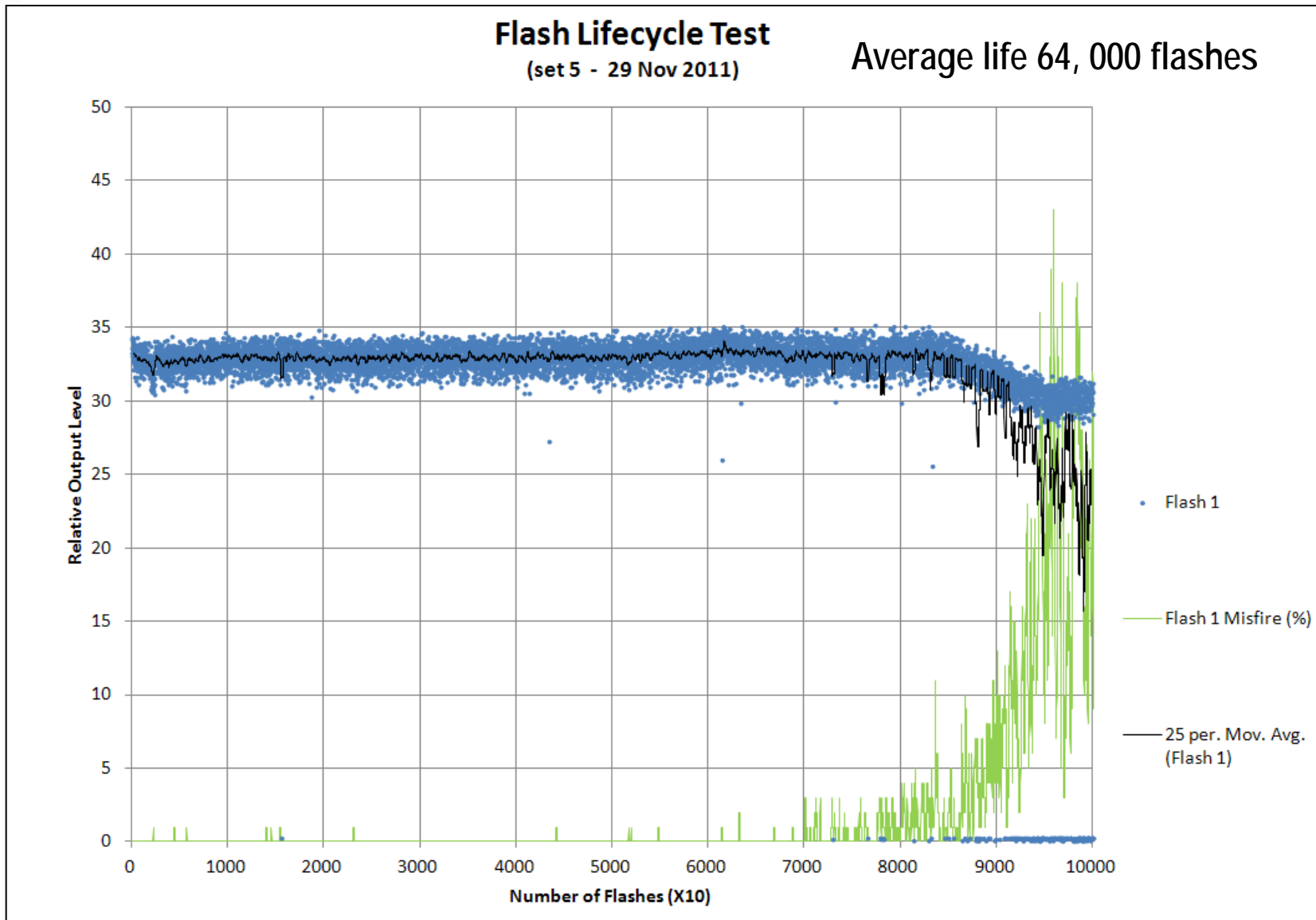



Original Housing and Bulb

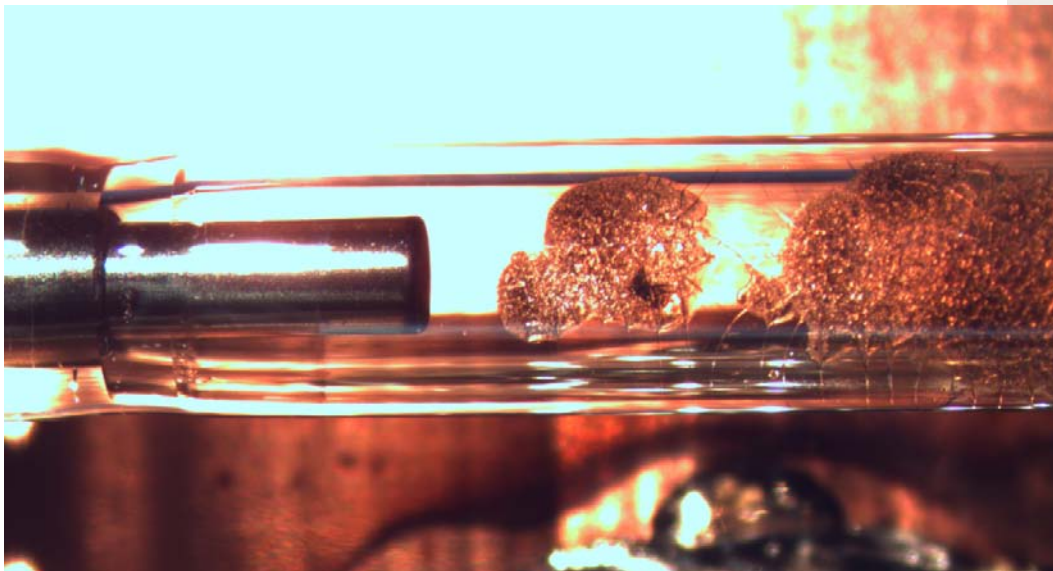

Bulb after 100,000 flashes

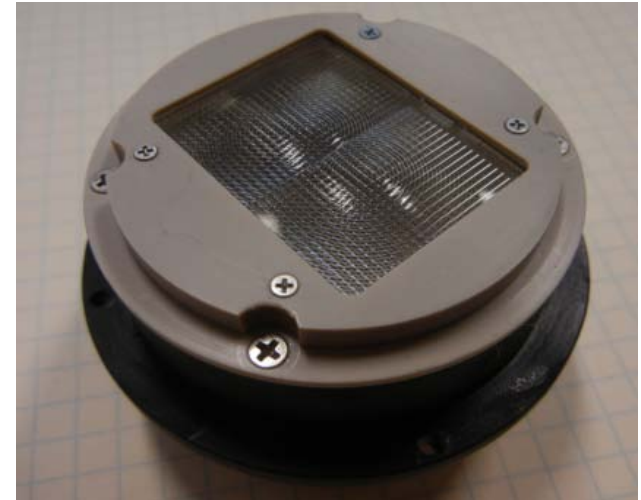
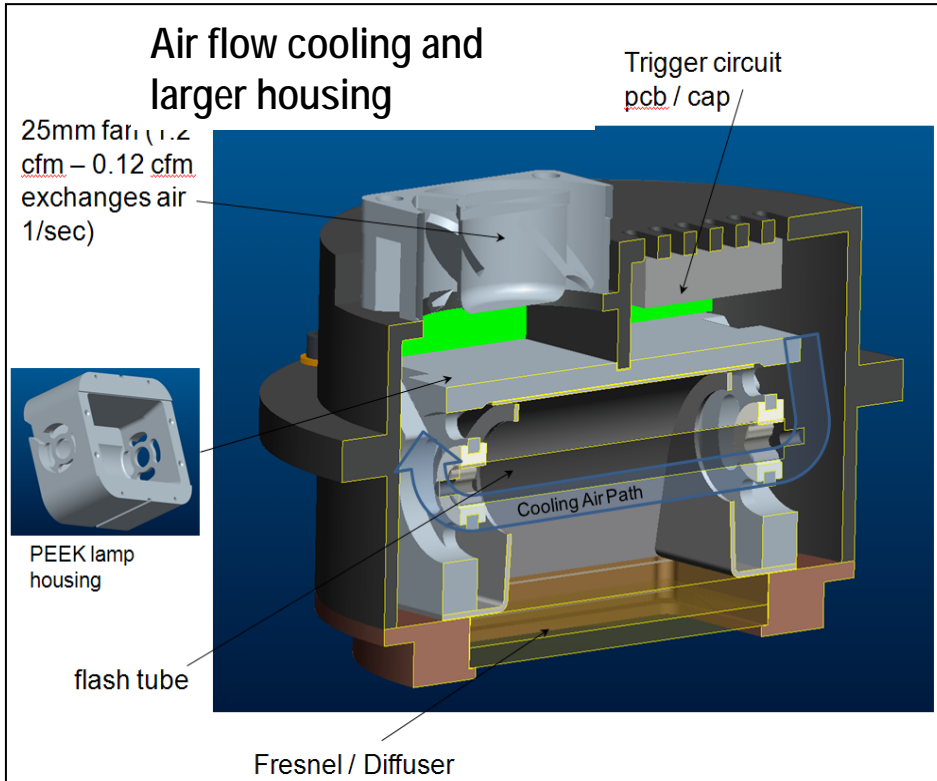

Switch from borosilicate to quartz glass

Improvements currently testing at an average life of 165, 000 flashes

Bulb Replacement

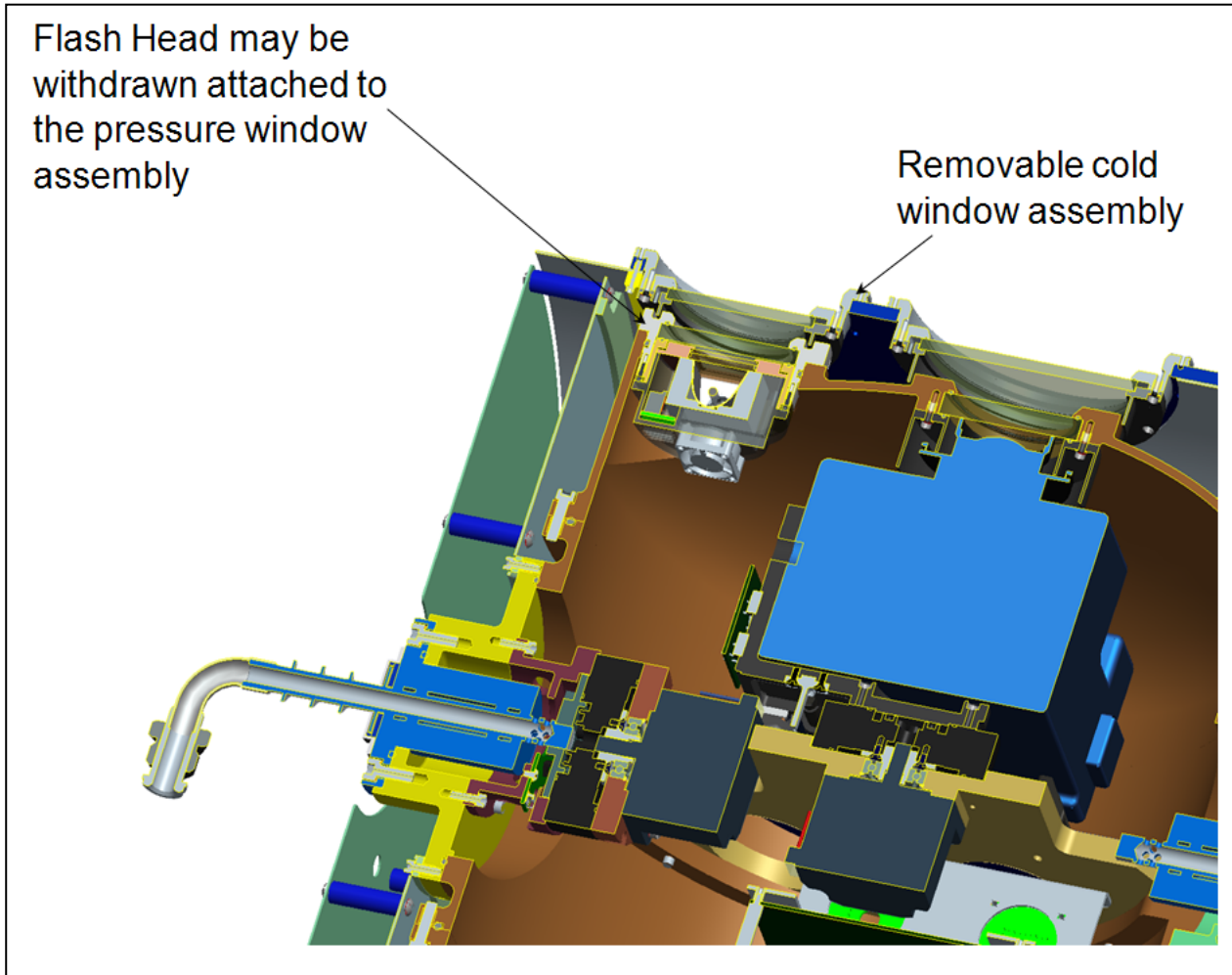

Bulb housing module designed for easy removal from front of canister at 15 meter height



Summary



- **Cryogenic photogrammetry system with**
 - 3.4 m radius windmill boom
 - +/- 60° pan range
 - + 60° / - 75° tilt range
 - 90° camera roll
- **Radiation reduced for sensitive JWST**
 - < 1 milliwatt heat
 - < 1 microwatt within the passband of the MIRI selected filter
- **Flash life increased from 64 k to 165 k flashes**
 - 100 k flashes planned