

Electrostatic Levitation: A Tool to Support Materials Research in Microgravity

Containerless processing represents an important topic for materials research in microgravity. Levitated specimens are free from contact with a container, which permits studies of deeply undercooled melts, and high-temperature, highly reactive materials. Containerless processing provides data for studies of thermophysical properties, phase equilibria, metastable state formation, microstructure formation, undercooling, and nucleation. The European Space Agency (ESA) and the German Aerospace Center (DLR) jointly developed an electromagnetic levitator facility (MSL-EML) for containerless materials processing in space. The electrostatic levitator (ESL) facility at the Marshall Space Flight Center provides support for the development of containerless processing studies for the ISS. Apparatus and techniques have been developed to use the ESL to provide data for phase diagram determination, creep resistance, emissivity, specific heat, density/thermal expansion, viscosity, surface tension and triggered nucleation of melts. The capabilities and results from selected ESL-based characterization studies performed at NASA's Marshall Space Flight Center will be presented.

Electrostatic Levitation: A Tool to Support Materials Research in Microgravity

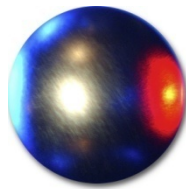

**Jan Rogers and Mike SanSoucie
NASA/MSFC/EM50, Huntsville, AL**

2012 TMS Annual Meeting, Orlando, FL
March 12, 2012

Electrostatic Levitation (ESL) Team

- MSFC ESL Team:
 - Dr. Jan Rogers, EM50
 - Mike SanSoucie, EM50
 - Trudy Allen, Info Pro
 - Glenn Fountain and Curtis Bahr, Qualis
 - Bill Witherow, EV43

Containerless Processing

- Levitation
- Force positions and manipulates sample
- No contact with container
- Ground based systems for several methods including:
 - Electrostatic
 - Electromagnetic
 - Acoustic
 - Aerodynamic
 - Other

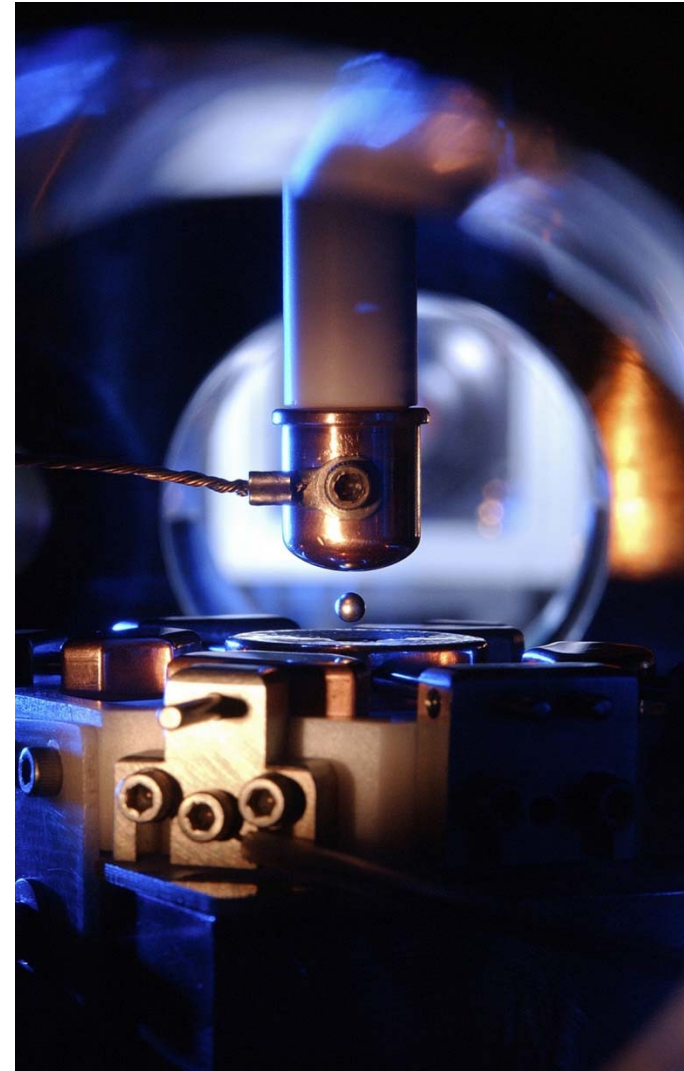

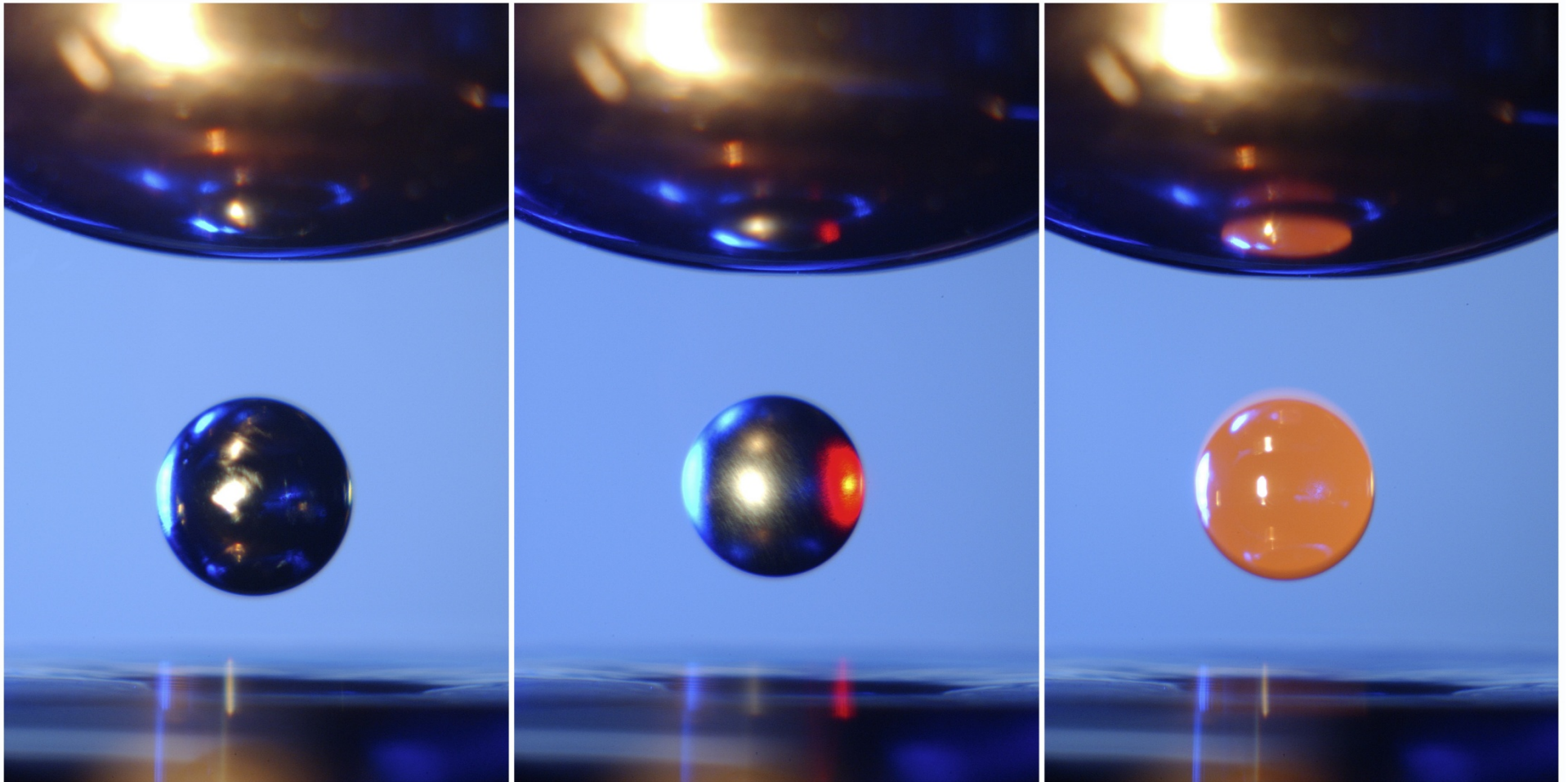

- ESL provides an ideal, containerless method for the study of undercooled melts and metastable states.
- Levitated samples do not contact a container and will not be contaminated by the container or react with it.
- Pyrometry, or non-contact temperature measurements employed in ESL.
- ESL provides a ground-based system to study levitated specimens to complement space-based levitation studies. (ESA's electromagnetic levitator cannot process samples in 1-g)

Outline

- Introduction
- ESL Facility Description
- Selected Results
- ISS Investigations Supported
- Conclusions/Future Work

ESL

- Processes or melts levitated samples
- Provides a quiescent environment for the samples
- Is an important containerless technique for the study of metals, alloys, glasses, ceramics and semiconductors
- Is a ground-based technique which could be performed in microgravity

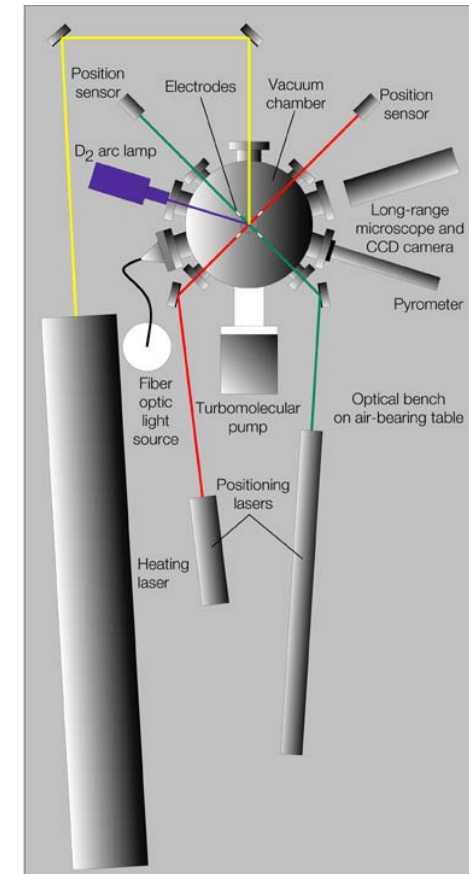

ESL System for Operations UHV- 5 atm.

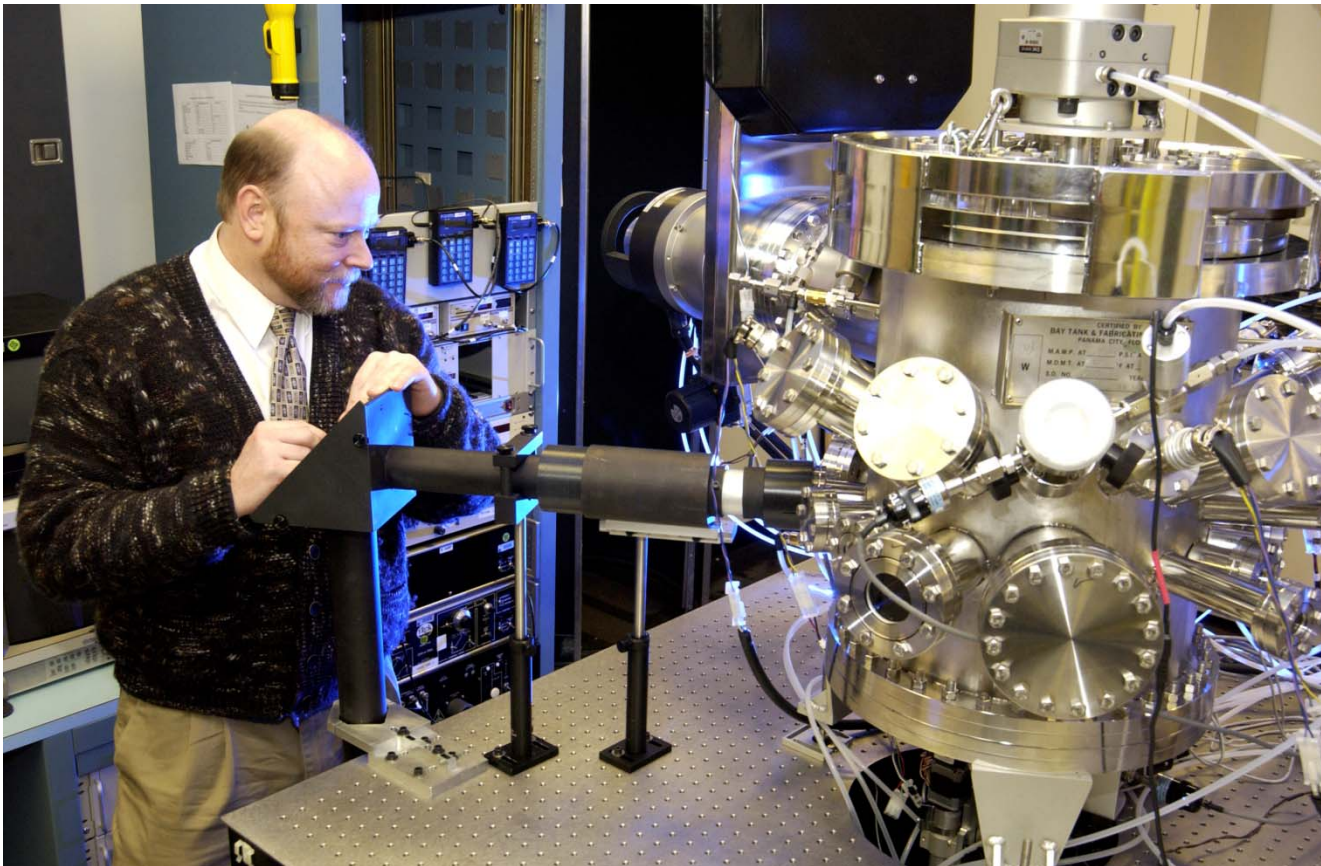

MSFC ESL Facility

- **The MSFC ESL Facility provides materials characterization data and experience with containerless processing to users.**
- **The MSFC Electrostatic Levitation (ESL) facility can provide measurements of thermophysical properties, which include creep strength, density and thermal expansion, emissivity, specific heat and phase diagrams. For melts, viscosity and surface tension can be measured.**
- **Processing data supports development of NASA flight investigations and characterization data supports NASA programs and external customers.**
- **Samples are 2-3 mm diameter spheres (30-70 mg)**
- **Heated by lasers: Nd:YAG, CO₂ and solid state**

Nickel Melt Cycle

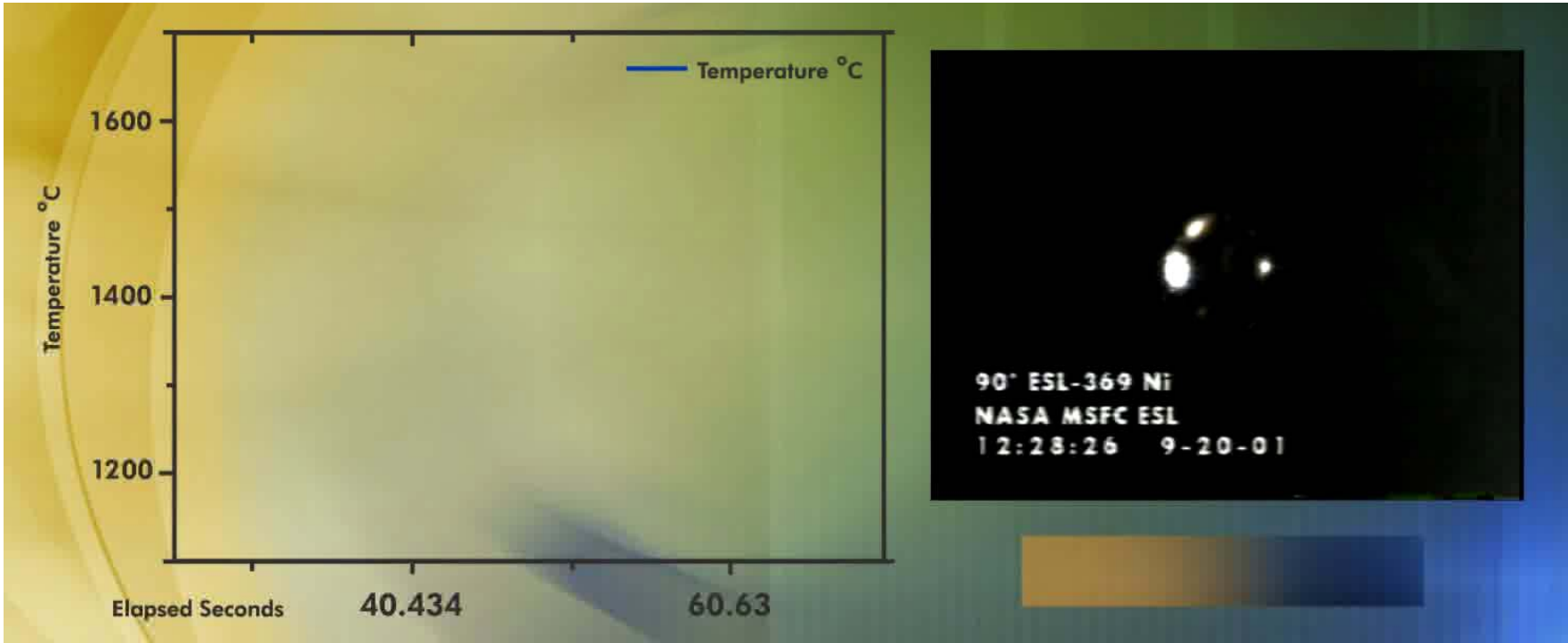

Materials Processed via ESL

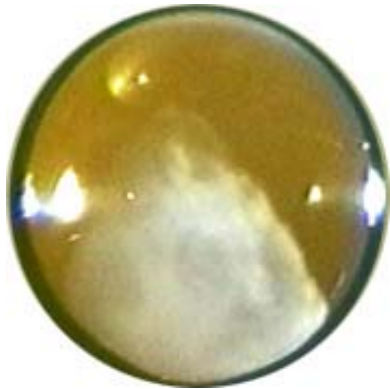

Glass Melt
with
Crystallites



Metals and
Alloys



Ceramics, including
pressed materials
like ZrB_2

Other materials include polymers, semiconductors, solids, melts and liquids.
Delivered data files for hundreds of samples to customers since 1997.

Sample Fabrication Methods and Shapes

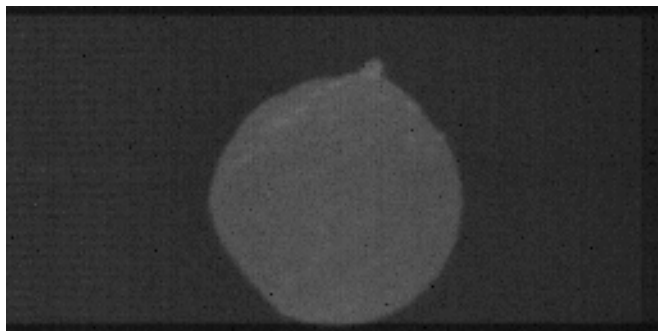

Machined by general-purpose machine shop from Nb rod

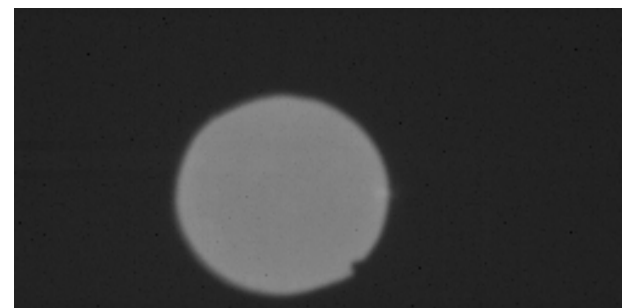

Arc melted Nb by ESL personnel

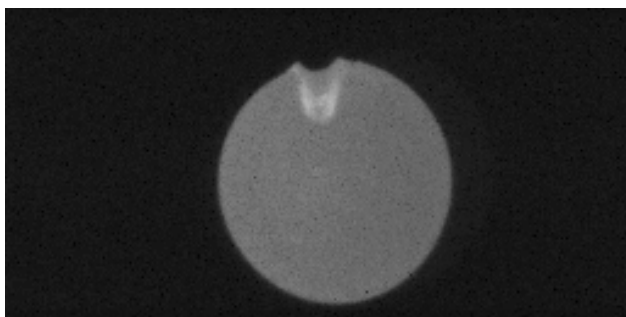

Nb ESL melted and scribed

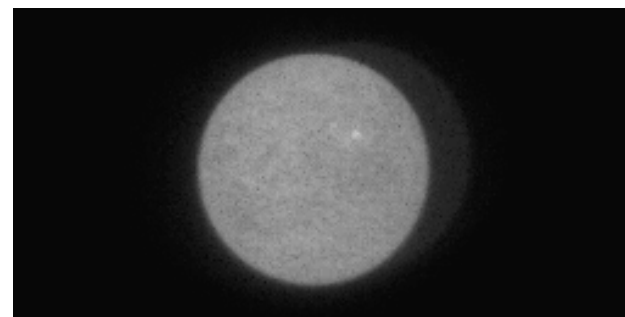

Nb machined by Industrial Tectonics Inc., precision sphere mfg specialists

Non-contact Temperature Measurement Tools

- Single wavelength/band pyrometers for the range: 200-3500 °C
- Two wavelength pyrometers for the range: 700-1400 °C
- Blackbody calibration source with operating range: 600-3000 °C
- Multi-wavelength spectropyrometers from FAR Associates provide temperature measurements with no operator input, even when the target's surface characteristics change with temperature or processing for the ranges:
 - 800-4000 °C
 - 300-2000 °C.

ESL Facility Capabilities

- **Phantom V7 provides 12 bit monochromatic images with 800x600 pixel resolution at rates up to 160,000 frames per second.**
- **Redlake Motion ProModel 10,000 provides 8 bit monochromatic images with 1280x1024 pixel resolution at rates up to 10,000 frames per second.**
- **Optical viewports are available on the chambers for user-provided equipment.**
- **Sample load lock and carousel mechanism support high-throughput processing.**
- **Processing at 10^{-8} Torr or at pressures up to 5 atm.**
- **An arc melter is available for sample fabrication.**
- **Additional capabilities include: RGA and mass scales with 1 microgram resolution are available for pre- and post-process weighing to determine mass losses.**

Density Data Analysis

- **Data from video images**
- **Computer detects edges, calculates volume vs. time**
 - Needs good contrast
- **Correlated with pyrometry, known mass gives density vs. temperature**
- **Typical precision: ~ 0.1% liquid, ~0.05% machined sphere, ~2% sample solidified in ESL**
- **Standard ESL backlighting uses a white light source**
- **At high temperatures, sample becomes a very bright, radiant object and contrast becomes poor**
- **Illumination system designed for high temperature studies using blue laser provide good edge detection to 2800° C.**

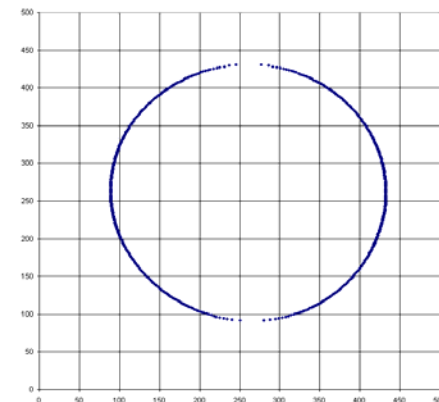
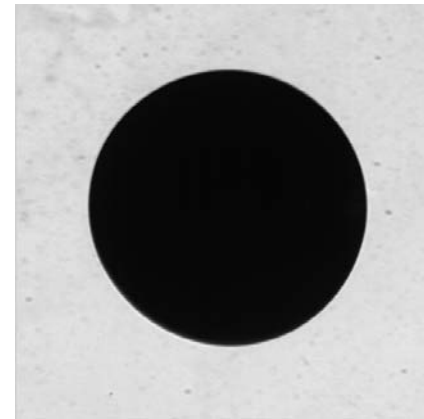

Backlit sample showing excellent contrast and computer detected edge

R.C. Bradshaw, R.W. Hyers, et al., UMass

Density of solid and liquid Ti_{39.5}Zr_{39.5}Ni₂₁

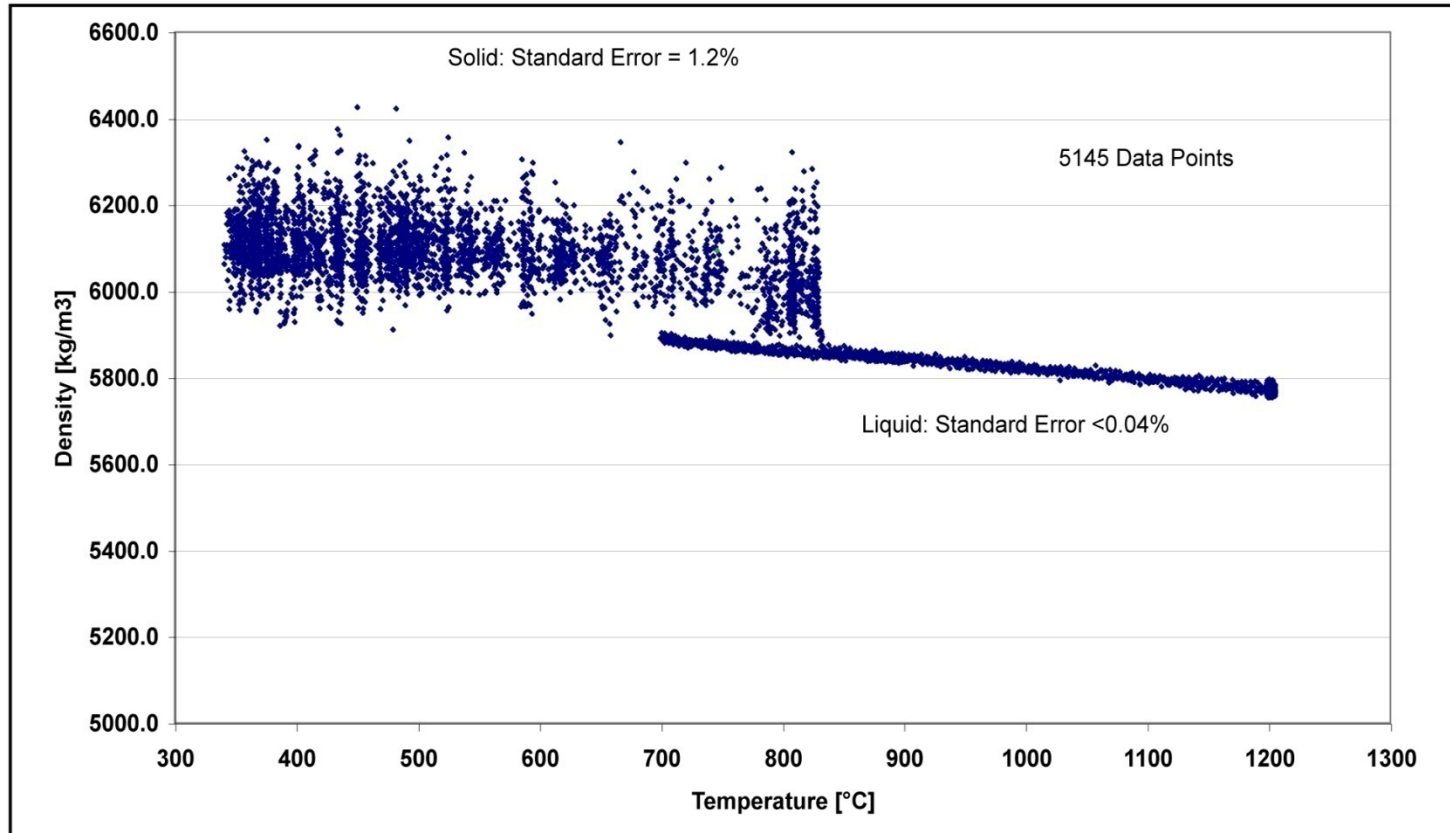

Note: Solid sample was not a precision-machined sphere, and had an irregular shape. Upon melting, the samples become more axisymmetric and the error was greatly reduced.

Oscillating Drop Method: Viscosity and Surface Tension

- Viscosity and surface tension data needed for advanced modeling of welding and casting
- Damped Oscillations $\text{Ti}_{37}\text{Zr}_{42}\text{Ni}_{21}$ at 1048 K
- Recorded at 1000 fr/sec, played at 10 fr/sec

$$\omega_l = \sqrt{\frac{l(l-1)(l+2)\gamma}{\rho R_o^3}} \quad \text{Rayleigh (1879)}$$

$$\tau_l = \frac{\rho R_o^2}{(l-1)(2l+1)\mu} \quad \text{Lamb (1881)}$$

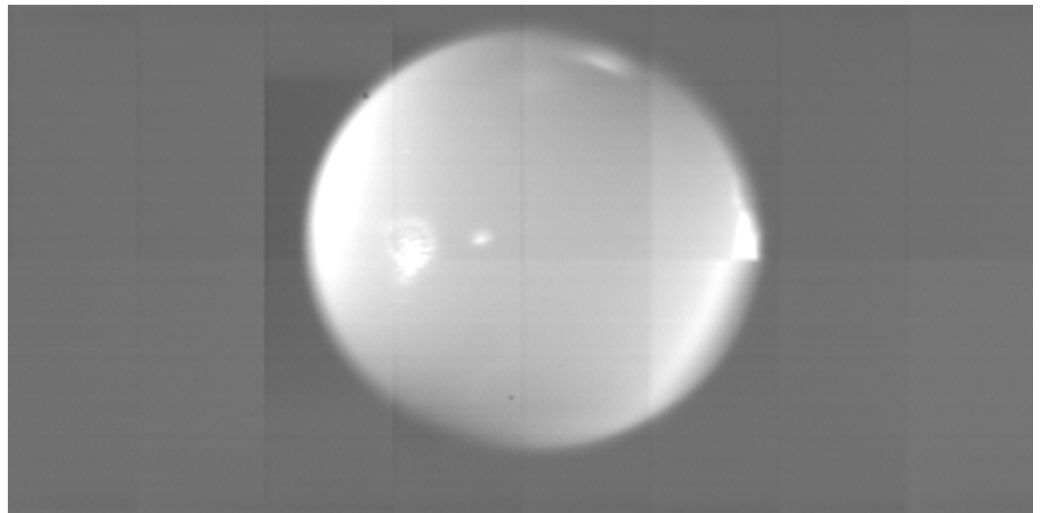

Phase Diagram Studies

Portable ESL at Argonne National Lab (ANL)

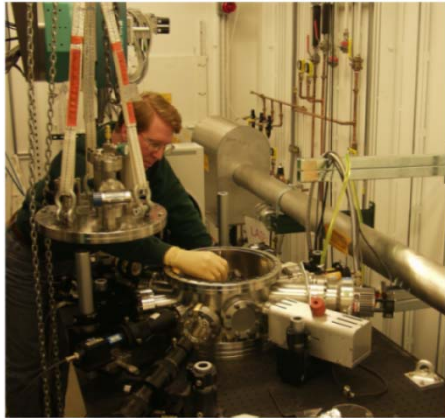

X-ray diffraction image from ESL processing at ANL



- Portable ESL used at the high energy (125 keV) synchrotron x-ray source at ANL .
- Provides *in-situ* determination of the atomic structures of equilibrium solid and liquid phases, including undercooled liquids, as well as real-time studies of solid-solid and liquid-solid phase transformations. Studies performed to support Dr. Kelton.
- Use of image plate (MAR345) or GE-Angio detectors enables fast (30 ms – 1s) acquisition of complete diffraction patterns
- More rapid and accurate technique than conventional methods which involve annealing and quenching (to try and preserve high-temperature structure) with subsequent room-temperature x-ray diffraction and electron microscopy studies

ESL Emissometer System

- Data needed for thermal design
- Emissometer developed by AZ Technology
- Temperature range:
 - 700 to 3500K
- FT-IR capabilities:
 - 0.400 to 28-um
 - Emittance mode
 - Multiple scan ranges
 - Filtering for heating laser wavelengths
- Blackbody source operated at same temperature as sample with matched collection geometry
- Emittance data from sample and blackbody source integrated over spectral range
- Ratio provides measure of total hemispherical emittance
- Preliminary tests with Inconel and stainless steel show good agreement with literature.

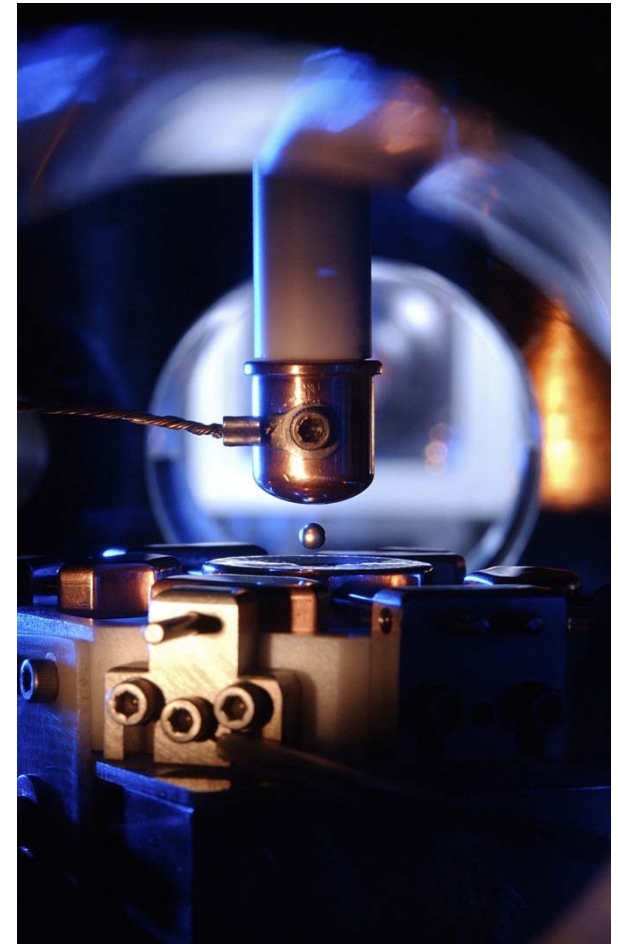

Schematic of System for Emissivity Measurements

Configuration A: Blackbody Calibration

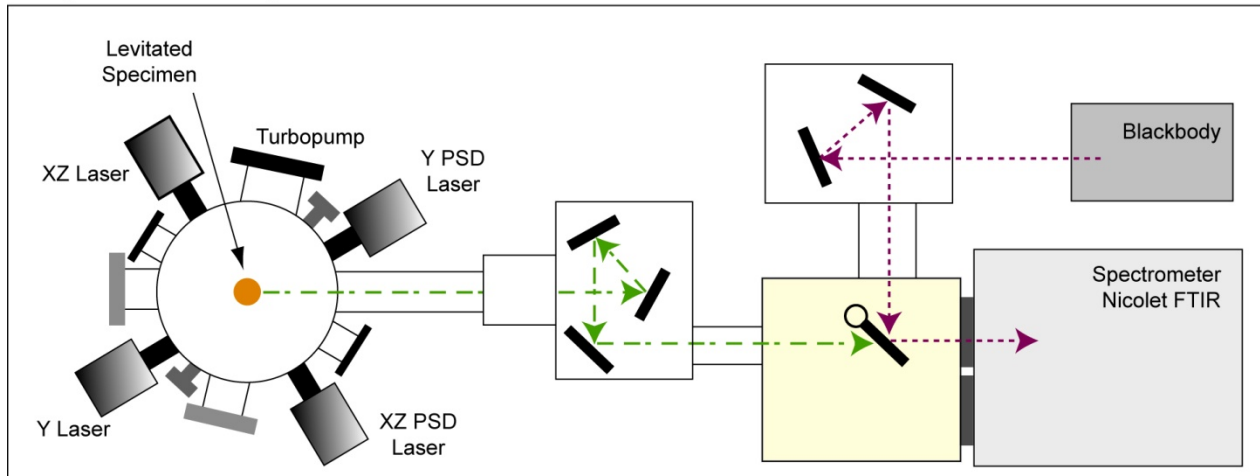

Configuration B: Emissivity Measurements

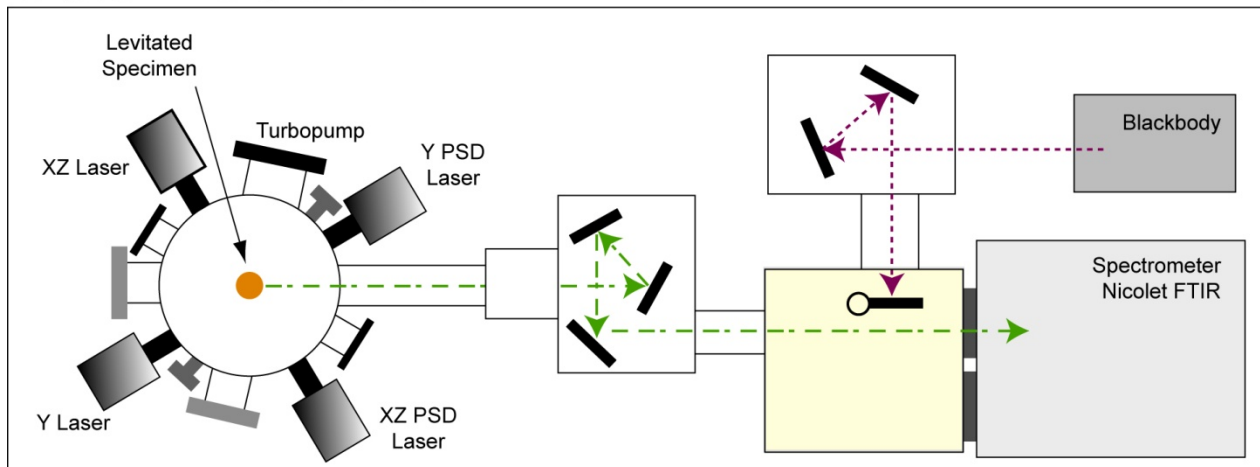

Viscosity of Pd₈₂Si₁₈

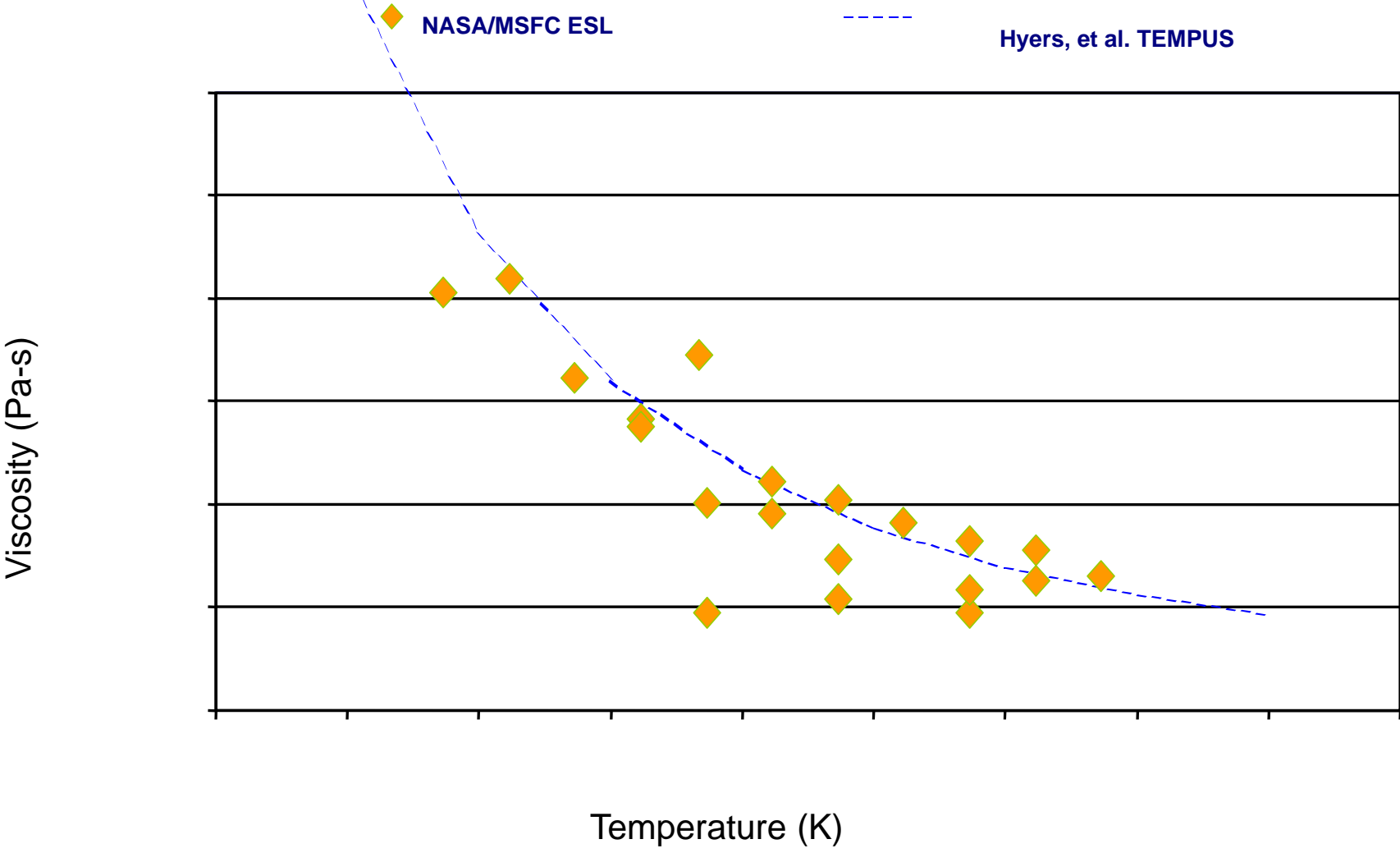

Phase Selection in Stainless Steel

- Double Recalescence in 72Fe-11.2Cr-16.8Ni Stainless Steel
- Processed in MSFC ESL July 23, 2001
- Recorded at 40,500 frames/sec, played at 10 frames/sec
- Project: “The Role of Convection and Growth Competition on Phase Selection in Microgravity” (LODESTARS-Dr. Matson)

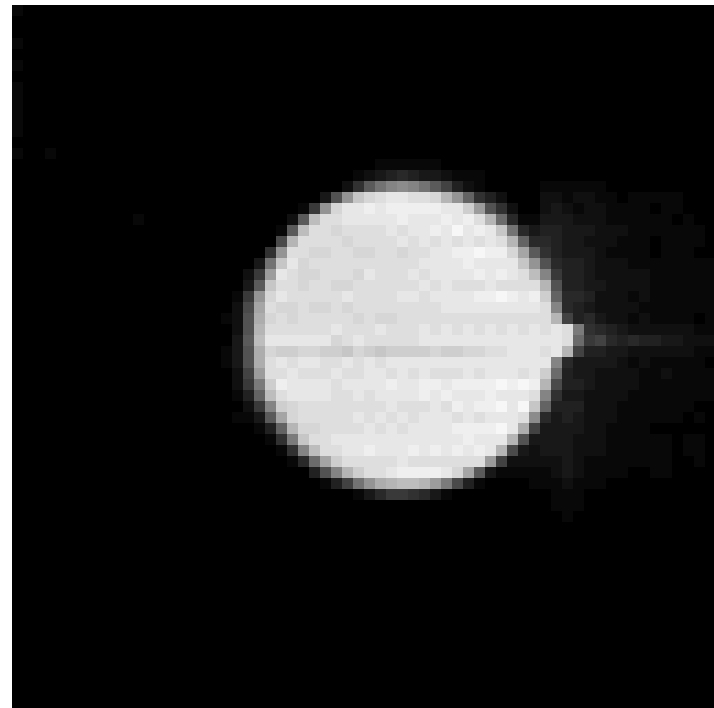

Triggering NiNb

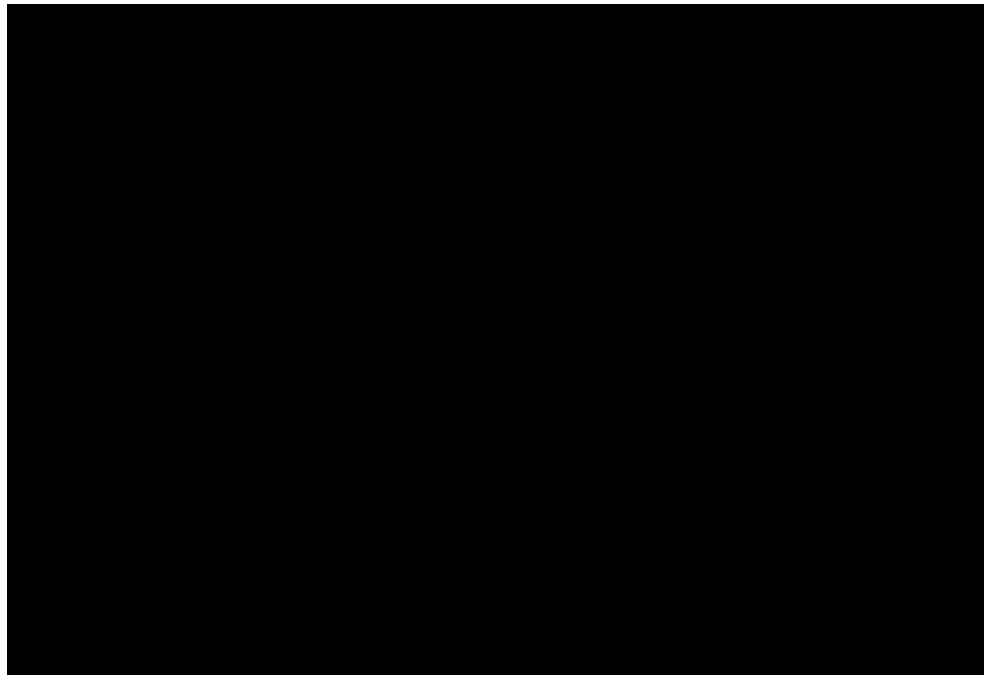

Reduced Gravity Containerless Processing

- Shuttle examples:
 - Electromagnetic (DARA TEMPUS)
 - IML-2, MSL-1 and MSL-1R
 - Acoustic (NASA DPM)
 - USML-1
- Future possibilities include:
 - ISS Electromagnetic (ESA EML)
 - Launch 2013 (ATV-4)
 - ISS Electrostatic (NASDA ELF)

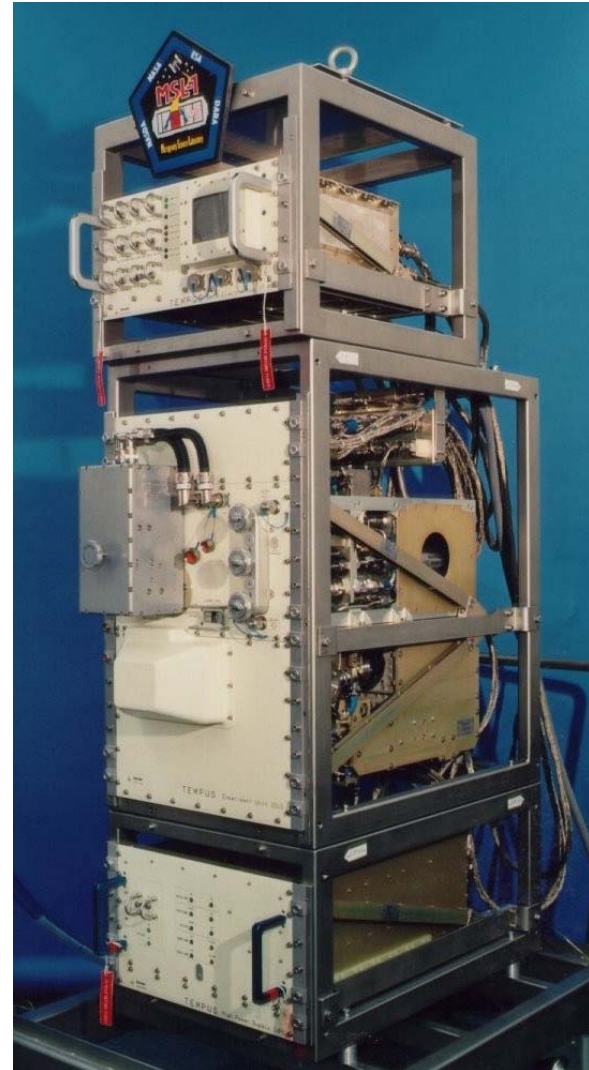

Microgravity Rationale

- Reduced forces needed for levitation
 - Field effects reduced
 - EML access to deeper undercooling and wide range of controlled convection conditions
 - ESL enables processing in additional gas environments without dielectric breakdown
 - Larger samples possible - enhances access to study of bulk effects for ESL
- Samples maintain spherical shape - *facilitates comparison with theory*

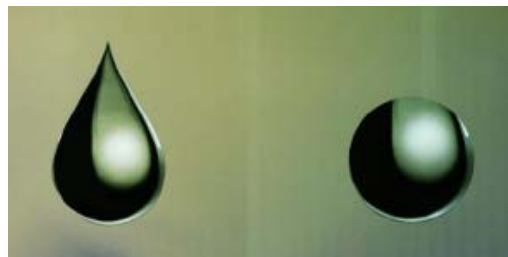

1-G

Space

Microgravity Rationale

- Microgravity provides greatly reduced fluid motion caused by:
 - Positioning fields in EML (permits controlled convection over wide range of conditions)
 - Buoyancy-driven convection
 - Phase separation due to density difference:

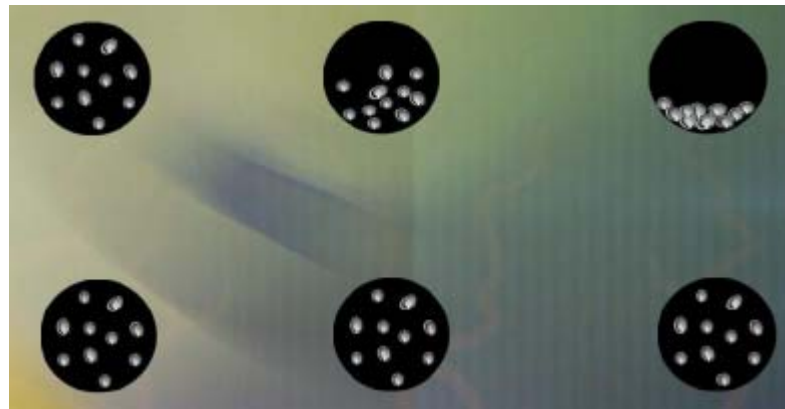

1-G

Space

ISS Investigations

- The MSFC ESL facility supports NASA scientists developing experiments for ISS
- NASA scientists participate in studies using the ESA/DLR electromagnetic levitation system (EML) as members of Topical Teams:
 1. Thermophysical Properties of Liquid Metallic Alloys - Modeling of Industrial Solidification Processes and Development of Advanced Products (THERMOLAB-ISS)
 2. Thermophysical properties and solidification behavior of undercooled Ti-Zr-Ni liquids showing an icosahedral short-range order (ICOPROSOL)
 3. Peritectic Alloy Rapid Solidification with Electromagnetic Convection (PARSEC)

ISS Investigations Supported

1. Dr. Roberts Hyers, University of Massachusetts, “Unified Support for THERMOLAB-ISS, ICOPROSOL, and PARSEC”
2. Dr. Ken Kelton, Washington University, “Studies of Nucleation and Growth, Specific Heat and Viscosity of Undercooled Melts of Quasicrystals and Polytetrahedral-Phase-Forming Alloys”
3. Dr. Ken Kelton, Washington University, “NASA Research under ESA-Based Investigations THERMOLAB and ICOPROSOL”
4. Dr. Doug Matson, Tufts University, “Electromagnetic Levitation Flight Support for Transient Observation of Nucleation Events” (ELFSTONE)
5. Dr. Doug Matson, Tufts University, “Levitation Observation of Dendrite Evolution in Steel Ternary Alloy Rapid Solidification” (LODESTARS)

Conclusions/Future Work

- **ESL support for ground-based studies:**
 - **Sample processing to provide ground-based levitation studies to assist in the development of flight experiments.**
 - **Ground-based levitation studies with oxygen control system to study the effects of partial pressure of oxygen and thermophysical properties and nucleation**
- **Development of a quench system for undercooling and microstructure studies.**

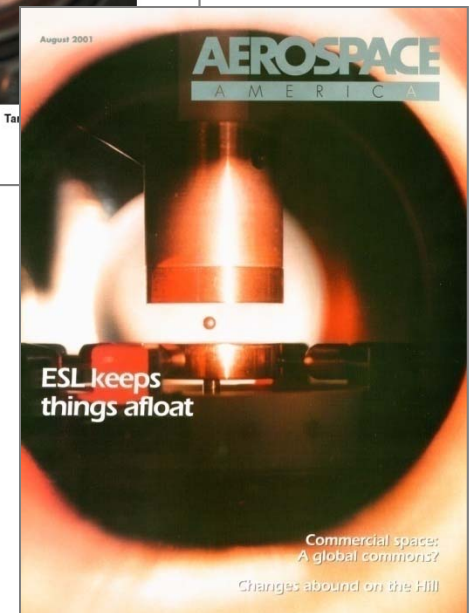
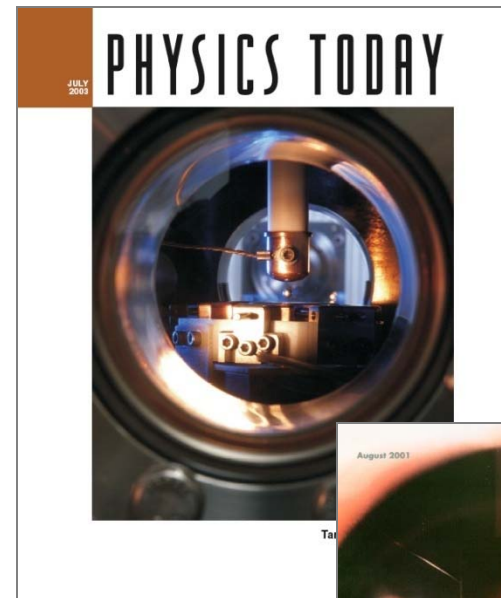



BACKUP

Ultra-High Temperature Creep Resistance via ESL

- Recent project completed to develop, validate and utilize a new ESL technique for studies of creep resistance at ultra-high temperatures. Major project tasks included:
 - Use of centrifugal acceleration (from photon pressure) to induce creep in levitated samples.
 - Capture of images of sample deformation at specified temperatures and times for analysis.
 - Development of software for on-line rotation analysis and creep measurements.
 - Development of predictive finite element model of stress/strain in samples.
 - Validation tests using conventional ASTM test methods.
 - Structural analysis of samples following ESL studies to examine deformation behavior and texture development
 - Magnetic rotation apparatus provides rotation rates up to 30,000 rps
- Results from ESL tests show excellent agreement with results from validation testing at high temperature materials facilities using ASTM Standard E-139.**
- Maximum temperature achieved for Nb creep using state-of-the-art high temperature furnaces was 1985° C
- ESL creep tests with Nb performed successfully at 2300° C (Nb mp ~ 2486° C), higher temperatures are possible.

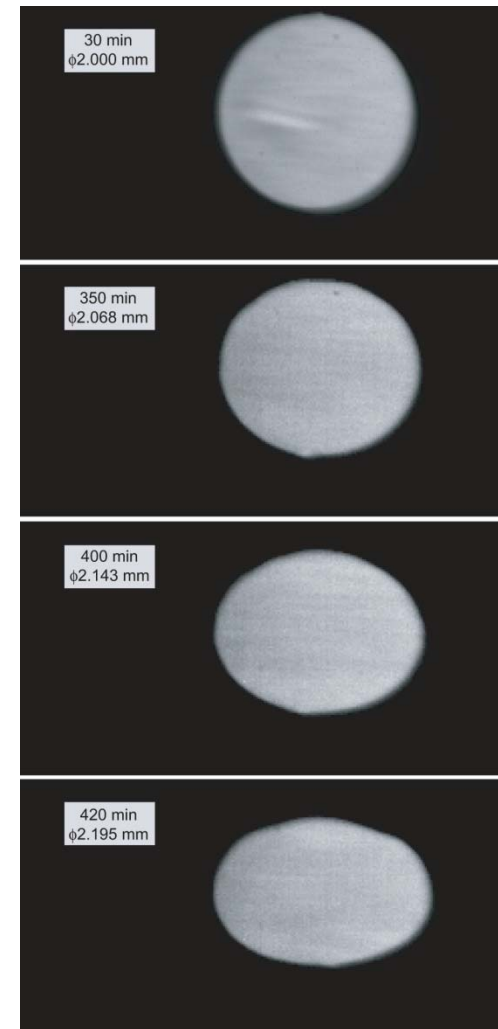

Nb at 1985° C

Results from ESL Creep Studies

- Creep deformation of Nb at 1985° C was measured using both the ESL technique and a conventional testing method
- The stress exponent from the ESL and conventional creep tests show good agreement with data from literature
- The ESL method is provides a unique capability for measuring creep at temperatures over 2000 C, as is required for numerous advanced aerospace applications.
- ESL represents a promising technique for determining creep properties of ultra-high-temperature materials

Method	Stress Exponent for Nb
ESL testing 2006	2.517
ASTM, furnace testing 2006	2.4
EML testing 1985	2.476
Extrapolation from low temp furnace data, 1982	4.4

Constitutive equation for creep in Nb, from Keissig, 1985:

$$\dot{\epsilon} = 2.64 \times 10^{-10} \sigma^{2.476} e^{-\left(\frac{55326}{T}\right)}$$