

INTERNATIONAL SPACE STATION MODAL CORRELATION ANALYSIS

Kristin Fitzpatrick

The Boeing Company, 3700 Bay Area Blvd. Houston, Texas

Michael Grygier

NASA, Johnson Space Center, Houston, Texas

Michael Laible

The Boeing Company, 3700 Bay Area Blvd., Houston, Texas

Sujatha Sugavanam

The Boeing Company, 3700 Bay Area Blvd., Houston, Texas

ABSTRACT

Modal analyses, model validations and correlations are performed for the different configurations of the International Space Station (ISS). Three Dedicated Thruster Firings (DTF) tests were conducted during ISS Stage ULF4; this paper will focus on the analysis and results of the DTF S4-1A, which occurred on October 11, 2010. The objective of this analysis is to validate and correlate analytical models used to verify the ISS critical interface dynamic loads.

During the S4-1A Dedicated Thruster Firing test, on-orbit dynamic measurements were collected using four main ISS instrumentation systems along with a Russian high rate sensor; Internal Wireless Instrumentation System (IWIS), External Wireless Instrumentation System (EWIS), Structural Dynamic Measurement System (SDMS), Space Acceleration Measurement System (SAMS) and Internal Measurement Unit (IMU). ISS external cameras also recorded the movement of one of the main solar array tips, array 1A.

Modal analyses were performed on the measured data to extract modal parameters including frequency, damping, and mode shape information. Correlation and comparisons between test and analytical frequencies and mode shapes were performed to assess the accuracy of the analytical models for the configuration under consideration. Based on the frequency comparisons, the accuracy of the mathematical model is assessed and model refinement recommendations are given.

1.0 INTRODUCTION

The on-orbit construction of the International Space Station (ISS) began in November 1998, and was completed in July of 2011. The ISS has been designed to operate for at least fifteen years to conduct science and engineering projects. To maintain its structural integrity during its construction and life span, structural loading distributions have been rigorously analyzed through numerical simulations and included in the design of the structure and its mission operations [1, 2, 17]. The accuracy of such analysis results is directly affected by the integrity of structural dynamic mathematical models and estimated input forces.

On-orbit dynamic math models of ISS configurations are generated by combining component math models. Each component model is required to be correlated with ground test data. However, it is expected that on-orbit math models will still contain modeling inaccuracies due to differences in boundary conditions, mass distributions, and gravitational fields [2, 9]. Uncertainty factors are used to compensate for inherent inaccuracies in the math models and the estimated input forces [4]. The latter ISS configurations will have greater uncertainties due to the accumulation of component model inaccuracies. Large uncertainties would restrict the ISS mission operations. This problem may be alleviated by correlating on-orbit math models using test data measured in space. On-orbit testing of earlier ISS configurations, with ground testing of new hardware components, will lead to the verification of later, more complex configurations. This “phased configuration verification” allows the use of the same uncertainty factors in predicting structural dynamic loads for all configurations.

This paper summarizes the on-orbit modal test and the related modal analysis, model validation and correlation performed for the ISS Stage ULF4, DTF S4-1A, October 11,2010, GMT 284/06:13:00.00. The objective of this analysis is to validate and correlate analytical models with the intent to verify the ISS critical interface dynamic loads and improve fatigue life prediction.

For the ISS configurations under consideration, on-orbit dynamic responses were collected with Russian vehicles attached and without the Orbiter attached to the ISS. ISS instrumentation systems that were used to collect the dynamic responses during the DTF S4-1A included the Internal Wireless Instrumentation System (IWIS), External Wireless Instrumentation System (EWIS), Structural Dynamic Measurement System (SDMS), Space Acceleration Measurement System (SAMS), Inertial Measurement Unit (IMU) and ISS External Cameras.

Experimental modal analyses were performed on the measured data to extract modal parameters including frequency, damping and mode shape information. Correlation and comparisons between test and analytical modal parameters were performed to assess the accuracy of models for the ISS configuration under consideration. Based on the frequency comparisons, the accuracy of the mathematical models is assessed and model refinement recommendations are given.

Section 2.0 of this report presents the math model used in the analysis. This section also describes the ISS configuration under consideration and summarizes the associated primary modes of interest along with the fundamental appendage modes. Section 3.0 discusses the details of the ISS Stage ULF4 DTF S4-1A test. Section 4.0 discusses the on-orbit instrumentation systems that were used in the collection of the data analyzed in this paper. The modal analysis approach and results used in the analysis of the collected data are summarized in Section 5.0. The model correlation and validation effort is reported in Section 6.0. Conclusions and recommendations drawn from this analysis are included in Section 7.0.

2.0 MATH MODELS AND DYNAMICS

An ISS math model was created for the configuration of the ISS Stage ULF4 DTF S4-1A. This math model was generated from collections of the latest ground test verified component models. The component models are represented by Finite Element Models (FEMs) that also include internal and external Component Mode Synthesis (CMS) models. In addition, the analyzed model incorporated, as closely as possible, the actual on-orbit boundary and interface conditions. The post-flight modeling effort also attempted to account for the actual array orientations that were recorded during the event. The model used in this analysis are linear and do not account for non-linearity that may be present.

The configuration of the ISS Stage ULF4 DTF S4-1A is outlined in Table 2.1. The configuration includes a Progress docked to the SM Aft and DC1 Nadir ports, and a Soyuz docked to the MRM1 Nadir and MRM2 Zenith ports. Figure 2-1 illustrates the vehicle and element configuration for this event. The specific SARJ and BGA angles are presented in Table 2-1 and depicted in the math model MSC/PATRAN™ view in Figure 2-2. The ISS solar array, 1A, that was recorded during the S4-1A DTF is also labeled in that figure.

Table 2-1. Configuration of ISS Stage ULF4 S4-1A DTF

ISS Stage ULF4 On - Orbit Event	Date	SM Aft	MRM1 Nad	DC1 Nad	MRM2 Zen	Stbd SARJ Angle	Port SARJ Angle	Stbd HRS Angle	Port HRS Angle
S4 - 1A DTF	10/11/10	39P	23S	37P	24S	195	75	30	45

ISS Stage ULF4 On - Orbit Event	BGA 3B Angle	BGA 1B Angle	BGA 1A Angle	BGA 3A Angle	BGA 4A Angle	BGA 2A Angle	BGA 2B Angle	BGA 4B Angle
S4 - 1A DTF	279	70	279	70	270	90	270	90

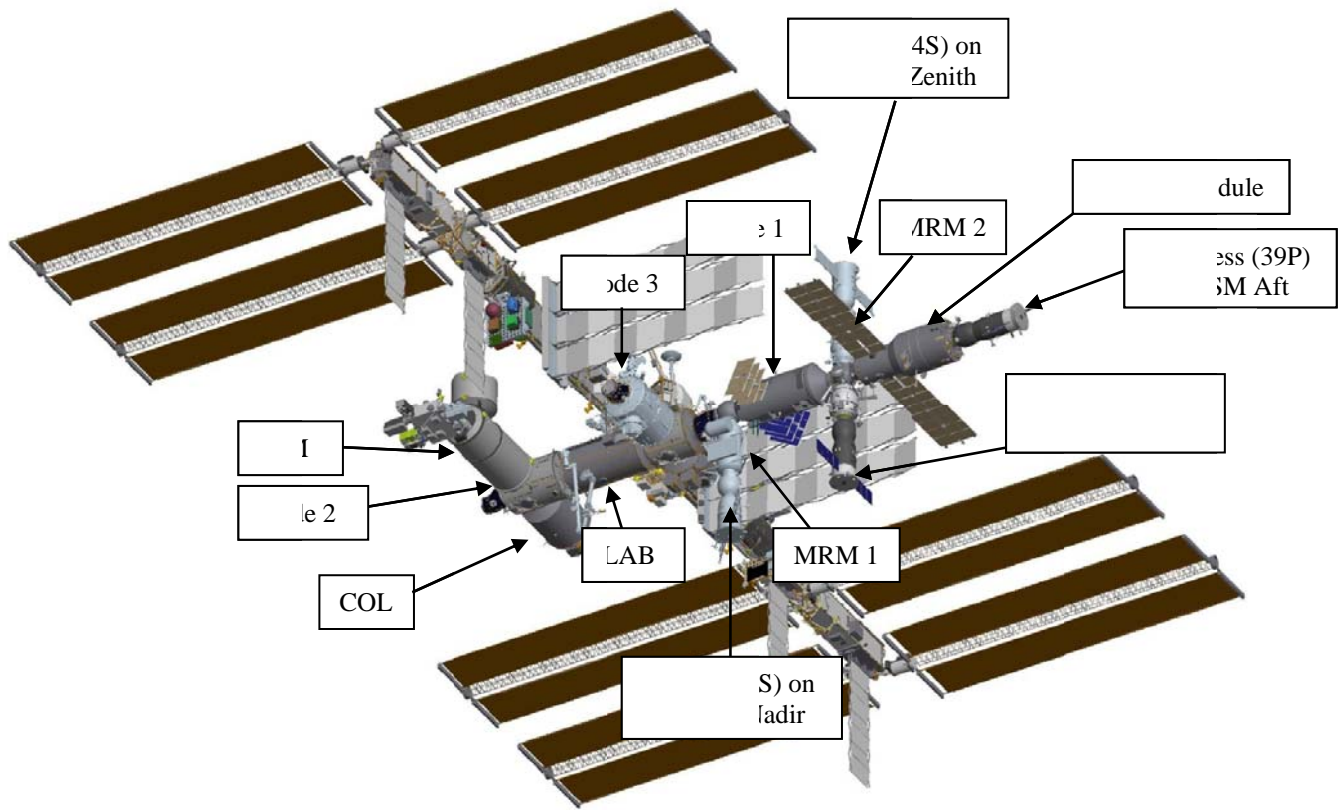

Figure 2-1. ISS Stage ULF4 Dedicated Thruster Firing S4-1A Configuration

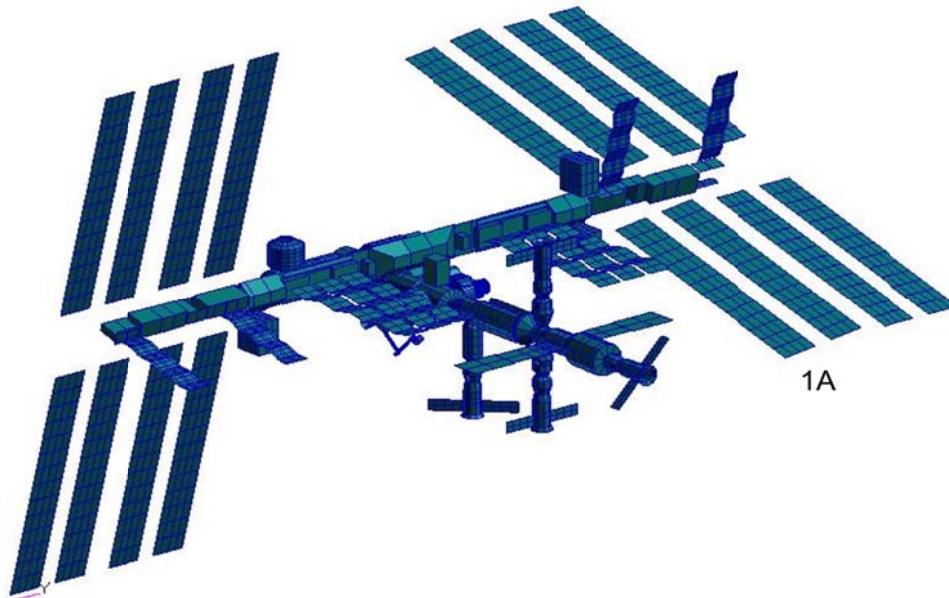

Figure 2-2: ISS Stage ULF4 S4-1A DTF Math Model PATRAN View

Table 2-2 is the latest on-orbit ISS mass properties compared to the NASTRAN model. The associated global system and truss modes (up to 5.0 Hz) are summarized in Table 2-3. The mode descriptions in the table were determined from kinetic energy distributions and mode shape animation using MSC/PATRAN™.

Table 2-2. Mass Properties: ISS Stage ULF4 S4-1A DTF Configuration

DESCRIPTION	24S_AR ISS+37P+23S+39P+24S after 24S docking						
	Mass (lbs)	Center of Gravity (in)			Moments of Inertia (Slug- ft ²)		
		X	Y	Z	Ixx	Iyy	Izz
VIPER Properties	827126	-160.9	-38.4	130.0	84599810	50464111	127527980
Loads Model fv84ds	789386	-161.6	-34.9	127.4	85752622	47993160	123591383
% Diff	-4.8%	0.5%	-10.1%	-2.0%	1.3%	-5.1%	-3.2%

Table 2-3. Mode Descriptions: ISS Stage ULF4 S4-1A DTF Math Model

Mode #	Freq. (Hz)	Mode Description
10	0.061	Array OP / Module XZ
17	0.092	Array IP/Station XY
36	0.112	Station XY (Slight)/Array OP
44	0.114	Station XY
57	0.150	HRS Out-of-plane
83	0.173	Truss XY
84	0.197	HRS IP / Module XZ / Truss XYZ
102	0.225	Truss YZ / Module XZ
131	0.272	Station XY (JEM XY)
142	0.285	Station XZ
171	0.362	SM Array IP / COL-JEM YZ
175	0.368	Truss YZ / Module TOR / HRS Torsion
211	0.385	HRS Torsion
245	0.447	Modules-JEM YZ / Truss XYZ
254	0.494	Station Torsion X / Truss YZ
256	0.513	Station Torsion X - JEM XYZ / HRS Accordion / Truss XYZ
276	0.553	Module XY / STBD Truss XY / HRS Accordion
286	0.578	HRS Accordion
288	0.584	PHRS Torsion / RSA Tor X / Truss YZ
297	0.637	EPS Torsion
302	0.665	Station XZ
313	0.720	Truss XY Bending
339	0.793	Module XY / Node 3 YZ / EPS IP
352	0.840	Module RSA YZ
353	0.843	Node 3 YZ / RSA XZ
355	0.888	Station XY / Soyuz MRM1 OP / EPS IP
359	0.928	HRS IP
368	0.994	Truss XZ / Module XZ
371	1.030	Module XY (N3/N1/AL)
382	1.099	RSA XZ
443	1.174	Station XY / JEM EF
484	1.251	JEM XY / Node 3 XY / COL YZ
486	1.310	Module XZ
504	1.425	RSA XZ / COL XY / JEM EF XYZ
511	1.508	JEM YZ / APM YZ / RSA XZ

Mode #	Freq. (Hz)	Mode Description
540	1.633	Station XY
549	1.672	Truss XY / Station XYZ / RSA YZ
553	1.703	Station XY
625	1.834	SPDM MB2
646	1.956	Truss XY Bending / more...
661	1.983	P3 Torsion
674	2.037	Truss XY / SPDM MB2
723	2.171	Airlock YZ / SM XY
728	2.190	Station XY
803	2.434	Truss COL N2 JEM YZ / SM XY
819	2.560	Module XZ
833	2.754	SM XY / Airlock YZ
834	2.785	SM XY / Airlock YZ / PHRS IP
921	3.458	MRM YZ / N2 N3 Airlock XY / S3 P3 Torsion
931	3.722	Station XZ
935	3.769	Truss XYZ
951	4.001	Station XYZ
960	4.103	US LAB XY / Node 2 XY
979	4.264	EPS IP 2nd
1003	4.564	Truss XYZ / Station XY
1008	4.703	Module XY

3.0 ON-ORBIT FLIGHT TESTING: DTF S4-1A

The purpose of the ISS Stage ULF4 S4-1A DTF test was to excite primary load inducing modes which would be recorded by the ISS instrumentation systems. The test was conducted on October 11, 2010, GMT 284/06:13:00.00 and was comprised of two firings. Firing 1 was an ISS Yaw firing designed to excite dynamic modes in the ISS XY plane, though other modes were also excited due to complexity of the ISS structure. Firing 2 was an ISS Pitch firing designed to excite dynamic modes in the ISS XZ plane, which also excited other modes due to the complexity of the ISS structure. Both test firings used ISS Service Module (SM) thrusters. The Service Module is a Russian Module located at the ISS aft, see Figure 2-1. A breakdown of each firing set is shown in Table 3-1. A diagram of the Russian Service Module thrusters is shown in Figure 3-1.

Table 3-1: ISS Stage ULF4 S4-1A DTF Firings

S4-1A Array	Event	Description	Thruster Firing Sequence	Duration (Sec.)	Start Time (Sec.)	Stop Time (Sec.)
		Free Drift			0.0	200.0
	Firing 1	Yaw	SM 12, 13, 14, 18, 19, 20	1.0	200.0	500.0
	Firing 2	Pitch	SM 21, 22, 23, 27, 28, 29	0.6	500.0	700.0
		Return to Attitude				

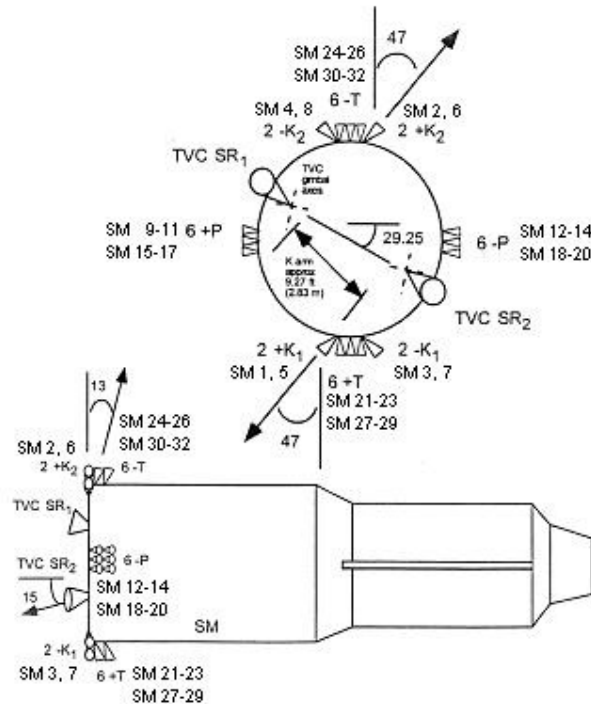

Figure 3-1: Service Module Thruster Diagram

4.0 ON-ORBIT INSTRUMENTATION SYSTEMS

4.1 OVERVIEW

During the ISS Stage ULF4 S4-1A DTF, structural responses were measured and recorded with a variety of instrumentation systems that include: External Wireless Instrumentation System (EWIS), Internal Wireless Instrumentation System (IWIS), Structural Dynamic Measurement System (SDMS), Space Acceleration Measurement System (SAMS), Inertial Measurement Unit (IMU) and ISS External Cameras. A detailed description of each of these systems is given in the following sections.

Photogrammetry data, from the ISS External Cameras, was taken of the 1A solar array during the S4-1A DTF. The data consists of a displacement time history response of two tracked points at the end the array. This data allows for an independent analysis of the solar array wing's modal parameters. Having a better understanding of the on orbit array mode frequencies and damping allows for less uncertainty to be placed on array modes during loads analysis which feed into reducing solar array position constraints during flight operations.

4.2 EXTERNAL WIRELESS INSTRUMENTATION SYSTEM (EWIS)

The ISS truss segments outboard of the solar array rotary joint (S4, S6, P4 and P5) were outfitted with External Wireless Instrumentation System (EWIS) accelerometers and Remote Sensor Units (RSUs) prior to launch [20]. The EWIS Network Control Unit, which sends user commands to the RSUs, resides inside the LAB pressurized module and two NCU antennas were externally mounted to the LAB via EVA. The EWIS architecture is shown in Figure 4-1. The EWIS System has both a Continuous Mode and a Scheduled Mode for data acquisition. The Continuous Mode aspect of EWIS records a two minute window of accelerometer data when a prescribed acceleration threshold is reached; such that 30 seconds prior to the threshold exceedance and 90 seconds after the threshold exceedance is stored for download. The Continuous Mode also collects data and sorts cycle counts into 200 micro-g bins for the time period in between Scheduled Mode data takes, which is utilized for structural life assessment. The Scheduled Mode allows for a user to command EWIS accelerometers to record at a set sampling frequency for a prescribed length of time. The EWIS RSUs store the accelerometer data until a data take has completed. The RSUs then transmit the data to the EWIS NCU via Remote Frequency (RF). The EWIS NCU then passes the data through a cable to a Space Station Computer (SSC) where it is stored until it is downloaded to the ground via KU-band.

Due to communication programming issues to the outboard truss only the accelerometers on the S4 and S6 IEA truss segments recorded data during the ISS Stage ULF4 S4-1A.

10 triaxial accelerometer units: 4-S6, 2-S4, 2-P4, 2-P5

(Keel located down)

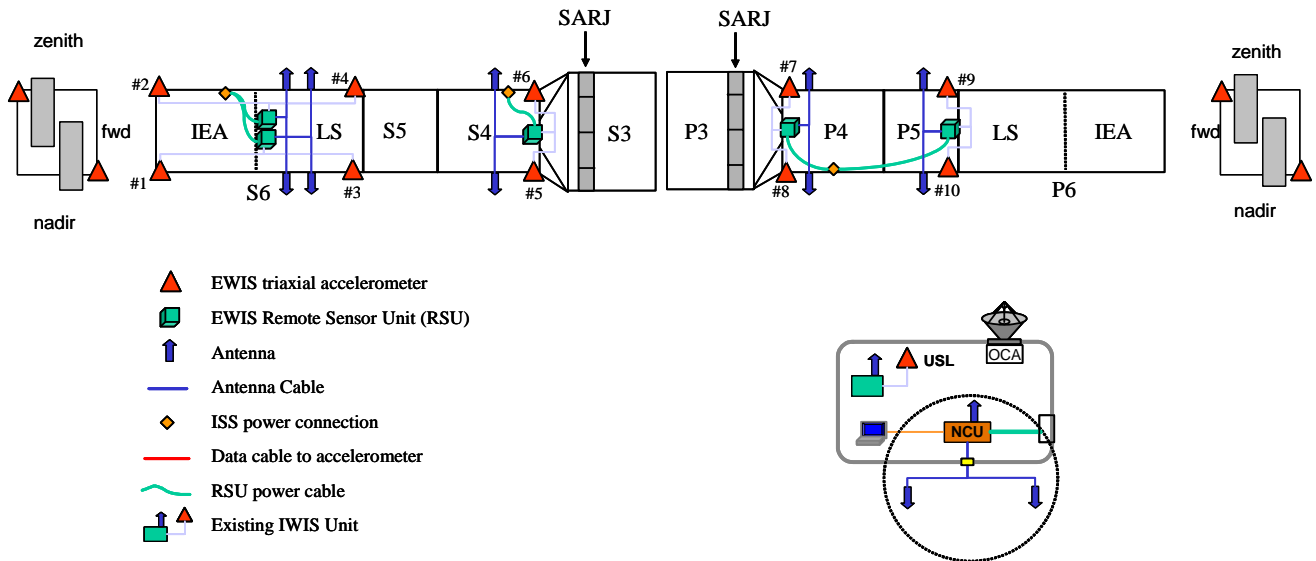

Figure 4-1. EWIS Architecture

4.3 INTERNAL WIRELESS INSTRUMENTATION SYSTEM (IWIS)

The Internal Wireless Instrumentation System (IWIS) operates within the pressurized ISS modules [5]. The IWIS hardware consists of Remote Sensor Units (RSUs) each connected by a cable to a single Triaxial Accelerometer (TAA). There is one IWIS RSU that also connects to eight strain gages. The Triaxial Accelerometers and strain gages receive their power from their connected RSU, which gets its power via a Green or Cobalt power brick connected to the Russian or US power system, respectively. The EWIS NCU, which commands and receives data from the EWIS RSUs, also commands and receives data from the IWIS RSUs via RF communication. The IWIS hardware configuration during the ISS Stage ULF4 S4-1A DTF is, shown in Figure 4-2, comprised of the EWIS NCU) six (6) Remote Sensor Units (RSU), six (6) triaxial accelerometer units, eight (8) strain gages, and accelerometer mounting plates.

Similarly to EWIS Scheduled Mode programming, IWIS RSUs are programmed prior to an on orbit event with a prescribed duration and sampling frequency. IWIS RSUs do not have a Continuous Mode they will only record data if preprogrammed to do so. After a programmed data take is complete the measured data is stored in the IWIS RSU until it receives a command from the EWIS NCU to download via RF to the EWIS NCU. Once the EWIS NCU has received the measured data it is passed to a SSC and later downloaded via KU-band, in the same manner as EWIS TAA data.

The IWIS accelerometers are temporarily attached to mounting plates that are installed on primary ISS structure. The mounting plates are attached to the structure using a combination of adhesive and grey tape. The IWIS strain gages are permanently mounted to the US Node 1 radial port struts. New IWIS components are scheduled to be implemented on orbit in early 2013, which will allow accelerometer data to be recorded in MRM 1 and MRM1. Also, and IWIS TAA and RSU will be installed in the MLM prior to its launch and connection to station.

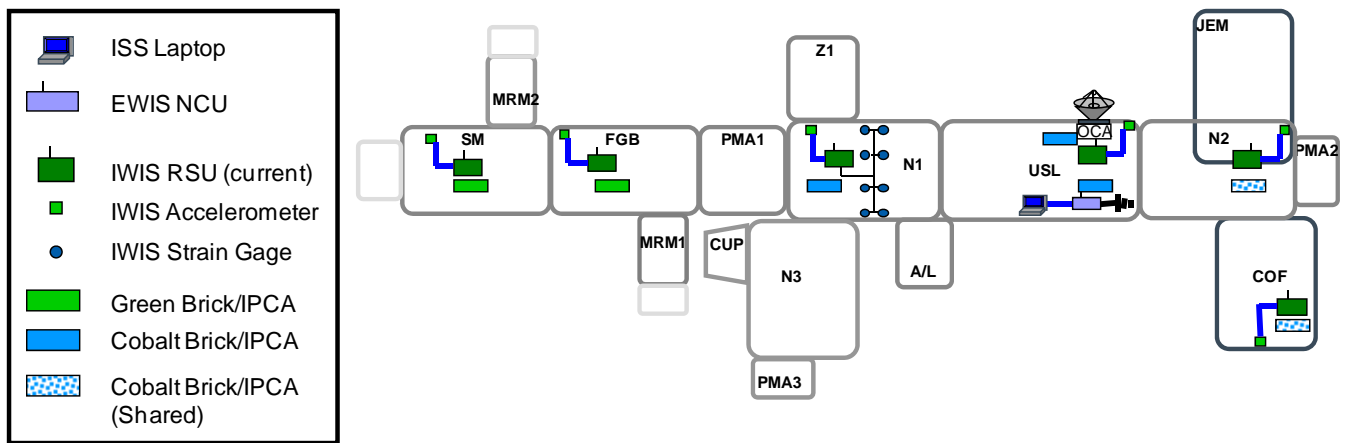

Figure 4-2: IWIS Sensor Configuration during ISS Stage ULF4 S4-1A DTF.

4.4 STRUCTURAL DYNAMIC MEASUREMENT SYSTEM

The Structural Dynamic Measurement System (SDMS) was developed by The Boeing Company for NASA-JSC. The SDMS is intended to measure on-orbit dynamic responses of the ISS Inboard Truss Segment and module-to-truss structure (MTS) struts. SDMS is comprised of 33 accelerometers, 38 strain gage bridges, and two signal conditioning units (SCUs). The accelerometers and strain gages are externally mounted on the five segments of the main inboard truss between the Solar Alpha Rotary Joints (SARJs).

The SDMS accelerometers are proof-mass type and their locations are shown in the schematic of the five inboard truss segments shown in Figure 4-3. The accelerometers are mounted in groups of one, two, and three, on the truss primary structure. Each strain gage-bridge uses four strain-gages to form a four-active-arm bridge circuit. A total of 152 strain gages were used to generate all 38 strain-gage bridges. Each strain gage bridge generates a single strain measurement. The general locations of the strain gage bridges are shown in Figure 4-3. Electrical power is provided to the accelerometers and strain gages by two SCUs. The SCUs are also used to amplify, filter, and digitize the signal output by the accelerometers and strain gage bridges. Sensor data is stored on a memory buffer before it is downlinked directly to the ground by telemetry. The SDMS can be fully operated by commands up-linked from the ground.

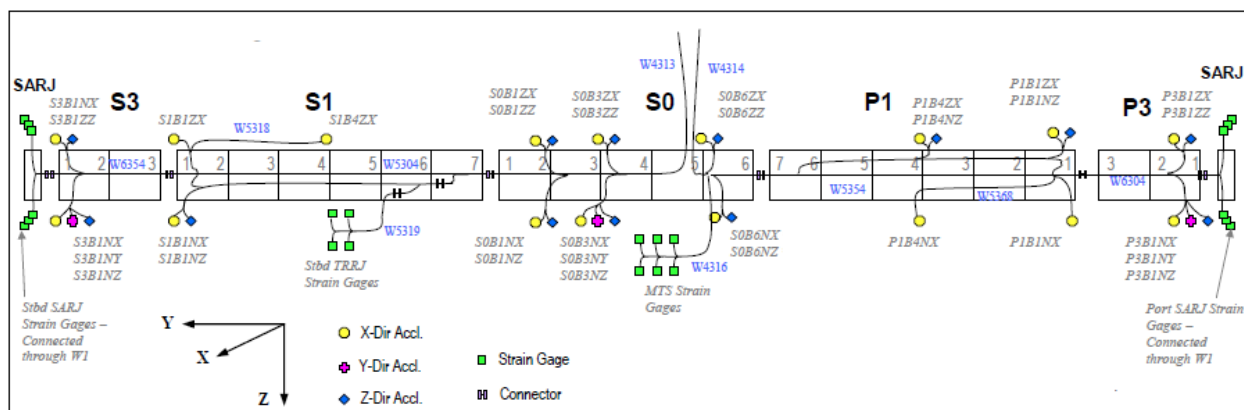

Figure 4-3: SDMS Accelerometer and Strain Gage Locations

The SDMS has a fixed sampling rate and anti-alias filtering of 40 Hz and 7.5 Hz, respectively. The SDMS system is capable of recording approximately 10.5 minutes of data. The memory buffer is circular so that if over 10.5 minutes of data is recorded, the data will be overwritten gradually starting from the buffer's beginning. When data recording stops (and over 10.5 minutes of data was collected), the last time step of the data collection immediately precedes the first time step that hasn't been overwritten. A more comprehensive discussion on the SDMS hardware can be found in [6].

4.5 Space Acceleration Measurement System (SAMS)

The Space Acceleration Measurement System (SAMS-II), Figure 4-4, provides a continuous measurement of the ISS vibratory acceleration environment from 0.01 to 300 Hz using a distributed, configurable set of tri-axial accelerometers. The accelerometers are housed inside module racks, secondary structure, instead of on the main structure like IWIS. The sensors are in racks in order to provide microgravity data for a variety of science projects, rack system analysis and for the overall ISS microgravity environment. Though these sensors are housed inside module racks, the frequency of interest for ISS loads modal correlation < 5Hz, has been found to have comparable content as the IWIS sensors on the main structure. The SAMS sensors that were recorded and used for the S4-1A DTF analysis are the US Lab sensors, F03 and F04, and JEM sensor, F05.

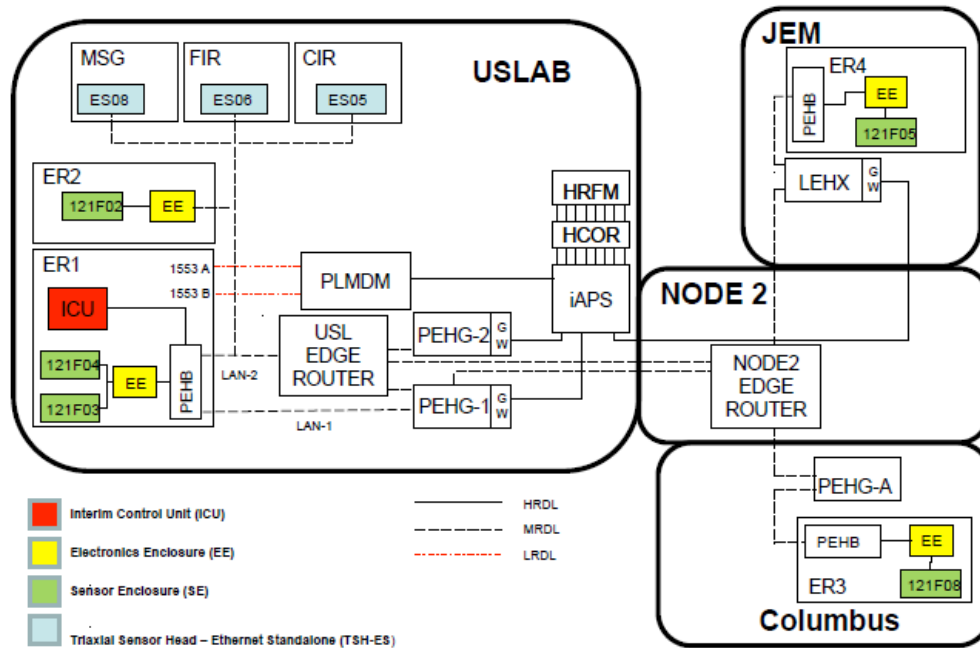

Figure 4-4: SAMS ISS Hardware

4.6 Russian Inertial Measurement Unit (IMU)

The IMU-D (Inertial Measurement Unit) is located in the MRM1 (Mini Research Module), a Russian Pressurized Module connected to the FGB (Functional Cargo Block). The sensor samples at a rate of 2400 Hz. This sensor can measure acceleration +/- 10 mg with a frequency range between 0.01 to 50 Hz. The data for a single event is recorded in 3 audio files, one file for each coordinate direction. The data is downloaded to a Russian ground site and delivered to US NASA personnel.

4.7 ISS PHOTOGRAMMETRIC SYSTEM

The ISS photogrammetric system uses EVTCG cameras outside of the ISS structure. The photogrammetric system is intended to be a non-contact instrument to record the dynamic deflections of low frequency space structures such as solar arrays, EPS radiators, and antennas. The Image Science and Analysis Group at NASA-JSC perform the photogrammetric processing of the recorded video footages to generate deflection time response histories. Daylight testing is the optimum condition for photogrammetric processing. Ideally, photogrammetric data processing should involve video footages from at least two video cameras to give a more accurate three-dimensional perspective of deflections. However, single camera approximate processing is also possible using some assumptions on the nature of the deflections. The current ISS video system and data processing method, Figure 4-5, offer a time history with a sampling rate of 15 or 30 Hz and a resolution of 0.1 inches.

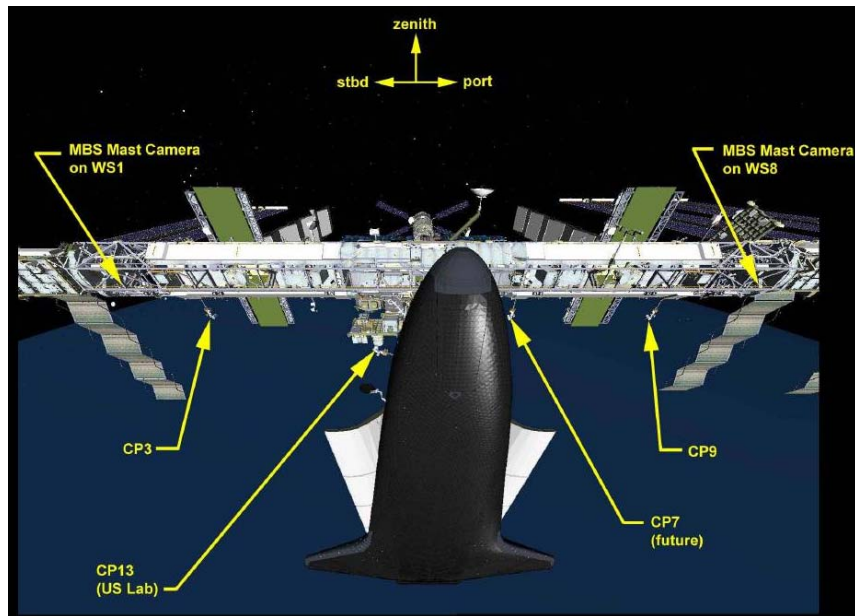

Figure 4-5: ISS Cameras used for Structural Dynamics Testing

5.0 MODAL ANALYSIS

5.1 OVERVIEW

The test data from all instrumentation systems was prepared for analysis. Time history data was converted, filtered, and plotted as needed. The power spectrum density (PSD) of this data was calculated and plotted to investigate its modal content. An attempt was made to synchronize data sets from different instrument system. This task was complicated by the fact that there is no universal time management across the different instrumentation systems. Each system has a different time keeping and standard that is not synchronized.

Modal analysis was then performed on all pre-processed data to determine the structural modal parameters, i.e., frequencies, damping factors, and mode shapes. Modal system identification was also performed separately on the photogrammetry displacement data and MTS strut strain gage data.

5.2 MODAL ANALYSIS PROCEDURE

Traditional modal analysis methods using frequency response functions (FRFs) were not used since the input excitation forces were not measured and the duration of free decay data is short. A special modal identification method [7] was used on the accelerometer data, which has been developed for applications to large space structures. It is a time-domain, free-decay method based on the Eigensystem Realization Algorithm (ERA) [8] and a time-domain zooming technique. This method does not require input force measurements and characterizes nonlinearities with a series of linearized modal parameters during the free-decay period.

To utilize the time-zooming technique, each data segment was first detrended to remove the constant and linear biases. The detrended data was filtered by a number of bandpass filters to emphasize different frequency ranges. The filtered data was then decimated to reduce the sampling rate. The intent of this combined filtering and decimation process is to emphasize the frequency content of the data in certain bandwidths. This process is comparable to a frequency-domain zooming technique used in the traditional modal analysis methods. It is again noted that the selected modal analysis process is based on a free-decay method and applied to the free-decay portion of the data sets. The ERA modal extraction is applied to several data time windows varying in length. This is performed to extract the most consistent modal content present in the data. The whole process described herein has been implemented in a Boeing proprietary MATLAB™ based Graphical User Interface (GUI) software entitled “The Boeing Modal Refinement and Identification Tool” (The Boeing MoReID).

The Boeing Test Analysis Correlation Solutions (BTACS), another Boeing proprietary interactive engineering MATLAB™ based GUI, was used to extract modal parameters from the MTS strut strain gage and photogrammetry data. BTACS has a system identification tool that extracts parameters through system realization using the Hankel matrix along with the singular value decomposition method.

5.3 SAMPLE DATA PLOTS

The S4-1A Dedicate Thruster Firing Test consisted of two sets of thruster firings. Each set of firings was designed to excite distinct sets of Truss and Module modes. Figure 5-1 through Figure 5-6 show SDMS time history accelerometer data plots for the yaw and pitch firings of the DTF test. Figure 5-1 is SDMS S3 (Starboard Truss Segment) ISS X direction accelerometer data, which shows the Yaw firing (first firing at t=60s) has higher magnitude in the ISS X direction than the pitch firing (second firing at t=360s), as expected. Figures 5-4 through 5-6 are the plots of the SDMS S0 (Center Truss Segment) ISS Z direction accelerometer data, which show a higher acceleration magnitude during the pitch firing.

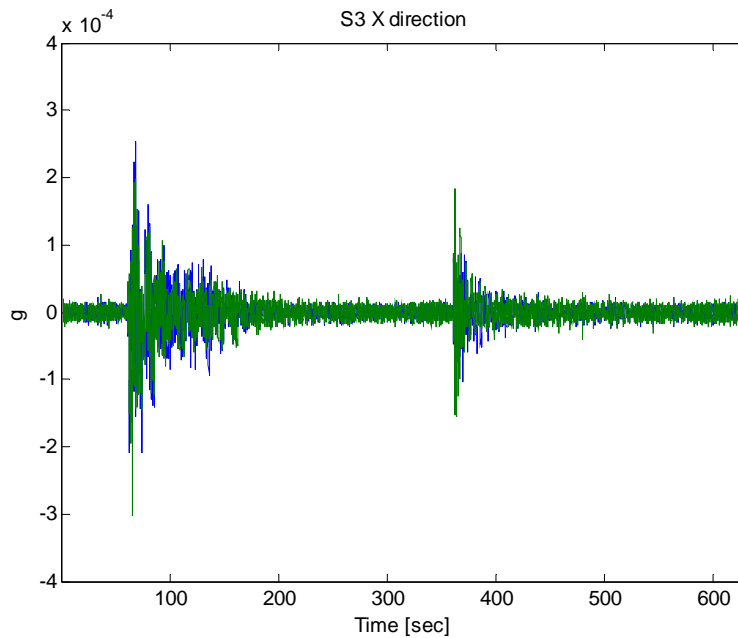

Figure 5-1. DTF S4-1A S3 ISS X: SDMS: Time History

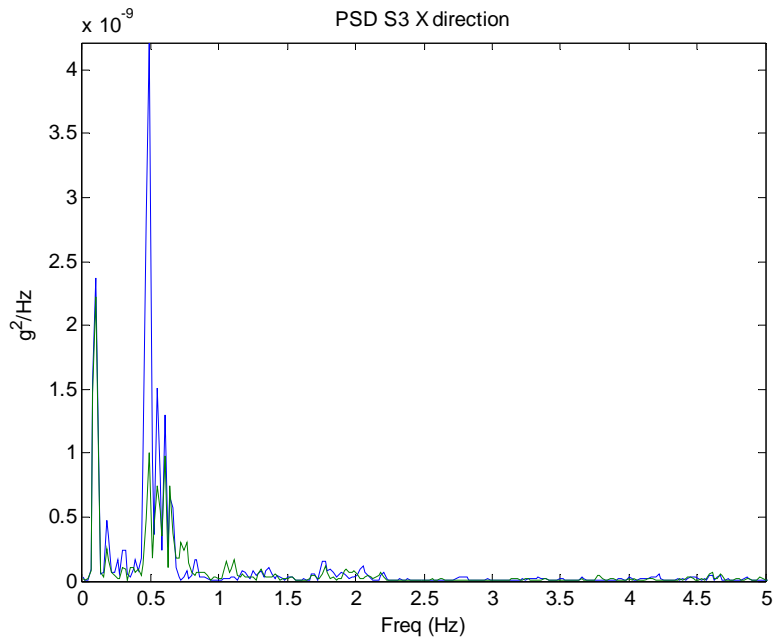

Figure 5-2. DTF S4-1A S3 ISS X: SDMS: PSD

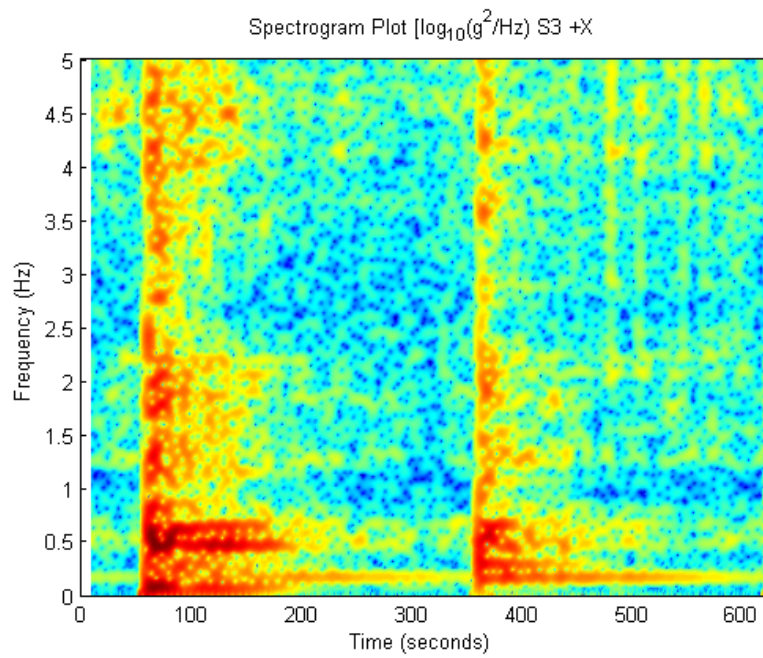

Figure 5-3. DTF S4-1A: SDMS S3 ISS X: Spectrogram

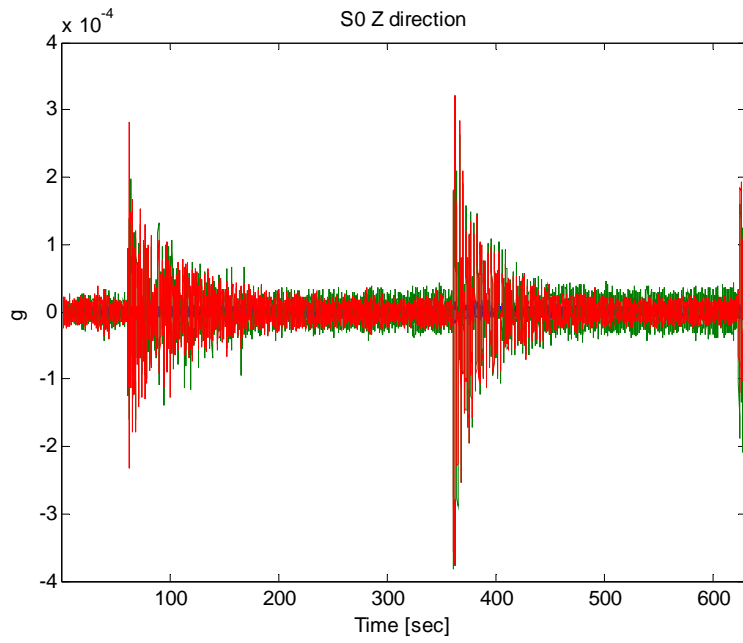

Figure 5-4. DTF S4-1A: SDMS S0 ISS Z: Time History

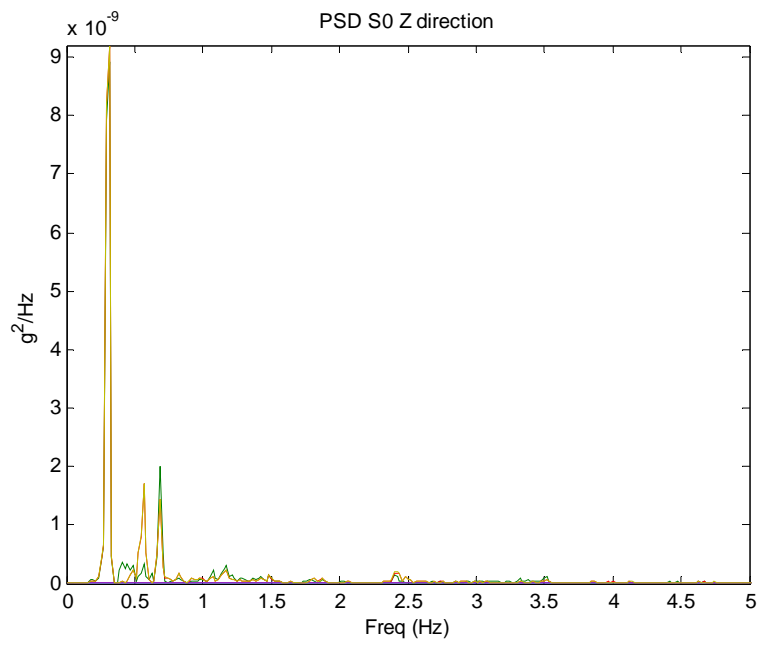

Figure 5-5. DTF S4-1A: SDMS S0 ISS Z: PSD

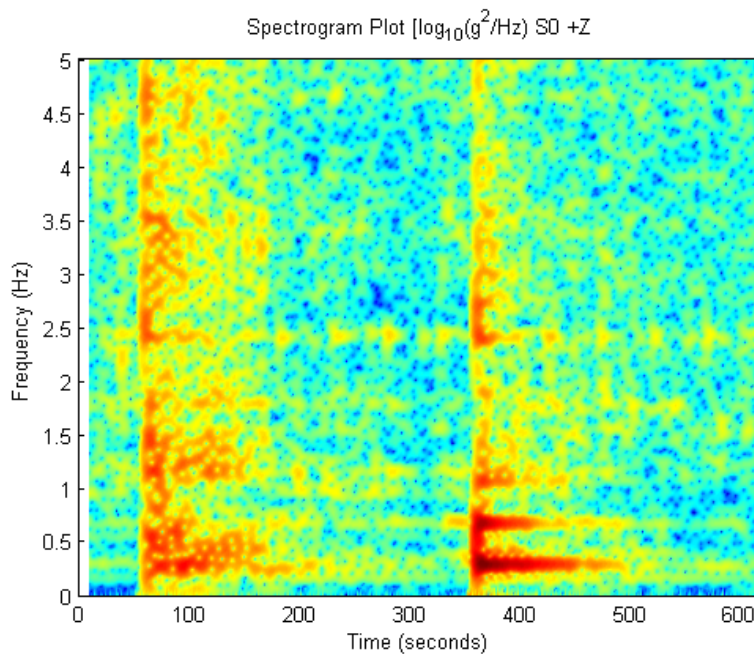

Figure 5-6. DTF S4-1A: SDMS S0 ISS Z: Spectrogram

6.0 MODEL CORRELATION AND VALIDATION

6.1 OVERVIEW

International Space Station integrated loads and dynamics verification and validation procedures are defined in Ref. [9]. Verification procedures are intended to insure that the on-orbit structure satisfies its structural requirements. Among others, these requirements include the verification that the structure can accommodate on-orbit loads. The model of the structure used in the verification of the on-orbit loads must be validated [4]. One of the requirements in the validation plan states that test and analytical modal frequencies agree within 5% for primary modes and within 10% for secondary modes [**Error! Reference source not found.**]. The model validation plans are intended (i) to prove that the on-orbit models satisfy the validation requirements or (ii) to refine the on-orbit models so that they satisfy the validation requirements.

6.2 MODE CORRELATION AND MODAL ANALYSIS

The task of matching test and analytical modes is commonly performed by evaluating the Modal Assurance Criteria (MAC) [10] and the Cross-Orthogonality (XOR) matrices [11]. Both MAC and XOR matrices are indicators that show the level of correlation between test and analytical mode shapes. These indicators are only meaningful with a large number of mode shape measurements spanning a wide spatial distribution. For the ISS, it is desirable to have two sensors in each ISS module; at least one sensor at each side of an interface. This would aid in defining axial and bending modes. Furthermore, the addition of three sensors placed in each ISS module would aid in defining ISS torsion modes. Such criteria are only partially met by modes extracted from the IWIS, SDMS, EWIS, SAMS and IMU-D dynamic measurement systems.

In the computation of the XOR matrix, a reduced mass matrix, having degrees-of-freedom (DOFs) consistent with the measurement DOFs, is needed. A reduced mass matrix for this particular problem requires a significant reduction from over several thousand DOFs (residual model) to less than 75 DOFs and was unavailable for this study. The computation of the MAC matrix does not require the use of a reduced mass matrix. Thus, test-analytical mode correspondences based on the MAC was used for the modes extracted from the ISS sensor systems.

It should be noted that the damping was very difficult to estimate with the type of on orbit test that was conducted and the type of data that was available. In order to estimate modal damping with high confidence, free decay data created from a test with several input sites is required. The S4-1A DTF had one input site, the SM thrusters, it is not feasible to conduct an on-orbit dynamic test on the ISS with multiple input sites and nominal on-orbit dynamic events (i.e., vehicle dockings, undockings) do not have the characteristics of this ideal data.

The analytical model and test data both exhibit high modal density above 1.5 Hz. Also, the data exhibits very low modal amplitude above 2.0 Hz. Therefore, mode correlation above 1.5 Hz was very difficult.

The photogrammetry data that was collected on the 1A solar array wing, attached to starboard truss segment S4, using ISS ETVCG cameras was analyzed independently from the accelerometer data. The Image Science and Analysis Group at NASA JSC received the analog video and, using their image processing software, created discrete displacement time history data sampled at 30 Hz. Modal parameters were extracted from this data and was used to assess the frequency and structural damping of the fundamental US PV Array modes.

The SDMS MTS Strut Strain Gage data that was collected during the S4-1A data was also analyzed independently from the accelerometer data. This data was used to investigate a low frequency mode that exhibits nonlinear characteristics. The mode under investigation can range in frequency from 0.08 to 0.11 Hz depending on the amplitude of the response.

The following sections will give results for the photogrammetry array data, the MTS strain gage data and the accelerometer data of the S4-1A DTF.

6.3 STAGE ULF-4: Dedicated Thruster Firing S4-1A – RESULTS

The analytical model was created in detail to match the ISS configuration during the time of the S4-1A DTF. The visiting vehicles, the solar array rotary joints (SARJ) angles, the array angles and the ISS robotic arm location were all represented in the NASTRAN system model, Figure 6-1.

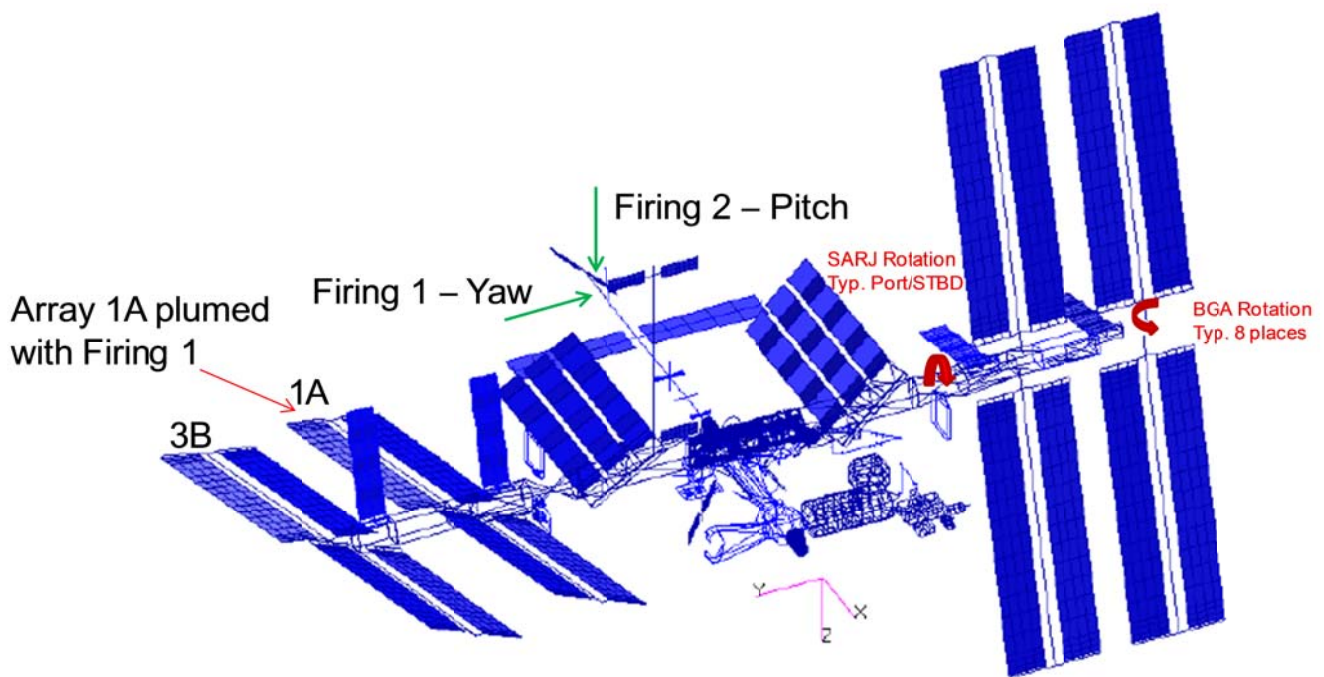

Figure 6-1: NASTRAN System Model S4-1A DTF

6.3.1 S4 - 1A Photogrammetry Results

The Image Science and Analysis Group (ISAG), at NASA JSC received analog video taken during the S4-1A DTF from two ISS ETVCG cameras. The cameras used were CP3 located on the S1 starboard truss segment and CP13 located on the US Lab. The ISAG used their image processing software to track two points at the end of the 1A Solar Array Wing, Figure 6-2. One point was on the mast cap located at the end of the mast of the solar array. The second tracked point was on the tip of the blanket box at the end of the solar array. The motion of each point was tracked in each video sequence and used to compute the relative displacement of the SAW tip in each axis, defined by the plane of the array during the DTF. Due to the high mathematical correlation between the axial and out-of-plane (OP) motion, the calculations were conducted in a way which

constrains the axial position to a fixed value of 0. This constraint is acceptable given that the motion of the array in the axial direction is significantly less than the in-plane (IP) or out-of-plane (OP) motions.

The displacement time history data was detrended and the modal parameters were extracted and analyzed using the system identification tool of BTACS. The BTACS system identification tool includes a method that extracts modal parameters within a set window over a prescribed period of time within the data set, Figure 6-3. The first firing set, Yaw direction, plumed the 1A array and provided the best data set for identifying the modal parameters. The second firing set, Pitch direction, was also analyzed but did not provide as high a quality results as the data from the first firing. The first two modes identified in the Yaw firing data showed an increase in frequency during the free decay of the array motion. The frequency shift overtime can be seen in the BTACS system ID window in Figure 6-4. The comparison results between the extracted modal parameters from the data and the analytical modal parameters are summarized in Table 6-1. The first OP mode had a frequency range from 0.064 to 0.068 Hz. The first IP mode had a frequency range of 0.097 to 0.104 Hz. There was also an array torsion mode identified at 0.096 Hz which is closely spaced with the first IP mode and these modes appear to interact with each other. There was also a second OP mode identified at 0.146 Hz. The results of the S4-1A photogrammetry analysis, along with the analysis conducted on other arrays, will aid in reducing the restrictions in the solar array constraint matrices; used by ISS ground personnel to select appropriate array angles to park solar arrays prior to a dynamic on orbit event (i.e. vehicle docking).

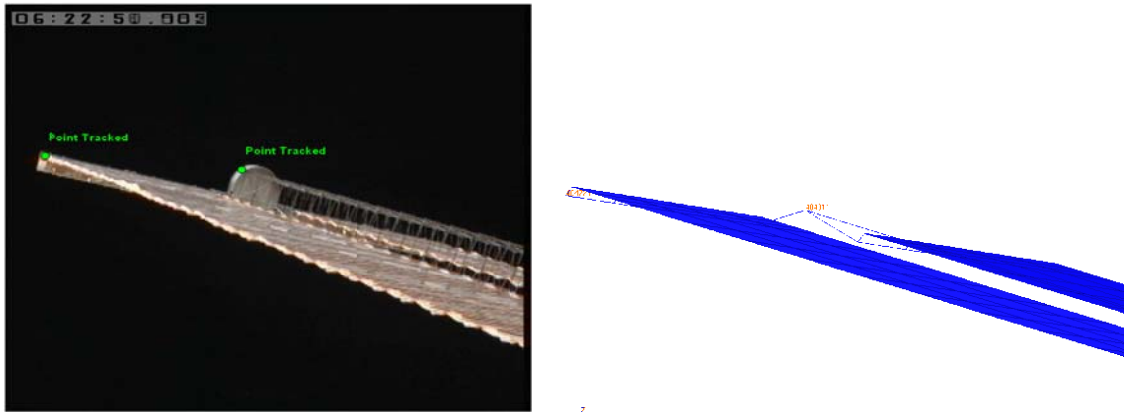

Figure 6-2: Tracked points of 1A, Left: Camera Image, Right: PATRAN™ Image

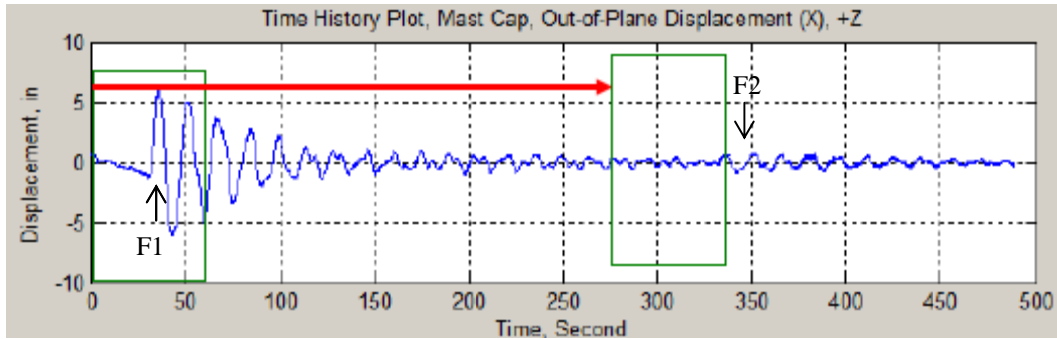

Figure 6-3: Time History, 1A Array Mast Cap, Out-of-Plane, Detrended

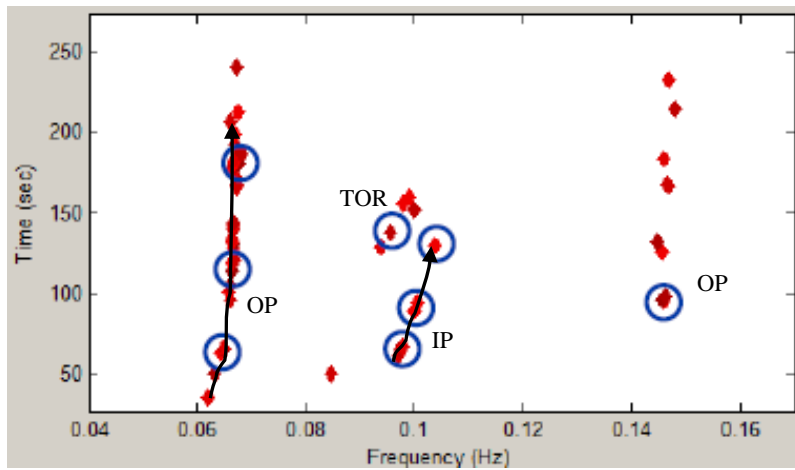

Figure 6-4: BTACS Sys ID Results for 1A Photo-g Data of S4-1A DTF F1

Table 6-1: BTACS Sys ID Results/MAC for 1A Photo-g Data of S4-1A DTF F1

Mode Description	On-Orbit			Analytical			
	Time	Freq (Hz)	% Damping	Mode #	Freq (Hz)	MAC	% Freq. Dif.
OP	Beg	0.064	8.58	16	0.067	0.975	3.8
-	Mid	0.066	1.90	-	-	0.964	0.7
-	End	0.068	0.34	-	-	0.974	-1.1
IP	Beg	0.097	2.96	20	0.096	0.953	-1.4
-	Mid	0.100	2.05	-	-	0.933	-3.9
-	End	0.104	3.22	-	-	0.975	-7.5
TOR	Constant	0.096	0.81	30	0.1	0.984	4.5
OP	Constant	0.146	0.64	60	0.151	0.955	3.6

6.3.2 S4-1A MTS Strut Strain Gage Analysis

In 2011 a maneuver was conducted that produced loads that were 25% higher than predicted loads. An investigation into the event found there was controller-structure-interaction; the controller was amplifying an excited structural mode. The mode in question had previously been identified with on orbit data and was found to correlate well with the shape of the corresponding analytical mode, having a MAC > 0.9 repeatedly, but could range in frequency difference from 2% -18%, even during the same ISS stage. The mode is an ISS XY global mode, where the truss and pressurized modules make a scissor like motion about the module-to-truss structure (MTS) struts. The MTS struts connect the pressurized modules to the truss segments of the ISS. The analytical reconstruction of the event produced high bending loads at the Node 1 to Lab interface, consistent with high MTS strut loads. SDMS MTS Strut strain gage data, for several on orbit events, was analyzed using the BTACS system identification tool which includes a method that extracts modal parameters within a set window over a prescribed period of time within the data set. This section will focus on the results of the data collected during the S4-1A DTF.

The SDMS MTS Strut strain gage time history data, bandpass filtered 0.03 Hz-0.2 Hz, for the S4-1A DTF is shown in Figure 6-5. The first firing is a yaw firing which excited the low frequency ISS XY mode with more energy than the pitch firing that followed. A visual of the frequency results of the system identification analysis is shown in Figure 6-6. The modal parameters were extracted from 12 time periods throughout the first firing. A modal assurance criterion (MAC) was calculated between each extracted mode. The MAC values between each extracted mode were all above 0.92; confirming that the tool was identifying the same mode over time with a changing frequency. The frequency of the mode shows a dependence on the magnitude of the data that was used for the extraction. The frequency, damping and EMAC value of the extracted modes is presented in Table 6-2: BTACS Sys ID Results for MTS Strain Gage Data of S4-1A DTF F1.

The investigation into the SDMS MTS strut strain gage data, which incorporated several data sets including the S4-1A data, concluded that the mode was nonlinear. Being a nonlinear mode, the frequency of its free vibration is dependent upon the free vibration amplitude. This amplitude dependent frequency characteristic was seen in the BTACS system identification results where the frequency of the mode changed 44% over the decay of S4 1A DTF Firing 1. The findings of the MTS Strut Strain Gage data analysis will feed into updating the thruster control algorithm to avoid controller-structure-interaction.

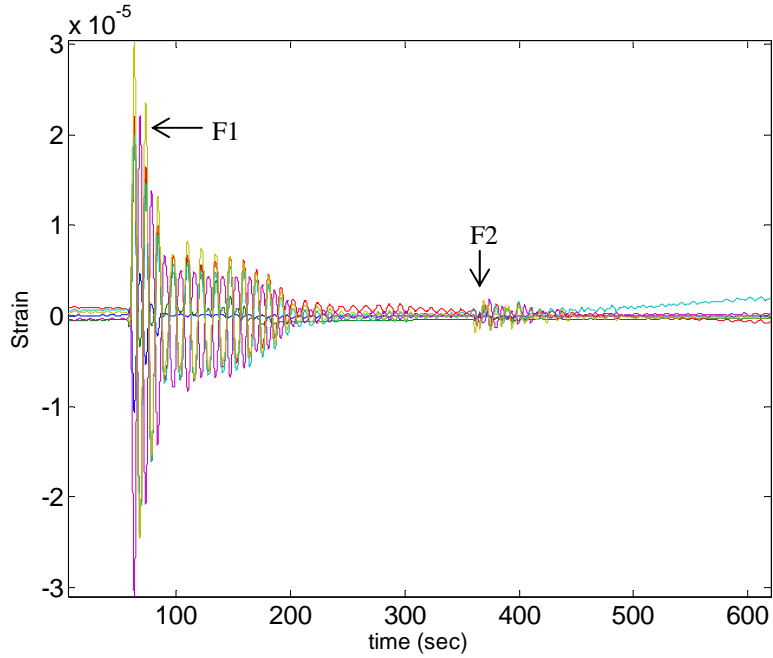

Figure 6-5: SDMS MTS Strain Gage Time History Data S4-1A DTF

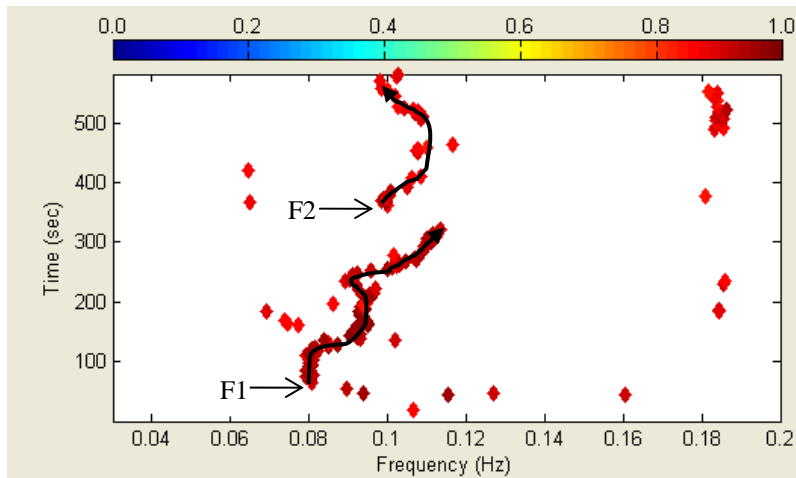

Figure 6-6: BTACS Sys ID Results, EMAC>85%, for MTS Strain Gage Data of S4-1A DTF

Table 6-2: BTACS Sys ID Results for MTS Strain Gage Data of S4-1A DTF F1

Time (sec)	Freq (Hz)	Damping	EMAC (%)
75	0.079	1.26	92.7
99	0.080	1.69	93.7
123	0.082	3.67	94.8
135	0.081	6.82	95.4

159	0.093	5.45	97.1
189	0.094	7.61	96.8
210	0.095	5.22	93.9
216	0.097	5.09	95.8
282	0.109	2.51	94.4
303	0.111	1.77	94.4
318	0.113	1.1	93.4
321	0.114	0.33	91.7

6.3.3 S4-1A Model Correlation

Using the Boeing MoReID Global ERA tool, modes were extracted from the combined accelerometer data sets of the S4-1A DTF Firing 1 and Firing 2. Each thruster firing set was treated as a separate on orbit data test. The first step in the correlation effort was to compare the test modes extracted from Firing 1 with Firing2 with the intent to show the consistency of the modes extracted from each of the dynamic responses. Due to the different types of thruster firings there were some modes that were excited by one firing set and not the other. The MAC was calculated using all of the accelerometers, all the accelerometers minus the IMU-D sensor, using only the pressurized module accelerometers and then using only the truss accelerometers. The MAC was calculated using different sets of accelerometer groups in order to determine the effect each sensor group had on the overall MAC value between the two firing sets; reason being the IMU-D and SAMS sensors have not been used for the purpose of model correlation before. The Firing 1 test mode 1 and 2 are the same mode, extracted twice, at different times within the data set, the overlay of the two mode shapes is presented in Figure 6-8 [A]. The difference in frequency of this mode is due to the dependence this mode has on free vibration amplitude, as discussed in section 6.3.2. In general, the results shown in Table 6-3 show good MAC correlation for the modes that were extracted with a high level of confidence.

Table 6-3: ISS Stage ULF4 S4-1A DTF Test/Test Correlation

Firing 1 Yaw		Firing 2 Pitch		Accel Group				Freq
Mode #	Freq	Mode #	Freq	All MAC	w/o IMU-D MAC	Modules MAC	Truss MAC	% Dif
1	0.084	1	0.1	0.977	0.977	0.987	0.969	18.4
2	0.104	1	0.1	0.985	0.987	0.99	0.984	-3.7
3	0.186	2	0.182	0.913	0.918	0.741	0.929	-2.5
8	0.308	5	0.304	0.96	0.957	0.974	0.957	-1.3
11	0.575	7	0.56	0.644	0.737	-	0.837	-2.7
14	0.771	9	0.748	0.68	0.729	-	0.801	-2.9
19	0.948	11	0.912	0.549	0.777	-	0.829	-3.8
24	1.481	14	1.55	-	-	0.622	-	4.7

The test/analytical correlation for the ISS Stage ULF4 S4-1A DTF configuration is shown in Table 6-4. The test modes that were excited from both firings and showed good correlation among themselves showed good MAC values with the analytical model modes. The modes that were excited well in one firing and not in the other firing, modes with higher frequency and mostly confined to one coordinate plane, also showed good MAC values when compared to the analytical model. The range of frequency differences of the first mode is linked to the nonlinear behavior seen in the on-orbit test mode, where the analytical model is a linear model and does not capture the nonlinear behavior of this mode. A diagram of an extracted mode shape overlaying the ISS structure is shown in Figure 6-7. That diagram is to aid in visualizing the other mode shape comparisons displayed in Figure 6-8 [A thru F], Figure 6-9 [G thru L], and Figure 6-10 [M thru N].

Table 6-4. Stage ULF4 S4-1A DTF: Test/Analysis Correlation: Accel Data

Test Data					Analytical Data					
Mode #	Freq. (Hz)	Damp (%)	EMAC CMI	F1-F2 MAC	Mode #	Freq. (Hz)	Freq. Diff (%)	Accel Group	MAC	Mode Description
2-F1	0.104	4.011	79 / 61	0.985	44	0.113	9.3	ISEMLJ	0.862	Station XY / Module & Truss
1-F2	0.1	2.903	87 / 69		44	0.113	13.5	ISEMLJ	0.847	"
1-F1	0.084	3.137	94 / 85	0.977	44	0.113	34.4	ISEMLJ	0.839	"
3-F1	0.186	1.107	83 / 47	0.931	83	0.172	-7.9	ISEMLJ	0.889	Truss XY Bending / Module XZ
2-F2	0.182	1.416	94 / 69	0.931	83	0.172	-5.5	ISEMLJ	0.933	"
3-F2	0.221	2.626	89 / 32		102	0.225	1.6	SE	0.731	Module & Truss XZ
					102	0.225	1.6	ISE	0.669	"
7-F1	0.259	1.36	83 / 48		125	0.271	8.1	ISEMLJ	0.782	Station XY (JEM XY)
								IMLJ	0.873	"
8-F1	0.308	0.394	90 / 25	0.96	142	0.285	-7.5	ISEJ	0.789	Station XZ
5-F2	0.304	1.249	97 / 23		142	0.285	-6.3	ISEJ	0.811	"
6-F2	0.404	1.464	82 / 3		175	0.368	-9	ISEMLJ	0.705	Truss YZ / Module TOR X / HRS Torsion
7-F2	0.56	1.639	76 / 19	0.742	254	0.494	-11.7	S	0.823	Station TOR X / Truss XYZ
11-F1	0.575	1.157	84 / 58		254	0.494	-14	S	0.746	"
8-F2	0.684	1.13	84 / 58		303	0.666	-2.6	I	0.885	RSA Module XZ / COL JEM OB Truss YZ
14-F1	0.771	0.484	87 / 37	0.741	313	0.719	-6.7	IS	0.83	RSA Modules XY / COL JEM YZ / Truss XYZ
9-F2	0.748	0.318	83 / 54		313	0.719	-3.9	IS	0.811	"
17-F1	0.853	0.627	80 / 57		354	0.86	0.8	IS	0.903	RSA Module YZ / Truss XYZ
16-F1	0.827	1.014	90 / 71		339	0.793	-4.2	IS	0.748	Staion XY / EPS OP
18-F1	0.906	1.331	80 / 18	0.777	354	0.86	-5.1	IS	0.749	RSA Module YZ / Truss XYZ
11-F2	0.912				354	0.86	-5.7	S	0.869	"
14-F2	1.55	0.411	81 / 40		511	1.508	-2.7	I	0.83	COL JEM YZ / Mocules XZ 2nd
25-F2	2.901	0.856	76 / 44		833	2.78	-4.2	IML	0.763	Module XZ (3rd Bending) / truss XY
56-F2	4.572	0.31	84 / 17		962	4.109	-10.1	SE	0.703	US LAB N2 XY / RSA XZ / Truss XYZ
57-F2	4.556	0.06	81 / 49		962	4.109	-9.8	IS	0.753	"

Note: S-SDMS, I-IWIS, E-EWIS, M-IMU-D, L-SAMS Lab, J-SAMS JEM

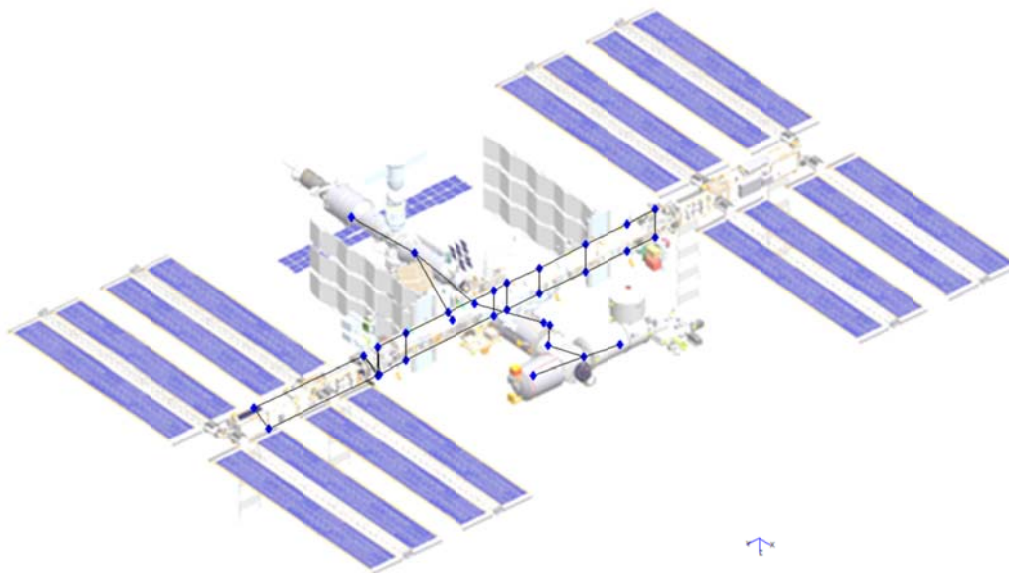
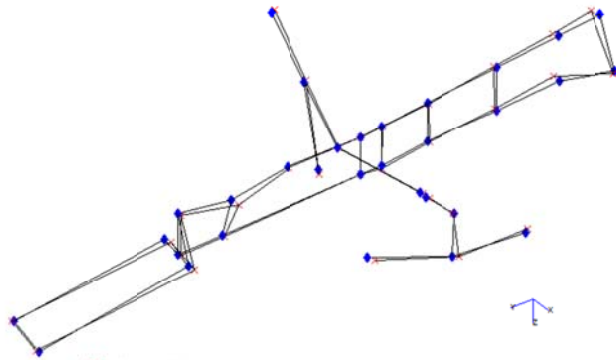
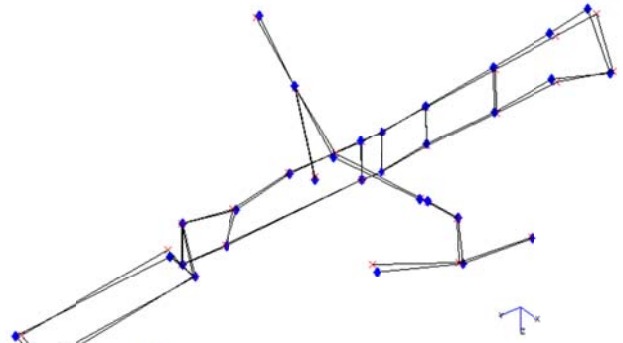

Figure 6-7: Sensor Location Mode Shape Diagram



x S4-1A F1 Mode 1: 0.084 Hz
 ◆ S4-1A F1 Mode 2: 0.104 Hz
 MAC = 0.97, Freq Dif = 22.9%

[A] S4-1A F1 Mode 1 vs.. S4-1A F1 Mode 2



x S4-1A F1 Mode 1: 0.084 Hz
 ◆ S4-1A F2 Mode 1: 0.1 Hz
 MAC = 0.98, Freq Dif = 18.4%

[B] S4-1A F1 Mode 1 vs. S4-1A F2 Mode 1

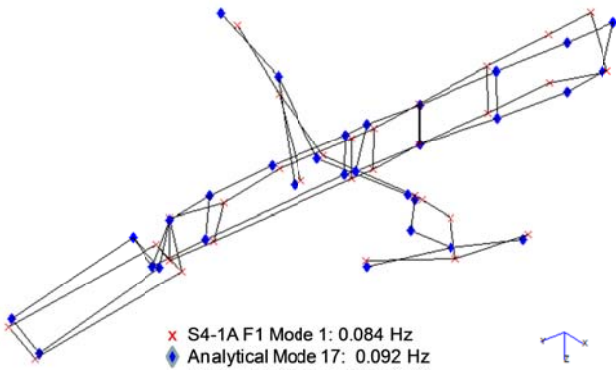

x S4-1A F1 Mode 1: 0.084 Hz
 ◆ Analytical Mode 17: 0.092 Hz
 MAC = 0.731, Freq Dif = 8.7%

[C] S4-1A F1 Mode 1 vs. Analytical Mode 17

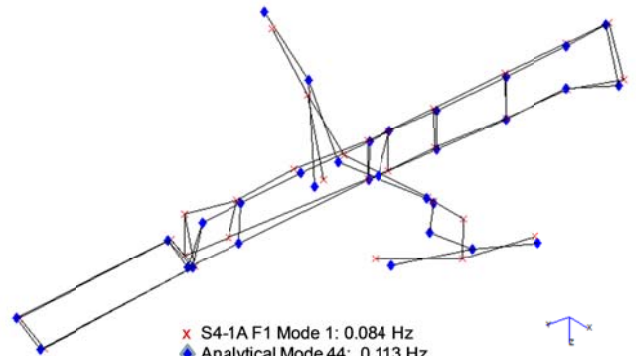

x S4-1A F1 Mode 1: 0.084 Hz
 ◆ Analytical Mode 44: 0.113 Hz
 MAC = 0.839, Freq Dif = 34.4%

[D] S4-1A F1 Mode 1 vs. Analytical Mode 44

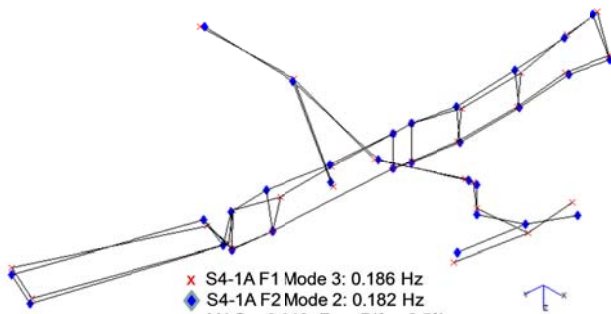

x S4-1A F1 Mode 3: 0.186 Hz
 ◆ S4-1A F2 Mode 2: 0.182 Hz
 MAC = 0.913, Freq Dif = -2.5%

[E] S4-1A F1 Mode 3 vs. S4-1A F2 Mode 2

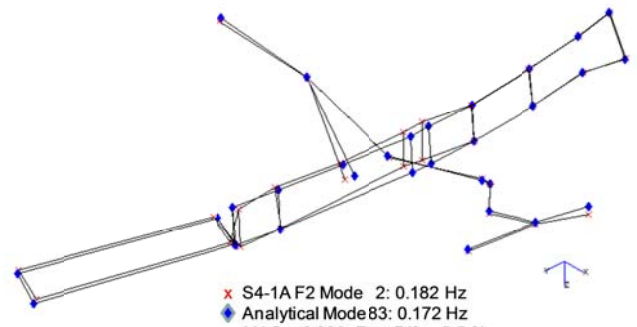

x S4-1A F2 Mode 2: 0.182 Hz
 ◆ Analytical Mode 83: 0.172 Hz
 MAC = 0.933, Freq Dif = -5.5 %

[F] - S4-1A F2 Mode 2 vs. Analytical Mode 83

Figure 6-8: Mode Shape Overlays, Test/Test and Test/Analytical [A thru F]

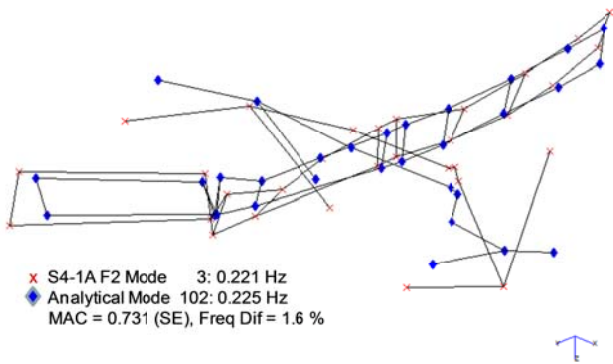

[G] S4-1A F2 Mode 3 vs. Analytical Mode 102

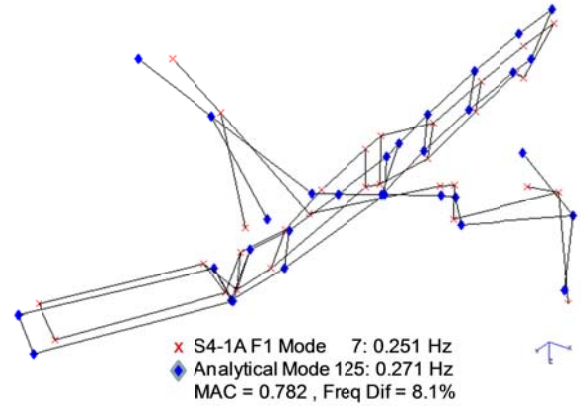

[H] S4-1A F1 Mode 7 vs. Analytical Mode 125

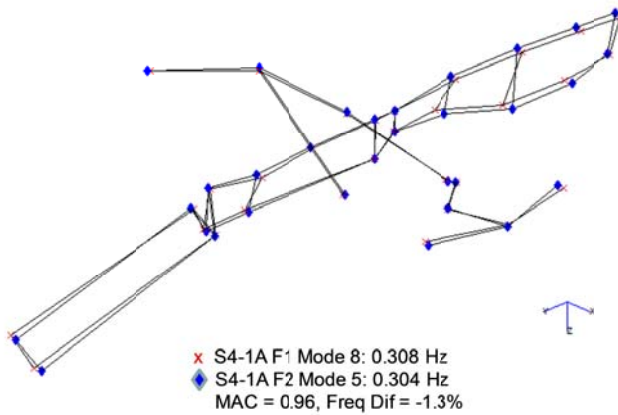

[I] S4-1A F1 Mode 8 vs. S4-1A F2 Mode 5

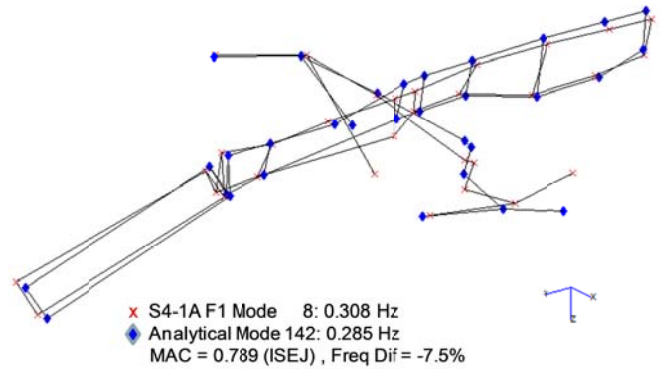

[J] S4-1A F1 Mode 8 vs. Analytical Mode 142

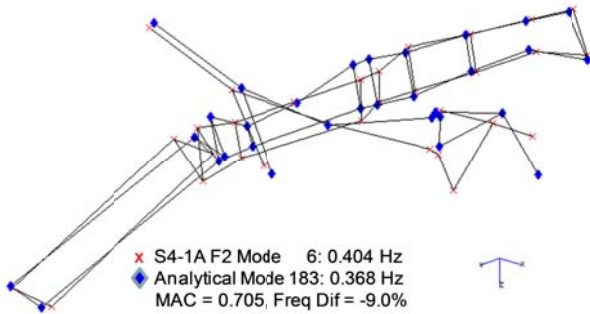

[K] S4-1A F2 Mode 6 vs. Analytical Mode 183

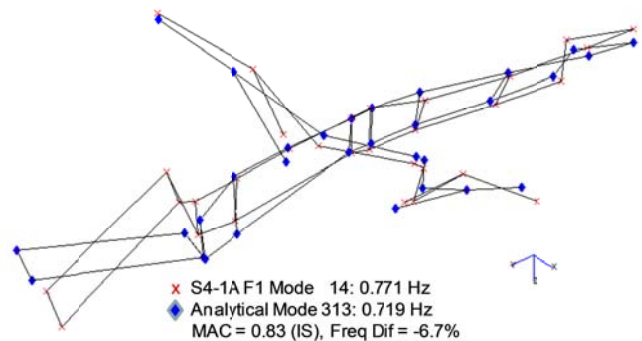

[L] S4-1A F1 Mode 14 vs. Analytical Mode 313

Figure 6-9: Mode Shape Overlays, Test/Test and Test/Analytical [G thru L]

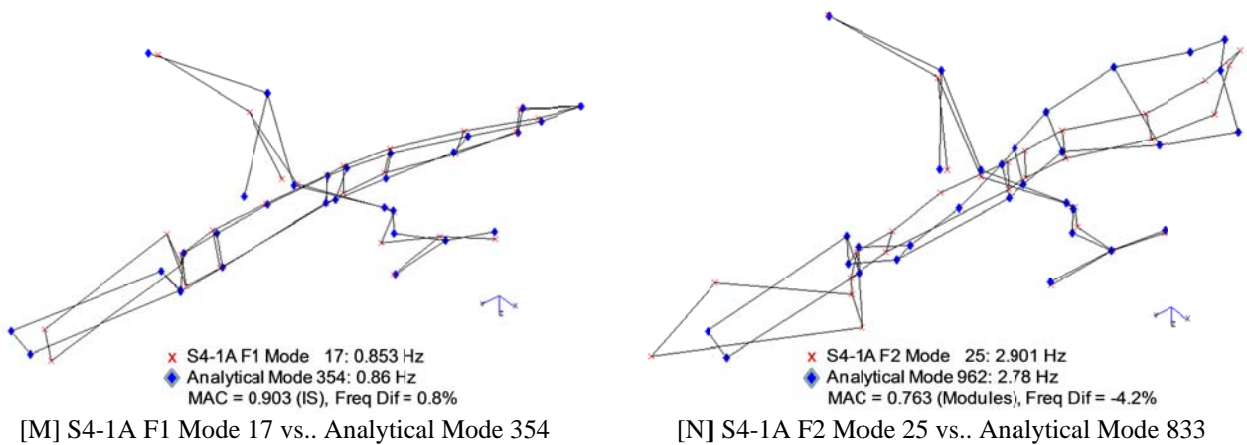

Figure 6-10: Mode Shape Overlays, Test/Test and Test/Analytical [M thru N]

7.0 CONCLUSIONS

On-orbit structural dynamic data was collected during the ISS Stage ULF4 S4-1A DTF using a variety of instrumentation systems. The main intent of these analyses was to measure dynamic responses of the ISS in order to validate and correlate analytical models. The main instrumentation systems that were utilized during the data collections included Internal Wireless Instrumentation System (IWIS), External Wireless Instrumentation System (EWIS), Structural Dynamic Measurement System (SDMS), Space Acceleration Measurement System (SAMS), Internal Measurement Unit (IMU) and ISS EVTCCG Cameras. The photogrammetry data of the 1A Solar Array Wing was used to increase the confidence in the frequency and damping of the fundamental array modes, which will feed into the development of less restrictive solar array constraint matrices. The SDMS MTS Strut strain gage data was used to investigate a low frequency mode whose frequency is dependent on the free vibration amplitude. The results of that study will feed into the update of the thruster control algorithm to avoid controller-structure-interaction. Modal analysis was performed on all measured accelerometer data to extract modal parameters including, frequencies, damping factors, and mode shapes. An analytical math model was developed to simulate the on orbit configuration of the ISS during the time of the S4-1A DTF. The developed models incorporated, as closely as possible, the actual on-orbit configurations including array angles, boundary and interface conditions. The identified test modes were correlated and compared to analytical modes to verify the accuracy of analytical model.

7.1 DISCUSSIONS

The analysis summarized in this report is essential to ensure, among others, accurate loads and load spectra predictions of ISS components, which could affect the ability to predict structural life consumption, determine structural health, verify future stages, and continue to ensure crew safety. The following general conclusions were drawn from the overall analysis. These conclusions are mostly consistent with the general trends that were observed from previous port-flight analysis [12-15,23].

- From the measured and analyzed data, it was determined that the most effective instrumentation systems are the IWIS, SDMS, EWIS and SAMS. These instrumentation systems have the appropriate sensor quantity, quality and locations for successful modal identification and model validation. The SAMS accelerometers, although mounted on secondary structural elements, were useful in modal parameter extractions for the structural frequency range of 0-5 Hz.
- Mode shape information proved to be indispensable in matching test and analytical modes using the MAC correlation. It is noted that the test/analysis correlation is a prerequisite in any model validation effort. The MAC is effective when the measured mode shapes have several components spanning a wide area. The MAC correlation also requires that the mode shapes be extracted with high confidence.
- Mode shapes were extracted with higher confidence than damping factors but with less confidence than natural frequencies. This is due to the type of on orbit dynamic test and the ISS not being a static test subject.

- The damping factors, for the same mode, vary considerably between different on-orbit dynamic events. A general trend of the variation was difficult to assess from one event to another and from different time segments of the same response.
- In general, damping factors identified from the test data are greater than the damping values of 1.0% used in the analysis.
- The SAMS and MAMS microgravity sensors have proven to be valuable as a structural condition monitoring system. The SAMS and MAMS data have assisted in several anomaly identifications and resolutions. These sensors also provide good structural frequency information and good information on the response of the ISS due to the applied excitation (crew IVA, reboost, docking, etc.).
- The EWIS system, with its trigger mode to monitor for unforeseen dynamic events and its ability to take up to 3 hours of scheduled mode data has been invaluable for monitoring the vibrations seen on the outboard truss segments along with monitoring the health of the solar array rotary joints (SARJ).

8.0 REFERENCES

1. Kim, H.M., Bartkowicz, T.J., and VanHorn, D.A., "Data Recovery and Model Reduction Methods for Large Structures," *Finite Elements in Analysis and Design*, Vol. 16, No. 2, pp. 85-98, June 1994.
2. Kim, H.M. and Kaouk, M., Final Report: Mir Structural Dynamics Experiment, The Boeing Company, Contract No. NAS15-10000, December 1998.
3. "Station Development Test Objective (SDTO) Catalog," SSP 50448, Rev. C, NASA-JSC, March 2007.
4. "Space Station Structural Loads Control Plan", Boeing Report No. D684-10019-1, March 1994.
5. "Internal Wireless Instrumentation System (IWIS) Interface Definition Document," JSC 28369, Rev. D, Engineering Directorate Avionic Systems Division, NASA-JSC, October 2000.
6. "ISSA PG-1 On-Orbit Instrumentation for SDMS, Rev.1," Boeing Memorandum A95-J012-SEM-M-9500771R1, May 1995.
7. Kim, H.M., VanHorn, D.A., and Doiron, H.H., "Free-Decay Time-Domain Modal Identification for Large Space Structures," *J. GUIDANCE*, Vol. 17, No. 3, pp. 513-519, May 1994.
8. Juang, J.N., Pappa, R.S., "An Eigensystem Realization Algorithm for Modal Parameter Identification and Model Reduction," *J. GUIDANCE*, Vol. 8, No. 5, pp. 620-627, 1985.
9. "Integrated Loads and Dynamics Verification Plan", Boeing Report No. D684-10288-01, Rev. B, August 1999.
10. Targoff, W.P., "Orthogonality Check and Correction of Measured Modes," *AIAA Journal*, Vol. 14, No. 2, pp. 164-167, February 1976.
11. Guyan, R.J., "Reduction of Stiffness and Mass Matrices," *AIAA Journal*, Vol. 3, No. 2, pp. 380, 1965.
12. "Flight-4A Post-Flight Analysis: Modal Analysis, Model Validation and Correlation," Boeing MSER Memorandum A92-J332-STN-M-MK-2001-0080, June 2001.
13. "ISS 5A-UF1 Post-Flight Analysis: Modal Analysis, Model Validation and Correlation," Boeing MSER Memorandum J332-2003-0161, June 2002.
14. "ISS 7P – 5S Post-Flight Analysis: Modal Analysis, Model Validation and Correlation," Boeing MSER Memorandum J332-2003-0163, July 2003.
15. "ISS 11A – 18P Post-Flight Analysis: Modal Analysis, Model Validation and Correlation," Boeing MSER Memorandum ISS-HOU-MSER-SIM-050177, October 2005.
16. Wilson, B. "Mission 11A STS-113 Reboost#2 IMU Data Processing Results," Lockheed Martin Memo 3HEC-ES-2LX-039, December 2002.
17. "DAC-8 Structural Loads Report: On-orbit Transient Loads and Loads Spectra," Boeing Report D684-10019-02-01-02, Revision E, March 2000.

18. Wellner, N., "Request Photogrammetry of P4 (2A & 4A) Solar Array Tips during SDTO maneuver on GMT 325," Chit ISS 004361, NASA JSC.
19. Costello, T., "ISS Instrumentation to Validate the Integrated Math Model," SSCN 008631 Revision B, September 2004.
20. Foster, R., "EWIS Design Overview," MSER Presentation, June 2005.
21. McNeill, S.I. "Analysis of INC 14 SAW Photo-G data," Boeing MSER Memo ISS-HOU-MSER-SIM-060212, December 2006.
22. Fitzpatrick, K., Grygier, M., Bartkowicz, T. "ISS Stage 12A Post-Flight Modal Analysis, Model Validation and Correlation," *IMAC-XXVII*, February 2009.
23. "ISS Stage 12A.1 Post-Flight Analysis: Model Analysis, Model Validation and Correlation," Boeing Engineering Information Document EID684-13643, September 2009.