

Development and Testing of a Methane/Oxygen Catalytic Microtube Ignition System for Rocket Propulsion

Matthew C. Deans

NASA Glenn Research Center/Case Western Reserve University, Cleveland, OH, 44135¹

Steven J. Schneider

NASA Glenn Research Center, Cleveland, OH, 44135²

This study sought to develop a catalytic ignition advanced torch system with a unique catalyst microtube design that could serve as a low energy alternative or redundant system for the ignition of methane and oxygen rockets. Development and testing of iterations of hardware was carried out to create a system that could operate at altitude and produce a torch. A unique design was created that initiated ignition via the catalyst and then propagated into external staged ignition. This system was able to meet the goals of operating across a range of atmospheric and altitude conditions with power inputs on the order of 20 to 30 watts with chamber pressures and mass flow rates typical of comparable ignition systems for a 100 lbf engine.

I. Introduction

Future NASA missions will have increasing complexity as we develop new goals and have more challenging undertakings. As the difficulty of these challenges grows, we seek to mitigate risk while developing enabling technologies. With chemical propulsion continuing to be a primary mode of transportation, the safety of these missions will be insured by developing systems that operate on higher performing nontoxic propellants like methane and oxygen. NASA's Propulsion and Cryogenic Advanced Development (PCAD) Project has focused on these concerns and developed systems to overcome these challenges.¹

While methane has beneficial properties, it has a few disadvantages with regards to its ignitability in that it has a longer ignition delay and higher ignition energy requirement as compared to other cryogenic fuels traditionally used in propulsion like hydrogen. While spark systems will continue to be a primary means for ignition, alternative and redundant ignition systems are of interest as they may have different failure modes or draw less power than a spark system and can provide for safety of the missions. One concept that can meet these requirements is a catalytic ignition system.

Catalysts have the natural ability to lower ignition energy requirements. While traditional spark systems may require higher voltage and power demands, the type of catalytic system proposed for the goal of producing an igniter for a 100 lbf thruster requires on the order of 25 watts. A spark ignition system with comparable performance for a similar engine would average 50 to 70 watts of power draw. With power being a conserved element on spacecraft, the catalyst would have a lower load on the system than a spark system would.

Catalytic ignition systems have been developed in the past that utilized packed bed or monolith configurations.² Packed catalyst beds are currently used in space for monopropellants such as hydrazine. These configurations have been shown to have drawbacks as they can degrade over time due to injection issues, non-uniformities in the bed, or other design concerns such as high pressure drops.² These expensive rare metal coated beds have high monetary costs due to the high surface area and pore structure, lack mechanical integrity due to their structure, and have a large mass causing poor thermal response.³ These configurations have multiple potential flow paths making simulation and modeling difficult; the type of single channel developed herein has been modeled before.⁴ Beds may also be restricted by the limiting temperature of the substrate.⁵ Microtubes of a single metal such as platinum would allow for smaller flows, less energy, higher achievable temperatures, and more direct application of heat. These drawn microtubes would allow for single structure construction, more uniform catalyst surface, and controlled

¹ Student Trainee (Engineering), Propulsion and Propellants Branch, 21000 Brookpark Road MS 301-2, Student Member AIAA, matthew.c.deans-1@nasa.gov

² Aerospace Engineer, Multidisciplinary Design, Analysis, and Optimization Branch, 21000 Brookpark Road MS 5-11, Associate Fellow AIAA, steven.j.schneider@nasa.gov

individual flow paths. Though this catalytic system would add additional flow system complexity as compared to a spark system and requires an electrical system, it should still be comparable to the current state of the art with regards to mass and dimensions in that it doesn't require the sizable exciter hardware that spark systems do.

II. Prior Work

Catalytic microtubes have been previously proposed as a concept for a microthruster.⁶⁻⁸ These devices were shown via modeling and experimentation to generate high temperatures as well as reactive products and radicals via their surface and gas phase combustion. It was theorized that these products could be used to create a flame kernel similar to that initially created by a spark plug that could be staged to create a torch igniter. Other catalytic concepts, using different catalytic elements and propellants, have used such staged ignition to achieve a torch and such downstream injection is a technique that has been used to reduce the response time of such ignition systems.^{2,9}

Computational simulations were undertaken to characterize this type of catalyst and propellant combination. This study provided ranges of thermal, fluid, and geometric conditions with thresholds necessary to induce both surface and gas phase combustion within the catalyst to create the initial catalytic elements and delineate what power and flow conditions would be required. A fundamental study to examine the ignition of methane and oxygen via these products was carried out to prove that staged ignition was possible. These trials yielded information about the conditions necessary and provided initial design parameters to manufacture test articles.⁴

III. Experimental Methodology

A. Testing

The goal of this study was to prove that a low power catalytic microtube element could produce a torch similar to a spark igniter. Similar order of magnitude flow rates of propellants had to be ignited to yield a choked torch. Because of the low input energy desired and small geometry of the tubes, the flows that could be lit through a device were two orders of magnitude smaller than the main flows of comparable spark ignition system hardware. These low flows necessitate staging where the catalytic products light another flow. Initial studies led to the development of a unique catalyst design and successive flame augmenters that would be used to light the full main igniter flows; these stages were tested individually and successively at both atmospheric and altitude conditions. The hardware designs were created by Matthew Deans and Dr. Steven J. Schneider; fabrication was by the Fabrication & Instrumentation branch at NASA Glenn. The microtube design discussed is in process for a patent, NASA GRC case LEW-18565-1.

B. Facility

All testing was carried out in the Research Combustion Laboratory (RCL) test cell 21 at NASA Glenn Research Center. The facility is capable of testing at both atmospheric and altitude conditions. The low pressure altitude conditions are controlled by an air driven ejector system with suction capacity of approximately 0.12 lbm/s dry air equivalent (DAE). The ejector reduced the pressure within the test chamber to a steady value of approximately 5 torr (0.1 psia). The valves and data system are controlled via a programmable logic controller and a graphical user interface. Data was acquired at varied rates, typically 10 to 50 Hz. Initial post processing of raw data was conducted on PCs coded in Fortran; additional processing was done by user written code.¹⁰

IV. Experimental Results

Prior to the study reviewed herein, initial trials were conducted with a resistively heated single tube catalyst. Ignition within the catalyst was demonstrated but, due to thermal losses through the electrical contacts, high temperature products at the exit were not achieved. These results led to the development of a unique catalyst microtube configuration that overcomes these thermal losses which serves as the basis for this study.

The next step in the testing process was to test this catalyst and system of staging to examine various conditions and show that a small flamelet generated by a catalyst could be stepped up in flow rate while maintaining stability and ignitability. The desired main igniter flows to be ignited were on the order of 1 to 10 g/s; the microtube catalyst was shown to operate as desired with 0.01 g/s, approximately 1% of the main flow. Stages were designed where this catalyst flow would light a premixed flow also of 1% of the main flow to create a hotter flame. The resulting flame would then be stepped up with a non-premixed stage to about 10% of the main flow. To prove this capability, the three individual components were made so that they could be tested separately with both instrumentation and visual diagnostics. These components were successively stacked and tested and this staged ignition was demonstrated. Positive results allowed for the production of a sealed combined design that could be tested as a replacement to a spark plug.

A. Catalyst Only

Purpose

Before normal operation, the catalytic surface was first activated which normally occurs with the application of high temperatures and the initial onset of combustion. Once activated, the operational envelope was characterized by varying power, oxygen/fuel (O/F) mass based mixture ratio and flow rate.

Design

Results of initial experimental testing leading to this final design showed that the hottest point to vent products naturally occurred in the middle of the catalytic electrical path. Using two catalyst tubes welded together at the tips and electrically attached near the gas inlets would utilize the energy once dissipated in the electrical leads to optimize the outlet temperature of the gasses; this configuration is seen in Fig. 1. This microtube pair would then be used to begin further combustion and increase the total flow rate achievable through the catalytic system component by effectively doubling the channels.

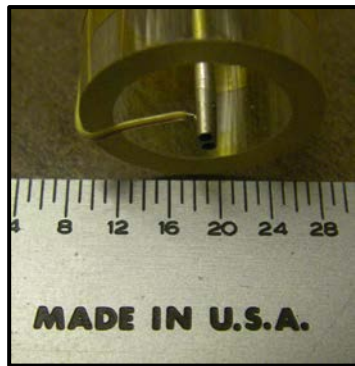

Figure 3. Close-Up View of Wishbone Catalyst Tip. Quartz Shield Tube, Tip Thermocouple, and Scale Detail Shown.

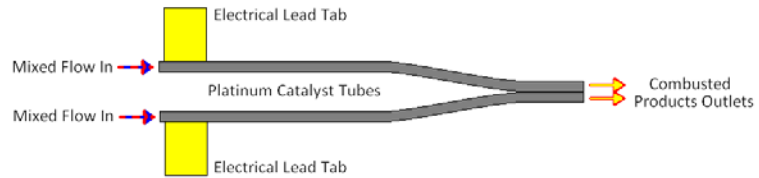

Figure 1. Diagram of 'Wishbone' Style Dual-Microtube Catalyst.

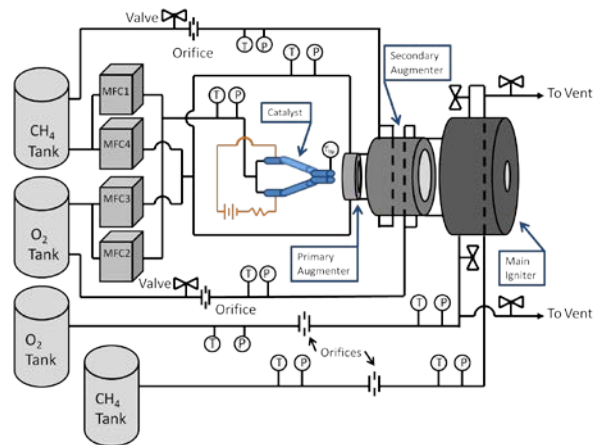

Figure 2. Flow and Power System Diagram.

The microtubes used were 0.8 mm ID platinum tubes. These were 10 cm long, though, with the fittings, electrical attachments, and the weldment, the effective heated length of each of the tubes was approximately 8 cm long. Initial calculations were run to confirm that these lengths could allow for experimental variation of all desired conditions.

To maintain the circuit path and heated sections, the tubes were kept physically separated until the tips where they were welded together. Because it was desired to maintain thermal and electrical isolation of the tubes, they were cantilevered from their bases; the vacuum or ambient gas that would surround the tubes providing insulation. As a visibility and safety measure, the assembly was shrouded with a quartz tube as seen in Fig. 3. This clear tube allows for visibility and maintains electrical and thermal isolation should the catalyst deflect and touch the shield tube.

To maintain the circuit path and heated sections, the tubes were kept physically separated until the tips where they were welded together. Because it was desired to maintain thermal and electrical isolation of the tubes, they were cantilevered from their bases; the vacuum or ambient gas that would surround the tubes providing insulation. As a visibility and safety measure, the assembly was shrouded with a quartz tube as seen in Fig. 3. This clear tube allows for visibility and maintains electrical and thermal isolation should the catalyst deflect and touch the shield tube.

Structurally, the two tubes would support each other and thermal expansion would happen equally to keep the orientation the same. Part of the testing monitored the orientation and deformation of this structure under the various loads that occur during torch ignition. While various structural supports were considered the complexity for this level of study was too great, though this may be of consideration

for further designs. For the first iterations of this test the catalyst was placed in a vertical configuration so that any thermal weakening of the metal would make it extend in the axial direction with gravity, maintaining the tip location relative to the centerline, rather than drooping and misaligning.

The flow system is seen in Fig. 2. Because there were two separate catalytic channels, the flows from the mass flow controllers were mixed and fed into a valve system. Not shown is a 3-way valve that would direct the gases to a bypass while the controllers regulate to the set point. The catalyst tubes were preheated to a desired temperature at which point the valves rotated to flow to the hardware. These flows were split and fed into the two catalyst tubes.

The pressure and temperature were instrumented just prior to the split and flow into the catalysts. The main source of data was a sole thermocouple, a type R wire thermocouple, tacked to the weldment where the tubes join together near the tip. The tip was shown to be near the hottest point of the catalyst and at this location, because of the thin walls of the tubes, the tip temperature of the metal should be approximately equal to the temperature of the flow exiting the catalyst. An open ball thermocouple, type K, was placed approximately 0.5 to 1 cm from the tip of the catalyst in order to read the gas temperature leaving the catalyst. Though it was a small thermocouple there was some drop in temperature from the catalyst to the thermocouple because of the small flows and the distance from the catalyst to the thermocouple.

The electrical leads were located near the flow inlets. Due to the need to have the current flowing along the catalyst, the flow system and potting material that the bases of the tubes were sealed in were made to be nonconductive.

Activation

As this was a newly fabricated catalytic element, the preparation of the surface, known as activation, was required. As manufactured, the surface sites needed for reaction were rendered inactive or would be blocked by contaminants. The flows through the tube need to be initially ignited at a higher temperature than would be needed with fully functioning surface chemistry in order to prepare the surface.

With the instrumentation providing readings for both current through the circuit and the voltage drop across the catalyst, the required power into the catalyst and tip temperature for activation is known. For this activation process, the catalyst was run with total combined propellant flows of 0.0066 g/s resulting in an O/F ratio of 1.0.

Activation was achieved by incrementally increasing the current until the point at which temperatures consistent with gas phase combustion were detected. This activation procedure is seen in Fig. 4 for the 1st Cat. (Catalyst) Activation case. For each point in the process, the current was applied and the temperature was allowed to come up to some steady state, typically within 30 seconds, before the flows were actuated. Higher power would result in a faster rise to steady state, but the typical 15 to 30 second requisite preheat time is much quicker than the preheat times for some alternative catalytic monoliths.

For the cases in which the temperature was not great enough, the flows wouldn't combust and instead convectively cooled the catalyst so that the maximum temperature registered was the maximum preheat temperature. Once the initial activation temperature was reached, with this case resulting in a preheat temperature of around 1250 to 1300 K with a setting of 12.5 amps applied, the gases would combust within the catalyst, resulting in a higher temperature detected.

After the activation point was reached, the current and resulting preheat temperature could be lowered back to near the theoretical required limit for normal operation. Figure 4 shows the full activation cycle for the first catalyst at atmospheric pressure conditions. After the activation point was reached, which can be seen by the sharp rise in temperature after 12 amps was exceeded, trials were carried out with decreasing current increments to determine the

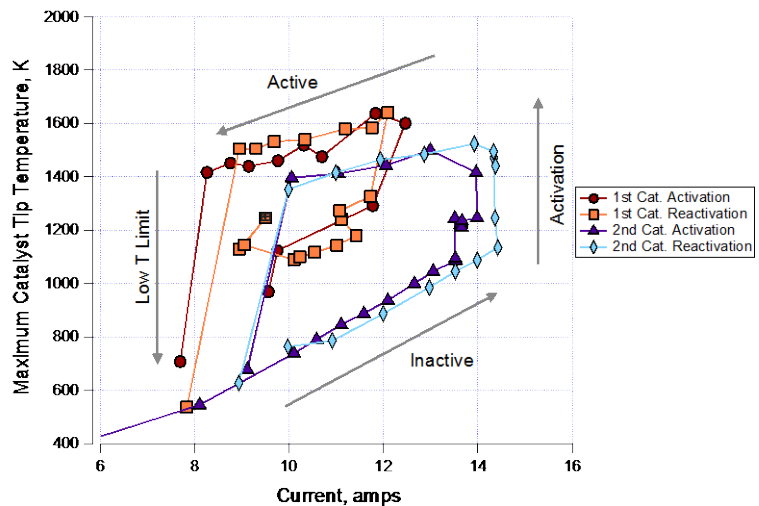

Figure 4. Comparison of Activation and Reactivation Cycles for Both Undated Catalysts.

minimum energy input required. As can be seen by the sharp drop off in temperature below 8 amps, the threshold for operation for this catalyst at these conditions exists at around 8 amps. A power of about 7 watts was required and an initial catalyst temperature greater than 700 K was needed which matches closely to the computationally predicted initial required temperature.

While not a primary focus of this study, the catalyst was deactivated and successfully reactivated. As activation and reactivation have direct parallels, Fig. 4 again shows a similar cycle to the initial activation after the catalytic operation was diminished. With flows of 0.0133 g/s flowing through the element at an O/F ratio of 1.0, higher temperatures were again achieved after raising the catalyst to a similar limit near 12 amps. For both the activation trials and the reactivation trials, the jump from the lower inactive leg to the hotter active leg occurred when the initial catalyst tip temperature read over 1300 K. Likewise, upon lowering the power, the temperature was lowered until it was to the point where combustion would not occur within the tube. For the initial activation, this drop off occurred between 7.75 amps and 8.3 amps; for reactivation this happened between 7.75 amps and 8.9 amps. The reactivation trial series did not have as fine a test point resolution, but the non-ignition limits overlap with each other and with the previously mentioned computational evidence that posed that the catalyst must be over 700 K for operation. While deactivation may be a problem present in catalytic systems, these results show a consistent ability to activate and reactivate under controlled conditions.

The initial catalyst was damaged during the testing and the tip thermocouple was destroyed so an alternate catalyst was built and tested. Figure 4 shows the same activation/reactivation loops presented for the previous catalyst with the addition of the activation and reactivation loops for this second catalyst. Both of the new activation and reactivation loops activate at similar temperatures and currents to each other. In comparison with the original catalyst, however, there are differences. While the activation temperatures are similar, appearing to occur when the catalyst tip thermocouple reads between 1200 and 1300 K, the new hardware does appear to operate at a somewhat lower temperature. Despite this lower temperature, activation did not occur until there was greater amperage applied. The new hardware activated with the current setting being more than 2 amps greater than the old hardware; this translates to approximately 2 to 3 Watts more required power before activation.

Since this second catalyst was manufactured at a later time than the original catalyst, there were some intentional modifications and some potential unintentional changes. A slightly larger gauge thermocouple was used on the new hardware. As a result of this thermocouple, and the manufacturing method used, there was also a much larger weld bead. Also, the new catalyst did not have as much separation between the tubes as they neared the tip. The two tubes were in contact with each other for a greater length. This area was approximately 0.5 cm longer in the new hardware. An analysis of the changes show that these differences could account for losses on the order of 1 Watt each, accounting for the different trends.

Deactivation

Since activation is important for the sake of enabling the catalyst to cause ignition, some knowledge of the deactivation was also accrued both through intentional study and as an additional, sometimes unexpected, result of other testing and operations. In order to deactivate the catalyst, it took extenuating circumstances. During the intentional and typical operation, described within this report, it stayed activated. Likewise, the catalyst would also stay active when sitting idle between trials, occasionally days and weeks at a time. As shown in the previous section, reactivation occurred with the same conditions as activation. This reactivation behavior appeared consistent regardless of the circumstances behind the deactivation event.

The catalyst was originally inactive as manufactured. When the catalyst was returned to the shop for repairs, such as reattaching the thermocouple or reopening the tip, the catalyst was rendered inactive again. After this behavior was noticed, the repair process was examined. Two potential causes of the deactivation were the welding

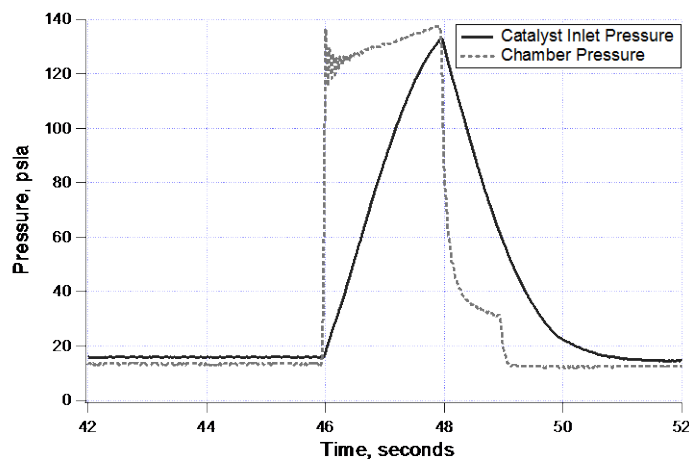

Figure 5. Comparison of Chamber and Catalyst Inlet Pressure Traces Showing Backflow Issue.

processes and the flow/leak check process. The welding of the catalyst joint or the thermocouple would create a hot spot within the catalyst. This high heat could allow for some change in the surface structure or reaction with some constituents of the ambient air that could reduce the surface sites and hinder ignition. During the leak checking process, water flowed through the catalyst and this could have potentially have left impurities on the surface.

One concern was deactivation during operation. The results showed that during normal operation the catalyst did not become deactivated. One potential failure that could occur is in the delivery of oxygen. It was known that extremely fuel-rich methane mixtures could potentially result in coking and the poisoning of the catalyst. While the catalyst was run with a fuel-rich mixture, there had been enough oxygen to sustain this augmented gas phase reaction and maintain the operation. With the depletion of oxygen, coking could potentially occur.

In order to test to see if coking could occur, standard power and flow settings for the methane were chosen. The oxygen flow was ceased as a full methane flow should be the limiting case for this situation. Trials were run with the typical catalyst timing as well as with extended time where methane was flowed through a hot catalyst for 5 minutes. Since this was simulating conditions that could occur if something failed, current was varied up to 13 amps resulting in tip temperatures up to approximately 920 K. After all of these cases, a regular trial was run with both methane and oxygen and the typical flow rates and power settings. In every trial the catalyst relit as desired within the standard variation. The activation process was not needed to restart the catalyst after this poisoning was attempted.

While deactivation did not occur when under proper operation, it did occur during certain trials where there were unintended backflows through the catalyst. During trials with the main igniter flows being ignited, the igniter chamber pressure backed up to over 130 psi. Due to the sudden increase in pressure when the main flows ignite, the mass flow controllers could not keep up with this sudden change in downstream pressure and some backflow through the catalyst and/or stagnating gas within it occurred as the pressure gradient was momentarily flipped as seen in Fig. 5. This reversal was due to the long line length between the controllers and catalyst as a result of the experimental configuration. This issue can be rectified with a design iteration. The oxygen valves in the main igniter and secondary augments both closed prior to the methane valves. These mixtures start fuel-rich and slew richer by denying them oxygen as opposed to having a mixture ratio excursion that could result in high temperatures damaging the catalyst. This resulted in backflows of hot products and nearly pure methane through the catalyst. With a stagnating hot slug of methane gas on a catalytic surface, coking can occur, contaminating the surface.

The attempts at intentionally causing deactivation only brought the temperature up to 920 K; this temperature was below the point at which coking can occur with methane, 950 K.¹¹ These backflows occurred at the point where all flows had already ignited so the catalyst temperatures were in excess of 1400 K. The combined effects of the high temperatures, the back flow, and the high pressure resulted in the spoilage of the catalyst. Spoiling was known to occur as immediately after the completion of that firing, the catalyst ceased to function until the proper reactivation cycle was carried out.

Catalyst at Atmospheric Pressure

A similar structured catalytic element had been studied in a previous phase of this study. An O/F of 1.0 had been previously examined and exhibited the requisite performance. To expand the operational envelope studied, an O/F ratio of 1.66 was selected for study and run across the possible range of mass flow controllers. Inconsistency in the power source caused some small fluctuation of the power, but the average current delivered was approximately 8.91 amps with a fluctuation of up to 0.15 amps. This setting was chosen since it should have resulted in a catalyst preheat temperature just above the minimum required temperature to guarantee catalytic ignition. Figure 6 shows the resulting maximum tip temperatures across this range.

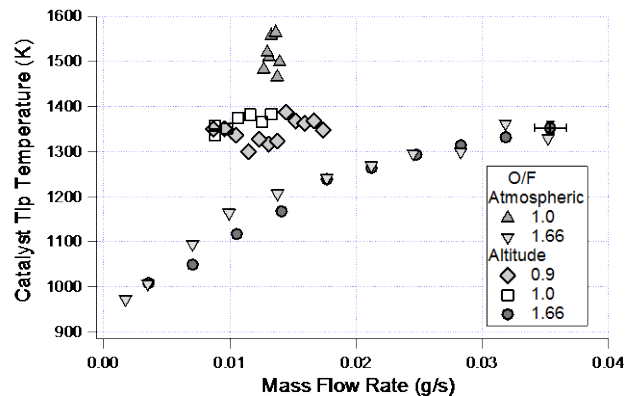

Figure 6. Resulting Tip Temperatures of Catalyst with Mixture Ratio and Flow Rate Variation. *The preheat temperature of atmospheric O/F = 1 trials was approximately 1060 K, O/F = 1.66 was approximately 840 K so the increase from preheat to peak are approximately equal. The preheat temperature of the altitude trials was approximately 860 K.*

While the mass flow rate can affect the temperature reached due to the required amount of residence length and the changing of thermal losses, a given O/F ratio should reach approximately the same peak temperature regardless of mass flow rate. While that is the case, the temperature plotted is the maximum tip temperature and the peak may not necessarily be located at the tip. For the trials with an O/F of 1.66, the reaction zone occurred rapidly near the inlet to the tubes. At this location there was a great deal of heat soak into the inlet fittings and time for convection to occur, cooling the gases and platinum before reaching the tip. A higher mass flow rate shortens the residence time and pushes the primary gas phase flame kernel towards the end of the tube. As shown, a peak tip temperature of near 1400 K was reached. While the single thermocouple at the tip makes it difficult to demonstrate the entrance heat losses, more detail will be shown in the altitude trials where the visual images recorded make a distinct difference.

Though not diagnosable in the current experimental setup, pushing the reaction zone towards the tip of the catalyst should result in an increased concentration of beneficial radicals vented since they will not have as much time to recombine or react to ignition hindering products or products with a diminished positive effect. While hot high mass flow rates may be beneficial in delivering a larger quantity of hot products, a high flow rate may also result in too great of a strain rate hindering further staged ignition.

Though a lower mixture ratio may cause a gas phase flame kernel to be a lower temperature, the primary concerns are more about thermal delivery than potential maximums. Likewise, reducing the power input will elongate the required catalytic length before the reaction peak occurs though increasing it may increase the overall thermal energy of the system. While this study did not have the ability to experimentally vary all of these conditions individually through a wide range, previous works have done this to varying degrees experimentally and computationally.⁴

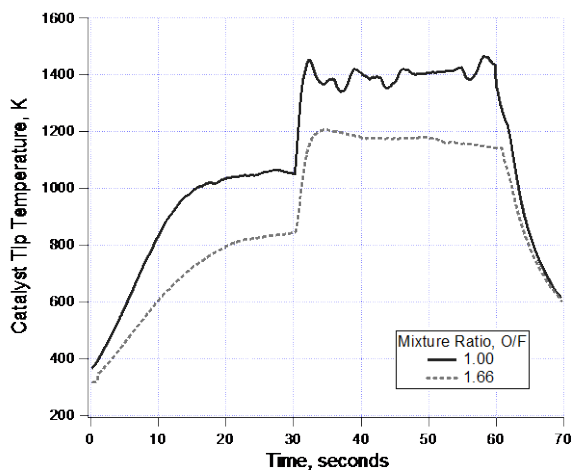

Figure 7. Temperature Trace of Catalyst Tip at Atmospheric for Two Different Mixture Ratios with Constant Mass Flow Rate of 0.0138 g/s.

The O/F = 1.0 flows shown in Fig. 6 demonstrate how a variation of parameters could approach the desired temperatures. These tests had a lower mixture ratio, a higher power setting at an average of 10.9 amps, and were run at a lower flow range. With this variation the temperature can be raised significantly, in this case to an average over 1500 K. This results in a case hotter at the tip than the higher O/F ratio yet still within the physical limitations of the catalyst. With the mixture ratio of 1.0 and this current setting, the preheat temperature was approximately 1060 K. With the lower current setting tested for the mixture ratio of 1.66 trials, the preheat temperature was around 840 K, just over the ignition onset point as seen in Fig. 7. Taking into account this initial temperature difference, the temperature increase after ignition is similar. While there was some gas phase reactions present within the catalytic channel that would indicate the higher mixture ratio should produce a hotter flame, the combined surface chemistry and thermal behavior of the system appear to have nullified the greater heat release. While the electrical power may have

been providing a great deal of the temperature increase, the combustion processes induced were still highly exothermic and provide for the vitiation that has been shown to enhance ignition.

Some of the peak temperature variation seen from point to point is not only a product of the flow variations but of the undesired power variations. Also, the length and order of the trials could have resulted in some heat soak into the upstream system which may have preheated the incoming gases. These small variations aside, a range of temperatures was reached that should cause further staged ignition. Though prior computational simulations did not match this configuration specifically, these results do corroborate with the expected values of temperatures approaching 1600 K. The variation of the flow, mixture, and power demonstrate the flexibility of the system in which a variety of factors can be modified in the pursuit of ignitability, system safety, and energy efficiency.

Catalyst at Altitude

Again, a similar set of trials were run at altitude conditions with ambient pressures for each case averaging under 0.09 psi (~5 torr). Fig. 6 shows the results of 3 mixture ratios tested across a range of flow rates and their maximum temperatures reached. Again, the power system was set to a constant but some variation occurred; the cases were run with an average of 7.9 amps for the O/F = 0.9, 8.1 amps for O/F = 1.0, and 8.3 amps for O/F = 1.66. In a vacuum the convective cooling should be largely reduced and these lower values were desired for the sake of catalytic preservation.

Gas phase combustion is typically hindered by low pressures and the residence time of the combusting gases should be reduced with a lower back pressure. The lower residence time may have assisted in pushing the hottest reaction zone and flame kernel towards the tip. The gas phase combustion continued to be supported by the surface chemistry. Within the confines of the catalyst, the pressure can stay somewhat elevated as the flows choke causing the low pressure effect to be somewhat mitigated. As seen in Fig. 8, though the ambient pressure was approximately 0.1 psia, the inlet pressure was approximately 5 psi as the combusting flow choked. Modeling confirms for these conditions that there was approximately a 0.5 psi drop down the length of the tube, maintaining a pressure above ambient. Since choked flow will occur with approximately two times the downstream pressure without exothermic combustion that the non-combusting flow will also choke. These trends track closely with each other until approximately 3 psi. While ignition would occur in a lower pressure regime, the initial reactions within the catalyst will be occurring above the ambient vacuum pressure. The long time to pressurize the catalyst when combusting is

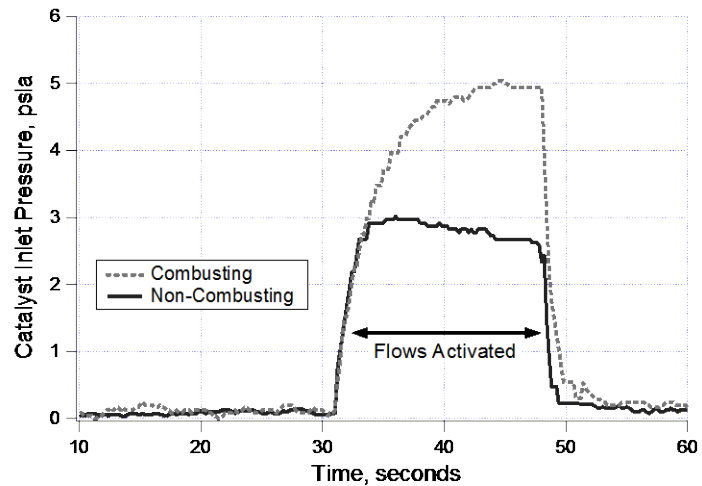

Figure 8. Pressure Traces of Catalyst Inlet Pressure at Altitude Conditions for Non- and Combusting Trials.

again the result of the long feed line between the controller and catalyst and can be significantly reduced.

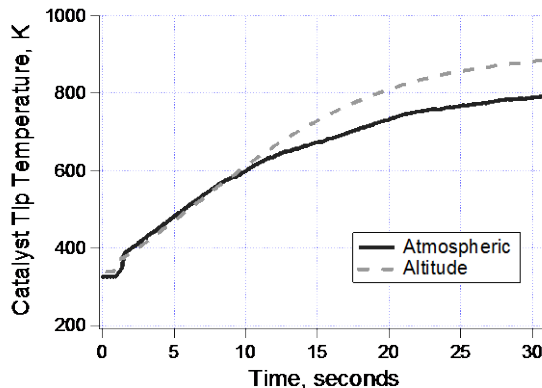

Figure 9. Comparison of Preheat Temperature Traces of Catalyst for Atmospheric and Altitude Trials with 7.85 amps.

differences in power input and taking into account the differing preheat temperatures these trends are comparable to each other.

A lower pressure within the tube would hinder the combustion processes. The lower pressure, and therefore density, at the same mass flow rate would result in a higher velocity and a resulting shorter residence time for the altitude condition. These low pressure factors taken into account would result in less heat release. Those negatives

were countered by the positive attribute of having less convective heat loss resulting in the near identical temperature rise for both conditions.

Figure 10 gives an example of altitude trials. The 30 second preheat was carried out with initial temperatures above the approximate 700 K catalyst ignition threshold. Upon flow activation, the temperature rises significantly. Within approximately 5 seconds of the flow activation, the O/F = 1.0 case catalyst tip temperature reaches 90% of the peak value. This percent corresponds to a temperature of over 1200 K and above the theorized required ignition temperature. At 9.8 seconds after the flow activation, the catalyst tip reaches 99% of the peak value at 1347 K. Though this is a much longer time scale than the millisecond time scales of spark systems, this is much quicker than the minute length time scales of other monolith catalysts.

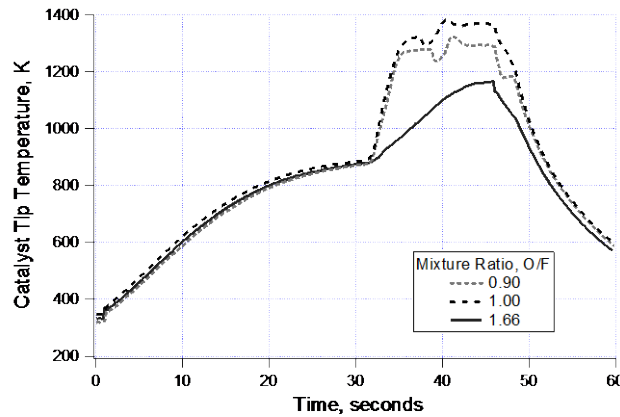

Figure 10. Comparison of Catalyst Tip Temperature Traces at Altitude with Corresponding Visuals.

Figure 10 shows the different tip temperature traces for various mixtures under other constant conditions. The O/F = 1.0 and 0.9 results appear very similar; though the higher mixture ratio is slightly hotter through the range, the variation of both traces overlaps significantly. The trend is cooler in this altitude trial than they were at atmospheric but this is due to a lower current setting with an average of 2.8 amps less than the atmospheric trials. These temperatures were still within the theorized ignitability zone and could potentially be increased with either power variation or tube optimization. The higher mixture ratio of 1.66 trended lower. As seen in Fig. 10 and accompanying video stills, the tip temperature read much cooler and was slower to heat. The pictures illustrate this as the lower mixture ratios have the hot glowing reaction zone at the catalyst tip, whereas the higher mixture ratio has the bright reaction zones located near to where the inlet of the tubes are. Because of the location, there was a lot more local mass for the heat generated to soak back into, lowering the temperatures at the exit. This heat loss behavior is confirmed with the aforementioned trends as higher flow rates will counter this reaction time with the shorter residence time pushing the flame more towards the exit. Again, this could potentially have a higher exit temperature as the higher and more stoichiometric mixture ratios should burn hotter but it would require greater flow rates beyond that of the capabilities of our current system.

With these results, the catalyst is proven to function at altitude and generate high temperatures in the zone required for further ignition. While future stages rely on gas phase combustion solely and may then be hindered by the low pressure, this first element functions as desired under these adverse conditions.

B: Catalyst and Augmenting Stages

Purpose

This series of tests demonstrated staged ignition and study the operation of the system under low pressure altitude conditions.

Design

In order to create a flame kernel from the

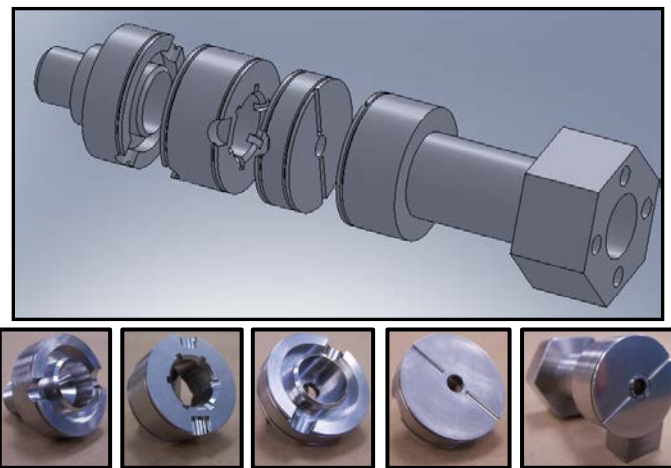

Figure 11. Exploded View of Catalyst Housing to Secondary Augmenter Integrated Spark Plug Replacement Device.

catalyst microtubes that could ignite the main igniter propellant flows, a system of staging was developed that, by successive ignitions of multiple stages, would create a higher temperature flame with an increased burning mass flow. This staging was done to prevent quenching by the larger main igniter propellant flows and ensure reliable and repeatable ignition. This system was also developed with geometry similar to spark plugs so it could directly replace a spark plug in an ignition system. The various components that comprise this system of staging are seen in Fig. 11 without the catalytic element.

The first stage after the catalyst, the primary augments, injects a fuel-lean premixed flow of propellants of the same order of magnitude as the catalyst mass flows in the radial direction towards the exhaust of the catalyst near its tip. The propellants were regulated via mass flow controllers. These flows were then mixed, flow through a three-way valve, and flow into the device via two separate tubes as diagrammed in Fig. 2. The lines prior to the augments were instrumented for pressure and temperature.

The augments itself consists of two tubes feeding the same gas into an internal circular manifold which distributes the gas around to 6 injection ports. These ports have exit areas of 0.5 mm by 0.5mm and all vent perpendicular to the flow out of the catalyst. The ports were dimensioned in order to deliver the mixture at a velocity greater than the fastest flame speed of a methane/oxygen mixture that could be possible under these conditions. Likewise, the port sizes were on a scale that should serve as a flame arrestor. These conditions will not only prevent dangerous flashback of the premixed gases but deliver a steady and stable supply of propellant to the flame zone. The exit port faces were 2.57 mm from the centerline of the catalyst flow.

In order to provide a stable flame to light full propellant another intermediate flow, the secondary augments, was added. While the catalyst and primary augments showed a stable and hot flame kernel, their flows were on the order of 1% of the main flows to be used and these large propellant flows could potentially quench such a small flame. Having an intermediate flow of 10% of the main flow would help to ensure reliable ignition.

For safety purposes the flows would remain separate and mix within the combustor. As seen in Fig. 2, the gaseous propellants were fed by tanks with regulated upstream pressure. To control the mass flow rates, and thereby the mixture ratio, orifices were used to create a choked flow condition so any fluctuation downstream would not affect the delivered mass flow rate. Pressure and temperature readings were taken prior to the orifice and at the entrance of the stage for both propellant flows. Each propellant has a dedicated valve that can be triggered to vary the timing of the stages.

The augments consists of a cylindrical chamber with an internal diameter of 15 mm that was 3 cm long. The methane and oxygen were brought into the device via two pipes to an internal manifold which distributes the flows to 6 evenly spaced channels. Due to the fuel-lean primary augments, the methane was fed to the ports closer to the catalyst. The propellant outlet port channels were separated by 11.5 mm and were centered within the device. These channels all point in the radial direction towards the centerline, but were angled 45 degrees towards the middle of the device so that the flows of methane and oxygen impinge at the centerline and midpoint. An internal view of this assembly is seen in Fig. 12.

The ports were sized so proper impingement and mixing occurred using nondimensional ratios for mass flow rates, exit area, and momentum.¹² While ideally all ratios should equal 1, because of the required mixture ratio for temperature control, the ratio of mass flow rates, or O/F mixture ratio, will have some variation above 1 but still within an order of magnitude. The exit areas were designed to be equal for this device. The momentum ratio was initially designed to be near 1 for the range of the conditions expected. The resulting cross sectional exit area of each of these ports was approximately 2 mm by 1.7 mm.

Because of the compact nature of the device, with geometry similar to a spark plug, and the flow system complexity required, there were no thermocouple or pressure taps into the body of this assembly. In order to connect the assembly to the main igniter, a threaded connection was used similar to that of a spark plug. Because this

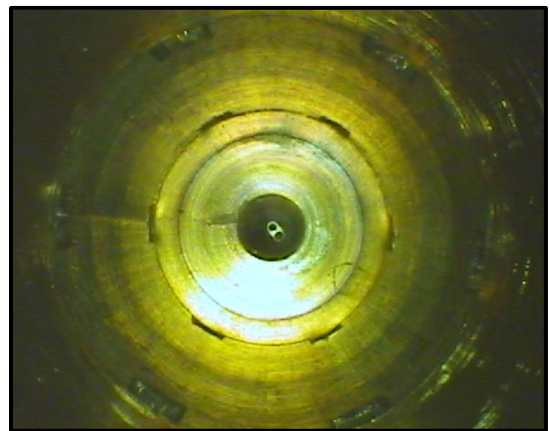

Figure 12. Interior Borescope Picture of Assembly. Radial Secondary Augments Ports in Concentric Circles, Primary Augments is Central Flat Face, Dual Tube Catalyst is Centered.

connection requires a smaller passage than the internal diameter of the combustion chamber of the secondary augments, a 45 degree converging nozzle was used to funnel the flow to a 4.445 mm diameter cylindrical passage through this connection. This exit passage was not sized to choke the flow and back up pressure because the feed systems for the individual components were already designed to choke. It was sized to allow for instrumentation to be inserted (a borescope or thermocouple).

The stages were welded together; with the exception of catalyst assembly. It was desired to have the catalyst be sealed yet readily removable for inspection or replacement.

Primary at Altitude

In attempting to ignite the primary augments premixed flows with the vented products of the catalytic igniter, this series was the first proof of concept that, even under low-pressure combustion-hindering conditions, such a concept is possible. For this series of trials, the catalyst was set in its previously established operation mode with flows of 0.0066 g/s for both propellants and an overall O/F mixture ratio of 1. The pressure in the chamber was reduced to approximately 4.5 torr (0.087 psia).

Prior testing with the catalyst and primary augments at atmospheric conditions in this configuration demonstrated that ignition was feasible with mass flow rates from 0.005 g/s to 0.05 g/s with mixture ratios ranging from approximately 2.5 to 22.5. While the fuel-rich mixture ratio tested at 2.5 was able to demonstrate ignition, achieved temperatures were lower than desired due to the fuel-rich catalyst igniting the fuel-rich augments. The large amount of variation occurred in the fuel-lean range with mixture ratios of 5 to 22.5 where the catalyst tip temperatures ranged from 1550 K to 1750 K. These are not fixed limits of ignitability but flow system limits.

Due to the time constraints of testing at altitude, few cases with just the catalyst and primary augments were carried out. Proof of operation was successfully established and stable flames were generated. Figure 13 shows the range tested, with flows on the same order of magnitude as the catalyst and mixture ratios varying in the fuel-lean range from 20 to over 35.

Trials were repeated at a mixture ratio of 25 with a non-light event recorded below 10 amps, though with higher mixture ratios a similar test to find the threshold of the amperage showed that 8.34 amps was able to still cause ignition. Likewise, in a later trial with the secondary augments, a mixture ratio of 20 in the primary was able to be lit by a catalyst functioning at 8 amps. With the known inconsistencies, a definitive threshold of required power is hard to state, though trends can be established though higher amperage can yield more reliable ignition.

Figure 14 shows the temperature trends for the tip thermocouple of two of these trials, one that resulted in the staged ignition of the primary augments (upper) and one that did not ignite. For the former, the behavior appears as before with an immediate rise in temperature with the activation of the flows. Again, the power was shut off before the flows through the catalyst and primary augments were ceased. The same type of behavior, as previously seen, exists with a drop to a lower steady state temperature as the flame was self-sustaining. This self-sustaining behavior may provide for a no-power pilot light mode where power or flow could be added to cause ignition on demand.

For the non-igniting trial, upon flow activation the temperature showed a fluctuation but not a significant rise. Should the catalyst not have reacted, the flowing gas would have cooled the tip thermocouple as previously seen, but

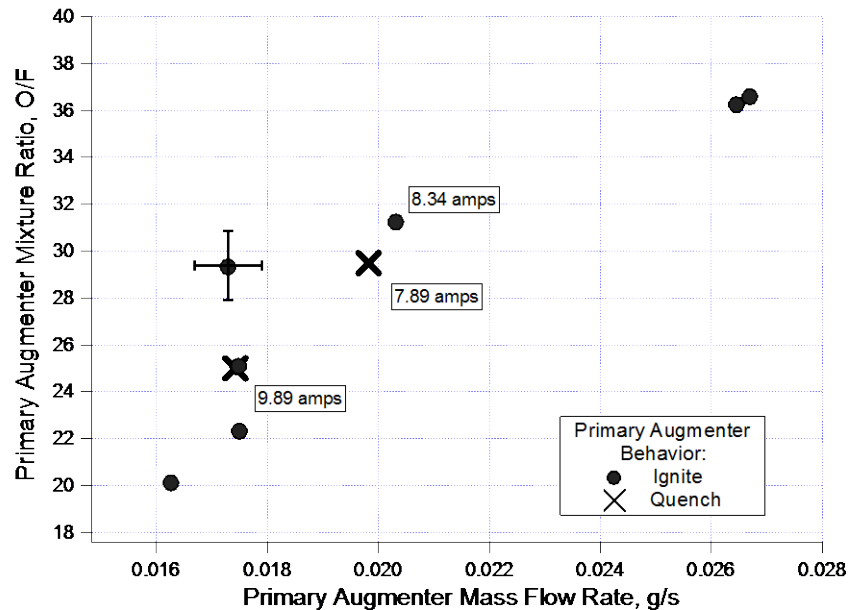

Figure 13. Test Matrix of Integrated Primary Augments at Altitude.

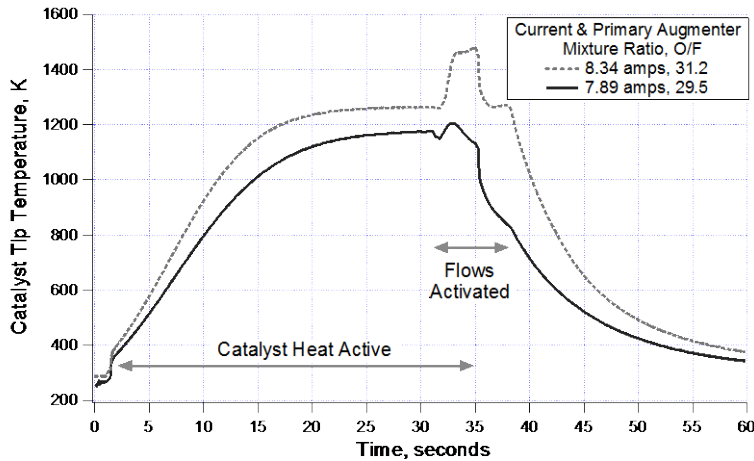

Figure 14. Temperature Trace of Igniting and Quenching Primary Augmenter at Altitude Trials.

failure of instrumentation in some cases, temperature trends with respect to mass flow rate and mixture ratio can't be reliably established. Upon ignition, the tip thermocouple registered increases between 200 and 350 K consistently. The data gained serves to prove the concept that staged ignition under low pressure conditions was possible and provide an initial starting point for testing further staged ignition.

Secondary at Altitude

Initial experimentation at atmospheric conditions with the catalyst and primary augmenter igniting the secondary augmenter demonstrated ignition was feasible in the current configuration. The mass flow rate was increased an order of magnitude as compared to the previous flows with a range extending from 0.15 g/s to 0.45 g/s. The mixture ratio was varied from approximately 1.0 to 2.0 with ignition throughout the regime. These bounds were due to flow system limitations and not physical limitations of ignition.

Igniting the secondary augmenter presented the dual ignition hindering challenges of having both a fuel-rich mixture and igniting it under low pressure. The timing of the stages is shown in Fig. 15. While rapid response was an eventual goal, for this proof of concept it was desired to have definitive zones for each stage so that the behavior could be observed. The first zone consisted of no flows with just power applied to the catalyst. As will be discussed, the tip thermocouple had become unreliable so the trace of the voltage drop across the catalyst is shown. As resistance changes with temperature and the current applied was held to a statistically constant value, the voltage trace shows parallel behavior to the thermocouple. This zone was given a 30 second time span to allow for heating to a steady state value. Though a greater current and higher power could have been initially applied to reach the requisite temperature within a shorter time period, this trial was kept to a lower power for the sake of examining some of these minimum power requirements and as an extra measure of safety to make sure the catalyst did not overheat. This signal reached 90% of its set point within less than half of the time period, approximately 13 seconds, and 99% of the final preheat value within approximately 22 seconds. These results match with previously observed behavior. As seen in the images, taken via a camera focused on a mirror viewing down the throat, the catalyst could be seen to glow lightly even prior to flow activation.

At 31 seconds, the three way valves leading to both the catalyst and primary augmenter were actuated. The primary augmenter flow rate of methane was so low that fluctuations caused some variation in mixture ratio though it stayed in the desired fuel-lean range. The catalyst ignited its internal stream which then ignited the primary augmenter stream causing a rise in voltage as the temperature increased. The visual appearance was that of a bright flame kernel. 10 seconds were given to confirm operation and the flame remained stable the entire duration.

At 41 seconds the secondary augmenter flows were simultaneously activated. Within 0.25 seconds the mixture ratio was delivered at the desired composition. As seen in the corresponding screen capture, the secondary ignited and produced a more radiant flame. Due to the configuration of the flow system, the catalyst and primary augmenter flows varied as the secondary flows were activated. With the back pressures modified, the mass flow controllers took some small time to recover. These restored to their desired operational settings within approximately 0.25 to 0.75 seconds and did not appear to affect ignition or the flame staging.

in this case the temperature did not rise or fall significantly. The catalyst had a reaction and internal flame but the non-burning primary augmenter gas injected at the tip convectively cooled this area without igniting. The catalyst was known to have ignited the internal flow since the tip thermocouple temperature drops to a lower steady temperature just over 800 K after the power was shut off. Without an internal flame, it would have dropped down to a lower temperature as can be seen by the temperatures achieved in Fig. 14 from 35 to 38 seconds.

Due to the variation in current, the limited flow regime, and the

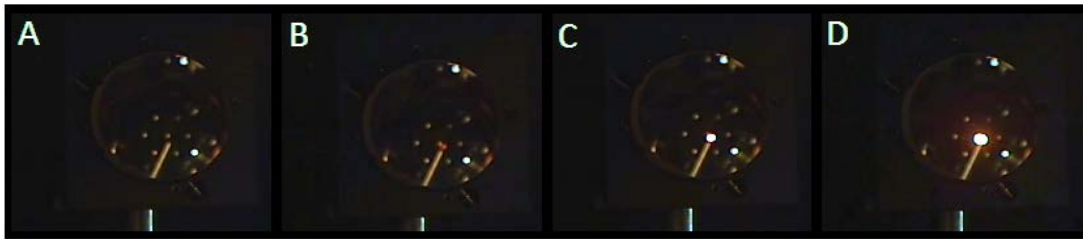
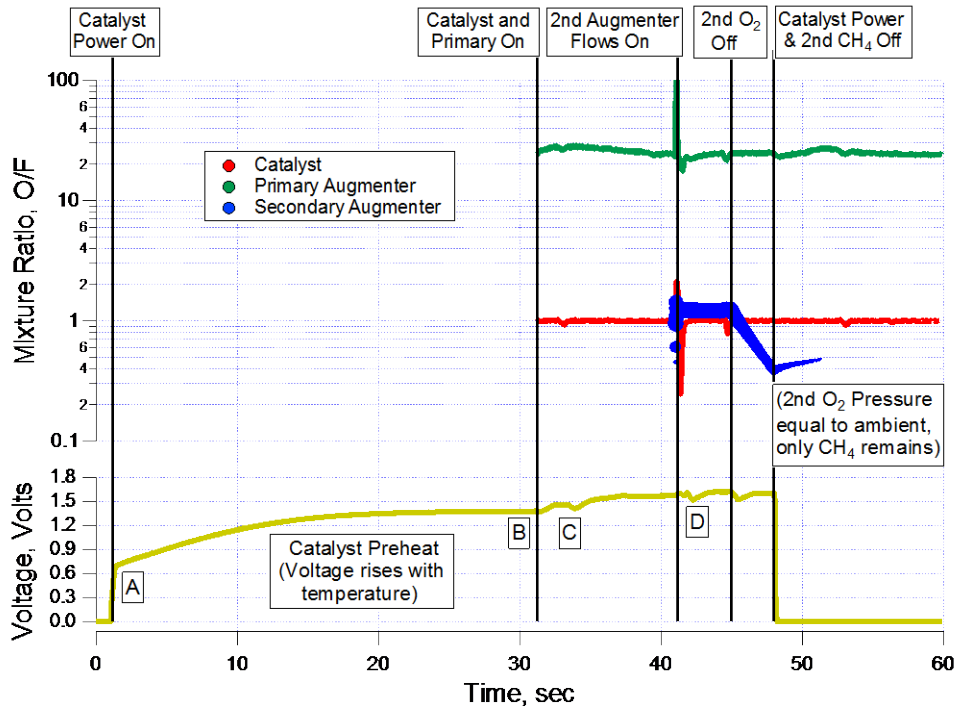

Figure 15. Timing Trace of Catalyst, Primary, and Secondary Augmenter Mixture Ratios and Voltage with Associated Visual.

At 45 seconds the valve to the oxygen line of the secondary augmenter was closed. Due to the line capacity between the valve and the control orifice, the flow slowly dropped off; this decline, as designed, lowered the mixture ratio to a cooler flame and approached the quenching condition. At 49 seconds the methane valve was closed as well. As the methane was designed for a larger flow rate it depleted faster than the oxygen so there was a short rise in mixture ratio, though it stayed fuel-rich. The flow rates continued to fall off until both flows were exhausted.

These trials presented a number of technical challenges that make full diagnosis and evaluation difficult. Foremost is that the only instrumentation present within the assembly was the catalyst tip thermocouple; the various manipulations that had occurred before had rendered it occasionally faulty. Catalytic deactivation and misalignment caused some non-optimal cases where the catalyst was functioning, but the flame with the primary augmenter was not as hot or stable as desired. Due to pressure oscillations in the lines caused by line capacity and pressure regulator issues, the flow system experienced some fluctuation in flow rates. The limited amount of time at vacuum meant that not all trials where variation occurred could be carried out again.

The last major challenge involved the observation of the flame. The throat after the secondary augments was not made small enough to drive the exit flow to a sonic velocity and produce a choked flame. It was designed as a long thin passageway to fit within the thread structure of a spark plug. This steel passageway and the metal structure it was attached to were acting as a large heat sink, draining heat from the flame as it passed through to the low pressure ambient chamber. Because of these factors, no visible flame was produced from the exit. After this fact was observed, a camera was moved to view down into the assembly.

Figure 16 shows the full range of trials that were tested with the secondary augments at altitude condition. Variation

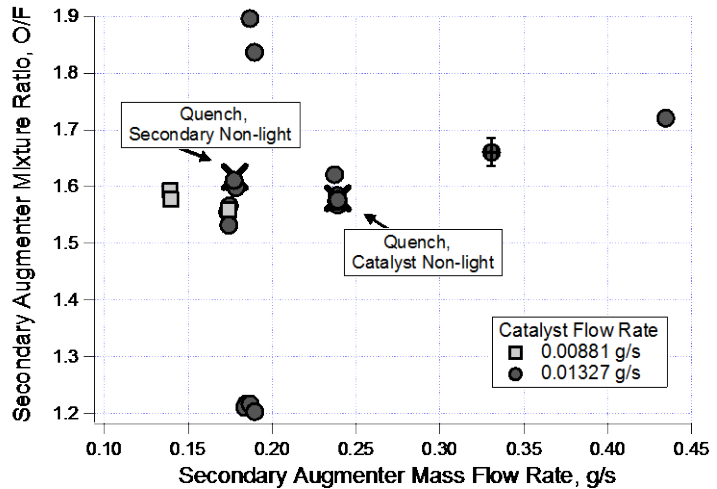

Figure 16. Test Matrix for Secondary Augments at Altitude Conditions.

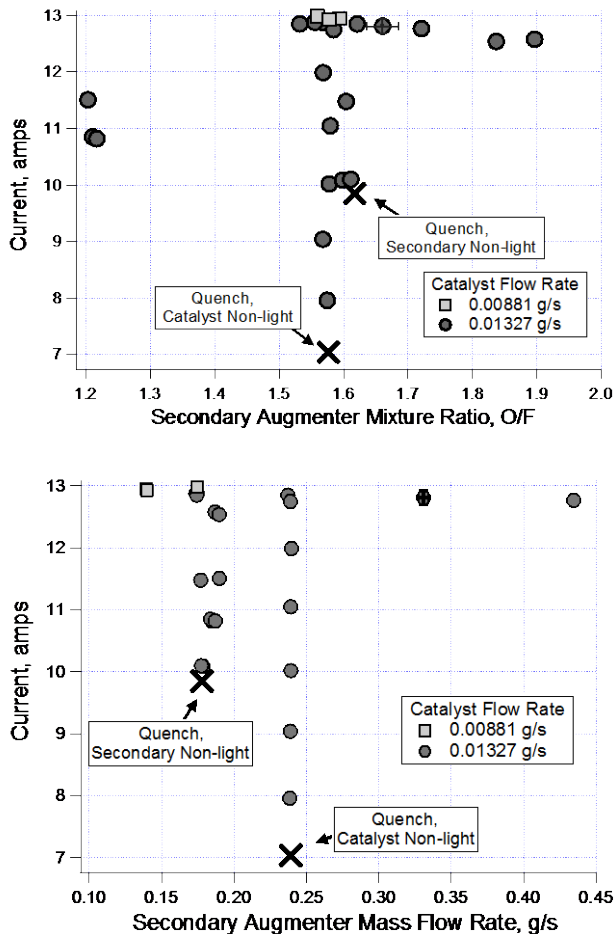

Figure 17. Test Matrix of Current Versus 1) Mixture Ratio and 2) Mass Flow Rate for Secondary Augments at Altitude Conditions.

was carried out with respect to both mixture ratio and total mass flow rate. The ignitable limitations of flow rate and mixture ratio were not observed within the capabilities of the system. This lack of failures attests to the functionality of the staged catalytic system.

The behavior behind the few non-ignition cases corresponds to the power applied to the catalyst. Figure 17 gives some indication of this and shows the dependency on current. The quenching condition for the lowest current point corresponds to the limits previously seen during the activation trials where this low current does not result in initial catalyst bed being hot enough to ignite.

The behavior for the only other case where the secondary augments did not light showed a different trend. The catalyst lit as expected yet the staging through the secondary augments did not occur as desired. It may be that with this lower power, the resulting product temperatures were nearing the threshold of ignitability. The transients, as seen in Fig. 15, could have caused conditions that prevented ignition. Repeat trials at this condition were unable to be carried out but a similar descending current trend at a slightly larger mass flow rate showed ignitions at current levels lower than this quench case. Should these non-ignitions be an indication of a threshold zone, it would be suggested that operation take place at current levels over 10.5 amps because repeated ignitions were obtained in that regime without failure.

Though staging was successfully demonstrated and some cases did exhibit higher temperatures at the outlet of the secondary augments, none of the

cases yielded exit temperatures approaching flame temperature. Though these thermocouples were some distance removed from the flame, a greater rise was desired. The hot gasses expanding into the larger low pressure cavity of the main igniter combined with the heat losses to the steel body of the system caused these low readings.

While the low exit temperatures do not invalidate the operation without a design modification, it does change the concept on how this may cause ignition in the main stage. Since the flow does not become choked through the passageway and the walls of the passage act as a large heat sink, the first three stages will not introduce a flame kernel into the main igniter chamber. Rather, ignition will rely on mixing of the main propellants with and ignition by a previously established flame at some location within the assembly of the first three stages.

C: Ignition of Main Igniter Flows

Purpose

In order to demonstrate the creation of a choked torch, gaseous propellants under atmospheric conditions were tested. Testing with gasses as the igniter body flows allow for study and analysis of the effect of flow rate and mixture ratio variation as well as more insight into the effect on the catalytic element under repeated firings at various conditions.

Design

This hardware iteration did not see any modifications to the catalyst and the pretested components but had the addition of the main igniter body and its feed systems. The main igniter body was a simplified design representative of traditional spark system but designed with some criteria in mind for this testing as seen in Fig. 18.

The body included a threaded and sealed connection like that of a spark plug port and could use either a spark plug or the catalytic assembly. The outlet of the staged system exhausted into a cylindrical main igniter chamber with an inner diameter of 0.75 in and length of 1.245 in. The chamber was vented through a converging 45 degree nozzle to an exit diameter of 0.14 inches. The nozzle was sealed with a copper O-ring. The exit area of the nozzle was sized according to an ideal characteristic velocity, C^* , calculation based on the desired operating chamber pressure and mass flow rates known for the previous stages and designed for the main chamber. C^* values were calculated in CEA based on the designed mixture ratios for operation and then equated and the throat was sized for the desired mixture and flow rate.

The methane and oxygen injection ports were sized so as to create a proper impingement and mixing of the propellants as detailed before. A third port was added to the chamber so that a thermocouple and pressure transducer could read the internal conditions. The flows were regulated via choked flow orifices as shown in Fig. 2. A series of orifice sizes were tested to continually increase the mass flow rate to study and determine the limits of ignitability. The fully assembled hardware is shown in Fig. 19.

Testing

The flow system was originally sized for flows of approximately 1.0 g/s; this lower flow rate would result in less potential convective losses to the catalyst and create mixing conditions where the heat and products of the flame generated by the previous stages would ignite the main flows. From this initial testing point, larger orifices were exchanged to increase the mass flow rate.

The other components in the stage were set at their functional points. The catalyst operated at an average mass flow rate of 0.013 g/s at a mixture ratio of 1. The primary augmentor operated at a flow rate of 0.024 g/s and, initially, a mixture ratio between 30 and 35; some variation occurred because of the low methane flow rate. After some repairs, more trials were run with a mixture ratio of 20, though this was still in the heavily fuel-lean range and resulted in no apparent change of function. The secondary augmentor was set to 0.185 g/s. The mixture ratio ranged from approximately a mass based O/F of 1.42 to 1.57, but on average was set at 1.5. The amperage to power the



Figure 18. Image of Main Igniter Body with Nozzle Removed.

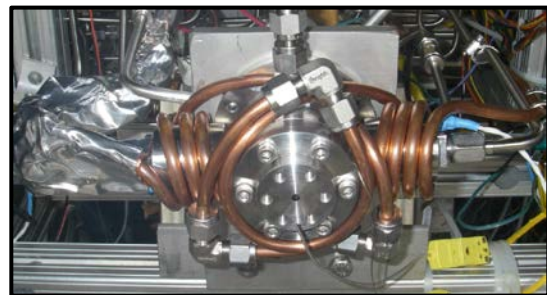

Figure 19. Front View Image of Fully Assembled Ignition System.

catalyst was set between 11.5 and 14 amps, averaging around 12.75 amps. The resulting power averaged around 19.5 watts with maximums near 30 W.

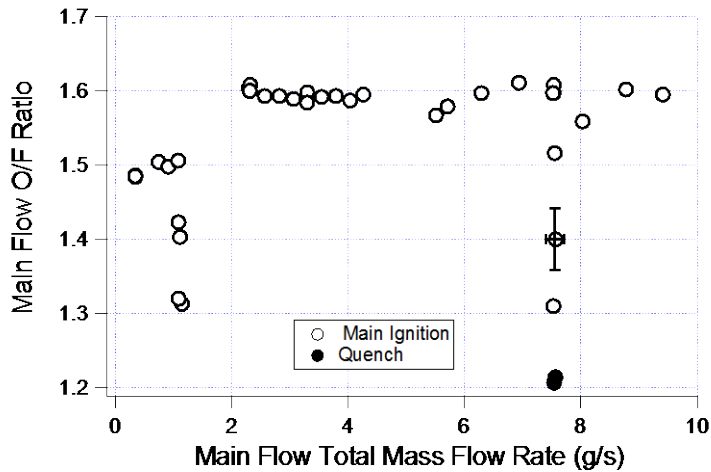

Figure 21. Main Igniter Test Matrix of Mixture Ratio and Mass Flow Rate with Gaseous Propellants.

sets were utilized, but at this mixture ratio and with the flow regime that was available, it was not possible to quench the torch. The main flows ignited every time.

The mass flow rate was then set to a value near the design point of approximately 7.5 g/s, and the mixture ratio was varied with a constant mass flow rate. The mixture ratio was lowered from its initial set point down to a value below 1.3 where it ceased being able to ignite with repeated trials establishing a threshold limit.

Below 2 g/s the chamber pressure wasn't high enough to properly choke through the nozzle. Initially, above 4.5 g/s a leak initially developed so the pressures achieved for some trials in this range were not under design conditions, but they all did produce a choked torch flame. After repairs had been conducted, there were a few additional test points gained with chamber pressures over 130 psia in the designed range.

The ignition capability and production of a torch was the primary focus of this study so the pressures achieved after ignition are not a primary concern so long as they were high enough to produce a choked torch. It should be noted that for the cases where a leak developed the loss was minor and the nozzle stayed choked with respect to the atmospheric pressure air that the igniter was being vented into.

For the mixture ratio achieved by accounting for all flows, these values were about 92.6% of the ideal C^* with a maximum of 95.5% and minimum of 90.5%. These are within range of what was expected with the known losses and multistage combustion. These values used the overall mixture ratio present within the igniter and not just the main flows. When considering the mixture ratio of only the main flows, these do not change significantly from the trend and error seen with an average C^* efficiency of 93.4%. Since the igniter functions on a staged design it will, by design, not be perfectly mixed and some loss in C^* efficiency was expected.

Ignition was repeatedly achieved, producing a torch flame similar to that of standard spark ignition systems as seen in Fig. 21. Figure 20 shows the text matrix. The initial low mass flow rates proved ignitable across the entire mass flow and mixture range tested, as can be seen in the sub-2 g/s range of the graph. As that configuration could not yield conditions under which ignition would not occur, the next size of orifices were replaced. The mixture ratio was selected at 1.6 so as to provide an ignitable mixture that wouldn't damage the components of the igniter. The reported mixture ratio is the total averaged over the duration of the firing time. The mass flow rate was increased to determine if there was an achievable limit. The mass flow rate was scaled through and beyond the designed mass flow rate. Multiple orifice

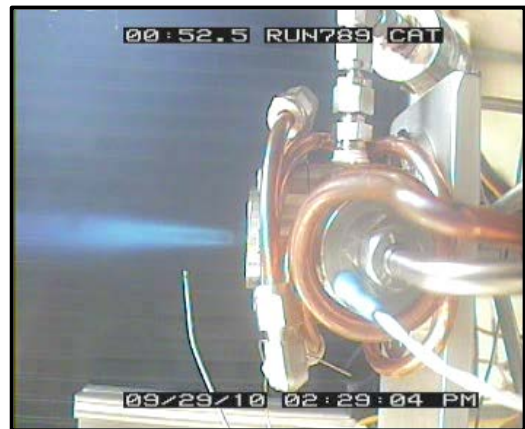

Figure 20. Main Igniter with Choked Gas Torch Flame.

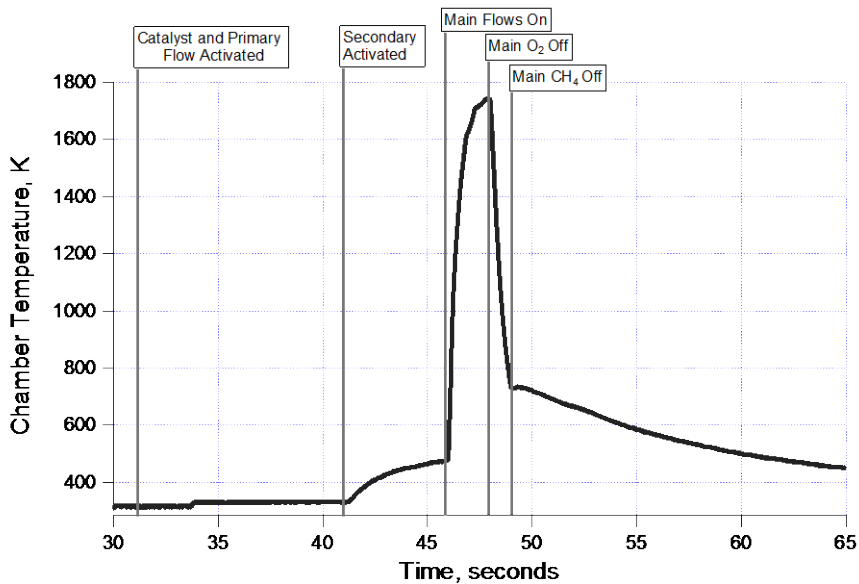

Figure 22. Chamber Temperature Trace of Main Igniter with Gas Propellants.

that would attain a steady temperature. Partly, this was done for the sake of the preservation of the device, should a mixture ratio excursion occur, but also this is somewhat typical of the pulsed operations that this technology could see in its duty as an ignition system for thrusters like attitude control systems.

Other behaviors of note within these trials have to do with the survivability of the catalyst. The deactivation issue was addressed and was a problem with the control system. The other observation was that the catalyst did exhibit some physical deformation thought to be due to the sudden pressure rise in choked conditions after ignition of the main flows. A before and after comparison of the catalyst can be seen in Fig. 23. There were no other mechanical loads on the catalyst that occurred during these trials. The behavior of the combined thermal weakening/expansion and gravity effect was already observed in the previous experimental series and did not result in this change. The sudden rise in pressure, originating in the main igniter cavity away from the catalyst, was the only large change that could have affected the tubes. Knowing now the limits of the catalyst and the corresponding behavior, this issue can be rectified in future iterations with a design and manufacturing modification. This catalyst was intentionally left long to allow variation of conditions to test for optimum points but could be shortened. Not only would a shorter length potentially reduce the power consumption as the voltage drop would be diminished, the structural strength of the catalyst would be improved as it would have less of a cantilevered length. A redesign of the channel the catalyst is contained within could also alleviate this issue. The distortion of the catalyst could cause misalignment and improper mixing of the hot catalytic products and primary augments, potentially preventing ignition, but no misfires were traced to this issue. It seems that the mixing and multiple stagnation and recirculation zones within the device allowed ignition to occur even without ideal placement.



Figure 23. Image Comparison of Catalyst Before and After Test Series. Note the separation and linearity in former and helical shape in after and different scales.

Since this ignition system must be able to light an engine, a high temperature torch is required. The resulting temperature maximums detected within the main chamber across the range tested approached chamber temperatures of 2050 K, near to the adiabatic flame temperatures calculated in CEA.

It should also be noted that these were firings of 2 second duration. As seen in Fig. 22, the temperature did not necessarily reach steady state. Since the primary focus of this study was on ignition, these firings were kept short to encapsulate that behavior, not necessarily last for a long burn

V. Conclusions

A. Summary

This study has successfully developed, demonstrated, and characterized how a microtube catalyst can be utilized as a low power ignition source and create a torch similar to a spark ignition system. A unique design of the catalyst was developed that optimized the exit temperature of the vented combusted gas and this design is currently being pursued for a patent, NASA Glenn Research Center Case LEW-18565-1. An operational regime for the catalyst was established with a total power application of fewer than 30 W required to develop a torch, an improvement over both comparable state of the art spark and alternative catalytic ignition systems. The activation, deactivation, and reactivation behavior of the catalyst was studied and the means to prevent deactivation and ensure the integrity of the catalyst were developed.

A design was created to create a flame kernel via the staged injection of further propellant flows. With the catalyst operating with a fuel-rich mixture mass flow on the order of 0.01 g/s, a premixed fuel-lean mass flow of a similar flow rate served as the primary augmentor, and a nonpremixed fuel-rich flow with a flow on the order of 0.1 g/s served as the secondary augmentor. These stages were integrated into a system with a similar geometric design as a comparable spark system and were used to ignite flows from 1.0 g/s to 10.0 g/s in a chamber representative of comparable igniter hardware generating the required torch behavior. The required mixture and flow conditions for successful and repeatable operation of this behavior were established. With this type of catalytic ignition demonstrated, these results show that a low energy ignition on-demand alternative exists with a different technological basis to the current state of the art. For the sake of mission safety and reliability, innovative concepts such as this should continue to be studied and implemented.

B. Future Work

In order to truly validate the concept, successful staged ignition under altitude and cryogenic conditions to create a stable torch should be carried out. While this study has established many steps towards that goal, the limits imposed have restricted it from reaching that goal at this time. Modifications to the design will be necessary, but the understanding to make those is well developed. Using hardware based on this concept to ignite a rocket will be an important step to test the operation and integrity under the dynamic pressure, temperature, and force conditions therein before the further implementation on flight hardware.

Acknowledgements

M. Deans thanks the NASA Graduate Student Researchers Program and the NASA Glenn Research Center Co-Op program for the support that made this effort possible.

References

- ¹Smith, T., M. Klem, and K. Fisher. "Propulsion Risk Reduction Activities for Non-Toxic Cryogenic Propulsion." AIAA SPACE 2010 Conference & Exposition. Anaheim: AIAA 2010-8680, 2010.
- ²Zurawski, R. L., and J. M. Green. "Catalytic Ignition of Hydrogen and Oxygen Propellants." AIAA/ASME/SAE/ASEE 24th Joint Propulsion Conference. Boston: AIAA-1988-3300, 1988.
- ³La Ferla, R., R. H. Tuffias, and Q. Jang. "Monolithic Catalytic Igniters." AIAA/SAE/ASME/ASEE 29th Joint Propulsion Conference and Exhibit. Monterey: AIAA-1993-1905, 1993.
- ⁴Deans, M. C. A Computational Study of the Ignition of Premixed Methane and Oxygen via a Hot Stream. Cleveland: Case Western Reserve University MS Thesis, 2009.
- ⁵Jensen, K., et al. "Warm-Gas Thruster Development Using Gaseous Hydrogen and Oxygen Catalytic Ignition." 36th AIAA/ASME/SAE/ASEE Joint Propulsion Conference and Exhibit. Huntsville: AIAA-2000-3163, 2000.
- ⁶Boyarko, G., C. J. Sung, and S. J. Schneider. "Catalyzed Combustion of Hydrogen-Oxygen in Platinum Tubes for Micro-Propulsion Applications." 42nd AIAA Aerospace Sciences Meeting and Exhibit. Reno: AIAA, 2004.
- ⁷Volchko, S. J., C. J. Sung, Y. Huang, and S. J. Schneider. "Catalytic Combustion of Rich Methane/Oxygen Mixtures for Micropropulsion Applications." *Journal of Propulsion And Power*, 2006: 684-693.

⁸Mento, C. A., C. J. Sung, A. F. Ibarreta, and S. J. and Schneider. "Catalytic Ignition of Methane/Hydrogen/Oxygen Mixtures for Microthruster Applications." 42nd AIAA/ASME/SAE/ASEE Joint Propulsion Conference and Exhibit. Sacramento: AIAA-2006-4871, 2006.

⁹Reed, B., and S. Schneider. "Hydrogen/Oxygen Auxiliary Propulsion." AIAA/NASA/OAI Conference on Advanced SEI Technologies. Cleveland: AIAA-1991-3440, 1991.

¹⁰Kearns, K. "The Revamping of an Ignition Test Facility." 41st Aerospace Sciences Meeting and Exhibit. Reno: AIAA 2003-279, 2003.

¹¹Burkhardt, H., M. Sippel, A. Herberz, and J. Klevanski. "Kerosene vs. Methane: A Propellant Tradeoff for Reusable Liquid Booster Stages." Journal of Spacecraft and Rockets vol.41 no.5, 2004: 762-769.

¹²Rupe, J. H. The Liquid Phase Mixing of a Pair of Impinging Streams. Pasadena: NASA Jet Propulsion Laboratory, 1953.

¹³Brauers, B., H. Snijders, W. Kwan, A. Mayer, R. Strunz, and T. Kachler. "Overview of the Development of the Catalytic Igniter For the Next Generation Launcher." 46th AIAA/ASME/SAE/ASEE Joint Propulsion Conference & Exhibit. Nashville: AIAA 2010-7058, 2010.