

Nuclear Propulsion for Space Applications

M. G. Houts, R. D. Bechtel, S. K.
Borowski, J. A. George, T. Kim, W. J.
Emrich, R. R. Hickman, J. W.
Broadway, H. P. Gerrish, R. B. Adams

presented by

Mike Houts
Michael.houts@nasa.gov





Basics of Nuclear Systems

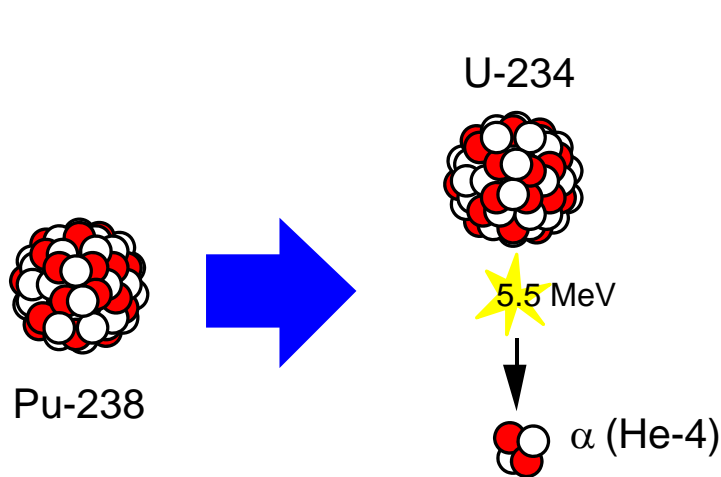

Heat Energy = 0.023 MeV/nucleon (0.558 W/g Pu-238)
Natural decay rate (87.7-year half-life)

Long history of use on Apollo and space science missions

44 RTGs and hundreds of RHUs launched by U.S. during past 4 decades

Heat produced from natural alpha (α) particle decay of Plutonium (Pu-238)

Used for both thermal management and electricity production

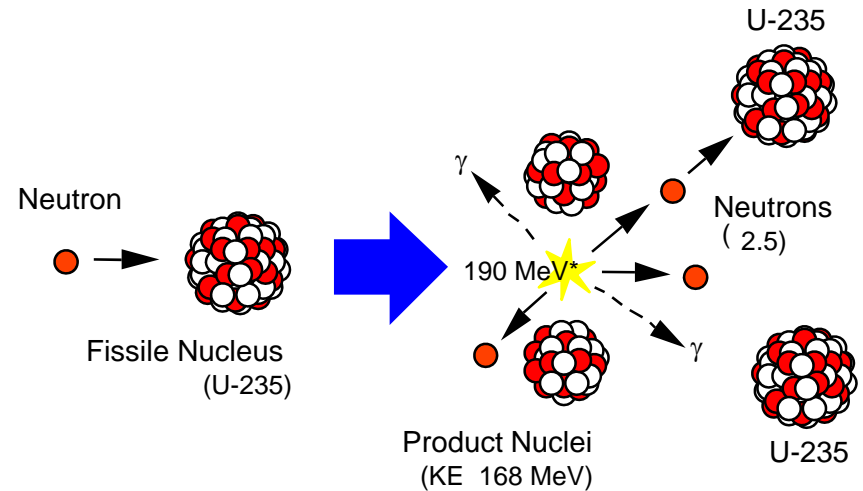

Heat Energy = 0.851 MeV/nucleon
Controllable reaction rate (variable power levels)

Used terrestrially for over 65 years

Fissioning 1 kg of uranium yields as much energy as burning 2,700,000 kg of coal

One US space reactor (SNAP-10A) flown (1965)

Former U.S.S.R. flew 33 space reactors

Heat produced from neutron-induced splitting of a nucleus (e.g. U-235)

At steady-state, 1 of the 2 to 3 neutrons released in the reaction causes a subsequent fission in a "chain reaction" process

Heat converted to electricity, or used directly to heat a propellant



Fission Introduction

- **Creating a fission chain reaction is conceptually simple**
 - Requires right materials in right geometry
- **Good engineering needed to create safe, affordable, useful fission systems**

- **1938 *Fission Discovered***
- **1939 *Einstein letter to Roosevelt***
- **1942 *Manhattan project initiated***
- **1942 *First sustained fission chain reaction (CP-1)***
- **1943 *X-10 Reactor (ORNL), 3500 kWt***
- **1944 *B-Reactor (Hanford), 250,000 kWt***
- **1944-now *Thousands of reactors at various power levels***

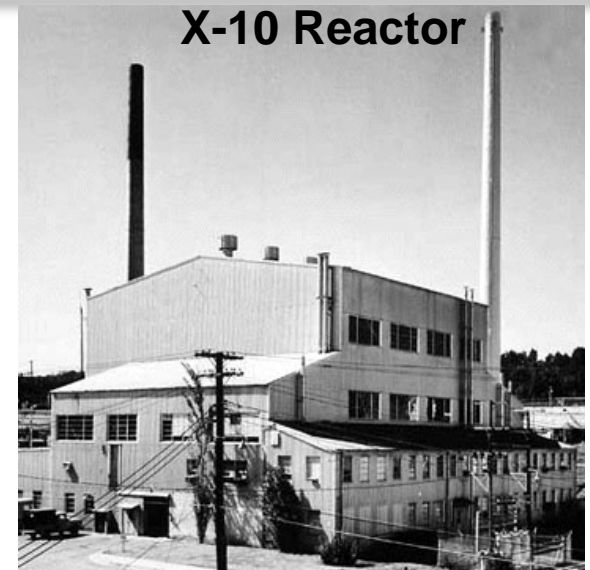



Fission is Highly Versatile with Many Applications

- Small research reactors
 - Examples include 2000 kWt TRIGA reactor recently installed in Morocco (< \$50M)
- Advanced, high-power research reactors and associated facilities
 - Examples include the US Fast Flux Test, EBR-II, ATR, HFIR
- Commercial Light Water Reactors
1,371,000 kWe (3,800,000 kWt)
- Space reactors
 - SNAP-10A 42 kWt / 0.6 kWe
 - Soviet reactors typically 100 kWt / 3 kWe (some systems >150 kWt)
 - Cost is design-dependent

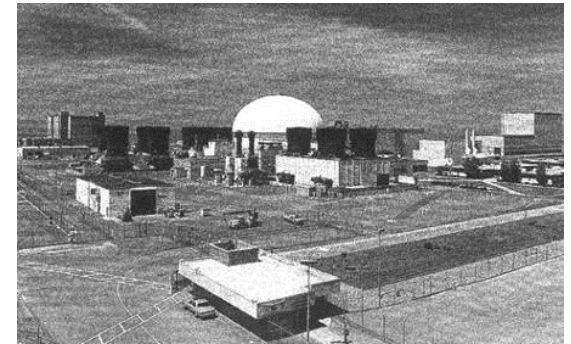
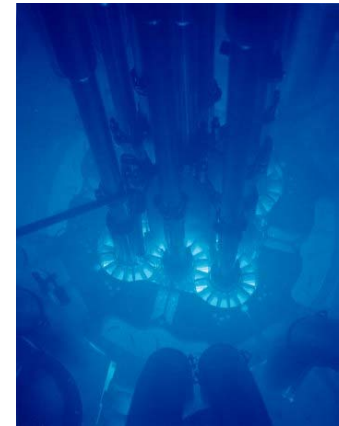

Figure II-92. SNAP 10A Flight System



Fission is Highly Versatile with Many Applications (continued)

- Naval Reactors
 - Hundreds of submarines and surface ships worldwide
- Production of medical and other isotopes
- Fission Surface Power
 - Safe, abundant, cost effective power on the moon or Mars
- Nuclear Thermal Propulsion
 - Potential for fast, efficient transportation throughout inner solar system
- Nuclear Electric Propulsion
 - Potential for efficient transportation throughout solar system
- Highly advanced fission systems for solar system exploration





Typical Space Fission System Operation

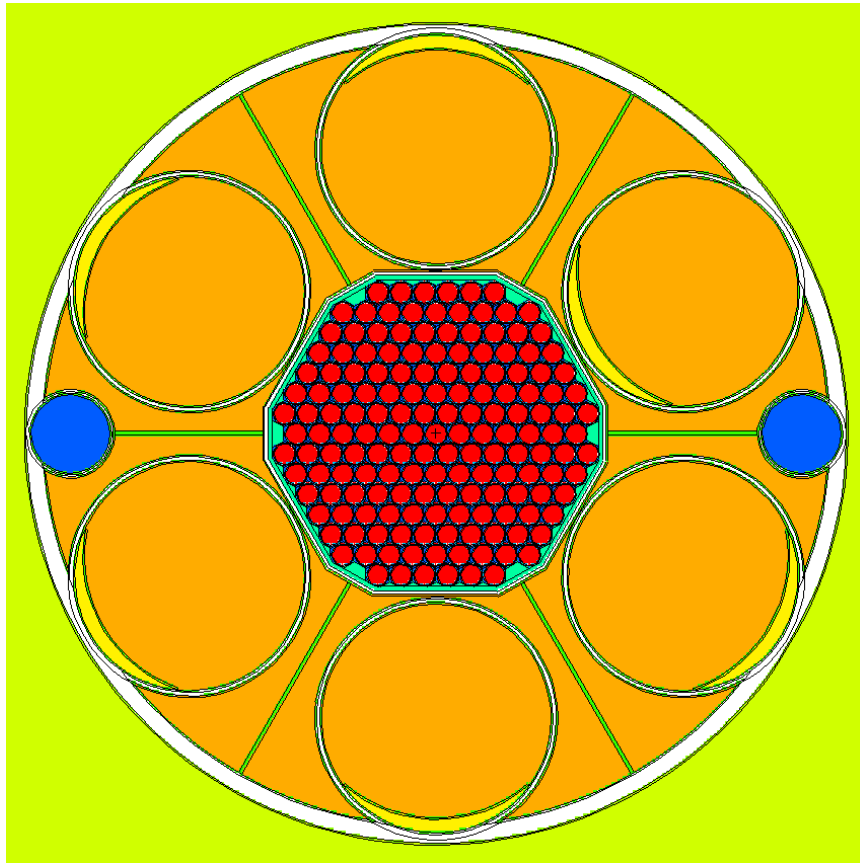

0.5 m

- System power controlled by neutron balance
- Average 2.5 neutrons produced per fission
 - Including delayed
- Constant power if 1.0 of those neutrons goes on to cause another fission
- Decreasing power if < 1.0 neutron causes another fission, increasing if > 1.0
- System controlled by passively and actively controlling fraction of neutrons that escape or are captured
- Natural feedback enables straightforward control, constant temperature operation
- 200 kWt system burns 1 kg uranium every 13 yrs



Safe, Compact, Near-Term Fission Power Systems Could Help Enable Higher Power Fission Propulsion Systems

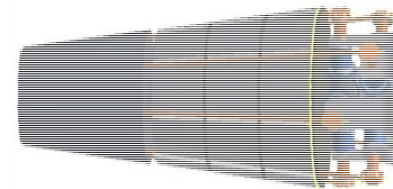

Science:

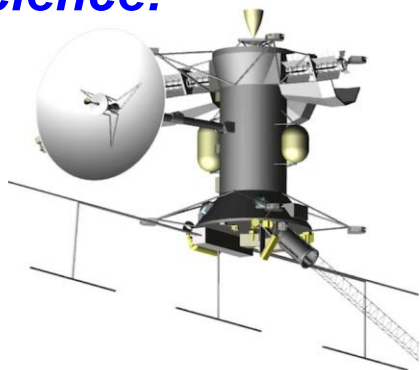

Jupiter Europa Orbiter
~600 We (5 to 6 RPS)

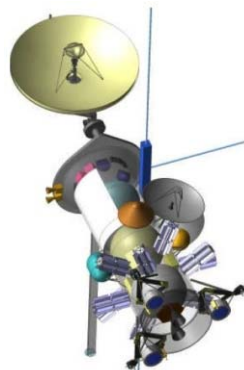

Neptune Systems Explorer
~3 kWe (9 Large RPS)

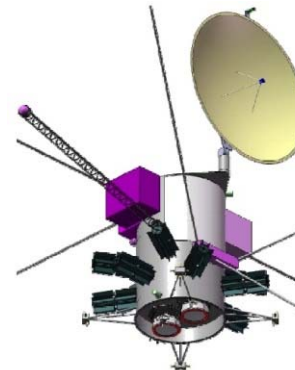

Kuiper Belt Object Orbiter
~4 kWe (9 Large RPS)

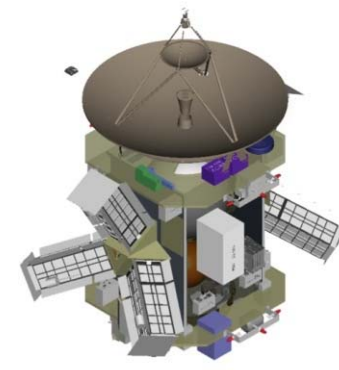

Trojan Tour
~800 We (6 RPS)

Exploration:

Teleoperated Rovers

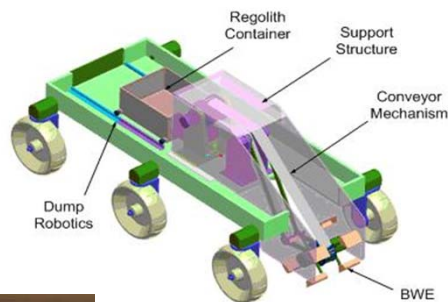

ISRU Demo Plants



Site Survey Landers

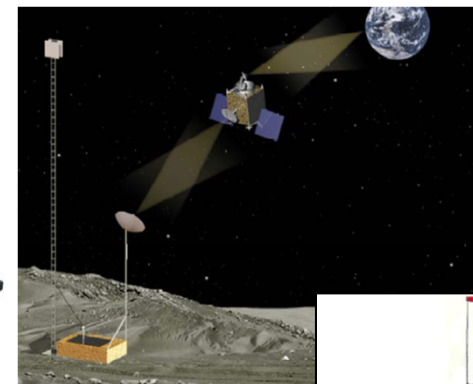
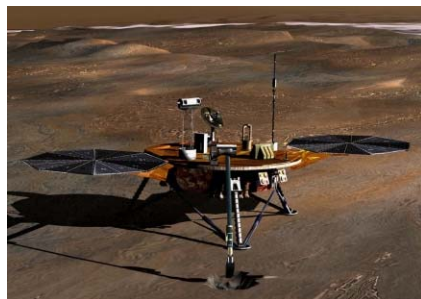

Comm Relay Stations

Remote Science Packages

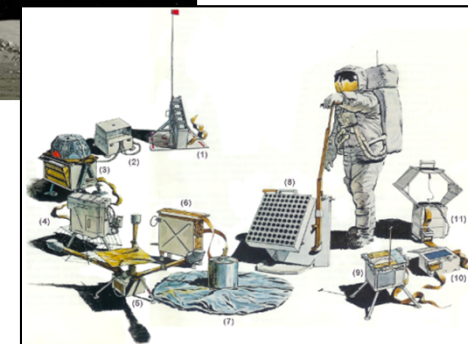



Fission Can Provide the Energy for Either Nuclear Thermal or Nuclear Electric Propulsion Systems

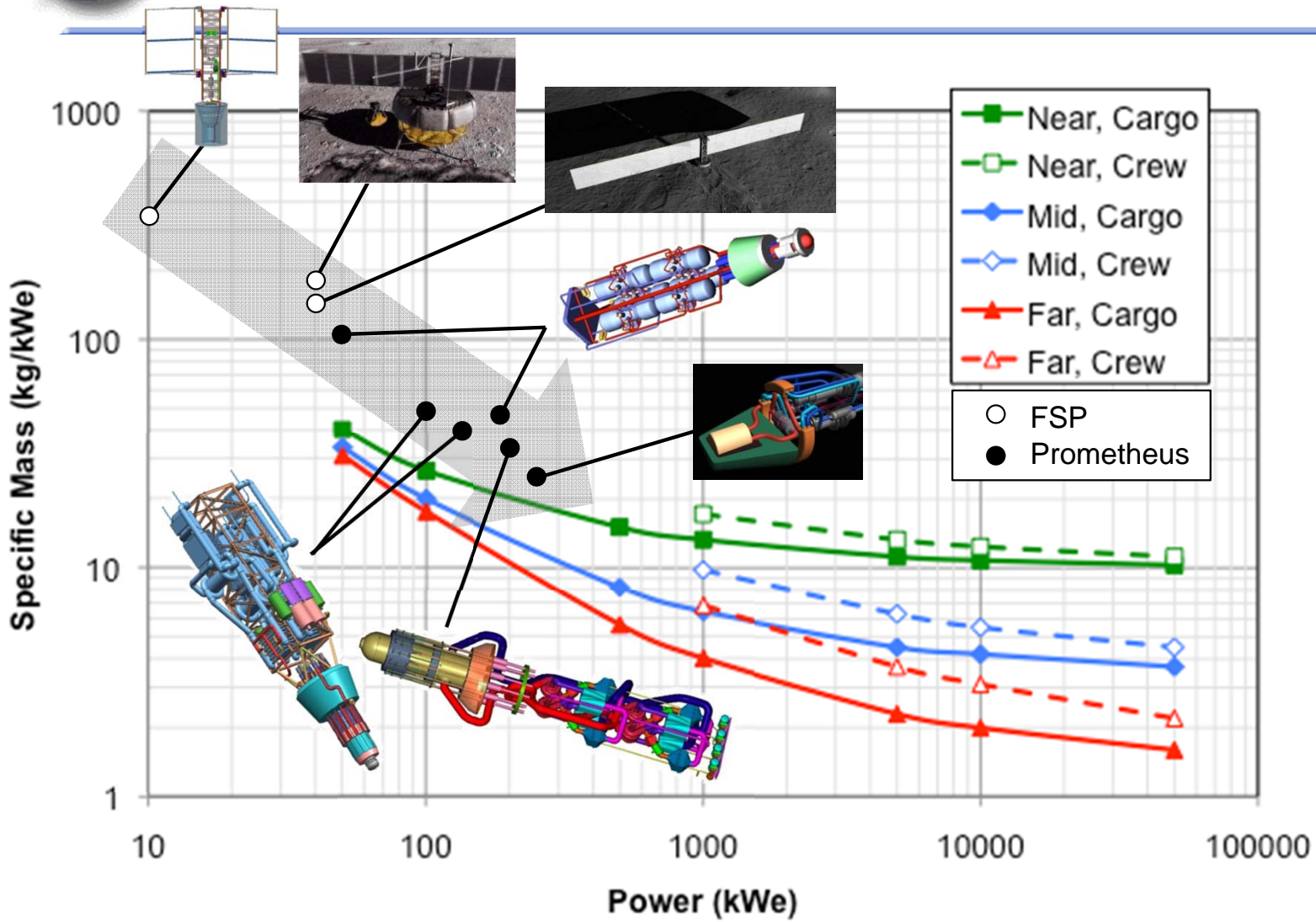

- NEP Power System Performance Projections from 2001 STAIF Conference
- Fission Surface Power and Prometheus Concepts Superimposed

Near=Liq Metal Rx, Brayton, 1300K, 6 kg/m², 200 Vac (Available ~10 yrs)
 Mid=Liq Metal Rx, Brayton, 1500K, 3 kg/m², 1000 Vac (Available ~ 15-20 yrs)
 Far=Liq Metal Rx, Brayton, 2000K, 1.5 kg/m², 5000 Vac (Available ~ 25-30 yrs)
 Cargo=Instrument rated shielding, 1.6x10¹⁵ nvt, 1.2x10⁸ rad @ 2 m
 Crew=Human rated shielding, 5 rem/yr @ 100 m, 7.5° half angle

Chart courtesy
 Lee Mason,
 NASA GRC



NASA is Currently Funding an “Advanced Exploration Systems” Project Investigating a Nuclear Cryogenic Propulsion Stage (NCPS)

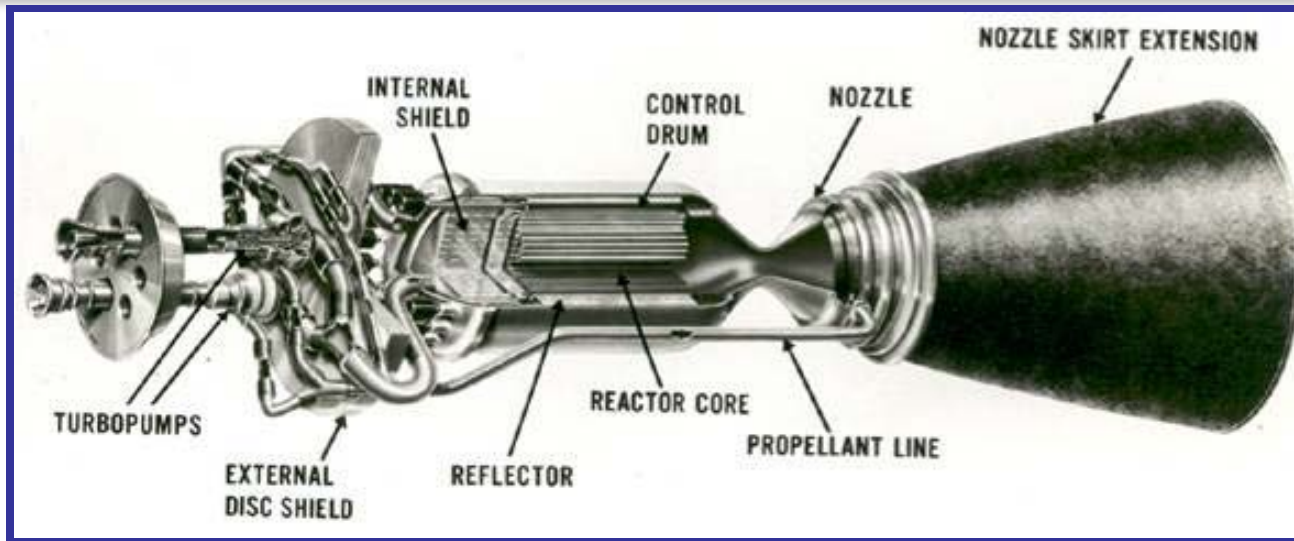

- Nuclear thermal propulsion (NTP) is a fundamentally new capability
 - Energy comes from fission, not chemical reactions
 - Virtually unlimited energy density
- Initial systems will have specific impulses roughly twice that of the best chemical systems
 - Reduced propellant (launch) requirements, reduced trip time
 - Beneficial to near-term/far-term missions currently under consideration
- Advanced nuclear propulsion systems could have extremely high performance and unique capabilities
- The NCPS could serve as the “DC-3” of space nuclear power and propulsion





NCPS Builds on Previous NTP Engine Designs / Tests

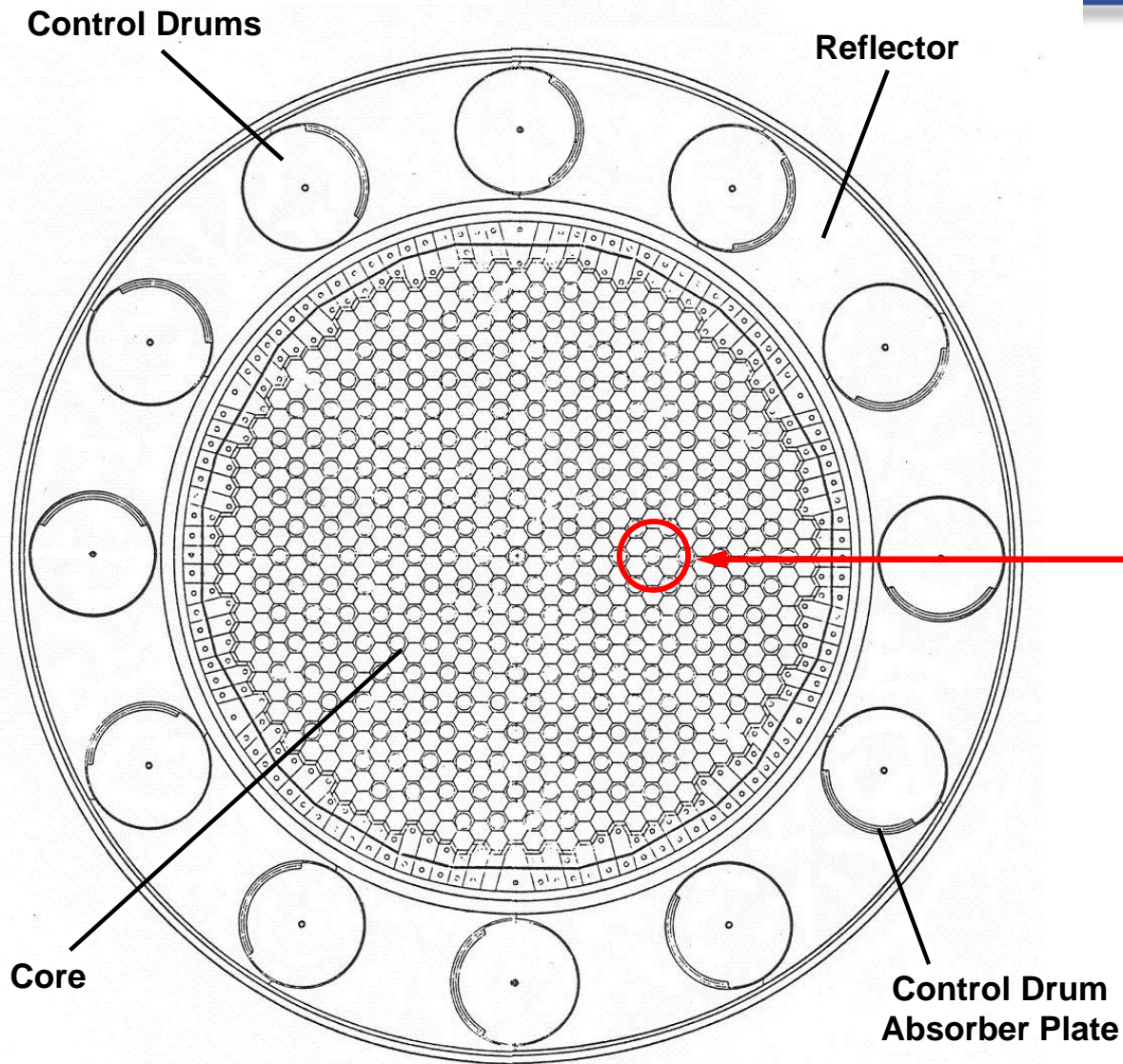

NERVA Reactor Cross Section

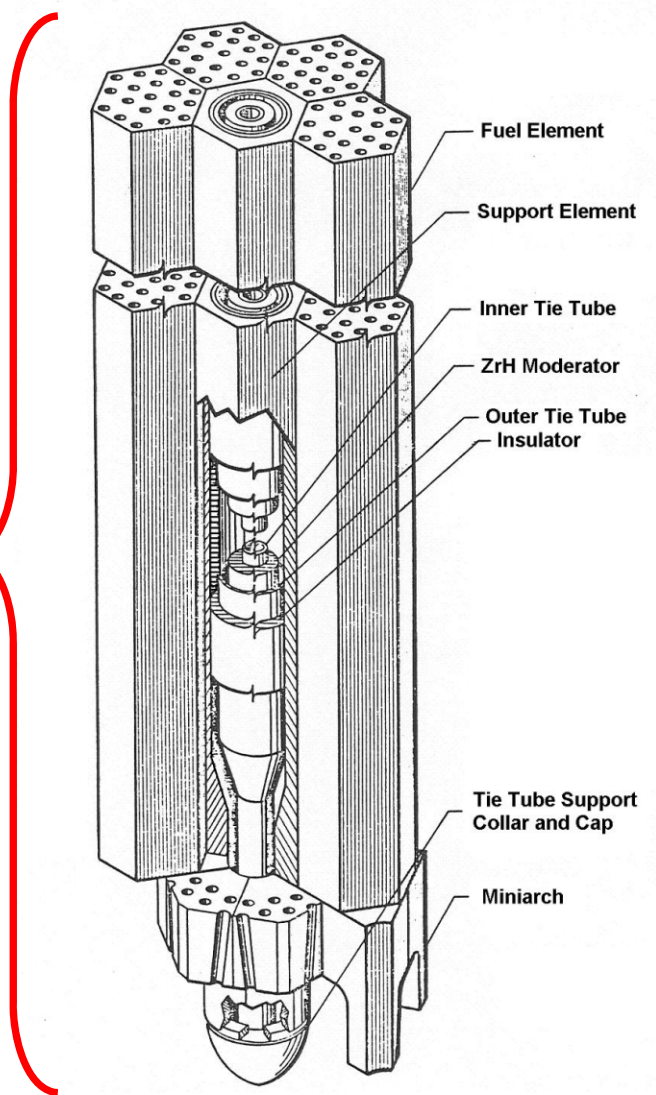

Fuel Segment Cluster



NCPS builds on the highly successful Rover/NERVA program (1955-1973) and more recent programs

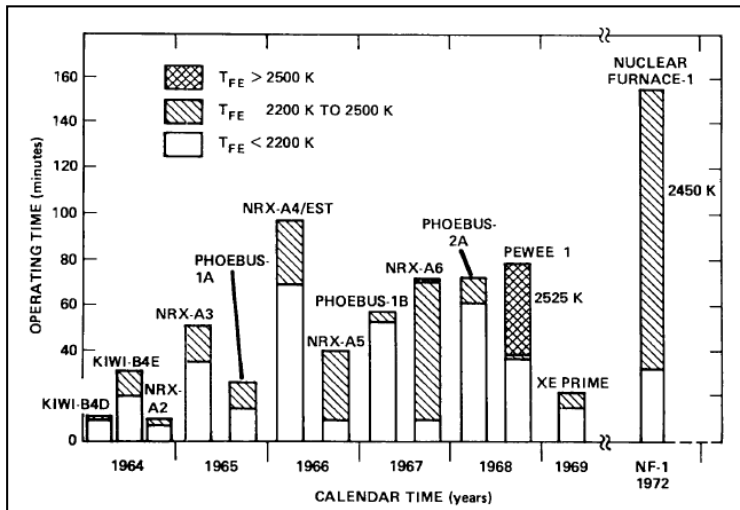
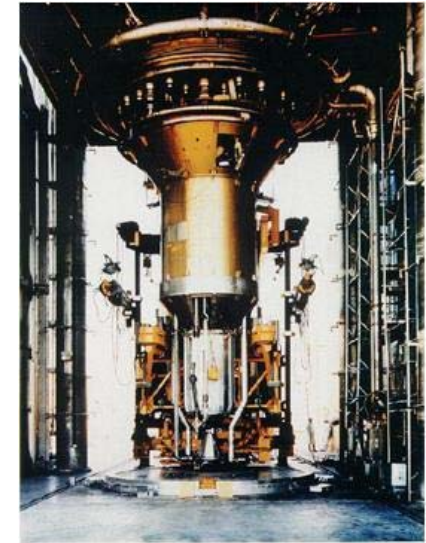
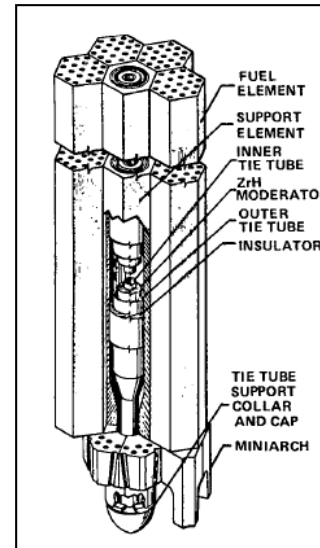
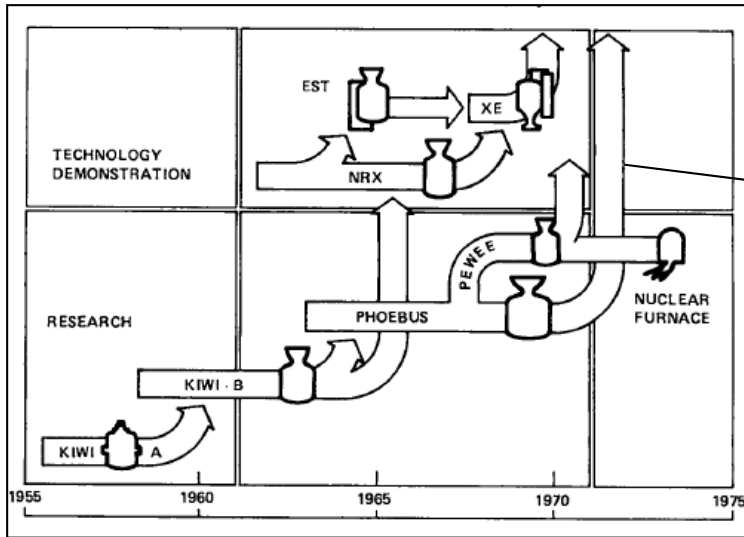



PHOEBUS NUCLEAR ROCKET ENGINE



The most powerful nuclear rocket engine ever tested (Phoebus 2a) is shown during a high-power test. The reactor operated for about 32 minutes, 12 minutes at power levels of more than 4.0 million kilowatts.



NCPS Project Work Breakdown Structure

1.0 NCPS Project Management

Project Manager: Mike Houts (MSFC)
DOE Lead: Ryan Bechtel
GRC Lead: Stan Borowski
JSC Lead: Jeff George

2.0 Pre-conceptual Design of the NCPS & Architecture Integration

Task Lead: Tony Kim

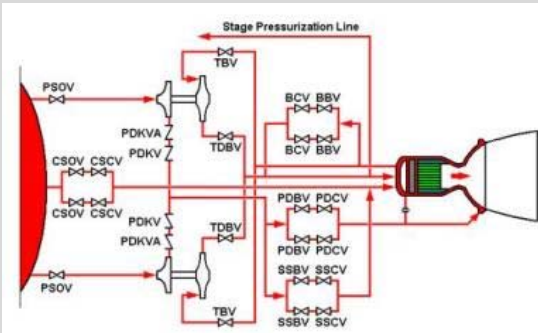

4.0 NCPS Fuel Design / Fabrication

PI: Robert Hickman, MSFC
Task Lead: Jeramie Broadway

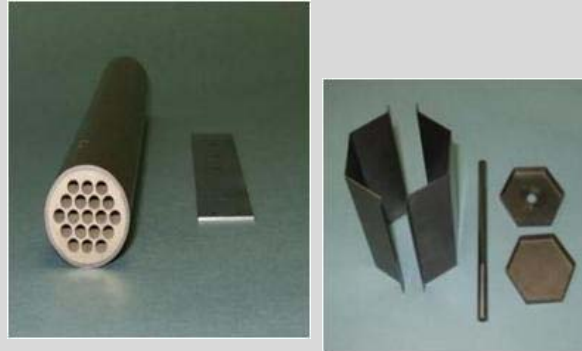

6.0 Affordable NCPS Development and Qualification Strategy

Task Lead: Harold Gerrish



3.0 High Power (≥ 1 MW) Nuclear Thermal Rocket Element Environmental Simulator (NTREES)

Task Lead: Bill Emrich

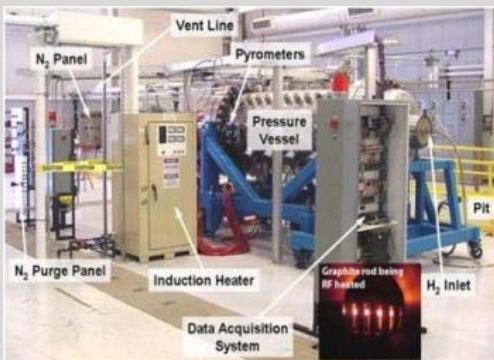

5.0 NCPS Fuels Testing in NTREES & CFEET

Co-Lead: Bill Emrich
Co-Lead: Jeramie Broadway

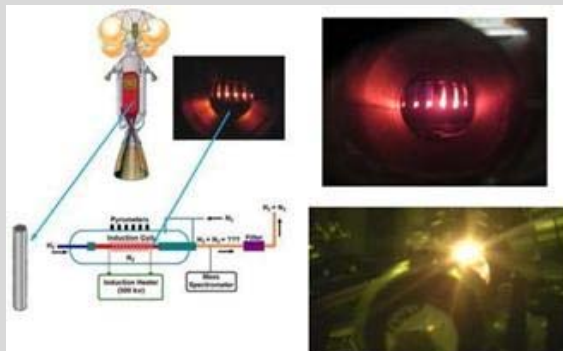

7.0 Second Generation NCPS Concepts

Task Lead: Rob Adams





NTR Transfer Vehicles for Reusable NEA, Lunar Cargo and Crewed Landing Missions using ~70 t-class SLS

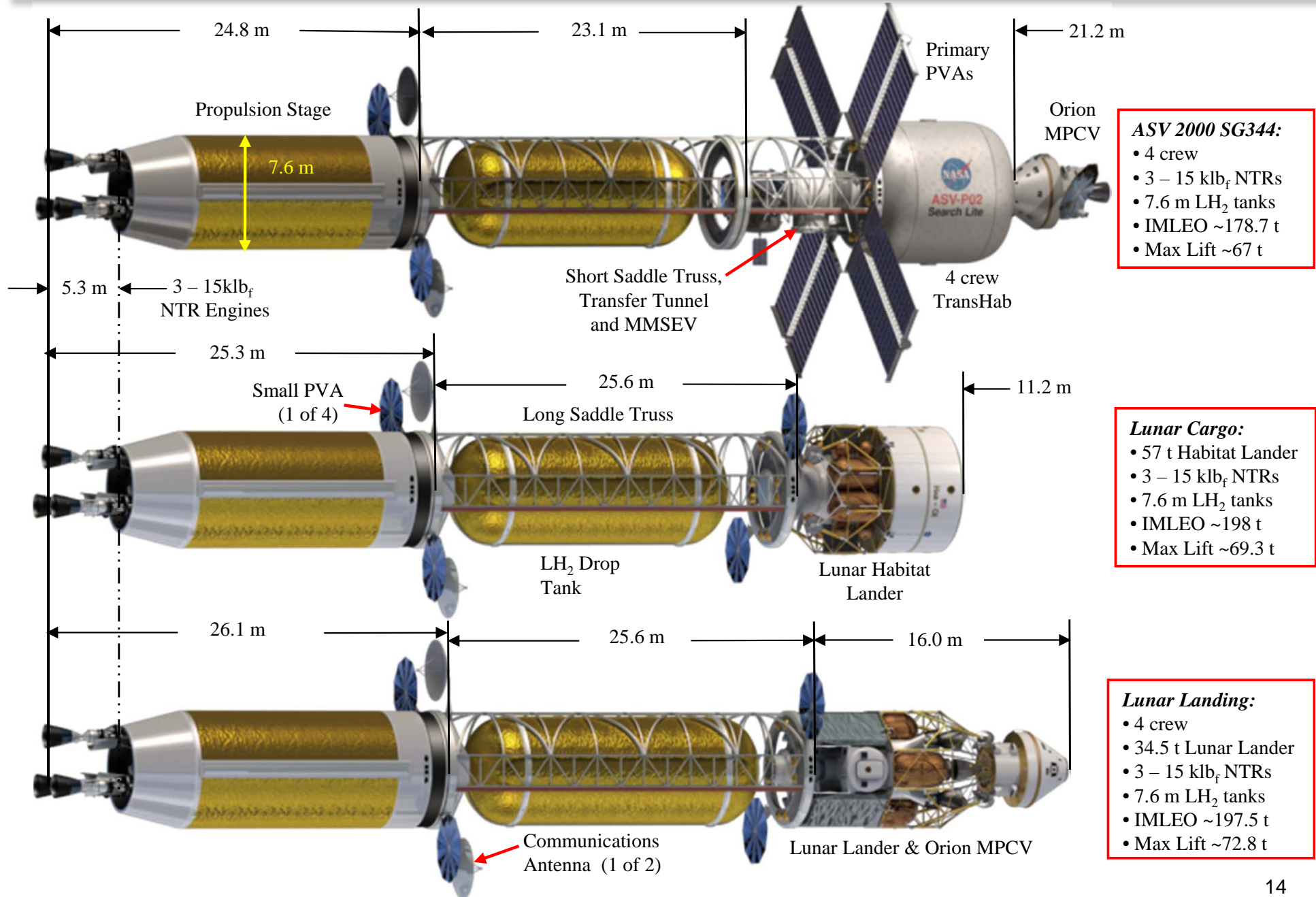



Growth Paths Identified using Modular Components to Increase Vehicle LH₂ Capacity & Mission Applications

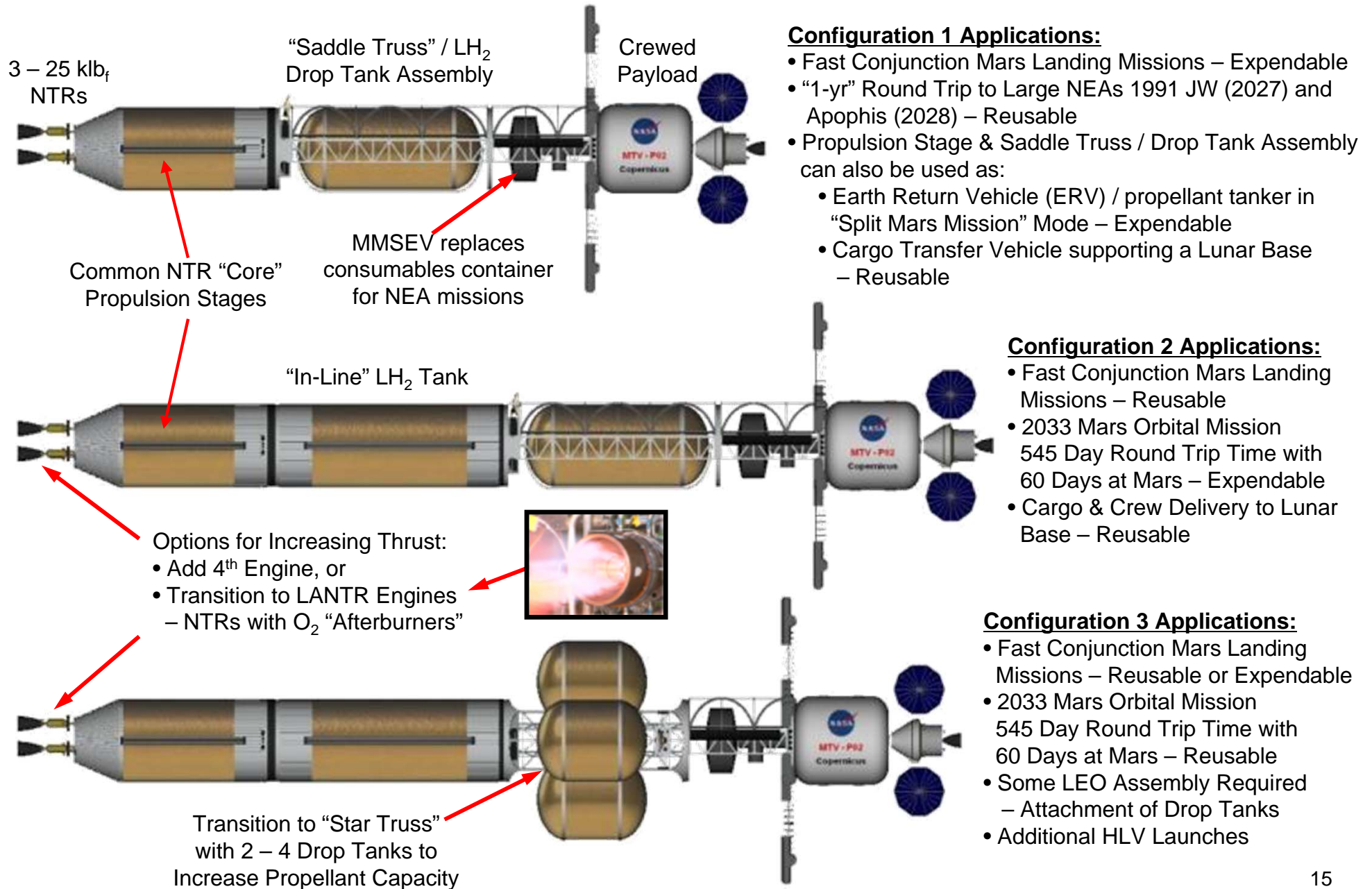



Notional NCPS Mission -- 2033 600 day Mars Piloted Stack Core Stage, In-line Tank, & Star Truss w/ (2) LH₂ Drop Tanks



Design Constraints / Parameters:

- # Engines / Type: 3 / NERVA-derived
- Engine Thrust: 25.1 klbf (Pewee-class)
- Propellant: LH₂
- Specific Impulse, Isp: 900 sec
- Cooldown LH₂: 3%
- Tank Material: Aluminum-Lithium
- Tank Ullage: 3%
- Tank Trap Residuals: 2%
- Truss Material: Graphite Epoxy Composite
- RCS Propellants: NTO / MMH
- # RCS Thruster Isp: 335 sec (AMBR Isp)
- Passive TPS: 1" SOFI + 60 layer MLI
- Active CFM: ZBO Brayton Cryo-cooler
- I/F Structure: Stage / Truss Docking Adaptor w/ Fluid Transfer

Mission Constraints / Parameters:

- 6 Crew
- Outbound time: 183 days (nom.)
- Stay time: 60 days (nom.)
- Return time: 357 days (nom.)
- 1% Performance Margin on all burns
- TMI Gravity Losses: 265 m/s total, f(T/W₀)
- Pre-mission RCS ΔVs: 181 m/s (4 burns/stage)
- RCS MidCrs. Cor. ΔVs: 65 m/s (in & outbnd)
- Jettison Both Drop Tanks After TMI-1
- Jettison Tunnel, Can & Waste Prior to TEI

NTP Transfer Vehicle Description:

NTP system consists of 3 elements: 1) core propulsion stage, 2) in-line tank, and 3) integrated star truss and dual drop tank assembly that connects the propulsion stack to the crewed payload element for Mars 2033 mission. Each 100t element is delivered on an SLS LV (178.35.01, 10m O.D.x 25.2 m cyl. §) to LEO -50 x 220 nmi, then onboard RCS provides circ burn to 407 km orbit. The core stage uses three NERVA-derived 25.1 klbf engines. It also includes RCS, avionics, power, long-duration CFM hardware (e.g., COLDEST design, ZBO cryo-coolers) and AR&D capability. The star truss uses Gr/Ep composite material & the LH₂ drop tanks use a passive TPS. Interface structure includes fluid transfer, electrical, and communications lines.

		Inline	(2) drop payload	core
	Power Level (kW)	5.25	44.75	7.07
	Tank Diameter (m)	8.90	8.90	8.90
	Tank Length (m)	19.30	13.58	17.10
	Truss length (m)		19	12
	Liquid LH ₂	72.18	96.29	62.90
Total	Foodstores			8.01
6 Crew				0.79
	Dry weight	17.67	19.30	36.41
	TransHab+Crew Science			34.649
	Samples			0.25
	CEV			10.10
Total	Launch Element Mass (mt)	100.50	121.48	67.93
	RCS Total Propellant	18.66		
	Total Launched Mass	391.84	mt	

	ΔV (m/s)	Burn Time (min)
1st perigee TMI + g-loss	2380	39.4
2nd perigee TMI	1445	17.8
MOC	1470	15
TEI	3080	23.5
	8375	95.7

Notional Example of Human Mars Mission



High Temperature Fuels Are Key to NTP Performance

Nuclear Thermal Rocket Performance Specific Impulse vs. Chamber Temperature

Two-Dimensional Kinetics, One Dimensional Equilibrium, Boundary Layer
1000 psia Chamber Pressure

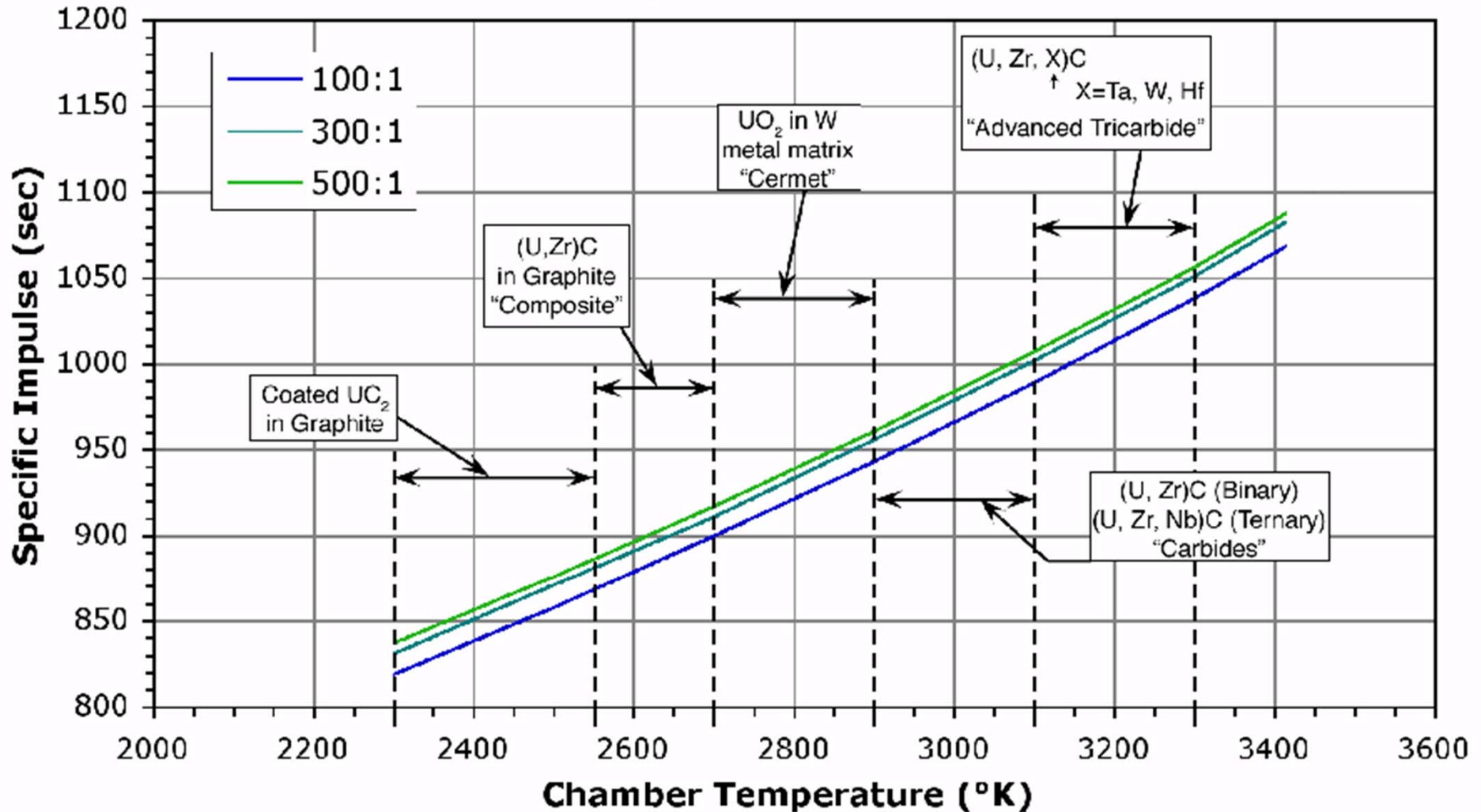



Fuel Material Development

- Develop/evaluate multiple fuel forms and processes in order to baseline a fuel form for NTP
 - CERMET: Hot Isostatic Pressing (HIP), Pulsed Electric Current Sintering (PECS)
 - Graphite composites
- Materials and process characterization
 - Develop and characterize starting materials
 - W coated fuel particles are required for CERMETS
 - Particle size, shape, chemistry, microstructure
 - Develop and characterize consolidated samples
 - Microstructure, density, chemistry, phases
 - Optimize material/process/property relationships
 - Fuel particle size/shape vs. properties
 - Cladding composition and thickness
- Hot hydrogen testing
 - Early development to validate test approach
 - Screen materials and processes (cyclic fuel mass loss)
 - Particle size, chemistry, microstructure, and design features (claddings)



Uranium Dioxide (UO₂) Particle Development

- UO₂ Particle Procurement

- Procured 2kg of dUO₂
- Particle size ranges:
 - <100um
 - 100um – 150um
 - >150um

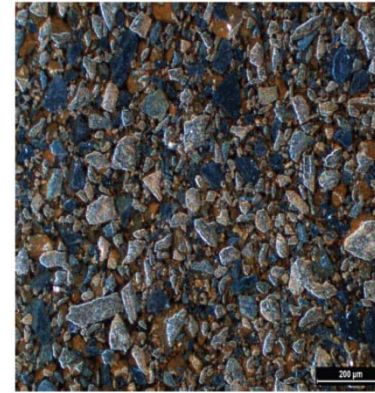

a.)

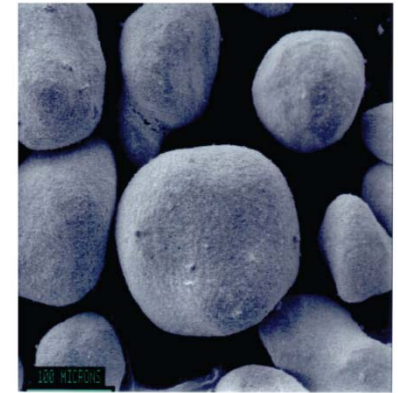

b.)

Y-12 Feedstock, (a) Depleted UO₂ and (b) Natural UO₂

- Plasma Spheroidization System (PSS)

- System design and assembly
- Start-up July 2012

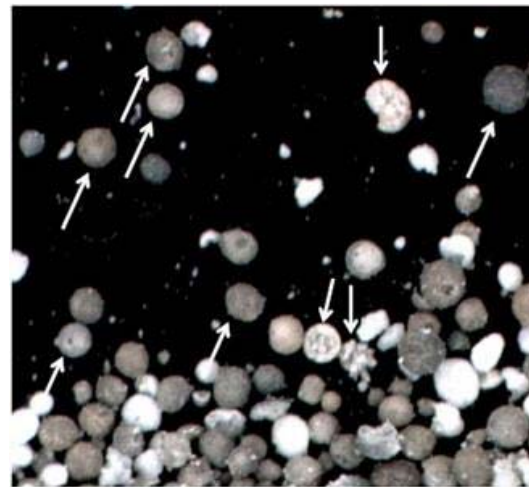

Initial Results



Completed MSFC PSS assembly

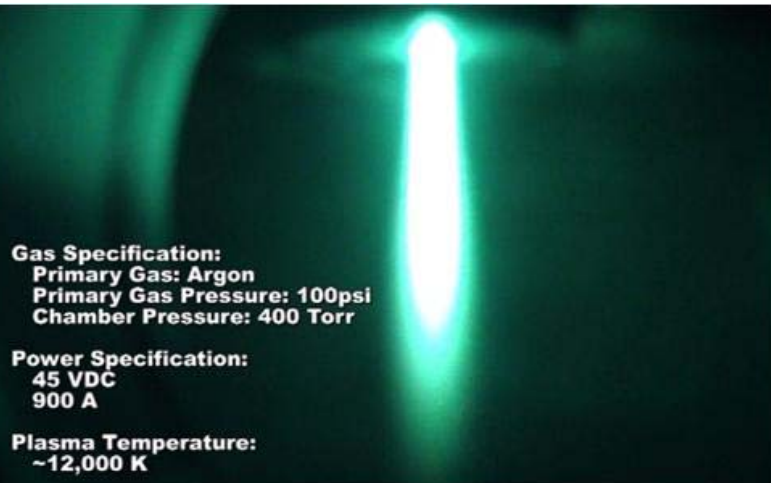



Chemical Vapor Deposition (CVD) Coated Particle Development

- MSFC Tungsten Hexachloride (WCl_6) Process Development

- Redesigned and upgraded CVD system complete
- Demonstrated W coating on Al_2O_3 substrate
- Ongoing fluidization trials
- Reactor design optimization for fluidization

- Tungsten Hexafluoride (WF_6) Process Development

- Process being developed by Ultramet
- Currently coating ZrO_2 particles
- Have demonstrated 20 vol% W coating

- 40 vol% W coated spherical particles required for HIP and PECS consolidation process development



Redesigned CVD System

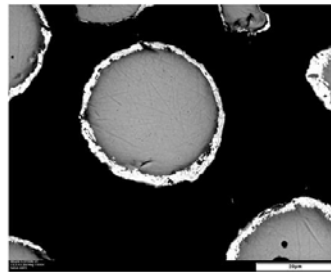
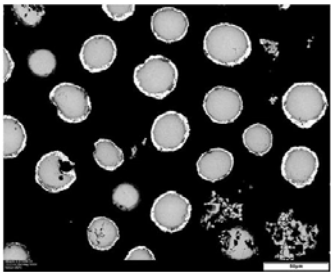

W coated ZrO_2 , average particle OD 31.0 μm , average coating thickness 1.76 μm .

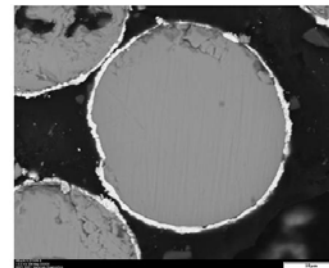
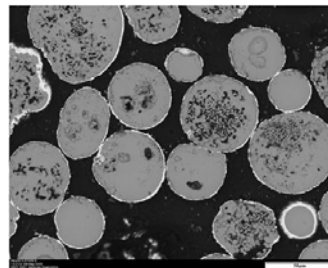

CVD Run 5: 30 minutes. W coated ZrO_2 .



CERMET Consolidation Process Development (CeO_2)

- ANL 200MW element chosen for NCPS reference design

- Hot Isostatic Pressing (HIP) process development

- In-house HIP furnace upgrades underway
- Identified glove box limitations for full size cans
- Established process schedule tolerance
- Updated can designs based on lessons learned
- Initiated manufacture of HIP cans

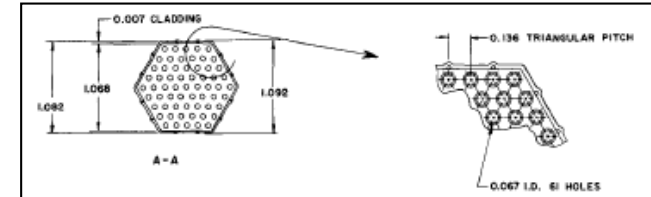

ANL 200MW Reference Design

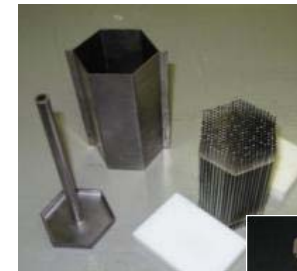

- Pulsed Electric Current Sintering (PECS) Development

- Completed pure W microstructural morphology study
- Fabricated 7 specimens of W-40vol% CeO_2 with varying ratios of particle sizes, W vs. CeO_2 (uncoated)
 - CeO_2 encapsulated W particles when $W > \text{CeO}_2$ (microstructure image shown)
 - Studies ongoing for $\text{CeO}_2 > W$ particle size
- EDM machining investigated as a method to drill coolant channels into W- CeO_2 specimens



HIP Parameters Study Cans

Hexagonal W- CeO_2 Specimen (PECS)



EDM Trials on W- CeO_2 Specimen



Recent Fuels Fabrication Activities



H2 Powder Furnace In Assembly

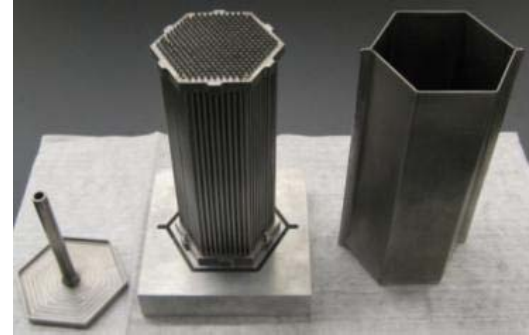

Molybdenum mandrel assembly for 331 Hexagonal demonstration



Piece parts of integrally cladded HIP sample (top).
Cladded HIP sample post HIP



W powder in H2 furnace



Top end cap welding of 331 Hex demo



331 Hexagonal demonstration post HIP

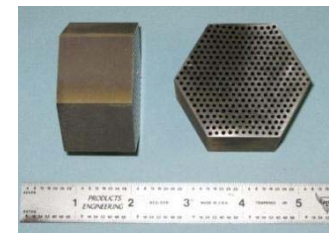



Nuclear Thermal Rocket Element Environmental Simulator (NTREES)

A key technology element in Nuclear Thermal Propulsion is the development of fuel materials and components which can withstand extremely high temperatures while being exposed to flowing hydrogen

NTREES provides a cost effective method for rapidly screening of candidate fuel components with regard to their viability for use in NTR systems

- The NTREES is designed to mimic the conditions (minus the radiation) to which nuclear rocket fuel elements and other components would be subjected to during reactor operation
- The NTREES consists of a water cooled ASME code stamped pressure vessel and its associated control hardware and instrumentation coupled with inductive heaters to simulate the heat provided by the fission process
- The NTREES has been designed to safely allow hydrogen gas to be injected into internal flow passages of an inductively heated test article mounted in the chamber



Nuclear Thermal Rocket Element Environmental Simulator (NTREES)

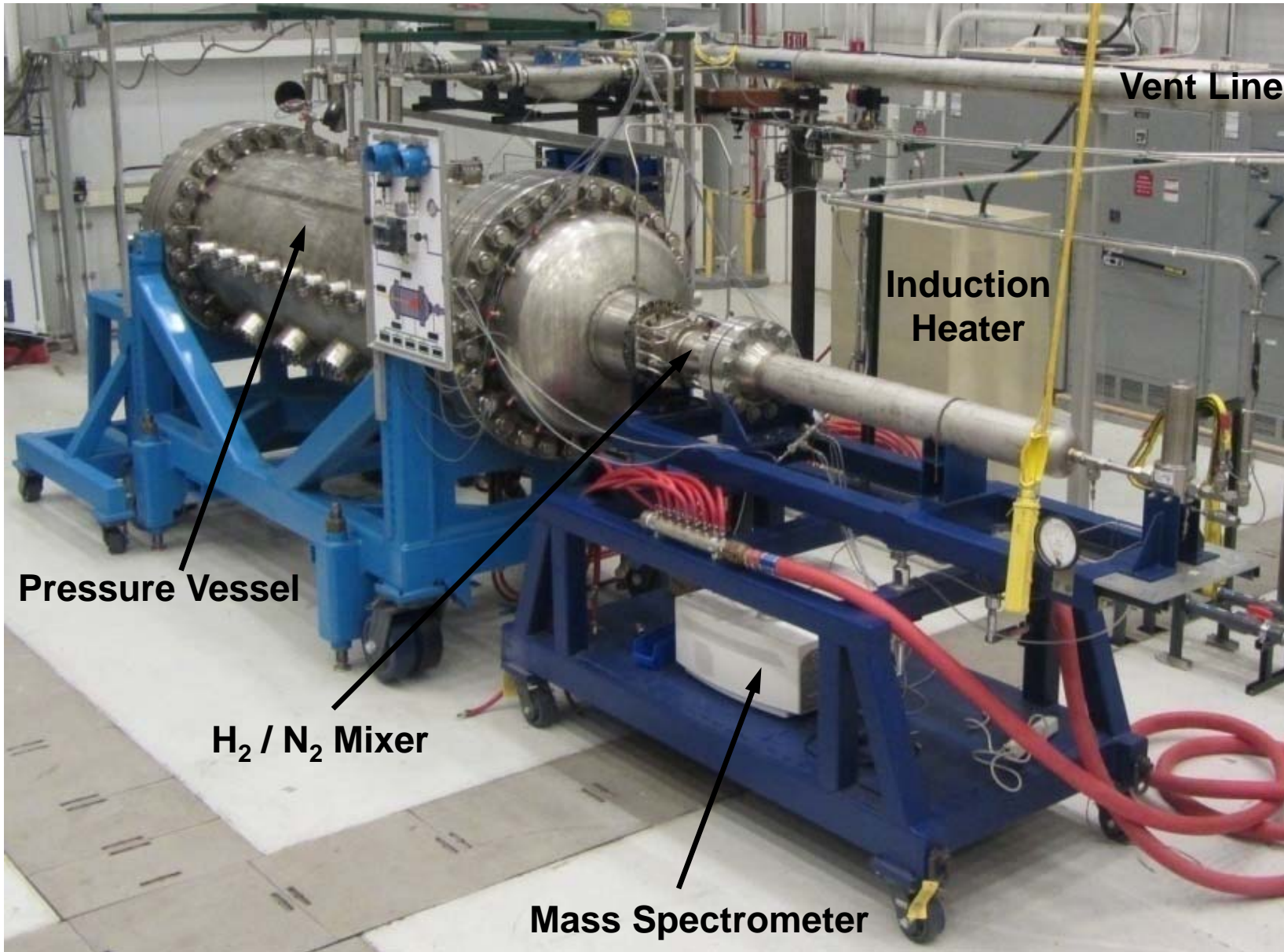



NTREES Undergoing Power Upgrade

- NTREES induction power supply is being upgraded to 1.2 MW
- Water cooling system is being upgraded to remove 100% of the heat generated during testing
- Nitrogen system is being upgraded to increase the nitrogen flow rate to at least 4.5 lb/sec
- New piping is being installed to handle the increased flow rates
- The H₂ / N₂ mixer is being upgraded to handle the increased heat loads
- Platform is under construction to allow the new induction heater to be located underneath the NTREES pressure vessel

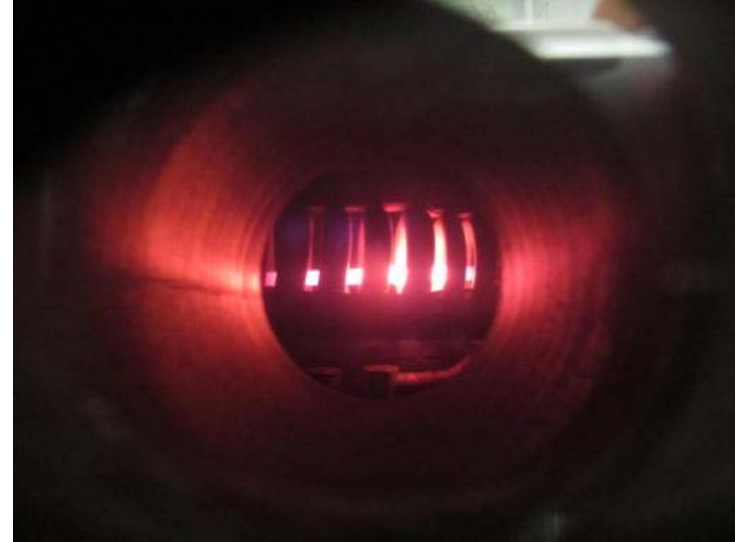



NTREES Testing

Hot Hydrogen Tests of W-HfN CERMET fuel element sample

- Sample completed over two full DRA5 mission profiles
 - 39.4 min full power, cool down
 - 17.8 min full power, cool down
 - 15 min full power, cool down
 - 23.5 min full power, cool down
- Maximum temperature achieved- 2073K



Etched and machined sample pre-test



Sample cross section prior to etch

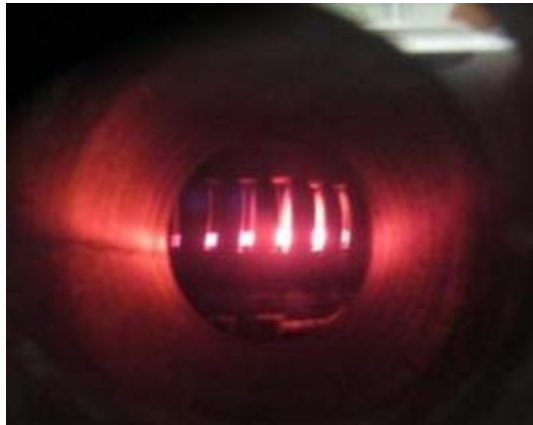

Sample Testing



NTREES Test Video
2 min of 30 min test run



CERMET Fuel Element Environmental Test (CFEET) System

- Coupon level thermal cycle testing
- 0.5" -6" long, 0.5" dia. samples can be thermally cycled at high temperatures quickly
- Flowing hydrogen environment
- System is complete and operational

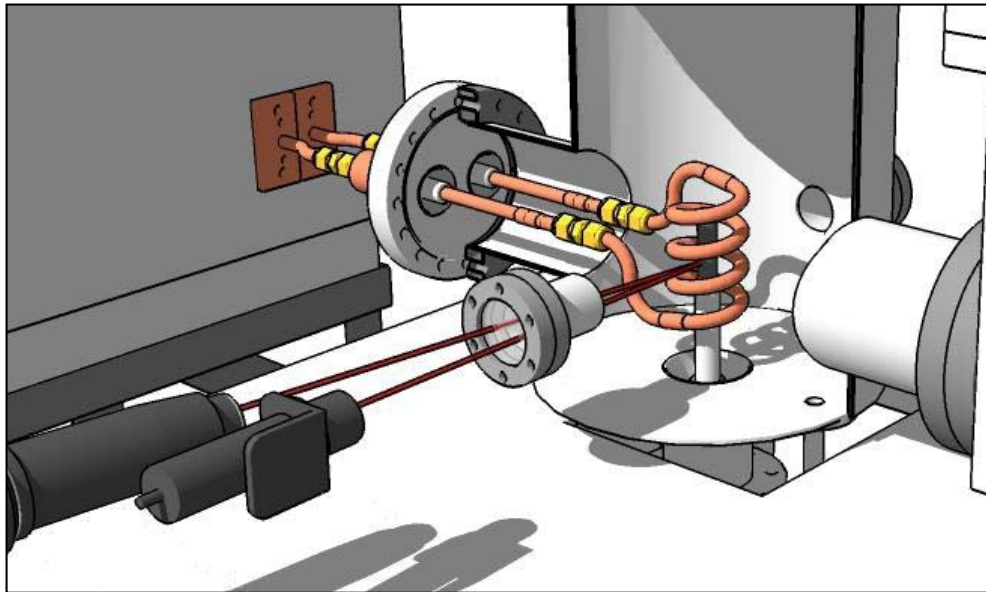

Cross section of CFEET chamber showing heating coils and sample



W/Re sample loaded into heating coil as viewed through the pyrometer viewport



Compact Fuel Element Environmental Tester (CFEET)



Chamber Water Jacketed



Molybdenum Thermal Shield



2 Ton Chiller



H₂ Feed and Burn-stack



Optimized Coil



Flow Controller Calibration

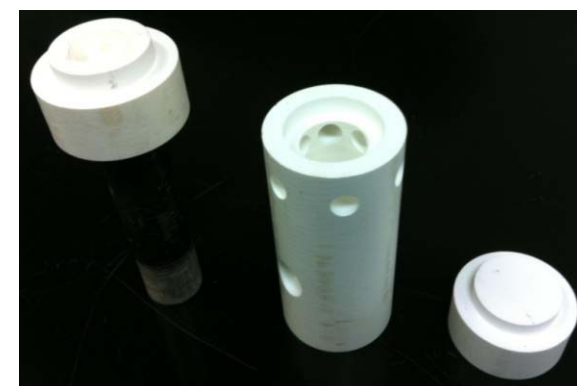

Next Generation BN Pedestal



G-10 & Lexan Flanges

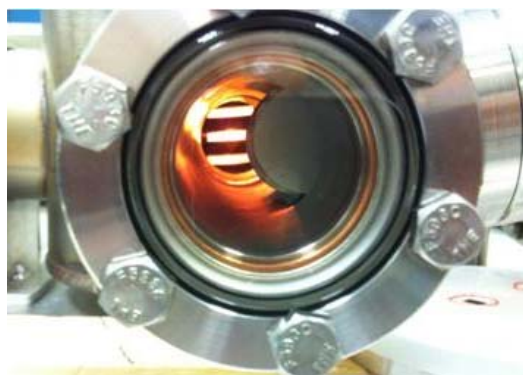

Sight Baffle



CFEET First Hot H₂ Test

- Heated Tungsten sample to 2523K while exposed to flowing H₂ at 16.5 SLPM
- All systems operated nominally



W Sample (0.5" OD x 1.5" L)



Pyrometer Port with sample at 2523 K

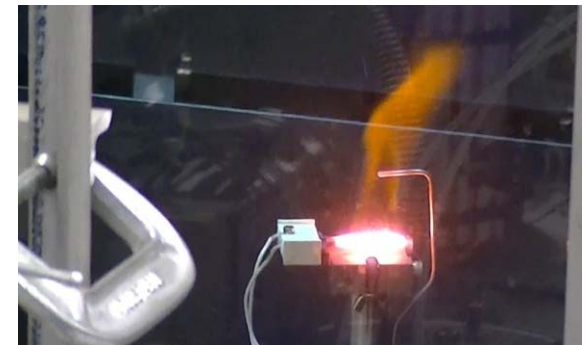

H2 Burn Stack



Temperature Profile



Affordable NCPS Development and Qualification Strategy

- Objective
 - Ensure ease of integration / applicability (SLS, other)
 - Devise an affordable NCPS development and qualification strategy
 - The integrated program development and test strategy will include fuel qualification and selection
 - Will use separate effects tests (hot H₂ and irradiation), innovative ground testing, state-of-the-art modeling, and the development of NCPS engines with an emphasis on affordability
- Key Deliverables
 - Yearly Reports
 - Estimated Cost and Schedule
 - Final Report: NCPS Development and Qualification Strategy

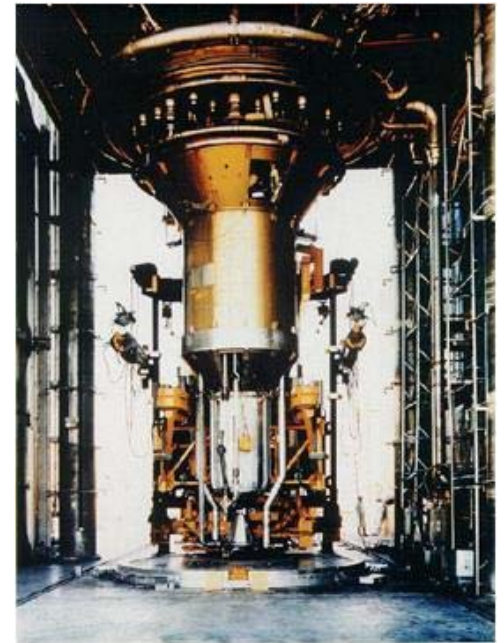



Nuclear Rocket Development Station (NRDS) Assets During Rover/NERVA Program

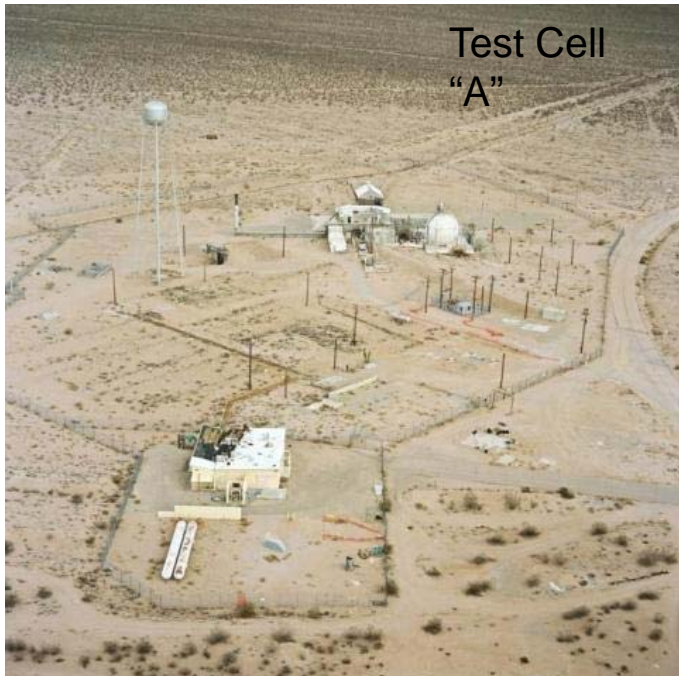

Test Cell
"A"

E-MAD used to assemble nuclear rocket engines for testing and to disassemble and inspect engines after testing

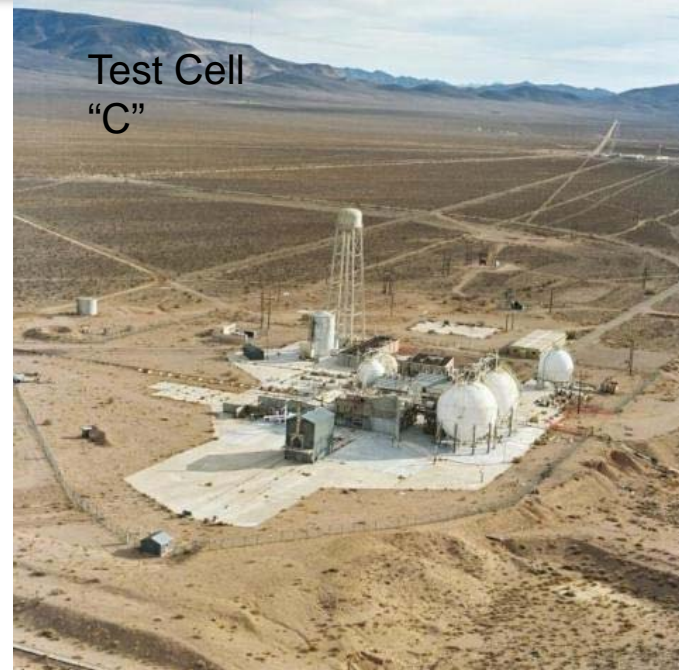

Test Cell
"C"



Nevada Test Site
Bore Hole



NERVA Engine Test Stand (ETS)





Existing Facilities at Idaho National Laboratory (INL)

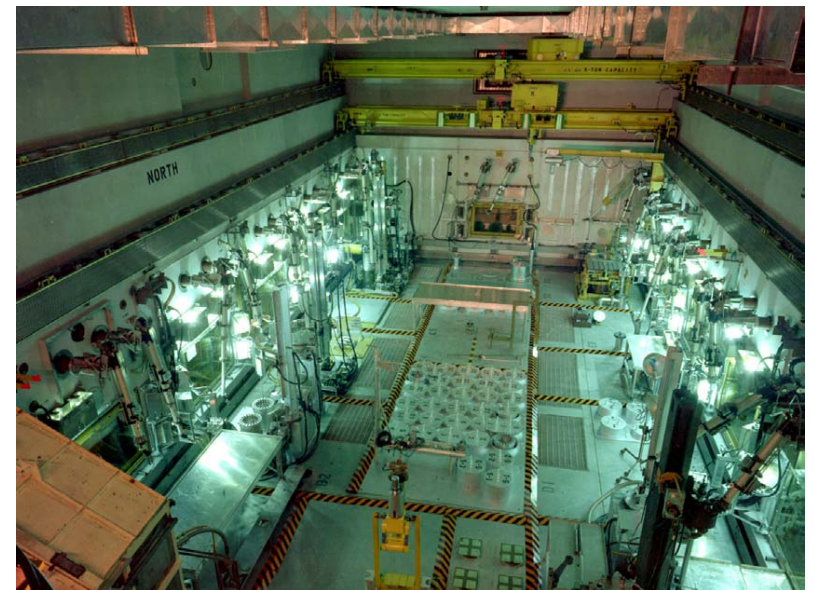



Demonstration Flight

- Assess the viability and desirability of an NCPS demo flight
- Assess potential data gathering and analysis techniques for both the operating and post-operational phases
- Assess impact of limits on information that could be obtained from a demo flight

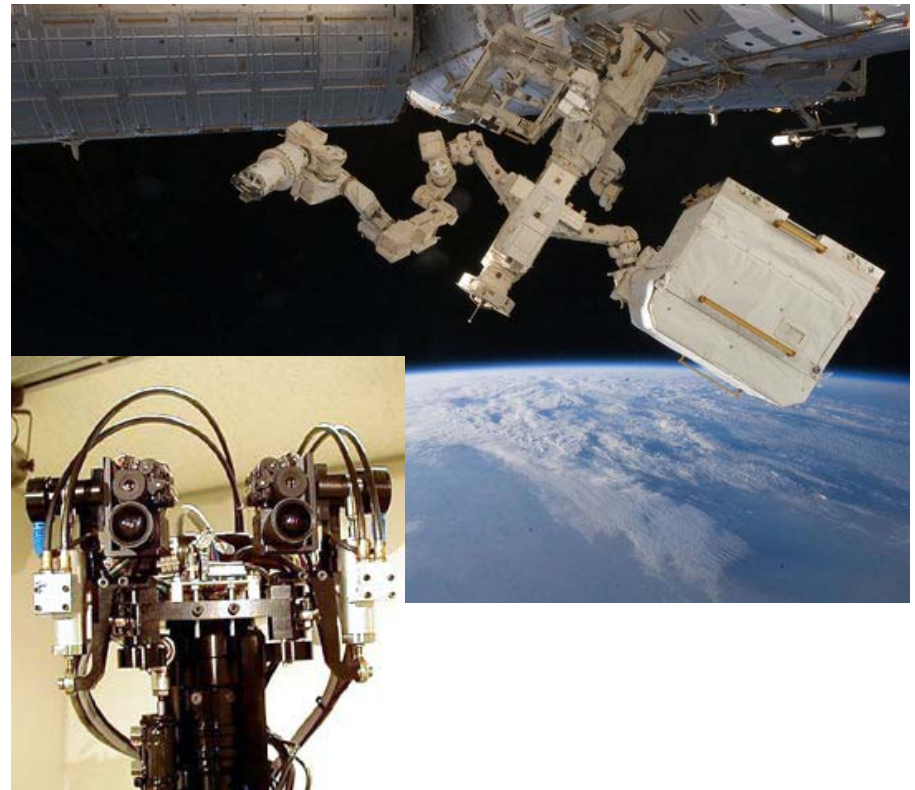
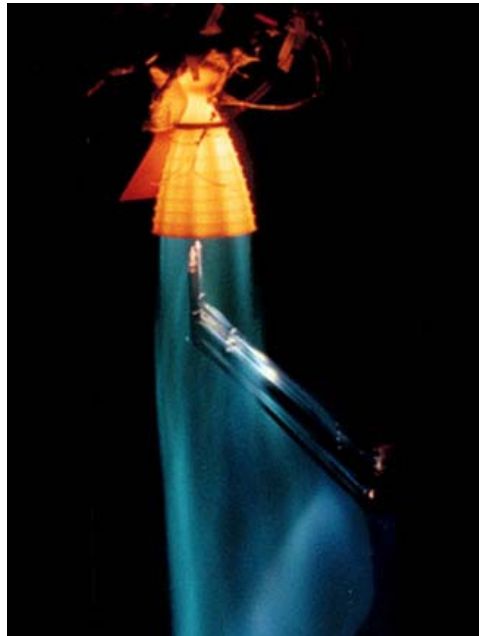



Proposed Types of Nuclear Thermal Propulsion

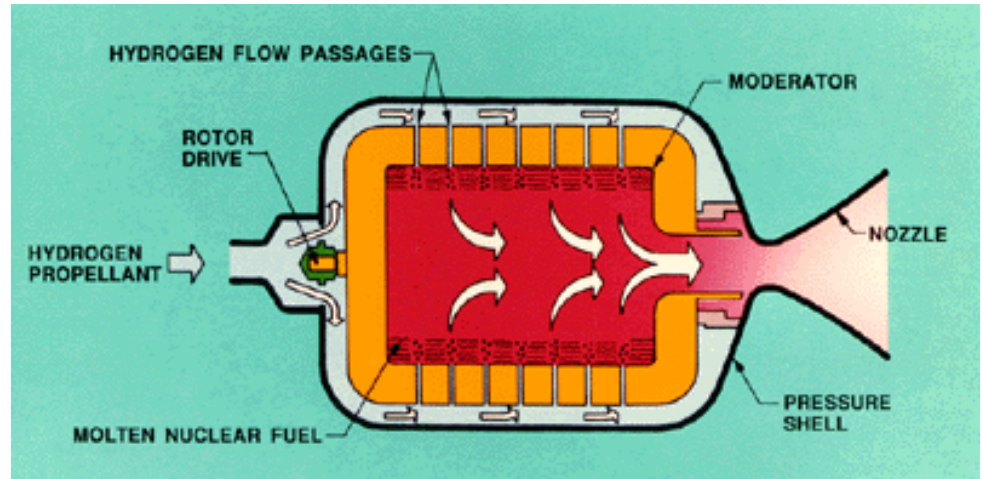
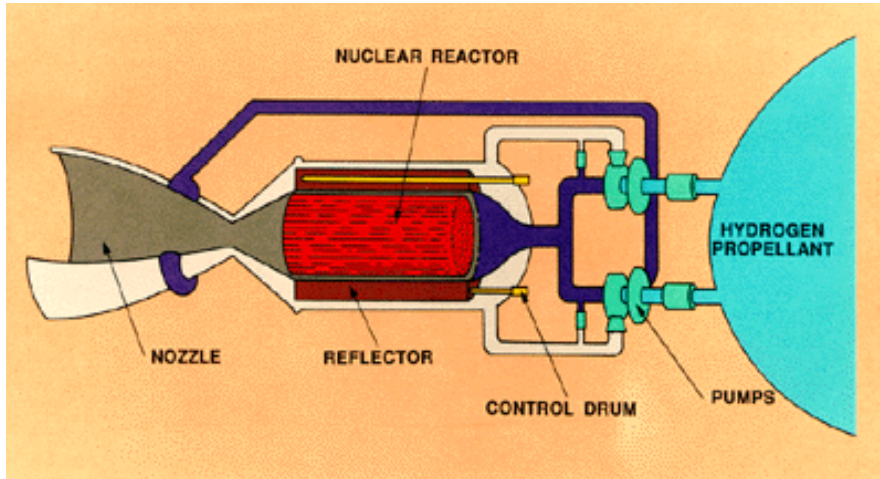

SOLID CORE NUCLEAR ROCKET

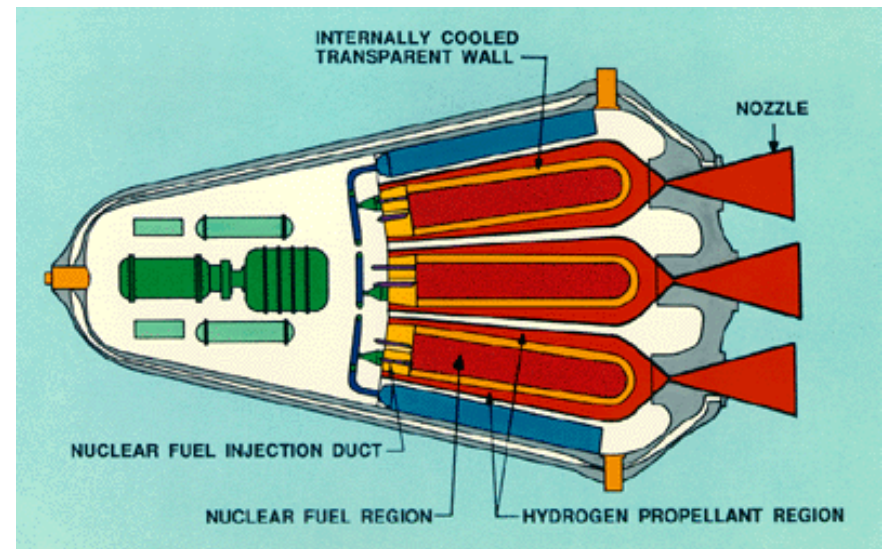
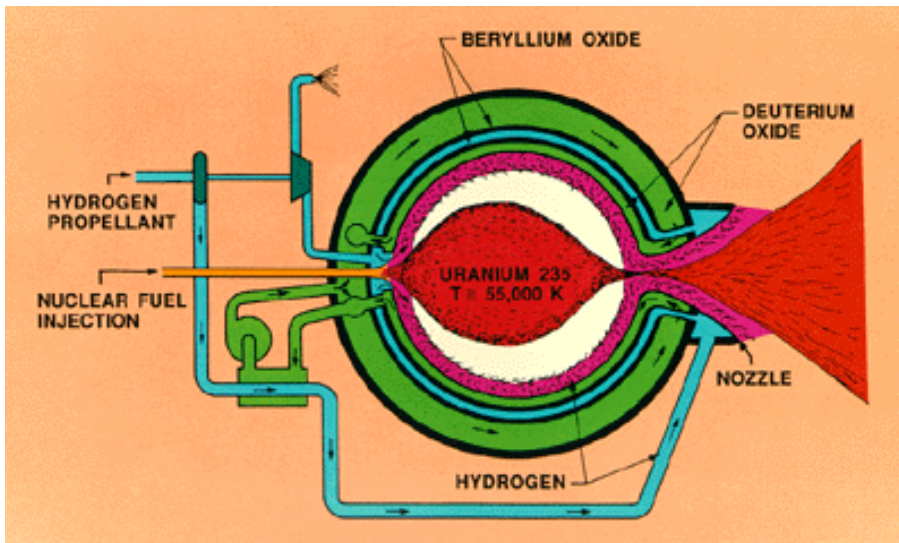



Future Plans / Path Forward

- Space nuclear power and propulsion are game changing technologies for space exploration
- The NASA NCPS project has 1 to 3 years to demonstrate the viability and affordability of a Nuclear Cryogenic Propulsion Stage
- Participation is encouraged. Please feel free to contact the NCPS project with interest or ideas (michael.houts@nasa.gov)