

NASA/CP-2012-217355

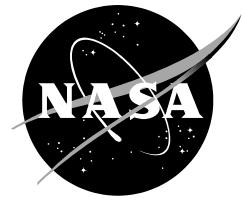

# **Antarctic Exploration Parallels for Future Human Planetary Exploration: The Role and Utility of Long Range, Long Duration Traverses**

*Stephen J. Hoffman, Ph.D., chair, editor*  
*Science Applications International Corporation, Houston, Texas*  
*Johnson Space Center, Houston, Texas*

*Stephen A. Voels, Ph.D., editor*  
*Science Applications International Corporation, Houston, Texas*  
*Johnson Space Center, Houston, Texas*

Prepared for  
Antarctic Exploration Parallels for Future Human Planetary Exploration Workshop  
Sponsored by NASA's Constellation Program  
Houston, Texas, August 4-5, 2009

National Aeronautics and  
Space Administration

*Johnson Space Center*  
*Houston, Texas 77058*

---

January 2012

## NASA STI Program ... in Profile

Since its founding, NASA has been dedicated to the advancement of aeronautics and space science. The NASA scientific and technical information (STI) program plays a key part in helping NASA maintain this important role.

The NASA STI program operates under the auspices of the Agency Chief Information Officer. It collects, organizes, provides for archiving, and disseminates NASA's STI. The NASA STI program provides access to the NASA Aeronautics and Space Database and its public interface, the NASA Technical Report Server, thus providing one of the largest collections of aeronautical and space science STI in the world. Results are published in both non-NASA channels and by NASA in the NASA STI Report Series, which includes the following report types:

- **TECHNICAL PUBLICATION.** Reports of completed research or a major significant phase of research that present the results of NASA Programs and include extensive data or theoretical analysis. Includes compilations of significant scientific and technical data and information deemed to be of continuing reference value. NASA counterpart of peer-reviewed formal professional papers but has less stringent limitations on manuscript length and extent of graphic presentations.
- **TECHNICAL MEMORANDUM.** Scientific and technical findings that are preliminary or of specialized interest, e.g., quick release reports, working papers, and bibliographies that contain minimal annotation. Does not contain extensive analysis.
- **CONTRACTOR REPORT.** Scientific and technical findings by NASA-sponsored contractors and grantees.

- **CONFERENCE PUBLICATION.** Collected papers from scientific and technical conferences, symposia, seminars, or other meetings sponsored or co-sponsored by NASA.
- **SPECIAL PUBLICATION.** Scientific, technical, or historical information from NASA programs, projects, and missions, often concerned with subjects having substantial public interest.
- **TECHNICAL TRANSLATION.** English-language translations of foreign scientific and technical material pertinent to NASA's mission.

Specialized services also include organizing and publishing research results, distributing specialized research announcements and feeds, providing help desk and personal search support, and enabling data exchange services.

For more information about the NASA STI program, see the following:

- Access the NASA STI program home page at <http://www.sti.nasa.gov>
- E-mail your question via the Internet to [help@sti.nasa.gov](mailto:help@sti.nasa.gov)
- Fax your question to the NASA STI Help Desk at 443-757-5803
- Phone the NASA STI Help Desk at 443-757-5802
- Write to:  
NASA STI Help Desk  
NASA Center for AeroSpace Information  
7115 Standard Drive  
Hanover, MD 21076-1320

NASA/CP-2012-217355

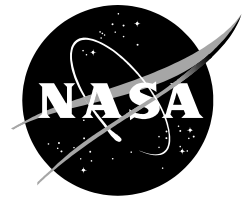

# **Antarctic Exploration Parallels for Future Human Planetary Exploration: The Role and Utility of Long Range, Long Duration Traverses**

*Stephen J. Hoffman, Ph.D., chair, editor*  
*Science Applications International Corporation, Houston, Texas*  
*Johnson Space Center, Houston, Texas*

*Stephen A. Voels, Ph.D., editor*  
*Science Applications International Corporation, Houston, Texas*  
*Johnson Space Center, Houston, Texas*

Prepared for  
Antarctic Exploration Parallels for Future Human Planetary Exploration Workshop  
Sponsored by NASA's Constellation Program  
Houston, Texas, August 4-5, 2009

National Aeronautics and  
Space Administration

*Johnson Space Center*  
*Houston, Texas 77058*

---

January 2012

## **Acknowledgments**

The editors would like to thank all of the invited speakers for taking the time and effort to put together very informative presentations to address the overall objective of this workshop.

The editors would also like to acknowledge Dr. Wendell Mendell, Chief Scientist of the Constellation Program, for making the resources available to bring these invited speakers together at the Johnson Space Center.

Finally, the editors would like to thank the USRA Lunar and Planetary Institute for hosting this workshop in their facility and, in particular, Ms. Elizabeth Wagganer for making all of the necessary arrangements to support the invited speakers and the workshop participants throughout this meeting.

Available from:

NASA Center for AeroSpace Information  
7115 Standard Drive  
Hanover, MD 21076-1320  
301-621-0390

National Technical Information Service  
5285 Port Royal Road  
Springfield, VA 22161  
703-605-6000

This report is also available in electronic form at <http://ston.jsc.nasa.gov/collections/TRS/>

## FOREWORD

“An endless procession passes before us of struggling figures, some erect and powerful, others weak, bent and dying of hunger, cold or scurvy, but all gazing forward to where their goal might be found. What were these men seeking? They were setting out to explore the unknown ... In every part of the world in every age this quest for knowledge has driven man forward. And so long as the human ear can listen for the breaking of waves on an unknown shore, so long as the human eye can try to follow the Northern Lights, and so long as human thought reach out toward distant worlds in space, so long will fascination of the unknown carry man forward. When man loses this thirst for knowledge he will no longer be man.”

— *Fridtjof Nansen, 1861-1930, Norwegian arctic explorer, Nobel Peace Prize (1922), statesman, scientist, and humanitarian. Quotation from In Northern Mists, London: Wm Heinemann, 1911, p6.*

# TABLE OF CONTENTS

FOREWORD .....	i
TABLE OF CONTENTS .....	ii
LIST OF FIGURES .....	iv
LIST OF TABLES .....	v
ACRONYMS AND ABBREVIATIONS .....	vi
ABSTRACT.....	viii
1 INTRODUCTION .....	1
1.1 Workshop Motivation .....	1
1.2 Workshop Structure .....	3
1.3 Report Outline.....	4
2 PROJECTED PLANETARY SURFACE TRAVERSE SYNOPSES .....	5
2.1 Overview.....	5
2.2 Mars Surface Traverse Options.....	6
2.2.1 The “Mobile Home” Concept of Operations .....	7
2.2.2 The “Commuter” Concept of Operations.....	8
2.2.3 The “Telecommuter” Concept of Operations .....	9
2.2.4 Science Community Inputs .....	9
2.2.5 The “Sortie” Concept of Operations .....	10
2.3 Summary and Implications .....	11
3 INVITED PARTICIPANTS .....	12
3.1 Mary Albert.....	12
3.2 Charles Bentley .....	13
3.3 Johan Berte.....	14
3.4 Richard Cameron .....	15
3.5 John Gruener .....	16
3.6 Friedrich Horz.....	17
3.7 Gary Lofgren.....	18
3.8 Charles Swithinbank .....	19
3.9 Marie-Claude Williamson.....	20
4 SELECTED ARCTIC AND ANTARCTIC TRAVERSE SYNOPSES .....	21
4.1 Norwegian-British-Swedish Antarctic Expedition of 1949-52.....	21
4.2 International Geophysical Year Traverses (1956 – 1958) .....	23
4.3 South Pole Queen Maud Land Traverses.....	25
4.4 Contemporary Arctic “Fly Camps”.....	26
4.5 Norwegian-American Scientific Traverse of East Antarctica.....	29

4.6	Belgian Princess Elisabeth Station and Support Traverses .....	31
4.7	Summary of Selected Traverse Vehicles, Ranges, and Cargo Capability .....	33
5	WORKSHOP ACTIVITIES AND OBSERVATIONS .....	41
5.1	Day One – Invited Presentations.....	41
5.2	Day Two – Facility Tours and Focused Discussion Groups.....	42
5.2.1	Tour of the Outdoor Mobility Test Facility .....	43
5.2.2	Tour of the Small Pressurized Rover Development Facility.....	44
5.2.3	Tour of the Advanced Space Suit Development Laboratory .....	46
5.2.4	Tour of the Surface Habitation Development Facility .....	48
5.2.5	Focused Discussion Groups .....	50
5.3	Observations and Comments from Workshop Participants .....	51
6	CONCLUSIONS AND RECOMMENDATIONS .....	53
7	REFERENCES .....	55
8	ADDITIONAL RESOURCES.....	56
A	APPENDIX A: PRESENTATIONS .....	57
A1	Presentation of Stephen J. Hoffman .....	58
A2	Presentation of Charles Swithinbank.....	72
A3	Presentation of Charles R. Bentley.....	98
A4	Presentation of Richard L. Cameron .....	123
A5	Presentation of Gary Lofgren .....	153
A6	Presentation of Friedrich Horz.....	161
A7	Presentation of Marie-Claude Williamson .....	173
A8	Presentation of Mary R. Albert.....	204
A9	Presentation of John E. Gruener .....	229
A10	Presentation of Johan Berte .....	238
B	APPENDIX B: VEHICLES.....	293
C	APPENDIX C: LIST OF PARTICIPANTS .....	299

## LIST OF FIGURES

Figure 1.1: Antarctic Expeditions and Traverses of the Invited Speakers .....	2
Figure 2.1: Notional Mars Traverses .....	6
Figure 2.2: Notional Large Pressurized Rover for Mars.....	7
Figure 2.3: Notional Mars Surface Systems for “Commuter” Option .....	8
Figure 2.4: Notional Teleoperated Rovers on Mars.....	9
Figure 2.5: Notional Mars Surface Exploration Timeline .....	10
Figure 4.1: Seismic Traverse During the NBSX Expedition .....	21
Figure 4.2: Traverses of the NBSX Expedition .....	22
Figure 4.3: Traverses during the IGY .....	24
Figure 4.4: Tucker Sno-Cat Model 743 AN .....	25
Figure 4.5: Tucker Sno-Cat Model 843 .....	26
Figure 4.6: Canadian Forces DC-3 .....	26
Figure 4.7: Canadian Forces Sikorsky S-55.....	27
Figure 4.8: Twin Otter Aircraft.....	28
Figure 4.9: Helicopter at Flycamp .....	28
Figure 4.10: Vehicle Configurations for NASTEА .....	29
Figure 4.11: Traverse Route for NASTEА .....	30
Figure 4.12: Princess Elisabeth Station.....	31
Figure 4.13: Unloading for PES at Breid Bay .....	33
Figure 4.14: Antarctic Traverse Vehicles .....	34
Figure 4.15: Antarctic Expeditions and Traverses of the Invited Speakers .....	35
Figure 5.1: Conference Speakers .....	41
Figure 5.2: Hill at JSC Rock Yard .....	43
Figure 5.3: Crater at JSC Rock Yard .....	44
Figure 5.4: Lunar Electric Rover (exterior) .....	45
Figure 5.5: Lunar Electric Rover (interior).....	45
Figure 5.6: EVA Glove Demonstration Facility .....	46
Figure 5.7: Manipulating Common Objects using EVA Gloves .....	47
Figure 5.8: Mark III EVA Suit Entry Hatch .....	47
Figure 5.9: Mark III EVA Suit Upper Torso and Helmet .....	48
Figure 5.10: Small Habitat Mock-ups.....	49
Figure 5.11: Large Habitat Mock-ups.....	49



## **LIST OF TABLES**

Table 4.1: Key Characteristics for Each of the Antarctic Traverses Discussed at this Workshop .....	36
Table 5.1: List of Discussion Participants .....	50

## ACRONYMS AND ABBREVIATIONS

ACE	Army Corps of Engineers
ARC	Ames Research Center
ALSEP	Apollo Lunar Surface Experiment Package
ANSMET	Antarctic Search for METeorites
ASCE	American Society of Civil Engineers
ASTER	Advanced Spaceborne Thermal Emission and Reflection Radiometer
ATV	All Terrain Vehicle
BELARE	BELgian Antarctic Research Expedition
Belspo	Belgian Science Policy Office
BPLF	Black Point Lava Flow
BR	Backroom
CapCom	Capsule Communications/Communicator
CARN	Canadian Analog Research Network
CAPTEM	Curation and Analysis Planning Team for Extraterrestrial Materials
CEE	Comprehensive Environmental Evaluation
CESAR	Canadian Expedition to Study the Alpha Ridge
CFD	Computational Fluid Dynamic
CLEAR	Canadian Lunar Experiments and Analogue Reference
CoI	Co-Investigator
CPGG	Canadian Planetary Geology and Geophysics [Working Group]
CRREL	Cold Regions Research and Engineering Laboratory
CSA	Canadian Space Agency
DIO	Directorate Integration Office
DRATS	Desert Research and Technology Studies
ESAS	Exploration Systems Architecture Study
EVA	Extravehicular Activity
FGPI	Field Geology Principal Investigator
GEBCO	General Bathymetric Chart of the Oceans
GPR	Ground Penetrating Radar
GPS	Global Positioning Satellite [System]
GSC	Geological Survey of Canada
IGY	International Geophysical Year
IPF	International Polar Foundation
IPY	International Polar Year
ISRU	In Situ Resource Utilization
ISS	International Space Station
JATO	Jet Assisted Takeoff
JSC	Johnson Space Center
KSC	Kennedy Space Center
LAS	Little America Station
LASAT	Lunar Analogue Site Analysis Team
LER	Lunar Electric Rover
LOREX	Lomonosov Ridge Experiment
LRV	Lunar Rover Vehicle
LSS	Lunar Surface Systems
MAT	Mars Architecture Team
MEPAG	Mars Exploration Program Analysis Group

MMCC	Mobile Mission Control Center
MSL	Mars Science Laboratory
NAC	NASA Advisory Council
NAIS	National Atlas Information Services
NAS	National Academy of Science
NASA	National Aeronautics and Space Administration
NASTEAA	Norwegian-American Scientific Traverse of East Antarctica
NBSX	Norwegian- British- Swedish Expedition
NRC	National Resources Canada
NSF	National Science Foundation
NTDB	National Topographic Database
PCSP	Polar Continental Shelf Program/Project
PES	Princess Elisabeth Station
PI	Principal Investigator
PV	Photovoltaic
QMLT	Queen Maud Land Traverse
RATS	Research and Technology Studies
RR	Robotic Rover
SAR	Synthetic Aperture Radar
SATCOM	Satellite Communications
SCALOP	Standing Committee on Antarctic Logistics and Operations
SCADA	Supervisory Control And Data Acquisition
SCAR	Scientific Committee for Antarctic Research
SciCom	Science Communications/Communicator
SDT	Science Definition Team
SMU	Snow Melt Unit
SPR	Small Pressurized Rover
SPQMLT	South Pole-Queen Maud Land Traverse
SSR	Science Support Room
STS	Solar Thermal System
STS	Space Transportation System
TRIM	Terrain Resource Inventory Mapping
SWP	Science Working Panel
TRL	Technology Readiness Level
UAV	Unmanned Aerial Vehicle
UNCLOS	United Nations Convention on the Law of the Sea
USAP	United States Antarctic Program
USARP	United States Antarctic Research Program
USGS	United States Geological Survey
USNC	United States National Committee
VSE	Vision for Space Exploration
WSU	Water Storage Unit
WTU	Water Treatment Unit

## ABSTRACT

This report describes a recent (August 2009) 2-day workshop at the NASA Johnson Space Center discussing lessons learned from traverses, driven largely by science objectives, in the Earth's polar regions. These lessons are viewed as contributing one facet of NASA's preparation to explore, over extended periods of time, the surface of the Moon, Mars, and the inner solar system. More than 60 years of extensive traverses in both the Arctic and Antarctic provide a potentially rich source of lessons for future planetary missions under analogous conditions. Results from this and a previous workshop (Hoffman, 2002) examining the similarities of space and polar exploration both indicate highly parallel activities and functional needs. However, as Henry Kissinger has noted: "History is not, of course, a cookbook offering pretested recipes. It teaches by analogy, not by maxims." So it was also recognized during the course of discussions at the workshop reported here that NASA's current approach for long-duration planetary surface operations has fundamental differences from any of the operational approaches described by the invited speakers. Choices made regarding these approaches drive the crew size and skill mix, as well as the system capabilities, needed to accomplish basic mission objectives. These, in turn, drive the logistical pyramid needed to support operations. The key then is to learn the lessons from Arctic and Antarctic traverse and adapt them to future planetary missions. This workshop attempted to facilitate this learning process by arranging for a direct interaction between those who created the history of Arctic and Antarctic traverses with those who are tasked with creating the future history of these traverses on other planets.

This workshop report documents the presentations made at the workshop and discusses several of the key findings or lessons. The presentations – visual materials and associated transcripts – are contained in appendices to this report. These appendices are considered the principal knowledge captured during this workshop; the sections of this report that precede these appendices provide background and context for the appendices and capture a summary of the discussions by those attending the workshop.

Fifty people, including the invited speakers, attended the first day's presentations. These attendees represented six different NASA Centers and several contractors or universities. The presentations consisted of: (1) Dr. Charles Swithinbank (Scott Polar Research Institute) discussing observations from the Norwegian- British- Swedish Expedition (NBSX) of 1949-52 and the evolution that followed; (2) Dr. Charles Bentley (University of Wisconsin) discussing the first of two perspectives on the International Geophysical Year and the evolution that followed; (3) Dr. Richard Cameron discussing the second of two perspectives on the International Geophysical Year and the evolution that followed; (4) Dr. Friedrich Horz and Dr. Gary Lofgren (NASA Johnson Space Center) discussing the Apollo lunar traverses and the associated planning along with contemporary field tests of NASA equipment and procedures; (5) Dr. Marie-Claude Williamson (Canadian Space Agency) discussing contemporary science traverses in the Arctic; (6) Dr. Mary Albert (Dartmouth College) discussing contemporary science traverses in the Antarctic; (7) Mr. John Gruener (NASA Johnson Space Center) discussing NASA's plans for potential traverses on the lunar surface in the next era; and (8) Mr. Johan Berte (International Polar Foundation) providing an overview of the new Belgian Princess Elisabeth Antarctic research station and its development.

A general recommendation from this workshop is that interaction between these two exploration communities should continue with both informal and more formalized events. Those representing both sides of this interaction (i.e., the polar traverse community and the planetary surface traverse community) reached a general agreement that there were lessons to be learned by both sides, but there is more work yet to be done to communicate and determine how best to take advantage of these lessons. Other specific

recommendations stemming from these general recommendations and from discussions held by workshop participants include:

1. Annual or biannual workshops to review NASA analogs and National Science Foundation (NSF) polar activities (emphasis on activities of similar scope/scale); other agencies or organizations would be invited as appropriate. A workshop held in October or April would avoid overlap with the NSF Antarctic season and NASA analog season. Another option would be to coordinate this event with another major meeting typically attended by one or the other of these exploration communities (examples include the meeting of the Scientific Committee for Antarctic Research (SCAR) or the SCAR's Standing Committee on Antarctic Logistics and Operations (SCALOP) Symposium or the annual Earth and Space conference sponsored by the American Society of Civil Engineers (ASCE).
2. Personnel from large government agencies or other organizations, such as the NSF and NASA, involved in relevant field activities should invite appropriate counterparts to participate in these field activities where possible.
3. Detailed, independent assessments of the operational approaches used by the organizations represented in this workshop (and similar groups not represented) to understand differentiating factors. Results of these assessments should then be made available to those personnel responsible for developing planetary surface operational concepts so they can decide what features (if any) used by these other organizations should be incorporated into its current approach to planetary surface exploration.
4. Review historical and current data sets that can be mined for information regarding logistics, heated volume (as a surrogate for pressurized volume), functional space utilization, energy requirement, etc. that can be used to develop mathematical models for these aspects of a surface mission or traverse. These data could reside with both governmental and nongovernmental organizations, indicating that contacts should be developed with both organizational types.
5. Review data from "case studies" describing crew skill mix and leadership approach used in polar exploration. Examples of successful and unsuccessful approaches exist and should be part of this assessment. One primary feature of this assessment could be a set of criteria to be used to determine the appropriate crew mixture of "professional astronaut" and "professional research scientist", an approximate description of the major skill sets used in polar scientific exploration teams. Continuing this line of reasoning, these results could also be used to determine the skill/training requirements for these two broad categories of crew members as well as examining the functional requirement implications resulting from this approach to crew make up.
6. Finally, investigate the benefits of joint operations of pertinent surface exploration activities and advanced systems by large government agencies or other organizations, such as the NSF and NASA. Benefits of this strategy could be:
  - a. Higher Technology Readiness Level (TRL) technology test beds and higher fidelity analog tests for NASA
  - b. Access to more advanced technologies for "polar" exploration community
  - c. A joint contribution to advancing scientific knowledge and technology state of the art



**Workshop Speakers**

Front row (l to r): Dr. Friedrich Horz, Dr. Mary Albert, Dr. Marie-Claude Williamson, Dr. Richard Cameron. Back row (l to r): Dr. Stephen Hoffman (workshop convener and speaker), Mr. Johan Berte, Dr. Charles Swithinbank, Dr. Charles Bentley, Mr. John Gruener. Not pictured: Dr. Gary Lofgren.

# 1 INTRODUCTION

Extended surface traverses by human explorers on other planets has been an element of many of the planned and actual missions in this modern era of space exploration. Wernher von Braun, in his book *The Mars Project* (von Braun, 1962), envisioned his crew of human explorers landing on the (presumed) smooth, icy planes of the Mars polar regions and then traversing to the equatorial regions (a distance of some 7,000 kilometers [~4300 miles]) to set up their rockets for ascent back to their waiting Earth-return spacecraft. The details for von Braun's book were being prepared during the early 1950s, at a time when many nations were resuming their exploration of Antarctica after World War II. This included one group of Norwegian, British, and Swedish scientists who had just completed a 2-year expedition to this continent, a period of time roughly equivalent to the time spent on the surface of Mars in von Braun's notional mission.

Since this plan was put forward by von Braun, there have been several actual traverses on the surface of the Moon, totaling approximately 95 kilometers [~59 miles] by 12 individuals accumulated in six separate Apollo missions. There have also been numerous other plans of varying levels of detail for both shorter and longer traverses on the Moon and Mars.

NASA is now actively examining how surface traverses will contribute to its overall human spaceflight strategy, namely to "establish a program to develop a sustained human presence on the Moon, including a robust precursor program to promote exploration, science, commerce and U.S. preeminence in space, and as a stepping stone to future exploration of Mars and other destinations" (Congress of the United States, 2005). One feature that has become apparent in studies of these future lunar and Mars missions is that both crew and robotic equipment, which could arrive on different vehicles, will land in a fairly benign (i.e., relatively free of landing hazards and conducive to establishing necessary surface infrastructure) location to reduce the risk of this phase of the mission. But "benign" can also be synonymous with "uninteresting" from a scientific or exploration perspective, resulting in the crew exhausting the scientific potential of a particular site before returning to Earth. This is especially true for Mars mission crews that could spend as much as 18 months at a given location (Drake, 2009a). Providing a capability to move long distances across the surface removes the need to risk a landing at a more challenging, but interesting, surface location.

A reservoir of data and lessons learned regarding surface traverses in very challenging environments relevant to planetary exploration can be found within the community of Arctic and Antarctic explorers. For example, during the 60-year period between von Braun's plan to explore Mars and recent Congressional authorization of NASA's future direction for human spaceflight, over 130 separate scientific traverses were carried out in the Antarctic. These traverses accumulated tens of thousands of kilometers of travel distance by several hundred individuals (Anon., August 2004, p. 2-7 through 2-10). This total does not include numerous resupply traverses by the United States, the Soviet Union, and other countries that maintain inland stations on the Antarctic continent. Similarly, more than 50 years of logistical support by the Polar Continental Shelf Program (PCSP) have provided a unique legacy of knowledge and lessons learned regarding scientific field traverses and surveys to the Canadian community of polar scientists.

## 1.1 Workshop Motivation

This reservoir of data and lessons from polar exploration has long been recognized as highly relevant for future exploration of other planetary surfaces. In fact, there are many aerospace engineers and NASA astronauts with direct experience deploying to the Earth's Polar Regions, and who bring this experience with them to their current tasks. However, there has been relatively little effort to systematically bring

this reservoir of experience to bear in shaping how similar deployments, and traverses in particular, will be conducted by NASA and others spacefaring nations on the lunar and Martian surfaces. One effort to take advantage of this reservoir of experience for planning these future missions began with a 2001 workshop that took a broad look at the experiences of Antarctic exploration in the late 1940s though the International Geophysical Year (Hoffman, ed., 2002). This workshop took a broad look at the parallels between these two exploration communities due to the lack of specific definition for NASA's plans for planetary surface exploration by human crews.

Now with a specific set of objectives set for human spaceflight over the next several decades, and as more effort is put into translating these objectives into specific missions and hardware systems, it was recognized that this reservoir could help shape these planning activities by NASA. The result was a workshop convened at the NASA Johnson Space Center (JSC) in August 2009 to tap into this reservoir of experience and discuss lessons learned from traverses, driven largely by science objectives, in the Earth's Polar Regions. Six individuals, whose collective experience spans a variety of relevant polar exploration expeditions that relied on traverse capabilities to accomplish science objectives over the past 50 years, were invited to participate in this workshop. They are:

Dr. Mary Albert  
 Mr. Johan Berte  
 Dr. Charles Swithinbank

Dr. Charles Bentley  
 Dr. Richard Cameron  
 Dr. Marie-Claude Williamson

Figure 1.1 shows the Antarctic expeditions and traverses carried out by five of these six individuals (Dr. Williamson's experience is in the Arctic). This figure illustrates how the experience of the selected group of speakers covers a broad range of vehicle size, traverse range, duration, and operation approaches that encompass the type of surface exploration envisioned for future planetary missions.

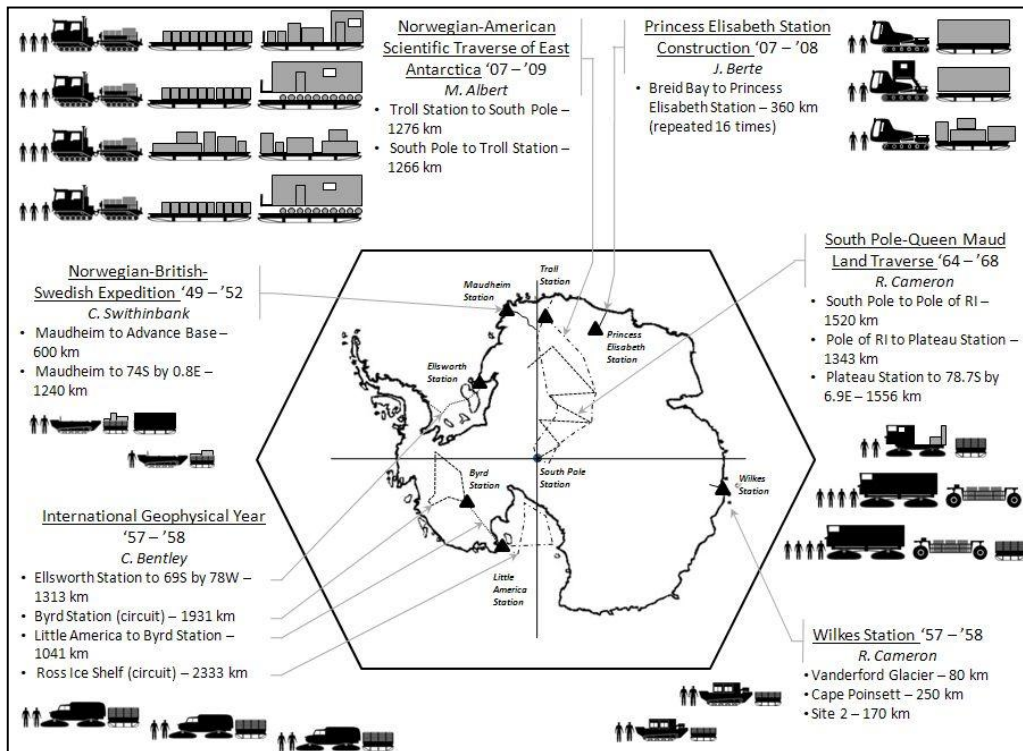

**Figure 1.1: Antarctic Expeditions and Traverses of the Invited Speakers**



In addition, four individuals were invited to present the current thinking for future planetary surface exploration missions. These individuals were:

Mr. John Gruener  
Dr. Friedrich Horz

Dr. Stephen Hoffman  
Dr. Gary Lofgren

Details regarding the personal background for each of these individuals and their relevant experiences will be presented in the following sections of this report.

## **1.2 Workshop Structure**

The workshop was divided into two parts covering 2 full days. On the first day, eight invited presentations were made to those attending. These presentations covered scientific traverses made in the Arctic and Antarctic, and on the lunar surface during the Apollo missions. In addition, planning for future planetary surface missions along with contemporary analog tests were described. The presentations, listed in the order in which they were presented, consisted of:

- (1) Dr. Stephen Hoffman (Science Applications International Corporation) discussing the objectives of the workshop and the current approaches being considered for exploration of Mars by human crews,
- (2) Dr. Charles Swithinbank (Scott Polar Research Institute) discussing observations from the Norwegian- British- Swedish Expedition (NBSX) of 1949-52 and the evolution that followed,
- (3) Dr. Charles Bentley (University of Wisconsin) discussing the first of two perspectives on the International Geophysical Year and the evolution that followed,
- (4) Dr. Richard Cameron discussing the second of two perspectives on the International Geophysical Year and the evolution that followed,
- (5) Dr. Friedrich Horz and Dr. Gary Lofgren (NASA JSC) discussing the Apollo lunar traverses and the associated planning along with contemporary field tests of NASA equipment and procedures,
- (6) Dr. Marie-Claude Williamson (Canadian Space Agency) discussing contemporary science traverses in the Arctic,
- (7) Dr. Mary Albert (Dartmouth College) discussing contemporary science traverses in the Antarctic,
- (8) Mr. John Gruener (NASA JSC) discussing NASA's plans for potential traverses on the lunar surface in the next era, and
- (9) Mr. Johan Berte (International Polar Foundation) providing an overview of the Belgian Princess Elisabeth Antarctica research station and its development.

The second day consisted of several smaller focus meetings with specialized groups (e.g., surface rovers, extravehicular activity [EVA] suits, habitats, traverse planning, etc.) to provide an opportunity for continued discussions based on the first day's presentations. The intent for these facility tours and discussions was to allow the invited participants not only to observe how NASA was preparing its systems for planetary explorations and traverses but also to interact directly with those developing these systems. The NASA developers and operators would also be afforded the opportunity to interact with the invited participants and discuss specific topics where exploration experience in the Arctic and Antarctic could provide guidance for future planetary missions. The invited speakers visited the following locales

at JSC and discussed topics associated with these specialized groups based on the previous day's presentations:

- (1) Outdoor mobility test facility (a.k.a. the "Rock Yard")
- (2) Small pressurized rover development area (Building 9)
- (3) Advanced Space Suit Development Laboratory (Building 34)
- (4) Surface Habitation development facility (Building 220)
- (5) Discussion of "strategic" and "tactical" science planning (Building 4S conference room)
- (6) Lunar Surface Systems Project Office (Building 1)
- (7) Discussion of potential coordination between polar exploration organizations and NASA human spaceflight organizations (Building 1)

Fifty people, including the invited speakers, attended the first day's presentations. These attendees represented six different NASA Centers and several contractors or universities. Many of these same personnel participated in the second day's discussions although in smaller groups. The invited speakers spent part of a third day discussing their impressions and recommendations with the workshop organizers.

### **1.3 Report Outline**

This report is divided into five main sections plus a number of appendices containing the presentations. The presentations – visual materials and associated transcripts – are considered the principal knowledge captured during this workshop; the sections of this report that precede these appendices provide background and context for the appendices and capture a summary of the discussions by those attending the workshop. First of these preceding sections is a description of the current thinking within the NASA human spaceflight community regarding planetary surface traverses. While this topic currently involves both lunar and Mars missions, it will be Mars missions that are described in some detail, given the workshop organizers' greater familiarity with Mars surface missions. The second and third sections offer a brief description of the background for each of the invited speakers followed by a brief synopsis of several of the Arctic and Antarctic stations and traverses described by the invited speakers. The fourth section is an expanded description of the surface traverse workshop held at JSC on August 4 - 6, 2009. The final section is a discussion of the observations and key lessons learned resulting from this workshop, along with plans for carrying this investigation forward into gathering more detailed data from traverses in the Earth's Polar Regions, along with the analyses that are planned for these data.

## 2 PROJECTED PLANETARY SURFACE TRAVERSE SYNOPSES

To provide context for the selected presentations and other activities making up this workshop, this section describes current thinking for exploration of planetary surfaces by human crews.

### 2.1 Overview

The exploration of the Moon and Mars by human crews has been an active area of (non-science fiction) discussion going all the way back to the mid-1950s. With the exception of the Apollo missions, this type of planetary exploration has not advanced much beyond the discussion and analysis phase. What is different about the current vision for human spaceflight compared to most of the past attempts at something similar is that these general objectives have been documented as public policy by the White House and codified into law by the U.S. Congress (for example: Anon., June 2004, and Congress of the United States, December 2005). The first step in this current process – retiring the Space Shuttle and building its replacement – is already well under way.

Another key difference in this current environment compared to years past, specifically the Apollo mission experience, is that future lunar and Mars surface missions are projected to last significantly longer – from about a week up to 18 months (for reference, the longest time spent on the lunar surface during a single Apollo mission was about 72 hours). The lunar missions in this new era are likely to start with about a 1-week duration and gradually grow to about 6 months between crew rotations at a single surface facility. Early lunar missions may visit several different surface sites at widely spaced locations, but the long-term goal is to build up a single, continuously occupied facility, much as the International Space Station (ISS) is continuously occupied now, with regularly scheduled crew rotations. Traverses of many 10's of kilometers away from the landing site are envisioned for each of these surface scenarios. Mars missions (i.e., the round-trip flight of a single crew of six people) on the other hand will last approximately 3 years in total duration, with about 18 months of that time spent on the surface of Mars. This is dictated by orbit mechanics and the current state of rocket propulsion technology. Orbit mechanics also dictate that these launch opportunities occur at intervals such that it will not be possible for one crew to overlap on the surface of Mars with the next crew; however, given that each crew will spend 18 months at a given site, current plans do not call for subsequent crews to return to the same location on the Martian surface, at least for the first several missions (Drake, 2009a).

Hardware elements needed for lunar and Mars exploration are early enough in their development cycles for similar functionality, and possibly common subsystems, to be incorporated into designs for both of these missions. There is also a reasonable rationale to sending human crews to the Moon before going on to Mars. This is driven in large part to building confidence in operations and equipment in smaller steps of shorter lunar missions before taking very large steps of a nominal Mars mission. Opportunities to launch crews to the Moon occur approximately once per month while opportunities to launch crews to Mars occurs approximately once every 26 months. Thus, if there are reasons to delay a lunar mission, then the Program suffers a delay lasting just a few months compared to a minimum 2-year delay for a missed Mars mission. Opportunities to return to Earth from the Moon are similarly more frequent. The specific interval is, again, orbit mechanics and propulsion system dependent but is no more than 1 month in duration. These factors allow equipment and operations to be tried on the Moon in a similar situation and environment but without the multi-year commitment should any aspect of the equipment or operations be flawed.

For both lunar and Mars missions, it is anticipated that both crew and robotic equipment, which could arrive on different vehicles, will land in a fairly benign location (i.e., relatively free of landing hazards and conducive to establishing necessary surface infrastructure). But “benign” can also be synonymous with “uninteresting” from a scientific or exploration perspective. Without the benefit of a capability to

explore the surface beyond their immediate locale, or to drill into the subsurface, the Program risks exhausting the scientific potential of a particular site before the crew returns to Earth. This is especially true for Mars mission crews who could spend up to 18 months at a given location. This is not to imply that missions cannot land at more interesting, but also more challenging, landing sites; Apollo missions evolved from the relatively benign Apollo 11 site to the relatively challenging sites for Apollo's 15, 16, and 17. But providing a capability to move long distances across the surface removes the need to risk a landing at a more challenging surface location. Hence the interest within the human spaceflight community in a surface traverse capability.

## 2.2 Mars Surface Traverse Options

The following section has been extracted from NASA SP-2009-566, Human Exploration of Mars, Design Reference Architecture 5.0 Addendum (Drake, 2009b) that describes options for exploring the surface of Mars during the first three human missions to this planet.

Candidate surface sites on Mars will be selected based on the best possible data available at the time of the selection, the operational difficulties associated with the site, as well as the collective merit of the science and exploration questions that can be addressed at the site. Data available for site selection will include remotely gathered data sets plus data from any landed mission(s) in the vicinity plus interpretive analyses based on these data.

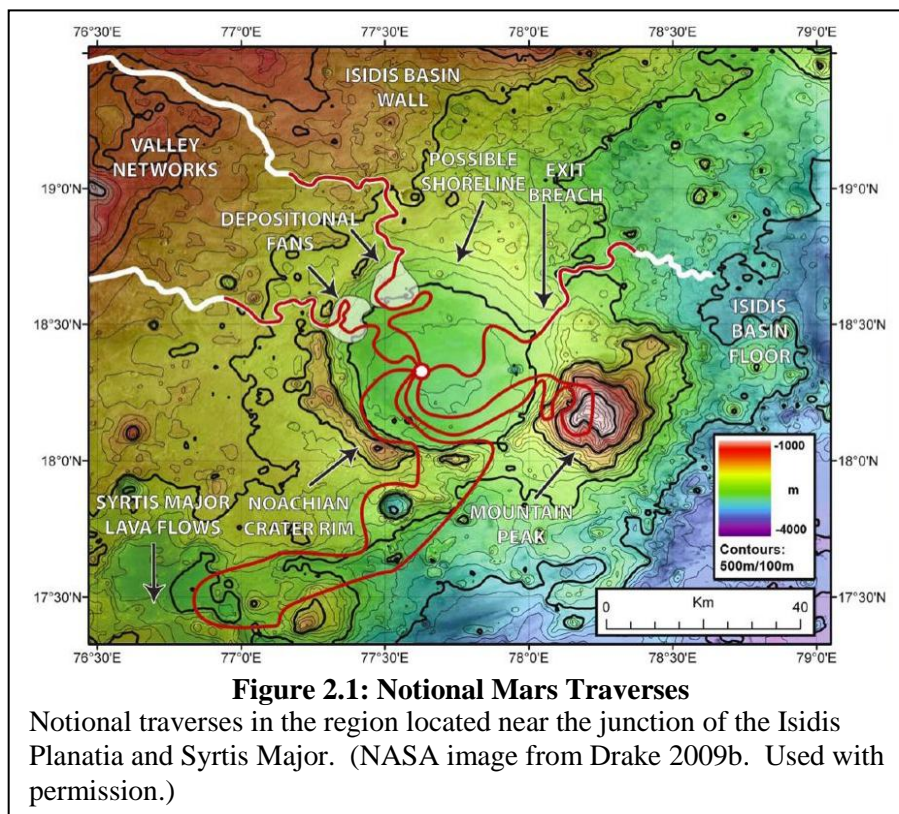

Figure 2.1 illustrates a notional series of traverses to features of interest at the junction of the Isidis Planitia and Syrtis Major regions on the surface of Mars. No particular preference is being given to this site; it is included here to illustrate some general features of a human exploration mission and the resulting implications for operations at such a site.

From an operational perspective, this location has a relatively broad, relatively flat, centrally located area where the cargo elements can land in relative safety. These cargo elements have no human crew on board, so

the landing site will be selected to be within the capability of robotic systems. However, this will likely place these systems and the crew at large distances from those features that are of interest to the crew and the science teams supporting from Earth. [The primary reference, NASA SP-2009-566, provides a detailed discussion of the mission strategy currently assumed for future human missions to Mars. However, pertinent to this discussion is the assumption that two large robotic cargo vehicles will be sent to Mars approximately 26 months before the crew arrives. One of these robotic cargo vehicles will land at the site chosen for the human crew (i.e., prepositioned) shortly after its arrival at Mars and will conduct

several important operational tasks prior to the crew’s arrival.] The scale at the lower right indicates that these features of interest are beyond what is currently considered a reasonable walking range for the crew (determined by the distance a crewperson can walk during one charge of power and breathing gases in their portable life support system – roughly 15 kilometers [~9 miles] total). Although sites with much closer features of interest are certainly possible, they are usually found at the expense of a relatively safe landing site. Thus, a nominal set of traverses for any of the first three human Mars missions are likely to be on the order of 100 kilometers (~62 miles) radial distance from the landing site, and based on several notional sites, including the one shown in Figure 2.1, these traverses could be much longer than the simple 200-kilometer (124-mile) round trip.

Three possible approaches to satisfying a desired combination of horizontal and vertical exploration were created during this reference architecture assessment for Mars exploration missions. These three options, given the working titles of “mobile home,” “commuter,” and “telecommuter,” were constructed to focus on different approaches to accomplish these two exploration “directions” (horizontal and vertical). It is recognized that there are other combinations and permutations of these basic functions that could also satisfy these high-level goals, but given the time and resource constraints of this reference architecture assessment, only these three were examined. An overview of each will be discussed in the next several paragraphs.

### 2.2.1 The “Mobile Home” Concept of Operations

The “mobile home” surface mission scenario assumes that surface exploration by the crew will be primarily a mobile operation. Thus, this scenario assumes the use of two (for mutual support) large, capable, pressurized rovers for extended traverses, spending between 2 and 4 weeks away from the landing site (see Figure 2.2). These rovers will have space and resources allocated for onboard science experiments. The landing site is assumed to be the location for those infrastructure elements not needed for the extended traverses, such

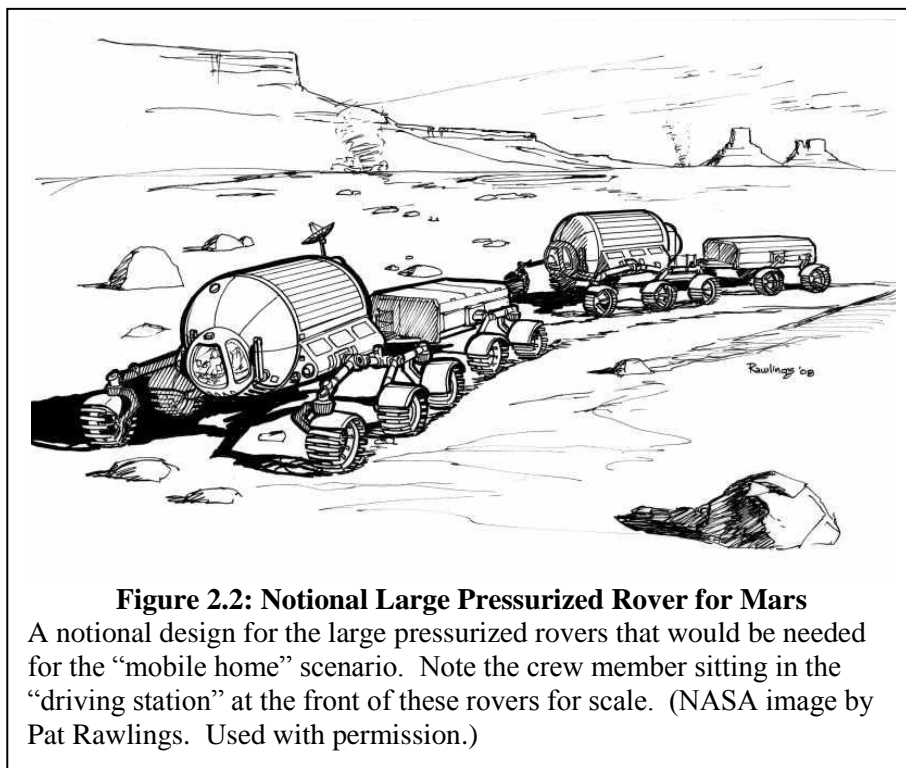

**Figure 2.2: Notional Large Pressurized Rover for Mars**  
A notional design for the large pressurized rovers that would be needed for the “mobile home” scenario. Note the crew member sitting in the “driving station” at the front of these rovers for scale. (NASA image by Pat Rawlings. Used with permission.)

as consumables, spare parts, and a large power plant. This infrastructure includes In Situ Resource Utilization (ISRU) systems, used primarily for ascent propulsion but which are also available (if this option is chosen) to make propellants for surface mobility systems. The processing capacity of this ISRU plant is to be decided and is dependent to a certain degree on the assumed implementation for the rover power source (assumed to be nuclear). The landing site will be the “pantry” for food and other basic maintenance and repair capabilities as well as storage for other consumables (e.g., propellant). As such, the landing site has minimal crew habitation capabilities. (However, in the course of 18 months, the crew will spend considerable periods here, so more than minimal habitation may be needed.) With this

division of functions among the surface systems, it is assumed that the crew will make a number of traverses away from the landing site but will return periodically to resupply and refit the rovers before deploying on the next traverse.

In addition to the internal science experiments mentioned above, the pressurized rovers will also bring along two small robotic rovers, two unpressurized (but small – comparable to the Apollo Lunar Rover Vehicle [LRV]) rovers to carry EVA crews, and a drill. The two robotic rovers can be teleoperated from the pressurized rover or can be given a set of instructions and allowed to carry out these instructions in an automated fashion. The unpressurized rovers will allow the EVA crews to move relatively quickly between sites within walk-back range of the pressurized rovers once the latter have stopped for extended operation at a given location (it is assumed that the large pressurized rovers will not be very nimble and thus will serve as a local “base camp” from which local traverses will be staged).

### 2.2.2 The “Commuter” Concept of Operations

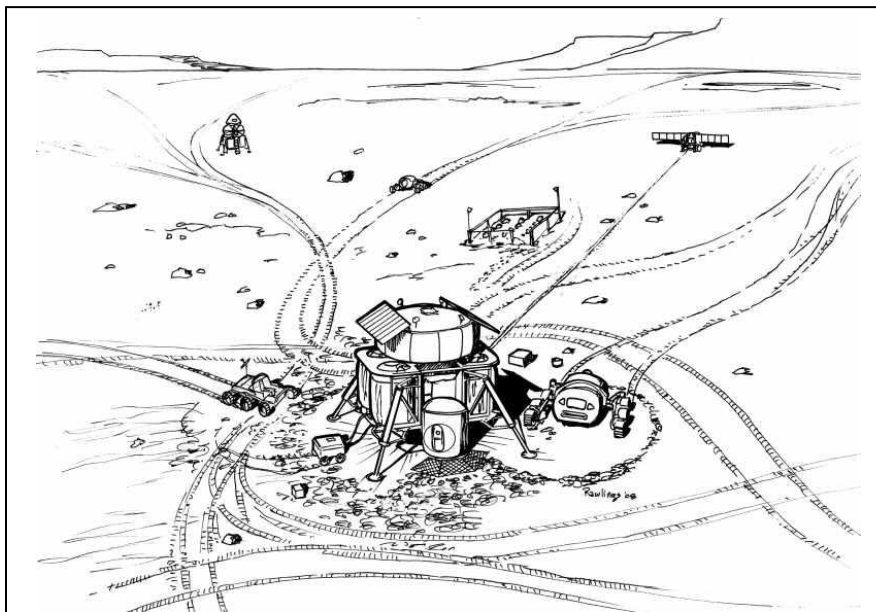

**Figure 2.3: Notional Mars Surface Systems for “Commuter” Option**

Notional view of the surface systems used in the “commuter” option for Mars surface exploration. (NASA image by Pat Rawlings. Used with permission.)

The “commuter” surface mission scenario (see Figure 2.3) assumed a centrally located, monolithic habitat, two small pressurized rovers, and two unpressurized rovers (roughly equivalent to the Apollo LRV). Power for these systems will be supplied by a nuclear power plant deployed with the cargo elements and used to provide power to an ISRU plant that in turn makes a portion of the ascent propellant. Although traverses will be a significant feature of the exploration strategy used in this scenario, these traverses will be constrained by the capability of the small pressurized rover. In this scenario, these rovers have been assumed to have a

modest capability, notionally a crew of two, 100 kilometers (~62 miles) total distance before being resupplied, and no more than 1-week duration before resupply. Thus, onboard habitation capabilities will be minimal in these rovers. However, these rovers are assumed to be nimble enough to place the crew in close proximity to features of interest (i.e., close enough to view from inside the rover or within easy EVA walking distance of the rover). Not all crew will deploy on a traverse, so there will always be some portion of the crew in residence at the primary habitat, permanently located at the landing site.

The primary habitat will have space and resources allocated for onboard science experiments. The pressurized rovers will carry only minimal scientific equipment deemed essential for field work; samples will be returned to the primary habitat and its onboard laboratory for any extensive analysis.

### 2.2.3 The “Telecommuter” Concept of Operations

In this last case, the “telecommuter” scenario, it is assumed that the crew will be based in a centrally located, monolithic habitat and only unpressurized (lunar rover equivalents) rovers will be used for local, short-duration EVAs. This implies traverses by the crew of no more than walk-back distances (approximately 15 kilometers [~9 miles] radial distance). The long range traverses will be handled by very capable robotic rovers (notionally a considerably improved Mars Science Laboratory [MSL] rover) teleoperated (or possibly supervised) by the surface crew from their habitat (see Figure 2.4). Because of the assumed prepositioning of surface cargo, there is an opportunity to deploy these rovers independently from the large surface habitat (but during the same atmospheric entry event) to sites that are distant from the habitat landing site. In this situation, there will be up to 2 years available for these rovers to carry out long-distance traverses, guided from Earth-based operators, with an ultimate destination of the habitat landing site. After the crew arrives at the habitat, these robotic rovers can be deployed on other traverses under the guidance of the surface crew.

### 2.2.4 Science Community Inputs

A group of scientists familiar with the goals and objectives likely to be established for future human missions to the Moon and Mars was assembled by the Mars Exploration Program Analysis Group (a standing NASA working group often asked to address these types of

questions). This group, named the Human Exploration of Mars Science Analysis Group, considered these three approaches and indicated a preference for the “commuter” option, although none of the approaches could be completely ruled out.

One approach to accomplishing the desired long traverses under this “commuter” scenario will be to use the pressurized rovers (or possibly robotic rovers) to preposition supplies in caches along the proposed route of travel prior to the “full duration” traverse. Thus, a typical traverse will begin with the crew (or robotic rovers) traveling out a nominal distance (approximately 15 kilometers [~9 miles], or EVA walk-back distance) and establishing a cache of commodities for life support and power (possibly emergency habitation) before returning to the habitat. Some amount of exploration-related activities may be accomplished during this cache deployment phase, but the primary purpose is route reconnaissance and

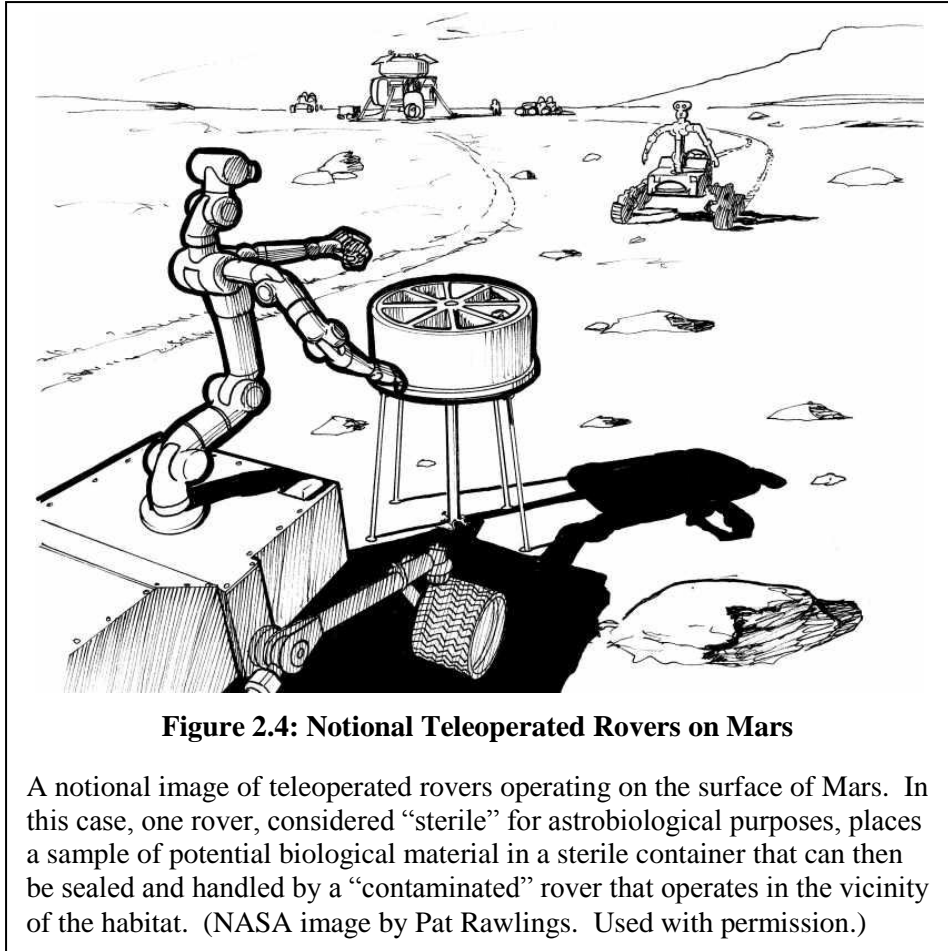

cache establishment. The crew then makes another traverse, establishing a second cache a like distance beyond the first cache. This process continues until all caches in this chain are built up sufficiently for the crew in the two pressurized rovers to make the entire round trip traverse for the time duration needed to accomplish traverse objectives. The amount of time required to set up and retrieve these supply caches will depend on the specific conditions for a traverse. However, the timeline in Figure 2.5 illustrates how much can be accomplished if approximately 2 weeks are allocated for establishing this string of caches and another 2 weeks to retrieve them. In addition, not all traverses will be long enough to require this type of support. A mixture of cache-supported and unsupported traverses has been illustrated. Finally, some amount of time will be required to repair and restock the pressurized rovers after each traverse as well as conduct any local experiments and plan for the next traverse. A notional 2 weeks between short traverses and 4 weeks between long traverses has been illustrated in Figure 2.5.

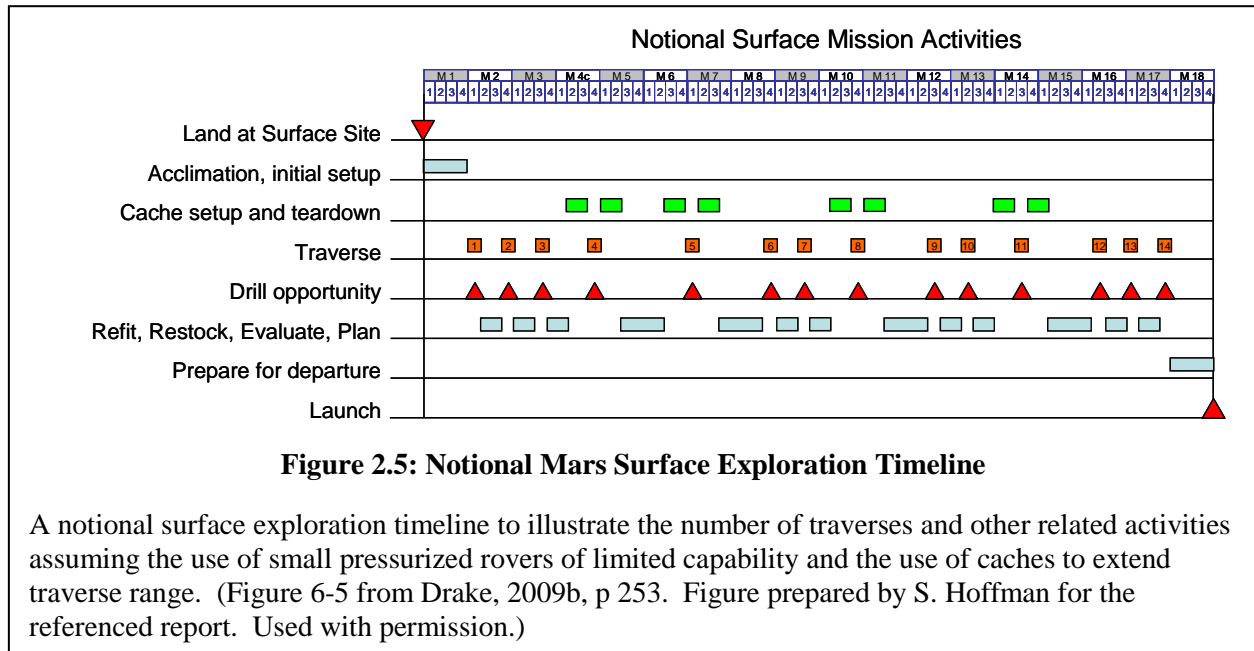

[A variation on this approach was discussed during the workshop, namely to deploy the “cache of commodities” from orbit along the selected route of travel, using small robotic landers. This approach is technically feasible and has the advantage of reducing the size (and mass) of the large robotic cargo landers described in the NASA reference mission – currently an area of some concern. This approach has the disadvantages of additional landing events, any of which have the potential to fail, and the added complexity of waiting for the orbiting “supply depot” to fly over the selected traverse route. A more detailed trade study is required to determine whether either of these approaches has a significant advantage over the other.]

### 2.2.5 The “Sortie” Concept of Operations

Any of the previous three examples of operational concepts for surface exploration could be applied to either the Moon or Mars. There is one additional concept of operations that is likely to be applied exclusively to the Moon – that of a limited duration (several days to several weeks, but probably not extending into the lunar “night”) deployment to a specific site where mission objectives can be accomplished in this limited amount of time and thus having a low probability of a return visit. For this type of mission, the amount of equipment delivered is also likely to be proportionately small (compared to the missions described above) and thus the traverse range is likely to be limited to that which can be accomplished in single day increments. Small pressurized rovers are also a possibility, in which these rovers double as the crew’s habitation space for the duration of the mission, making multiple day traverses possible.



### **2.3 Summary and Implications**

This section has described several approaches under consideration for exploring the surface of other planets. But these approaches are hypothesized; no experience yet exists for extended surface exploration of these other bodies. So experience from other sources that are as close as possible can provide an additional means (i.e., in addition to the preferences of the science community discussed above) of deciding where to focus development efforts leading to these actual missions. Polar exploration on Earth has a long history using approaches functionally equivalent to the “mobile home,” “commuter,” and “sortie” options described in this section. This history extends back to very early exploration in both the Arctic and Antarctic. Despite advances in technology over the years, these approaches are still in use. In the post-World War II era of exploration, aircraft of various payload capacities have become the transportation means of choice for “sortie” type exploration in both Polar Regions. In the Antarctic, many countries use surface ships as the most economical means of bringing large quantities of food, fuel, and other supplies to a permanent outpost, typically located on or near the coast. These outposts are then used as a hub to support other “forward” outposts or for staging long exploratory/scientific traverses. The latter could be of a size or distance that does not require further support after departing the outpost (i.e., of the “mobile home” type). Or these could be of a type requiring periodic resupply using cached supplies along the traverse route or could be resupplied by other means (e.g., air drop of supplies). The invited speakers for this workshop were selected to cover this range of exploration approaches, described in more detail in the following sections.

### 3 INVITED PARTICIPANTS

The following sections provide a brief description of each invited participant's background and rationale for their attendance at this workshop.

#### 3.1 Mary Albert



Dr. Mary R. Albert is currently a professor of engineering at the Thayer School of Engineering at Dartmouth College, where she serves as thesis advisor to students at undergraduate, Master's, and Ph.D. levels.

Dr. Albert was the U.S. Lead Principal Investigator for the Norwegian-American Scientific Traverse of East Antarctica Program. The field expedition for this international partnership involved scientific investigations along two overland traverses in East Antarctica: one going from the Norwegian Troll Station to the United States South Pole Station in 2007-2008; and a return traverse by a different route in 2008-2009. She was Chair of the U.S. Committee to the International Polar Year (IPY; 2007-2008), a committee of the Polar Research Board of the National Academy of Science, from its inception in 2003 until June 2005. She has spent many field seasons in Greenland and

Antarctica investigating the physical properties of snow (microstructure and permeability) and their effects on air-snow transport processes.

Dr. Albert received a B.S. in mathematics from Penn State in 1975, a B.E. and an M.S. in engineering sciences from Dartmouth College in 1983, and a Ph.D. in applied mechanics (computational fluid dynamics) from University of California San Diego in 1993. Before becoming a professor at Dartmouth College, she was a scientist in the Geophysical Sciences Division at the U.S. Army Corps of Engineer's Cold Regions Research and Engineering Lab (CRREL).

Dr. Albert's current research is centered on transfer processes in porous media, including air-snow exchange in the Polar Regions and in soils in temperate areas. Her research includes field measurements, laboratory experiments, and theoretical modeling. Mary conducts field and laboratory measurements of the physical properties of natural terrain surfaces, including permeability, microstructure, and thermal conductivity. Mary uses the measurements to examine the processes of diffusion and advection of heat, mass, and chemical transport through snow and other porous media. She has developed numerical models for investigation of a variety of problems, from interstitial transport to freezing of flowing liquids. These models include a two-dimensional finite element code for air flow with heat, water vapor, and chemical transport in porous media, several multidimensional codes for diffusive transfer, as well as a computational fluid dynamics code for analysis of turbulent water flow in moving-boundary phase change problems.

### 3.2 Charles Bentley

Dr Charles Bentley is the A.P. Crary Professor Emeritus of Geophysics, Department of Geology and Geophysics, University of Wisconsin-Madison.

Dr. Bentley joined the Arctic Institute of North America in 1956 to participate in International Geophysical Year (IGY)-related activities in the Antarctic. He wintered over consecutively in 1957 and 1958 at Byrd Station, a station in the interior of West Antarctica that housed 24 men each winter – 12 Navy support people and 12 civilian scientists/technicians. During the austral summers, he also participated in over-snow traverses, first as co-leader, then leader (the other co-leader went home after the first year). These traverses consisted of six men and three vehicles, and lasted several months. These traverses covered more than 1609 kilometers (1000 miles) of largely unmapped and unphotographed terrain. During these traverses, connections to Byrd Station were by radio (daily, when the transmission conditions were good enough) and roughly every 2 weeks by resupply flight.

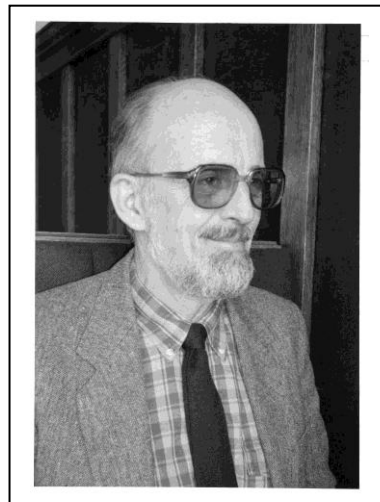

Dr. Bentley received a B.S. in physics from Yale University in 1950 and a Ph.D. in geophysics from Columbia University in 1959. During his career in the Department of Geology and Geophysics at the University of Wisconsin-Madison (1959 – 1987), he held academic positions ranging from Project Associate through Professor, and finally as A.P. Crary Professor of Geophysics. Among a variety of other activities, he has been a member of the Polar Research Board, National Research Council (NRC) (1978-1997, chairman 1981-1985), as well as a U.S. member (1981-1997) and vice president (1990-1994) of the Scientific Committee for Antarctic Research (SCAR), International Council of Science (ICS). Dr. Bentley has received many awards from American, British, and Russian organizations for his outstanding contribution to the glaciological and geophysical studies of the Polar Regions. Among these awards are the Goldthwait Medal from the Byrd Polar Research Center, the Ohio State University; the Seligman Crystal from the International Glaciological Society; and the Bellingshausen-Lazarev Medal from the Soviet Academy of Sciences.

### 3.3 Johan Berte

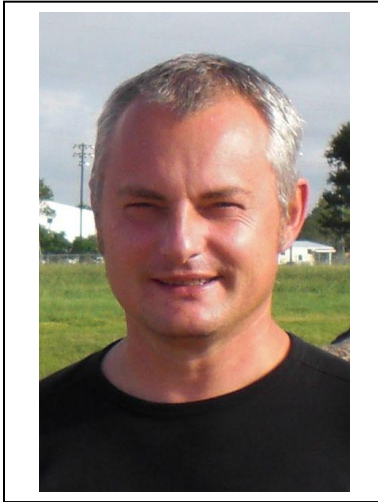

Mr. Johan Berte is an industrial designer based in Belgium. He is currently Project Manager for the International Polar Foundation (IPF; Brussels, Belgium) Princess Elisabeth Antarctic Station project. He leads the IPF design team and is responsible for coordination of station construction.

Aware of the increasing impact of human activities on the Earth system, Belgian Science Policy Office (Belspo) launched in 1997 a research programme in support of a sustainable development policy. This umbrella programme included the Belgian Scientific Programme on Antarctic Research. The International Polar Foundation, an organization led by the civil engineer and explorer Alain Hubert, was commissioned by the Belgian Federal government in 2004 to design, construct and operate a new Belgian Antarctic Research Station as an element under this umbrella programme. The station was to be designed as a central location for investigating the characteristic sequence of Antarctic geographical regions (polynia, coast, ice shelf, ice sheet, marginal mountain area and dry valleys, inland plateau) within a radius of 200 kilometers (~124 miles) of a selected site. The station was also to be designed as ‘state of the art’ with respect to sustainable development, energy consumption, and waste disposal, with a minimum lifetime of 25 years.

Mr. Berte participated in the conceptual design studies leading to the selection of the IPF by the Belgian government to construct his team’s proposed station design. Since 2004, Mr. Berte has traveled in each of the subsequent Antarctic seasons to the proposed location for the new Princess Elisabeth Antarctic Station, assisting in the final site selection, preparing the site for construction, locating a surface route for the transport of supplies and heavy equipment from the coast to the site and, finally, completing the on-site assembly and checkout of the station. When not deployed to the Antarctic, he has been responsible for the engineering and overseeing construction of all of the systems that make up this station.

Mr. Berte has experience as a conceptual designer, system engineer, and project manager in innovative projects ranging from industrial automation, application of new technologies, and space instrumentation. Mr. Berte is a guest teacher and advisor on design methodology and technological innovation at various institutes in Belgium and other locations.

### 3.4 Richard Cameron

Dr. Richard Cameron is currently an adjunct professor at Webster University in St. Louis, Missouri.

While completing his undergraduate studies at the University of New Hampshire (B.Sc. in Geology, 1954), Dr. Cameron spent the summer of 1953 at the Summer School at the University of Oslo where he had the opportunity of taking a course on Norway in the Polar Regions with Dr. H. U. Sverdrup, a student of the noted polar explorer Fridtjof Nansen. After the course, he worked with the Norwegian Polar Institute on glaciers in the Jotunheim. Following graduation, he worked with Dr. Valter Schytt (chief glaciologist of the Norwegian-British-Swedish Antarctic Expedition) first in Greenland in the summer of 1954 and then during 1955 at the University of Stockholm.

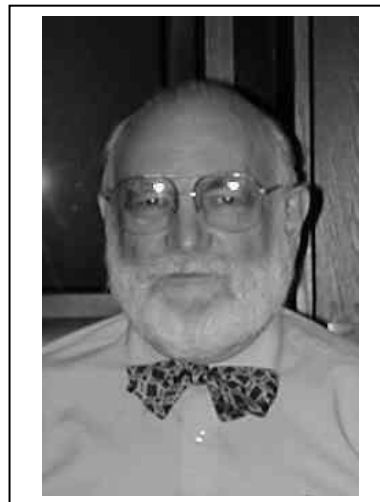

Dr. Cameron joined the Arctic Institute of North America in 1956 to participate in IGY-related activities in Antarctica. He served as Chief Glaciologist at Wilkes Station, on the coast of East Antarctica. This was a joint Navy-civilian operation consisting of 17 Navy personnel and 10 scientists. Specifically, his glaciological team consisted of two colleagues with whom he had worked before – Olav Loken in Norway in the summer of 1953, and John Molholm in Greenland in the summer of 1954. This team spent much of its time at a remote station established 80 kilometers (50 miles) inland, where they conducted both meteorological and glaciological studies. One of the glaciological studies entailed digging a 35-meter (~115-foot) vertical pit to study snow densification and stratigraphy.

After completing his doctoral course studies at The Ohio State University in 1961, he accepted the position of Chief of the Geotechnics Branch, Terrestrial Sciences Lab, Air Force Cambridge Laboratories. He returned to Ohio State University in 1963 to finish his dissertation and receive his degree. He then served in a number of positions at the University - Assistant to the Director of the Institute of Polar Studies, Associate Director of The Ohio State University Research Foundation, Assistant Dean of University College, and Assistant Dean of International Programs. In 1973, Dr. Cameron joined the National Science Foundation first as Associate Program Manager and then Program Manager of International Organizations, Division of International Programs. He then moved to the Division of Polar Programs where he was the Program Manager for Glaciology from 1975 to 1985. In this last position he acted as the NSF Representative at South Pole Station at the beginning of each summer. He would go in on the first flight, usually on November 1, with the replacement crew and spend a month or more to monitor how the new crew was doing. Now and then it was necessary to replace a crew member who was not adequate to handle the job assigned or not emotionally stable enough to spend the whole winter.

Dr. Cameron, has been conducting a number of study tour programs for Webster University during the last few years – Glacier Studies in Austria in 1999, Physical Geography of the Netherlands in 2000 and 2001, and Fire and Ice (glaciology and volcanology) in the Pacific Northwest in 2001.

### 3.5 John Gruener



Mr. John Gruener is a systems engineer working in the Lunar Surface Systems Project Office, part of the Constellation Program Office. His primary responsibility is science integration in NASA's exploration mission planning and architecture development activities.

Mr. Gruener began working in the space program in May, 1986, after receiving a B.S. in aerospace engineering from the University of Texas at Austin. He first worked supporting Space Shuttle missions and the design of the ISS, but quickly moved to advanced mission planning activities for human and robotic exploration beyond low Earth orbit. Mr. Gruener participated in NASA's 90-Day Study on Human Exploration of the Moon and Mars in 1989, and the subsequent government-wide study known as the Synthesis Group on America's Space Exploration Initiative.

Mr. Gruener received an M.S. in physical science, with an emphasis in planetary geology, from the University of Houston-Clear Lake in 1994. He then began working with NASA JSC's Solar System Exploration Division on the development of prototype planetary science instruments, the development of a mineral-based substrate for nutrient delivery to plant growth systems in bio-regenerative life support systems, and in support of the Mars Exploration Rover missions in rock and mineral identification.

In 2004, Mr. Gruener again participated in a renewed effort to plan and design missions to the Moon, Mars, and beyond. He participated in many exploration planning activities, including NASA's Exploration Systems Architecture Study (ESAS), Global Exploration Strategy Workshop, Lunar Architecture Team 1 and 2, Constellation Lunar Architecture Team, the Global Point of Departure Lunar Exploration Team, and the NASA Advisory Council (NAC) Workshop on Science Associated with the Lunar Exploration Architecture. Mr. Gruener has also been an active member of the science team supporting NASA's Desert Research and Technology Studies (RATS).

### 3.6 Friedrich Horz

Dr. Friedrich Horz is a planetary scientist interested in impact processes.

Dr. Horz was hired by NASA in 1970 to assist in the geologic training of the Apollo 15, 16, and 17 astronauts. He participated in numerous field trips and classroom activities; specifically, he was to introduce the topic and concepts of impact processes to the crews, a subject that was in its infancy at the time and of interest to only a few prior to the Apollo Program. His familiarity with Apollo and associated science operations led to his current assignment as Deputy Scientist for analog field-tests for the Constellation Program.



Dr. Horz received his B.S. (in 1961) and Ph.D. (in 1965) from the University of Tübingen, Germany, with a thesis that included detailed field work and mineralogical-petrographic characterization of the impact melts at the Ries Crater, Germany. His postdoctoral work at the NASA Ames Research Center, California Institute of Technology, and the Lunar Science Institute, Houston, focused on the experimental reproduction of diagnostic deformation and melt phenomena in minerals and rocks that were subjected to impact-triggered shock waves; the experiments produced shock waves of known amplitudes, providing pressure calibrations for equivalent features in naturally shocked rocks. Dr. Horz joined NASA JSC in 1970 and founded the “Experimental Impact Laboratory,” which he also managed for 35 years, ultimately including three unique high-velocity guns to simulate shock waves and the cratering process. He published extensively on the shock metamorphism of minerals, rock, and lunar soils, conducted collisional fragmentation experiments and cratering studies, and modeled the evolution of planetary regoliths. He also simulated micro-craters generated by sub-millimeter-sized cosmic dust particles and developed/exposed/analyzed cosmic dust detectors on board Shuttle, MIR, and the Stardust Mission to comet Wild 2.

Dr. Horz received the Barringer Award of The Meteoritical Society in 1996 for his lifetime accomplishments in impact studies. In addition, Dr. Horz has a commendation from the American Geologic Society, and has received, at JSC, NASA Outstanding Performance awards, Certificates of Commendations, and Sustained Superior Performance awards.

### 3.7 Gary Lofgren



Dr. Gary E. Lofgren is a senior planetary scientist and the Lunar Curator for NASA. He has been a research scientist and Principal Investigator in the NASA Cosmochemistry program since 1968. He has studied lunar and terrestrial basalts, and is currently studying the origin of chondrules in meteorites. Chondrules are the most primitive and the oldest material in our solar system that is available to study. Thus, these studies will shed light on the earliest history of our solar system. As Lunar Curator, his duties are twofold: 1) maintain the scientific integrity of the lunar samples; and 2) assist scientists that want to study lunar samples to obtain the materials most appropriate for their studies. He works with CAPTEM (Curation and Analysis Planning Team for Extraterrestrial Materials) a NASA advisory committee to meet both these objectives, and to ensure that the lunar samples are used for only high quality scientific studies. He oversees the preparation of lunar material for distribution to scientists for study, to museums for display, and for educational purposes. Most recently he is participating in the DRATS Analog program that is developing planetary surface operations including science operations.

Dr Lofgren's area of expertise is experimental petrology with emphasis on experimentation at high temperatures and pressures using controlled oxidation/reduction atmospheres. He conceived and built the Experimental Petrology Laboratory in the Solar System Exploration Division at JSC into a world recognized facility. He pioneered the modern science of the experimental study of the kinetically controlled crystallization (dynamic crystallization) of silicate rock melts. These studies have provided a standard for the interpretation of igneous rock textures (the relationship of minerals to one another) and other kinetically controlled phenomena and models for their formation. Particular emphasis is placed on understanding such textural features as crystal size and shape as a function of crystal growth conditions.

Dr. Lofgren received his Ph.D. (1969) and B.S. (1963) from Stanford University and his M.A. from Dartmouth College, all in geology. He began working for NASA in 1968. He served on the Lunar Sample Preliminary Examination Team. In addition to being involved in the initial examination of Apollo samples, he was involved with the geologic training of the Apollo astronauts. He was the geologic science training coordinator for the Apollo 15 crew and also worked with the Apollo 13, 16, and 17 crews. He convened a Geological Society of America, Penrose Conference on the "Application of Crystal Growth Theory and Experiments to Rock Forming Processes," in 1976. He was the leader of the Chemistry and Petrology Team of the NASA "Comparative Planetological Study of Basaltic Volcanism" Project (1976-1981). Gary has advised on numerous graduate theses completed at several universities around the country. He has also advised more than 20 NRC Research Fellows during their studies at JSC.



### 3.8 Charles Swithinbank

Dr Charles Swithinbank is currently an Emeritus Associate of the Scott Polar Research Institute, University of Cambridge, England.

Dr. Swithinbank has been conducting research in the Earth's Polar Regions since 1947, beginning with his participation in the Oxford University Iceland Expedition. He was the youngest member of the Norwegian-British-Swedish Antarctic Expedition, spending 2 consecutive years with 15 other researchers and support staff at Maudheim Station. During this expedition, he participated in several oversnow traverses measuring several hundred kilometers in extent and lasting for many weeks at a time. His polar expedition record stretches into the 1990s. During these expeditions, Dr. Swithinbank has conducted research at British, U.S., and Russian stations in the Antarctic.

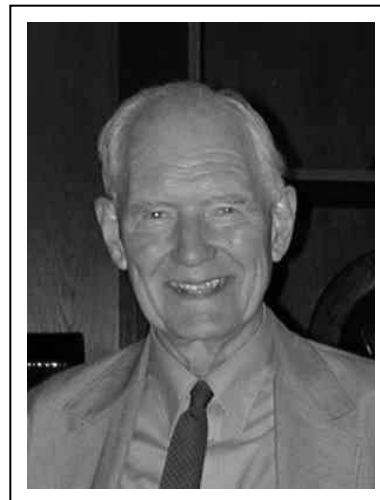

Dr. Swithinbank received a B.A. in geography in 1949, an M.A in 1953, and a D.Phil. in glaciology in 1955 from the University of Oxford, Pembroke College. His work with the Norwegian-British-Swedish Antarctic Expedition continued through 1955. He then spent 4 years as a research fellow at the Scott Polar Research Institute, located at the University of Cambridge. From 1959 through 1963, Dr. Swithinbank was a research associate and lecturer at the University of Michigan (where he earned his private pilot's license). From 1963 through 1986, he worked for the British Antarctic Survey (a British government institute that is part of the Natural Environment Research Council), first as Chief Glaciologist (1963-74) and then as Head of Earth Sciences (1974-86). During this time, he spent three winters and more than 20 field seasons in the Polar Regions. He continues to visit the Polar Regions frequently as a consultant for commercial expeditions in Arctic and Antarctic waters. Since 1986, Dr. Swithinbank has been an Emeritus Associate at the Scott Polar Research Institute, University of Cambridge. He has been involved in the interpretation of satellite images of Antarctica, mapping, and the development of ice runways for transport aircraft.

Among his extensive professional activities, Dr. Swithinbank has been a member of the International Commission on Snow and Ice (Vice-President 1979-83), International Glaciological Society (President 1981-84), and the American Association for the Advancement of Science (Life Member). He has received many awards from British, American, Scandinavian, and other organizations for his outstanding contribution to a wide variety of studies of, and expeditions to, the Polar Regions. Among these awards are the King Haakon VII of Norway-Medal of Merit (1952), the Scott Polar Research Institute-Watkins Award (1953), the Queen Elizabeth II-Polar Medal (1956), the King Gustav VI of Sweden-Retzius Medal (1966), and the United States Antarctica Service Medal (1974).

### 3.9 Marie-Claude Williamson



Dr. Marie-Claude Williamson is a research scientist at the Geological Survey of Canada (GSC), and adjunct research professor at Carleton University, Ottawa.

Dr. Williamson completed her undergraduate studies at l'Université de Montréal, acquiring field mapping experience while working during the summer months for the Québec Department of Natural Resources. A growing interest in volcanic rocks and love of the sea brought her to Nova Scotia in 1979 to pursue graduate studies. In 1982, she received an M.S. for completing a project on ancient volcanic rocks located along the western shore of Cape Breton Island. Following a year of technical work in marine geology, and in search of a Ph.D. project, she was offered an opportunity by a pioneer of the GSC's Operation Franklin, Dr. Neil McMillan, to map and study large tracts of igneous rocks exposed along spectacular ridges and cliffs in the Canadian High

Arctic. The field work for this project was carried out on Axel Heiberg Island and northern Ellesmere Island from 1983 to 1985, in collaboration with staff at GSC Calgary who were experts on the thick succession of sedimentary rocks known as the Sverdrup Basin. Expeditions were typically compact in nature, involving herself and an assistant supported by the Polar Continental Shelf Project (PCSP). Fly camps were established in remote areas of the two islands by Twin Otter and helicopter flights originating out of Resolute or Eureka.

Dr. Williamson was invited to join the Division of Planetary Exploration at the Canadian Space Agency in July 2005. The newly formed division required geoscience expertise to respond to interest worldwide in robotic and manned exploration missions to the Moon, Mars, and beyond. She became the first geologist on staff in August 2007 with specific mandates to promote geology and geophysics both in programs and research, particularly at analogue sites in the Arctic Islands; give a voice to the Planetary Sciences community in Canada; and work with engineers on the selection of scientific instruments targeted for lunar surface investigations by Canadian-built robotic rovers.

In 2003 and 2004, Dr. Williamson carried out geological mapping and sampling from PCSP-supported fly camps on Axel Heiberg Island. In 2007-2008, in collaboration with the PCSP, Mars Institute, and McGill University, Dr. Williamson coordinated the logistics requirements for 17 planetary analogue research projects deployed out of the Haughton Mars Project Research Station on Devon Island or the McGill Arctic Research Station on Axel Heiberg Island. In 2008-2009, she co-chaired the first Canadian Planetary Geology and Geophysics (CPGG) Working Group to define, for the planetary geology and geophysics community, a set of Scientific Priorities for the Global Exploration Strategy.

Dr. Williamson completed her 2-year secondment at the Canadian Space Agency (CSA) in August 2009. She has since joined the Central Canada Division of the GSC located in Ottawa. In her capacity as field geologist, Dr. Williamson contributes to a 5-year project initiated in 2008 to update geological maps of the Canadian Arctic landmass. Her current assignment is the Minto Inlier, located on Victoria Island, Northwest Territories.

## 4 SELECTED ARCTIC AND ANTARCTIC TRAVERSE SYNOPSES

Six examples of exploration in the Earth's Polar Regions were selected for presentation and discussion at this workshop. These examples were selected to span both the time and capabilities of the post-World War II era of polar exploration. Many of the features discussed in the previous section regarding options for human exploration of planetary surfaces are addressed in these examples. Each of these examples will be described briefly here; an expanded discussion of each case can be found in the appendices of this report.

### 4.1 Norwegian-British-Swedish Antarctic Expedition of 1949-52

[This summary was assembled from notes prepared by C. Swithinbank for this workshop and from a history of the Norwegian-British-Swedish Antarctic Expedition (NBSX). Dr. Swithinbank's complete notes can be found in Appendix A of this report; the full text for the NBSX history can be found at <http://www.spri.cam.ac.uk/resources/expeditions/nbsx/>]

The Norwegian-British-Swedish Antarctic Expedition (NBSX) of 1949-52 began with Swedish scientists seeking to investigate some pre-World War II photographic data that appeared to indicate significant glacial retreat in this area (there were concerns about climate change even at that time). Unable to finance the entire expedition, Swedish scientists expanded the effort to include colleagues from Norway and England with similar interests (and additional finances; see Giaever, 1954,



**Figure 4.1: Seismic Traverse During the NBSX Expedition**

Seismic traverse staged from Advanced Base, covering some 1,300 kilometers in 80 days during the 1951/52 austral summer. (Photo courtesy of C. Swithinbank. Used with permission.)

and Swithinbank, 1999, for additional details). With the addition of Norwegian and British scientists, objectives for the expedition also expanded to include a general survey of this region of Antarctica, which was largely unexplored at the time. This expedition spent 2 consecutive years completing these objectives, which included a wide range of scientific investigations in the fields of geology, glaciology, meteorology, and medicine (see Figure 4.1 and Figure 4.2). In addition, the crew conducted significant topographical surveys and mapping of the local region. Norway was mainly responsible for meteorology and topographical surveys, Britain for geology and Sweden for glaciology. The expedition team totaled 15 men – eight scientists (two glaciologists, two meteorologists, two geologists, a geophysicist and a topographical surveyor) and seven support personnel.

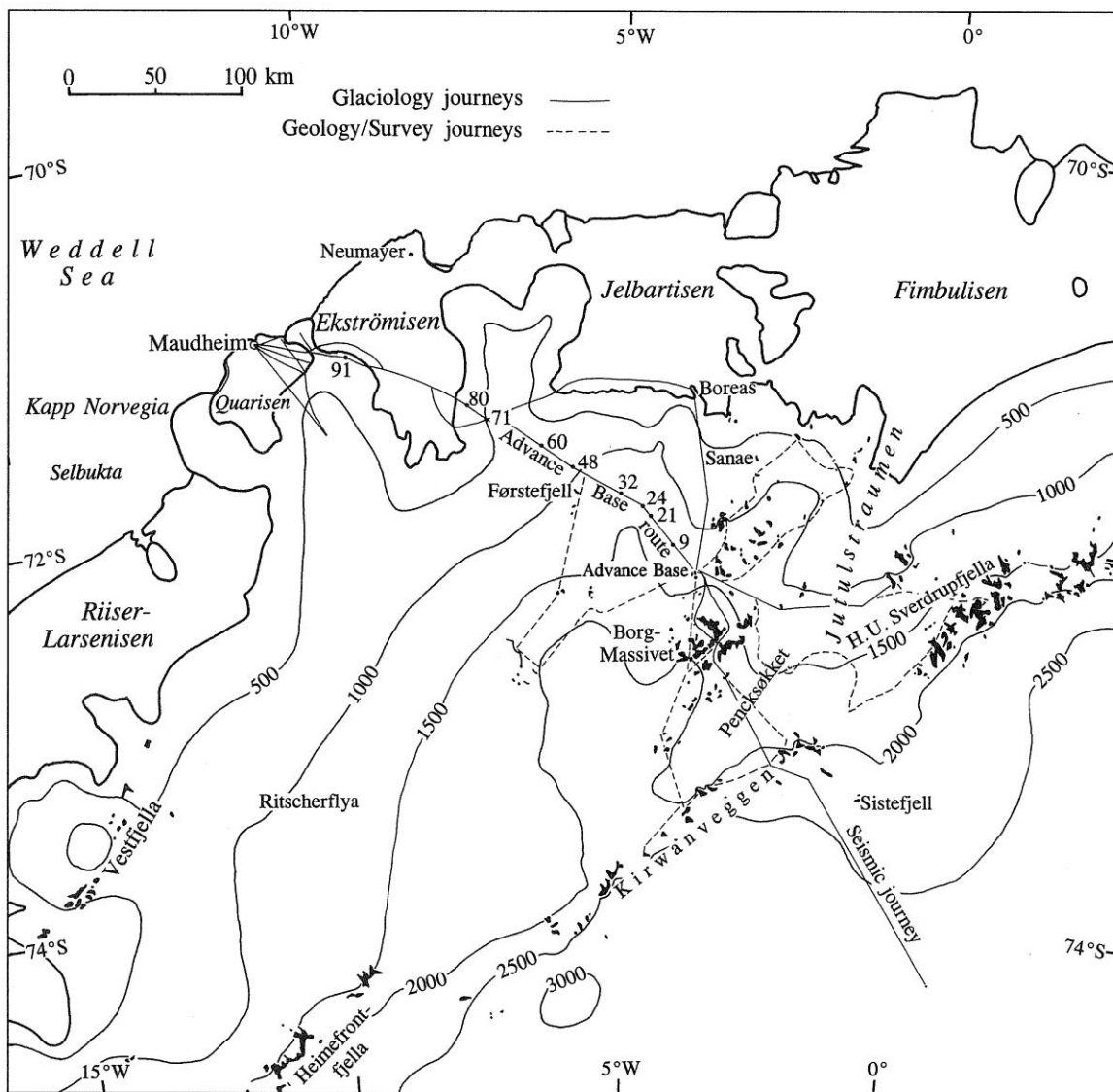

**Figure 4.2: Traverses of the NBSX Expedition**

Traverses conducted during the Norwegian-British-Swedish Antarctic Expedition. Included are traverses conducted by teams on skis or with dog sleds, in addition to those carried out using the M29 Weasel. The numbers along the Advance Base route are several of the 150 numbered flags and 138 snow cairns used to mark this route. In addition to marking the route, these flags and cairns also marked the location of several supply depots used to support traverses between Maudheim and Advance Base. (Map provided by C. Swithinbank. Used with permission.)

This group used much of its first austral summer to find a suitable location near the coast of Dronning Maud Land – an area lying between the meridians of 20°W and 45°E – where they could establish a base camp. Light aircraft were used to cover more of the coastline in a shorter period of time. Even with this assistance, it took the team until early February (late in the austral summer) to find a location along the ice front where their cargo ship could unload. Several prefabricated huts, for accommodation and housing of research and communication equipment, were assembled at this base camp (christened Maudheim, located at 71°03'S, 10°55'W) along with some 450 tons of supplies, sufficient for a stay of up to 3 years (to protect against the possibility of pack ice preventing the ship from reaching them at the

appointed time). Another camp – Advance Base – was sited at 72°17'S, 03°48'W (approximately 320 kilometers [~199 miles] from Maudheim), close to a nunatak named the "Pyramid." This camp was not permanently occupied, but consisted of tents, stocks of food, and fuel available to support field parties. This team also established a network of expedition-support supply depots away from Maudheim and Advance Base to allow field parties to explore for extended times and at extended ranges from either camp.

Surface traverses were conducted either by means of dog teams pulling sledges (62 dogs were part of this expedition) or by using some number of the three "Weasels" available to this team (the Weasel was a small tracked amphibious vehicle developed for military use during World War II; capable of transporting several people or pulling up to three tons of payload). Most of the reconnaissance traverses were conducted by small (two- or three-man) teams using dog sledges and skis. One of these teams remained in the field for 6 months before returning to Maudheim. The Weasels were used primarily to haul heavy loads, such as the short (3 kilometers [~2 miles]) trip between the supply ship and Maudheim or the long (300 kilometers [186 miles]) trip between Maudheim and the Advanced Base. During the 1951/52 austral summer, two Weasels and a habitable trailer constructed on site, were used for an 80-day, 1,300-kilometer (808-mile) traverse to conduct the longest traverse carried out by this team: a seismic survey originating from Advanced Base (see Figure 4.2).

#### **4.2 International Geophysical Year Traverses (1956 – 1958)**

[Adapted from <http://www.nas.edu/history/igy/>; accessed on September 28, 2001]

In 1952, the International Council of Scientific Unions proposed a comprehensive series of global geophysical activities to span the period July 1957 - December 1958. The International Geophysical Year (IGY), as it was called, was modeled on the International Polar Years of 1882-1883 and 1932-1933 and was intended to allow scientists from around the world to take part in a series of coordinated observations of various geophysical phenomena. Although representatives of 46 countries originally agreed to participate in the IGY, by the close of the activity, 67 countries had become involved.

American participation in the IGY was charged to a U.S. National Committee (USNC) appointed in March 1953 by the National Academy of Sciences (NAS). The core USNC was made up of 16 members, but the five Working Groups and 13 Technical Panels that operated under it eventually drew in nearly 200 additional scientists. The technical panels were formed to pursue work in the following areas: aurora and airglow, cosmic rays, geomagnetism, glaciology, gravity, ionospheric physics, longitude and latitude determination, meteorology, oceanography, rocketry, seismology, and solar activity. In addition, a technical panel was set up to attempt to launch an artificial satellite into orbit around the Earth.

IGY activities literally spanned the globe from the North to the South Poles. Although much work was carried out in the arctic and equatorial regions, special attention was given to the Antarctic, where research on ice depths yielded radically new estimates of the Earth's total ice content. IGY Antarctic research also contributed to improved meteorological prediction, advances in the theoretical analysis of glaciers, and better understanding of seismological phenomena in the Southern Hemisphere.

In 1954-55, the United States began investigating sites for stations for the IGY. The following austral summer it established the McMurdo Sound Air Operation Facility. Of the 65 IGY Antarctic research stations established by 12 nations, the United States operated seven, including the prestigious and scientifically valuable, but operationally challenging, site at the geographic South Pole. The National Science Foundation funded IGY work through the National Academy of Sciences, and the Department of Defense separately funded and provided operational support.

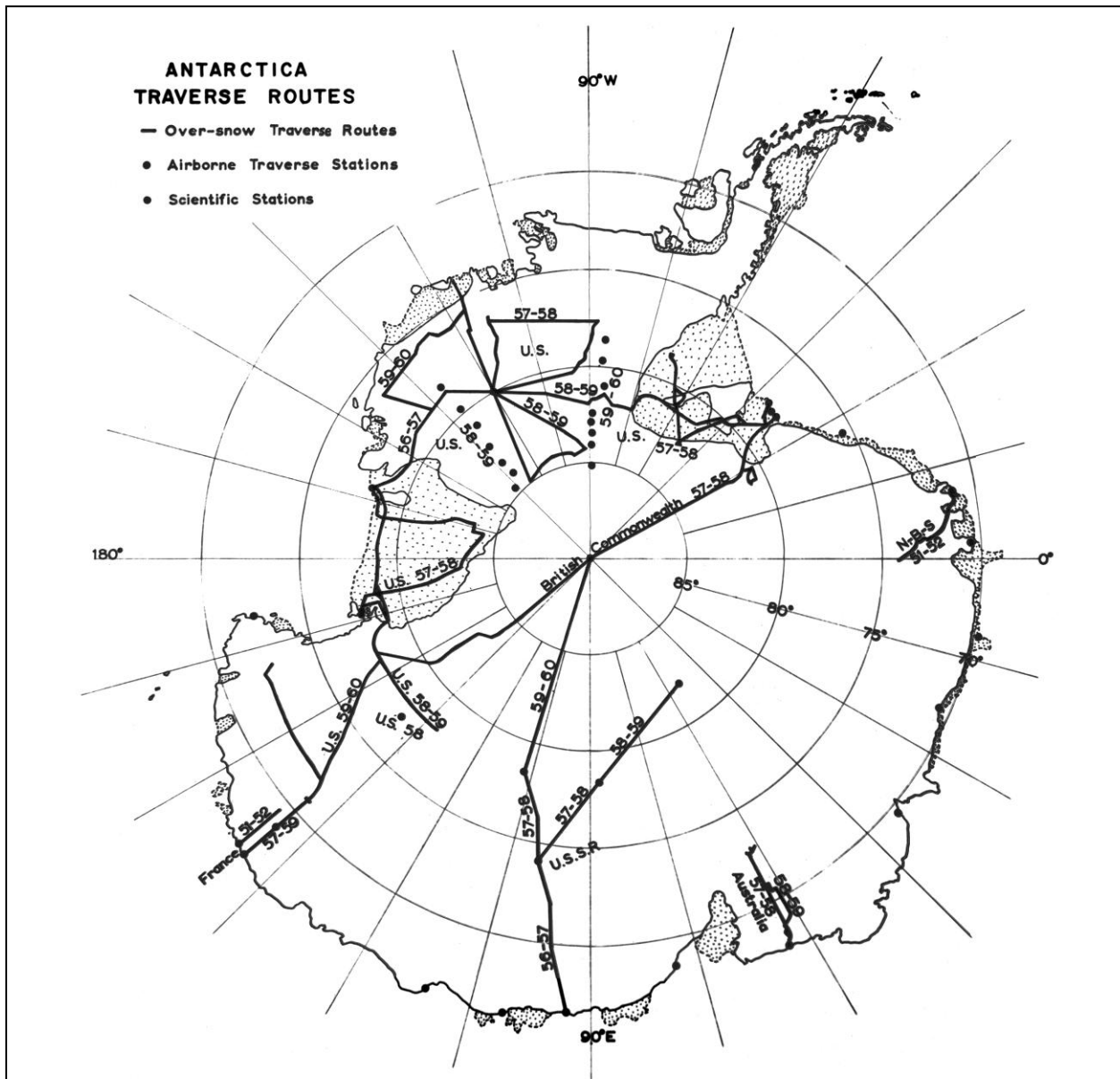

**Figure 4.3: Traverses during the IGY**

Traverses carried out in association with the International Geophysical Year by the United States and other participating nations between 1956 and 1960. (Map provided by C. Bentley. Used with permission.)

Of particular interest for this workshop were the scientific traverses (see Figure 4.3) carried out as part of the IGY:

- During the austral summer of 1956-57: the traverse from Little America to Byrd Station (co-led by Charles Bentley and Vernon Anderson).
- During the austral summer of 1957-58: the Filchner Ice Shelf Traverse (led by Ed Thiel), the Ross Ice Shelf Traverse (led by Albert Crary) and the Sentinel Mountains Traverse (co-led by Charles Bentley and Vernon Anderson).

- During the austral summer of 1958-59: the traverse across the Filchner Ice Shelf to Byrd Station (led by Jock Pirrit), the Horlick Mountains Traverse (led by Charles Bentley), and the traverse from McMurdo Station to the East Antarctic ice sheet (led by Albert Crary).

Each of these traverses was carried out by a relatively small number of people (between 5 and 10) and a relatively small number of vehicles (2 to 3). But these traverses averaged between 805 and 1609 kilometers (500 and 1000 miles) through largely unknown terrain. Significant supplies were carried by each of the traverse teams, but they were also occasionally resupplied by air courtesy of the U.S. Navy.

### 4.3 South Pole Queen Maud Land Traverses

Between 1964/65 and 1967/68, a reconnaissance traverse was carried out by the United States Antarctic Program (USAP) to support geophysical and glaciological studies from the South Pole to a point roughly in the center of the Queen Maud Land region (specifically at 78°42'S, 6°52'E). Due in part to the distances involved, this reconnaissance was split over three separate austral summer seasons: 1964/65, 1965/66, and 1967/68. Scientists on these traverses gathered geophysical measurements (gravity, magnetics, ice thickness), glaciological measurements (ice density, surface hardness, surface features, and a variety of firm measurements), and daily meteorological observations.



**Figure 4.4: Tucker Sno-Cat Model 743 AN**

Two Tucker Sno-Cats (Model 743 AN) each pulling a single sledge. Traverses carried out by the United States during the International Geophysical Year were occasionally resupplied by air. In this photograph a US Navy P2V Neptune on a reconnaissance mission circles overhead. (Photo courtesy of C. Bentley. Used with permission.)

During each of these three traverses, the traverse team consisted of eight scientists and two or three “traverse engineers.” Three large, specially built Tucker & Sons Corporation Sno-Cats® (two Model 843s and one Model 742; Model 742 was the flat bed version of Model 743) were used for transportation. Two of these Sno-Cats were configured as habitats (the Model 843s; see Figure 4.5); one was configured as a flat bed and was used as the platform for the ice coring drill (the Model 743). These three Sno-Cats pulled various combinations of three one-ton sleds, three two-ton Maudheim sleds, two Rolligon trailers (also known as a Rolli-trailer; a trailer with large inflatable tires in which was carried a portion of the fuel for the Sno-Cats). One of these Sno-Cats towing the Rollitrailer and two other sleds is shown in Figure 4.5. A typical load on these sleds and trailers was approximately 18 metric tons (40,000 pounds) of supplies, including about 5 metric tons (12,000 pounds) of fuel, 0.9 metric tons (2,000 pounds) of food and 0.9 metric tons (2,000 pounds) of explosives. But even with this payload, the traverse party required anywhere from one to three airdrops of fuel and supplies during each of the three Austral Summer seasons.



**Figure 4.5: Tucker Sno-Cat Model 843**

The Tucker Sno-Cat Model 843 pulling a Rollitrailer and a Maudheim sledge during SPQMLT I. (Photo courtesy of R. Cameron. Used with permission)

The first South Pole Queen Maud Land Traverse (SPQMLT I) began at the South Pole (all three Tucker Sno-Cats, sleds, trailers and supplies were flown to the South Pole in U. S. Navy C-130 aircraft) on December 4, 1965, and traveled for 54 days to the Pole of Relative Inaccessibility (82°7'S, 55°2'E; the geographical point farthest from any Antarctic coast line); a total distance of 1,524 kilometers. SPQMLT II began with the 11-person crew being flown by C-130 to the equipment stored at the Pole of Inaccessibility on November 22, 1965. After just over 3 weeks spent working on the Sno-Cats, this team left the Pole of Inaccessibility on December 15, 1965, and traveled for 45 days to the U.S. Plateau Station, a total

distance of 1,343 kilometers. The final team of 10 people left Plateau Station on December 5, 1967, and traveled to a point deep in the Queen Maud Land region (78°42'S, 6°52'E), a distance of 1,556 kilometers. The crew and equipment were loaded on C-130 aircraft and flown back to McMurdo Station. This series of overland traverses ended, in part, due to the success of aerial mapping of the surface (using a variety of sensors) and subsurface (including measuring ice sheet thickness using airborne radar). A map showing these traverses can be found in Section 4.5 below.

These three crews covered a total distance of 4420 kilometers (835 miles) over a total of 152 days, an average of almost 30 kilometers (19 miles) per day. However, the actual moving rate would have been faster had these teams not made stops along these traverses to drill ice core, dig snow pits, and set off explosive charges to gather seismic data and determine ice depth.

#### 4.4 Contemporary Arctic “Fly Camps”

[This summary was assembled from notes prepared by M-C Williamson for this workshop and from a history of the Canadian Polar Continental Shelf Program (PCSP). Dr. Williamson’s complete notes can be found in Appendix A of this report; the full text for the PCSP history can be found at [http://polar.nrcan.gc.ca/about/history\\_e.php](http://polar.nrcan.gc.ca/about/history_e.php)]



**Figure 4.6: Canadian Forces DC-3**

A Canadian Forces DC-3. An aircraft similar to this was used to support *Operation Franklin* in 1955. (Used by permission of the Canadian Department of National Defence.)



As the name implies, *fly camps* are short duration camps established by the Polar Continental Shelf Program (PSCP) (Natural Resources Canada) throughout the Canadian Arctic for the purposes of scientific exploration and research. Historically, the first fly camps were established in the 1950s to support reconnaissance mapping of frontier areas by the GSC. Between 1952 and 1958, helicopter support enabled GSC crews to map about half as much of Canada at a reconnaissance scale as had been mapped in the previous 110 years. The most ambitious of these mapping programs, *Operation Franklin*, covered approximately 260,000 square kilometers (162,500 square miles) of the High Arctic in one summer – about the same area as France. The project used a DC-3 aircraft, two Sikorsky S-55 helicopters, and three dog teams (see Figure 4.6 and Figure 4.7). For the GSC, a standard operational plan involved flying to a remote location and landing the aircraft as close as possible to the area of scientific interest. Geologists would then establish a fly camp, and expect a scheduled move to another location of interest, weather permitting. *Operation Franklin* was a scientific milestone that set the stage for Canadian government and industry to further explore and understand the high Arctic. Some parallels can be drawn between this era of geological exploration in the High Arctic and the Apollo missions to the Moon. Small teams were able to reach a relatively large number of sites of geological interest with the following caveats: exploration was restricted to walking distance from camp, and there were few opportunities to return to these sites for detailed studies until the 1980s.

World events over the next several years gave rise to an increased interest in the Canadian Arctic:

- the launch of Sputnik and the resulting realization of the strategic value of this region in the Cold War between the United States, the Soviet Union, and their respective allies;
- the 1958 United Nations Conference on the Law of the Sea gave nations the rights to mineral and other resources on their continental shelves to a depth of 200 meters (656 feet).

Canada was now claiming jurisdiction over a polar continental shelf about which it knew virtually nothing. In answer to all these emerging pressures, the Government of Canada established the Polar Continental Shelf Project (PCSP) in the spring of 1958. For the next 30 years, PCSP scientists carry out research in geology, geography, climate, ecosystems, culture, and history of the Canadian Arctic. In 1986, the PCSP becomes strictly a logistics coordination agency; the last of its scientific staff return to their host agencies.

Since its first scientific forays into the field in 1959, PCSP has built up a logistics support network that stretches approximately 2160 kilometers (1342 miles) from Alaska to

Greenland and from the Arctic Circle to the geographic North Pole. Now renamed the Polar Continental Shelf Program, PCSP provides ground and air support services to approximately 130 scientific groups from more than 40 Canadian and international universities or government agencies in disciplines that range from archaeology to space science to zoology.



**Figure 4.7: Canadian Forces Sikorsky S-55**

A Canadian Forces Sikorsky S-55 helicopter. Two aircraft of this type were used to support *Operation Franklin* in 1955. (Used by permission of the Canadian Department of National Defence.)



**Figure 4.8: Twin Otter Aircraft**

A Twin Otter aircraft departs after offloading a research team and their equipment at Strand Fiord, Axel Heiberg Island. (Photo courtesy of M-C. Williamson. Used with permission.)

Contemporary field operations supported by PCSP are based on the system pioneered during *Operation Franklin*, and carry the potential to train space crews for longer-duration missions. Fly camps are established with support from PCSP fixed- and rotary-wing aircraft based on careful operational planning on the part of the principal investigator (PI). Site selection is driven primarily by science goals but critical issues such as environmental impact and access to drinking water are taken into account. There are significant differences between the logistics support provided by these two types of aircraft. Fixed-wing aircraft supporting fly camps usually consist of Twin Otters outfitted with tundra tires. These aircraft can deliver a larger number of people (11 passengers and gear) or greater amount of cargo in a single flight when compared to rotary-wing aircraft.

The principal challenge for science PIs who carry out research from fly camps is to choose a safe landing site in an areas of subdued topography. It remains that tundra landing strips in the High Arctic are rarely, if ever maintained on an annual basis unless they are designated fuel caches. As a result, the final choice of a landing site is highly dependent on the state of the tundra landing strip, pilot's skills, and prevalent weather. Figure 4.8 shows a Twin Otter taking off shortly after offloading a PCSP-supported research team at the Strand Fiord tundra, on western Axel Heiberg Island. In this particular case, the party of four devoted almost 6 hours to shuttling their gear off the tundra airstrip and setting up sleep and kitchen tents. In contrast rotary-wing aircraft afford a greater degree of flexibility in the choice of a landing site, even in rough terrain, as illustrated in Figure 4.9, but at the expense of smaller camps or multiple flights to establish and extract equipment and personnel.. Pilots usually rely on the science PI for navigational input. Helicopter-supported fly camps are limited to small teams and may require complex flight plans to and from PCSP bases (i.e., multiple moves) to complete all the field campaign objectives. In the case of geoscientific projects, mapping, surveying, and sampling are typically planned according to a set of 10 to 15-kilometer (6 to 10-mile) foot traverses radiating out from base camp, a model that was successfully applied during the Apollo Program. Use of all-terrain vehicles (ATVs) can extend this range by providing a capability to explore longer distances across the tundra but at the expense of additional equipment and fuel delivered by fixed-wing aircraft and, therefore, contingent on the capability for a Twin Otter to land safely. The duration of individual fly camps is dictated by the research to be accomplished at sites of interest. Timelines are also constrained by the support that can be provided by the PCSP during the course of the Arctic season (June through early September) depending on the



**Figure 4.9: Helicopter at Flycamp**

Following a snowstorm, a PCSP helicopter is tasked to move a crew of three geologists from their fly camp to the Eureka Weather Station. (Photo courtesy of M-C. Williamson. Used with permission.)

number and type of other research programs being supported. Robust operational planning that includes the acquisition of territorial permits, equipment redundancy, crew training, briefings with PCSP Base Camp managers in Resolute, and several scientific research backup plans are required for field campaigns to be successful. As such, fly camps are ideally suited to provide advance scientific training opportunities for future space exploration crews.

#### 4.5 Norwegian-American Scientific Traverse of East Antarctica

[This summary was assembled from notes prepared by M. Albert for this workshop and from information regarding the Norwegian-American Scientific Traverse of East Antarctica posted on the Internet. Dr. Albert’s complete notes can be found in Appendix A of this report; additional information adapted from multiple entries from <http://traverse.npolar.no/>; accessed multiple times between September 2009 and May 2010.]

As the name implies, this traverse was a joint effort by U.S. and Norwegian scientists (although there was membership from other countries as well) that was carried out as part of the 2007 – 2008 International Polar Year (IPY). As with the earlier Norwegian-British-Swedish Expedition discussed above, neither of these sponsoring groups had sufficient resources to carry out this traverse on their own, but they were able to jointly assemble a team and supporting resources for this important IPY traverse. The overall objective of this traverse was to gather data from the East Antarctic ice sheet from a variety of sources to be used to study the current and past role of this ice sheet in the Earth’s climate. This included comparing data sets with those gathered approximately 40 years earlier during the South Pole Queen Maud Land Traverse discussed above. The specific science data sets to be gathered by this team included physical, chemical, and electrical property analyses of ice laid down over time (obtained from ice cores) and stratigraphic measurements from recent years (obtained from snow pits). The team also gathered radar data and related it to satellite (particularly Synthetic Aperture Radar [SAR]) images. The radar measurements allowed the team to connect data from the snow pits and core samples, as well as mapping near those sites, to the longer traverse.

The traverse team totaled 12 people – seven scientists and five support personnel. This team used the Swedish-built Berco TL-6 “Snow Cat” as its primary means of transportation. Four of these Snow Cats were used for the traverse, each vehicle pulling two large (and occasionally a small) sledges. The configuration of these four vehicle/sledge combinations is shown in Figure 4.10.

Prepositioned supply depots (primarily fuel) were used to resupply these vehicles on both the southbound (three depots) and northbound (two depots, including South Pole Station) traverses.

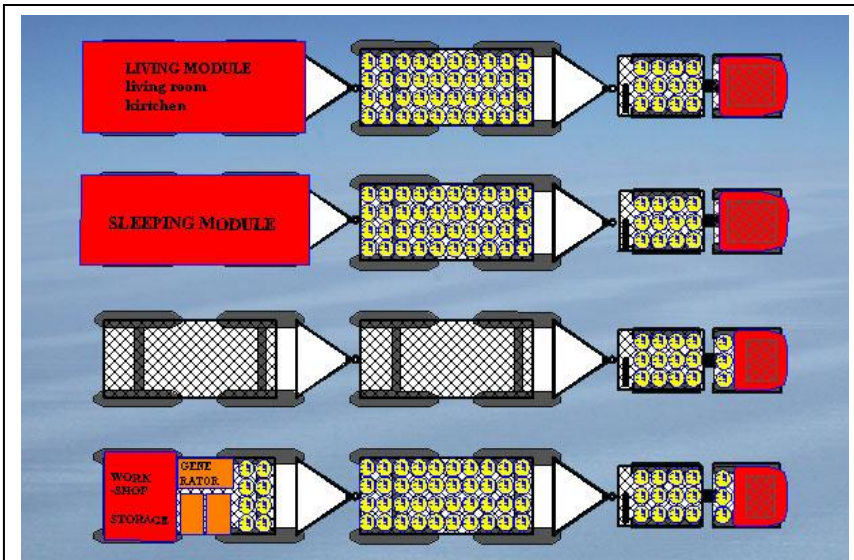

**Figure 4.10: Vehicle Configurations for NASTEA**

Vehicle configuration for the Norwegian-American Scientific Traverse of East Antarctica (NASTEA). Colors code: red = vehicles and modules, yellow = fuel, grey/white = equipment. (Image courtesy of M. Albert. Used With permission.)

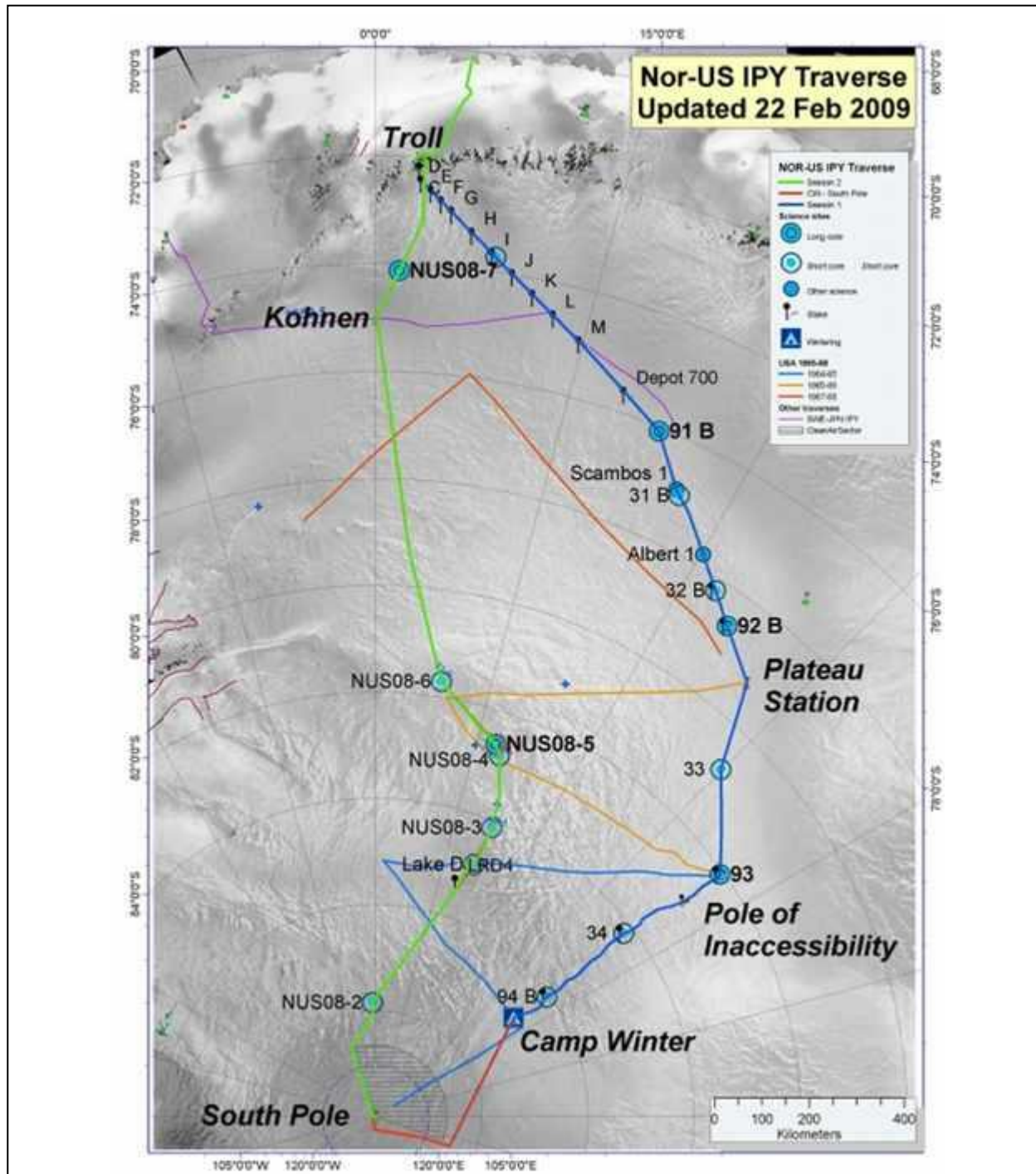

**Figure 4.11: Traverse Route for NASTEA**

Traverse route for the Norwegian-American Science Traverse of East Antarctica (NASTEA). The dark blue line indicates the 2007/08 route south and the light green line indicates the 2008/09 route north. Also indicated with a light blue-gold-red line are the three SPQMLT from the mid-1960s. (Map courtesy of M. Albert. Used with permission.)

Figure 4.11 shows the traverse route followed by this team from the Norwegian station (Troll) to the South Pole (dark blue in this image with science stations indicated) and the return route (light green in this

image). The route from Troll to the South Pole was completed during the 2007-2008 austral summer and covered a distance of 2676 kilometers (1663 miles) in 59 days (an average of 45 kilometers [28 miles] per day). Note: Due to recurring mechanical problems with the traverse vehicles, this team actually stopped just short of the South Pole and was flown the remaining distance. The following season, the traverse team made significant repairs to their vehicles before continuing on to the South Pole and then returning to Troll by a different route. The route from South Pole to Troll was completed during the 2008-2009 austral summer and covered a distance of 2166 kilometers (1346 miles) in 62 days (an average of 34 kilometers [21 miles] per day).

#### 4.6 Belgian Princess Elisabeth Station and Support Traverses

[This summary was assembled from notes prepared by J. Berte for this workshop and from the Final Comprehensive Environmental Evaluation (CEE) Report for the Princess Elisabeth Research Station (Anon., March 2007). Mr. Berte's complete notes can be found in Appendix A of this report; the full text for the CEE Report can be found at [http://www.belspo.be/belspo/bepoles/doc/final\\_CEE\\_en.pdf](http://www.belspo.be/belspo/bepoles/doc/final_CEE_en.pdf)]

To better understand how the Earth System works in general and to facilitate Belgian scientists in their Antarctic work, a panel of experts (commissioned by the Belgian Science Policy Office, Belspo) recommended in 2002 the re-opening of a Belgian scientific station in Antarctica. Constructed during the 2007-2008 IPY, the new Belgian "Princess Elisabeth" Research Station links the intensive burst of IPY activities with the post IPY role of Antarctica to study the functioning of the Earth System for the benefit of society. The objectives of the science programme at the new station therefore mirrors the major themes put forward within the (Belgian) Science Plan of the IPY:

- (1) determine the present state of the environment;
- (2) observe and understand the change of the natural environment, develop projections of the future environment;
- (3) study the link between Antarctica and the rest of the globe;
- (4) open new frontiers of science (microbiology, subglacial extreme environment);
- (5) use the unique vantage point of a station remotely situated at the edge of the polar plateau for the observations of the Earth's interior (crustal dynamics) and the cosmos (meteorites, upper air physics);
- (6) making use of the momentum created by the IPY, develop programs with respect to education (youth, schools) and outreach (general public).



**Figure 4.12: Princess Elisabeth Station**

The Princess Elisabeth Station main building with the Utsteinen Nunatak in the distance. (Photo courtesy of J. Berta. Used with permission.)

The new station has been erected on the Utsteinen Ridge (71°57'S; 023°21'E), situated at the foot of the Sør Rondane Mountains, Dronning Maud Land, 173 kilometers (107 miles) inland from the former (Belgian) Roi Baudouin base (operated between 1958 and 1967). The design of the Princess Elisabeth Research Station infrastructure is based on sustainable technology and high energy efficiency, using renewable energy as the primary energy source, thereby limiting the use of fossil fuels to transport and

field work. The Research Station is designed for optimal use by 12 people, four of these people being the station's staff. The station will be occupied by this group during the Austral summer season (November through February) and will be remotely monitored during the remainder of the year. The station will support traverse activities within a range of maximum 200 kilometers (124 miles), up to the polar plateau and down to coastal Breid Bay. This range of support will allow access to all geographical regions: polynia, coast, ice shelf, ice sheet, marginal mountain area and dry valleys, inland plateau.

The Research Station facilities consist of four major structures: a main building (Figure 4.12), a garage/storage building, and two stand-alone scientific facilities. The station has a hybrid design: the main building is above ground-level and anchored into snow-free rock area and the adjacent garage/storage building is mainly constructed under the surrounding snow surface. Altogether the main station and garage/storage facility has usable floor space (living, technical, research, storage) of 1500 m<sup>2</sup>. The use of a station "extension" will make it possible to accommodate another eight people. This extension consists of heated shelters used for sleeping only. The two small stand-alone scientific facilities will be located on the same ridge as the main building, one to the south and one to the extreme north of the station. Both facilities will have data connection to the main station; the south facility will have electrical power directly from the station while the north one will have its own power supply (solar panels/ small wind turbine/ batteries). The science dedicated area is up-wind of the station to prevent disturbance of the measurements.

The station design has a maximum target energy load of 40 kW, excluding research equipment and support vehicles. The station is designed to be constructed, operated and decommissioned using:

- fossil fuels for transport and construction only
- solar/wind for construction, one wind turbine is operational during the construction and solar photovoltaic (PV) panels are used to generate electricity
- solar/ wind for building functions and scientific equipment (in the operational phase)
- two back-up diesel generators

The water supply for the station is the result of a combination of solutions. The initial system will use snow drift and the (resulting) snow accumulation caused by the building and the ridge. The collected snow will be automatically dumped into (the lower positioned) snow collector located in the garage/storage building. The station has solar thermal panels which are used to heat a thermal buffer layer that insulates the main building. Excess heat from this system will be used to melt snow, thereby limiting the use of electrical energy to pumping the water. In addition electrical heating, eventually backed-up with waste heat originating from co-generation (multiple sources possible), can be used in the system. A water buffer tank in the main building will accommodate 5 days supply of potable water and the hot water storage will also be inside the main building. Both water storage systems are part of the thermal buffer mass of the building.

Current vehicles and logistic support for the station consists of:

- four skidoos with three sledges;
- two Prinoth Everest Antarctic version snow tractors (both with a crane; one with an emergency cabin) with eight 6.1-meter (20-foot) cargo sledges;
- two bulldozers (recovered from the abandoned Japanese Asuka station); and

- in addition, a 1000 x 50-meter (3280 x 164-foot) snow landing strip will be leveled at the start of each season for aircraft support.



**Figure 4.13: Unloading for PES at Breid Bay**

Unloading provisions for the Princess Elisabeth Station at Breid Bay. (Photo courtesy of J. Berta. Used with permission.)







The yearly station provisioning will be carried out via supplies delivered by ship to one of three locations along the coast in the vicinity of Breid Bay (Figure 4.13). To limit the number of days needed to off-load the ship (for budget and safety reasons), an inland depot area was identified at a safe distance from the edge of the ice shelf where the transport containers could be rapidly accumulated and temporarily stored. Transport containers will be limited to a maximum of 8 metric tons (17,637 pounds) for safe movement across the sea ice and easy handling. These transport containers will then be moved from the depot area for the remainder of the 180 kilometers (112 miles) to the Research Station by a series of convoys using the previously identified snow tractors and cargo sledges. Personnel will be moved to and from the station via aircraft.

#### **4.7 Summary of Selected Traverse Vehicles, Ranges, and Cargo Capability**

This section has briefly described the polar exploration expeditions of the invited speakers, focusing on their methods of traversing across significant distances over extended periods of time. These examples cover a broad range of personnel in the field, expedition durations, distance covered during the expedition, and cargo required to support the personnel in the field. With the exception of the “fly camps” example, these expeditions used a variety of vehicles, some modifications of existing designs and some custom designs, to traverse the unimproved terrain being explored.

Several expedition parameters and vehicle characteristics are summarized on the following pages for the expeditions described by the invited speakers. These summaries are intended to provide a side-by-side comparison to illustrate the similarities and differences of the example expeditions. These particular summaries are focused on the selected example expeditions in the Antarctic; the Arctic “fly camps” examples were not included because the diverse number, scope, and distribution of “fly camps” supported in the Arctic do not easily fit into this type of comparison. However, this is not intended to diminish this approach for exploring vast areas; it is in fact a technique that is also used where appropriate in the Antarctic.

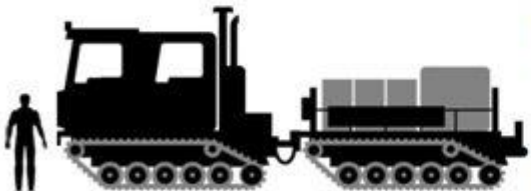
Figure 4.14 provides a comparison of the size and capability of the vehicles used in each of the selected Antarctic traverses. Figure 4.15 illustrates the location, range, number of personnel and number of vehicles used in the selected Antarctic traverses. This figure is repeated from Section 1.2 above but at a larger scale to improve its readability. The final entry in this section is Table 4.1 that documents data captured in these two figures plus information on the location, duration, cargo, and “speed made good” during the selected traverses.

	<p><b>Studebaker M29C "Weasel" (Open Cab)</b>  Representative Expeditions Discussed at Workshop:  Maudheim to Adv. Base &amp; Return, 11/50, 600km  Maudheim to Adv. Base &amp; Return, 12/50, 600km  Maudheim Depot Refresh, 9/51, 400km  Maudheim region seismic studies, 10/51, 1240km  Weight: 2200 kg (dry)  <b>Cargo Capacity: 450 kg plus 2300 kg on sled</b></p>
	<p><b>Studebaker M29C "Weasel" (Enclosed Cab)</b>  Representative Expeditions Discussed at Workshop:  Wilkes Station to Vanderford Glacier &amp; Return, 1/57, 80 km  Wilkes Station to Cape Poinsett &amp; Return, 1/57, 250 km  Wilkes Station to Site 2 (S2) &amp; Return, 3/57, 170 km  Weight: 2300 kg (est) (dry)  <b>Cargo Capacity: 450 kg plus 2300 kg on sled</b></p>
	<p><b>Tucker Sno-Cat Model 743 AN</b>  Representative Expeditions Discussed at Workshop:  IGY-US Little America to Byrd Station, 1/57, 1041km  IGY-US Little America to Ross Ice Shelf, 10/57, 2333km  IGY-US Byrd Station seismic studies, 11/57, 1931km  IGY-US Ellsworth Station seismic studies, 10/57, 1313km  Weight: 3400 kg  <b>Cargo Capacity: 1000 kg (crew + cargo) plus 2500 kg on sled</b></p>
	<p><b>Tucker Sno-Cat Model 843 and Rolli-Trailer</b>  Representative Expeditions Discussed at Workshop:  QMLT I South Pole to PoRI, 12/64, 1520 km  QMLT II PoRI to Plateau Station, 12/65, 1343km  QMLT III Plateau Station science studies, 12/67, 1556km  Weight: 11000 kg (wet)  <b>Cargo (total Rolli-Trailer and sled): 14000 kg</b></p>
	<p><b>Berco TL-6</b>  Representative Expeditions Discussed at Workshop:  Nor-US South Bound, Troll Station to near South Pole, 12/07 – 2/08, 2176km  Nor-US North Bound, near South Pole to Troll Station, 12/08 – 2/09, 2166km  Weight: 6800 kg  <b>Cargo Capacity: 4200 kg plus &gt; 23000 kg on trailer</b></p>
	<p><b>Prinoth "Everest Power Antarctic"</b>  Representative Expeditions Discussed at Workshop:  Princess Elisabeth Station construction support (12/07 – 1/08)  Traverse Length: 360 km roundtrip, 16 trips in 2007-2008  Weight: 9700 kg w/ Attached Shelter  <b>Cargo Capacity: 3000 kg plus &gt; 23000 kg on trailer</b></p>

**Figure 4.14: Antarctic Traverse Vehicles**  
Comparison of vehicles and cargo capacity used between 1950 and 2008



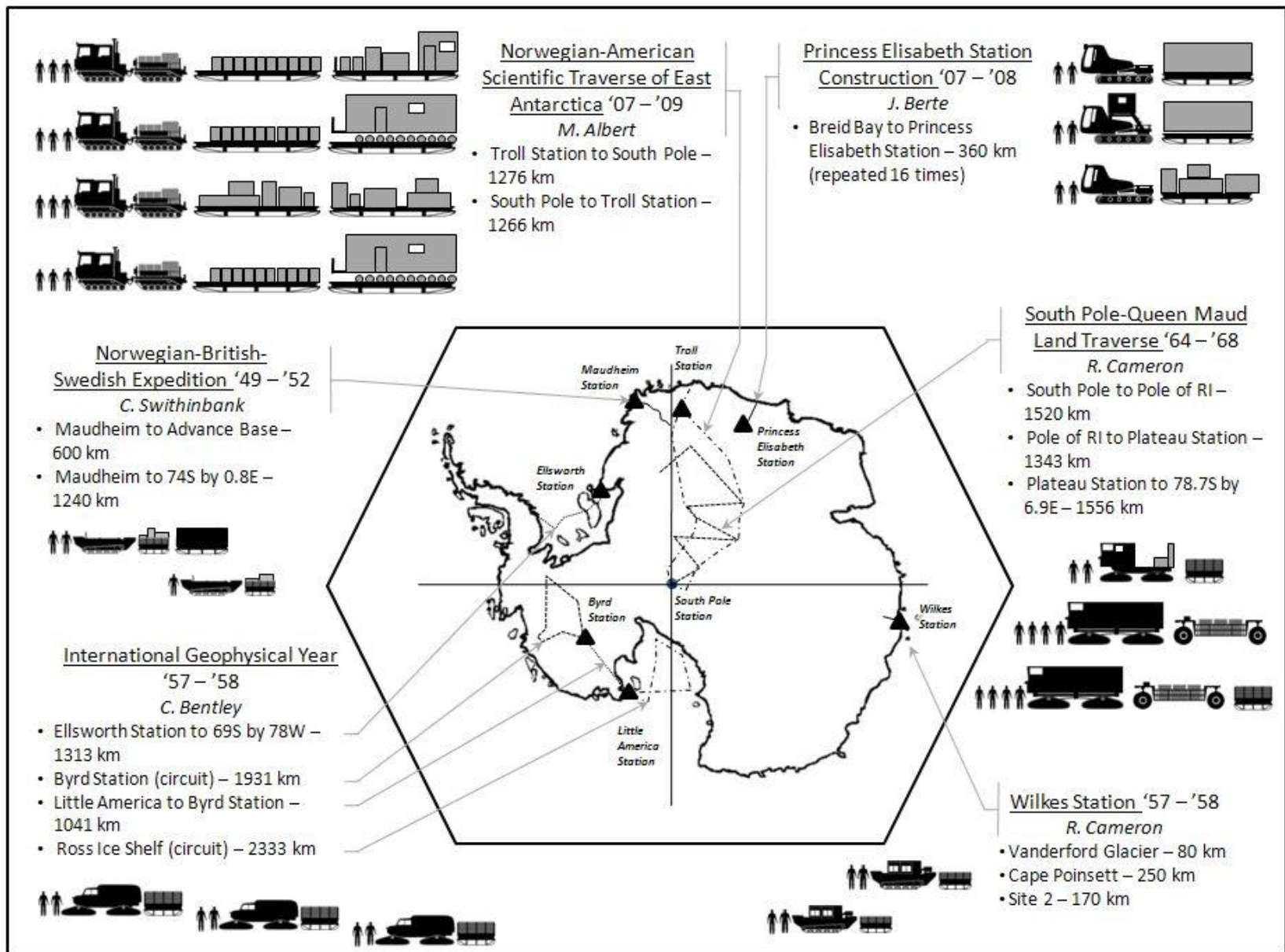

Figure 4.15: Antarctic Expeditions and Traverses of the Invited Speakers

**Table 4.1: Key Characteristics for Each of the Antarctic Traverses Discussed at this Workshop**

<b>Expedition Title</b>	<b>Traverse</b>	<b>Dates</b>	<b>Days</b>	<b>Distance (km)</b>	<b>Speed Made Good (km/day)</b>	<b>Purpose</b>	<b>Load</b>	<b>Vehicle (number of vehicles)</b>	<b>Crew</b>	<b>Notes</b>	<b>Ref.</b>
<b>Norwegian-British-Swedish Expedition (NBSX)</b>	<b>Maudheim to Advance Base and return</b>	<b>Nov 20, 1950 Nov 28, 1950</b>	<b>8</b>	<b>600</b>	<b>75</b>	<b>Depot laying and establish Advance Base depot</b>	<b>0.5 t on Weasel plus 2.5 t on sled</b>	<b>M29 Weasel (open cab) (3)</b>	<b>6</b>	<b>7 t to Advance Base. Max cruise speed 15 km/h</b>	<b>11, 13, 14</b>
	<b>Maudheim to Advance Base and return</b>	<b>Dec 4, 1950 Dec 8, 1950</b>	<b>5</b>	<b>600</b>	<b>120</b>	<b>Additional supplies to Advance Base depot</b>	<b>200 kg on first Weasel plus 2.5 t on sled. 300 kg on second Weasel plus 1700 kg on sled.</b>	<b>M29 Weasel (open cab) (2)</b>	<b>6</b>		<b>11, 13, 14</b>
	<b>Maudheim to 200 km out towards Advance Base and return</b>	<b>Sep 30 1951 Oct 10 1951</b>	<b>11</b>	<b>400</b>	<b>36</b>	<b>Depot refresh</b>	<b>Not described</b>	<b>M29 Weasel (open cab) (2)</b>	<b>3</b>	<b>Six breakdowns during trip</b>	<b>11, 13, 14</b>
	<b>Maudheim to 74.3 S, 0.8 E and return</b>	<b>Oct 18, 1951 Jan 7, 1952</b>	<b>82</b>	<b>1240</b>	<b>15</b>	<b>Seismic Studies</b>	<b>2.5 t per Weasel. Depots used for resupply enroute</b>	<b>M29 Weasel (open cab) (2)</b>	<b>3</b>	<b>One Weasel abandoned</b>	<b>11, 13, 14</b>
<b>IGY-US</b>	<b>Little America to Byrd Station</b>	<b>Jan 28, 1957 Feb 27, 1957</b>	<b>31</b>	<b>1041</b>	<b>34</b>	<b>Glaciology and Seismic Studies; Test traverse procedures</b>		<b>Tucker SnoCat 743 (3)</b>	<b>4 Scientists + 1 Support</b>		<b>2, 8, 12</b>

Expedition Title	Traverse	Dates	Days	Distance (km)	Speed Made Good (km/day)	Purpose	Load	Vehicle (number of vehicles)	Crew	Notes	Ref.
	Ross Ice Shelf from Little America	Oct 24, 1957 Feb 13, 1958	113	2333	21	Glaciology and Seismic Studies	1045 kg (crew + cargo) plus 2.5 t towed per SnoCat	Tucker SnoCat 743 (3)	6 Scientists + (?) support	Max distance without support 500 km. Air support for fuel drops.	2, 8
	Byrd Station	Nov 19, 1957 Feb 23, 1958	96	1931	20	Glaciology and Seismic Studies	1045 kg (crew + cargo) plus 2.5 t towed per SnoCat	Tucker SnoCat 743 (3)	5 Scientists + 1 support	Max distance without support 500 km. Air support for fuel drops.	2, 8
	Ellsworth Station to 78 40 S, 69 W	Oct 28, 1957 Jan 17, 1958	82	1313	16	Glaciology and Seismic Studies	1045 kg (crew + cargo) plus 2.5 t towed per SnoCat	Tucker SnoCat 743 (3)	5 Scientists + (?) support	Air support to plot initial path through crevasse region. Crew exchanged at end point via airlift. Relief crew cached all for next year.	2, 8
Wilkes Station Support	Wilkes Station to Vanderford Glacier & Return	Oct 14, 1957 Jan 4, 1958	-	80	-	Study of glacier properties and features					10, 12

Expedition Title	Traverse	Dates	Days	Distance (km)	Speed Made Good (km/day)	Purpose	Load	Vehicle (number of vehicles)	Crew	Notes	Ref.
	Wilkes Station to Cape Poinsett & Return	Nov 24, 1957 Jan 19, 1958	-	250	-	Seismic Studies					10, 12
	Wilkes Station to Site 2 & Return	Jan 24, 1958 Mar 1, 1958	-	170	-	Seismic Studies				Multiple trips to set up and operate at S2 Station.	10, 12
South Pole – Queen Maud Land Traverse I	South Pole to Pole of Relative Inaccessibility (PoRI)	Dec 4, 1964 Jan 28, 1965	54	1520	28	geophysical glacial meteorological	18000 kg total 5500 kg fuel 900 kg food	Tucker Sno-Cat 843 (2) Tucker Sno-Cat 742 (1)	8 Scientists + 2 Support	One airdrop for fuel.	5, 6, 8, 10
South Pole – Queen Maud Land Traverse II	Pole of Relative Inaccessibility to Plateau Station	Dec 15, 1965 Jan 29, 1966	45	1343	30	geophysical glacial meteorological	18000 kg total 5500 kg fuel 900 kg food	Sno-Cat 843 (2) Sno-Cat 742 (1)	8 Scientists + 3 Support	Two airdrops for fuel. One airdrop for spare parts.	5, 6, 8, 10
South Pole – Queen Maud Land Traverse III	Plateau Station to 78.70S, 6.87E	Dec 5, 1967 Jan 26, 1968	53	1556	29	geophysical glacial meteorological	18000 kg total 5500 kg fuel 900 kg food	Sno-Cat 843 (2) Sno-Cat 742 (1)	8 Scientists + 1 Support	Three airdrops for fuel and supplies.	5, 6, 8, 10
Norwegian-American Scientific Traverse of East Antarctica	Troll Station to (near) South Pole	Nov 16, 2007 Jan 14, 2008	60	2176	36	geophysical glacial meteorological	Two sledges / vehicle	Berco TL-6 (4)	7 Scientists + 5 Support	Avg. cruise speed: 10 km/h Depot fuel (between 122 and 155 drums total).	1, 4, 7

Expedition Title	Traverse	Dates	Days	Distance (km)	Speed Made Good (km/day)	Purpose	Load	Vehicle (number of vehicles)	Crew	Notes	Ref.
	South Pole to coastal loading point for Troll Station	Dec 23, 2008 Feb 16, 2009	56	2166	39	geophysical glacial meteorological	Two sledges / vehicle	Berco TL-6 (4)	7 Scientists + 5 Support	Avg. cruise speed: 10 km/h Depot fuel (72 + 25 drums).	1, 4, 7
Princess Elisabeth Station (PES) Construction Support	PES to Coast depot and return (16 construction + 2 fuel trips)	Dec 18, 2007 Feb 9, 2008	2 (per trip)	360 (per round trip)	180	Bulk delivery of station elements	Sledges (2 per Prinoth) carrying primarily ISO containers	Prinoth "Everest Power Antarctic" (3)	2 per Prinoth	Depots every 45 km. Avg. cruise speed 15 km/h. Each 360 km round trip required 40 hours driving time (average)	3, 9

1. Albert, Mary (August 2009). Transcript from workshop presentation documented in this report.
2. Anon. (April 1958). "IGY Antarctic Oversnow Traverses", IGY Bulletin, National Academy of Sciences, Washington DC, Number 10 (April 1958).
3. Anon. (accessed 2009-2010). Information gathered from various pages at this web site: <http://www.antarcticstation.org/>
4. Anon. (accessed 2010). Information gathered from various pages at this web site: <http://www.travers.npolar.no/>
5. Anon. (accessed 20 March 2010). Information gathered from various pages at this web site: <http://traverse.npolar.no/historical-traverses/pole-of-inaccessibility>
6. Anon. (accessed 20 March 2010). Information gathered from various pages at this web site: <http://traverse.npolar.no/historical-traverses/us-traverses>
7. Anon. (accessed 2010). <http://www.polarareet.no/filearchive/Traverse.pdf>
8. Bentley, Charles (August 2009). Transcript from workshop presentation documented in this report.
9. Berte, Johan (August 2009). Transcript from workshop presentation documented in this report.
10. Cameron, Richard (August 2009). Transcript from workshop presentation documented in this report.
11. Giaever, John (1954). *The White Desert*, Dutton & Co., New York.
12. Goldthwait, Richard P. (December 1958). USNC-IGY Antarctic Glaciological Data Field Work 1957 and 1958, Report 825-1, The Ohio State University Research Foundation, Columbus, Ohio.
13. Swithinbank, Charles (1999). *Foothold on Antarctica*, The Book Guild Ltd., Sussex, England.
14. Swithinbank, Charles (August 2009). Transcript from workshop presentation documented in this report.

THIS PAGE INTENTIONALLY BLANK

## 5 WORKSHOP ACTIVITIES AND OBSERVATIONS

As discussed in Section , this workshop was a 2-day event. The first day was devoted to a series of invited presentations. The second day was devoted to a series of facility tours and focused discussions intended to give the invited speakers a better understanding of the process being used by NASA to prepare for future planetary surface activities and traverse. This also provided NASA personnel with an opportunity to hold direct and more focused discussions with these invited speakers regarding their experiences as they apply to these future missions and traverses. This section will summaries these activities and discussions. In several cases these discussions have been collapsed into general observations about a particular topic.

### 5.1 Day One – Invited Presentations

Figure 5.1 is a photograph of those making presentations on the first day of this workshop. These presentations, along with a transcript of the oral descriptions, can be found in Appendix A of this report. Questions and discussion were allowed after each of these presentations. From these discussions and a conversation with the invited speakers following the presentations, the following observations were made:



**Figure 5.1: Conference Speakers**

Speakers making presentations at this workshop. Front row (l to r): Dr. Friedrich Horz, Dr. Mary Albert, Dr. Marie-Claude Williamson, Dr. Richard Cameron. Back row (l to r): Dr. Stephen Hoffman (workshop convener and speaker), Mr. Johan Berte, Dr. Charles Swithinbank, Dr. Charles Bentley, Mr. John Gruener. Not in this photograph: Dr. Gary Lofgren.

The invited participants' experience covers most of the options under consideration by NASA for future planetary exploration and traverses.

- Successful examples of fixed base operations (primarily Antarctic) and temporary/sortie operations (Antarctic and Arctic).
  - Durations ranging from a few days/weeks to more than 2 years.
  - Successful examples of the “Mobile Home” and “Commuter” approaches.
  - Vehicle crew complements ranging from two to four.
  - Traverse crew sizes ranging from three to 12.
- All crews in this “sample” were a mixture of research scientists and non-scientist support personnel, with an approximate ratio of 1:1.
  - Mixture of self-contained operations (i.e., the traverse teams function autonomously, sometimes out of direct contact with other team members or with a home institution, for days or weeks at a time) and “mission control” supported operations (i.e., in periodic contact with other stations that could provide support, both material and non-material, at intermediate points in a traverse).
  - In early Antarctic traverses, all crews were male only; in later traverses, crews were mixed gender. Several interesting approaches were discussed for handling the mixed gender makeup of the crews on later traverses (e.g., sleeping arrangements by personal habit rather than by gender: snoring/heavy sleepers in one space, non-snoring/light sleepers in a different space).
  - Adequate time and “comfortable” quarters allowed analyses to be made during some of these traverses, and thus the crews produced results in addition to gathering samples.
  - A comment made by several of the invited participants: missions lasting 2 or more years were entirely doable from crew perspective. This comment was also accompanied by the statement that this outcome required a crew personally invested in and committed to mission/science objectives.

## **5.2 Day Two – Facility Tours and Focused Discussion Groups**

During the second day of the workshop the invited speakers and other workshop participants visited the following locales at JSC and discussed topics associated with these specialized groups based on the presentations made on the first day of the workshop:

- Outdoor mobility test facility (a.k.a. the “Rock Yard”)
- Small pressurized rover development area (Building 9)
- Advanced Space Suit Development Laboratory (Building 34)
- Surface Habitation development facility (Building 220)
- Discussion of “strategic” and “tactical” science planning (Building 4S conference room)
- Constellation Program’s Lunar Surface Systems Project Office plans and potential collaboration opportunities (Building 1 conference room)
- Discussion of potential coordination between polar exploration organizations and NASA human spaceflight organizations (Building 1 conference room)

A brief description of the rationale for visiting each of the locales or for the group discussion is contained in the following sections. Major observations and comments from all the activities on the second day of the workshop are summarized in Section 5.3.



### 5.2.1 *Tour of the Outdoor Mobility Test Facility*

The JSC “Rock Yard” is a facility used to perform preliminary tests of candidate planetary surface systems. The purpose of this tour was to give the invited participants a better understanding of the testing process used to take hardware and operations into progressively more realistic environments. This tour was arranged with the assistance of Mr. Joe Kosmo, who has been one of the principal organizers of the NASA DRATS since their inception. Figure 5.2 shows several of the invited participants examining a portion of the “Rock Yard” constructed to simulate a portion of the surface of Mars. Figure 5.3 shows another of the invited participants examining the “cratered terrain” portion of the “Rock Yard” constructed to simulate a portion of the surface of the Moon.



**Figure 5.2: Hill at JSC Rock Yard**

The workshop participants in this photograph include (from left to right): Dr. Stephen Voels, Dr. Charles Bentley, Mr. Pat Rawlings, Mr. Sam Feola, Mr. Paul Thur, Dr. Mary Albert, and Mr. Johan Berte.



**Figure 5.3: Crater at JSC Rock Yard**

Dr. Marie-Claude Williamson examining the “cratered terrain” portion of the “Rock Yard.”

### ***5.2.2 Tour of the Small Pressurized Rover Development Facility***

Building 9 at JSC is the home of Space Shuttle and ISS training simulators. It is also the facility used to assemble and test concept vehicles intended to be used by astronauts to explore the surfaces of the Moon, Mars, and other solar system bodies. A small pressurized rover concept, known as the Lunar Electric Rover (LER) (now referred to as the Space Exploration Vehicle), was under development at the time of this workshop. The purpose of this tour was to give the invited participants the opportunity to interact directly with the team of engineers developing this vehicle, thus affording both groups the chance to understand the challenges faced by their counterparts and to exchange ideas that might overcome these challenges. This tour was arranged with the assistance of Mr. Rob Ambrose and was conducted by Mr. William Bluethmann, one of the principal engineers of this vehicle. Figure 5.4 and Figure 5.5 show Mr. Bluethmann explaining features of the small pressurized rover to several of the invited participants.



**Figure 5.4: Lunar Electric Rover (exterior)**

Mr. William Bluethmann (right) explains design features of the LER to some of the invited workshop participants; Mr. Johan Berte, Dr. Charles Swithinbank, and Dr. Mary Albert (from left to right).



**Figure 5.5: Lunar Electric Rover (interior)**

Mr. Sam Feola (at left; Raytheon Polar Services manager for the NSF Antarctic Services Contract) and Mr. William Bluethmann discuss interior accommodations and functions of the LER while seated in one of these vehicles.

### 5.2.3 *Tour of the Advanced Space Suit Development Laboratory*

Building 34 at JSC is the home of advanced space suit development and the DRATS. Personnel working in this facility are central to the development of the space suit garments (the life support backpack is developed elsewhere) as well as the tools and equipment that will be used to explore the surface of other planets. The purpose of this tour was to give the invited participants the opportunity to interact directly with the team of engineers developing the pressurized garments that future crews must use when exploring other planets as well as the tools they will use to assist them in this exploration. Such an interaction was assumed to afford both groups the chance to understand the challenges faced by their counterparts and to exchange ideas that might overcome these challenges. This tour was arranged with the assistance of Mr. Joe Kosmo and was conducted by Mr. Kosmo and Mr. Jesse Buffington. Figure 5.6 and Figure 5.7 show several of the invited participants experiencing the challenges of manipulating objects, such as hand tools, while using a pair of pressurized gloves as well as examining pressure garments designed for planetary surface exploration. Figure 5.8 and Figure 5.9 show some of the invited participants examining the detailed features of pressure garments under study to help develop future surface exploration suits.



**Figure 5.6: EVA Glove Demonstration Facility**

Dr. Charles Bentley (at left) experiences the dexterity of EVA gloves when a pressure differential comparable to that of a space mission is applied to these gloves.



**Figure 5.7: Manipulating Common Objects using EVA Gloves**

Dr. Mary Albert (center) experiences the dexterity of EVA gloves when a pressure differential comparable to that of a space mission is applied to these gloves. Mr. Paul Thur (at left; Traverse Manager for Raytheon Polar Services) and Dr. Marie-Claude Williamson (at right) observe.



**Figure 5.8: Mark III EVA Suit Entry Hatch**

Mr. Johan Berte examines interior features of the experimental Mark III EVA suit.

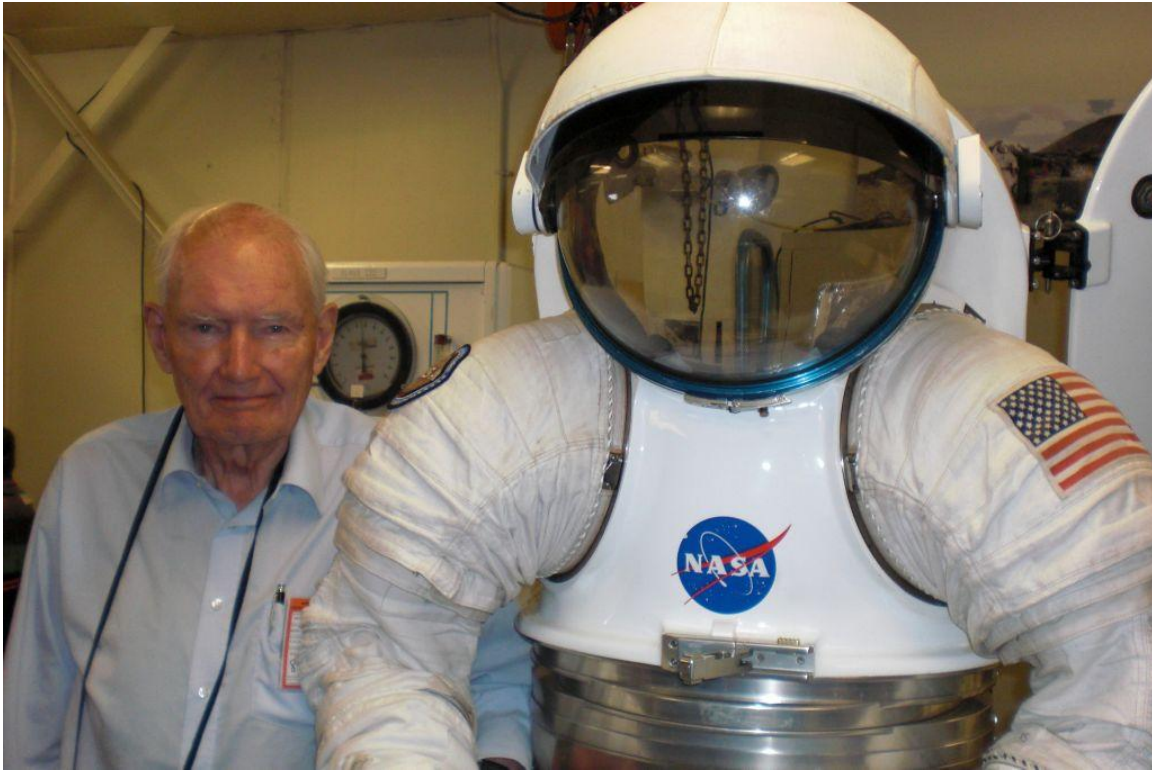
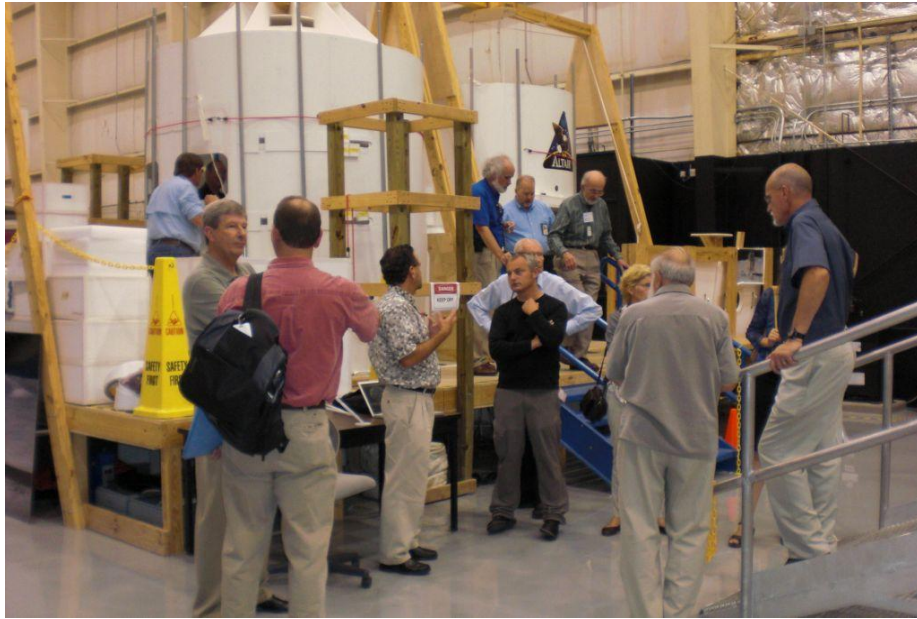

**Figure 5.9: Mark III EVA Suit Upper Torso and Helmet**

Dr. Charles Swithinbank examines details of the experimental Mark III EVA suit designed for operation on planetary surfaces.

#### ***5.2.4 Tour of the Surface Habitation Development Facility***

Building 220 at JSC is the facility used to build full-scale habitat mock-ups of varying fidelity to test different configurations and internal outfitting. The purpose of this tour was to provide the invited participants with an opportunity to interact directly with the team of architects and engineers developing pressurized habitats that could be used by future astronaut crews when exploring other planets. As with earlier tours, this interaction was assumed to afford both groups the chance to understand the challenges faced by their counterparts and to exchange ideas that might overcome these challenges. This tour was arranged with the assistance of Mr. Larry Toups and Mr. Terry Tri; both of these gentlemen conducted the tour of this facility and held discussions with the invited participants. Figure 5.10 shows several of the invited participants discussing features of one of the full-scale mock-ups in this facility. Figure 5.11 shows two other habitat mock-ups examined during this tour.



**Figure 5.10: Small Habitat Mock-ups**

A discussion of habitable volume likely to be available to future astronaut crews. On the platform in the center of this photo (left group; from left to right): Dr. Stephen Hoffman, Mr. Terry Tri (NASA/JSC Manager, Lunar Surface Analogs Project), and Dr. Charles Bentley. In the foreground (left to right): Mr. Sam Feola, Dr. Dale Anderson, Mr. Larry Toups (NASA/JSC Lead for Habitation Systems), Mr. Johan Berte, Dr. Charles Swithinbank (directly behind Mr. Berte), Dr. Marie-Claude Williamson, Dr. Richard Cameron, and Mr. Pat Rawlings (on stairs).



**Figure 5.11: Large Habitat Mock-ups**

Another example of the habitat mock-ups examined by the workshop participants. In the foreground of this view is a representative horizontal cylindrical configuration. To the right (and just barely visible in this view) is a vertical cylindrical configuration.

### 5.2.5 Focused Discussion Groups

Three focused discussions were arranged for the afternoon of the workshop’s second day. The topics for each of these discussions were:

- (1) “Tactical” (i.e., day-by-day) planning of science activities compared with “strategic” planning (i.e., planning for several weeks or months to address a specific question or related set of questions),
- (2) Plans being made by the NASA Lunar Surface Systems Project Office and potential collaboration opportunities, and
- (3) Commonalities and potential collaboration opportunities between the NASA human spaceflight community and the polar exploration community.

The purpose for each of these discussions was to use the presentations as the basis for a more focused discussion about each of these topic areas than could be achieved on the first day of this workshop. Those attending the first day of the workshop plus other interested individuals at JSC were invited to attend these discussions. The following individuals attended at least one of these focused discussion sessions.

**Table 5.1: List of Discussion Participants**

Name	Affiliation	Name	Affiliation
Mary Albert	Dartmouth College	Fred Horz	NASA Johnson Space Center
Dale Andersen	Carl Sagan Center	Gary Lofgren	NASA Johnson Space Center
Charles Bentley	University of Wisconsin	Don Petit	NASA Johnson Space Center
Johan Berte	International Polar Foundation	Pat Rawlings	SAIC
Karin Blank	NASA Goddard Space Flight Center	James Rice	Arizona State University
Jacob Bleacher	NASA Goddard Space Flight Center	Gary Spexarth	NASA Johnson Space Center
Andy Cameron	Intelligent Land Management	Charles Swithinbank	Scott Polar Research Institute
Richard Cameron	National Science Foundation (retired)	Paul Thur	Raytheon Polar Services
Chris Culbert	NASA Johnson Space Center	Larry Touns	NASA Johnson Space Center
Dean Eppler	Science Applications International Corp.	Stephen Voels	Science Applications International Corp.
Sam Feola	Raytheon Polar Services	Brian Wilcox	Jet Propulsion Laboratory
Stephen Hoffman	Science Applications International Corp.	Marie-Claude Williamson	Canadian Space Agency



### 5.3 Observations and Comments from Workshop Participants

Comments and observations made during the facility visits and focused discussions conducted on the second day of the workshop have been consolidated and summarized in this section:

- During various discussions of how much “personal space” (i.e., floor space or total volume) should be allowed for “personal space,” several of the invited participants noted that “personal space” is more a matter of privacy (or isolation) than a minimum amount of floor space or volume. Dr. Swithinbank noted that his “personal space” allocation during his 2-year mission was approximately 1.5 by 2 meters (~5 by 6.5 feet) and he could stand up in this area; he found this to be adequate.
- Dr. Bentley commented that he found the internal volume of the LER, by itself, to be too small for more than a few days. His experience with similar sized vehicles in the Antarctic was that they were frequently working outside for extended periods, which made the interior volume less of a factor. He could not comment on whether frequent EVAs from the LER would have a similar effect. (Observation by S. Hoffman: *this comment by Dr. Bentley may be more important as a consideration for the capabilities of the EVA system – the frequency, duration, and ease of donning/doffing the equipment – than the interior size of a pressurized rover.*) In contrast, Dr. Swithinbank commented that in his opinion the internal volume of the LER seemed adequate for the kinds of traverses described.
- Numerous comments were made during discussion held in the Advanced Space Suit Development Laboratory. A typical example was a discussion regarding the continued use of rock hammers and other EVA tools observed in this Development Laboratory that have the potential to throw debris in random directions. Such flying debris could impose additional design factors on the EVA suits that might be otherwise avoided. With the assumption of power tools in the EVA tool catalog, it might make more sense to use a version of these tools to accomplish the same desired result, such as removing surface rind in a more controlled manner or to acquire samples that are of a uniform size and shape (e.g., using a hand-held coring drill to acquire uniform rock samples). This would remove the need tools, such as the rock hammer, and the associated requirements (to protect EVA equipment from crew-generated flying debris).
- The “polar” community was surprised at the apparent lack of on-site authority to adapt the scientific investigations being planned for the scientist/PI on planetary missions (based on an assumed projection of the practices they heard about in presentations or discussed in the focused discussion groups) or that the PI may not even be member of crew.
- The “polar” community observed that the range and duration postulated for these future missions would, in their experience, argue for at least some of the crew members to be highly experienced field scientists. This would be comparable to the current practice of selecting individuals destined to become “pilot” astronauts with a significant number of flight hours in high performance aircraft. One suggested approach for implementation would be to acknowledge that the desired skill mix for these future exploration crews includes experienced field scientists. Accompanying this acknowledgement would be an announcement that one of the selection criterion for these “scientist” astronauts would be a significant number of hours spent in diverse field locations relevant to their particular science discipline. This would help incentivize young scientists considering an astronaut career to invest the time and effort to develop this aspect of their experience base.

- There seemed to be general agreement among the invited participants that it was more effective to go into greater depth in a limited range of scientific investigations rather than trying to cover a broad range of investigations with a limited ability to carry out any of these investigations at much depth.
- There were a several areas in which the “space” community and the “polar” community had what was considered very similar technology needs, including:
  - Efficient power generation and utilization
  - Non-petroleum based power generation,
  - Water utilization and reuse,
  - Information technologies, including on-site information utilization and communications with a “home institution,”
  - Robotic/automated support,
  - Waste reduction/elimination,
  - Streamlining/minimizing logistics/supply chain.
- Both the “space” community and the “polar” community were (pleasantly) surprised at degree of commonality between the two programs and that this commonality could form the basis for expanded interaction between these exploration communities. “Commonality” in this usage means:
  - Physical/operational/logistical challenges,
  - Size and duration of teams in the field,
  - Science/research objectives as a mission/traverse driver,
  - Crew size, skill mix, training needs (there are probably others; these are the topics that were captured).

## 6 CONCLUSIONS AND RECOMMENDATIONS

This workshop and a previous workshop (Hoffman, 2002 examining the similarities of space and polar exploration both indicate highly parallel activities and functional needs. However, it was also recognized during the course of this workshop that NASA's current approach for long-duration planetary surface operations has fundamental differences from any of the operational approaches described by the invited speakers. Choices made regarding these approaches drive the crew size and skill mix, as well as the system capabilities, needed to accomplish basic mission objectives. These, in turn, drive the logistical pyramid needed to support operations.

Therefore, a general recommendation from this workshop is that interaction between these two exploration communities should continue with both informal and more formalized events. Those representing both sides of this interaction (i.e., the polar traverse community and the planetary surface traverse community) reached a general agreement that there were lessons to be learned by both sides, but there is more work yet to be done in order to communicate and determine how best to take advantage of these lessons.

Six specific recommendations stemming from these general recommendations and from discussions held by workshop participants include:

1. Annual or biannual workshops to review NASA analogs and NSF polar activities (emphasis on activities of similar scope/scale); other agencies or organizations would be invited as appropriate. A workshop held in October or April would avoid overlap with the NSF Antarctic season and NASA analog season. Another option would be to coordinate this event with another major meeting typically attended by one or the other of these exploration communities (examples include the meeting of the Scientific Committee for Antarctic Research (SCAR) or the SCAR's SCALOP Symposium or the annual Earth and Space conference sponsored by the ASCE).
2. Personnel from large government agencies or other organizations, such as the NSF and NASA, involved in relevant field activities should invite appropriate counterparts to participate in these field activities where possible.
3. Detailed, independent assessments of the operational approaches used by the organizations represented in this workshop (and similar groups not represented) to understand differentiating factors. Results of these assessments should then be made available to those personnel responsible for developing planetary surface operational concepts so they can decide what features (if any) used by these other organizations should be incorporated into its current approach to planetary surface exploration.
4. Review historical and current data sets that can be mined for information regarding logistics, heated volume (as a surrogate for pressurized volume), functional space utilization, energy requirement, etc. that can be used to develop mathematical models for these aspects of a surface mission or traverse. These data could reside with both governmental and nongovernmental organizations, indicating that contacts should be developed with both organizational types.
5. Review data from "case studies" describing crew skill mix and leadership approach used in polar exploration. Examples of successful and unsuccessful approaches exist and should be part of this assessment. One primary feature of this assessment could be a set of criteria to be used to determine the appropriate crew mixture of "professional astronaut" and "professional research scientist", an approximate description of the major skill sets used in polar scientific exploration

teams. Continuing this line of reasoning, these results could also be used to determine the skill/training requirements for these two broad categories of crew members as well as examining the functional requirement implications resulting from this approach to crew make up.

6. Finally, investigate the benefits of joint operations of pertinent surface exploration activities and advanced systems by large government agencies or other organizations, such as the NSF and NASA. Benefits of this strategy could be:
  - a. Higher TRL technology test beds and higher fidelity analog tests for NASA
  - b. Access to more advanced technologies for “polar” exploration community
  - c. Joint contributions to advancing scientific knowledge and technology state of the art

## 7 REFERENCES

- Anon. (April 1958). "IGY Antarctic Oversnow Traverses", IGY Bulletin, National Academy of Sciences, Washington DC, Number 10.
- Anon. (June 2004). A Journey to Inspire, Innovate, and Discover: Report of the President's Commission on Implementation of United States Space Exploration Policy, The Office of the President of the United States, Washington, DC.
- Anon. (August 2004). Development and Implementation of Surface Traverse Capabilities in Antarctica: Comprehensive Environmental Evaluation, National Science Foundation, Washington, DC.
- Anon. (March 2007). Construction and Operation of the New Belgian Research Station, Dronning Maud Land, Antarctica: Final Comprehensive Environmental Evaluation Report, Belgian Federal Science Policy Office (Belspo), Brussels, Belgium.
- Congress of the United States (30 December 2005). NASA Authorization Act of 2005 (Public Law 109-155), Washington, DC.
- Drake, Bret G. (July 2009a). Human Exploration of Mars, Design Reference Architecture 5.0, NASA/SP-2009-566, National Aeronautics and Space Administration, Washington, DC.
- Drake, Bret G. (July 2009b). Human Exploration of Mars, Design Reference Architecture 5.0 Addendum, NASA/SP-2009-566-ADD, National Aeronautics and Space Administration, Washington, DC.
- Giaever, John (1954). The White Desert, Dutton & Co., New York.
- Goldthwait, Richard P. (December 1958). USNC-IGY Antarctic Glaciological Data Field Work 1957 and 1958, Report 825-1, The Ohio State University Research Foundation, Columbus, Ohio.
- Hoffman, Stephen J. ed. (2002). Antarctic Exploration Parallels for Future Human Planetary Exploration: A Workshop Report, NASA/TP - 2002 - 210778, National Aeronautics and Space Administration, Washington, DC.
- Swithinbank, Charles (1999). Foothold on Antarctica, The Book Guild Ltd., Sussex, England.
- Von Braun, Wernher (1962). The Mars Project, University of Illinois Press, Urbana, Illinois.

## 8 ADDITIONAL RESOURCES

Internet Web Sites accessed:

- [antarcticstation.org](http://antarcticstation.org)
- [berco.nu](http://berco.nu)
- [cspg.org/events/luncheons/2005/20050922-kerr.pdf](http://cspg.org/events/luncheons/2005/20050922-kerr.pdf)
- [ess.nrcan.gc.ca/scient\\_e.php](http://ess.nrcan.gc.ca/scient_e.php)
- [fimbul.npolar.no](http://fimbul.npolar.no)
- [fimbul.npolar.no/en/nare0910/expedition-diary/entries/28\\_november.html](http://fimbul.npolar.no/en/nare0910/expedition-diary/entries/28_november.html)
- [nas.edu/history/igy/](http://nas.edu/history/igy/)
- [ngdc.noaa.gov/mgg/bathymetry/arctic](http://ngdc.noaa.gov/mgg/bathymetry/arctic)
- [polar.nrcan.gc.ca](http://polar.nrcan.gc.ca)
- [polar.nrcan.gc.ca/about/history\\_e.php](http://polar.nrcan.gc.ca/about/history_e.php)
- [polar.nrcan.gc.ca/about/manual/pdf/operations\\_manual\\_e.pdf](http://polar.nrcan.gc.ca/about/manual/pdf/operations_manual_e.pdf)
- [polararet.no](http://polararet.no)
- [polararet.no/filearchive/Traverse.pdf](http://polararet.no/filearchive/Traverse.pdf)
- [prinoth.com](http://prinoth.com)
- [thecanadianencyclopedia.com/index.cfm?PgNm=TCE&Params=A1ARTA0001490](http://thecanadianencyclopedia.com/index.cfm?PgNm=TCE&Params=A1ARTA0001490)
- [traverse.npolar.no](http://traverse.npolar.no)
- [traverse.npolar.no/historical-traverses/pole-of-inaccessibility](http://traverse.npolar.no/historical-traverses/pole-of-inaccessibility)
- [traverse.npolar.no/historical-traverses/us-traverses](http://traverse.npolar.no/historical-traverses/us-traverses)
- [www.belspo.be/belspo/bepoles/doc/final\\_CEE\\_en.pdf](http://www.belspo.be/belspo/bepoles/doc/final_CEE_en.pdf)
- [www.spri.cam.ac.uk](http://www.spri.cam.ac.uk)
- [www.spri.cam.ac.uk/resources/expeditions/nbsx/](http://www.spri.cam.ac.uk/resources/expeditions/nbsx/)

## **APPENDIX A: PRESENTATIONS**

This appendix contains a “loose” transcript of the presentations and the slides presented.

## **A1 – Presentation of Stephen J. Hoffman**

### ***Antarctic Exploration Parallels for Future Human Planetary Exploration: Science Operations Lessons Learned, Planning, and Equipment Capabilities for Long Range, Long Duration Traverses***

[Slides 2 – 3] The purpose for this workshop can be summed up by the question: Are there relevant analogs to planetary (meaning the Moon and Mars) to be found in polar exploration on Earth?

The answer in my opinion is “yes” or else there would be no reason for this workshop.

However, I think some background information would be useful to provide a context for my opinion on this matter. As all of you are probably aware, NASA has been set on a path that, in its current form, will eventually lead to putting human crews on the surface of the Moon and Mars for extended (months to years) in duration. For the past 50 – 60 years, starting not long after the end of World War II, exploration of the Antarctic has accumulated a significant body of experience that is highly analogous to our anticipated activities on the Moon and Mars. This relevant experience base includes:

- Long duration (1 year and 2 year) continuous deployments by single crews,
- Established a substantial outpost with a single deployment event to support these crews,
- Carried out long distance (100 to 1000 kilometer) traverses, with and without intermediate support
- Equipment and processes evolved based on lessons learned
- International cooperative missions

This is not a new or original thought; many people within NASA, including the most recent two NASA Administrators, have commented on the recognizable parallels between exploration in the Antarctic and on the Moon or Mars. But given that level of recognition, relatively little has been done, that I am aware of, to encourage these two exploration communities to collaborate in a significant way.

[Slide 4] I will return to NASA’s plans and the parallels with Antarctic traverses in a moment, but I want to spend a moment to explain the objective of this workshop and the anticipated products. We have two full days set aside for this workshop. This first day will be taken up with a series of presentations prepared by individuals with experience that extends back as far as the late 1940s and includes contemporary experience. The people presenting bring a variety of points of view, including not only U.S. but international, although most, if not all, have collaborated on international teams. The second day will consist of a series of small focused group interactions centered on those elements likely to be needed for traverse missions, such as mobility, habitation, and extravehicular activity (EVA, aka space suits). Our invited participants will be talking with people that specialize in these elements so that we can foster more direct interaction and exchange of experiences between these two exploration communities. After the workshop we will be preparing a report documenting these presentations and the essence of the focused interactions.

[Slides 5] Returning now to the exploration of the Moon and Mars in general and traverses in particular, this has been an active area of (non-science fiction) discussion going all the way back to the mid-1950s. Unfortunately, with the exception of Apollo, we have not gotten much closer to realizing them. What is different about the current situation compared to most of the past attempts at something similar is that these general objectives have been documented as public policy by the White House and codified into law



by the U.S. Congress. The first step in the current process – retiring the Space Shuttle and building its replacement – is already well under way.

A key difference in this environment is that future lunar and Mars missions will differ from what you probably remember from the Apollo missions in that they will last longer – from about a week to a couple of years (for reference the longest time spent on the lunar surface during an Apollo mission was about 72 hours). The lunar missions in this new era are likely to start with about a one-week duration and gradually grow to about 6 months between crew rotations at a single surface facility. Early lunar missions may visit different surface locations but the goal is to build up a single, continuously occupied facility, much as the International Space Station is continuously occupied now, with regularly scheduled crew rotations. Mars missions (i.e., the round-trip flight of a single crew of six people) on the other hand will last approximately 3 years in total duration, with about 18 months of that time spent on the surface. This is dictated by orbit mechanics and the current state of our rocket propulsion technology. Orbit mechanics also dictate that these launch opportunities occur at intervals such that it will not be possible for one crew to overlap on the surface of Mars with the next crew. But given that each crew will spend 18 months at a given site, current plans do not call for subsequent crews to return to the same location on the Martian surface, at least for the first several missions.

[Slides 6 – 7] The next two charts illustrate the similarity between the hardware elements needed for lunar and Mars exploration as we currently understand them. There is some reasonable rationale to sending human crews to the Moon before going on to Mars. This is driven in large part to building confidence in operations and equipment in smaller steps before taking some very large steps. Opportunities to launch crews to the Moon occur approximately once per month while opportunities to launch crews to Mars occurs approximately once every 26 months. Thus if there are reasons to delay a lunar mission the Program suffers a delay lasting just a few months compared to a minimum of 2-year delay for a missed Mars mission. Opportunities to return to Earth from the Moon are similarly more frequent. The specific interval is, again, orbit mechanics dependent but is no more than 1 month in duration. These factors allow equipment and operations to be tried in a similar situation and environment but without the multi-year commitment should any aspect of the equipment or operations be flawed.

For both lunar and Mars missions it is anticipated that both crew and robotic equipment, which could arrive on different vehicles, will land in a fairly benign location. But “benign” can also translate into “uninteresting” from a scientific or exploration perspective, resulting in the crew exhausting the scientific potential of a particular site before returning to Earth. This is especially true for Mars mission crews who will spend 18 months at a given location. This is not to imply that missions cannot land at more interesting, but also more challenging, landing sites; Apollo missions evolved from the very flat Apollo 11 site to the relatively challenging sites for Apollo’s 15, 16, and 17. But providing a capability to move long distances across the surface removes the need to risk a landing at a more challenging surface location. Hence the interest in a surface traverse.

[Slides 8 – 10] These next three charts illustrate the kinds of ranges and types of features that we may wish to explore from one of these “benign” landing sites on the Moon and Mars.

[Slide 11] There is one other aspect of future lunar and Mars missions that has an extensive experience base in Antarctic traverse – drilling. There is limited experience with this exploration tool during Apollo (and some Soviet robotic) mission and, so far, none on Mars. Exploring the subsurface of both the Moon and Mars will be a key feature of these future missions. Most of our invited Antarctic speakers have direct experience with this exploration tool.

[Slides 12 – 13] So what kind of Mars mission are we talking about? These two charts show the ground rules and study results from the most recent effort by a NASA team to capture the desires of the science/exploration community and translate them into a technically feasible approach. This can be considered the large end of the scale for future human missions: 6 crew spending almost 18 months on the surface of Mars.

[Slide 14] There are several Antarctic cases that are analogous to this – we have several speakers here today that have lived through those experiences, including the Norwegian-British-Swedish expedition (NBSX) of 1949 – 1952. Here is a comparison of several of the key features of these missions.

[Slides 15 – 16] There are also Antarctic cases that are at the small end of the scale, one of which is called ANSMET. These two charts describe this Antarctic mission and provide a comparison with Apollo activities on the Moon.

[Slide 17] And finally, the long traverse. Several nations currently active in the Antarctic regularly use long, unsupported traverse to achieve a variety objectives in this environment. These are the type of experiences we plan to discuss in this workshop.

[Slide 18] This should give you an idea of the “playing field” we are working in and the general evolution of the thinking of the NASA community that I work in, namely that: (a) Mars missions will be relatively infrequent and very long duration (by NASA standards) with no opportunity for resupply or for relief should something go wrong; (b) the Moon provides an equally challenging situation in which to build confidence in equipment and operations but over shorter durations while still accomplishing important scientific investigations; and (c) surface traverse offers a means to investigate many interesting sites from a single, “safe” landing site.

So NASA has embarked on planning for these surface bases and for a key capability of traversing across the surface for potentially long distances and extended periods of time from the landing site. It is my opinion, reinforced by the workshop we did in 2001 (NASA/TP–2002–210778, [Antarctic Exploration Parallels for Future Human Planetary Exploration: A Workshop Report](#)), that the accumulated experience exploring the polar regions is something that NASA should mine for the guidance it can provide in this new planning process. So what I called "lessons" in my workshop invitation are most likely things our invited speakers do not spend any time thinking about any more, things they just do because they know they work. There is probably not a one-to-one correspondence between what the invited speakers have done and what NASA is attempting to do on the Moon and Mars but a dialog about the invited speakers' experience and what NASA is thinking about doing on these planets should help these NASA folks figure out what should be their best course of action.

This chart shows the agenda we have set up for the remainder of today and will be the starting point for our dialog between these two exploration communities.



# Antarctic Exploration Parallels for Future Human Planetary Exploration: Science Operations Lessons Learned, Planning, and Equipment Capabilities for Long Range, Long Duration Traverses

4 August 2009

Stephen J. Hoffman, Ph.D.  
NASA/Johnson Space Center

Aug 4, 2009

Surface Mission Option Descriptions – V5

1



## Are There Relevant Analogs to Planetary Science Traverses in Polar Exploration?

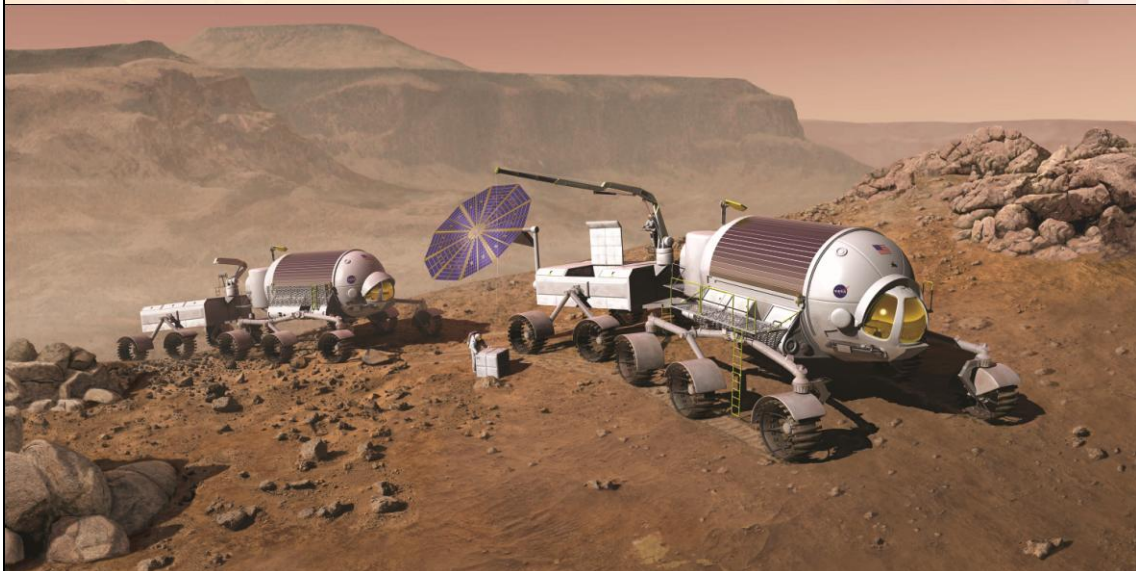

Aug 4, 2009

Surface Mission Option Descriptions – V5

2



## There Are Relevant Analogs in Polar Exploration

- **Antarctic exploration has accumulated 50+ years of experience that is an excellent analog for lunar and Mars missions**
  - Long duration (1 yr and 2 yr) deployment
  - Established outposts with a single deployment
  - Long distance (100 – 1000 km) traverses
  - Built on evolved processes and lessons learned
- **Prior NASA Administrators have on more than one occasion compared planetary exploration to Antarctic exploration**

Aug 4, 2009

Surface Mission Option Descriptions – V5

3



## Objectives and Products

- **Workshop Objective:**
  - **Present an overview of 50+ years of Arctic and Antarctic scientific traverse experience and discuss the relevance to the NASA Constellation Program planning and testing activities**
    - Lessons learned in science operations, traverse planning, and logistics
    - Evolution of what can and cannot (should not) be accomplished on traverse
    - Implications of equipment and crew capabilities on science operations during traverse
  - **External presentations provided by**
    - Several consultants with experience extending back to Antarctic traverses in the 1950s
    - NSF Office of Polar Programs personnel and contractors
    - Army Corps of Engineers/Cold Regions Research and Engineering Laboratory (ACE/CRREL) personnel
    - Canadian Space Agency personnel
- **Products**
  - **Workshop report documenting science operations lessons learned from Arctic and Antarctic traverse experience**
  - **Document interaction between science operations objective, equipment capabilities, crew capabilities and logistics for use by LSS and any Mars-forward planning**

Aug 4, 2009

Surface Mission Option Descriptions – V5

4



## A Bold Vision for Space Exploration, Authorized by Congress

- Complete the International Space Station
- Safely fly the Space Shuttle until 2010
- Develop and fly the Crew Exploration Vehicle no later than 2014 (goal of 2012)
- Return to the Moon no later than 2020
- Extend human presence across the solar system and beyond
- Implement a sustained and affordable human and robotic program
- Develop supporting innovative technologies, knowledge, and infrastructures
- Promote international and commercial participation in exploration



### NASA Authorization Act of 2005

The Administrator shall establish a program to develop a sustained human presence on the Moon, including a robust precursor program to promote exploration, science, commerce and U.S. preeminence in space, and as a stepping stone to future exploration of Mars and other destinations.

Aug 4, 2009

Surface Mission Option Descriptions – V5

5

## Lunar Surface Architecture

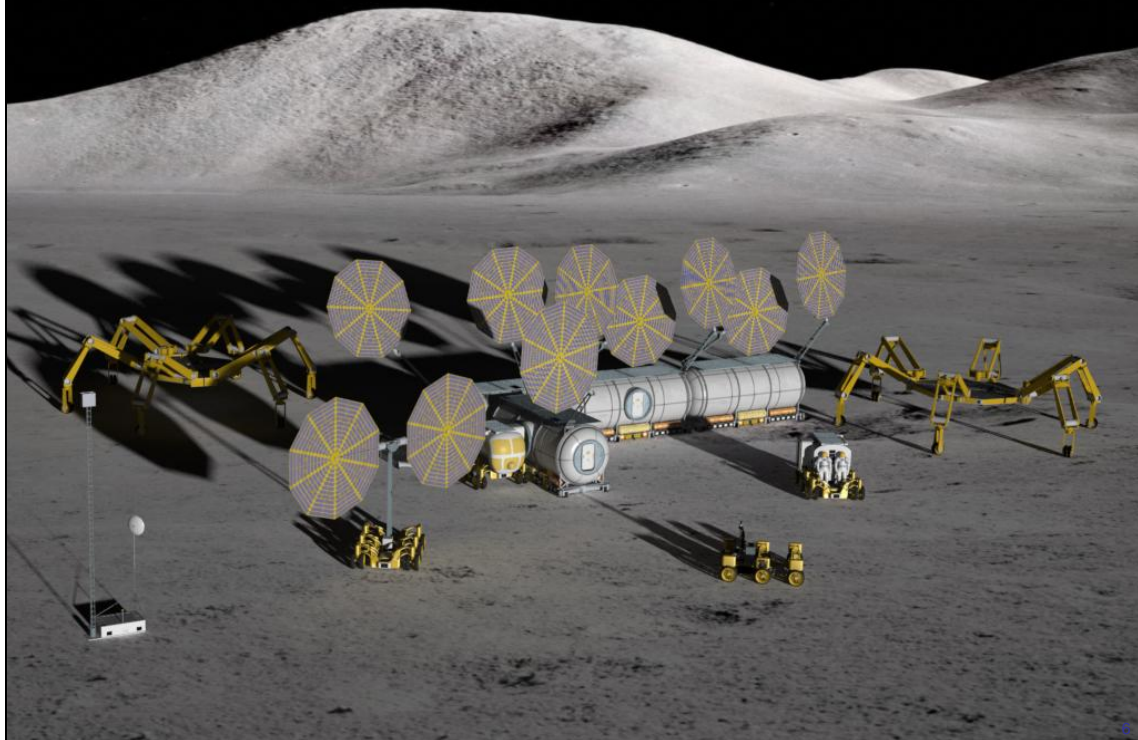

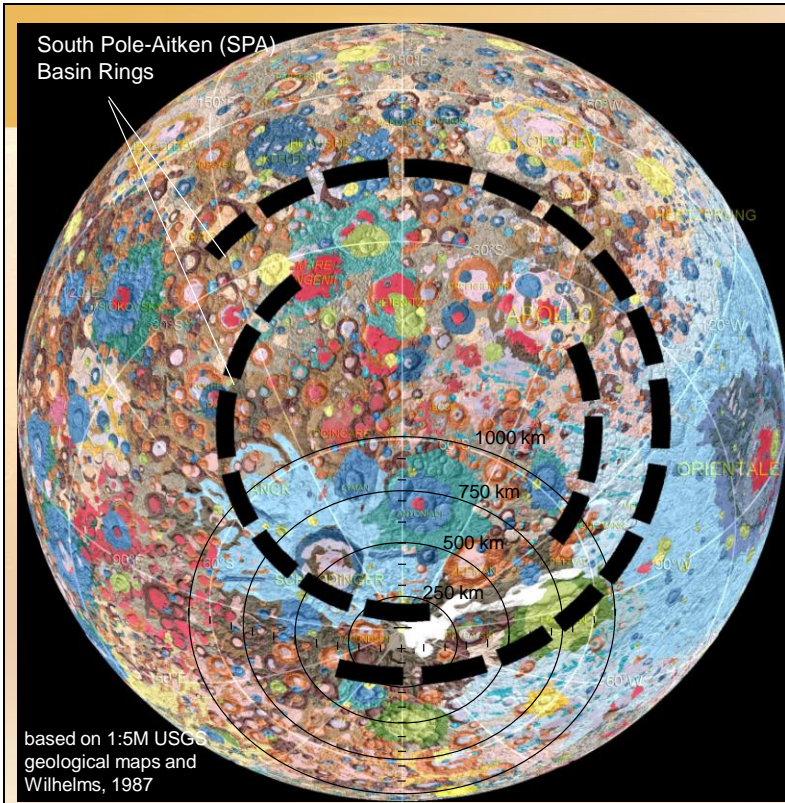

South Pole-Aitken (SPA) Basin Rings

based on 1:5M USGS geological maps and Wilhelms, 1987

### Example Outpost at Lunar South Pole

- Within 100 km**  
Interior SPA basin materials  
SPA basin ring massifs  
Malapert massif  
Shackleton & Shoemaker craters
- Within 250 km**  
Amundsen & Cabeus craters  
Schrödinger basin ejecta  
Drygalski crater ejecta
- Within 500 km**  
Schrödinger basin; dark halo (pyroclastic) crater on floor  
Orientale basin ejecta  
Drygalski, Zeeman, Schomberger, Scott, Hale, and Demanox craters
- Within 750 km**  
Orientale basin ejecta  
Antoniadi, Lyman, Hausen, Moretus, Boussingault, and Neumayer craters  
Mare fill in Antoniadi
- Within 1000 km**  
Planck & Poincaré basins  
Mare Australe & SPA maria  
Cryptomaria near Schiller basin  
Fizeau, Petzval, Zucchi, and Clavius craters

Aug 4, 2009

Surface Mission Option Descriptions – V5

8



### EXAMPLE REGIONAL SCALE GEOLOGICAL STUDIES INVOLVING CONTINUOUS ROVING\*

- Sample early crustal rocks to understand the development of the magma ocean, formation of the crust and mantle, timing of anorthosite formation and other large intrusive magmatic events, size and composition of the lunar core
- Measure bulk chemical composition of the Moon to constrain the processes by which elements were partitioned in the Earth-Moon system at the time of formation
- Use the Moon's craters as a natural laboratory to study the large impact process, including the origin and mechanism of central peaks and basin ring development, excavation dynamics and dimensions, and the mechanics of ejecta emplacement

#### FOR EACH GEOLOGIC UNIT:

- Determine and map the lateral extent of major lithologies and landforms
- Define and sample ejecta blankets from major pre-imbrian impacts
- Map the major structures associated with various size impact craters
- Collect samples that will date major geologic events, including impacts and magmatic events

#### CAPABILITIES REQUIRED:

- Pressurized rove capability with a minimum radius of ≈1000 km
- A campaign of multiple long roves
- 100s to 1000s of EVA crew days

Aug 4, 2009

Surface Mission Option Descriptions – V5

LEAG BASS, SAT Report, 2009



**RESULT:** Human surface mobility on Mars (for science) should facilitate ~100 km long traverses, on the basis of Human Science Reference Mission (HSRM) Case Studies conducted by the HEM-SAG.

Ancient impact Basin and Early Crust HSRM Case Study Site

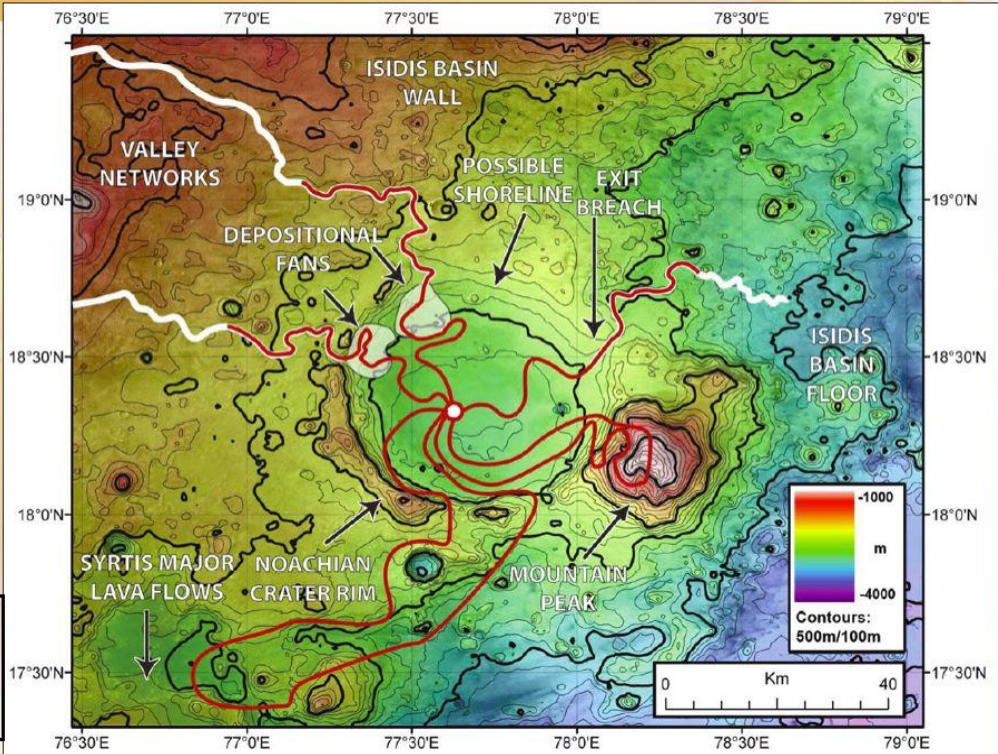

RED line indicates a set of science traverses (work in progress)



## Subsurface Drilling

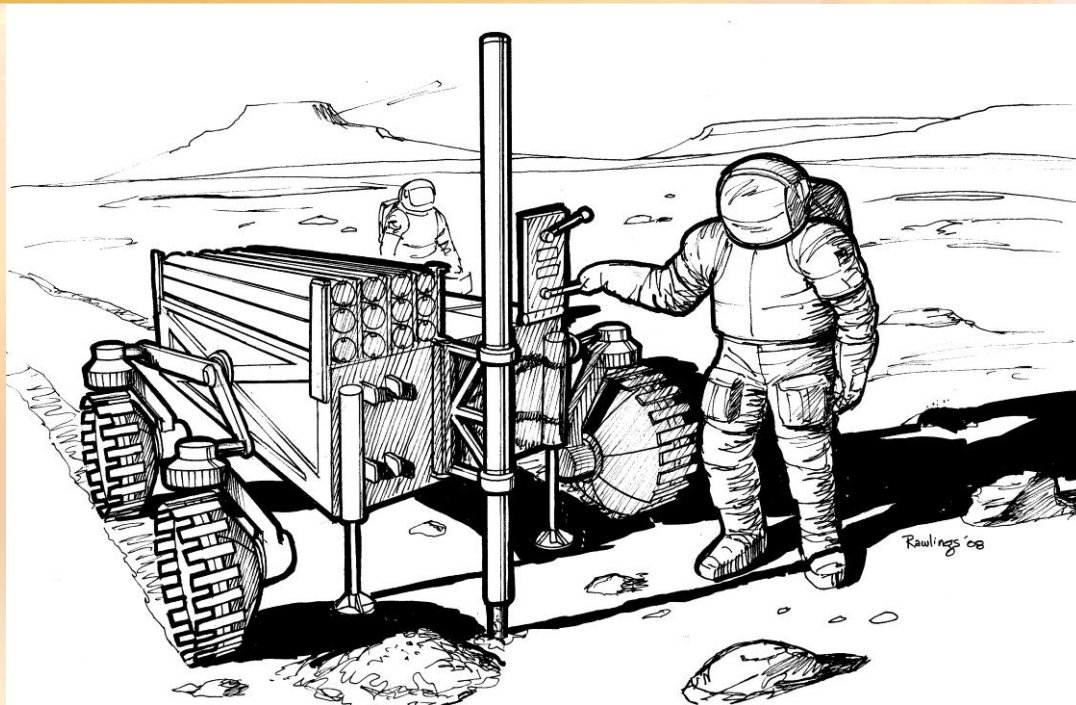

Aug 4, 2009

Surface Mission Option Descriptions - V5

11



## Mars Surface Mission Assumptions

- **Assumptions based on previous studies (adopted here) or from completed MAT Decision Packages**
  - **Six crew**
    - All land on the surface together
  - **Long-Stay mission profile**
    - Nominal surface mission lasts approximately 500 sols
  - **Pre-Deploy transportation strategy**
    - Two cargo flights sent one opportunity prior to crew, one of which lands at the designated surface site shortly after arrival at Mars
  - **ISRU plant functioning at the surface site**
    - Quantities are TBD
    - Commodities include (nominally): oxygen, methane, water, buffer gases
  - **Mass allocation for surface activities**
    - (nominally) 100 kg for returned samples
      - This includes samples of all types: geologic, atmospheric, biological, medical, etc.
    - (nominally) 1000 kg for surface science experiments and equipment
      - Specific science experiments and equipment would be selected based on the objectives for the site being visited and thus will likely be different for each mission

Aug 4, 2009

Surface Mission Option Descriptions – V5

12



## Surface Mission Strategy Option 2: “Commuter”

Notional Surface Mission Activities

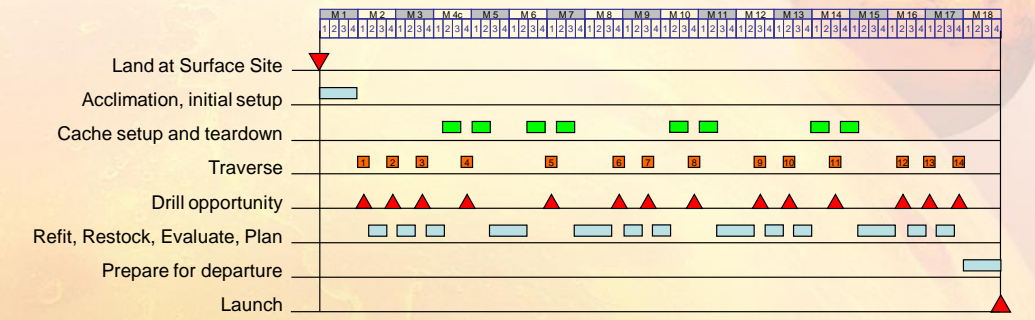

### Surface Assets

Item	Mass
Primary Habitat	15 MT (est)
Sm. Press. Rover x 2	6 MT (est)
Crew Consumables	7.5 MT (est)
Drill	1 MT (est)
Science Equipment	1 MT (allocation)
ISRU and Power Plant	2 MT (est)
Robotic Rovers x 2	0.5 MT (allocation)
<b>Total</b>	<b>33 MT</b>

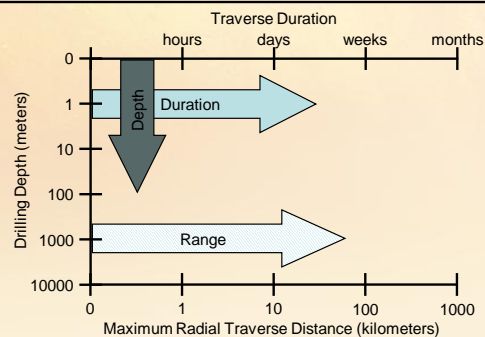

Aug 4, 2009

Surface Mission Option Descriptions – V5

13





## Different Comparative Views

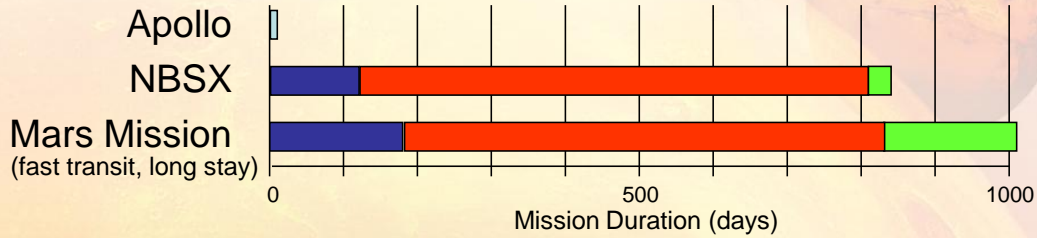

### Personnel



Apollo



NBSX



Mars Mission (?)

### Surface Cargo and Facilities



4.8 MT  
(no propellant)



450 MT



Approximately 80 MT  
(no propellant, aeroshell, parachutes)

Aug 4, 2009

Surface Mission Option Descriptions – V5

14



## ANtarctic Search for METeorites (ANSMET)

- In November 2002, ANSMET deployed a four person reconnaissance team to investigate a series of poorly explored blue ice fields southeast of the Weddell Sea and  $\approx 200$  miles north of the South Pole
- Over the course of the season, this team's operational experience became a good analog for the operations and logistics requirements that might be incurred on a manned exploration mission
- During 5 1/2 weeks of activity, we were able to collect a wealth of logistics and traverse data, part of which is presented here

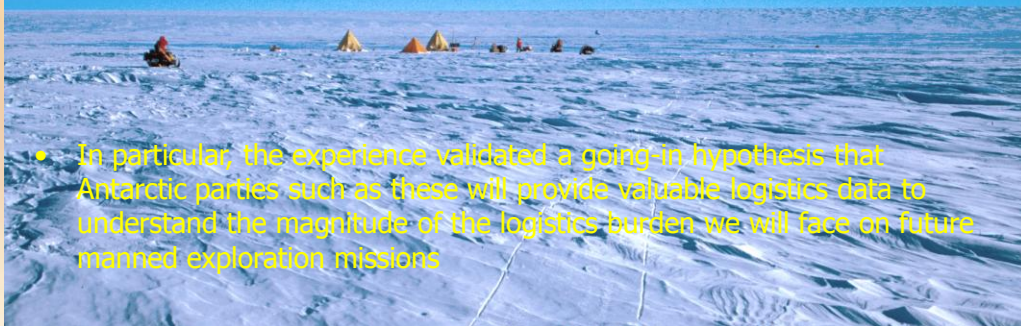

- In particular, the experience validated a going-in hypothesis that Antarctic parties such as these will provide valuable logistics data to understand the magnitude of the logistics burden we will face on future manned exploration missions

Aug 4, 2009

Surface Mission Option Descriptions – V5

15



## ANSMET also studied as Small Team Analog

- Comparison Data is between Apollo and ANSMET programs is very close at this level of granularity.
- We expect similar scalable math with larger field camp, small station and medium station numbers in future Analog work.

	Time, hrs	% On Surface Time
APOLLO 15		
Total Time on Surface	66.9	100%
Utilization Time	14.5	22%
Logistics Time	30.2	45%
Sleep Time	22.2	33%
APOLLO 16		
Total Time on Surface	71.0	100%
Utilization Time	14.6	21%
Logistics Time	29.1	41%
Sleep Time	27.5	39%
APOLLO 17		
Total Time on Surface	75.0	100%
Utilization Time	15.1	20%
Logistics Time	33.2	44%
Sleep Time	26.6	35%
ANSMET '02-'03 RECCE TEAM		
Total Time in Field	872.5	100%
Utilization Time	113.8	13%
Logistics Time	353.5	41%
Sleep Time	342.3	39%
Weather downtime	63.0	7%

Aug 4, 2009

Surface Mission Option Descriptions – V5

16



## And, lest you think these surface traverses are hard to do ...



- NSF is moving to an operational resupply of South Pole Station from McMurdo Station. Early proof of concept tests included:
  - Eight crew
  - 1654 kilometers (1023 miles) one-way; no resupply enroute (including at South Pole)
  - 2900 meter (9300 foot) elevation change
  - Approximately 40 days one-way (average 1.5 km/hr although periodic stops are built in)
  - Delivers a net 100 tonnes of supplies
  - Already planning for robotic vehicles to reduce crew size
- Russians and French have performed similar resupply for years

Aug 4, 2009

Surface Mission Option Descriptions – V5

17



## Agenda

- 8:30 – 9:00 Introductions: Steve Hoffman and Dr. Wendell Mendell
- 9:00 – 9:45 Dr. Charles Swithinbank (Scott Polar Research Institute) - observations from the Norwegian- British- Swedish Expedition (NBSX) of 1949-52
- 9:45 – 10:30 Dr. Charles Bentley (University of Wisconsin) - the first of two perspectives on the International Geophysical Year and the evolution that followed
- 10:30 – 10:45 a short break
- 10:45 – 11:30 – Dr. Richard Cameron - the second of two perspectives on the International Geophysical Year and the evolution that followed
- 11:30 – 12:15 – Dr. Friedrich Horz and/or Dr. Gary Lofgren - the Apollo lunar traverses and the associated planning
- 12:15 – 1:15 Lunch
- 1:15 – 2:00 Dr. Marie-Claude Williamson (Canadian Space Agency) - contemporary science traverses in the Arctic
- 2:00 – 2:45 Dr. Mary Albert (Dartmouth) - contemporary science traverses in the Antarctic
- 2:45 – 3:00 a short break
- 3:00 – 3:45 John Gruener (NASA) - NASA's plans for potential traverses on the lunar surface in the next era
- 3:45 – 4:15 Johan Berte (International Polar Foundation) - overview of the Belgian Princess Elizabeth Antarctica research station and its development
- 4:15 – 5:00 open discussion with all presenters and attendees

Aug 4, 2009

Surface Mission Option Descriptions – V5

18



## Automated Drill as part of Rover Testbed



Aug 4, 2009

Surface Mission Option Descriptions – V5

19

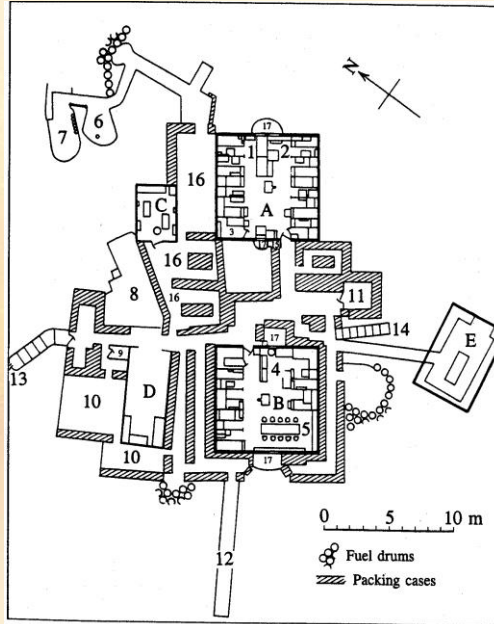

Aug 4, 2009

Surface Mission Option Descriptions – V5

20



## Surface Mission Strategy Option 2: “Commuter”

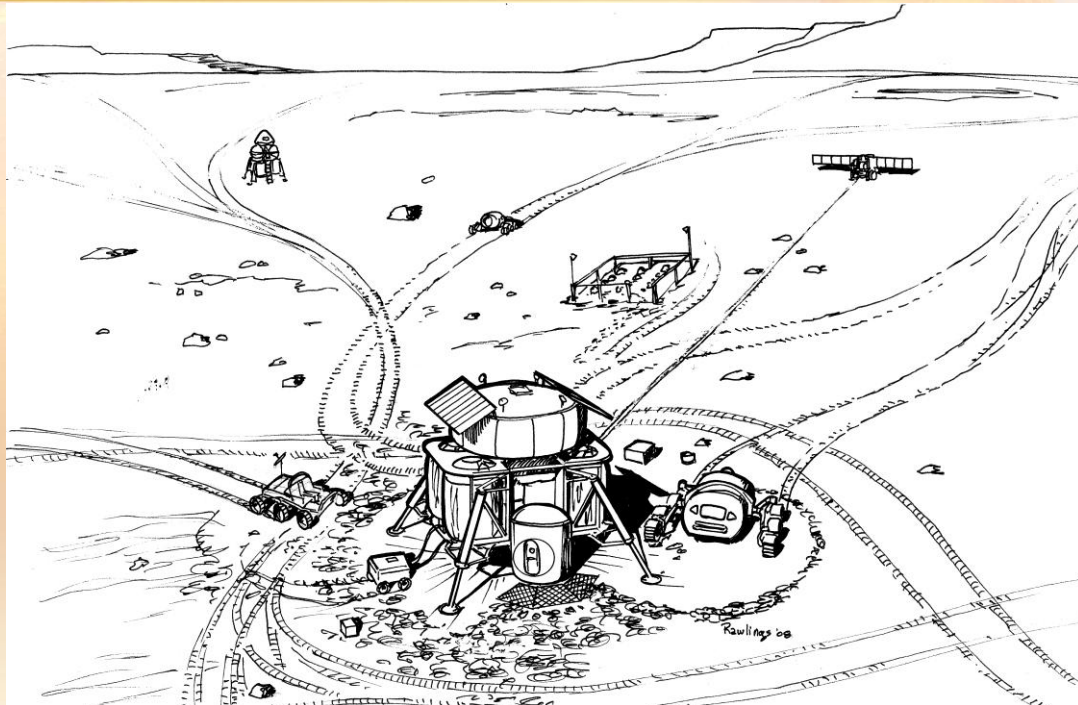

Aug 4, 2009

Surface Mission Option Descriptions – V5

21



## Mars Surface Environment

### Surface temperature

Height above Surface (feet)	Day (F)	Night (F)
5	15	-105
0	65	-130
(Antarctica)	-15	-82

- Surface pressure: 7 -10 millibars (Earth surface pressure is 1000 millibars)
- Length of day: 24 hours 37 minutes
- Length of year: 687 days (the “long stay” surface mission is approximately 500 to 600 days long)
- Surface area: 145 million square kilometers (the same as all of the dry land on Earth)

Aug 4, 2009

Surface Mission Option Descriptions – V5

22



## Long Stay Mission Sequence Pre-Deploy Option

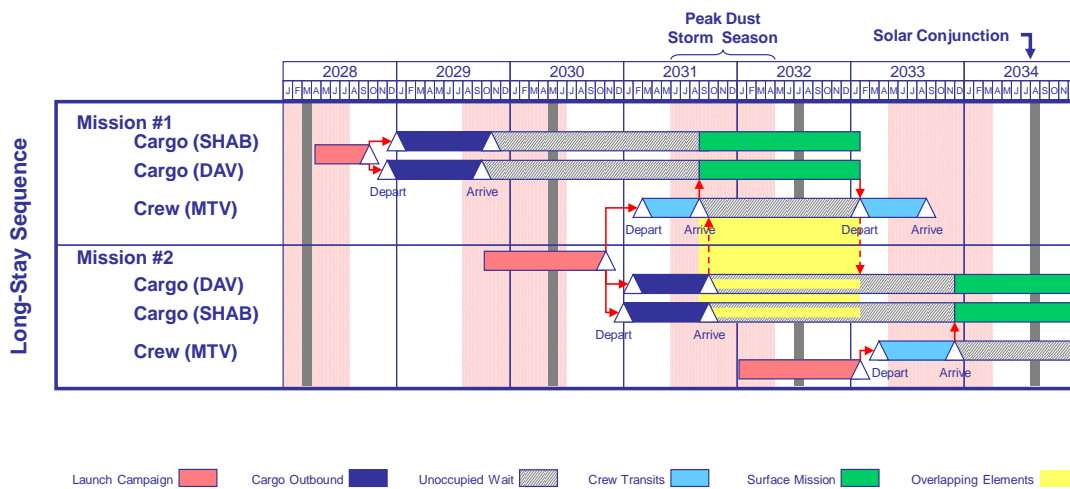

23

## A2 – Presentation of Charles Swwithinbank

### *Parallels between Antarctic travel in 1950 and planetary travel in 2050 [to accompany notes on “The Norwegian British-Swedish Antarctic Expedition 1949-52”]*

#### **Cost of the expedition** (Slide 1)

Norway and Britain were recovering from World War II and food was still rationed. The total cost of the 16-man 2½-year expedition had to be less than £1 million (circa \$40M today). Norway agreed to shoulder 50% of the costs, Britain and Sweden 25% each.

#### **Capacity of the launch vehicle** (Slide 6-7)

The only affordable vessel was *Norsel*, a 600-ton sealer owned by the skipper. All equipment and supplies had to be jammed into the holds or carried on deck. Initially it was planned that the ship would go south in 1949 and only return in 1952 to evacuate us. In the event, the budget allowed *Norsel* also to come in the middle summer season, bringing supplies, aircraft, and personnel.

#### **Objectives** (Slides 2, 12, 21-22)

To explore as much as possible of 1 million km<sup>2</sup> of unexplored territory. We were the first expedition to winter in Antarctica between 95°E and 57°W - nearly half the coastline of Antarctica.

It was understood that we must be self-sufficient in every respect for 2½ years. There could be no firm or detailed plans for inland exploration until we found where it was possible to make a landing.

#### **Personnel** (Slides 9-11, 21-22, 24-28, 32)

Limited by cost and logistics to 15 men: 8 science and 7 support staff. This ratio meant that scientists had also to serve in support capacities. The science staff was to consist of:

- (a) A topographic surveyor to provide ground control for aerial mapping. The prime duty of the first explorer in any new land is to make a map showing what is there.
- (b) Two glaciologists. The initial impetus for the expedition came from a Swedish glaciologist who had seen indications of glacier recession in aerial photographs taken by the Neu Schwabenland Expedition of 1938-39. His own work had documented contemporary glacier recession round the North Atlantic, which led to the question of whether climatic warming was also occurring in the southern hemisphere.
- (c) One geophysicist to measure the thickness of the ice sheet where possible. Contemporary speculation was that the Antarctic ice sheet might be 300 m thick, whereas German work had claimed ice thicknesses of 3,000 m in Greenland.
- (d) Two geologists. The idea of continental drift was a hot topic among earth scientists. We might find critical evidence.
- (e) Two meteorologists. We could fill a vast gap between existing weather stations (>2,000 km in every direction). Also weather forecasting was important for Norway's whaling industry.

#### **Selection of personnel** (see Personnel)

Participation involved signing on for 2½ years; a 1-year expedition would have ruled out all but localized exploration. This limited the number of candidates. Four out of 15 were married. Selection was by interview and medical examination. At that time, the idea of female participation was not even discussed. The capacity of our small ship precluded any redundancy in staffing. In the event, three men drowned in February 1951. The rest of us, qualified or not, had to take over their jobs.

## **Insurance**

Personnel were not offered life insurance nor, to the best of my knowledge, did the unmarried members insure themselves.

## **Analog training**

This is vital (as with travel on other planets). Whilst only two out of 15 had ever been to the Antarctic, almost all had worked in the Arctic. I had undergone winter and summer training in Iceland and Lapland and was taught crystallography by Max Perutz.

## **Medical** (Slides 24-28)

We had a young Swedish physician. He had to accept that in **no** emergency – however serious – could help be brought in from outside. Knowing that earlier expeditions had found that teeth rot in all climates, he took a three-week course in dentistry and prepared for trauma of any kind – in men or dogs. He was not found wanting. A geologist got a chip of rock in one eye and the eye had to be removed.

## **Salary**

The tripartite committee agreed that compensation should be no greater than the same person would have been paid at home. Some of the single men, myself among them, would have been happy to go without any pay. The money, we felt, would be better spent on equipment.

## **Launch pad** (Slide 6)

The small foredeck of *Norsel* could only accommodate three Weasel tractors, a large ice coring drill, dog food, spare parts and 62 sled dogs on top of it all. The rest of the upper deck was hidden under fuel drums. Both holds were full and a crated aircraft sat on the after hatch with a second aircraft on top of it. The Plimsoll line was below the waterline.

## **The base** (Slides 3-9, 13, 37)

The coastline consisted of ice cliffs 20-25 m high – impossible to land on. We steamed from 5°E to 12°W searching for a low point where the ship could unload. Finally we found one at 10°56'W, far to the west of where we had hoped. Four hundred tonnes of cargo were unloaded and driven 3 km inland, where a base was established on floating ice shelf. Food for 3 years was taken in case the ship was unable to reach the base after the planned 2 years.

Only now did it become possible to make detailed plans. The science staff themselves decided on priorities in their own fields. This chain of events was as foreseen from the start of the expedition and proved best in the circumstances. In each pair of the science staff, one was senior and thus had the final say. The seniors met with the leader to decide on who was to use which tractors or dog teams in each season. Experiences gained in the first field season affected planning for the second. In the circumstances I can think of no better way.

Discipline on base was invisible. We worked from breakfast to supper with time only for a quick lunch. The leader set a roster for domestic duties in which all staff had to take part. Work involved clearing the exits from drift snow, cutting and bringing in snow blocks to make water, washing dishes and sweeping out. We took pride in handling our science programs without help, but if help was asked (for heavy lifting or moving), it was willingly given.

## **Aviation** (Slides 4, 23, 31)

Constrained by what could be carried on *Norsel* and deployed while the ship was present. Two light aircraft in each of three seasons. In 1949-50, two Austers of the Royal Air Force; in 1950-51 two

Norwegian-built aircraft crewed by Widerøes Flyveselskap; and in 1951-52 two aircraft of the Royal Swedish Air Force. Together they took oblique aerial photographs covering some 100,000 km<sup>2</sup>. The Weasel crews were required to carry fuel inland to extend the range of the survey aircraft. Today the roles have been reversed: aircraft fly fuel inland to extend the range of surface traverses.

### **Field work** (Slides 14-23, 31-36)

After an initial reconnaissance with dog teams seeking a crevasse-free route inland, all three weasels, each one hauling two tonnes, made two journeys to a point 300 km inland to establish an (unmanned) Advance Base. Their cargoes consisted primarily of dog food, to facilitate lightweight scientific excursions radiating out from the Advance Base into areas of scientific interest. All Antarctic expeditions before 1957 made depot-laying journeys to provide for longer scientific traverses later. I expect that similar non-scientific traverses will be necessary in advance of long-range science journeys on other planets.

### **Risks of travel** (Slides 13-14, 18, 23, 29-30, 39, see also Medical)

We took risks - we knew we took them. Field radios at the time were low-powered and heavy. Communication with base was rare. We had no communication with friends or family at home, and in my view, that was for the best. The only time we could rest with a clear conscience was in blizzards. On one long journey we dumped the radio to be picked up later on our return, on the grounds that if we did have an emergency, nobody could reach us to help anyway.

### **Geology** (Slide 20)

Our two geologists traveled far from the Advance Base during both field seasons. Carrying fuel supplies (dog food) for a month, man food (dehydrated) and rock specimens acquired along the way, they covered a vast area. The surveyor drove his own dogs with the geophysicist as assistant. While the geologists were hacking away at rocks, the survey team lugged a theodolite up peaks to extend a triangulation network.

### **Glaciology** (Slides 21-22)

The glaciologists each had an assistant from the support staff, so they could either travel together or divided into two parties to cover more ground. At each camp they dug a pit to determine the rate of snow accumulation, drilled (by hand) to a depth of 10 m to measure ice temperatures, and in places set up and surveyed ice-movement markers to be resurveyed the following season.

### **Geophysics** (Slides 33, 34-36, 38)

The principal object was to determine the thickness of ice by seismic sounding – the only means known at the time. After experiments as far as the Advance Base in the 1950-51 summer, both Weasels were devoted to a seismic sounding traverse in 1951-52 as far inland as supplies would allow. The party reached 620 km inland and found ice thicknesses of 2,500 m.

### **Conflicts**

There was competition for use of the Weasels, particularly after one of the three machines was lost in an accident. Apart from that, we solved our differences amicably. On returning to England, our Leader wrote in *The Times* of London (19 Feb 1952): “I do not think there has ever been a polar expedition with so little friction between members.” My own opinion is that, other things being equal, once away from home an international expedition encounters fewer difficulties than would a national expedition. Each one of us, to the best of our ability, leaned over backwards to suppress our national prejudices and preconceptions. That, surely, was the key to our success.



I do not recall any occasion on which the senior man from one country convened a meeting to discuss a *national* policy. It helped that the meteorology program involved a Norwegian and a Swede; glaciology and geophysics had Swedish, British, and Australian participants; and the geology/survey program had Canadian, British and Norwegian members. We knew that any alignment based on nationality would be disruptive, and that the success or failure of the expedition would be judged by its scientific results.

**Sequelae** (Slides 40-44)

Advance depot-laying generally fell out of favor because of the availability of aircraft.

Seismic sounding became an important part of the International Geophysical Year (1957-58). It was superseded by airborne radar sounding in 1966 when I flew an early version over the Antarctic Peninsula. Later work used C-121J, LC-130 and DHC-6 aircraft. Forty years later a similar instrument was used for sounding the Polar Ice Caps of Mars.

CHARLES SWITHINBANK

NORWEGIAN-BRITISH-SWEDISH  
ANTARCTIC EXPEDITION  
1949-52

CS 24 July 2009<sub>1</sub>

*Is the World Getting  
Warmer?*

*Antarctic Expedition to Seek Clues*

(By ASTLEY HAWKINS)

LONDON.

CLUES to whether the world is getting warmer and slowly melting the ice and snow from the polar regions will be sought in the Norwegian, Swedish and British expedition, preparing to leave for the Antarctic late this year. Holes will be bored in glaciers to measure their depth and study their history

*Buenos Aires Herald (10 March 1949)*

2



**Ice front (20 m high)**

3



**Auster taking off to search the ice front for a dock**

4



Maudheim (Jan 1951)

5



Ice dock (Jan 1950)



**Maudheim 3 days old**

7

**Plan of Maudheim,  
our habitat for two  
years**

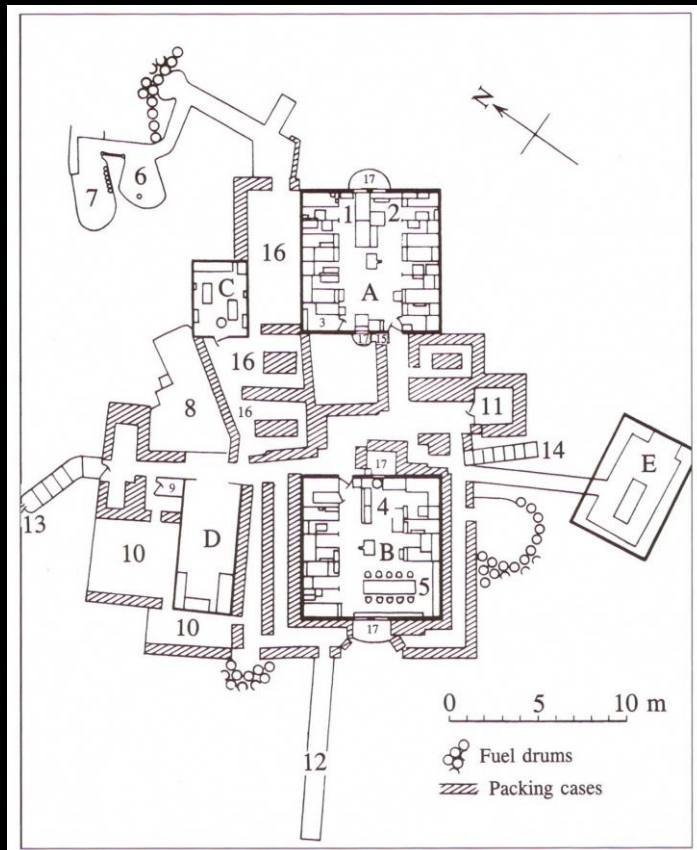

8



Lunch

9



Ice coring to  
100 m depth

Ice crystal  
studies in cold lab  
at -20° C



11

## Tell Ice Age Like a Tree

NEW YORK (NANA)—Ice has “rings” which date it just like a cross section of a tree, it appears.

A report recently from the joint British-Scandinavian Antarctic expedition under Capt. John Giaever reported that their glaciologists had brought to the surface ice which fell as snow at the time the Germans under Bismarck invaded France 80 years ago.

*St John's Evening Telegram (15 Sep 1950)*

12



**Main habitat after the first winter**

13



**Dogfights were common**

14





**Slow going with 500 kg on the sledge**

15

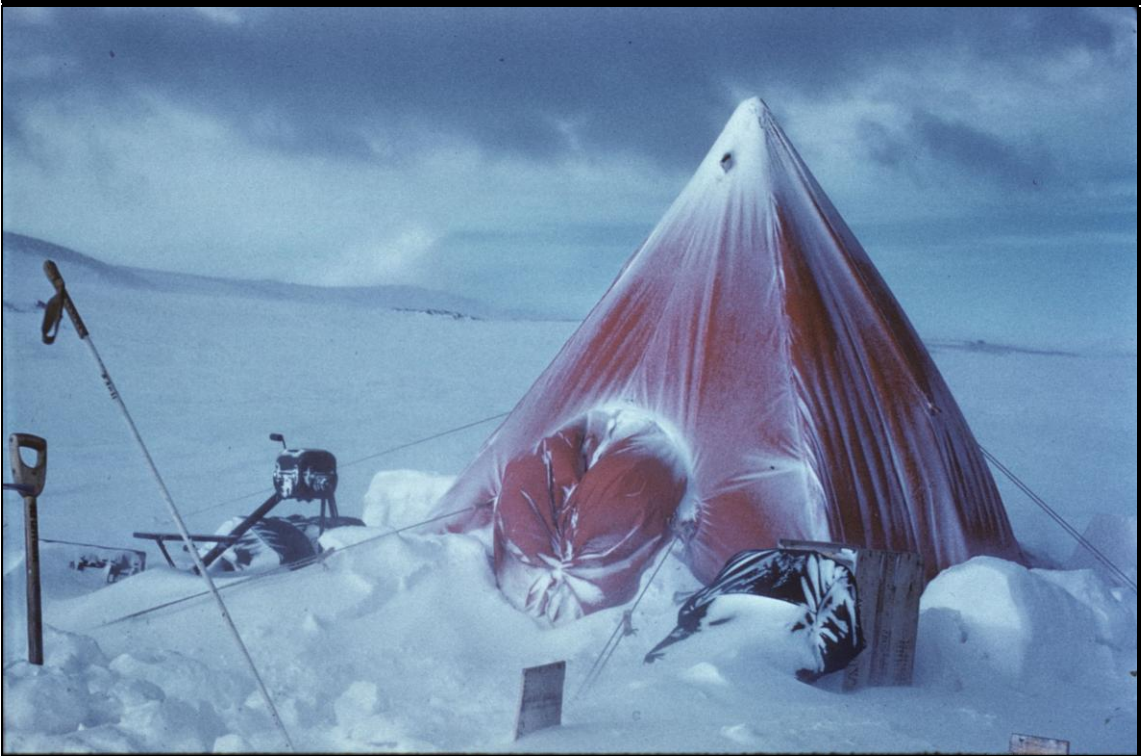

**Travel habitat  
(note hand-cranked generator for radio)**

16



Weasel hauling 2 tonnes (mostly dogfood)

17



Crevasse!

18



**Weasels approaching mountains**

19



**The Advance Base at Pyramiden**

20

**We drilled to 10 m at every camp for ice temperatures**



**Measuring snow density and annual layers**

22

**How pilots  
learn about  
whiteout**



**Dr Wilson  
(veterinary)  
surgeon**

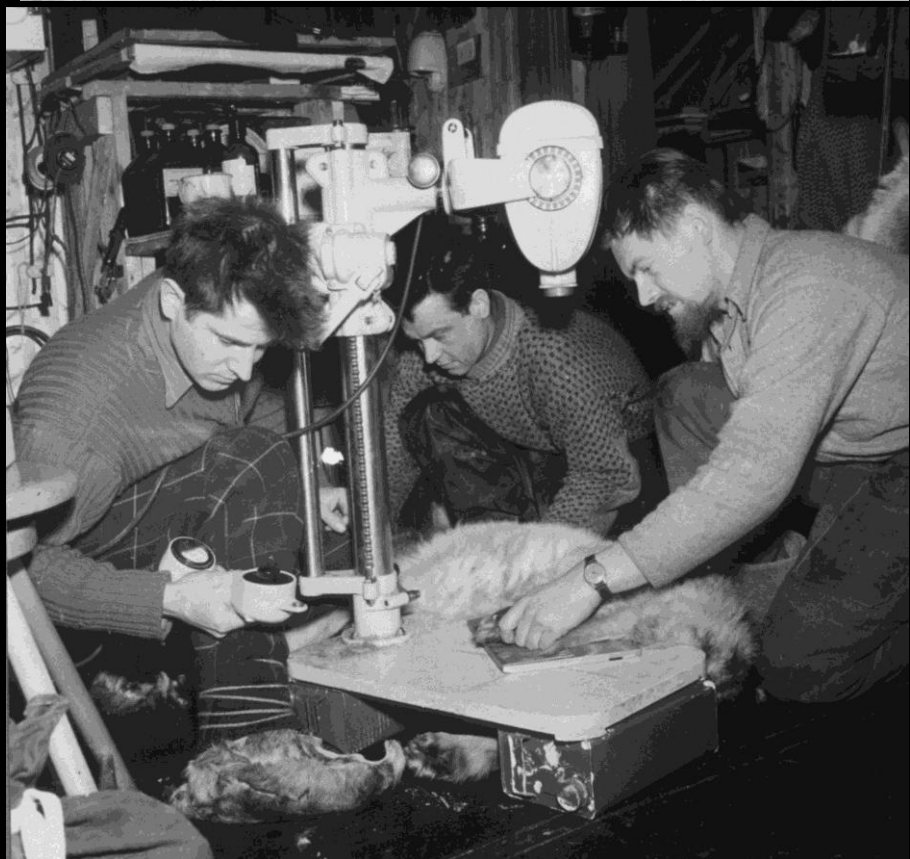



**Dr Wilson (cranial surgeon)**

25



**Dr Wilson (dental surgeon)**

26

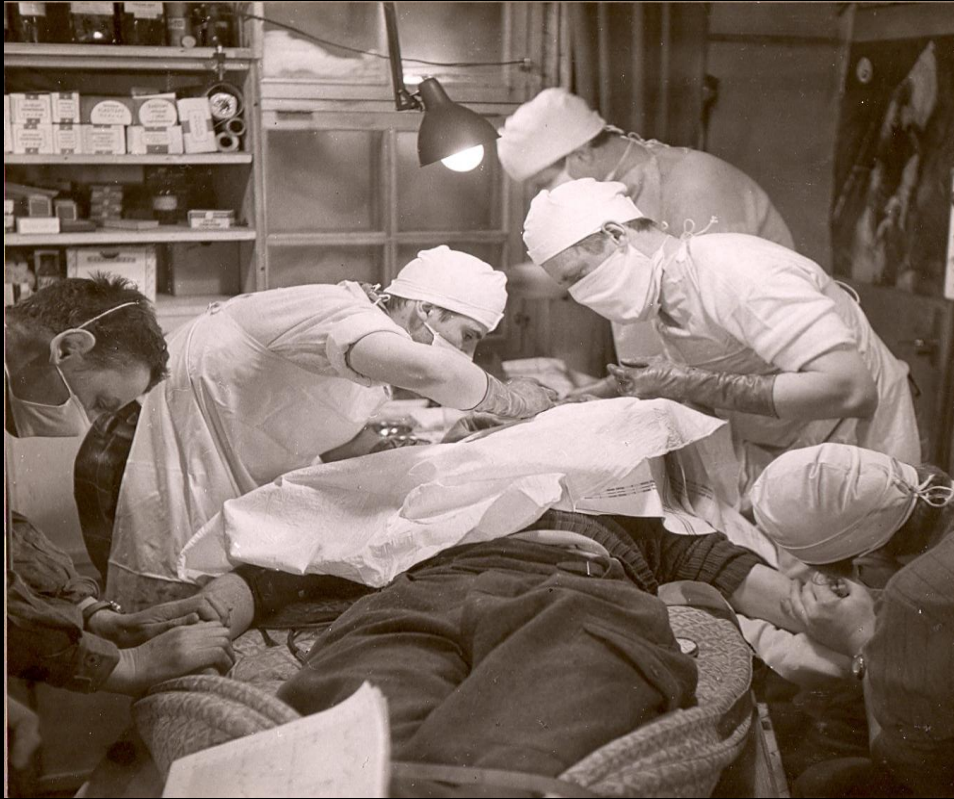

Dr Wilson (eye surgeon)

27

# Dramatic operation in Antarctic saves man's sight

USING "home-made" instruments and assisted by men who had no medical experience, Dr. O. Wilson, a member of the joint British-Scandinavian Antarctic Expedition, performed an eye operation on a British geologist and saved him from total blindness.

Dr. Wilson, who had never even seen such an operation performed, received his instructions by wireless from an eye specialist in Sweden. In the seven days before the operation

Johannesburg Star (2 October 1951)

28



Hallgren swam  
to an ice floe

29

13 HOURS ADRIFT  
ON FLOE

---

STORY OF MAUDHEIM  
SURVIVOR

*Calcutta Statesman (25 April 1951)*

30





**Beechcraft 18R of the Royal Swedish Air Force**

31



**Yarning**

32



**Seismic traverse heading south (10 Nov 1951)**

33

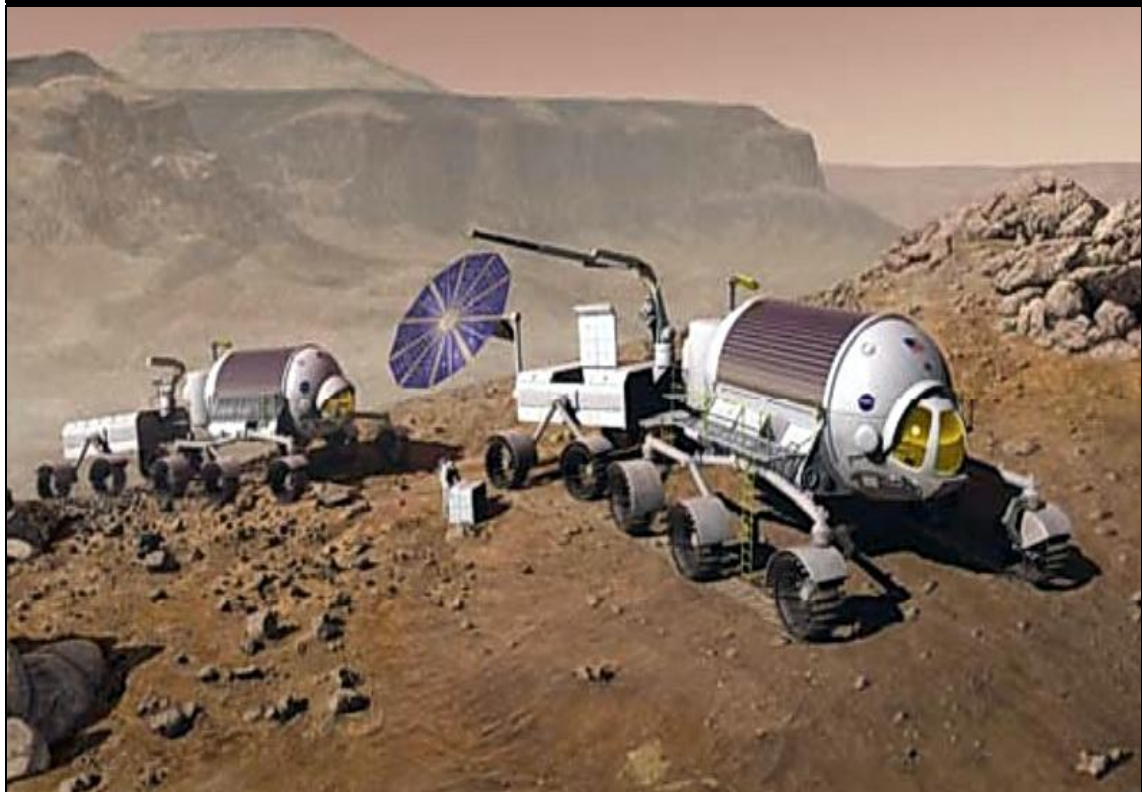

**Mars traverse (Rawlings 2007)**

34



**In seismic caboose**

35



**Farthest south (Dec 1951)**

36



**Maudheim (Feb 1952)**

37

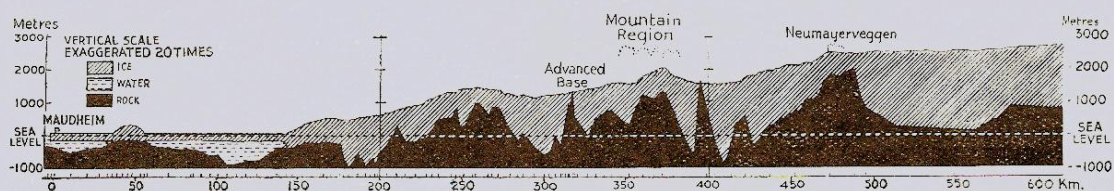

**600 km seismic traverse**  
*(Nature, Vol. 171, 1953, p. 55)*

38

ENDLESS WASTES  
OF ICE “AFFECT  
THE BRAIN”

Antarctic expedition's  
grim winter

*Johannesburg Star (14 Sept 1951)*

39



*First airborne radar sounding (12 Jan 1967)*

40



**'Super-Constellation' (C-121J) with 35 MHz antenna (Dec 1967)**

41



**LC-130 ice radar antenna (Dec 1978)**

42



**150 MHz antenna on Twin Otter  
(Jan 2009)**

43

**Fig. 1. (Top) Radargram from SHARAD orbit 5192**

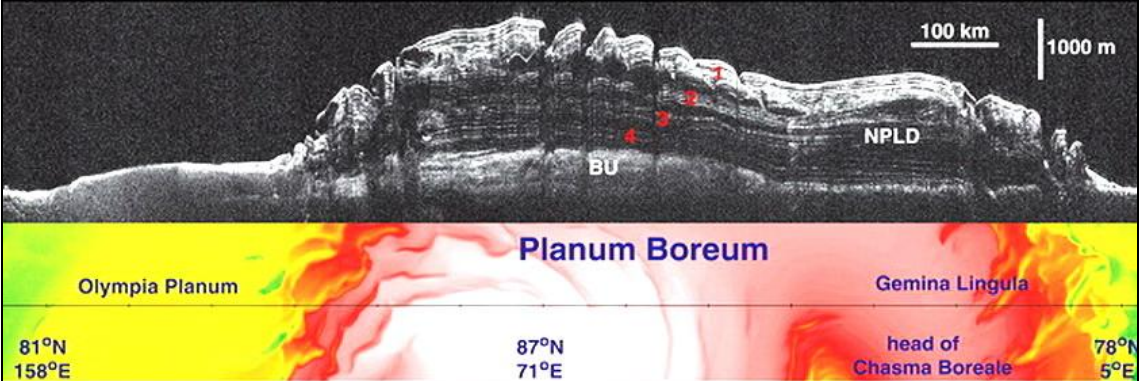

**R. J. Phillips et al., Science 320, 1182 -1185 (2008)**

Mars North Polar Ice Cap

## **A3 – Presentation of Charles R. Bentley**

### ***My IGY in Antarctica***

[Slide 1] To put my remarks in context I'm going to use as a framework a brief travelogue of my IGY Antarctic years.

[Slide 2] We start in New Zealand, on board our southbound ship, the Pvt. Joseph F. Merrell. Pictured here are Bentley, Ostensio, Morency, and Anderson.

[Slide 3] Travel to Antarctica: In those days access was only by ship; WWII Victory ship, thin-skinned, icebreaker escort, wait until mid-summer for sea ice to break up; to have a full field season must go in the year before and winter over. This is still the routine for countries without Antarctic air facilities. KA56 is the Arneb, one of the logistics ships.

[Slide 4-5] After several days we reach the Ross Sea, where we encounter sea ice, and are joined by an icebreaker (GB3 is the USS Atka) to help us get through.

[Slide 6] USS Atka and another icebreaker out front, then probably the USS Arneb and for sure the USNS Pvt. John R. Towle, taken from on board USNS Pvt. Joseph F. Merrell. Both Towle and Merrell were Medal of Honor recipients for actions against the Germans after the invasion of Europe.

[Slide 7] We move eastward through the Ross Sea to the vicinity of Admiral Byrd's latest Little America Station, where we discharge our cargo at a low spot in the Ross Ice Shelf edge that had already been scouted out.

[Slide 8] Little America is a typical IGY station – buildings, cargo dump, Weasels. In the foreground are Bert Crary and George Toney

[Slide 9-10] We are not slated to stay here so we collect our vehicles; 3 Tucker Sno-Cats, gasoline powered, 4-track drive, all pontoons turn, cab over engine for warm access to latter – also keeps cab warm – so warm, in fact, that often we have to drive with open windows and doors to cool off; several K lb drawbar capacity. Benches inside for instruments and sleeping; cooking; and scientific equipment. Aneroid altimeters, exploration seismic gear, gravity meter, magnetometer, rammsonde, snow density gear, radios for inter-Cat and traverse-to-base communication, navigational equipment.

[Slide 11] We set out for Byrd Station in the West Antarctic interior, 640 miles away following a marked trail.

[Slide 12] We met Maj. Merle (Skip) Dawson leader of the Army-Navy Trail Party on his way back to LAS in his Weasel. At Mile 280.

The types of measurements to be made were laid out by the IGY Glaciology Panel in Washington when they decided what instruments to provide for the program, but we had a lot of leeway in deciding our experiments and the actual design of the traverse operations.

Traverse routine: travel one Cat ahead then other two 5 miles behind for differential altimetry. We stopped every 5 miles for altimeter, gravity, magnetic readings, rammsonde every 20 miles; alternate days traveling, then day on site for seismic work and pit studies. Some conflict over cooking at first because



nobody considered it his job. It was to be the job of the original mechanic, but the man we had was a late substitute for the original man and the new man had not agreed to be cook, but eventually worked out a routine. Mogas drums cached for us every 50 miles.

Danger in traveling with light tailwind enveloped in own exhaust – CO poisoning

Food: some good, newly developed dehydrated items, but with the Sno-Cats we had plenty of hauling capacity so we carried mostly full-weight frozen items – steaks, etc.

After almost a month of travel, we arrive at Byrd Station.

[Slide 13] (This was actually taken in November, 1957, at the start of Sentinel Traverse, 1957-58. Shown here are Dan Hale sitting on sign, then standing, Bentley, Jack Long, Ostenso; kneeling, Norbert Helfert, sitting, Anderson.)

[Slide 14-6] Byrd Station was still a work in progress when we arrived; buildings were still going up as the construction was delayed by long time needed to find route through Fashion Lane to get to Byrd Station location. These pictures show the modular construction of Clements hut. Scientists help with construction. Not everything needed arrived before last flight (by R4D), so some improvising was required; e.g., missing non-magnetic panels. We did have an ample supply of real essentials, like food; diesel fuel for heating, electric power generation, and running big Caterpillar; mogas

[Slide 17] The last piece of construction was the aurora tower. After it is finally built, we settle in for the long winter ahead.

[Slide 18] Russ Greenwood shoveling snow into the snow melter. The snow melter used excess heat from diesel generators. Every man expected to replace water he used; e.g., for shower, clothes washer

Most men at Byrd Station, including all the members of the traverse party, were young, just in their twenties. Half were civilians and half were Navy SeaBees – 12 of each. And we were all men – women wouldn't be allowed on the continent in the U.S. program for more than a decade. The station leadership was split: the chief scientist, in charge of the scientists, and the officer in charge of the SeaBees (who was also the doctor) shared the responsibility evenly. It worked well both winters because of character of the leaders. The only real leadership problem in IGY was at a station where one man was leader of both groups (Ellsworth Station; Finn Ronne). That also was a matter of the character of the leader.

[Slide 19] Primary activities during winter: working on data (geophysicists), digging a deep snow pit to study the record of past snowfalls (glaciologists) and preparing for summer's traverse.

[Slide 20] There was plenty to do to keep us from getting bored. We taught ourselves celestial navigation and sending Morse code; built a kitchen wannigan; and calculated sled loads. During the latter, we realized we had ample capacity so loaded up on frozen class A rations.

[Slide 21] We occasionally used the ham radio to talk to the folks back home. (Here I am with Steve Barnes, making a call during winter 1958.) During the next year, we had proper equipment and our connections were much better. This was an important morale booster in absence of any other connection home.

[Slide 22] Here we are enjoying the company of some new mid-winter arrivals.

[Slide 23] The Second winter was plush compared with first. New recreation building w/ ping-pong and [Slide 24] pool tables, exercise area (Judo class), [Slide 25] good beer supply, roster included Navy Chief to help out Officer-in-Charge/doctor.

[Slide 26] While there was still light, we got some work done outside. Here, Ostenso and Anderson, with a theodolite.

[Slide 27-28] Clothing. The first slide shows some of the special clothing supplied: down parka & pants, Byrd cloth windproofs, dog-skin mitts, caribou-skin boots, full facemask, bear paw mitts; second shows much better parka hood, much better nose-&-cheek mask. [Slide 28] But the standard summer wear was as shown (Bentley, Bill Long, Le Schack, Anderson, Jack Long, Ostenso) – Korean War vintage Army issue (field jacket, field pants, parka, all with removable liners), plus down vest (not Army issue), personal hat (most men had personal items – sense of variation from uniform probably important). Bear paws still issued, but the best mitts for working when it was too cold for leather gloves with inserts were the leather "chopper" mitts (see previous Slide 19).

[Slide 29] After months of darkness, the sun finally rises again, [Slide 30] showing us our Sno-Cats buried in snow, outside and [Slide 31] inside. So after, lots of digging, [Slide 32] and some preparatory barbering, [Slide 33] we were ready to go.

The Kitchen wannigan was a huge improvement over cooking in Sno-Cats. The gyrocompasses we were supplied with for finding the vehicle headings were insufficiently damped for travel over the rough, hard snow surface – they swung wildly and were useless. Fortunately, someone dug up an Army vehicle (tank) magnetic compass, which worked nicely. It saved the day!

The traverse routine was the same as before except no trail to follow, no fuel caches. One cat led, 3 miles ahead of the other two. We alternated travel and station days with a few several-day stops for more extended work – seismic refraction, [Slide 34] deeper pits. Cooking was shared, except I did all breakfasts so I could wake everybody. I think others appreciated it that I was first up and (usually) last to go to bed. Carried enough mogas for about 150 miles, and then needed a resupply flight. We waited several days for the first one, but thereafter the Navy pilots were eager to fly out to us.

Navigation was by sun shots – we taught ourselves over the winter. At first the Navy navigators tried to tell us where we were, but they soon realized that sunshots from solid ground with a theodolite were more accurate than sextant shots from a moving aircraft.

[Slide 35] Resupply flights (here an R4D taking off with JATO assist) brought out fresh bread, sometimes some veggies and fruit and mail – an important morale factor. The cook at Byrd Station, while an excellent cook, was a bit of a sourpuss who thought our several unsuccessful attempts to start off on our traverse (due to the gyrocompass problem) were our deliberate efforts to f\_\_\_ up his meal planning. When he sent out a couple of pies on a re-supply flight we thought he had forgiven us until we bit into them and found them thoroughly laced with red pepper!

[Slide 36] On the traverse to the Sentinel Range, 500 miles to the east. Traverse route was generally planned to be a northeast loop to Mt Ullmer (north end of Sentinel Range, the main part of which was previously unseen). We were free to alter our route according to what we found, and we did, [Slide 37] first at Mt Takahe and [Slide 38] then at Sentinel Mts.

[Slide 39] Safety: the electrical crevasse detector worked well only at low travel speeds – at our cruising speed of 7 mph it bounced too much over the sastrugi to see any crevasse signals so we made a decision early on to traverse without its protection. I was under the ignorant expectation that there would be no crevasses in the WAIS interior. We left the crevasse detector mounted (but turned off) anyway because it was a good sastrugi detector when traveling in poor lighting conditions.

[Slide 40] The weather was mostly good, although we encountered some windy days.

[Slide 41] We learned how to be prepared; e.g., parking Sno-Cats and sleds so the wind didn't catch the doors and drifting was minimized, picking up all seismic cables right away after shooting, etc.

A final personal note: I was originally scheduled to stay over just one winter. Sometime during that winter the call came for volunteers to extend a year. I jumped at the chance because I was so interested, as a geophysicist/glaciologist, in our surprising findings and I thought IGY would end and I would never have another chance. I was never sorry I did so, even after I found out that the Antarctic research program was continuing.

# My IGY in Antarctica

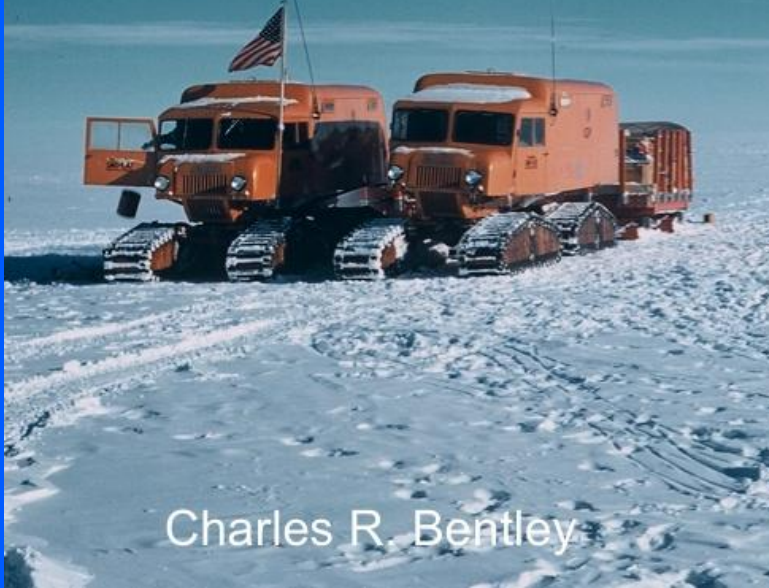

Charles R. Bentley

1



2



3



4





7



8









13



14







19



20





23



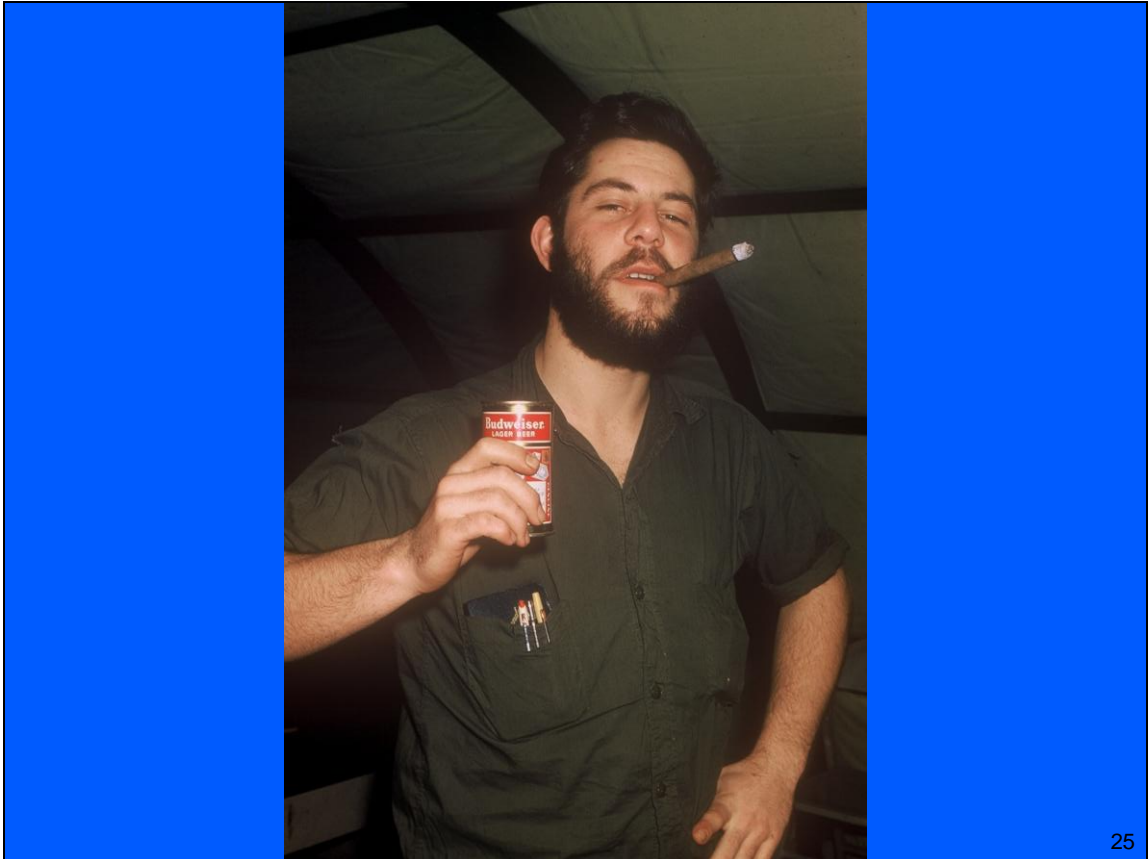





27





30





33



34







39



40





## **A4 – Presentation of Richard L. Cameron**

### ***Short Trips and a Traverse***

[Slide 2] AT THE EDGE OF THE ICESHEET – WILKES STATION 1957

The assignment for the Navy Seabees was to first establish a joint US-NZ base at Cape Hallett and then go along the coast of East Antarctica and set up Wilkes Station. However, delays caused by the need to stop work at Hallett and deliver tractors to McMurdo as a tractor and operator (Willy) went through the sea ice and then again at Hallett a pinching of the ARNEB by sea ice being forced against the ship by high winds and the subsequent requirement of Admiral Dufek to inspect the ship (he was in McMurdo).

[Slide 3] Three ships finally headed to Wilkes, the icebreaker GLACIER, and two cargo ships, the ARNEB and the GREENVILLE VICTORY. [Slide 4] En route there was heavy sea ice and [Slide 5] large tabular bergs. The arrival date was 29 January 1957 and by 16 February the station had been built and the ships left. The site was Clark Peninsula in the Windmill Islands a group of Precambrian outcrops attached to the ice sheet by ice ramps. [Slide 6] The station could experience fine weather or [Slide 7] bad weather with strong katabatic winds.

[Slide 8] The station had dual leadership with Lt. Burnett and Dr. Carl Eklund (shown in slide). Eklund had been in the Antarctic in 1940 with Finn Ronne when they sledged over 1264 miles in 84 days and mapped 500 miles of coastline of the Antarctic Peninsula. The station consisted of 17 Navy personnel and 10 IGY scientists. Throughout the year there was good morale but of course the isolation was easier on the scientists as their work became more interesting as the year wore on and the Navy men became bored with the tedium of their respective chores.

[Slide 9] At Wilkes we had three forms of transportation; dog team, [Slide 10] Weasel, and [Slide 11] a raft with outboard motor. [Slide 12] Inland of the station the ice sheet gained in elevation rapidly and had a firm surface with no crevasses en route to where [Slide 13-14] we built a small station called S-2 for glaciological work. Here we dug a snow pit 115 feet deep to study the snow stratigraphy and the depth/density profile.

[Slide 15] To the south of Wilkes a large glacier flowed into Vincennes Bay. [Slides 16-19] It was a 25-mile journey with Weasels and we spent many days there measuring the movement of the glacier which was 2.7 meters per day. [Slide 20-21] To the north of the Windmill Islands the ice sheet exhibited a beautiful ice front terminating in the sea. However, in the winter the fast ice made a lovely highway where one could travel along quite swiftly. It was tempting to explore this area. The first time we ventured forth on this sea ice the weather turn bad with high katabatic winds coming off the ice front so we retreated to the safety of the station. The next morning all the sea ice was gone. We waited several weeks and the sea ice reformed.

[Slide 22] This time we traveled 75 miles to Cape Poinsett. There were some cracks in this meter thick sea ice, [Slide 23] so we put 2x10 boards down and drove across. [Slide 24] Along the way we would stop for a quick lunch. [Slide 25] At one spot we ran across a spectacular sight and that is where the ice front calved tossing sea ice blocks all about. [Slide 26] In this shot one can see the bottom of the iceberg and its very smooth surface and a few boulders. [Slide 27] A large piece of sea ice sits upon an iceberg and in the distance one can see the blocks of sea ice spread out on the fast ice. So at Wilkes we had short trips inland to S-2, to the Vanderford Glacier, and to Cape Poinsett.

The Weasels were a very good form of transportation for the glaciologist but now and then they broke down. Once we were stranded at the Vanderford as the vehicle refused to run and our communications were poor. After 3 days the base sent out a group to find us. We were three men for 3 days in a two-man tent. I froze my feet and they were numb for several months. Another time we had two weasels out at S-2 and neither would start. As there was a D-4 tractor 20 miles away on the Station to S-2 trail the mechanic and I walked the 20 miles and thank goodness the tractor started.

The only real incident at the station was when the ET [electronics technician] Chief Charlton was going through the chow line and the cook Daniels place some chicken on his tray. Charlton threw it back saying he was tired of chicken and that is when Daniels decked him. You must realize that Daniels was cooking for 27 men, three times a day, month after month. He was doing the best he could. He lost his temper and a stripe.

[Slide 28] TO THE INTERIOR OF THE ICE SHEET – QMLT -1964-65

[Slide 29] The first of the South Pole Queen Maud Land Traverses began in December of 1964. There would be two more: 1965-1966 and 1967-1968. The traverse equipment consisted of two large 841 Tucker Snocats, one 742 Tucker Snocat equipped with a drilling unit, two rolligons (which are large wheeled trailers whose tires can hold 500 gallons of fuel each), and four sleds. There were ten personnel – geophysicists, glaciologists, meteorologist, navigator and mechanics. [Slide 30] The traverse began at South Pole Station on 4 December 1964 and traveled in a zigzag route to the Pole of Relative Inaccessibility in 54 days. Travel speed was about 5 miles per hour. There were 180 gravity stations, 29 seismic stations for vertical reflection and a few seismic stations for wide-angle reflection, short refraction and long refraction. There were 29 glaciological stations. [Slide 31] Recorded on the traverse were geophysical data, [Slide 32] glaciological data, and [Slide 33] meteorological data.

[Slide 34] The United States Antarctic Program was emblazoned on the side of the 841 to discourage passersby from stealing the vehicle. [Slide 35] The whole traverse hardware is shown in this shot. [Slide 36] A good view of the rolligon. [Slide 37] The glaciologist is ever digging snow pits and here is Dr. Picciotto doing just that. [Slide 38] The determination of annual accumulation by stratigraphy is very difficult in this part of Antarctica where the accumulation is so low. Note the uneven layers and eroded areas. The accumulation was obtained by measuring the amount of snow above the Castle Nuclear bomb fallout. Accumulation values on the traverse ranged from 6.7 to 3.6 grams per square centimeter per year.

[Slide 39] The surface condition of the ice sheet varied from smooth and soft to [Slide 40] hard and rough. [Slide 41] Sastrugi were sometimes difficult to cross as some were over a meter high.

[Slide 42] Here we have a photo of one of the units of the traverse – the 841, a rolligon, and a sled.

[Slide 43] The interior of the 841 had bunks for 6 people, work space, a kitchen, and table for meals.

[Slide 44] Not all personnel could be seated at once but there was always someone off making measurements or making some necessary repairs.

[Slide 45] Halfway through the traverse additional fuel was needed and drums of diesel were parachuted to us. The red parachute was for the spare parts and mail. This refueling was quite a job as the pallets punched holes in the snow and one had to get in with the barrels and hand pump the fuel to the rolligon tires or directly into a vehicle. [Slide 46] The crew hauls in the mail and spare parts on a banana sled past some tents. Inside the vehicles it was quite warm and so for comfortable sleeping many preferred a tent.

[Slide 47] The 742 had the drill rig with which we were able to drill to a depth of 40 meters. These holes were used by the glaciologists for density and temperature measurements and then the geophysicists utilized them as shot holes for their seismic work. [Slide 48] Drilling of these holes was one of the coldest tasks on the traverse as can be attested by this driller. [Slide 49] Of course another cold task is pictured here where by the time you have your pants back up man was they have been filled by drifting snow.

[Slide 50] The Pole of Relative Inaccessibility (Elevation 3718 meters) was reached on January 28, 1965. Note the statue of Lenin atop the drilling tower. After such a long trip a little play was necessary so the navigator is sighting his theodolite on the centerfold of a *Playboy* magazine. The snow accumulation in central East Antarctica is low. [Slide 51] Here the glaciologist is measuring the depth from the surface to the base of the weather shelter placed by the Russians in 1958. The accumulation rate calculated was 3.6 grams per square centimeter per year. [Slide 52] The air temperatures during the traverse ranged from -18.2 to -44.7 degrees Centigrade. [Slide 53] The late Dr. Edgard Picciotto was the geochemist-glaciologist who pioneered the use of radioactive fallout for determining snow accumulation.

This was a successful traverse with a considerable amount of scientific data obtained and with no injuries to the members. One chap became ill with a troublesome cough indicative of a serious upper respiratory problem and as we would receive only one C-130 flight where there would be a landing, I requested a replacement for him and the sick man was flown out. I was concerned about pneumonia and at these high elevations it can be fatal. Upon arriving at the Pole of Relative Inaccessibility I became sick and got down on my hands and knees and vomited. I believe this was a combination of being over tired and I am not too good at high elevations. After these few moments I was okay.

The vehicles were prepared for the winter and would remain there for the next season's team to carry on with Queen Maud Land Traverse 2.

# Short Trips and a Traverse

Dick Cameron

1

At the Edge of the Ice Sheet

Wilkes Station

1957

2







7



8



9



10









15



16



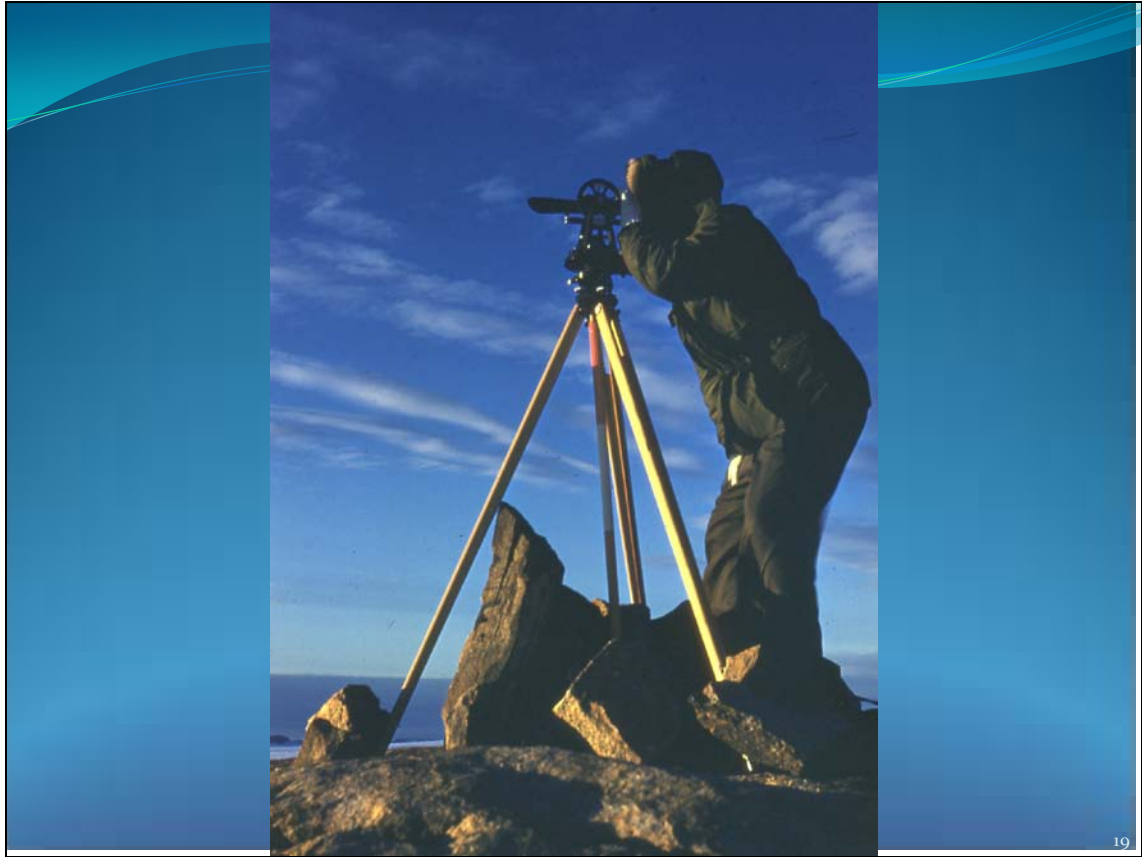

19



20



21



22

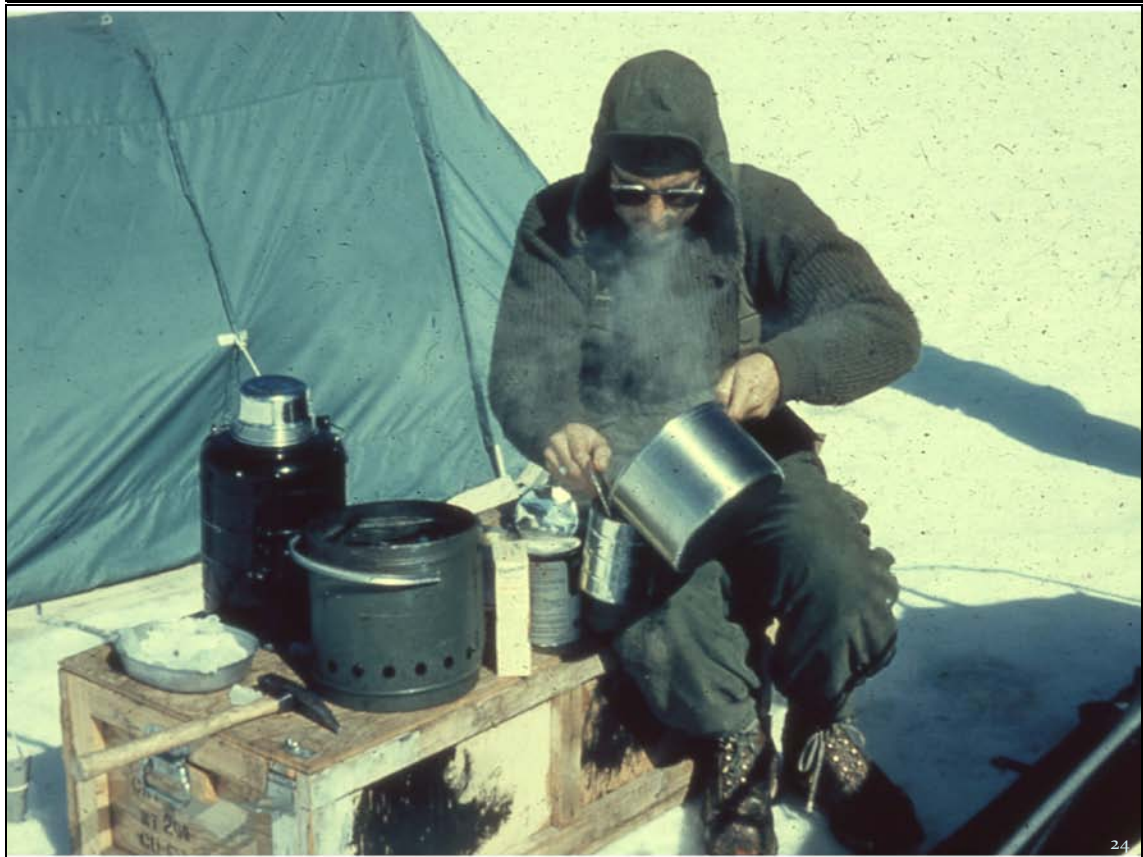



25



26





## To the Interior of the Ice Sheet

Q M L T  
1964-1965

28



29

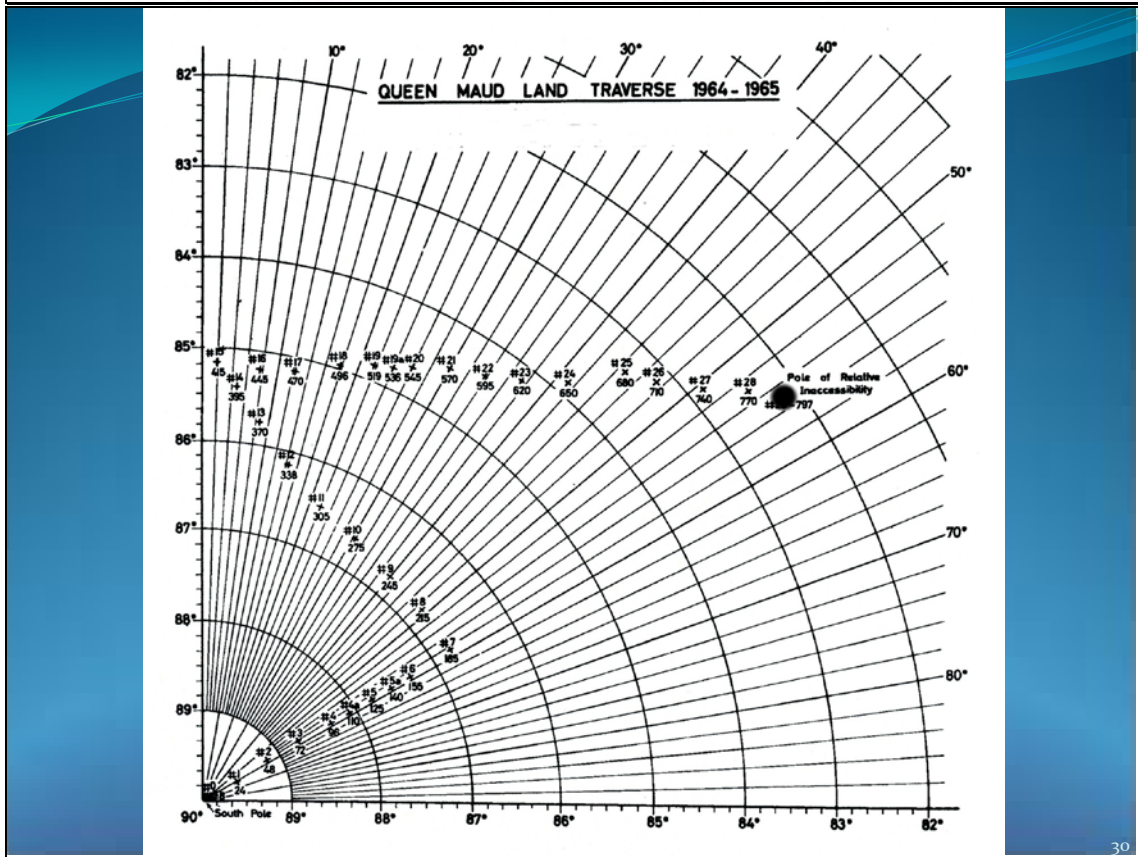

30

# Recorded on Traverse

## Geophysical Data

- Surface Elevation – Altimeters
- Ice Thickness
  - Seismic
  - Gravity
- Magnetics
- Nature of Upper Crustal Layers
  - Seismic Long Refraction

31

## Glaciological Data

- Snow Accumulation
  - Stratigraphy
  - Nuclear Test Debris Horizon 1954
    - (using  $^{240}\text{Pb}$  Unstable Isotope Method)
- Depth/Density Curve to 40 Meters
- Mean Annual Air Temperature
  - 10 - Meter Temperature

32

# Meteorological Data

- Temperature
- Wind
- Cloud Cover
- Visibility
- Solar Halos

33





35

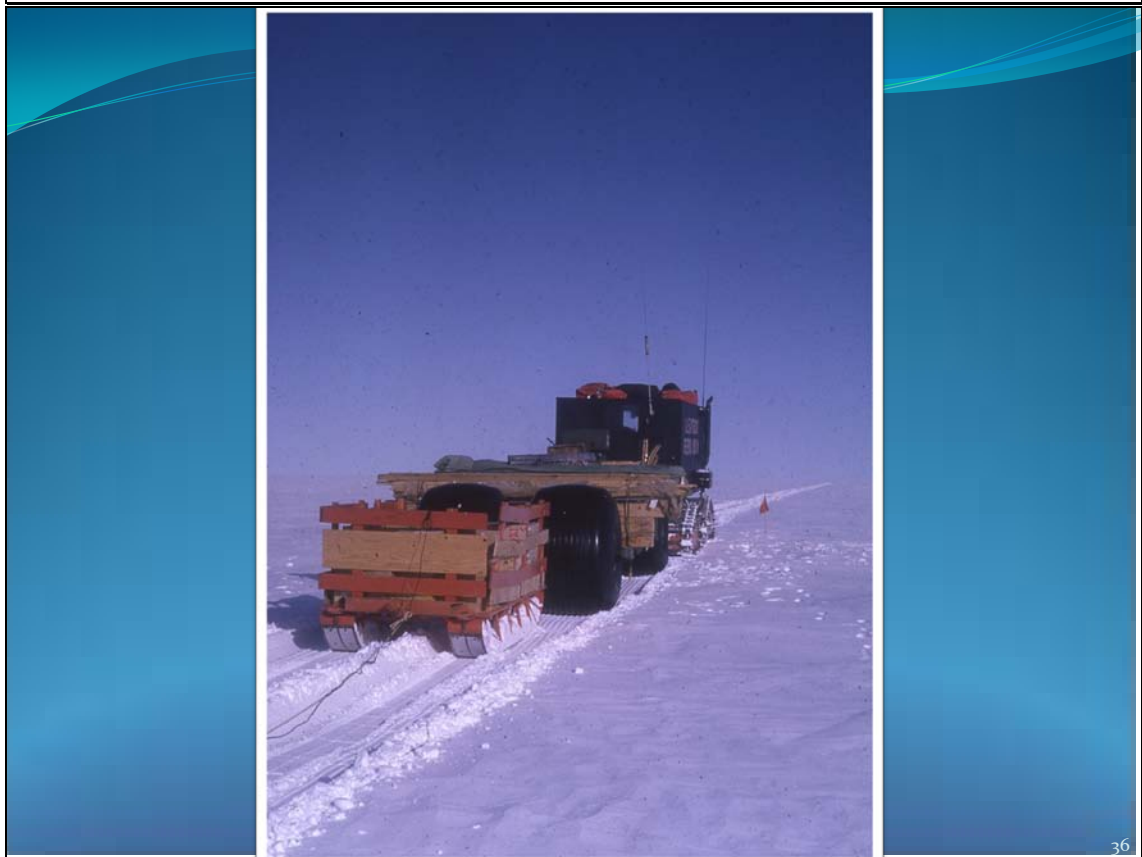

36

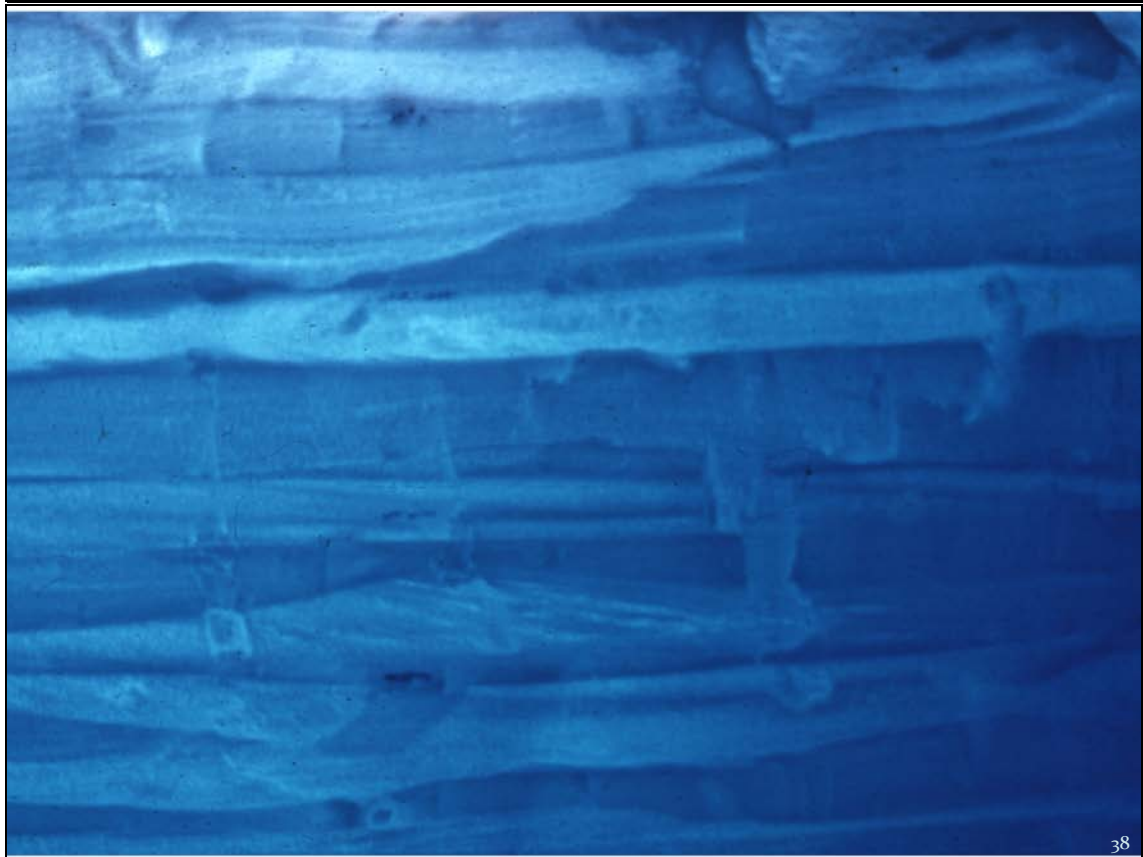



39



40



41



42





43



44





47

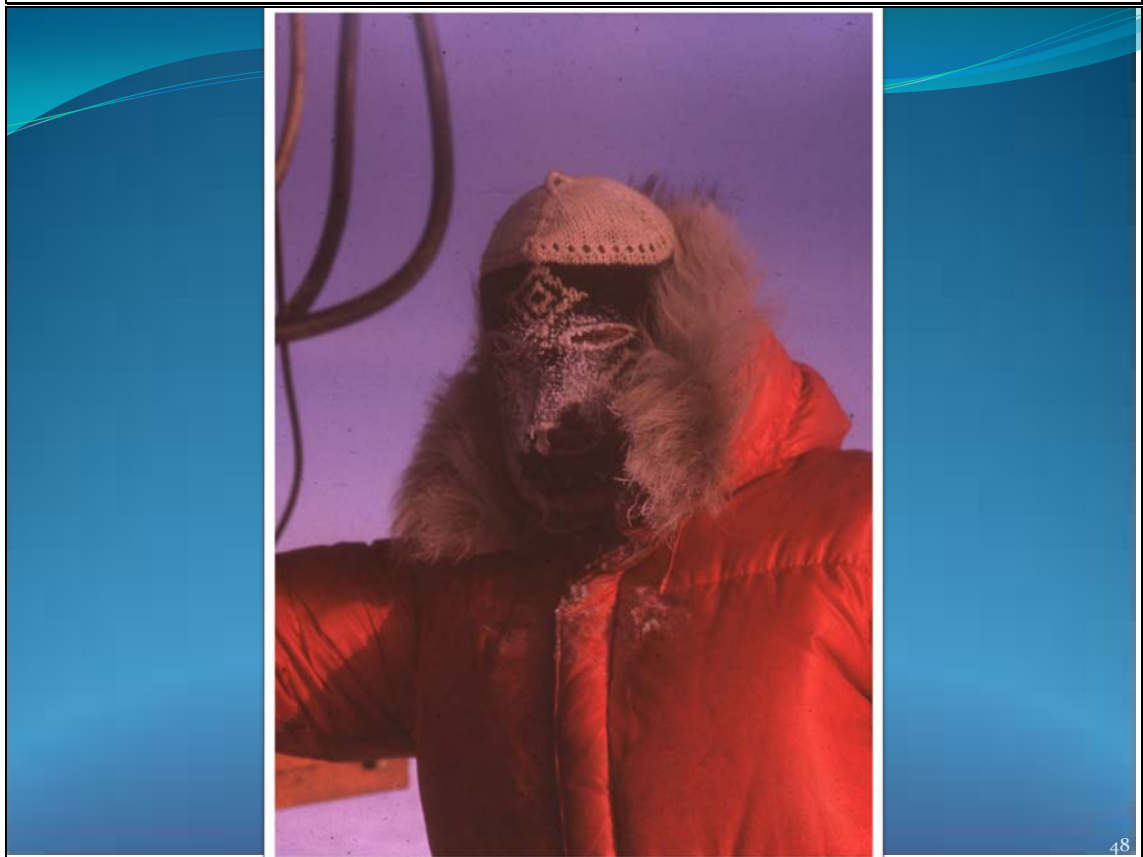

48



49

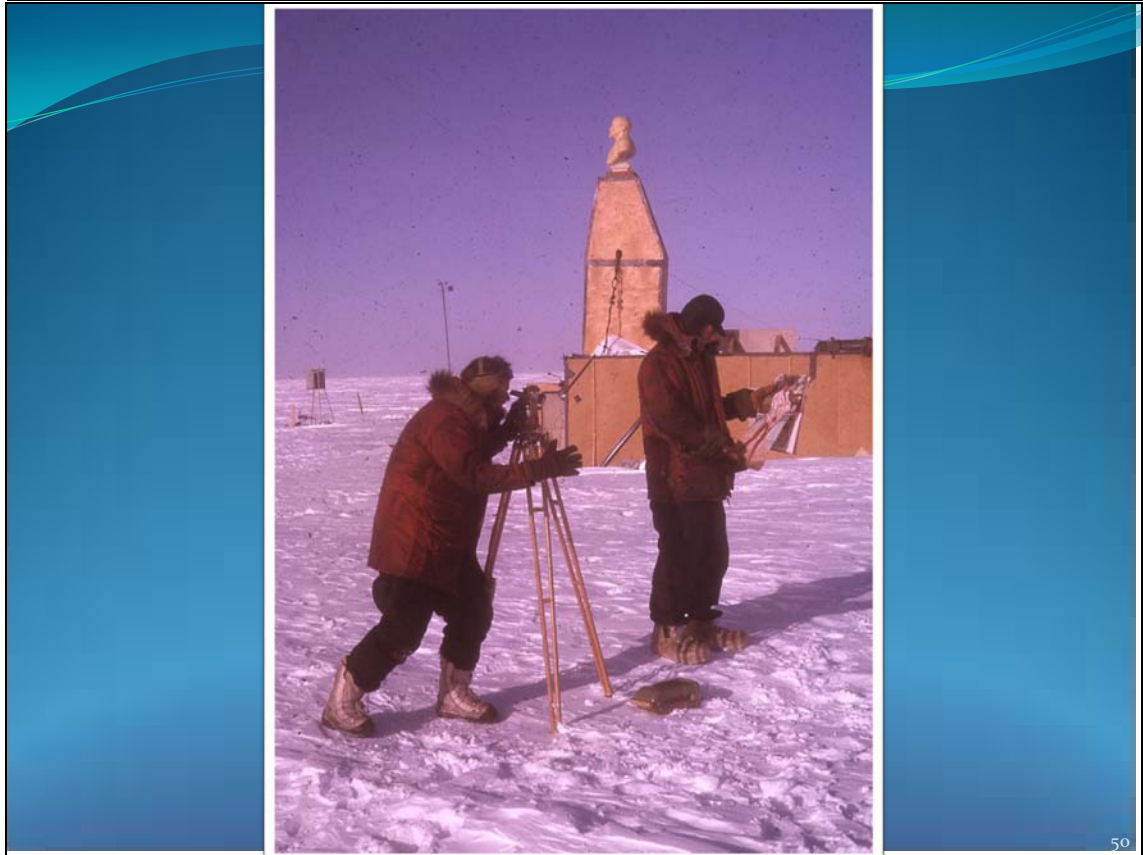

50



51

### QMLT 1964 - 1965

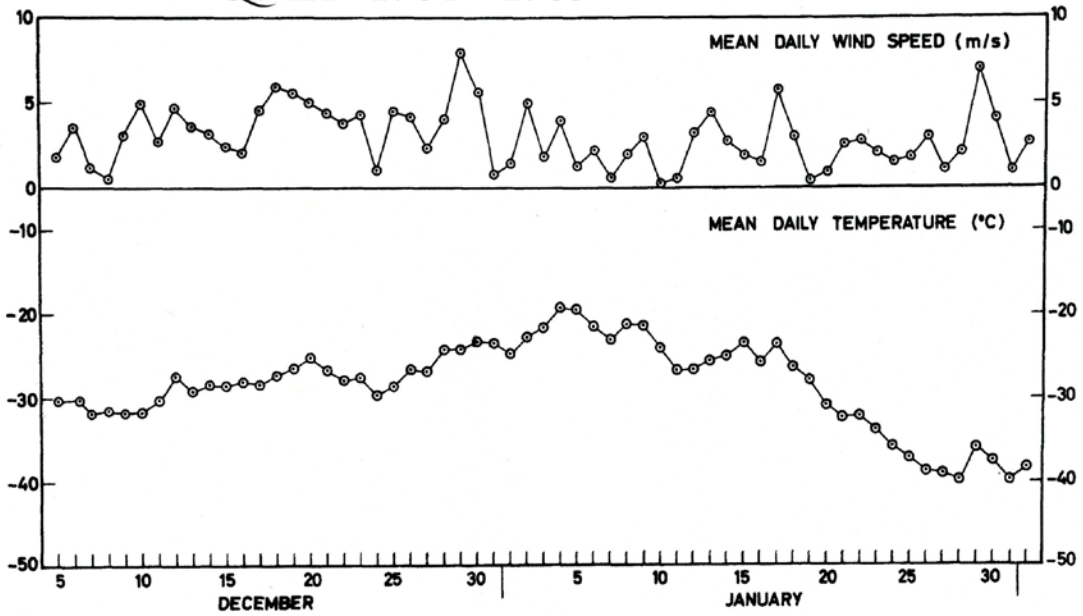

52

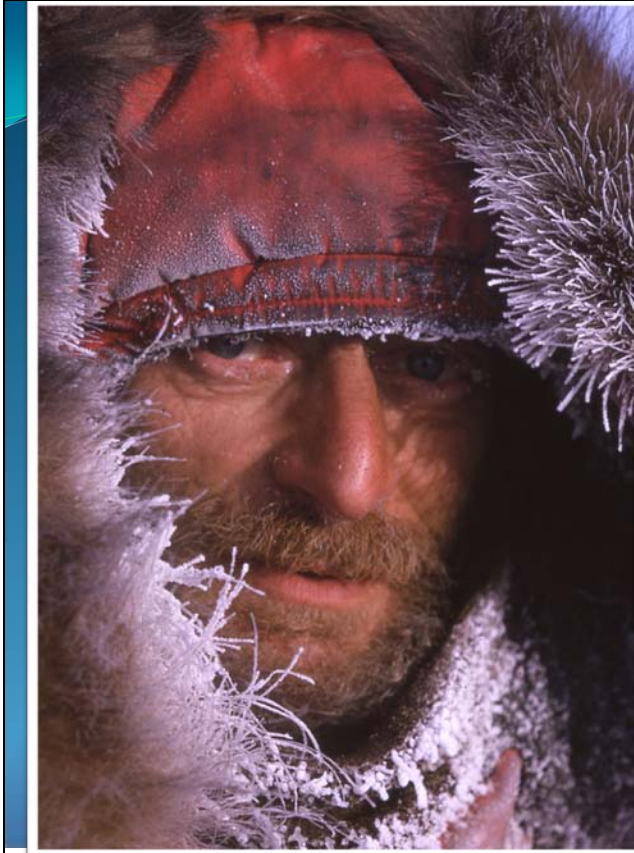

The late  
Dr. Edgard Picciotto  
Geochemist

53

## **A5 – Presentation of Gary Lofgren**

### ***Geologic Traverse Planning for Apollo Missions***

[Slide 1] Geologic Traverse Planning for Apollo Missions, Gary Lofgren

[Slide 2] The science on Apollo missions was overseen by the Science Working Panel (SWP), but done by multiple PIs. There were two types of science, packages like the Apollo Lunar Surface Experiment Package (ALSEP) and traverse science. Traverses were designed on Earth for the astronauts to execute. These were under direction of the Lunar Surface PI, but the agreed traverse was a cooperation between the PI and SWP.

The landing sites were selected by a different designated committee, not the SWP, and were based on science and safety. As experience and confidence was gained, later mission were more “daring”.

[Slide 3] Once the site was picked, the Lunar Surface PI worked with SWP and flight operations to script the traverses. Unlike field geology on the Earth, these traverses were highly scripted. The Lunar Surface PI was responsible for training the crew, CapCom, and backroom scientists to meet the science objectives of the landing site.

[Slide 4] The training of the crew became a critical aspect of success. Except for Apollo 17, we were dealing with a group of astronauts that were primarily pilots. They were very smart, but they did not have a geologic background. So it was necessary to develop a crew training program with the aspects listed here that allowed the team (crew, CapCom, scientists, etc.) to get the job done.

We started out carefully and as we gained experienced added more to the program. Later mobility allowed for more possibilities, but also meant more planning and training.

[Slide 5] These are the field trip locations used to train the astronauts. Each location was picked to represent one of the aspects of the science to be done or the geology the astronauts would experience.

Field training was basically 3- to 6-day field trips once a month for 18 to 24 months. This resulted in over 1000 contact hours with the Apollo crews.

[Slide 6] We made the training realistic by having the astronauts trained wear volumetric representations of their suits. This version had their life support backpack, chest-mounted camera, and sampling tools. They also had communications similar to what they would have on the moon. Since the Hasselblad cameras did not have a view finder, it was important for the astronauts to learn how to get the object they wanted into the field of view by positioning their body.

[Slide 7] We worked to find field locations that could duplicate the view the astronauts would see on the moon. Here the Grand Canyon near Taos, NM, stands in for Hadley Rill; the view across the canyon is the same scale as what the Apollo 15 astronauts would see on the moon.

[Slide 8] Sampling techniques were practiced in detail using realistic tools, including using a simulated lunar vehicle from the US Geological Survey (USGS).

[Slide 9] One of the important things was the debriefings that came at the end. The crew would walk through entire traverse again with the scientists. They would discuss with the astronauts what they did well and what they could improve.

[Slide 10] The most important result was that the astronauts gained confidence in what they were doing. This included not only the science, but also the tools and the techniques for using them effectively. The sample gathering activity became second nature to them – automatic – which improved efficiency and accuracy. The training also gave them confidence in working with a highly scripted timeline; knowing that there were limits to certain activities and that sometimes they needed to move on.

Pre-flight orbital photography of the landing site was not that good; the crew had sufficient confidence to adapt once they saw what was really there.

Getting the mission commander on board with training was important and, in the end, they were one of the people pushing to make sure that training was included.

We learned that bringing the flight directors and other front room personnel out to the training about 4 months before the flight helped get everybody synced to what needed to be done. Training should include everyone in the support chain working together.

[Slide 11] The science support and backroom support was an important activity, but was not real-time. The communication needed to follow a route through several people (flight directory, CapCom, etc...) and was limited by quality and amount of video. I expect that this will change for our future exploration of the moon.

The backroom support was most used to help with replanning when problems occurred – advising on how to fix equipment and replanning of traverse sequences.

[Slide 12] A body is needed to settle disputes concerning science priorities. During Apollo, the SWP set the priorities and made the decisions as to what had priority when replanning was needed.

As the mission went on, the scientist would come up with more suggestions for sample collection; such as get sample from under other rocks or in shadows. Some of these suggestions started being made real-time. The SWP was responsible for deciding on the inclusion of these ideas.

We will need to decide what sort of overarching science committee model is appropriate for future lunar exploration. One close to the Apollo model is probable, but with better communications may allow more real-time interactions/support.



# **Geologic Traverse Planning for Apollo Missions**

**Gary Lofgren,**

Planetary Scientist  
Lunar Curator

Astromaterials Acquisition. & Curation  
Astromaterials Research and Exploration Science  
NASA Johnson Space Center

1

## **How was Science Done on Apollo** science by several different committees experiments by individuals

**Science PIs: Experiments were the work of individual  
science PIs, selected by committee**

**Throughout Apollo there were many science PIs**

**Landing sites chosen by a committee for that purpose**

**Surface geology and traverse planning was a PI  
experiment, but approved by committee**

**Crews were chosen by Flight Operations**

**Astronaut training was done by surface PI**

2

## Site Traverse Planning

Landing sites were restricted to near the equator

Each landing site had Specific Science Objectives

Field Geology PI had the task of meeting the Science objectives for a site

The FGPI planned the traverses based on photo geology

A high level science review board reviewed the traverse planning and defined specific experiments

FGPI Trained the Crew, Capcom, and BR scientists to meet science objectives

3

## Crew Training Critical

Problem solving: The geologic thought process in field

Common language: Do you have the words that work

Observation skills: Can you describe what you see

Train the Crew, Capcom, Scientists together

Realistic simulated traverses, science back room, debrief

Practice routine procedures:

- Navigation, follow the map, photo panoramas

- Collecting, documenting rock and soil samples

- Description from small to large scale features

- Repetition, repetition, repetition

Classes in moon rock type recognition

Detailed discussion of mission objectives

4

# Geologic Field Training Sites

## Volcanic Craters and Flows

Coso Hills, CA  
Hawaii  
Rio Grande Gorge Taos, NM  
Buell Park, AZ  
Kilbourne Hole,  
Ubehebe Crater, Death Valley, CA  
Flagstaff, AZ (3 times)

## Plutonic (Crustal) Rocks

No. Minnesota  
San Gabriel Mtns., CA  
San Juan Mtns., CO

## Craters, impact & explosion

Meteor Crater, AZ  
Medicine Hat, Canada  
Nevada Test Site

## General, Surface Features

Orocopia Mtns., CA  
Mojave Desert, CA

Each trip 3-6 days including travel time

Over 30 people participated in A-15 training

5



6



7



8

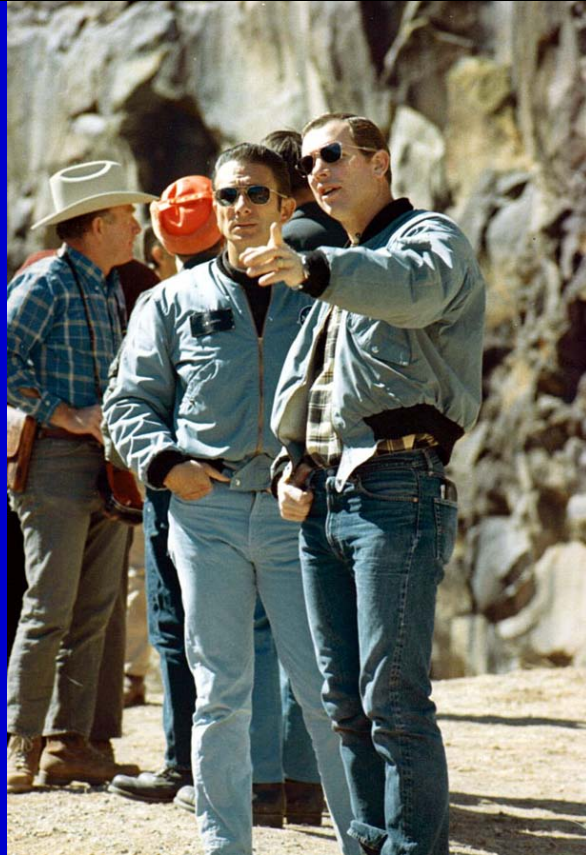

9

## **How Well Did It Work**

**Confidence in their understanding the mission science objectives and knowledge of how to succeed**

**Built rapport with scientists and a common language**

**Astronauts became a stakeholders in achieving objectives**

**Confidence in the tools and how to use them effectively.**

**Learned to work with highly subscribed timeline requiring high efficiency and focus on objectives**

**In short, became field geologists**

10

## **Science Support/Backroom**

The concept and the practice evolved, matured?

Formal Science BR 10 or so people that followed activities and were ready to advise

What BRs: Separate with own channels of communication

Field Geology PI

Surface ALSEP PIs

Orbital PIs

Communicated thru formal channels, e.g. Lovell to Flight director to CapCom for Field Geology PI

Limited information, voice and TV where available

Limited input, usually in response to questions or necessary changes to traverses due to problems.

11

## **Overarching Science Committee**

The committee evolved, matured?

Needed a body to settle disputes between the science priorities of different science objectives

Surface Working Panel (SWP) Set Priorities

Reviewed FGPI traverse planning

Decided what experiments would be deployed

Special sample collection

Interfaced with engineers somewhat, again evolved

Defined sample collection procedures and needs

Had a representatives in the Science BRs, real time priorities

12

## **A6 – Presentation of Friedrich Horz**

### ***Desert Research and Technology Studies (DRATS) Traverse Planning***

[Slide 1] The Desert Research and Technology Studies (DRATS) include large scale field tests of manned lunar surface exploration systems; these tests are sponsored by the Director's Office of Integration (DOI) [sic, Directorate Integration Office (DIO)] within the Constellation Program and they include geological exploration objectives along well designed traverses. These traverses are designed by the Traverse Team, an ad hoc group of some 10 geologists from NASA and academia, as well as experts in mission operation who define the operational constraints applicable to specific simulation scenarios.

[Slide 2] These DRATS/DOI tests focus on 1) the performance of major surface systems, such as rovers, mobile habitats, communication architecture, navigation tools, earth-moving equipment, unmanned reconnaissance robots etc. under realistic field conditions and 2) the development of operational concepts that integrate all of these systems into a single, optimized operation. The participation of "science" is currently concentrating on geological sciences, with the objective of developing suitable tools and documentation protocols to sample representative rocks for Earth return, and to generate some conceptual understanding of the ground support structure that will be needed for the real time science-support of a lunar surface crew.

[Slide 3] Major surface systems exercised in the June 2008 analog tests at the Moses Lake site, WA. [Upper left] The Chariot Rover (developed at Johnson Space Center) is an unpressurized vehicle driven by fully suited crews. [Upper right] Mobile Habitat provided by the Jet Propulsion Laboratory. Chariot is the more nimble and mobile vehicle and the idea is to drive the habitat remotely to some rendezvous place where Chariot would catch up – after a lengthy traverse – at the end of the day. [Lower left] The K-10 remotely operated robot (provided by NASA Ames Research Center) conducting scientific/geologic reconnaissance of the prospective traverse region, locating specific sites for more detailed exploration by Chariot and its crew. [Lower right] This earth-moving equipment (provided by NASA KSC) can be attached to Chariot and is envisioned to, for example, level an outpost site or to mine lunar soil.

[Slide 4] DRATS tests at Black Point Lava Flow (BPLF), Flagstaff, AZ, in Oct. 2008; featuring the Small Pressurized Rover (SPR). The latter allows the crews to drive in short-sleeve comfort and carries sufficient consumables to support the crews for a few days and nights. The astronauts egress and ingress the rover cabin via novel "suit ports" that allow them to step into their EVA-suits from inside – and after closing some seals, to step onto the lunar surface within approximately 10 minutes.

[Slide 5] Fully suited crews conducting field work at BPLF in Oct. 2008. [Upper left] Note the suit port "opening" on the rover and the fixed plates on the astronauts' back packs that interface with/seal against this opening. [Lower left and Right] The geology field tools very much resemble those used by Apollo; however, the Hasselblad film cameras were replaced by modern video cameras mounted onto the back packs (above the astronauts' right shoulder). As a consequence, the present science "back room" will receive in real time continuous, multiple video streams, including those from rover-mounted video cameras, as opposed to Apollo when all surface photography could only be seen after the films were developed following return to Earth.

[Slide 6] The traverse planning process starts with photogeologic mapping of an area and the definition and prioritization of the scientific objectives; no ground observations are allowed in this process, unless acquired via remotely operated robot; typically some 10 geologists are involved in these activities. A set of preliminary traverses is then repeatedly iterated between science and operational interests, until a final

traverse emerges that complies with the capabilities and constraints of all surface systems being exercised.

[Slide 7] Major operational constraints that applied for the DRATS 2008 traverse planning.

[Slide 8] Location of Black Point Lava Flow in Northern Arizona, some 40 miles NE of Flagstaff, and part of the San Franciscan Volcanic Field. The relatively young flow is scarcely vegetated, a prerequisite for good rover mobility as well as good rock exposures, thus approximating lunar surface conditions.

[Slide 9] Photogeologic units and maps of the general region as determined by the Traverse Planning Team.

[Slide 10] More detailed photogeologic map of the actual DRATS 2008 test area.

[Slide 11] Example of a typical traverse plan originating and ending at Base Camp (red dot), indicating the specific route to be taken to reach individual stations (numbers), with each station serving specific geologic objectives. This Google Earth-based traverse plan is being displayed on board the rover and used by the crew to navigate.

[Slide 12] Excerpt from a typical traverse plan describing what the crew has to do and observe at a given station, such as Station 1a of traverse SPR. Again: these instructions are available to the crew as text-boxes at any marked location in the Google Earth-based traverse map. The purpose of this slide is to illustrate the detail of planning that goes into the DRATS traverses. Not shown is the detailed time line that is part of this plan; it is generally Mission Control that controls this time line during the actual traverses and that implements any deviations from the nominal plan.

[Slide 13] Traverse plans for the DRATS 2009 campaign. The latter demonstrated the capabilities of current systems to support a continuous, 14-day lunar mission; significantly, the crew worked, ate, and slept inside the rover cabin for a solid 2 weeks and exited only in fully suited configuration to do geological exploration and vehicle maintenance. Total traverse distance was some 135 km. The tent symbols indicate overnight camps, the tear shaped symbols individual geology stations; Base Camp is again marked by a red dot.

[Slide 14] Examples of real-time video images displayed in the DRATS 2009 Science Support Room (SSR), which was located at Base Camp and manned by 7 scientists. Up to 6 separate cameras could be accessed simultaneously by the SSR; the real-time management, analysis and interpretation of these multiple video streams represents a major challenge for efficient back room operations, and constitutes a dramatic departure from Apollo.

[Slide 15] Example of a typical field scene obtained from a suit-mounted video camera (note field of view is partly blocked by astronaut's helmet; the blue pants belong to a geologic field observer, who silently monitors the activities for subsequent constructive critique at the end of the day). Note the textural and structural detail of diverse basalt boulders that are being revealed by modern, suit-mounted video cameras.

[Slide 16] Close up image of a basalt fragment obtained with a suit-mounted video camera. This image illustrates the richness of detail and information that can be obtained via modern digital cameras and that will have to be processed and interpreted by the SSR in essentially real time.



[Slide 17] Inside the DRATS 2009 SSR illustrating the CoI, PI, and SCICOM “stations”.

[Slide 18] Role assignment of the DRATS 2009 Science Support Room; the latter was located in the Mobile Mission Control Center (MMCC), a giant, enclosed trailer that has been developed and installed at NASA JSC and KSC, and that was hauled to the field site/Base camp at Black Point Lava Flow, AZ. The SSR had 7 “operational” functions and seats, all equipped with dedicated PCs and dual monitors. One wall was occupied by the *Field Geology PI*, his *CoI* (who are responsible for all scientific matters) and the science communicator (*SCICOM*; the only person who talked to the crew in the field). The other wall was occupied by “specialists” that kept track of all *rocks* collected, that operated the high-resolution *panoramic still camera* (Giga Pan) on top of the rover’s central mast, and that monitored all geologic “structures” visible in the *suit-mounted cameras* and additional cameras on the rover. An *OPSLINK* position communicated with Flight Control next door and informed the SSR about all non-scientific matters, such as time lines, navigation/position data, and/or any anomaly that would override the nominal traverse plan.

Summary: Detailed traverse planning not only supports the integration and simultaneous operation of diverse engineering systems during NASA’s analog field tests, but the latter provide significant opportunities also for the conceptual development of future science operations. Simultaneous streams of multiple video and still cameras have to be processed, analyzed and interpreted in essentially real time, a major challenge that needs further development and study. The present activities also develop a cadre of experienced operator-scientists that will eventually design the detailed surface operations of the future.

# **Desert Research and Technology Studies (DRATS)**

## **TRAVERSE PLANNING**

Friedrich Horz  
ESCG Group  
Houston, TX  
Aug. 4, 2009  
LPI Workshop

1

### **Purpose of Analoge Field Studies:**

**Conceptual Advancement of Technology Systems**

e.g. Rover

Communication (voice; video)

Unmanned robots

**Conceptual Development of Mission Operations, including**

**Science Operations**

e.g. Tools

Sampling and Documentation Protocols

Ground Support/Science Backroom

**Integration of all Systems and Implications for Constellation  
Architecture**

2

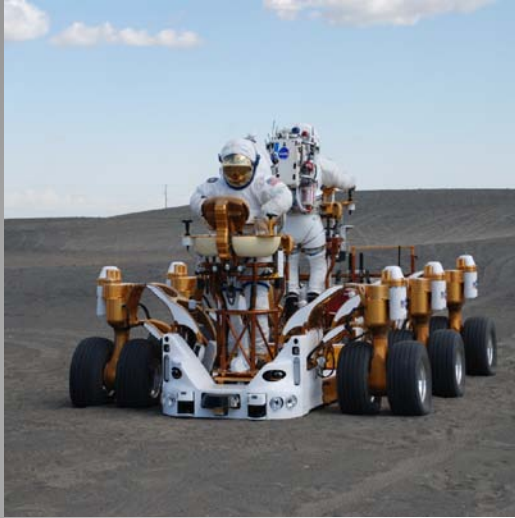

3



4



5

## Traverse Planning: Approach

### Science Objectives:

- Produce Geologic Map from Remote Sensing Data
- Interpret Origin of Photo-Geologic Units
- Establish Science Objectives and their Priorities
- If available: Robotically Acquired Ground Observations

### Preliminary Traverses:

- Determine Points of Interest
- Select those Points most Suitable for “Stations”
- String these Stations into some logical Flow
- Determine Driving Times
- Iterate and Re-arrange until suitable Station Times (typically > 30 min) result that meet the Science Objectives.

### Final Traverses:

- Repeated Iterations with Diverse Operational Elements to define formal Overhead Times and Navigation Data
- Load into Google Earth Based Navigation System on LER

6

# Traverse Constraints

**Terrain :** Accessible by Rover

**Mobility:** Rover Speed some 4 km/h

**Crew Day:** 15 hours

**In Suit :** 8 hours/day

**Egress/Ingress:** 15/10 min ea

**Diverse Technology Demonstrations**  
e.g. Recharging  
Docking with Habitat  
Loss of Signal

7

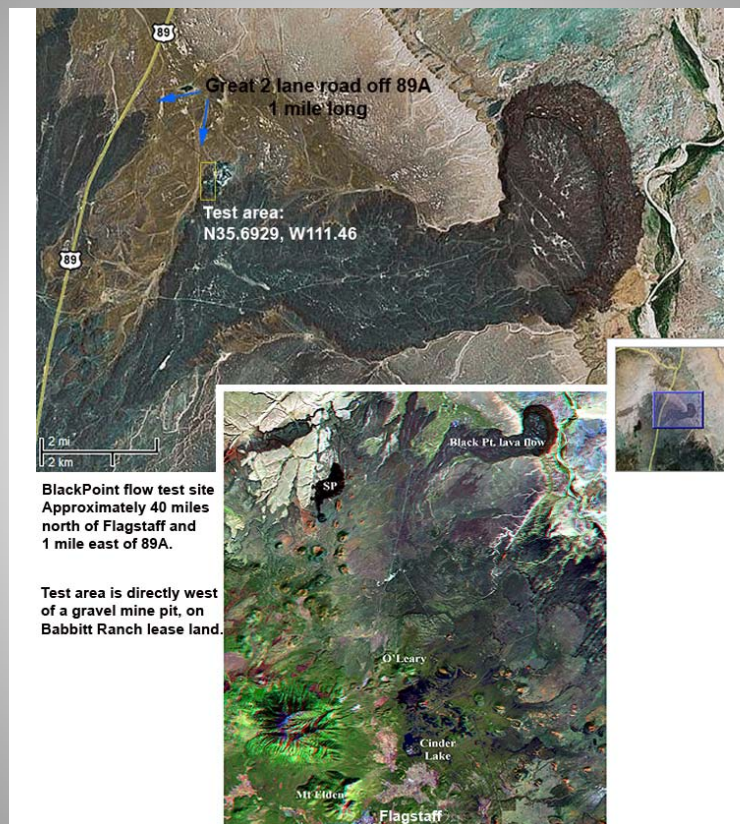

8



9

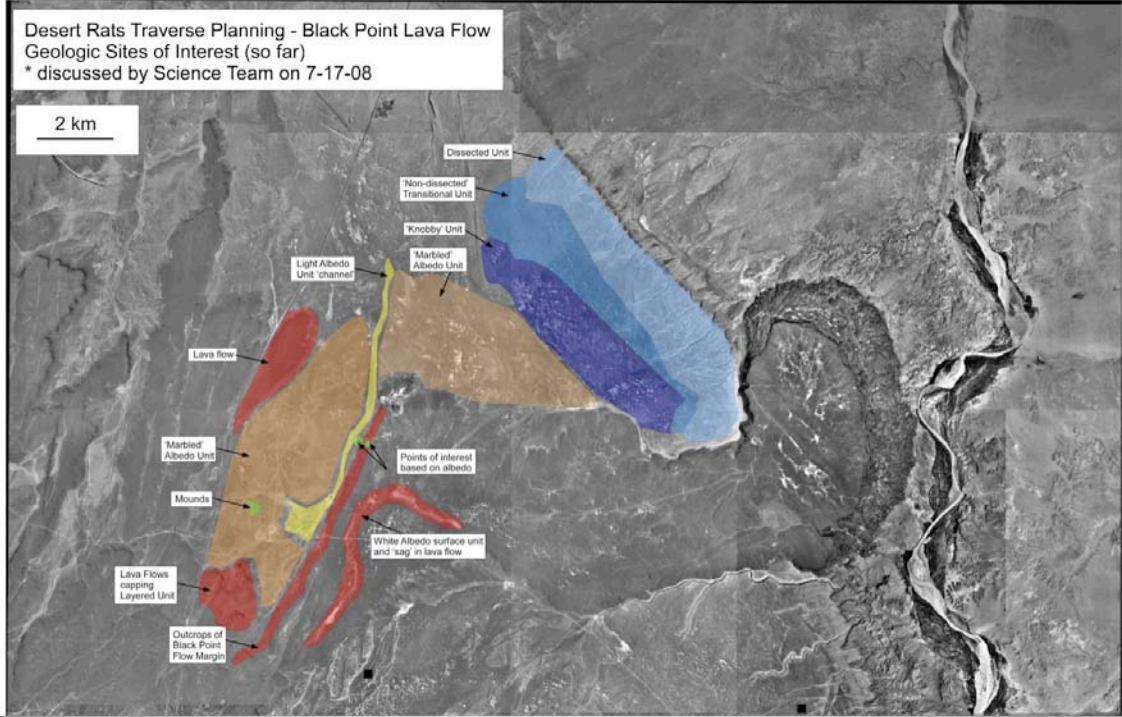

10

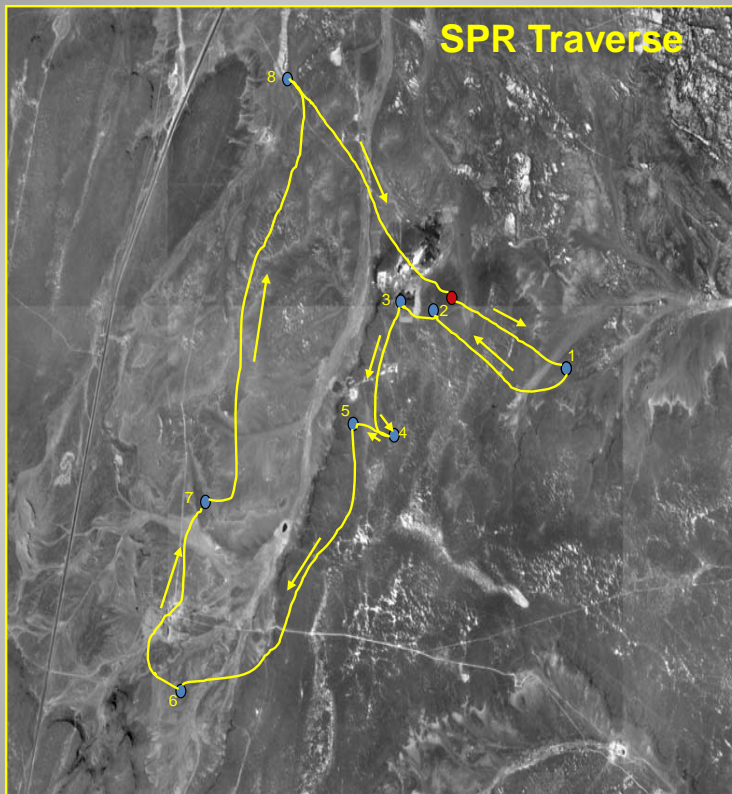

11

## SPR TRAVERSE

9:30 Hours

### DETAILED TASKS

**RED:** Instructs crew to egress and ingress

**Blue:** Brief comment regarding relation to major science objective(s)

**Bold:** Major tasks (to be incorporated into cuff check list)

*Normal font:* specific suggestions and pointers

Drive A (including test drive):

Comment on vehicle performance and trafficability issues (surface relief;  
boulders, vegetation etc)

Comment on possible lava-flow features

**EV 1: Remain inside**

**EV 2: Egress**

Station 1a)

Describe general morphology and geological setting of BPLF and MU

What do you see along the planned traverse and at (what?) distances  
beyond, including the horizon?

Detailed description of BPLF:

How thick?

How extensive? (how far to the S?)

Any obvious stratification?

Detailed description of MU:

Is it layered and at what scales?

Does it look like a volcanic or sedimentary deposit?

Is the contact of BPLF and MU exposed and accessible anywhere?

**EV2:** Collect 2-5 representative samples from the top of BPLV

Describe textural diversity of samples, e.g. color, grain size, vesicles,  
vugs, lineations, identifiable minerals including phenocrysts

12

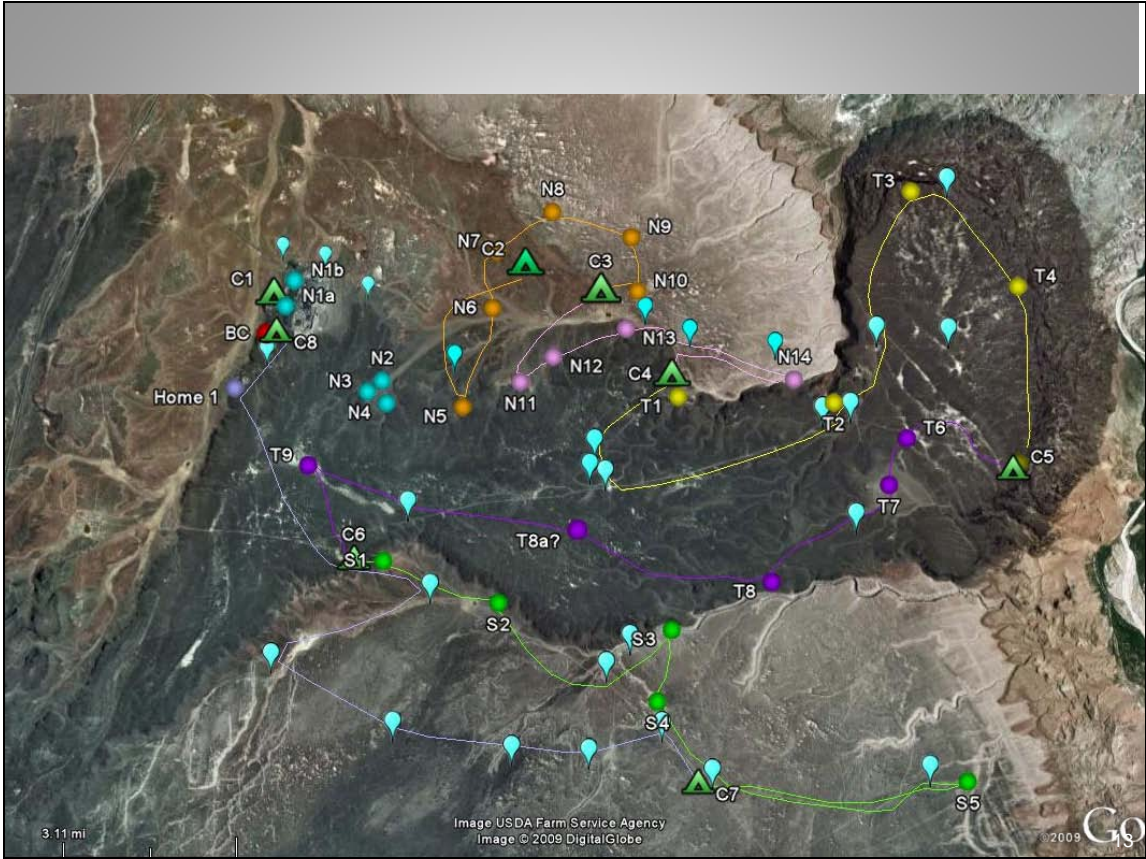

# EVA Suit Camera Live Display

Live image displays from  
Network Video Recorder (NVR)

Quad or single display









17

	Seat 1	Seat 2	Seat 3	Seat 4	Seat 5	Seat 6	Seat 7	Seat 8	Field 1	Field 2	Field 3	
	Co I	PI	SCICOM	Giga Pan	Structure	Petrograph	TBD/OBS	OPSLink				
Aug.28	Dry Run	Rice	Kring	Lee	Hurtado	Hynek	Evans	K10	Lofgren	Horz		
Aug. 29	N1, B	Rice	Kring	Lee	Hurtado	Hynek	Evans	K10	Lofgren	Horz	Hodges	Cohen
Aug. 30	W2, B	Kring	Rice	Lee	Hodges	Hynek	Evans	Cohen	Horz	Lofgren	Hurtado	Lee
Sept. 2	W1, A	Kring	Rice	Eppler	Hodges	Hurtado	Cohen	K10	Horz	Lofgren	Hynek	Evans
Sept.3	N2, A	Rice	Kring	Eppler	Hodges	Hurtado	Cohen	K10	Lofgren	Horz	Ming	
Sept.4	N, Day 2	Hurtado	Kring	Eppler	Hynek	Evans	Cohen	Ming	Horz	Lofgren	Head	
Sept.5	N, Day 3	Hynek	Kring	Ming	Evans	Hurtado	Cohen	Head	Lofgren	Horz	Bell	Gruener
Sept.6	Top; Day1	Ming	Horz	Hurtado	Hynek	Bell	Gruener	Head	Lofgren	Kring	Cohen	Eppler
Sept.7	Top;Day2	Cohen	Lofgren	Hynek	Hurtado	Evans	Gruener	Head	Horz	Eppler	Ming	
Sept.8	S, Day1	Ming	Rice	Cohen	Hynek	Gruener	Bell	Evans	Eppler	Kring	Horz	
Sept.9	S, Day2	Evans	Rice	Eppler	Ming	Gruener	Bell	TBD	Horz	Kring	Lofgren	

18

## A7 – Presentation of Marie-Claude Williamson

### *Science Traverses in the Canadian High Arctic*

[Slide 1] Science Traverses in the Canadian High Arctic, Marie-Claude Williamson (Canadian Space Agency); Current address: Central Canada Division, Geological Survey of Canada.

[Slide 2] The presentation is divided into three parts.

Part I is an overview of early expeditions to the High Arctic, and their political consequences at the time. The focus then shifts to the Geological Survey of Canada's mapping program in the North (Operation Franklin), and to the Polar Continental Shelf Project (PCSP), a unique organization that resides within the Government of Canada's Department of Natural Resources, and supports mapping projects and science investigations. PCSP is highlighted throughout the presentation so a description of mandate, budgets, and support infrastructure is warranted.

In Part II, the presenter describes the planning required in advance of scientific deployments carried out in the Canadian High Arctic from the perspective of government and university investigators. Field operations and challenges encountered while leading arctic field teams in fly camps are also described in this part of the presentation, with particular emphasis on the 2008 field season.

Part III is a summary of preliminary results obtained from a Polar Survey questionnaire sent out to members of the Arctic research community in anticipation of the workshop. The last part of the talk is an update on the analog program at the Canadian Space Agency, specifically, the Canadian Analog Research Network (CARN) and current activities related to Analog missions, 2009-2010.

[Slide 3] This slide shows the position of Axel Heiberg Island, in the Canadian Arctic Archipelago, on the General Bathymetric Chart of the Oceans (GEBCO) bathymetric map of the Arctic Ocean (Jakobsson et al. 2000). The island is separated from Ellesmere Island by the Nansen Sound. Most of the field work illustrated in the presentation was carried out in western and central parts of the island. Axel Heiberg Island and Devon Island are both uninhabited islands of similar areal extent:

Axel Heiberg Island:	43,178 km <sup>2</sup>
Devon Island:	55,247 km <sup>2</sup>
Ellesmere Island:	196,235 km <sup>2</sup>

GEBCO website: <http://www.ngdc.noaa.gov/mgg/bathymetry/arctic>

This is my favorite map simply because I lived in an oceanographic institute and it includes the study area for my doctoral degree. On this polar projection, some important physiographic features of the Canadian Arctic Islands are worth noting:

1. The narrow polar continental shelf, adjacent to a large sedimentary basin that underlies most of the Arctic archipelago, the Sverdrup Basin –
2. the proximity to Greenland, across the Nares Strait,

3. The Canada and Eurasia Basins. The Lomonosov Ridge, Alpha Ridge, just north of Ellesmere Island, and Chukchi Plateau. The red dot indicates the locations of Axel Heiberg Island, topic of most of this presentation.

[Slide 4] This slide shows the chronology of events leading to Norway's claim of the Sverdrup Islands under international law in 1928. Captain Sverdrup and his predecessor, Fridtjof Nansen, were the first to explore the islands located west of the Nansen Sound (Kenney, 2005).

The *Fram* Expeditions (under Nansen and Sverdrup) were sponsored by the Norwegian Consul, Axel Heiberg, and the Ringnes brothers (Ellef and Amund) of brewing fame. The *Fram*'s Second Arctic Expedition, under the command of Otto Sverdrup started on June 24, 1898, and lasted four winters. The expeditions formed the basis for a Norwegian claim to the area.

[Slide 5] Although Otto Sverdrup and the *Fram* crew explored a much wider area, the Sverdrup Islands (Axel Heiberg Island, Ellef Ringnes Island, and Amund Ringnes Island) were undiscovered. This slide shows the location of Axel Heiberg Island, Ellef Ringnes Island, and Amund Ringnes Island in the archipelago.

[Slide 6] This slide shows an ASTER image of Axel Heiberg Island and Ellesmere Island. Folded rocks are visible beneath the light snow cover that is typical of this polar desert environment. The red square delimits the area explored by Otto Sverdrup and his crew during the second *Fram* expedition, 1898-1902 (Kenney, 2005). The short book by Gerard Kenney on the Norwegian-Canadian Expeditions of the early 20th century is a compelling account of the hardships endured by Otto Sverdrup and his men during the course of the expedition. The names of the crew are listed in the top right-hand corner of the slide. These names are familiar to Arctic explorers but also to scientists engaged in geological work on these islands: Sverdrup Basin, Stolz Peninsula, Schei Point, Fosheim Peninsula, Isachsen Formation, Baumann Fiord, Bay Fiord, and Hassel Formation.

[Slide 7] In response to the Norwegian Expeditions, the Canadian government sponsored a number of Canadian patrols in the Eastern and Central Arctic, some of which I have listed here. As a result of increased activity in the North, the Norwegian government withdrew its claim to sovereignty over the Sverdrup Islands in 1930. However, the exploits of the Norwegian men who ventured in this hostile environment on the *Fram* are forever recorded in Canadian geographic annals and geological history.

[Slide 8] This slide illustrates important milestones in the exploration of the Canadian Arctic Islands and adjacent ocean.

- Operation Franklin: Fifty years ago, in the summer of 1955, the Geological Survey of Canada conducted Operation Franklin, the first helicopter supported exploration program in the Canadian Arctic Islands. It was a reconnaissance program, covering approximately 200,000 square miles, about the same area as France. The project used a DC-3 aircraft, two Sikorsky S55 helicopters, and three dog teams. The geologists did a lot of walking from their fly camps, but the study areas still look small and scattered when they are plotted on a map of the Arctic. We jokingly referred to this phase of exploration as "postage stamp geology." For those of us who were on Operation Franklin, it was an unforgettable adventure. It also was a scientific milestone that set the stage for government and industry to further explore and understand our high Arctic. (Extract from a talk by J.W. Kerr.) <http://www.cspg.org/events/luncheons/2005/20050922-kerr.pdf>

- Exploration Drilling in the Sverdrup Basin: Data from Operation Franklin surveys revealed a thick layer of sedimentary rocks and structures in the Arctic Islands, similar to those found in oil fields. The petroleum industry was quick to carry out investigations for oil and natural gas.
- Arctic Oceanographic Experiments – Ice Islands: See a description of the Canadian Experiment to Study the Alpha Ridge as an example of operations on the Arctic sea ice:  
<http://www.thecanadianencyclopedia.com/index.cfm?PgNm=TCE&Params=A1ARTA0001490>
- United Nations Convention on the Law of the Sea (UNCLOS): The Director of UNCLOS Canada is Dr. Jacob Verhoef, Earth Sciences Sector: NRCan. [http://ess.nrcan.gc.ca/scient\\_e.php](http://ess.nrcan.gc.ca/scient_e.php)

[Slide 9] The Polar Continental Shelf Program (PCSP). The value of support in 2007 tripled in 3 years over its previous base partially due to climate change studies and International Polar Year (IPY) support. The 2007 report has just been completed and can be downloaded from their website (<http://polar.nrcan.gc.ca>). A history of the PCSP can also be found on the website History of PCSP at [http://polar.nrcan.gc.ca/about/history\\_e.php](http://polar.nrcan.gc.ca/about/history_e.php)

One reason the PSCP works well is that it is run military style; the base camp manager is the ultimate authority when it comes to field operations. You make your twice-a-day radio calls and follow protocols or you do not get your resources the following year.

[Slide 10] This slide shows a schematic map of Axel Heiberg Island, northern Ellesmere Island, and northwestern Greenland. The red oval and square illustrate the extent of my Ph.D. study area, and the location of base camps. Field operations were based on the system pioneered during Operation Franklin. Fly camps were established with support from PCSP fixed- and rotary-wing aircraft. Mapping and sample collection were planned according to a set of 10-15 km foot traverses radiating out from base camp. This part of the Arctic Archipelago is characterized by volcanic and intrusive rocks of Cretaceous age emplaced in a large continental rift basin reactivated during the opening of the adjacent Arctic Ocean.

[Slide 11 – skipped in presentation] Looking back at some of the events that were impressed upon me during field work on Axel Heiberg Island brings me to a helicopter flight from our base camp at Bunde Fiord, on the northwestern part of the island, to a site revisited by a Survey geologist based out of Ottawa during Operation Franklin, Jack McMillan.

[Slide 12] For the Geological Survey of Canada, Operation Franklin was the first large-scale effort to carry out geological mapping with helicopter support – flying a path, setting up a fly camp, and then moving on as long as the weather didn't close in. I was looking for a Ph.D. thesis and Jack knew what needed to be completed, what gaps remained at the end of Operation Franklin.

There had not previously been any females at the base camp and at first my participation was declined by the base camp manager. Fortunately, Jack McMillan kept working to get me a spot and that changed. A very wise decision by the GSC camp manager that year was to include two other women in the field party of about 25.

[Slide 13] This slide show Bunde Fiord glacier in July 1983.

[Slide 14] These are pictures from the 1983 field season. Taking a look at the photo of the helicopter at the top left would alert any geologist working these camps in the 1980s that this was an emergency

landing. Small tents such as this one were restricted to the pilots; everyone else used Logan tents (bottom left). So ice fog, tent's up, the pilot is stranded: Resolute, we have a problem.

[Slide 15] If you were going to the arctic next year, then planning for the expedition would have to start early this year, e.g. September 2009. These are the planning steps you would need to outline with your CoI. The government and some universities now also require a risk analysis.

[Slide 16] These are the next planning steps that are required, and timelines.

Once you get your letter from the PCSP offering aircraft and logistics support, things start to move faster. One note, you cannot negotiate with PSCP; for example, if they decide they are decreasing your requested flight hours by one half, you have to live with it and adjust the field season as a consequence.

[Slide 17] Operations – The first challenge is site selection. You will use all the information you have to plan your sites. But, unless this is a return trip to a previously studied area, once on the helicopter, the geologist is the navigator and must choose the right location for a base camp; taking into account not only the science, but logistics, such as access to drinking water.

[Slide 18] These are photographs from some of the previous sites I have visited. Some of them are problematic, some of them are not. Site selection is entirely driven by science goals but the availability of drinking water remains a critical issue during field work in proximity to salt domes.

[Slide 19] Everyone always asks about the weather. The truth is, it is changing. There never used to be much rain in the polar desert now you can get weeks of wet weather. You have to be prepared for everything ([http://polar.nrcan.gc.ca/about/manual/pdf/operations\\_manual\\_e.pdf](http://polar.nrcan.gc.ca/about/manual/pdf/operations_manual_e.pdf), Advice to the Arctic Researcher). The greatest threat during foot traverses is hypothermia, not necessarily from falling in glacial streams but from the gradual effects of a cold wind over time.

[Slide 20] The next two slides are about aircraft support. Twin Otter support is very different from helicopter support. Basically the extent of your relationship with the Twin Otter pilot is take-off to landing. Rarely does the PI have any power of negotiation regarding the landing site, particularly if there are no landing strips and we need to land directly on the tundra. This slide shows the Twin taking off after dumping our gear at Strand Fiord. It took our party of four about six hours to move the gear to a better location, and set up camp.

[Slide 21] This slide shows the difference between fixed-wing and rotary-wing aircraft support. In the aftermath of a snowstorm at a site near Lightfoot River, on northern Axel Heiberg Island (August 2008), the helicopter pilot worked very hard to get our team of three geologists back to the Eureka weather station in close to white-out conditions.

[Slide 22] This slide illustrates a basic concept for any type of polar work, in the Arctic or Antarctic: Once you get past aircraft support and the weather, these some of the other challenges you will need to face. Depending on the profile of your field crew members, some or all of these may start failing at some point (team work, navigation, achieving science goals), and be compounded by equipment failure and isolation. Sometimes this implies that as the leader you have to make unfortunate decisions.

[Slide 23] These are the sort of things you need to take into account: terrain, logistics (moving camp), equipment breakdown, wildlife (there are only 17 species in the arctic, but you have to deal with all of them), etc... Again, be prepared.

[Slide 24] As beautiful as it is, at some point you are far away from home, cold, wet and bored. You need to prepare your team ahead of time and manage any crises with confidence to avoid disaster.

[Slide 25] This slide of the tundra at Lightfoot River on Axel Heiberg Island illustrates how difficult it is to navigate with very few landmarks for mapping. If the weather closes in, the situation becomes dangerous even with a GPS.

[Slide 26] And of course there is the problem of isolation.

[Slide 27] As a team leader, I have had my experiences with bizarre behavior by my team members. This is a list of the factors that I found impact their behavior. Fatigue is probably the biggest factor for a geologist as you are performing physical labor 10 to 12 hours a day. Waning interest can be a problem with young investigators that have always wanted to go to the field in the Arctic but now that they have been there for awhile (3-4 weeks), it is no longer as exciting – field assistants need to be strongly motivated to keep going.

[Slide 28] In my own experience, I have found that effective people leadership starts with prioritization. It all ends up on that radar screen in your mind – the question is ‘how close are we to a crisis’ – what can be done to resolve the issue now or at least keep it under control until more information is available or I can get advice from Base Resolute.

Of course, that doesn't always work.

In my experience, the most difficult decision when a problem arises with a team member is to make the conscious decision, as the leader, to slow down the intense pace of foot traversing and science activities to allow some time to deal with the issue. This requires a personal decision to shift focus, observe, consult if necessary, and decide – one that has the immediate and beneficial effect of capturing the team's attention. If/when that happens, I found that the approach is effective. Now with the full (surprised, concerned) attention of the field team, dialogue can be initiated, the problem can be addressed, and a solution can be found. It takes time, attention, and effort but the process usually pays off in the end, and gets us back on track, albeit with revised objectives, hopefully with the field party intact and ready to move on.

[Slide 29] In the next five slides, I illustrate some aspects of team selection. Remember, I am a public servant, so when I talk about different cultures, I am usually referring to the cultural differences between government and academia – two different types of accountability, reporting structures and deliverables. I like this slide, because if I had to pick the perfect person, it would be someone like this gentlemen who realizes and understands the risks, yet remains calm.

[Slide 30] This ideal is rarely achieved. In reality, you are looking for someone who is motivated, enthusiastic, curious, and resourceful.

[Slide 31] You also want someone who is capable of some degree of autonomy, and of relaxing in any environment, such as this field geologist waiting for the helicopter to show up for a camp move.

[Slide 32] At the same time, we always had meals together, and we shared the work at base camp. The professor here on the right did not really want to cook, but we eventually convinced him to try it.

[Slide 33] As illustrated on this slide, participants also need to be sociable and get along in a larger group – have barbecues, for example, when other researchers in the area come by for a visit.

[Slide 34] This slide illustrates some statistics concerning the polar survey that I mentioned earlier. The data show some interesting trends, but I am still evaluating the results. This is a breakdown of the survey participants, in terms of numbers, expertise, gender, and experience.

[Slide 35] This slide illustrates some of the results to the questions of “Most Important Quality of the Field Team” and “Valuable Qualities of Individuals”.

[Slide 36] This slide shows a graph of the relative importance of various factors on mission success. If CSA is going to fund universities to perform planetary analog work, we need to look at the results of surveys such as this one to realize what is important to the arctic science community, and how can we best work with these preferences as a funding agency.

[Slide 37] These are the CSA analog sites in the arctic. Key to colored dots: Green, Resolute; Red, Haughton Mars Project on Devon Island, and McGill Arctic Research Station on Axel Heiberg Island; yellow: Eureka Weather Station.

Through the Canadian Analogue Research Network (CARN), CSA has invested infrastructure and research projects at two sites in the Canadian High Arctic: the Haughton-Mars Project on Devon Island in collaboration with the Mars Institute and McGill Arctic Research Station on Axel Heiberg Island in collaboration with McGill University. This summer, a reconnaissance team led by CSA in collaboration with Environment Canada travelled to the Fosheim Peninsula on Ellesmere Island to investigate the potential for the development of a third site to support field teams based out of the Eureka Weather Station.

All three sites are very different, but a common denominator is their potential for Mars analog research. In Canada, lunar analog sites consist of impact craters in anorthositic rocks (Manicouagan, Mistastin), and there are no sites yet identified for studies of lunar regolith (unconsolidated materials) – we will probably need to go to Iceland.

[Slide 38] In the Recommendations proposed by the CLEAR-1 mission SDT (June 2009), geological and geophysical investigations of the lunar regolith are given priority re: lunar science objectives related to In Situ Resource Utilization and Astronaut Activities with rovers.

The Arctic polar desert does not provide a suitable (high-fidelity) analog. The Lunar Analogue Site Analysis Team (LASAT) Iceland report (Potential for Lunar Analogue Research at Askja and Hekla Volcanoes, Iceland) contains a detailed description of the Askja caldera as a potential analog where such studies can be carried out.

[Slide 39] The next two slides show a definition of analog missions, and some of the operational requirements.

[Slide 40] This slide illustrates a list of tests and measurements acquired during analog missions that provide Lessons Learned. Logistics are not explicitly included but are implied through Infrastructure. The list is biased towards instrument-based scientific investigations.



[Slide 41] From my experience trying to gather metrics, by for example timing how long it took to describe geology at outcrops, I have concluded that some technologies could facilitate the process. We need technology that records the metrics without interfering with the work being done.

[Slide 42] These are iPaq's loaded with a basic set of data before going to the field

- 1) Vector (points, lines and polygons)
  - a) streams, lakes, roads, etc ...
  - b) National Topographic Database (NTDB) - 1 : 50,000 and 1 : 250,000 scale
  - c) Terrain Resource Inventory Mapping (TRIM) – 1 : 20,000 and 1 : 250,000 scale
  - d) National Atlas Information Services (NAIS) – 1 : 2 M, 1 : 7.5 M, 1 : 30 M scale
- 2) Raster (images)
  - a) Geological map, geophysical data, Earth observation data, station locations, etc ...

These have a built in GPS and chronometer to automatically measure when and where work is being done and recorded.

Meetings between the Geomatics team at CSA Planetary Exploration and GSC (Québec and Ottawa offices) have centered on adapting the GANFELD software package to a broader set of field entries. GANFELD is intended for the capture of geospatial data and geological information during field traverses.

[Slide 43] And here are my conclusions. In my view, the most important factor to consider if Arctic field work is considered for training is the duration of the mission. By analogy, if a team sets out to participate in an Ironman competition with no previous experience, the coach might wish to start training the team for a "Sprint Triathlon"; the individual segments are shorter, but the athletes will have to deal with all the critical transitions: swim to bike, bike to run. Once they have trained for, and experienced these transitions, they can shift their focus on the endurance factor of their "mission", and eventually attempt an Ironman Triathlon.

[Slide 44] Acknowledgments

[Slide 45-47] Backup slides with charts on the Polar Survey.

Marie-Claude Williamson  
Canadian Space Agency  
[Marie-Claude.Williamson@csa.gc.ca](mailto:Marie-Claude.Williamson@csa.gc.ca)

## Science Traverses in the Canadian High Arctic

*Polar Traverse Workshop  
August 2009*

1

 Canadian Space Agency / Agence spatiale canadienne



### Outline

- Exploration Highlights, Arctic Archipelago
- The Polar Continental Shelf Project (PCSP)
- Planning Arctic Field Deployments in 2009
- Operations
- Challenges
- Lessons *\*We Have Already\** Learned :  
*A Polar Science Survey*
- Analog Sites in the Canadian Arctic :  
*Managing Expectations*
- Planetary Analog Missions : CSA update

*Polar Traverse Workshop*

*4 August, 2009*

Canada

2

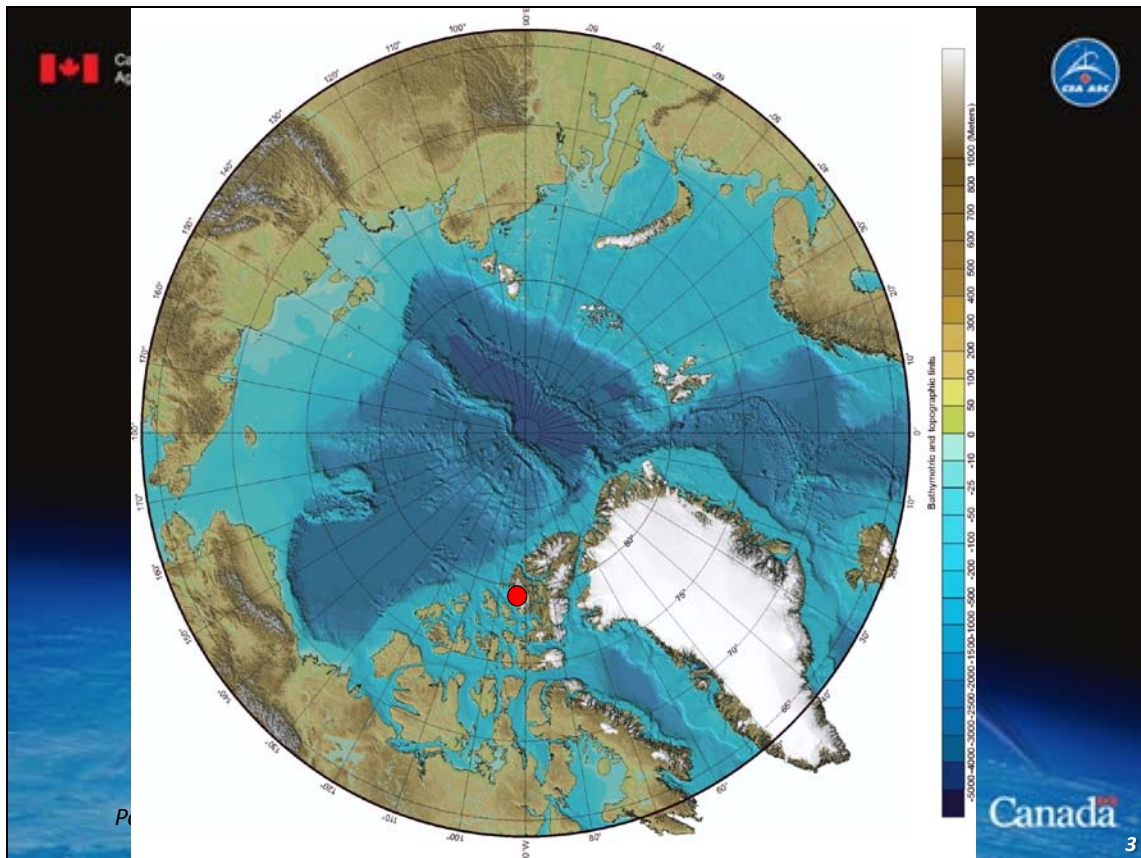

## The Norwegian Expeditions 1893-1902

- Exploration
- PCSP
- Planning
- Operations
- Challenges
- Lessons Learned
- Polar Science
- Survey
- Analog Sites
- Analog Missions

- 1880 Canada inherits all remaining northern tracts of land from the British Crown
- Captain Otto Sverdrup leads a crew of 15 men on the *Fram* for an Expedition to the High Arctic Islands, 1898-1902
- 1928 Norway reserves all rights under international law over the Sverdrup Islands

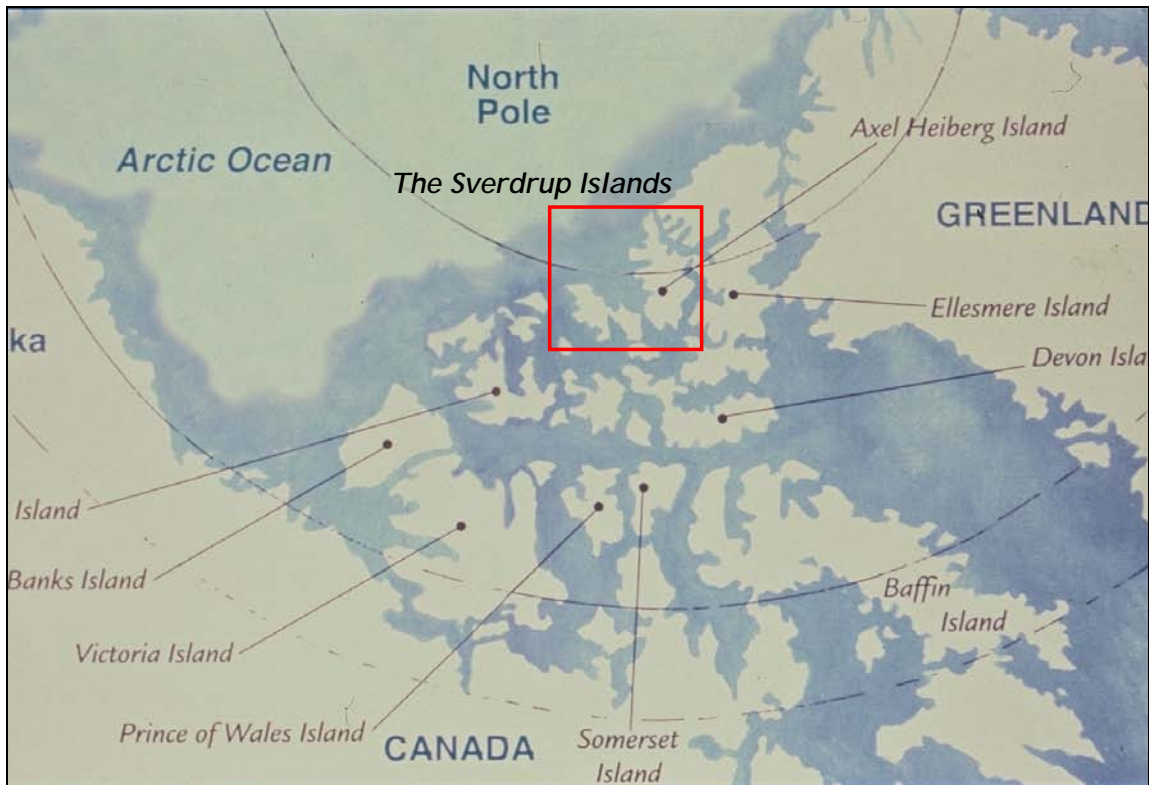

**THE HIGH ARCTIC**

gs  
5

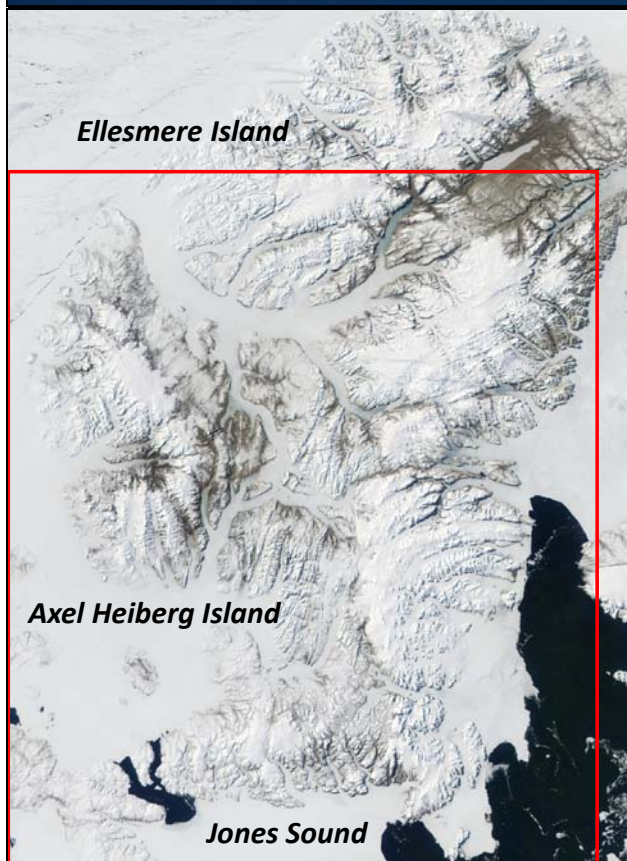

Otto Sverdrup Jacob Nodtvedt  
 Peder Leonard Hendriksen  
 Karl Olsen Rudolph Stolz Per Schei  
 Ivar Fosheim Herman Simmons  
 Ove Braskerud Johan Svendsen  
 Gunerius Ingvald Isachsen  
 Victor Baumann Olaf Raanes  
 Edvard Bay Sverre Hassel

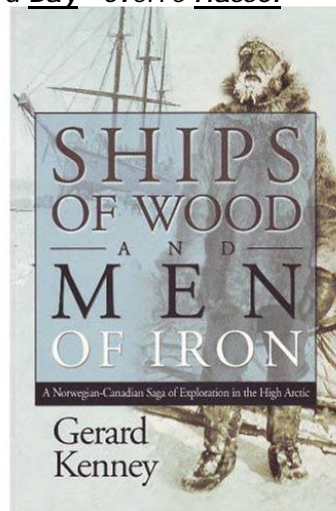

5

## The Canadian Expeditions 1903-1948

- Albert P. Low (geologist) and the *Neptune*, 1903-1904: the first Eastern Arctic Patrol
- Joseph E. Bernier and the *Arctic*, 1904-1925
- V. Stefansson and the *Karluk*: The Canadian Arctic Expedition, 1913-1918
- Henry A. Larsen and the *St. Roch*, 1928-1948
- 1930 The Norwegian government formally recognizes Canada's sovereignty over the Sverdrup Islands

## The Geological Survey of Canada

- **Operation Franklin, 1955, 200,000 sq. miles**
- Exploration drilling in the Sverdrup Basin, 1960-1980
- Geophysical Experiments, Arctic Ocean
  - LOREX, 1979
  - CESAR, 1983
- *Ice Island*, N Ellesmere Island 1984-1993
- UNCLOS program for Canada

<http://www.international.gc.ca/continental/limits-continental-limités.aspx?lang=eng>

# The Polar Continental Shelf Program

## PCSP Base Resolute Camp Managers

Barry Hough      Dave Maloley

Mike Kristjanson      Tim McCagherty

<http://polar.nrcan.gc.ca>

- Exploration
- PCSP
- Planning
- Operations
- Challenges
- Lessons Learned
- Polar Science
- Survey
- Analog Sites
- Analog Missions



**PCSP field season 2007**  
 Value of support \$7,971,500  
 Projects supported 123  
 Field personnel 1135  
 Twin Otter flight hours 1726  
 Helicopter flight hours 3783

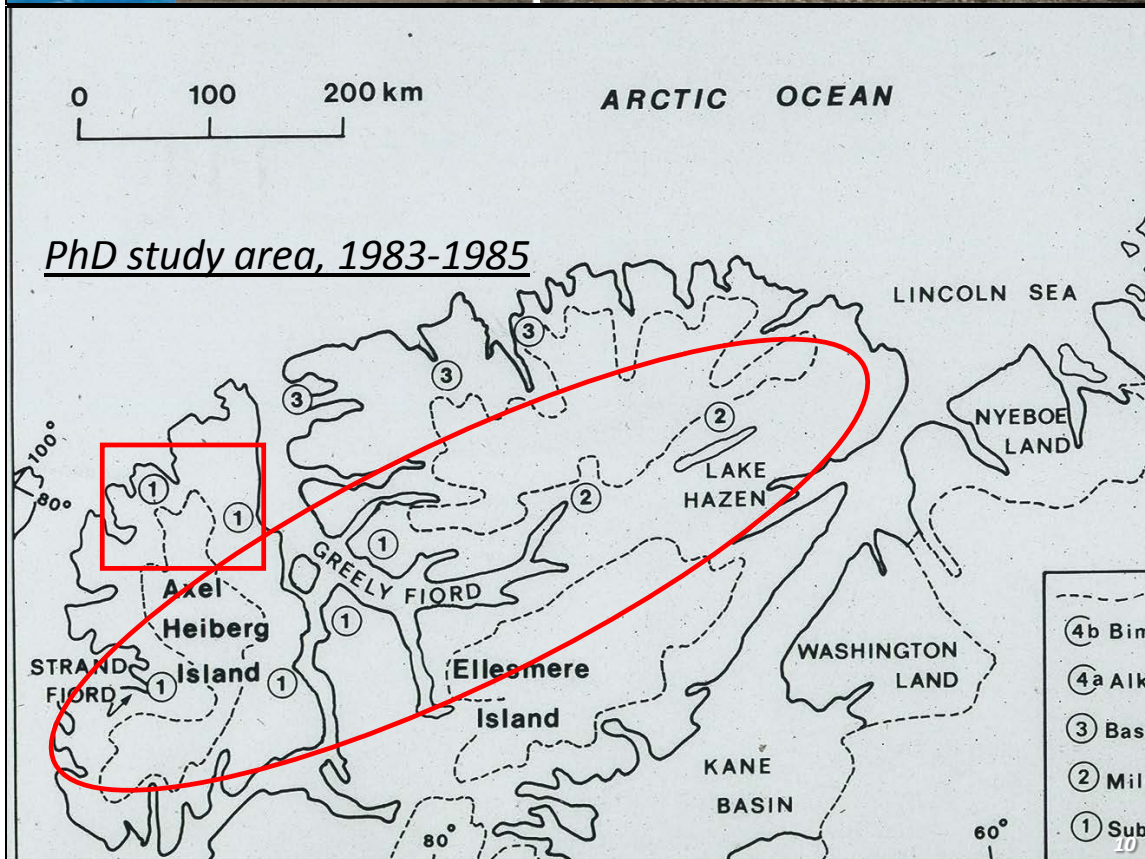



*Glacier Observation Monuments, Bunde Fiord, July 17, 1983*



13



14





# Planning Fly Camps

- Exploration
- PCSP
- Planning**
- Operations
- Challenges
- Lessons Learned
- Polar Science
- Survey
- Analog Sites
- Analog Missions

- Science Objectives
- Geographic area and Timelines
- Operational Planning : access, infrastructure, science instruments, supporting technologies
- Risk analysis
- Field party
- **Logistics**

- 2009
- SEPT
- OCT
- NOV



# Planning Fly Camps

- Application for PCSP Aircraft & Logistics
  - Application for Research License NRI
    - Nunavut Environmental Impact Review Board
  - Application for Nunavut Water License
  - **PCSP Letter of Support**
  - **NRI License and Water License**
  - **PCSP request for final IN-OUT flights, fixed-wing and rotary-wing aircraft**
  - **OPERATIONAL READINESS REVIEW**
- Team, food, equipment, instruments, logistics

- 2009
- OCT
- NOV
- 2010
- JAN
- FEB
- MARCH
- APRIL
- MAY
- JUNE

# Operations

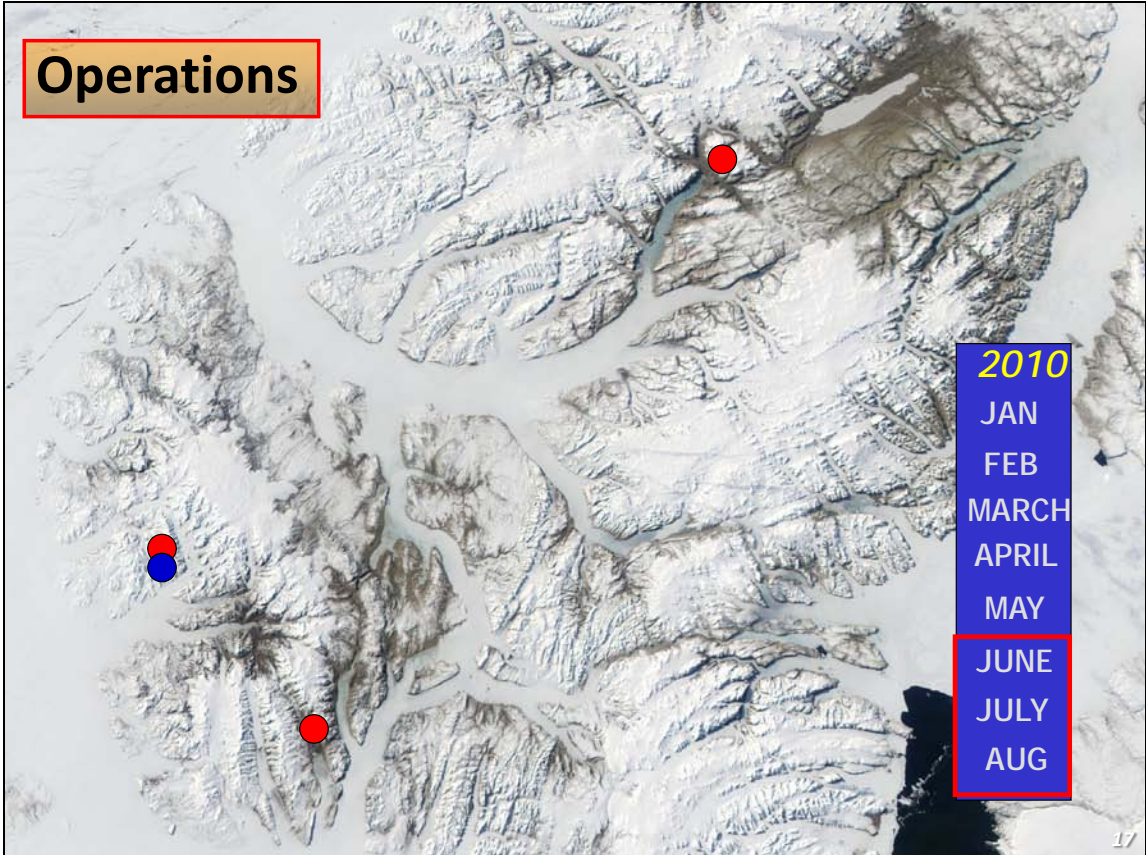

CSA 2008



Dalhousie University 1984

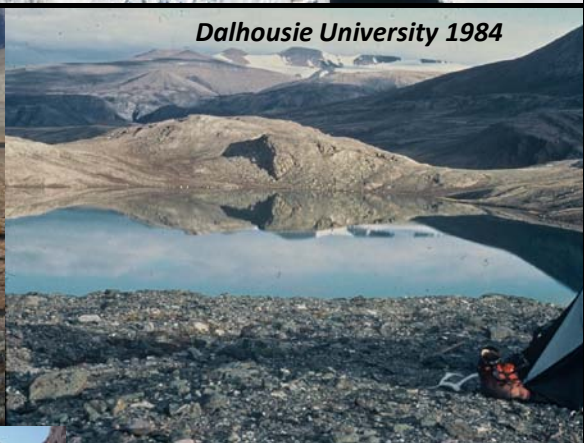

GSC 2004



GSC 2004



# The Weather. Well?

- Exploration
- PCSP
- Planning
- Operations
- Challenges
- Lessons Learned
- A Polar Science Survey
- Analogue Sites
- Analogue Missions

**PCSP Operations Manual**  
**2. Advice to the Arctic Researcher**

- 2.18. Hypothermia
- 2.19. Frostbite
- 2.20. Dehydration



## Aircraft Support: Strand Fiord airstrip, July 2003



*Lightfoot River, August 2008*



21

## **(Other) CHALLENGES**

- Team work
- Navigation
- Achieving science goals
- Equipment breakdown
- Isolation



22



23



24

*Lightfoot River, August 2008*  
*N80°45' W92°25'*



25



26



# Human Factors

*Isolation*

*Fatigue*

*Waning interest*

*Anxiety*

Leadership



*What's on the Radar Screen?*

# Team Selection

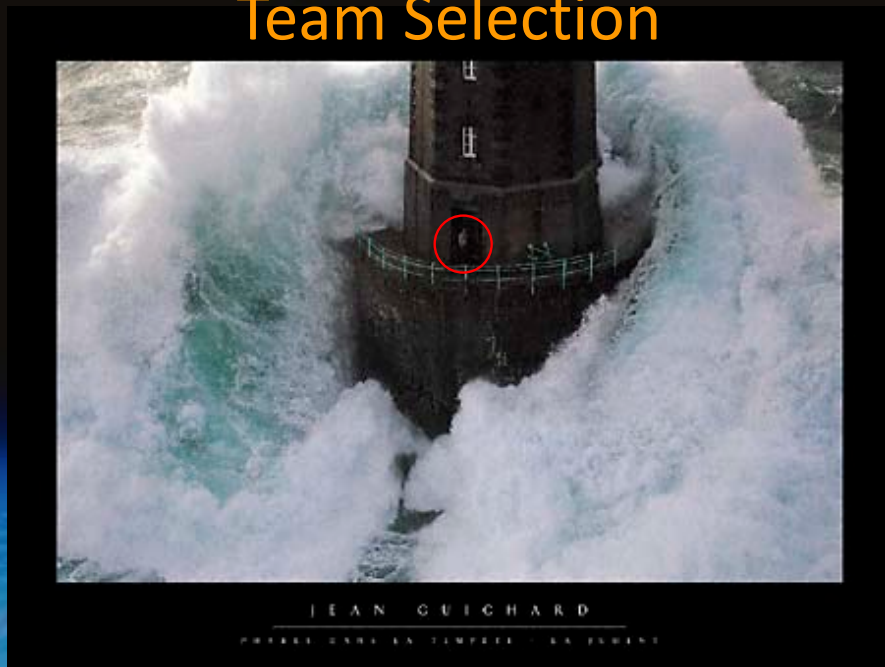

Polar Traverse Workshop

4 August, 2009

Canada

29

Expedition Fiord, July 2008



30



*Whitsunday Bay, July 2004*



31

*Eureka Pass, July 2003*



32

*Expedition Fiord, July 2008*



33

 Canadian Space Agency / Agence spatiale canadienne



## Participants

### *Polar Survey 2009*

Exploration  
PCSP  
Planning  
Operations  
Challenges  
Lessons Learned  
*A Polar Science Survey*  
Analog Sites  
Analog Missions

- Questionnaire sent out mid-June
- 13 participants
- 12 Principal Investigators, Canada, U.S.A., U.K.
- CMN [1], CSA [2], GSC [2], Universities [7], HS [1]
- PhD, Postdoctoral 3
- Women 5, Men 8
- # of field seasons in the Arctic 2 - 25
- Study areas: Arctic Archipelago, Baffin Island - Nunavut; , Mackenzie Valley - NWT, Central and northern Yukon, Iceland, Antarctica

*Polar Traverse Workshop*

*4 August, 2009*



34



# Results, Team Selection

## Most Important Quality of the Field Team

- Congeniality
- It's quality
- Dedication
- Planning
- Skills to meet research objectives
- Common sense
- Compatibility
- Complementary expertise
- A good sense of humour
- Getting along while still competent
- Camaraderie
- Highly-motivated

## Valuable qualities of individuals

- Physically fit
- Endurance (stamina)
- Mentally sound (emotionally stable)
- Academically qualified
- Good sense of humour
- Reliable
- Team player (cooperative)
- Willingness to contribute
- Adaptable (flexible)
- Enthusiastic
- Ingenious
- Curious (adventuresome)
- Common sense (not reckless)
- Leader



# Results, Impact on Mission Success

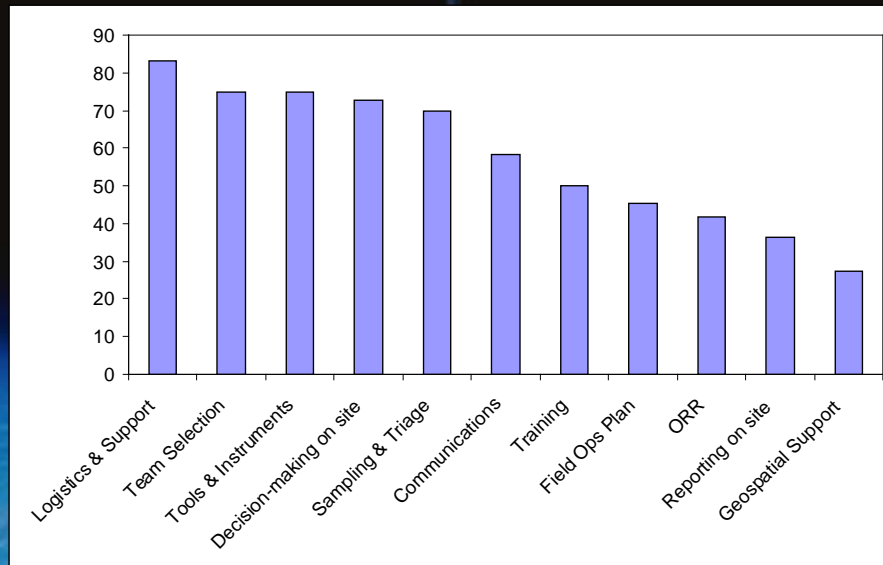



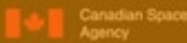

37

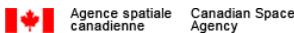

Canadian Space Agency



Agence spatiale canadienne Canadian Space Agency



## Potential for Lunar Analogue Research at Askja and Hekla Volcanoes, Iceland

### Report & Recommendations

Lunar Analogue Site Analysis Team (LASAT)

Meeting at the Canadian Space Agency  
July 6-8, 2009



*Polar Traver*

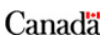

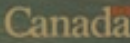

38



# CSA Analog Missions update

## ANALOG MISSION

- Exploration
- PCSP
- Planning
- Operations
- Challenges
- Lessons Learned
- A Polar Science Survey
- Analog Sites
- Analog Missions**

An integrated set of activities that will encompass multiple features of the target mission (including human factors) and result in system-level interactions



## Operational Requirements

- Team selection
- Operational plan & readiness reviews
- Test of infrastructure support
- Test of communications
- Instrument performance and versatility
- Data quality
- Sample identification, and triage
- Database management
- Metrics**
- Test of geospatial support
- Reporting & decision-making on site

# Metrics



To compile the measurements that will lead to a better understanding of work efficiency during field traverses, we need instruments that will:

- (1) allow the rapid storage of these data on site;
- (2) support - not interfere with - the normal business of conducting science experiments and technological field tests.

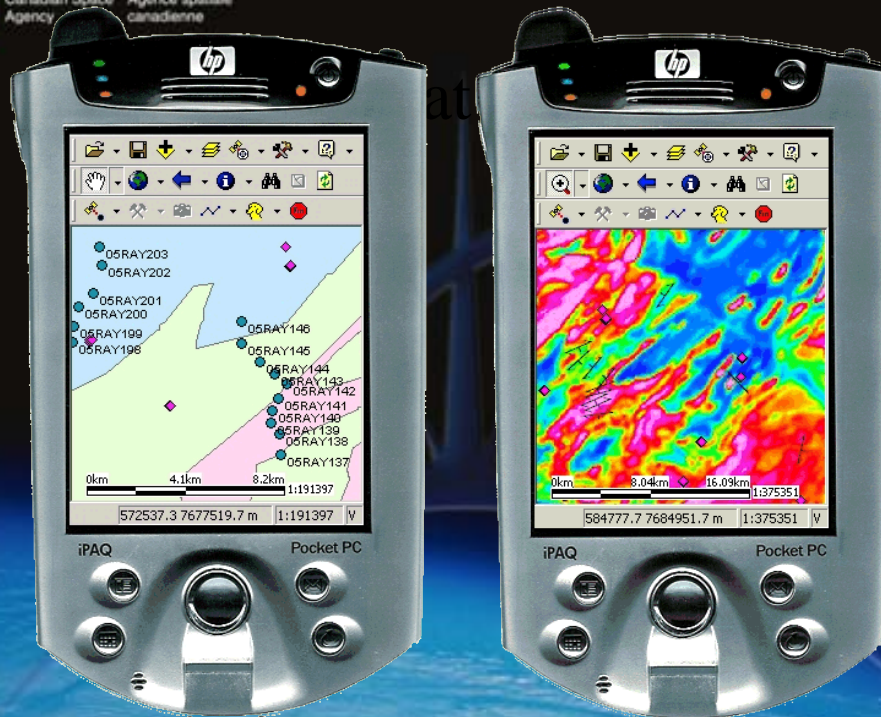

## Lessons Learned

- From past expeditions to the High Arctic,
- contemporary traverses by Arctic scientists
- fly camp planning and operations enabled by PCSP aircraft and logistics support

*can be applied to long-duration space missions but close attention must be given to the transition in physical and mental endurance levels expected from the crew; the ability to achieve science goals while adapting to new challenges; and the greater (continued) demand on the supporting infrastructure*

## Acknowledgments

**PCSP Project 507-08:** Wayne Pollard, Chris McKay, Marianne Mader, Krystal Aubry, Joey Sliwinski, Ron Peterson, the Spaceward Bound team 2008, and the UH pilots

**CSA:** Alain Berinstain, Martin Lebeuf, Vicky Hipkin, Richard Léveillé, James Doherty, Martin Tétreault, Bernard Marsan

**GSC, PCSP:** Marc d'Iorio, Martin Bergmann, Mike Kristjanson, Pierre Brouillette

**Polar Science Survey:** Jim Basinger, Jean Bédard, Rebecca Carey, Sean Clark, Steve Grasby, Timothy Haltigin, Denis Lacelle, Jay Nadeau, Steve Rippington, Natalia Rybczynski, John Smol, Helen Smyth, Caroline-Emmanuelle Morisset

**LASAT-Iceland:** Denis Lacelle, Mickael Germain, Maxime Phaneuf, Kim Binsted, Rebecca Carey, Eric Negulic, Brian Cousens

# BACKUP SLIDES

Polar Traverse Workshop

4 August, 2009

Canada

45

## Polar Science Survey Q. 11

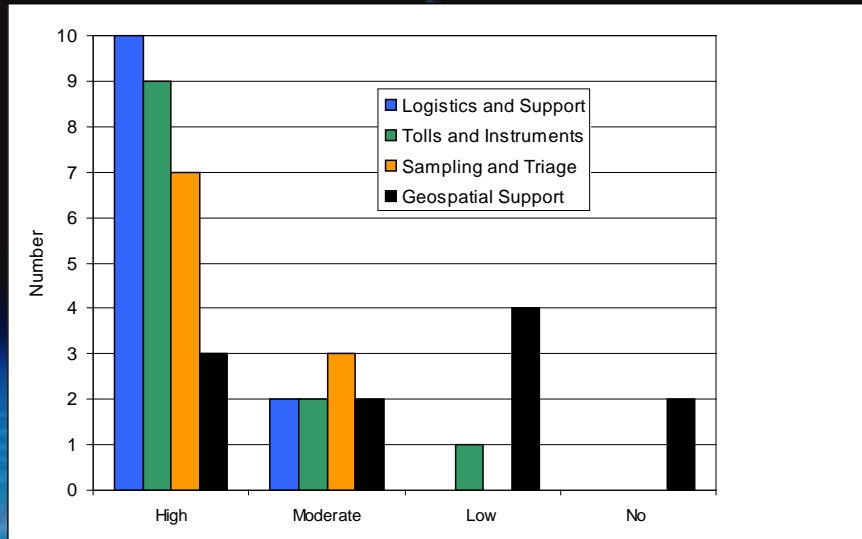

Polar Traverse Workshop

4 August, 2009

Canada

46





# Polar Science Survey Q. 11

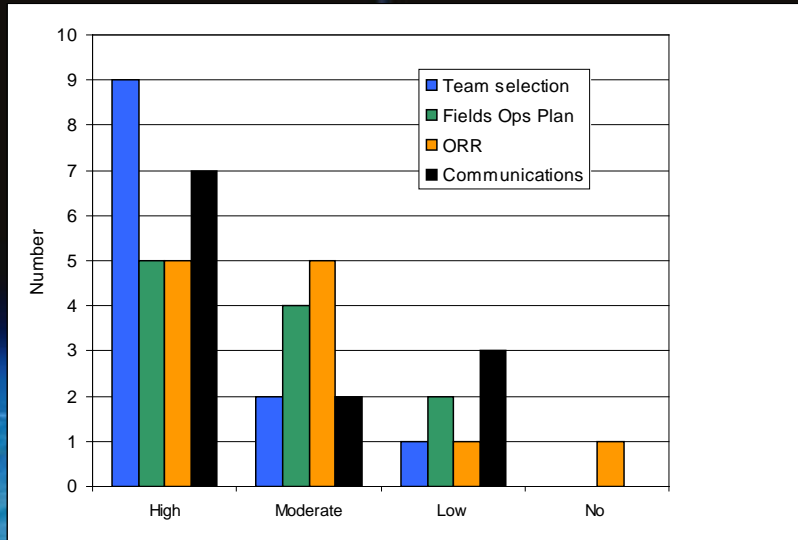

## **A8 – Presentation of Mary R. Albert**

### ***NOR-USA Scientific Traverse of East Antarctica: Science & Logistics on a Three-Month Expedition across Antarctica's Farthest Frontier***

[Slide 1] NOR-USA Scientific Traverse of East Antarctica: Science & Logistics on a Three-Month Expedition across Antarctica's Farthest Frontier; Mary R. Albert, Ph.D., Dartmouth, Hanover, N.H.

[Slide 2] This talk is primarily about the Norwegian – USA traverse, but I have also talked with the Japanese and am familiar with other US traverses that have taken place. This is the team that took part in our traverse. We also attempted to be the first group to use UAVs in the Antarctic.

[Slide 3] This is an overview of how I have laid out my talk and you will see the subjects on this chart highlighted as I move through it.

[Slide 4] Why traverse across Antarctica?

[Slide 5] There is lot of data on climate change in the Antarctic, we need to go there to gather that data through measurements.

[Slide 6] This talk is mostly about the logistics of the traverse, but as science was the driver for the traverse, I want to point out a couple of the overarching science questions the traverse addressed, which I have listed here.

[Slide 7] To answer the accumulation rate and related question, we used both pits and core. The pits primarily for stratigraphy and the cores to do physical, chemical and electrical property analyses as counting layers in a low accumulation area is not practical.

[Slide 8] And we also did surface studies. One of our plans was to use UAVs.

[Slide 9] We also did radar and related it to satellite, particularly SAR, images. The radar measurements allowed us to connect our pits and core sample data and our mapping near those sites to the longer traverse.

[Slide 10] This is a view of our coring activity.

[Slide 11] Notice that the collection of cores is being done with clean suits and brought back to the Desert Research Institute for analysis.

[Slide 12] We used the holes drilled for the cores to implant a thermal monitoring system at each location, which also included an automated weather station.

[Slide 13] Why traverse across Antarctica – you do it for science and to gather that data which you cannot gather by satellite.

[Slide 14] Also, the time was right with world agreeing to International Polar Year activities. The Norwegians needed new infrastructure at their station and as it is not near the coast, they needed to traverse anyway. So they asked the NSF if any American scientists would be interested in joining the traverse to do science. This gave the US community an opportunity to go where we usually do not go.

[Slide 15] Pre-traverse Planning

[Slide 16] From this list of meetings, you can see this did not happen overnight. Fortunately, this was a team that most knew each other and was highly motivated as the first proposals were due in June 2005. We used monthly whole group telecons to keep everyone involved and motivated and to know what was going on, including the development of the vehicle infrastructure by the Norwegians.

[Slide 17] The years of planning contributed to the mission success. The first year at Troll we did our final training and a lot of cargo handling.

[Slide 18] The Field Team and the Team's Attitude.

[Slide 19] This is a picture of us and here you can see a breakdown of our characteristics.

One particular point, John Guldahl, the Chief of Logistics, designed the vehicles and he has spent a lot of time in the Antarctic and said he was not going to freeze his ass off – so, the person designing vehicle not only had the experience, he is also the one using it.

Something that Norwegians did, that was new to us, is that main meal was pre-prepared as a 12-person serving package that only need to be placed in hot water for half an hour.

The nationalities are weighted toward Norwegians as they supplied the logistics support.

None of these characteristics made any difference once we were on the traverse; everybody did whatever needed to be done. If the logistics was all done and we needed to finish up some science activities before we could move on, the logistics guys helped. If the reverse was true, the scientists move supplies or helped with tools.

[Slide 20] Humans on Long-Duration Missions

[Slide 21] Humans are chemical machines and on long-duration missions, you need to realize this. John Guldahl realized this and built the vehicles accordingly. There were two heated modules; one was for living and one was for sleeping. There was heat in the floors – heat recovered from the vehicles.

We were organized and within 40 minutes of stopping, we would be cabled up, meal ready and we were ready to eat. We always had meals together. After dinner we would do a review of the day and discuss the plan for the next day. This gave everybody a good feel for how everyone was doing.

In the middle here you can see a real kitchen, small, but real.

After dinner, this became our work area. It had lots of outlets for computers, it was warm and comfortable – with the heated floor you could take off your boots as well as your jacket. Unlike other traverses, I came back not just with cores, but with reduce data – information. The living conditions made that possible. And by being able to analyze the data in the field, we were able to replan and take advantage of opportunities.

[Slide 22] The sleeping module was similarly built. It had three separate bunkrooms with six, six and three bunks. The bunks were each moveable up and down and had ventilation and reading light by your

head. For us what was important in deciding the sleeping arrangements was not gender, but how you sleep – light sleeper and non-snoring, snoring, and heavy sleepers that are not bothered by being next to the bathroom. Some of the norms at home do not apply in the field.

[Slide 23] The Norwegians also built a small science tent for me; for which I will be eternally grateful. There was not enough time to setup a tent every time, so this was a real time saver; I could start working as soon as we stopped. It also allowed for us to do quick science at a spot when we had to stop some place for logistics reasons, such as vehicle problems.

[Slide 24] This is the work space for our mechanic. Like the main units, it has a heated floor and gave our mechanic a heated place where he could work.

[Slide 25] We had special events along the traverse to keep a team spirit and keep attitudes up beat. Three months out was too far away to think about, so we had intermediate goals. Here we are at plateau station, seeing the way it was left, 50 years ago.

[Slide 26] Another special event was Christmas. We traveled on Christmas Eve, but once we stopped, we had our main meal; setup a tree; and passed out presents I had brought.

[Slide 27] New Year's was at the Pole of Inaccessibility with Champaign and cigars.

[Slide 28] We had visitors. Here is a very rich Swede with his friends from Dubai, Germany, and Canada who were on their way in a twin otter to the Pole of Inaccessibility. They heard about us and asked if they could visit. So, we ended up being a tourist attraction on their way.

[Slide 29] Balancing Science and Logistics. In this case, the traverse would not have happened had the Norwegians not needed new infrastructure. But once the infrastructure was available, it was important to do good science. NSF would not have funded us just to go along and survive.

[Slide 30] This distance is about the same as from Miami to Boston and was traveled at the speed of a tractor. The circle sites were deep (90 m) drill sites where we stopped for 5 days. The other labeled sites were 30 m drill sites. Notice that some of these are labeled "B". Before going on the traverse we planned the route and the sites, balancing travel ability and science return. The "B" usually meant that we were driving along and another differential died. When that happened, it took at least a couple days to fix, so when we were close enough that became the new site. We did have a time constraint, because if the cores were not at the ship in time, they sit in Antarctica for a year.

This is a Bessler, which was used to bring the differentials that needed to be replaced. In all we needed to do six replacements. As it turned out, we were one differential short and had to secure the equipment for winter over about 3 days short of our goal. The Norwegians would go down early the next year, basically setup a garage and replace the drive trains. That basically fixed the differential problem and they sailed back to Troll without problem. The Norwegians had field tested the vehicles and made a number of other adjustments before taking them to Antarctica, but the differential problem had not surfaced – so field test, field test, field test.

[Slide 31-36] Summary of Lessons Learned (well documented on slides as text).

[Slide 37] Acknowledgments

[Slide 38-42] Preliminary Science Results

[Slide 41] On the Troll – South Pole – Troll traverses, a 400 MHz Ground Penetrating Radar (GPR) system is used for crevasse detection and navigation along the entire route. The GPR provides very reliable identification of crevasses concealed under a snow cover, and will greatly enhance the travel safety – especially during the second season when the route comes very close to known crevasse zones in the Recovery Lakes region.



# NOR-USA Scientific Traverse of East Antarctica: Science & Logistics on a Three-Month Expedition Across Antarctica's Farthest Frontier

Mary R. Albert, Ph.D.  
Dartmouth  
Hanover, N.H.

1



## Norwegian – U.S.A. Scientific Traverse of East Antarctica

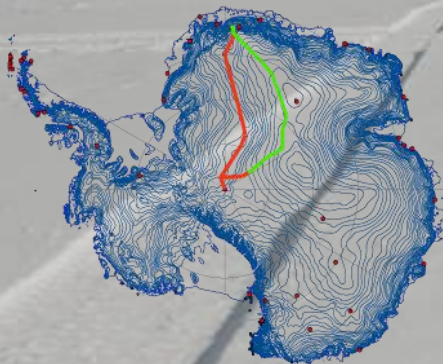

**Mary Albert (U.S.), Jan-Gunnar Winther (Norway)**

**U.S.: Ross Edwards, Gordon Hamilton, Glen Liston, Joe McConnell, Tom Neumann, Ted Scambos, Eric Steig**

**Norway: Svein Erik Hamran, Elisabeth Isaksson, Jack Kohler, Rune Storvold**

<http://traverse.npolar.no>

2



## Overview



- Why traverse across Antarctica?
- Pre-traverse planning
- The team and the team's attitude
- Humans on long-duration missions
- Balancing science & logistics
- Summary of lessons learned

3



## Overview



- Why traverse across Antarctica?
- Pre-traverse planning
- The team and the team's attitude
- Humans on long-duration missions
- Balancing science & logistics
- Summary of lessons learned

4

## How is East Antarctica reacting to global climate change ?

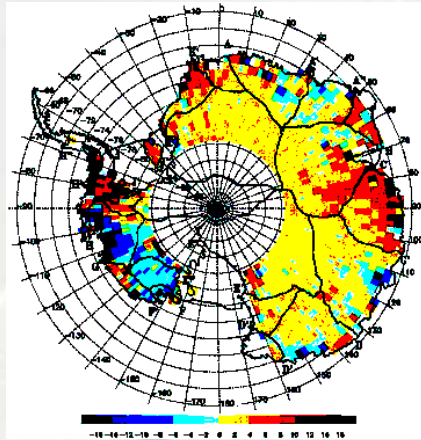

Davis et al, 2005

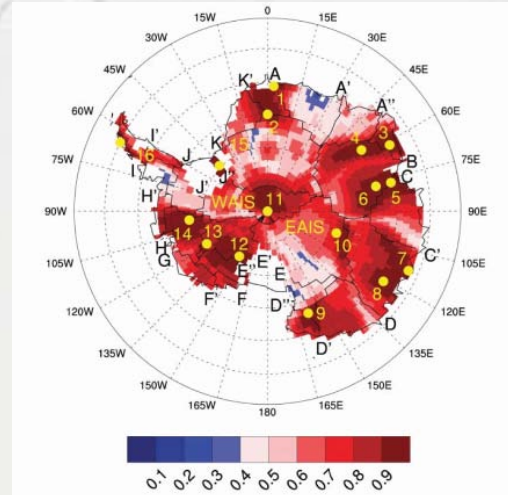

Monadhan et al, 2006

Remote sensing signatures contain uncertainties, and few ice cores have been drilled in the interior to constrain models. IPCC 2007 pointed to the need for data.

5

## Overarching science questions:

- What is the accumulation rate in this part of East Antarctica, and has it changed in recent decades?
- What regional climate patterns are evident in this area of East Antarctica over the last 1000 years?
- What is the evidence in East Antarctica of anthropogenic activity abroad?
- What is the thermal response of this area to global warming?

6





What is the accumulation rate in this sector of East Antarctica, and has it changed in recent decades?



Measurements: snow & firn physical, chemical and electrical properties

7



What is the accumulation rate in East Antarctica, and has it changed in recent decades?



Near-surface spatial variability:  
 UAV surveys  
 Surface roughness  
 Redistribution modeling

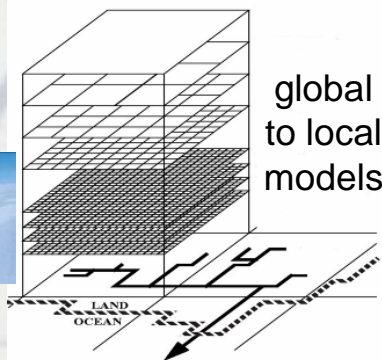
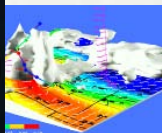
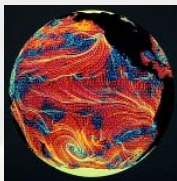

8



## What is the accumulation rate in East Antarctica, and has it changed in recent decades?



Extrapolation of measurements over larger areas:



Shallow radar & GPS

Satellite imagery

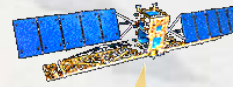

SAR image

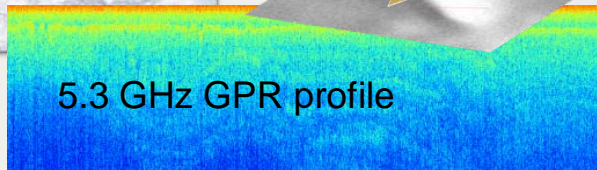

9



## What regional climate patterns are evident over the last 1000 years?



Measurements: chemical & isotopic composition of ice cores

10



## What is the evidence in East Antarctica of anthropogenic activity abroad?



Chemistry of snow and ice contains tracers for industrial pollution  
Careful sampling and analysis is essential to avoid contamination!

11



## What is the thermal response of East Antarctica to global warming?



Past (30~50 years): Firm temperature profiling

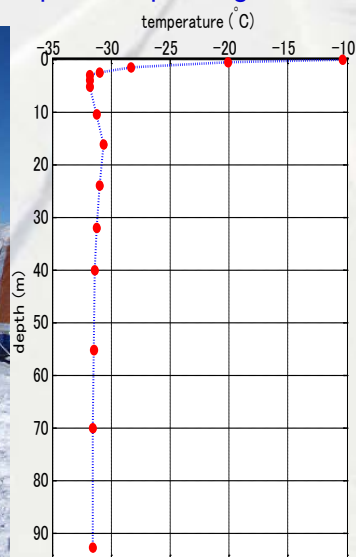
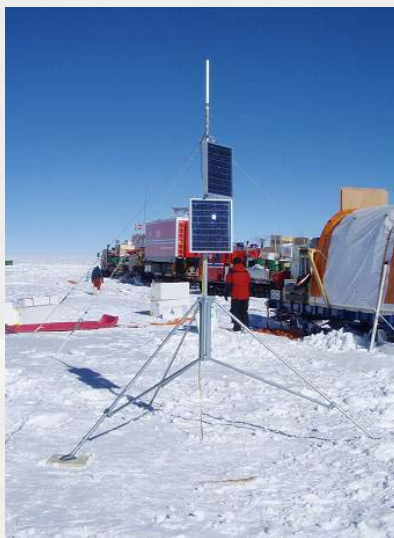

Present and future: AWS



12



# Overview



- Why traverse across Antarctica?
- Pre-traverse planning
- The team and the team's attitude
- Humans on long-duration missions
- Balancing science & logistics
- Summary of lessons learned

13



# The time was right



WMO

**THE NATIONAL ACADEMIES**  
*Advisors to the Nation on Science, Engineering, and Medicine*

 Norges forskningsråd



**“An intense, internationally coordinated campaign of polar observations, research and analysis that will further our understanding of physical and social processes in polar regions, examine their globally-connected role in the climate system, and establish research infrastructure for the future.”**

14



# Overview



- Why traverse across Antarctica?
- **Pre-traverse planning**
- The team and the team's attitude
- Humans on long-duration missions
- Balancing science & logistics
- Summary of lessons learned

15



## Years of Pre-Traverse Planning



### Whole-group meetings:

- Tromso Norway May 2005
- Arlington, VA (NSF) Oct 2006
- Jackson NH, June 2007
- Hanover NH, July 2007 (w/ Bentley, Orheim, Clough)
- (traverse year 1: Nov2007 – Feb 2008)
- Tromso Norway, April 2008
- (traverse year 2: Nov 2008-Feb 2009)
- Fairlee VT, August 2009
- Plus Monthly whole-group teleconferences 2006-2008
- Norwegian development of the vehicle infrastructure 2005-2007



16



## Years of planning plus pre-departure training contribute to success



Medical training



Safety training



Cargo handling

17



## Overview



- Why traverse across Antarctica?
- Pre-traverse planning
- The field team and the team's attitude
- Humans on long-duration missions
- Balancing science & logistics
- Summary of lessons learned

18



## The Team



**7: PhD scientists**

**5: support**

**3: women**

**9: men**

**6: Norwegian**

**3: American**

**2: German**

**1: Japanese**

**Ages from just under  
30 to over 50**

**Attitude: together we  
can do it.**

19



## Overview



- Why traverse across Antarctica?
- Pre-traverse planning
- The team and the team's attitude
- **Humans on long-duration missions**
- Balancing science & logistics
- Summary of lessons learned

20



## Life on the traverse: living module



21



## Life on the traverse: sleeping module



22





## Life on the traverse: science tent

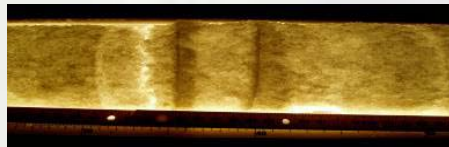

23



## Life on the traverse: workshop



24



## Special events: Plateau Station



25



## Special events: Christmas



26



## Special events: New Year



27



## Special events: visitors



28



# Overview



- Why traverse across Antarctica?
- Pre-traverse planning
- The team and the team's attitude
- Humans on long-duration missions
- **Balancing science & logistics**
- Summary of lessons learned

29



## Science & logistics are negotiated decisions

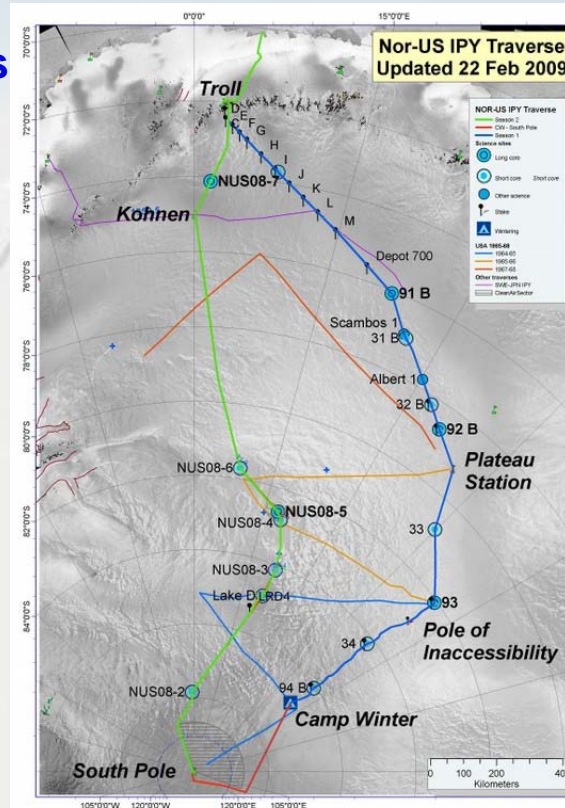

30



## Overview



- Why traverse across Antarctica?
- Pre-traverse planning
- The team and the team's attitude
- Humans on long-duration missions
- Balancing science & logistics
- **Summary of lessons learned**

31



## Why traverse?

- For specific and compelling science
- To collect samples, send a robot
- To do science, send highly qualified **scientists**

32



## Pre-traverse planning

- **Planning is crucial for all aspects of science, logistical, and human elements**
- **Planning needs active involvement of everyone on the field team**

33



## The team and the team's attitude

- **Highly capable, committed, compassionate people who respect one another and get along**
- **People who are sincerely interested in and committed to what they are doing, and not just there to rack up a badge.**
- **Need at least as many scientists as support with no barriers between them; everyone is busy all the time, and all take care of one another.**

34



## Humans on long-duration missions



- A healthy, well fed and well rested team of people who are sincerely interested in what they are doing can successfully continue for a long time.
- Periodic private communication with home is important and makes a difference

35



## Balancing science & logistics



- Science is the main goal, and logistics needs to be planned to achieve the science. When things go wrong, science and logistics are negotiated to salvage the best achievable for both (including the health and safety of all).

36



## Acknowledgments



- U.S. National Science Foundation
- Research Council of Norway
- Air National Guard
- ACLI
- Safair
- Raytheon
- Crews at Troll, Amundsen-Scott, and McMurdo Stations
- Capt Edward A Murphy
- and a long list of individuals and institutes who provided advice, inspiration, information, and other kinds of assistance

37



## Preliminary Results: East Antarctica near the ice divide has warmed over the past few decades

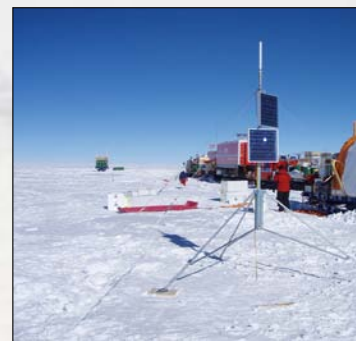
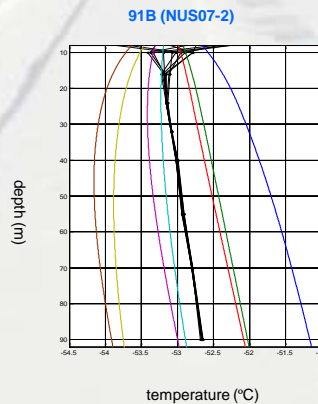
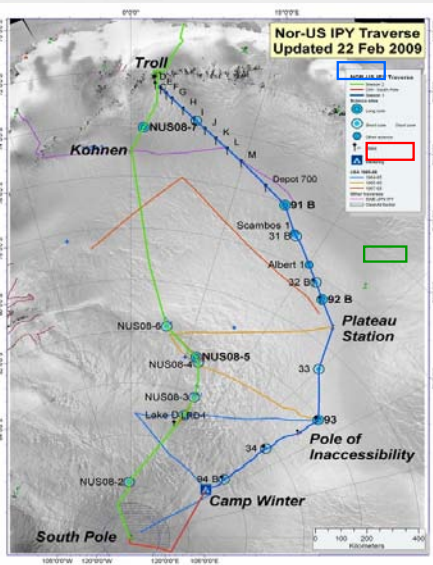

Muto, Scambos, Steffen,  
Excerpts from a poster at AGU, 2008 38





## Preliminary results: East Antarctic accumulation shows decreasing trend after ~1800

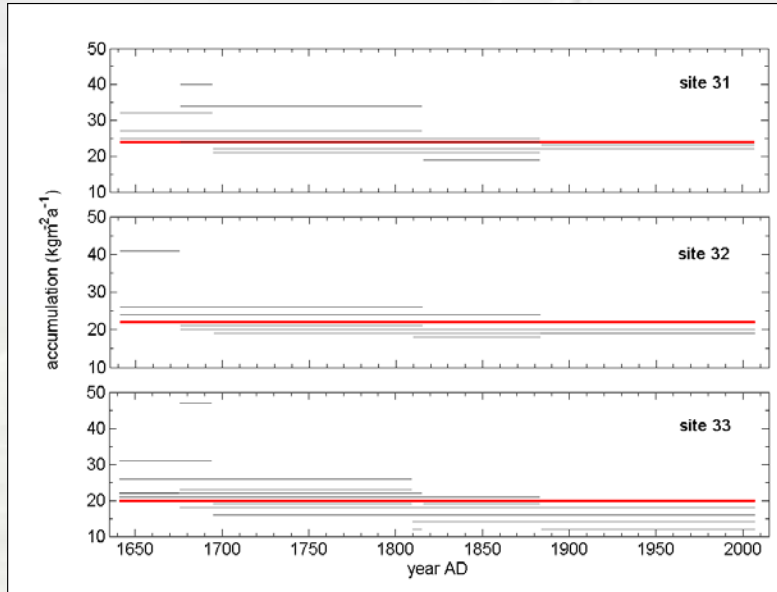

Site 31:  
24 mm/yr w.e

Site 32:  
22 mm/yr w.e

Site 33:  
20 mm/yr w.e

All sites showed decreasing trend

Anschütz et al., manuscript in preparation

39



## Preliminary results: Accumulation rate can be mapped from satellite images of firn properties

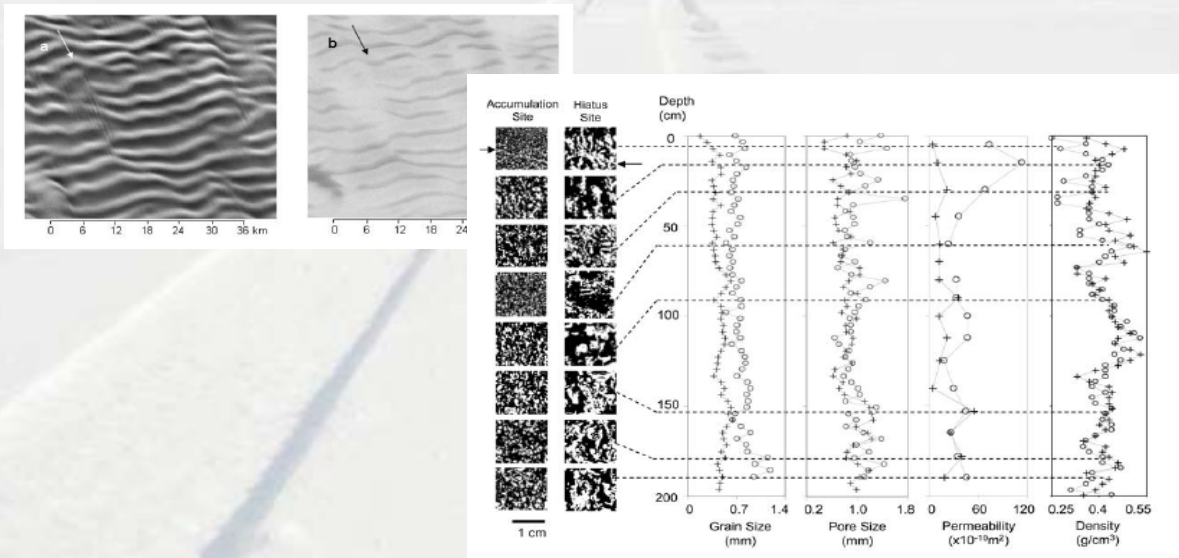

Albert et al, manuscript in preparation

40



## Safety: Crevasse detection

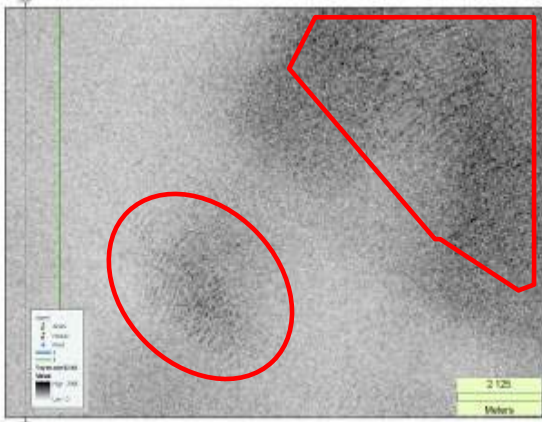

Pre-traverse route planning used satellite imagery to identify possible crevassed areas

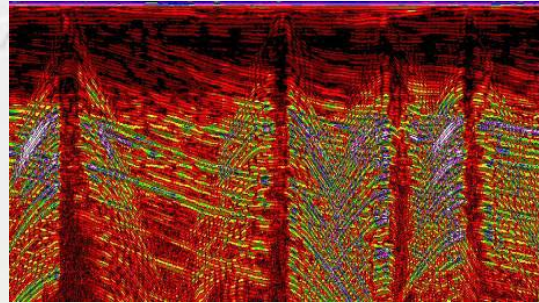

"The sniffer", a 400 MHz GPR

## **A9 – Presentation of John E. Gruener**

### ***A notional example of understanding human exploration traverses on the lunar surface***

[Slide 1] A notional example of understanding human exploration traverses on the lunar surface, John E. Gruener, NASA-JSC.

[Slide 2] Back in 2004 when the Vision for Space Exploration (VSE) was released and we started thinking about going back to the moon, we wanted to start thinking about not being limited to the local landing site like we were in Apollo. To do this we are going to need a traverse capability like you have been talking about today for Antarctica. So we need to expand from just an unpressurized capability to a pressurized traverse capability. Not just to support further distances from the land site, but also greater time away.

[Slide 3] Listed here are a number of different {science} groups, each with a different set of often conflicting requirements for their science on the moon. For example, the astrophysicists would like to be on the far side of the moon with a low-noise view of space, while the Earth scientists want the near side with a clear view of the Earth. So, we need to try and come up with an architecture or plan that makes everyone happy.

[Slide 4] We have been looking at the lunar South Pole for our reference missions. So we needed to see what science requirements we could meet using that location for an outpost. One way to increase the diversity of site to which we have access is long traverses. With traverses of 100 to few 100 kms, we can characterize the basins around the South Pole; get to locations with permanent views of Earth or permanent view of space away from Earth radio noise. The site also is advantageous for power as we have more consistent solar viewing than the 14-day day/night cycle at lower latitudes and that makes solar based power more practical.

[Slide 5] This is from a poster I put together for a NASA Advisory Council meeting in Tempe, AZ. It shows some of the more local locations to which we would want to traverse from the reference output location. These sites are not too far, but we would want to go there for days to weeks and work the field site.

[Slide 6] On a much larger scale, these are other basins and areas we could visit on traverses that are both further and longer in duration.

[Slide 7] Here I have laid out three different traverses that would provide us with a wide range of geological data.

[Slide 8] The data here shows the parameter space of how fast and how far we can travel under various assumptions. This data plus our EVA time at the sites will help define the logistics needed to support traverse activities.

[Slide 9] Applying the above data to the traverses I showed before, these are the sort of traverses that result. These may be a little optimistic. As you will notice, most of these traverses reference 14-day sequences; that is because of the day/night cycle. In order to go beyond 14 days, you need better power logistics.

[Slide 10] These are examples of some work done by other people in looking at the science we could do around the South Pole. The gray lines with purple points represent their traverse ideas with stops.

[Slide 11] Way before our current VSE thinking, there were ideas for long traverses across the surface of the moon.

[Slide 12] More recently, some other ideas for traverses not based on a South Pole outpost, but rather on a landing site with sufficient supplies for 45 days and 100 km of traverse capability. It was interesting to see how the two teams prioritized their science objectives. Each team also described the assumptions, basically their requirements, of what they needed to carry out their traverse.

[Slide 13] Assumptions of Team 1. The LRV-type soil sample was something done on Apollo. Without getting off of the rover, the astronauts would scoop up a sample. Both teams thought a good way to do this would be an improvement.

[Slide 14] Assumptions of Team 2. The second team had similar assumptions, but also included a cargo capability to drop of remote stations and carry small robots that would be used while the main vehicle was parked. This small robot would also be controllable from Earth as the astronauts rested.

# A notional example of understanding human exploration traverses on the lunar surface



John E. Gruener  
NASA-Johnson Space Center

1



## Unpressurized Traverses

Very Apollo-like (i.e., lunar roving vehicle)

Astronauts wear space suits

Limited to local traverses (10-20 km from outpost site) and short periods of time (<10 hours)



## Pressurized Traverses

Similar to current undersea exploration (i.e., pressurized submersibles)

Astronauts inside in 'shirt-sleeve' environment

Designed for long-duration traverses (i.e., many tens of km to low hundreds of km), and many days away from an outpost site

2

## Basic Needs of the Scientific Communities

### Planetary Science

Global access (e.g., crustal diversity)  
 Remote stations (e.g., control from earth)  
 On site sample analysis  
 Crew operations (e.g., field work, emplacement and maintenance)  
 Robotic operations (e.g., teleoperation)

### Astrophysics

Far side (e.g., radio telescope)  
 Remote observatories (e.g., control from earth)  
 Crew operations (e.g., emplacement and maintenance)

### Earth Science

Earth view (e.g., ideally near side)  
 Remote observatories (e.g., control from earth)  
 Crew operations (e.g., emplacement and maintenance)

### Heliophysics

Sun and Earth view  
 Instruments in lunar orbit and on lunar surface  
 Remote observatories (e.g., control from earth)  
 Crew operations (e.g., emplacement and maintenance)

### Life Science

Anywhere  
 Pressurized laboratory  
 Crew operations (e.g., research)

### Planetary Protection

Anywhere  
 Crew operations (e.g., research)



3

## Basic Needs of the Scientific Communities Lunar South Pole- an example

### Planetary Science

Shackleton crater possibly on South Pole-Aitken (SPA) basin inner ring  
 Malapert and Leibniz  $\beta$  possibly SPA basin rim  
 SPA terrane distinct from Apollo samples (e.g., Procellarum KREEP terrane)

### Astrophysics

Far side is accessible  
 Requires long range traverse, continuous power, and communications

### Earth Science

Shackleton Outpost partial earth view  
 Malapert peak-continuous earth view  
 Requires long range traverse, continuous power, and communications

### Heliophysics

Shackleton Outpost partial sun view  
 Malapert peak-continuous sun view likely  
 Requires long range traverse, continuous power, and communications

### Life Science

At Outpost

### Planetary Protection

At Outpost

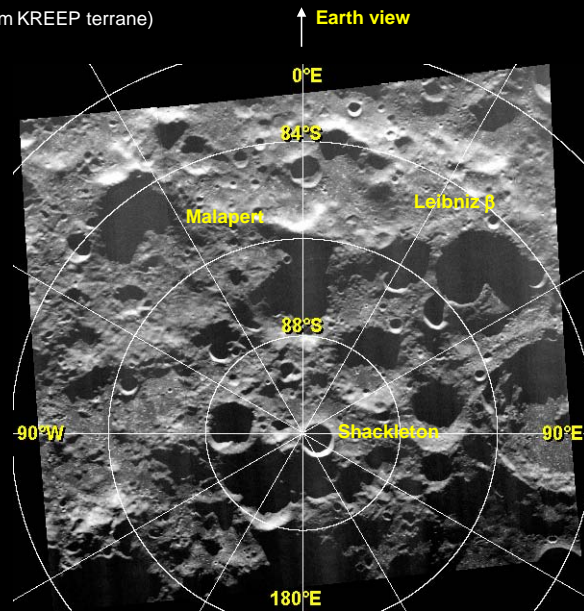

(from Margot et al, 1999 and Bussey)<sub>4</sub>

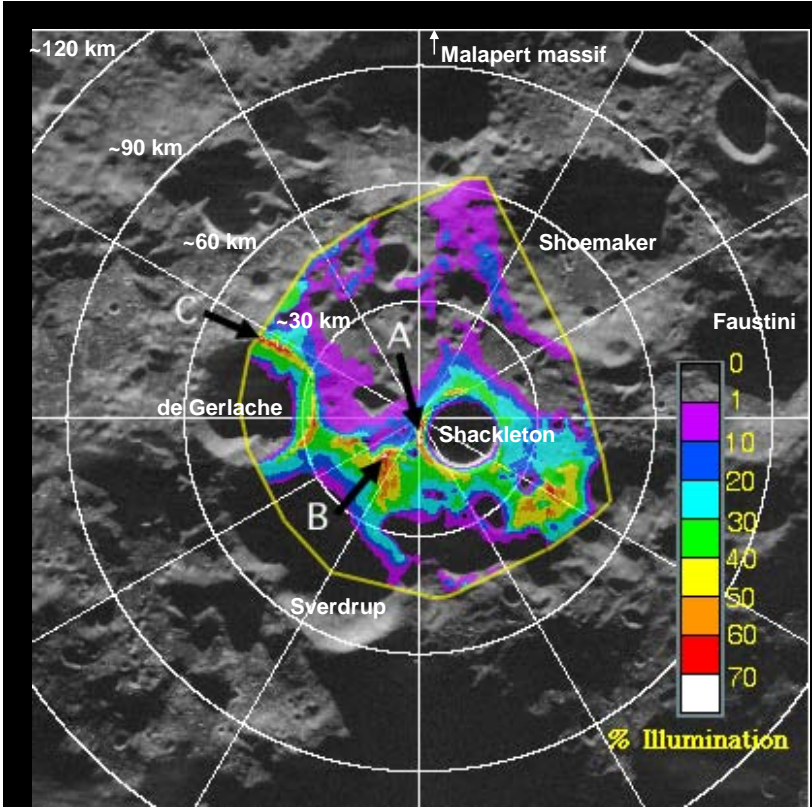

### Lunar Outpost at South Pole

Local traverses could be used for:

#### Infrastructure Emplacement

- Point A to Point B ~10 km
- Point A to Point C ~47 km
- Point B to Point C ~43 km

#### Exploration Science

- (distances from outpost to center of crater)
- Shackleton crater ~10 km
  - de Gerlache crater ~50 km
  - Shoemaker crater ~60 km
  - Faustini crater ~90 km
  - Malapert massif ~120 km

#### Resource Development

- Shackleton crater floor (19 km dia)
- Shoemaker crater floor (50 km dia)
- de Gerlache crater floor (30 km dia)
- Points A, B, and C (illumination)

From Bussey, et al., 1999

5

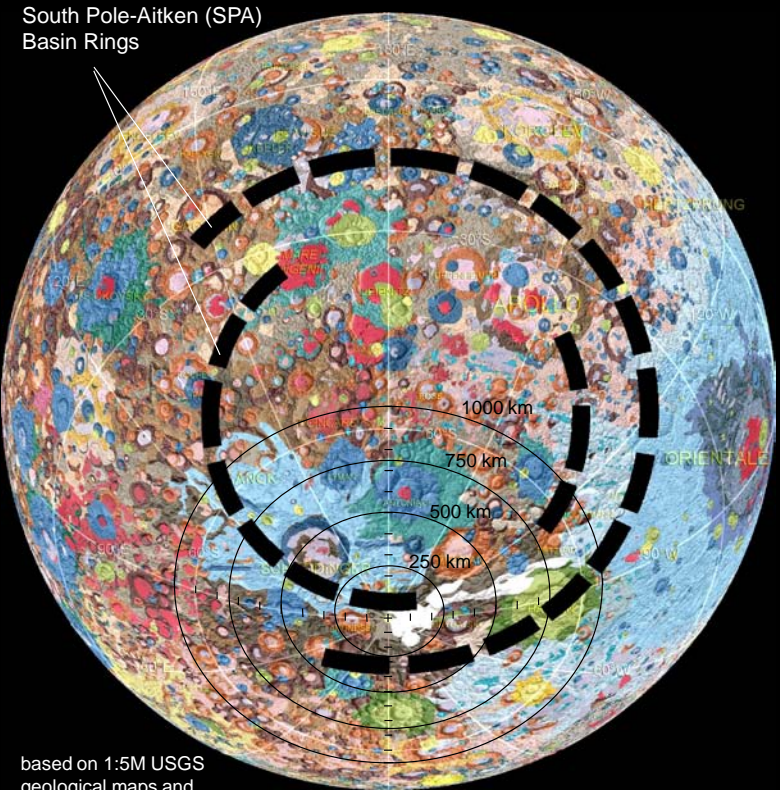

### Lunar Outpost at South Pole

#### Within 100 km

- Interior SPA basin materials
- SPA basin ring massifs
- Malapert massif
- Shackleton & Shoemaker craters

#### Within 250 km

- Amundsen & Cabeus craters
- Schrödinger basin ejecta
- Drygalski crater ejecta

#### Within 500 km

- Schrödinger basin; dark halo (pyroclastic) crater on floor
- Oriente basin ejecta
- Drygalski, Zeeman, Schomberger, Scott, Hale, and Demonax craters

#### Within 750 km

- Oriente basin ejecta
- Antoniadi, Lyman, Hausen, Moretus, Boussingault, and Neumayer craters
- Mare fill in Antoniadi

#### Within 1000 km

- Planck & Poincaré basins
- Mare Australe & SPA maria
- Cryptomaria near Schiller basin
- Fizeau, Petzval, Zucchi, and Clavius craters

based on 1:5M USGS geological maps and Wilhelms, 1987

6

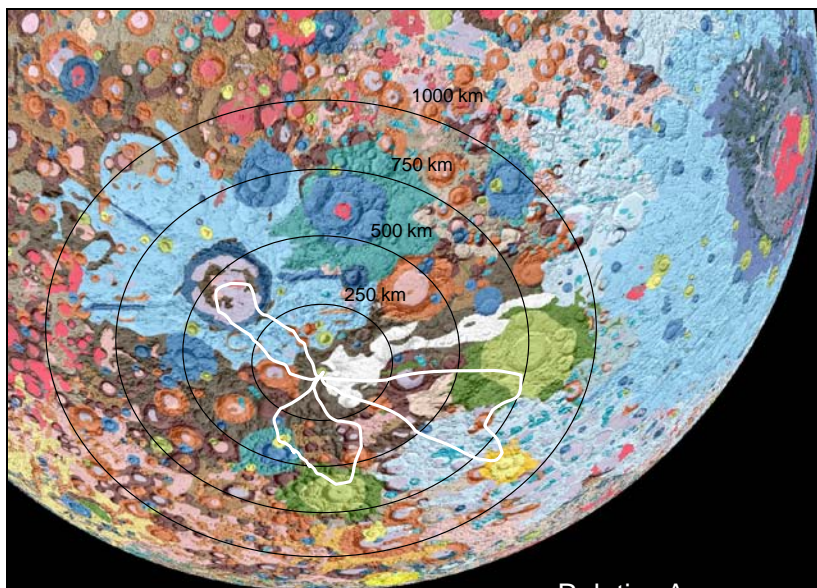

## Lunar Outpost at South Pole

The basic idea for long range traverses is to:

Visit major features

large impact craters or basins  
basin rim massifs  
resource deposits

Or

Visit as many 'colors' as you can

Characterize the heterogeneity in age and composition within a local geologic unit.

Characterize and sample maximum diversity in age and composition across many geologic regions.

Yellow = Copernican System  
Green = Eratosthenian System  
Blue/Red = Imbrian System/mare materials  
Orange/Tan = Nectarian System  
Brown = Pre-Nectarian System

### Relative Age

Youngest

Oldest

7

## Human pressurized rover long-range roving traverse distances from a lunar outpost at the South Pole

	Average Driving Speed					
	10 km/hr		8 km/hr		5 km/hr	
	Total (km)	Radius (km)	Total (km)	Radius (km)	Total (km)	Radius (km)
14 days, 10 hrs roving /day	1400	700	1120	560	700	350
12 days, 10 hrs roving /day	1200	600	960	480	600	300
10 days, 10 hrs roving /day	1000	500	800	400	500	250
14 days, 5 hrs roving /day*	700	350	560	280	350	175
12 days, 5 hrs roving /day	600	300	480	240	300	150
10 days, 5 hrs roving /day	500	250	400	200	250	125

\*This can be used as a proxy for using half of the days for driving, and half of the days for extravehicular activity (EVA)

## Apollo Lunar Roving Vehicle (LRV) traverse data

	Average Driving Speed (km/hr)	Average % of EVA spent driving
Apollo 15	8.9	17
Apollo 16	8.2	16
Apollo 17	8.2	19



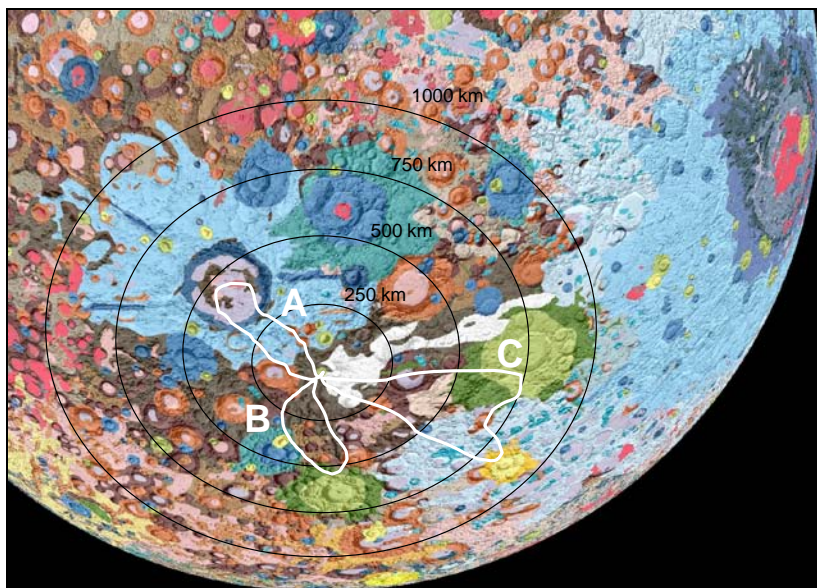

## Lunar Outpost at South Pole

### Human Pressurized Rovers

#### A. Long range traverse mission to Schrödinger basin:

< 500 km radius  
 12-14 day total mission  
 10 km/hr avg. driving speed  
 2-4 days in Schrödinger area

#### B. Visit as many 'colors' as you can

≤ 500 km radius  
 14 day total mission  
 10 km/hr avg. driving speed  
 1-2 days in Schomberger area  
 1 day in Moretus area  
 1 day in Newton area

#### C. Visit as many 'colors' as you can (extended)

> 500 km radius  
 >14 day total mission  
 10 km/hr avg. driving speed  
 mission extends into lunar night  
 major objectives: Zucchius, Hausen

9

Clark et al. (2008), Unraveling bombardment history of South Pole Region: Traversing Crater Ejecta Blanket 'Spheres of Influence'

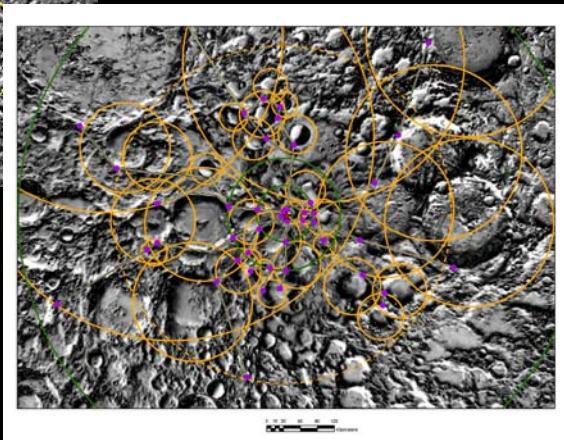
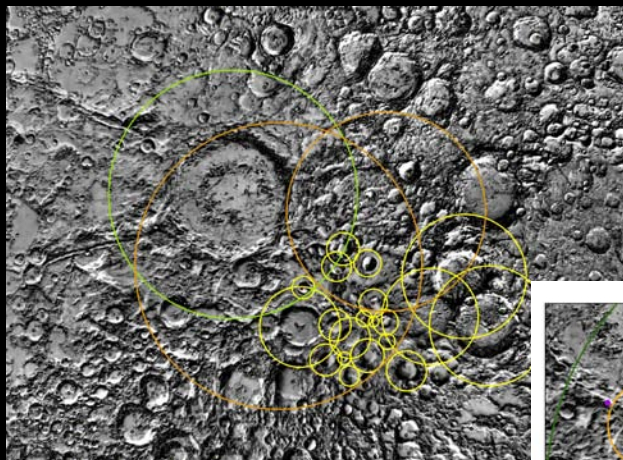

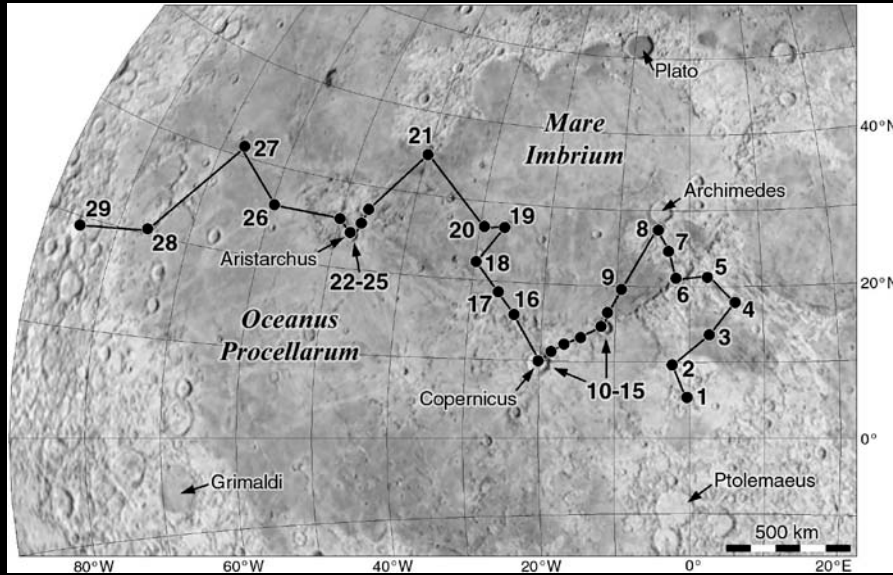

Cintala, Spudis, Hawke (1985), Advanced Geologic Exploration Supported by a Lunar Base: A Traverse Across the Imbrium-Procelfarum Region of the Moon

11



**Recent CxP Sponsored Workshop (2009)  
45-day Exploration of Aristarchus Plateau**



Team 1

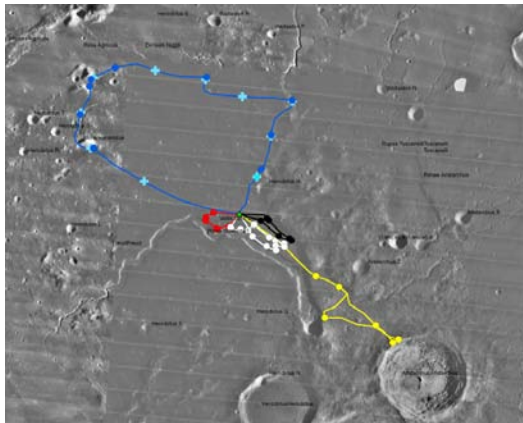

D. Carrier, B. Garry, J. Hagerty, P. Spudis

Team 2

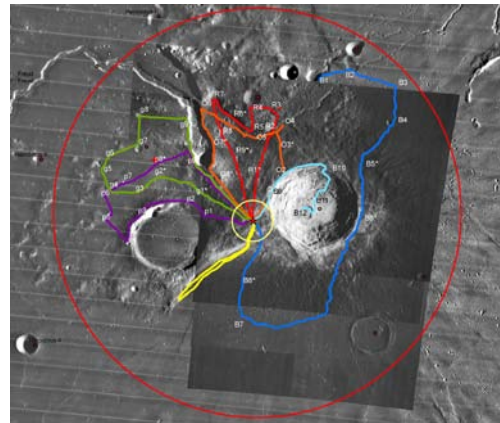

B. Banerdt, L. Gaddis, S. Mest,  
J. Plescia, R. Zeigler

# System Assumptions -Team 1

## Operations

No walk-back requirement (LERs back up each other), so trip out to max range first and work back not necessary (but not excluded)

Traverse routes and stops are *suggestions*; crew needs to use geological judgment to pick final sampling/field work sites

## Additional field equipment

HDTV on rovers documents traverses, site geological settings

Multi-spectral mapping camera (imaging spectrometer)

Small rock drill to collect oriented bedrock samples (few cm)

Traverse geophysics (gravity, GPR, magnetics, active seismic)

## LER requirements

Need to collect "LRV"-type spot soil samples during traverses (~300-500 g scoop)

Manipulator arm

Pull or carry robotic rover (RR) during LER traverses

Winch and tether; pull-points mounted on LER, RR, suits

Capable of being teleoperated from Earth for after mission activities (bulldozer blade, others TBD)

# Field Remote Sensing et al. – Team 2

## Hand-held

Camera  
XRF/XRD

## Rover- mounted

Arm / scoop for sample acquisition      Gravimeter  
Radon m/s      Magnetometer  
Multispectral (VNIR) – mast mounted – panorama  
GPR (penetration into the regolith, dielectric?)

## ALSEP-like station – deployed in three locations

Broad-band seismometer      Heat flow probe (5-10 m)  
Superconducting gravimeter      Radon detector  
EM sounding      Retroreflector (only at 1 station)

## FIDO Deployed from the LER

Operated from LER / Earth      Collect samples  
Local recon while LER is parked      Imaging system (HDTV)

## **A10 – Presentation of Johan Berte**

### ***The Princess Elisabeth Station***

[Slide 1] The Princess Elisabeth Station, Johan Berte

[Slide 2] If you are going to build a station in Antarctica, the first decision is where. Most stations have been built near the coast on the ice and because of the winds are quickly buried in snow. We selected Utsteinen; it is a little further inland on solid rock.

[Slide 3] This is the area where our station is located. It is an 1100 km gap between a Japanese station to the east and a Russian station to the west. Our easiest access is through Cape Town, South Africa. A Belgian station was in the area until 1967 and a Japanese station until 1991, when they were abandoned.

[Slide 4] The red dot is the location of our station; the two green dots are the previous Belgian and Japanese stations. Our station is on the west side of the mountains to protect it from the adiabatic winds. The location gives us access within 200 km to three different areas of scientific interest – the coast area, the mountain range with dry valleys, and finally the high plateau.

[Slide 5] These are some pictures of the typical types of science that you can do in the 200 km area around the station location.

[Slide 6] The goal of the project was to build a station and enable science. So first we needed some basic requirements, which I have listed here; plus we had to finance the station ourselves. Our most important requirement was that we decided to make it a zero emissions station. This was both a philosophical choice as we thought it more consistent with Antarctic Treaty obligations and it was also a logistical advantage. If you are using renewable energy sources, you do not have to bring in all the fuel.

[Slide 7] When I came into the project in 2004, there had already been some work done by an architect; the design presented to me was mostly driven by aesthetics. The sponsors wanted a new approach and the diagram on this slide shows in a nutshell the methodology I used. We took a broad view to develop several concepts over a range of parameters. Building a zero emissions facility is not difficult; building one that also meets the science, human factor and lifetime requirements is more difficult.

I was working with people from the building community that were used to getting a set of architecture drawings, after which they would hire engineers and develop a technical solution that fit inside the aesthetics of the architecture drawings. What we did instead on this project was to remain in the trade space of the parameters without drawings and let the architecture be one of the results. Of course people get nervous if they do not have something to see, so we would create visualizations, crystallizations at points in time. Out of 11 potential building concepts, one was selected through a process of trade-offs to become the baseline for further development.

[Slide 8] This was the first crystallization (iteration) from our process and was the baseline that we evolved. We treated the Antarctic environment not as an enemy, but as an ally, so we were looking for features that could help us. This version consists of two modules. The first module is easy to see and sits on the rock, elevated by poles. The second module is lower, on the non-wind side in the ice next to the rock. The two modules are connected by stairs so that you do not need to go outside. Through measurements, we know that the ice is very stable.

The main module has a technical core containing systems such as water treatment. In the next layer out from this technical core are all the items that use core resources, so in this case for example the bathroom. This keeps everything compact and integrated with short piping. The next layer out are the living areas. Here on the wind side, where we can better control the wind flow and thus reduce noise, we have placed the sleeping rooms. On the non-wind side, we have storage and infirmary, less used areas. To the north (left), we have the offices because there is nothing to see in that direction. And finally, on the south side, we have the living room with a view of the mountains. You will also notice that we are basically circular, so you always have two ways to get to the same place.

[Slide 9] This was the level of drawings I allowed people to use as we worked on the concept of our station.

[Slide10] The station starts to evolve. The roof section has become bigger as we saw an increased storage need for our solar thermal heating systems. We also standardized the wall sections and angles between sections to ease the logistics of building the station. This geometry was combining requirements from ergonomics, construction, aerodynamic and solar passive gains

[Slide 11] This is one of the many small trade studies that we did in our parallel process. This is our light study in which we found out that good lighting conditions meant less energy for lights, but could also heat the station too much. Our first design had offices with temperatures of 40°C (104°F). The engineers of course had an immediate solution – add an air conditioner to the office space. To which I replied, “Are you crazy?” From a week at the Norwegian station, I had learned that people wanted to look out, but were always closing the blinds because of the low sun angle. So our solution to both these problems was to put in low windows on the side and indirect lighting from above. All window layouts were designed to control these solar passive gains but at the same time answered psychological needs. This is just one example showing how simple solutions can solve complex problems.

[Slide 12] And so the station evolved again – this is a drawing I made on the airplane to South Africa. You have lots of time to do this on 11-hour flights were no one is bothering you. [Slide 13] So this was then the third crystallization. The big change here is that the staircase has been replaced with a tower-like structure inside. This allow for gravity feed of water when needed. Also in the tower is a control room-like area for the manger to view what is going on outside on the wind protected side.

[Slide 14] The reason for the pretty pictures here is that it was time for a press conference. At this time, we thought we had a design, but still needed to finish our snow erosion models and testing, which were ongoing at that time.

[Slide 15] And this is what evolved in those studies.

[Slide 16] Why was that needed? We had good control over the forces on the building, which we had controlled from the beginning.

[Slide 17] We also controlled snow accumulation effect pretty well, but we were neglecting a little bit the snow erosion effects. Our model showed that we would dig out our garage (the module in the ice/snow) over time. We changed the corners to reduce the vortex and moved the station slightly. It was only 10 cm in one direction and 20 cm higher.

[Slide 18] This was then the design at the end of that period.

[Slide 19] We also looked at materials. Although we were always interested in high tech materials, we kept on coming to the conclusion that wood worked best. So, 90% of the building is wood construction. Wood use was however not well known to us, so we brought in some specialists to help us analyze water content and other factors. This was important because the wood starts out in Europe, goes through the tropics and ends up in the Antarctic all in fairly short time.

[Slide 20] We also need to work out how to work with the wood and how to package it. All 114 of the containers were worked out in 3D, so that we had good center of gravity and weight data for unloading under sea ice conditions.

[Slide 21] And we did a good amount of testing. This is the last model of the final design. You see a wall section. The outer section is a skin, not part of the mechanical design, which contains insulation. There are two ways to handle the typical problem of snow/water intrusion. One is to avoid and the other accept. We choose to accept. So the skin is designed such that water melt will come out the bottom.

[Slide 22] This is part of our production.

[Slide 23] After a study of what we should test and what we should not test, we decided it was easier to build the station in Belgium and use the opportunity to train the crew and test procedures. We even reproduced the rock environment.

[Slide 24] And of course, since we built it, we had to invite some people. We had it open for 3 days and more than 40,000 people went through it. This was quite a good vibration test.

[Slide 25] This was our parallel study on energy. The goal was not only to make the building zero emission, but also energy efficient within the constraints.

[Slide 26] One of the major factors in the Antarctic is that you are autonomous – no power grid. With renewable energy, grid stability is difficult to achieve. You need to balance the items listed here.

[Slide 27] We worked with standard stand-alone grid with a three-phase bus, which included generator backup, solar energy, wind energy, and batteries. Only surplus energy is stored in the batteries. Of course, you theoretical installed power (consumers) is far more than you can produce, so you need an energy management system. You could just go with a factor of 3, but we needed to do better.

[Slide 28] So we looked in detail at how the power was being used in different situations (attended, unattended, winter-over, etc...). We used two redundant controllers, similar to what you would find in a chemical plant. We have a system that prioritizes usage. For example, charging my MP3 player is not a high priority. We wanted people to be aware of the energy usage, so we installed a large status display in the living room. It was interesting to see how quickly people adapted to such a system. People coming in from outside would naturally look at the energy status.

[Slide 29] We had a number of issues integrating the electrical trays. The number and space needed tripled once we starting outfitting. Now these electrical units need constant temperature and humidity throughout the year; so that needed to remain in the technical core. Our solution was to put them on movable racks with cabling that allowed them to stay connected when moved. Thus, we could roll them out of the way when we needed to work in the area.

[Slide 30] This is the water treatment unit schematic. All water is treated and we have 70-75% recovery from secondary systems. Only drinking water is melted from the snow adjacent to the station.

[Slide 31] As you can see, the water treatment unit is a very compact system. These are pre-assembled as a unit and slip right into their location.

[Slide 32] The water treatment units have full access from the front, so they are easy to maintain in the tight area.

[Slide 33] Here is the water storage in the tower section. There is a reservoir for melt water and one for recycled water.

[Slide 34] This screen shot is from management system (SCADA); this one is for the solar thermal system. There are similar screens for all systems. We have access to such screens in both the base manager's office and the living room.

[Slide 35] To prepare, we constructed the entire technical core in Belgium; again, we did this for both testing and training.

[Slide 36] This is a list of the expeditions and corresponding goals leading to the creation of an operating station. Because our landing site is not accessible until December, we need to plan our deliveries for the following year.

[Slide 37] Scouting the site on the first expedition.

[Slide 38] This is how we got there, using the Novolazarevskaya runway at the Russian station.

[Slide 39] This is our target area. Originally 8 locations in the 300 square km area were under consideration and here you can see our final selection. The parameter list for selecting included requirements like accessibility, sun and wind conditions, access to fresh snow, stable bedrock etc....

[Slide 40] This first expedition went in by air and consisted of 7 people and 2 tons of equipment, including 2 snowmobiles. We only had a limited period of 1 month on the ice.

[Slide 41] Another view of our final selection; protected, but not so protected that wind turbines would not work; good access to the plateau; soft snow for water.

[Slide 42] During this visit, we installed an automatic weather station and did a topographic survey. These data were used for the engineering process.

[Slide 43] For the second expedition, we came in by Bessler (refurbished DC3).

[Slide 44] We needed to map a route from the coast to the station site. Of course, near the coast there are lots of crevasses.

[Slide 45] On the third expedition we came in by ship.

[Slide 46] And we were lucky and found a good offloading location with a natural ramp in a crack. Unfortunately, the wind picked up, pushing the ship back and the ship took the ice with it. So in the end it took us almost 10 days to get 12 containers on land.

[Slide 47] What worked very good was this logistics train. We have an agreement with Norwegians whereby we bought the same vehicles as they had and then we could share spare parts. We used for the first time this side loading mechanism and it worked very well.

[Slide 48] At the site, we tested the anchoring ability of the rock for the wind turbines. We assembled one turbine for testing.

[Slide 49] After the problem at the first ship unloading site, we needed a different unloading site for the fourth expedition. We found this new site, but it was much more to the west.

[Slide 50] So we had to re-map the access route.

[Slide 51] So this is our ship on the fourth expedition at our new landing site.

[Slide 52] We traveled about 5 km over the sea ice. This is our new ramp area. During this year we unload 117 containers, 1000 fuel drums and two new vehicles.

[Slide 53] Our logistics guys laid out all the unloaded containers; and if you look at the satellite photos, you can see them all nicely lined up.

[Slide 54] Then of course, you have the normal Antarctic issues – weather and breakdowns.

[Slide 55] At the site we had to deal with one more big issue – the anchoring of the building. The rock is not really solid bedrock, so we had to not only anchor the building to the rocks; we have to anchor the rocks to each other. This was one thing we could not test. And we finished just as the first vehicle was coming in from the coast.

[Slide 56] Here we are starting to build the station. The lessons learned from building it first at home really paid off.

[Slide 57] The assembly went much quicker than we expected.

[Slide 58] Soon the entire garage was complete and the frame for the upper building was complete.

[Slide 59] Then we came to a decision point. Do we close the building or not? You do not want to have a half-closed building during a storm. We decide to close it. With the skin you can see a combination of rounded forms and sharp edges. The sharp edges on the corners are vortex triggers.

[Slide 60] Here is a nice distance view of the station. During a storm, we left the crane unlocked and it just moved back and forth with the wind like a wind vane.

[Slide 61] Just after we closed, we had our first storm. This was actually good as it allowed us to immediately evaluate the wind interaction around our new station. There were no vibrations at 140 km/hr (87 mph). There was not enough snow to evaluate accumulation patterns.



[Slide 62] A good view of the station from the Utsteinen.

[Slide 63] A picture taken during the last days of the season.

[Slide 64] My office.

[Slide 65] The base camp.

[Slide 66] Another view of the station from the Utsteinen.

[Slide 67] During the fifth expedition, we were working to get all the active systems installed.

[Slide 68] Although I was attempting to hold off the scientists until we were a little more complete, we did start science operation last year. This is a list of those science projects.

[Slide 69] This is an important picture – after leaving the station for 8 months, the big news was that it was still there, including all the wind turbines.

[Slide 70] This is the mess tent to the east side of the station. Although you cannot see it, there was no snow accumulation or erosion around the station.

[Slide 71] This is an overview of our base camp organization.

[Slide 72] This is a shot from our ultralight airplane, which we can use in good conditions.

[Slide 73] This is our tent city. Everyone has their own.

[Slide 74] This is inside our mess. Good food equals good moral.

[Slide 75] This is overview of our active systems connections throughout the station.

[Slide 76] The bio-reactor installed.

[Slide 77] The water storage with local water treatment not quite installed. Recycled water on the left; snow melt on the right.

[Slide 78] One of the solar thermal systems installed on the roof.

[Slide 79] The corresponding part of the solar thermal systems installed on the in the roof.

[Slide 80] Here you have your typical picture of a site under construction.

[Slide 81] Here are two redundant ventilation systems.

[Slide 82] This is an important picture. With wood construction, there is no natural grounding, which is inconvenient for people and a real problem for electrical equipment. So we laid down a grid of copper strips. The strips are laid down in 3D, so they include the ceilings, basically creating a cage.

[Slide 83] This is a picture near completion of the station.

[Slide 84] Here you see that we also have solar panels on the sides of the station. This does not add to the overall production as much as it allows it to be more continuous as the sun progresses.

[Slide 85] This is the power electronics and the solar panels on the garage roof. Originally, these were to go on the rocks, but logistically it was easier to put them here. We are a little worried about the effect they will have on the snow accumulation – we will find out when we return this year.

[Slide 86] Eight of the nine wind turbines were installed; the ninth will be installed this coming year.

[Slide 87] Here are some additional details on the wind turbines.

[Slide 88] This is the effect I mentioned earlier where we decided to accept the water melt in the skin and handle it instead of trying to avoid it all together.

[Slide 99] The snow accumulation does not look too bad around the solar panels, but we will see the final answer when we get back.

[Slide 90] Here is a short description on one of our expedition related research projects.

[Slide 91] And here are the preliminary results.

[Slide 92] These are the locations of some additional scientific facilities that have been built to the north and south of the station along the ridge.

[Slide 93] In the coming year, we will finalize the technical build out of the station, including adding our satellite communications.

[Slide 94] And we will start adding site projects. Here we are looking at adding UAV support with a vehicle that can carry a 100 kg science payload.

[Slide 95] Finally, at the beginning of the winter season, the lights go on.

# The Princess Elisabeth Station NASA - Antarctic Traverse Workshop



04/07/2009  
Johan Berte

1

## Terrain conditions

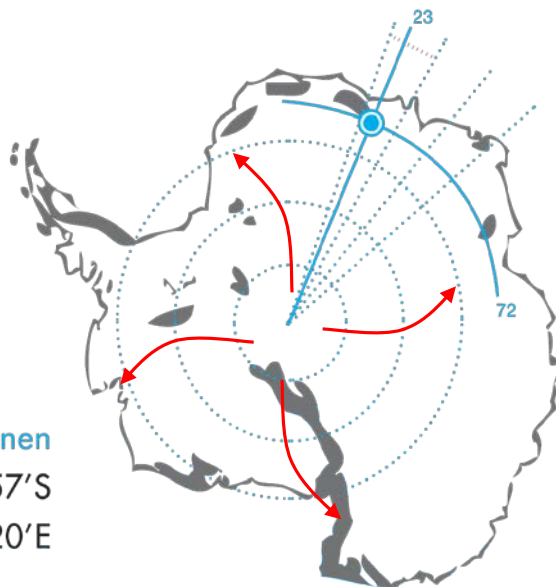

**Utsteinen**  
71°57'S  
23°20'E

Ice/compacted snow  
↓  
Plateau & coast  
&  
Rock/permafrost  
↓  
Mountains & coast

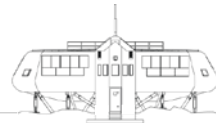
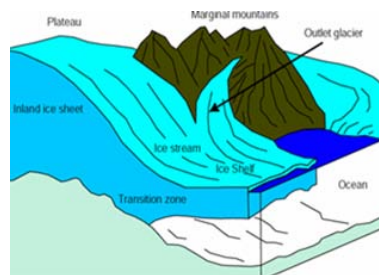

2

## Closing the network



SOUTH AFRICA (CPT)

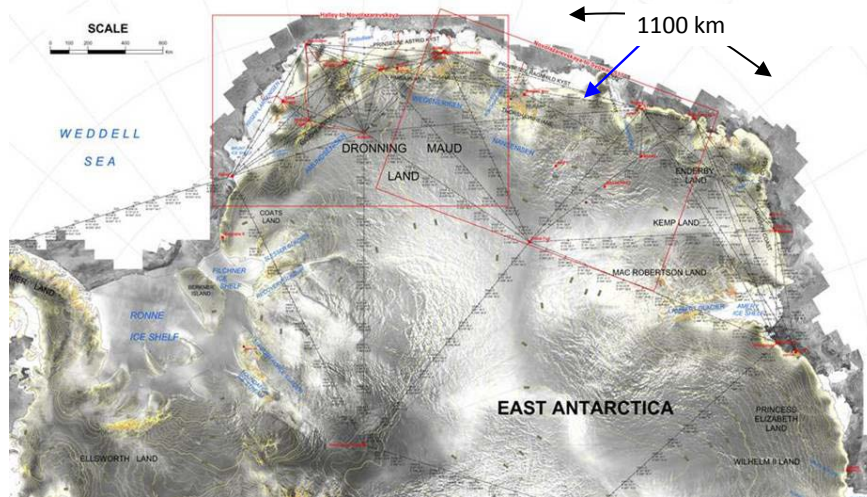

- Logistics
- Science
- SAR

INTERNATIONAL POLAR FOUNDATION

3

## Operations range

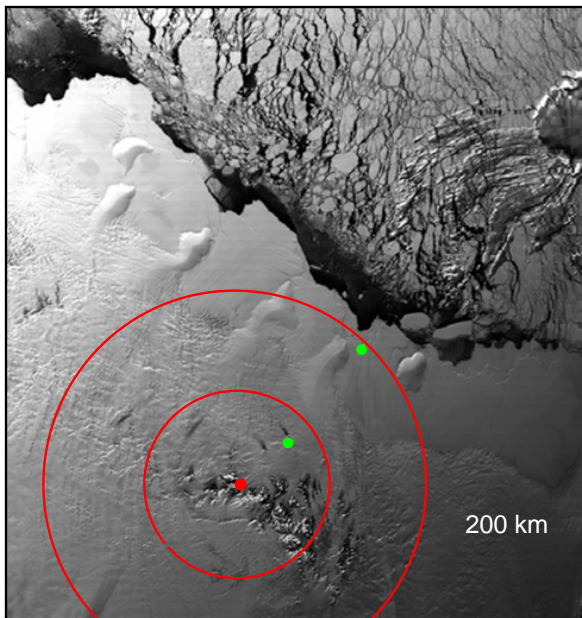

- Starting point for field expeditions up to 200 km
- Stand-alone facilities for observations : geomagnetic, ionosphere, gravimetric, GPS measurements, seismic ...
- Climatology, glaciology, microbiology ...

INTERNATIONAL POLAR FOUNDATION

4

## Science

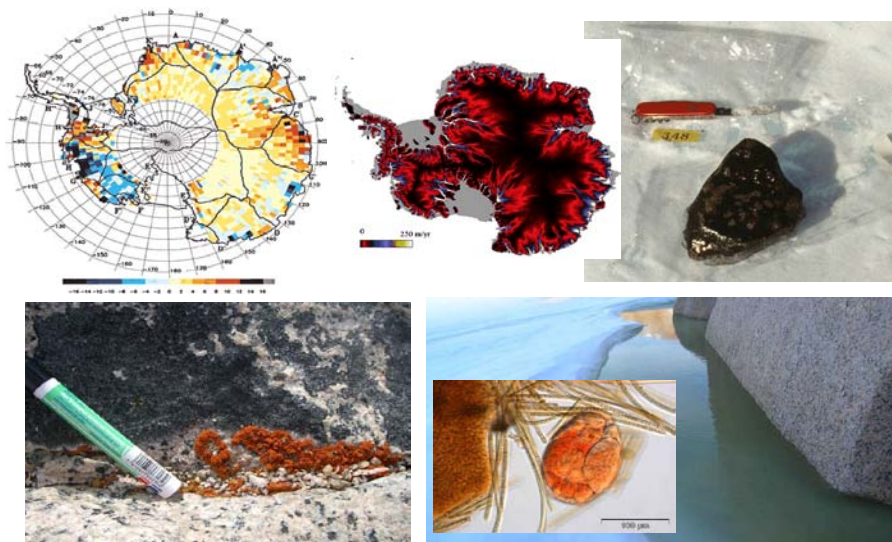

## Requirements



- Full year manned/unmanned
- Remote sensing
- Remote start-up (October)
- 16 Visitors (5 staff)
- Accommodation (living, technical, research, storage): 1500 m<sup>2</sup>
- +25 Years lifetime
- Zero emissions target

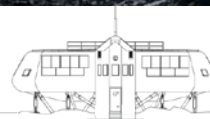

# Design process: methodology

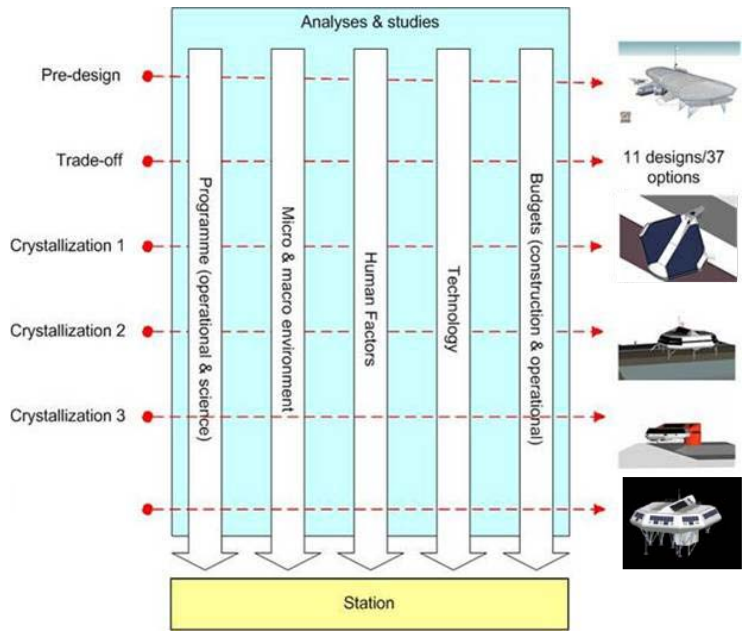

- Form follows function
- 11 designs
- 37 Integrations
- Trade-off process

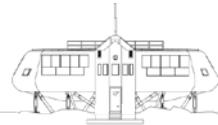

# A hybrid typology (C-1)

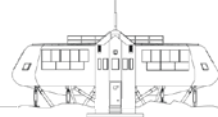
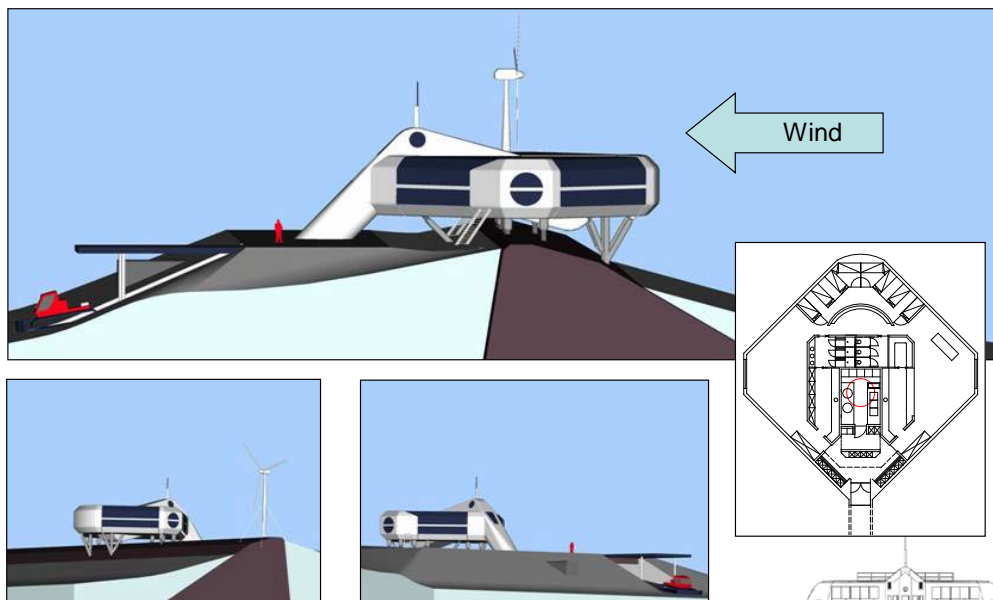

# Conceptual design

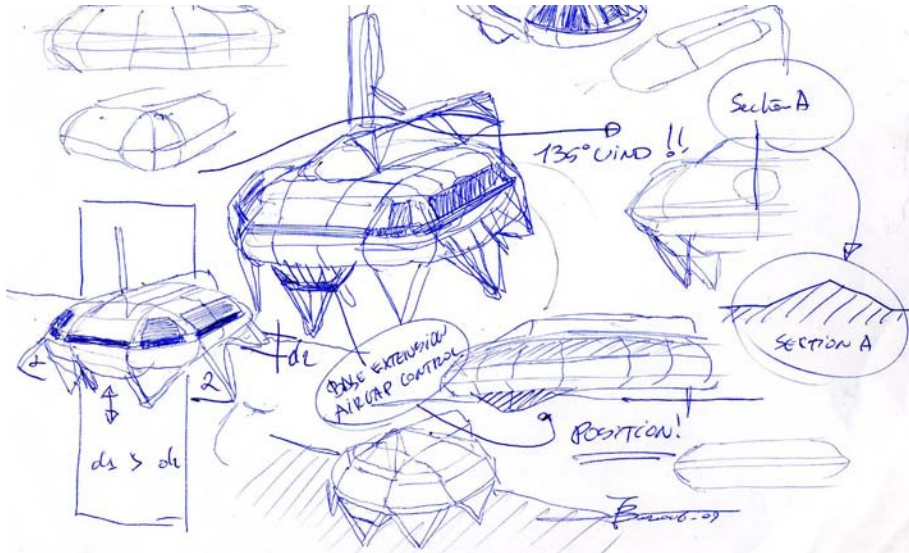

INTERNATIONAL POLAR FOUNDATION

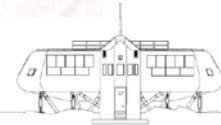

9

# Main building (C-2)

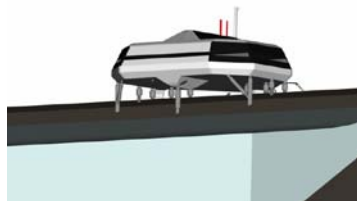
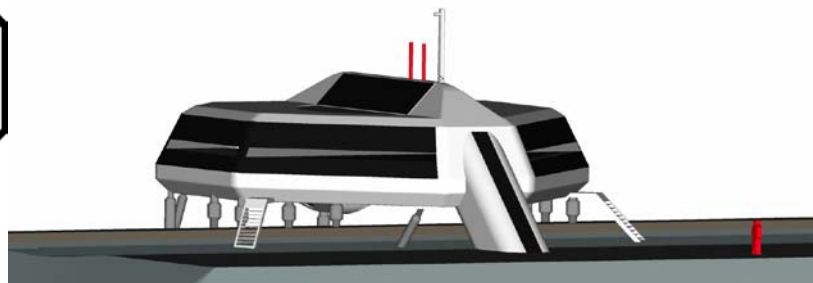
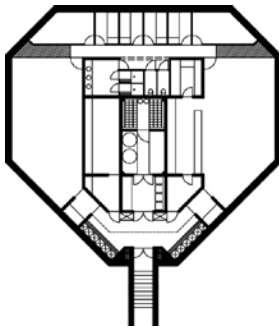

INTERNATIONAL POLAR FOUNDATION

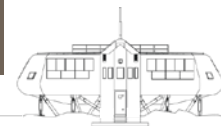

10

# Design process: key parameters



- Office
- 15 December
- 12:00
- No clouds

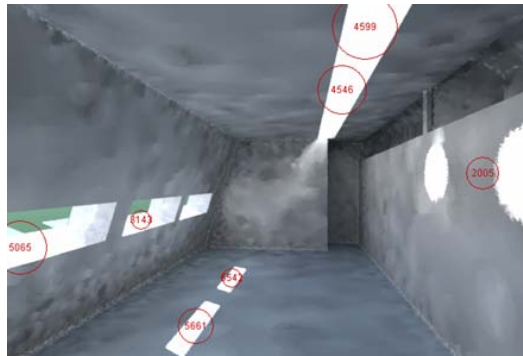

LUX  
 950  
 850  
 750  
 650  
 550  
 450  
 350  
 250  
 150  
 50

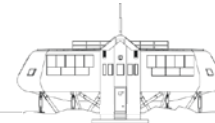
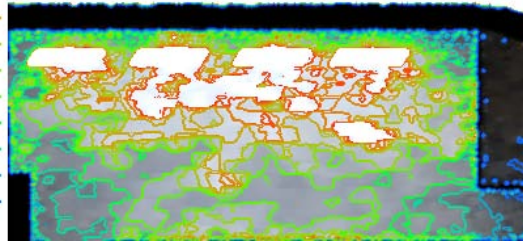

# Conceptual design

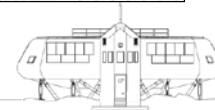
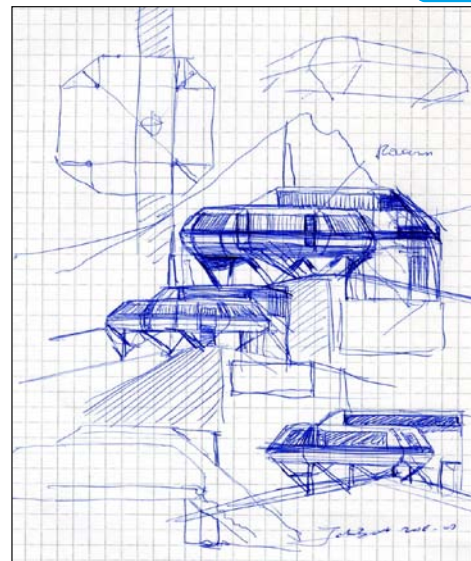
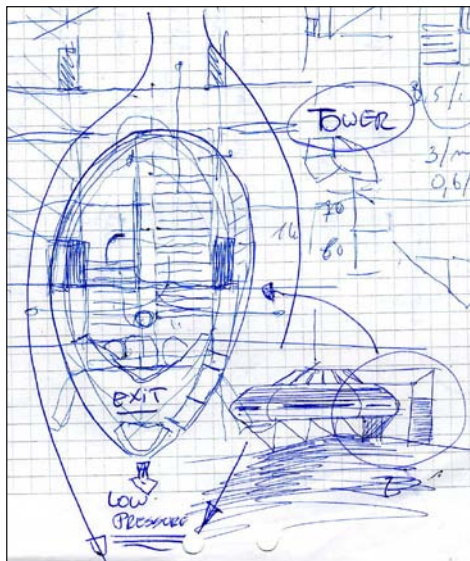



# Main building (C-3)

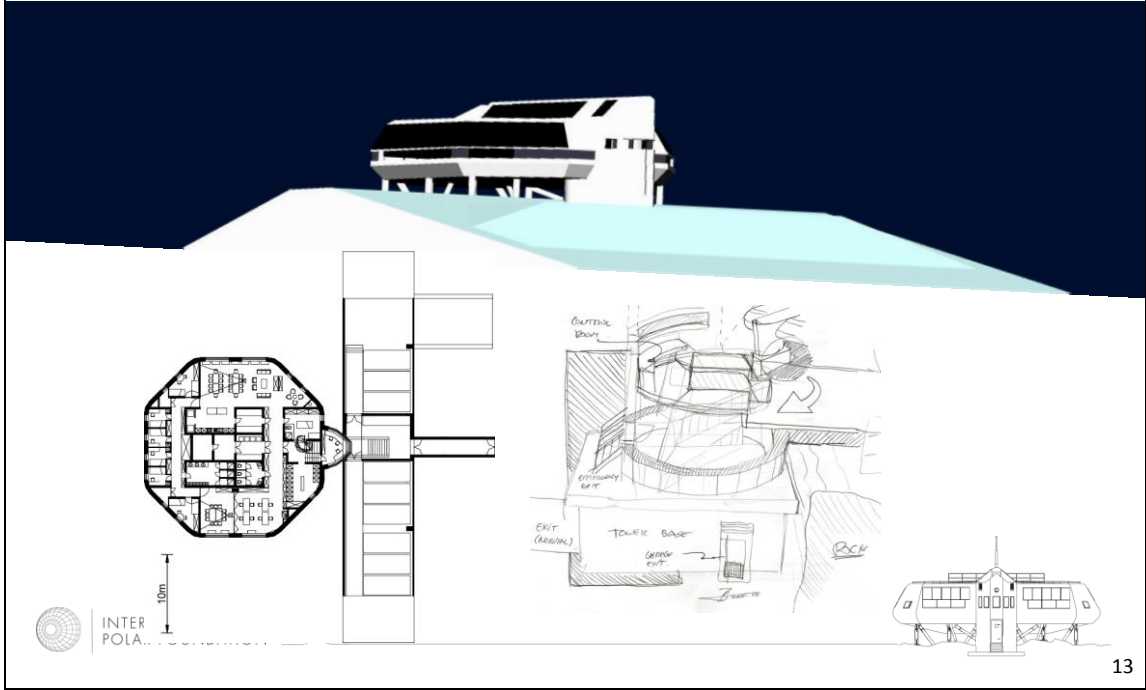

13

# 2006: design freeze



14

# Aerodynamic CFD modeling

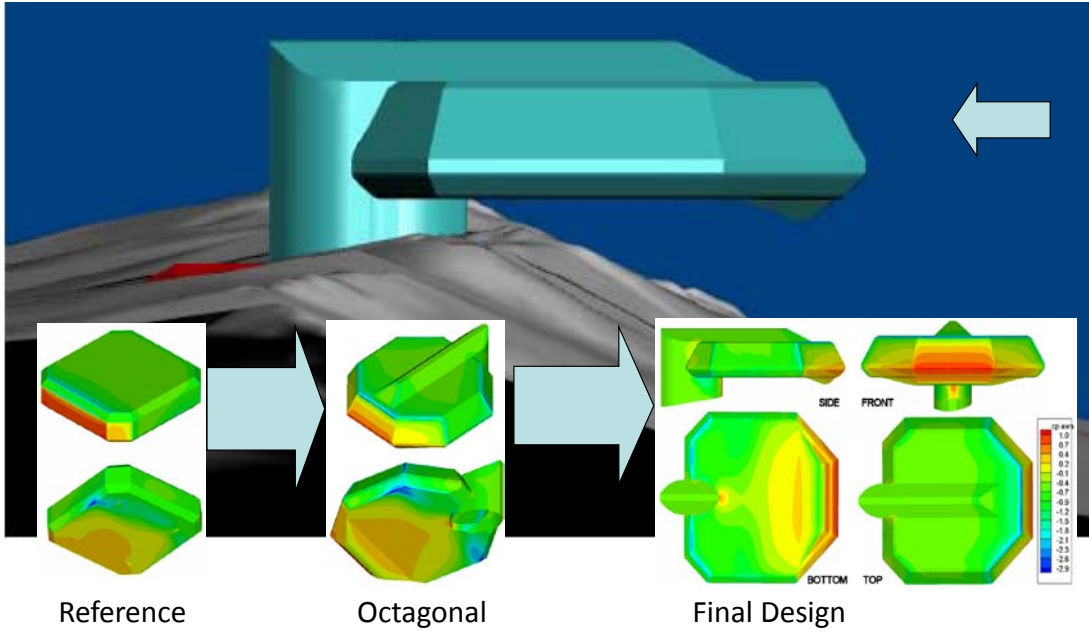

15

# Aerodynamic CFD modeling

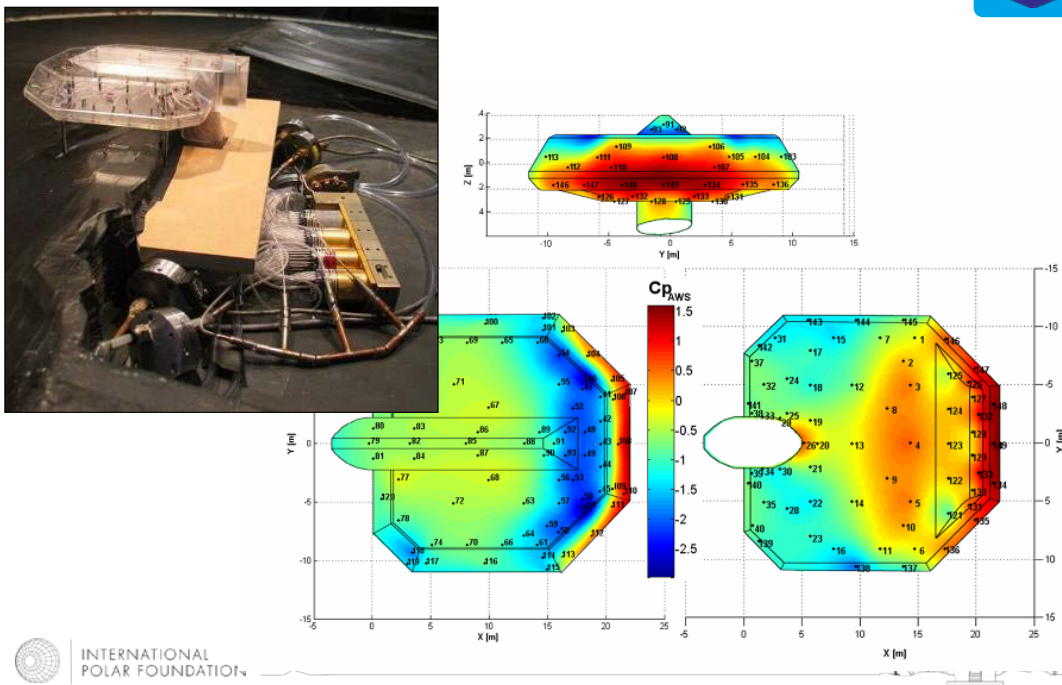

16

# Snow erosion/accumulation

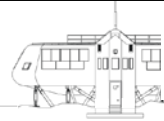
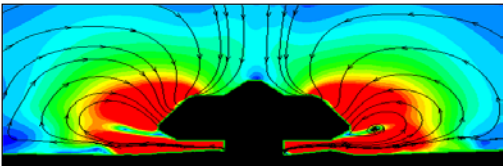
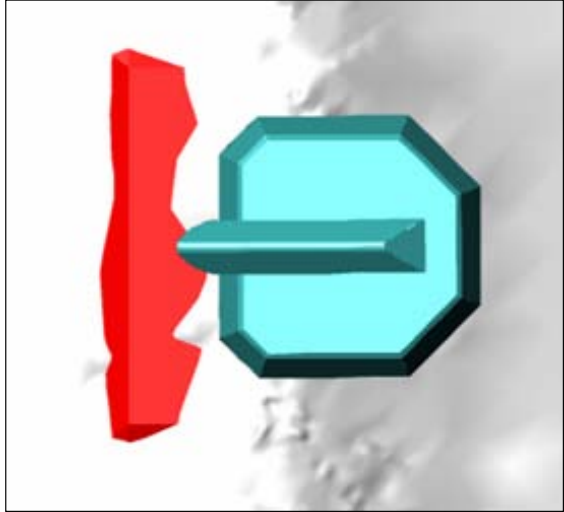

# Conceptual design

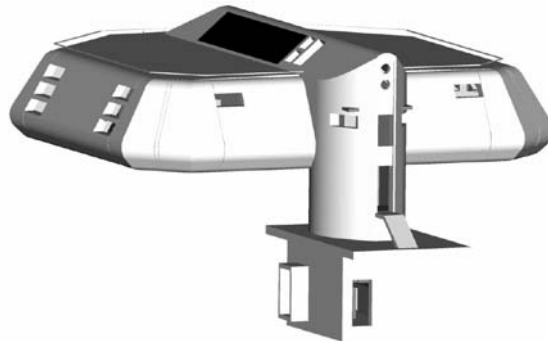
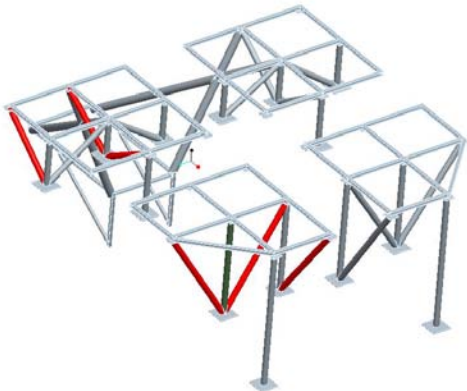
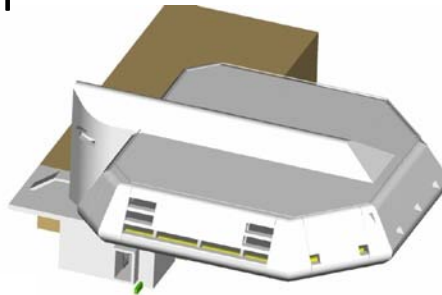
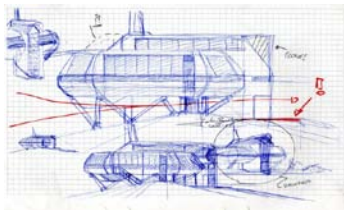

# Wood engineering

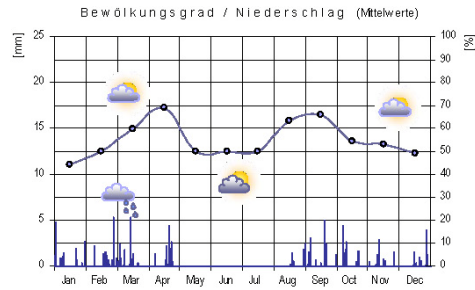
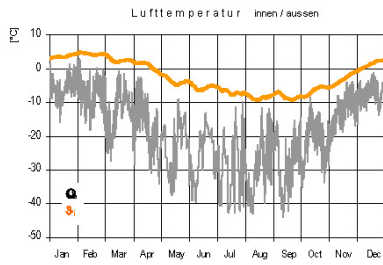
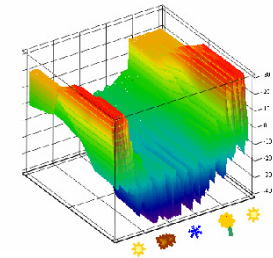
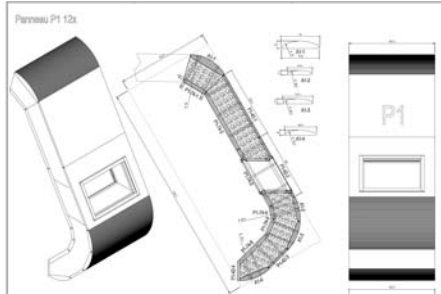

19

# Construction/transport

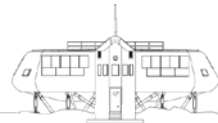
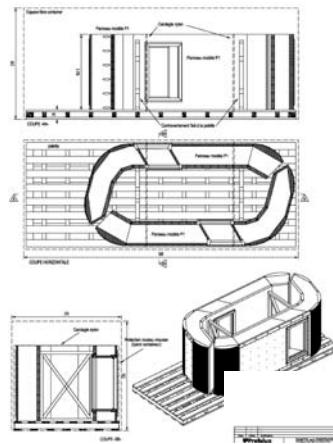
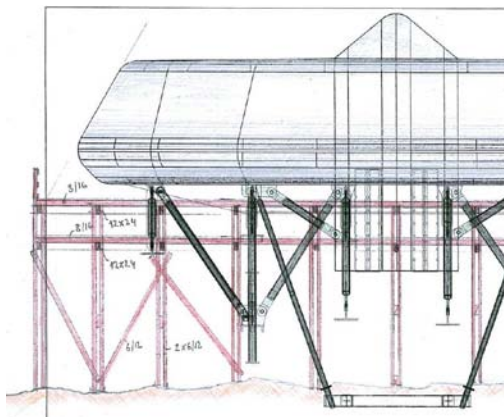

20

# Testing



INTERNATIONAL POLAR FOUNDATION

21

# Wood construction



INTERNATIONAL POLAR FOUNDATION



22

# Test assembly



INTERNATIONAL POLAR FOUNDATION



23

# 09/2007



INTERNATIONAL POLAR FOUNDATION



24

## Focus on micro-grid: Constraints?



- Isolated environment: Security!
- Low temperatures down to -30 C
- No earthing is possible! Ice & granite are good isolators
- Low humidity <10% => static electricity => kiloVolts are possible!
- Imposed Energy resources by pre-study of 3E:
- Photovoltaic
- Wind
- Batteries
- Gensets for backup
- Low Short circuit power 300A during 100ms (equiv. to Ucc of 25%) due to static converters => adapted protective strategy

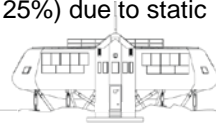

## Focus on micro-grid: Technical



- 3 x 400V + N + “Global earthing” = connecting of all metallic parts together
- Discharging of persons when entering the base
- Main Busbar: In = 250A
- Photovoltaic: BIPV: 17.78kWp – SAPV: 44.94kWp => 58MWh
- Wind: 9 x 6kWp: 54kWp => 140MWh
- Batteries: 48V - 8000Ah C10
- Gensets: 2 x 40kVA @  $\cos \varphi 0.81$  => 6.5MWh /2200l of fuel
- Variable loads: installed power of +400kVA
- Insuring stability of the micro-grid: Sunny Island (SMA) 3 x (3 x 5kW) @ 25 C

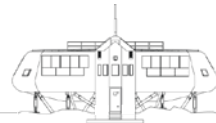

# Micro-grid P load > 3 x Pproduction

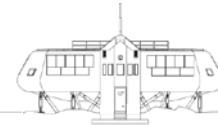
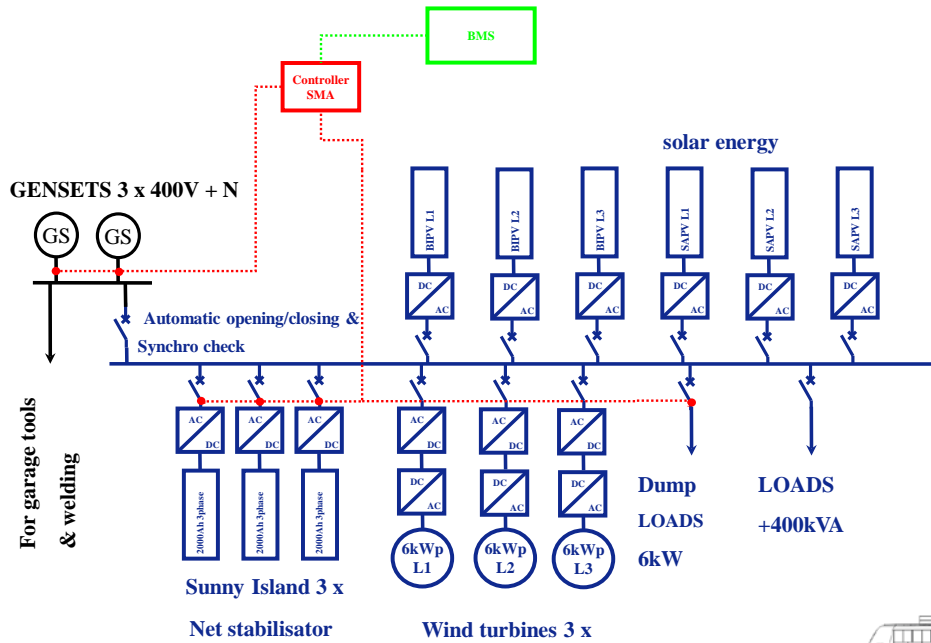

# Smart-grid P load > 10 x Pproduction

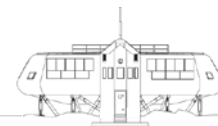
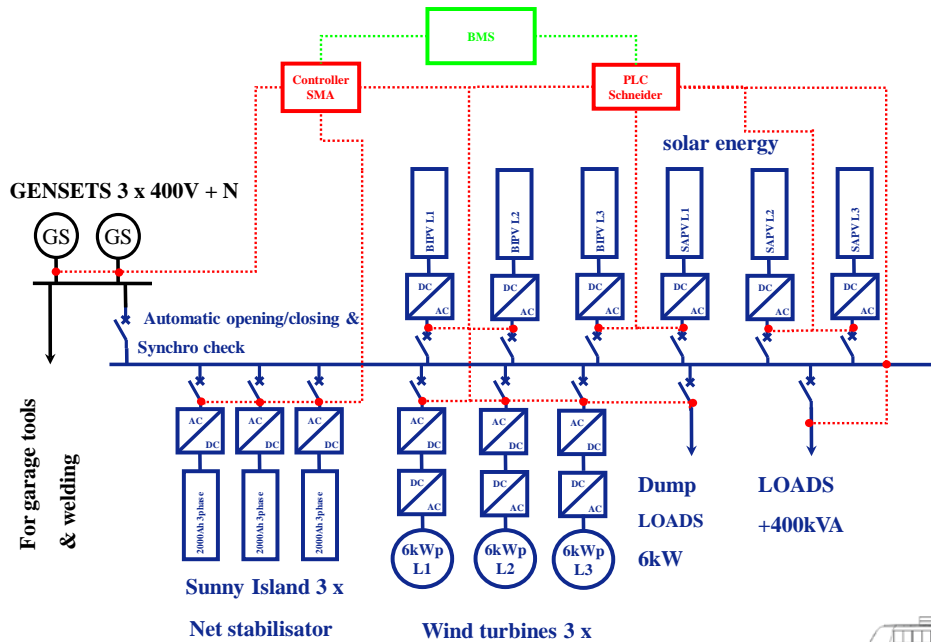



# Integration challenge

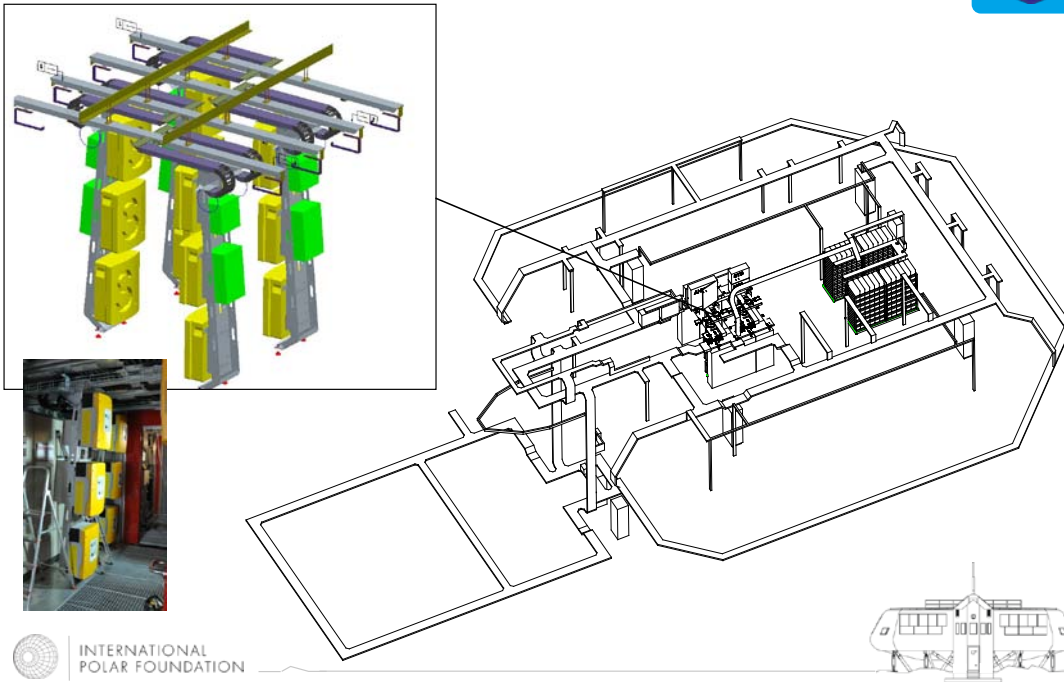

INTERNATIONAL POLAR FOUNDATION

# WTU

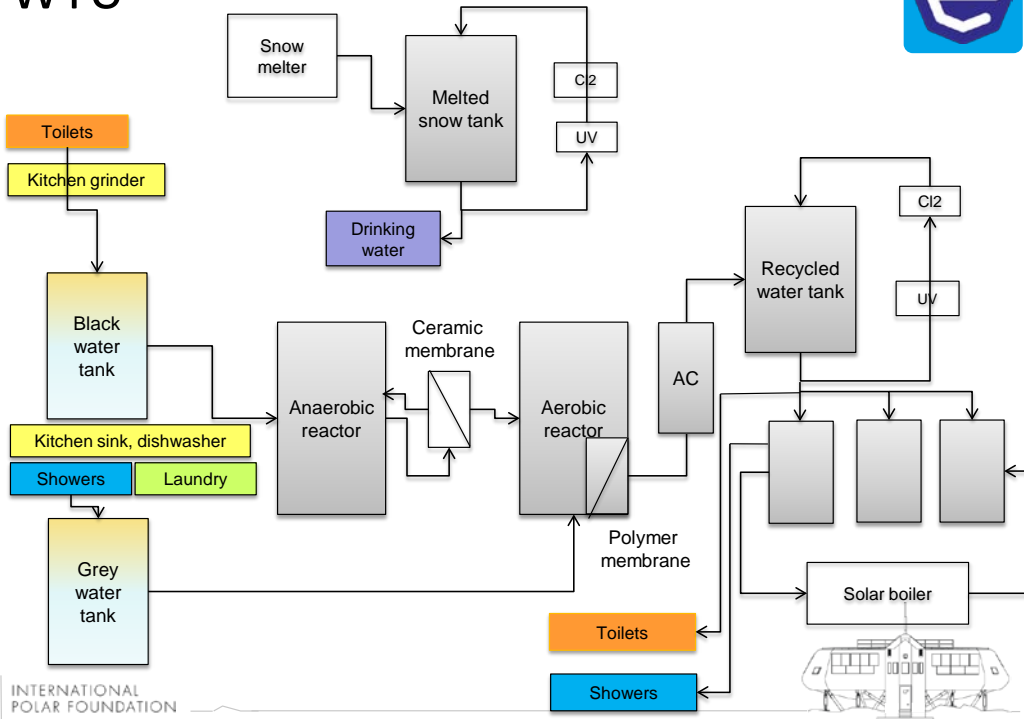

INTERNATIONAL POLAR FOUNDATION

# WTU



- Anaerobic & aerobic reactors

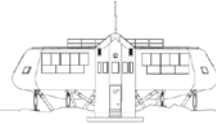

# WTU

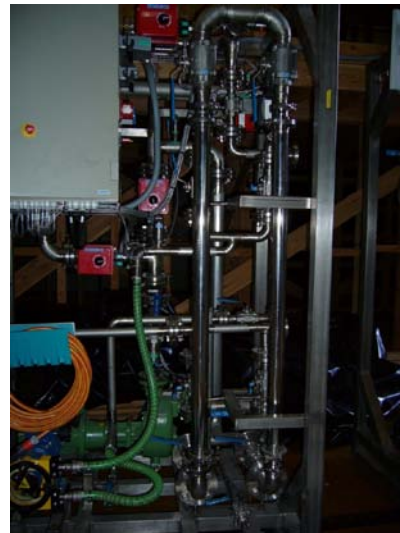

- Activated carbon column and cleaning devices

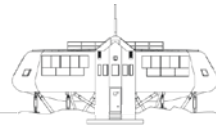

# WWB

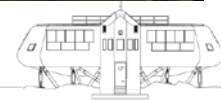
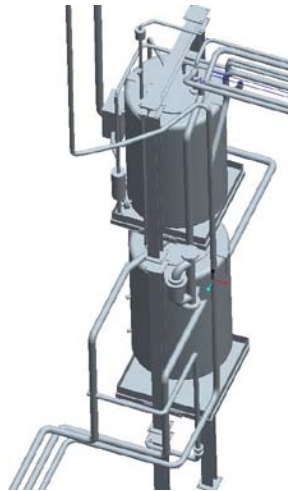
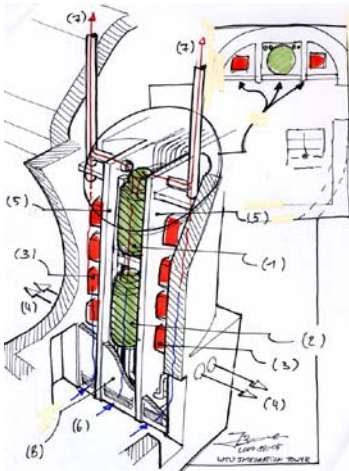

# STS-S2 & SMU

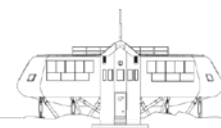
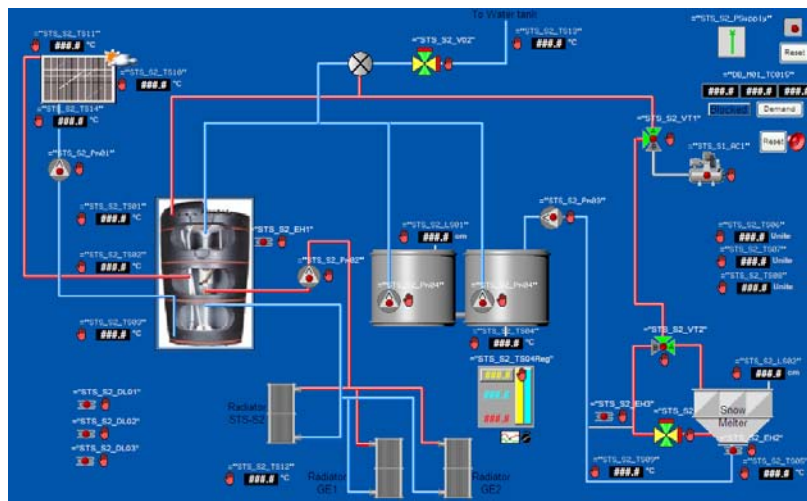

## BELARE 2008/9 Preparations

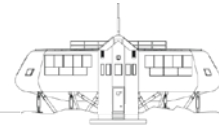

## BELARE (BELgian Antarctic Research Expeditions)



### BELARE 2004/5: Site Survey expedition

- Selection of a construction site

### BELARE 2005/6: Logistic Survey Expedition

- Safe access routes

### BELARE 2006/7: Site Preparation Expedition

- Shipment heavy equipment

### BELARE 2007/8: Construction Phase 1 Expedition

- Construction of buildings

### BELARE 2008/9: Construction Phase 2 Expedition

- Active systems
- Start operational life of the Station

### BELARE 2009/10: Construction SATCOM

- Satellite communications
- Science

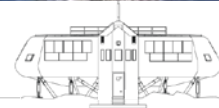

## BELARE 2004/5 : Building site



INTERNATIONAL  
POLAR FOUNDATION



37

## BELARE 2004/5 : Building site



Novolazarevskaya blue ice  
runway

38

# Queen Maud Land, Sør Rondane Mts

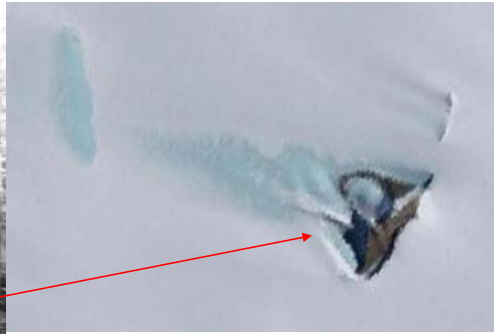
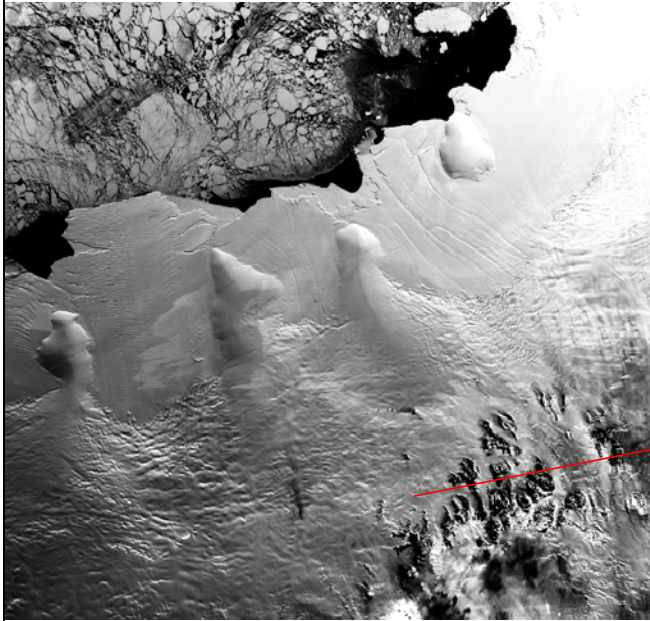

INTERNATIONAL POLAR FOUNDATION

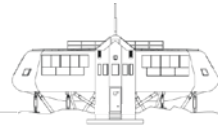

39

# BELARE 2004/5 : Building site



Gunestadbreen December 2004

40

# BELARE 2004/5 : Building site

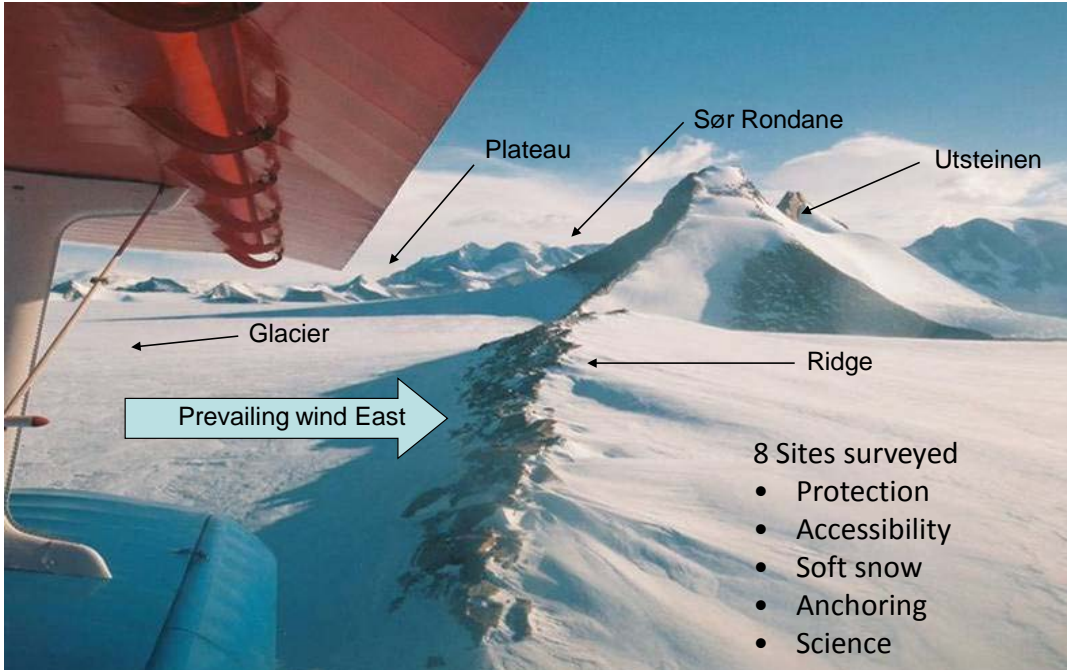

41

# BELARE 2004/5 Building site

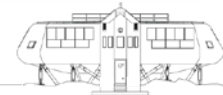
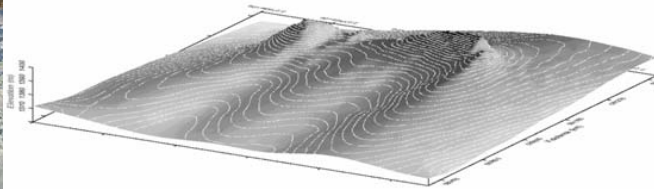
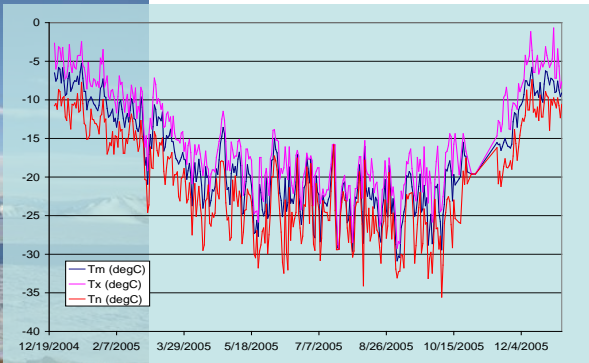
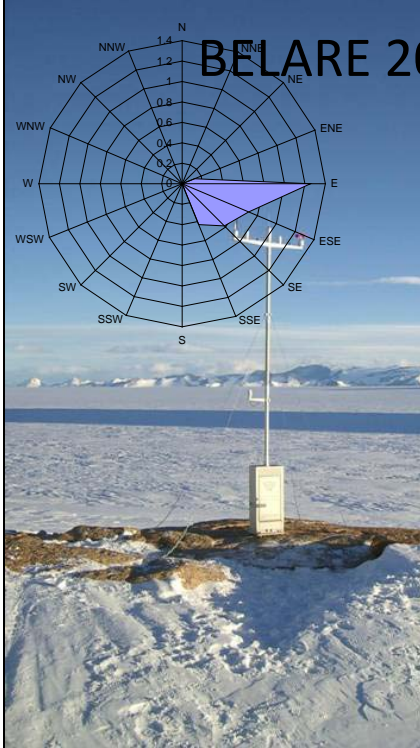

42

# BELARE 2005/6 : logistics



Breid Bay December 2005

# BELARE 2005/6 : logistics

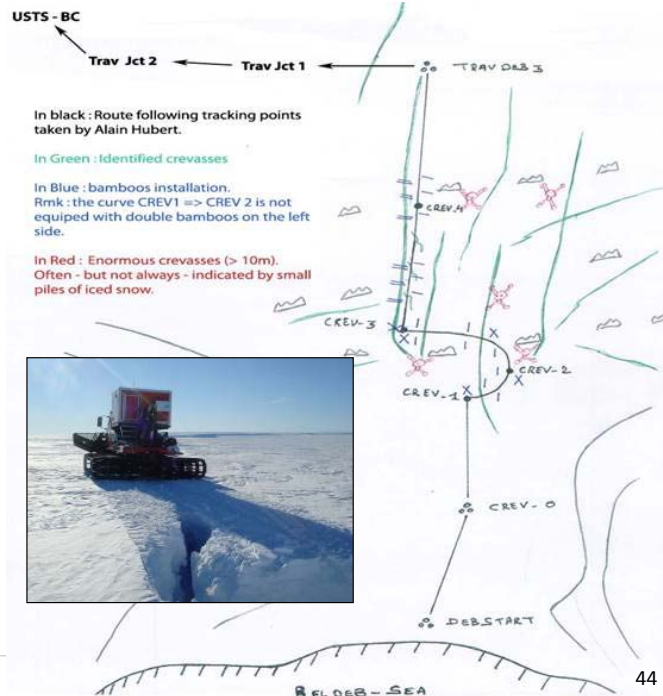



## BELARE 2006/7: general repetition

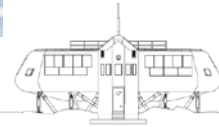

## BELARE 2006/7: ship unloading

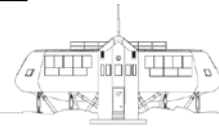

## BELARE 2006/7: overland traverse



## BELARE 2006/7: testing



- First ship unloading (200T)
- Vehicles, fuel, supplies
- Validation logistic chain
- Anchoring & position building
- Wind turbine test (9 x 6 kW)

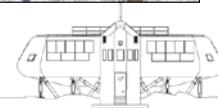

# BELARE 2007/8: Unloading site



INTERNATIONAL POLAR FOUNDATION

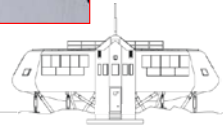

49

# BELARE 2007/8: Unloading site

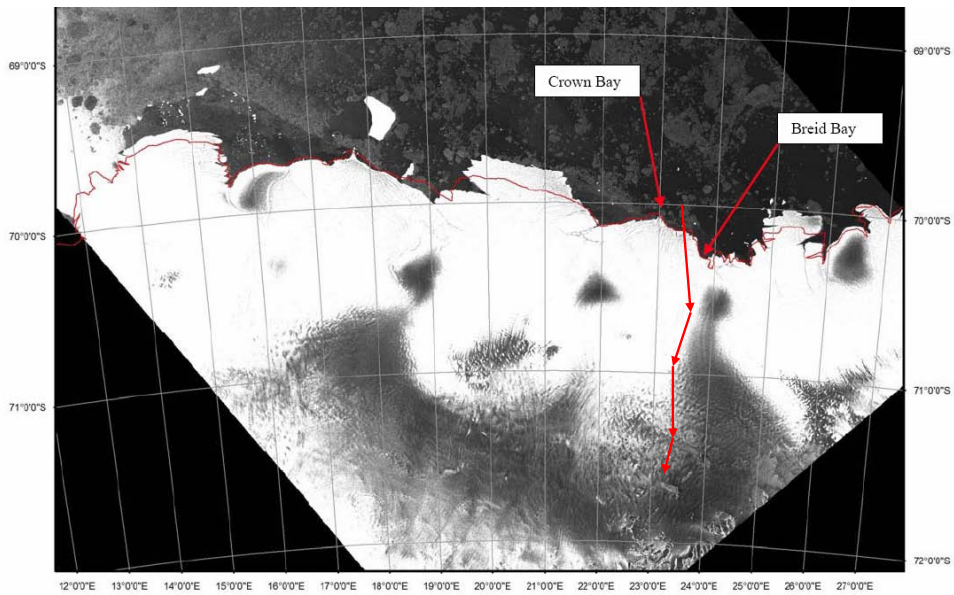

INTERNATIONAL POLAR FOUNDATION

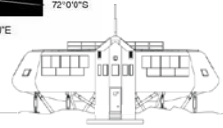

50

# BELARE 2007/8



INTERNATIONAL POLAR FOUNDATION

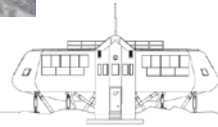

51

# Unloading on sea ice



INTERNATIONAL POLAR FOUNDATION

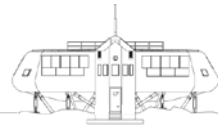

52

## Coast depot

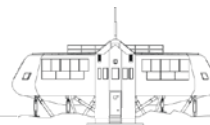

## Traverses: GPS guidance

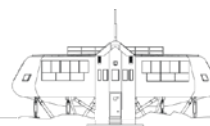
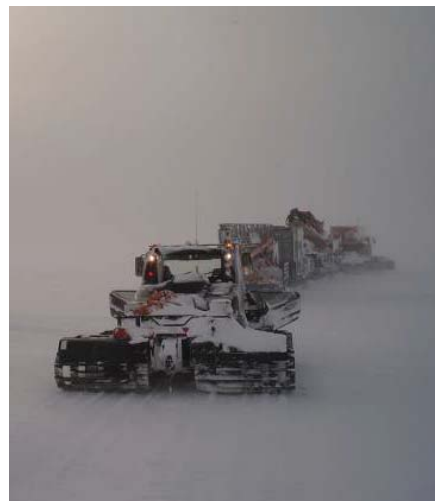

# Anchoring

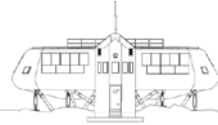

# Wood structure

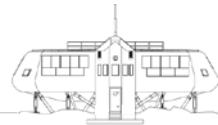

# Frame

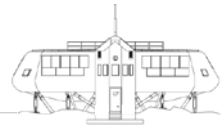
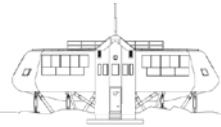

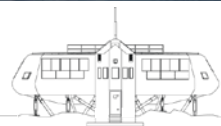
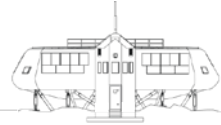





 INTERNATIONAL  
POLAR FOUNDATION

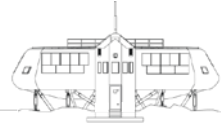

61



 INTERNATIONAL  
POLAR FOUNDATION

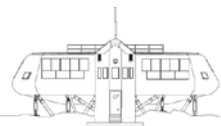

62

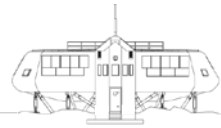
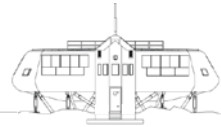

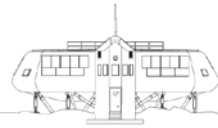
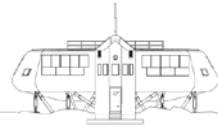

2008/9 Target:

Active systems  
Interior finishing  
Startup

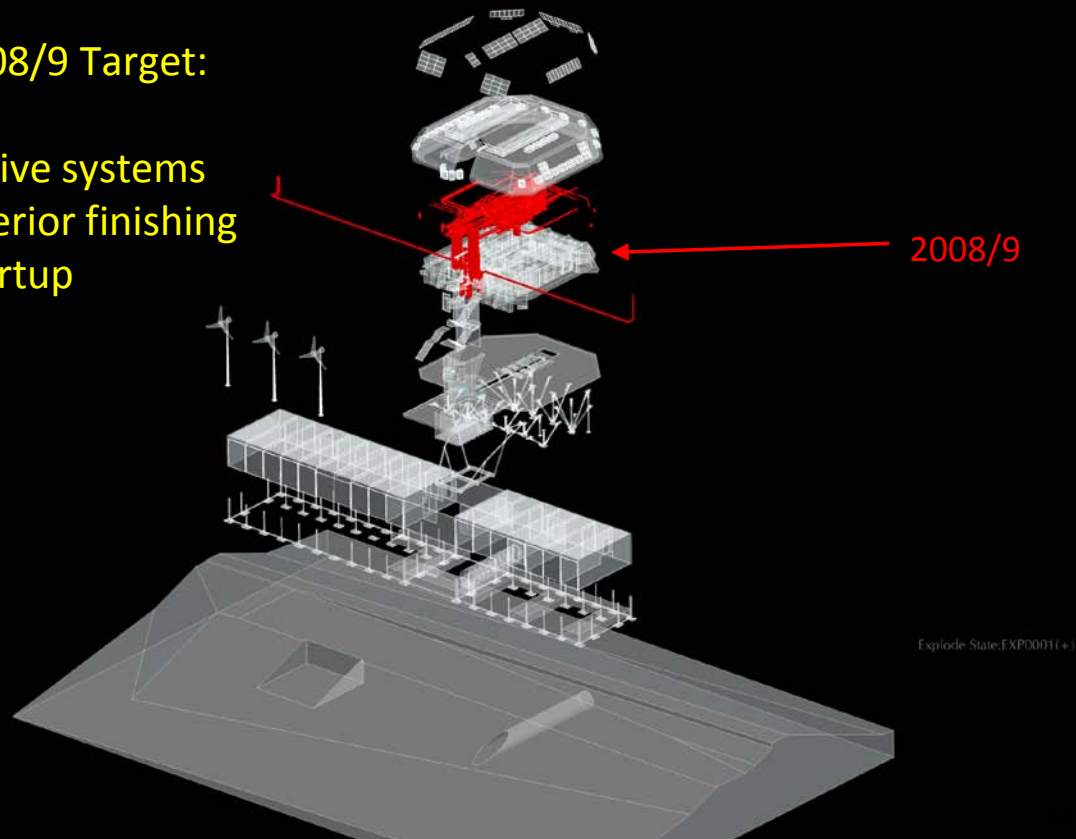

## Science Belare 2008/9



**BELATMOS (RMI)** => BELgian monitoring of ozone and related trace gases, UV radiation, and aerosol particles in support of ATMOSpheric chemistry and climate research

**GIANT (ROB)** => Geodesy for Ice in ANTArctica (Evaluation of the ice mass around the Belgium station in Antarctica using GPS and Absolute Gravity observations)

**LISSA (ROB)** => Lithospheric and Intraplate Structure and Seismicity in Antarctica

**BELISSIMA (ULB)** => Belgian Ice-Sheet Shelf-Ice Measurements in Antarctica

**BELDIVA (ULG)** => Belgian Microbial Diversity Project in Antarctica

**HYDRDRANT (KUL)** => Atmospheric branch of the HYDRological cycle in ANTArctica

**NIPR NARE 51** => Logistic support

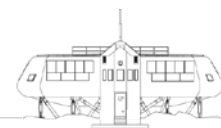

# BELARE 2008/9



INTERNATIONAL  
POLAR FOUNDATION

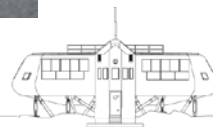

69



INTERNATIONAL  
POLAR FOUNDATION

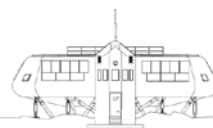

70

# Utsteinen Base Camp: organisation

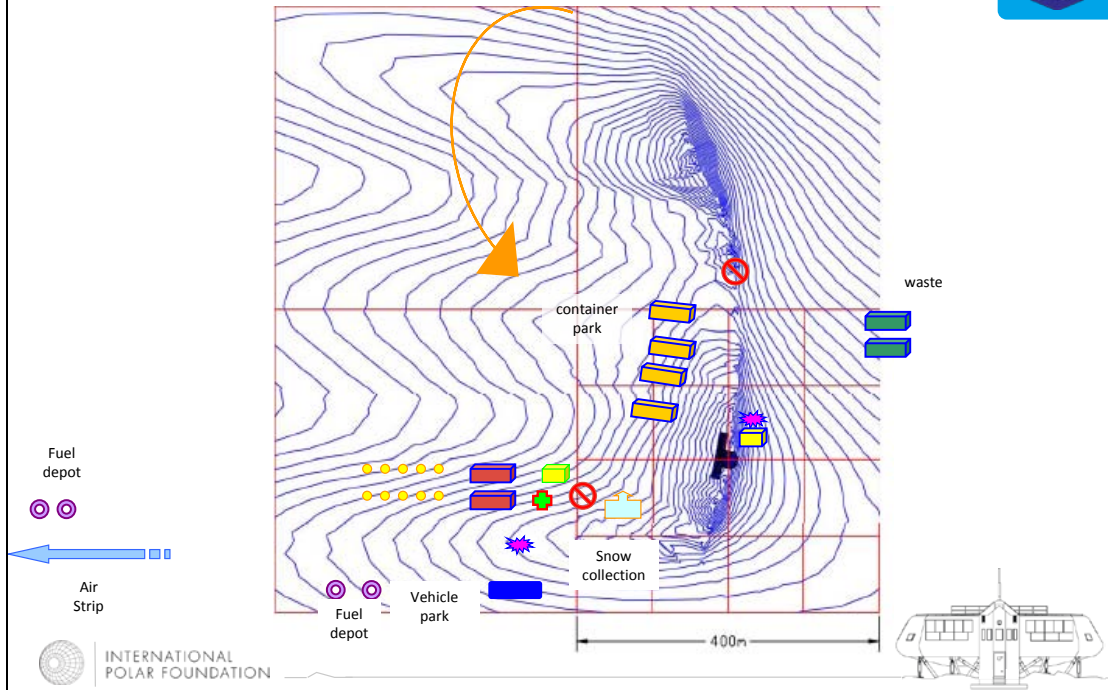

71



INTERNATIONAL POLAR FOUNDATION

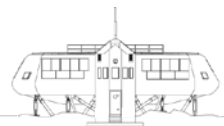

72

## Sleeping quarters

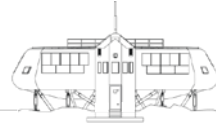

## Mess: feeding up to 34 people

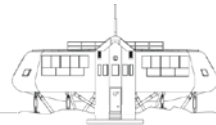

## Active systems integration

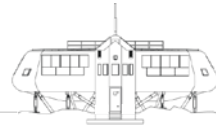
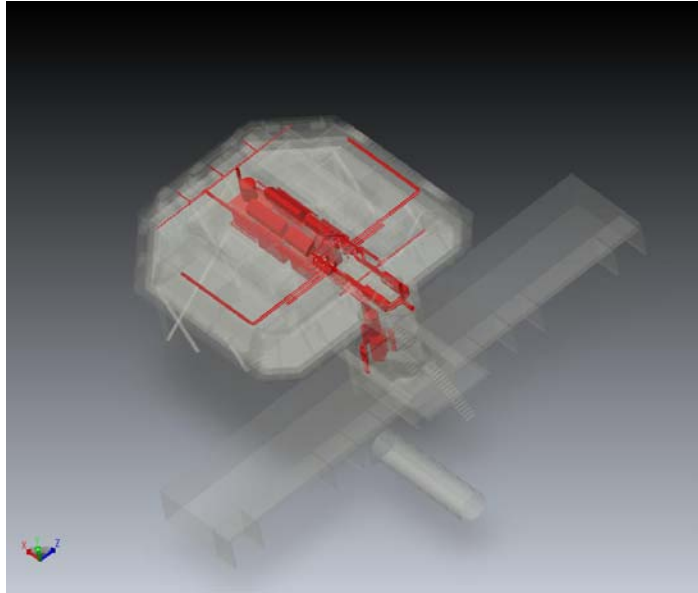

## WTU



- Aerobic reactor and cleaning unit on site

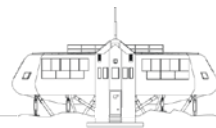



# WSU



INTERNATIONAL POLAR FOUNDATION

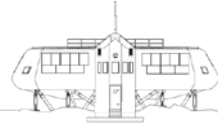

77

# STS-S1



INTERNATIONAL POLAR FOUNDATION

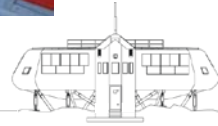

78

# STS-S1

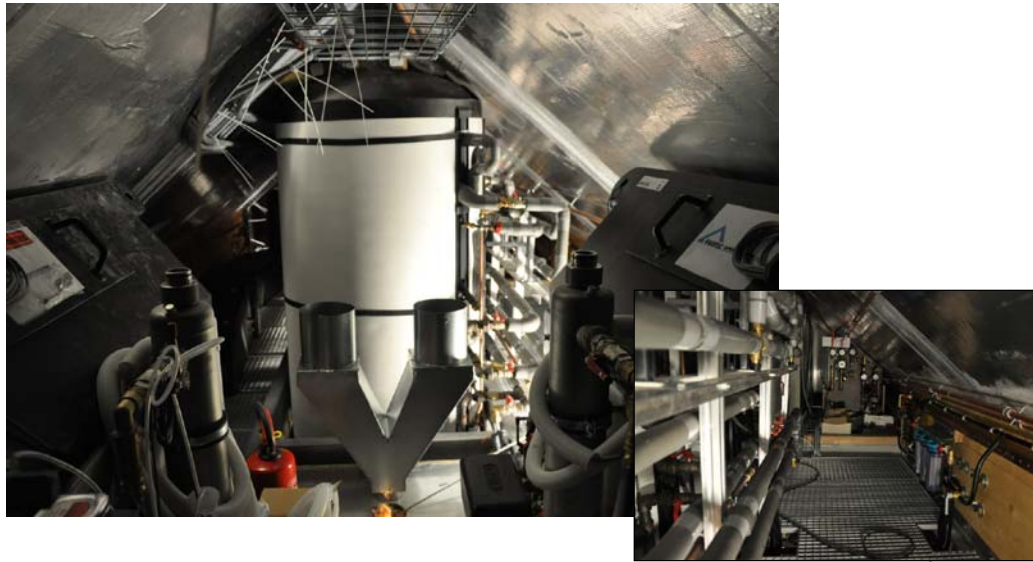

INTERNATIONAL POLAR FOUNDATION

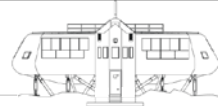

79



INTERNATIONAL POLAR FOUNDATION

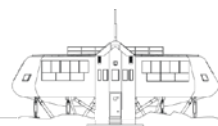

80

# HVAC



INTERNATIONAL POLAR FOUNDATION

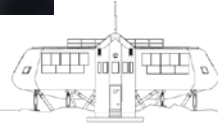

81

# EMC



INTERNATIONAL POLAR FOUNDATION

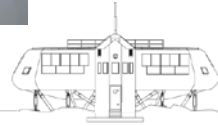

82

# BELARE 2008/9



INTERNATIONAL POLAR FOUNDATION

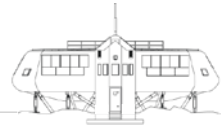

83

# BI-PV



INTERNATIONAL POLAR FOUNDATION

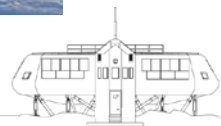

84

# SA-PV

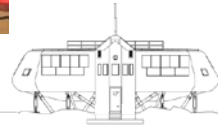
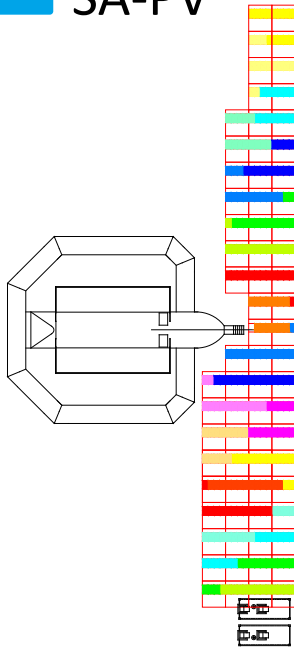

# Wind Turbines

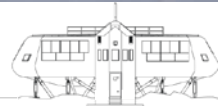

# Wind Turbines



## Technical Specification Sheet

<b>MODEL</b>	Proven 6 (6kW)
Cut In (mph)	25
Cut Out (mph)	None
Survival (mph)	70
Rated (mph)	12
Rotor Type	Downwind, Self Regulating
No. of Blades	3
Blade Material	Glassfibre/epoxy Composite
Rotor Diameter(m)	5.5
Generator Type	Brushless, Direct Drive, Permanent Magnet, 48V DC
Battery charging	Grid connect with Windy Bay Inverter
Direct Heating	230Vac 50Hz or 240 Vac 60Hz ac
Rated RPM	300
Annual Output	6,000-12,000 kWh
Hub Weight (kg)	600
Mast Type	Tilt up, tapered, self-supporting, no guy wires (tilar goned towers also available on request)
Hub Height (m)	9 or 15
WT Found (m)	2.5x2.5x1 or 3x3x1.2
Tower Weight (kg)	160 or 654
Mechanical Brake	Yes
Noise @ 20m	45 dBA
Noise @ 20m	65 dBA
Rotor Thrust (kN)	10
Sample of commercial customers	British Telecom Scottish Health Board Association Brexit Rail Irish Lighthouse Authority UK Lighthouse Authority Tireobha Orange Shell Exploration Suez Aramco

**Proven Patented Furling**  
In winds of above 12m/s or 25mph, the Proven's blades twist to limit power in response to high rpm

**Low Speed Equals Durability**

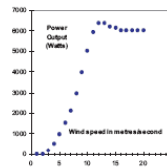

**Marine Build Quality**  
All machines are manufactured with galvanised steel, stainless steel & plastic components

1. metres/second = 2.24 miles per hour x 0.447
2. Output graph is typical for the tower height range wind speeds (normally) higher wind sites will produce 40% more output power lower sites of single higher wind speed sites e.g. 40% more output power at 15m tower height
3. All machines have an ACP 20-25 dBA meter at the base of the tower at a height of 20m.
4. A 6m spacing 20m away @ approx 40 mph is 70dB(A)

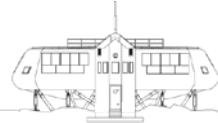

# Ice

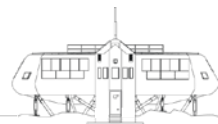

## Snow

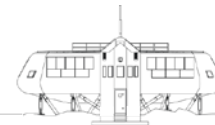
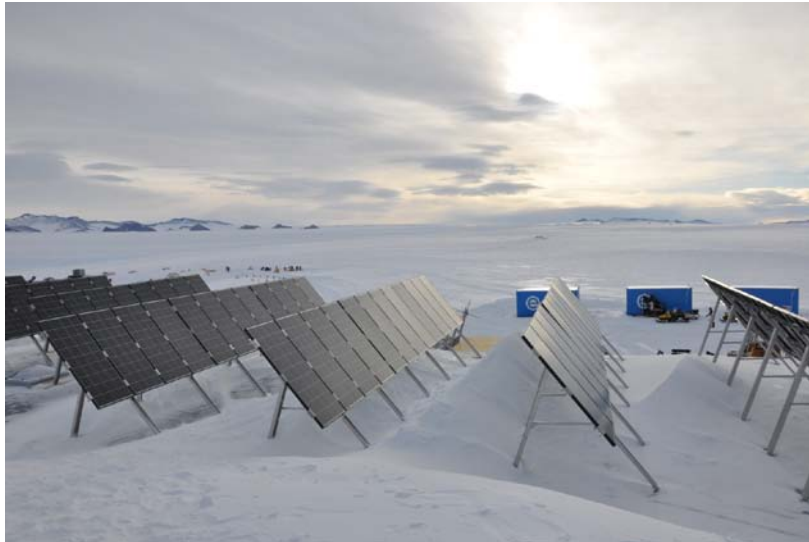

## Expedition related research



- Circadian rhythms, physical activity and their influence on sleep-wake regulation during an Antarctic summer expedition
- Dept of Behavioral Sciences - Royal Military Academy

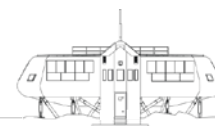

## Summary of results



- Sleep
  - Non restorative sleep, high sleep fragmentation
  - Inversion in sleep architecture between light sleep and REM sleep
- Circadian desynchronisation by constant illumination?
  - Cortisol rhythms maintained: Behavioural cues sufficiently able to entrain?
  - Melatonin rhythms phase delayed (peaks in the early morning): accounts for the sleep disturbance?
- Link between sleep efficiency and physical activity
- Mood and vigilance
  - No mood disturbance, no effects of stress (POMS & cortisol)
  - Highly disrupted PVT (attention performance similar to subjects being sleep-deprived for 5 consecutive days).
- Potential countermeasures to be investigated: melatonin supplementation and exercise regimen => follow-up experiment.

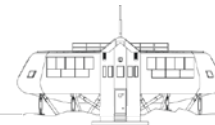

## Outside facilities

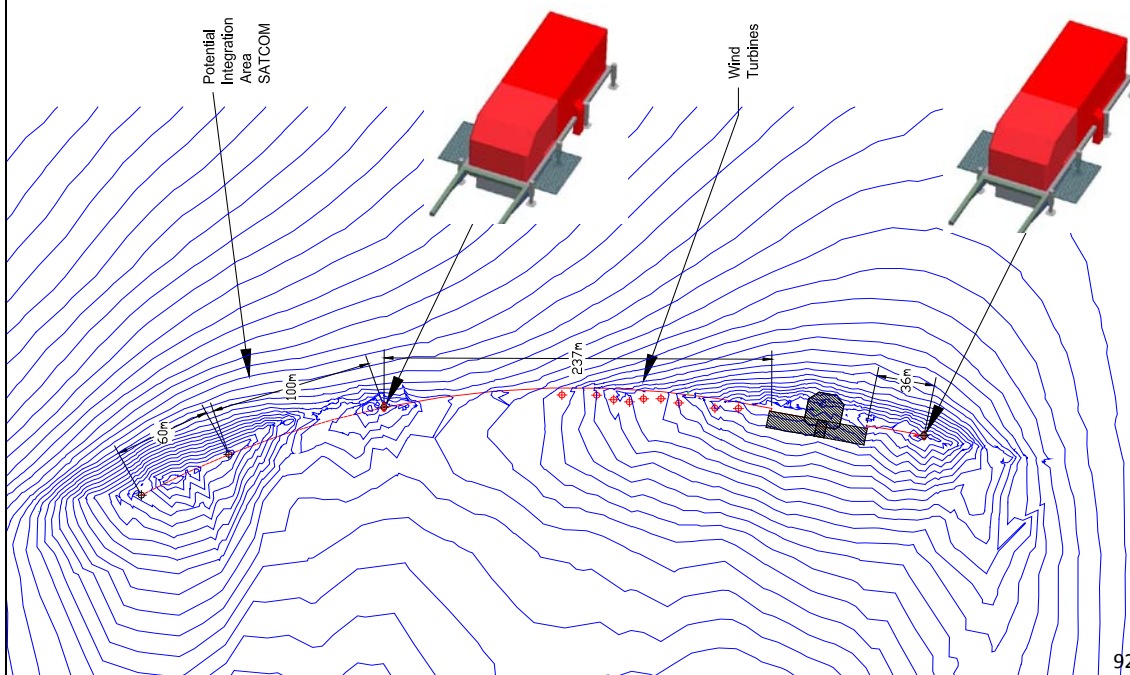



# SATCOM

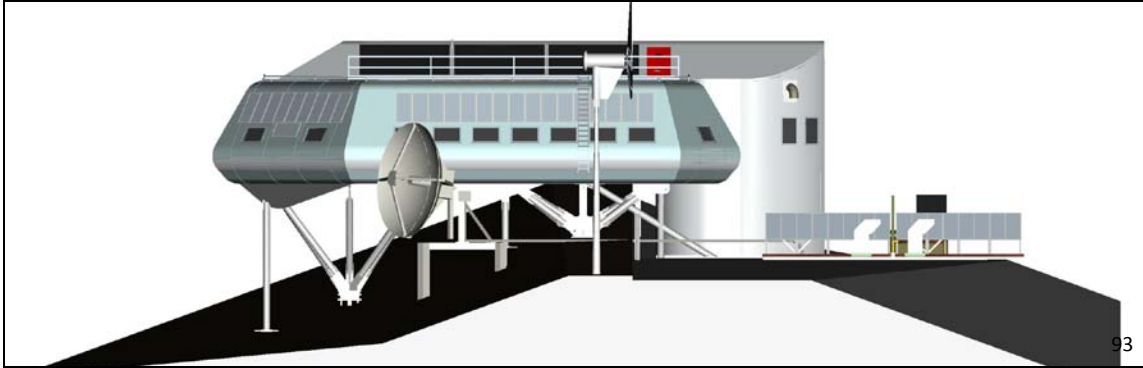
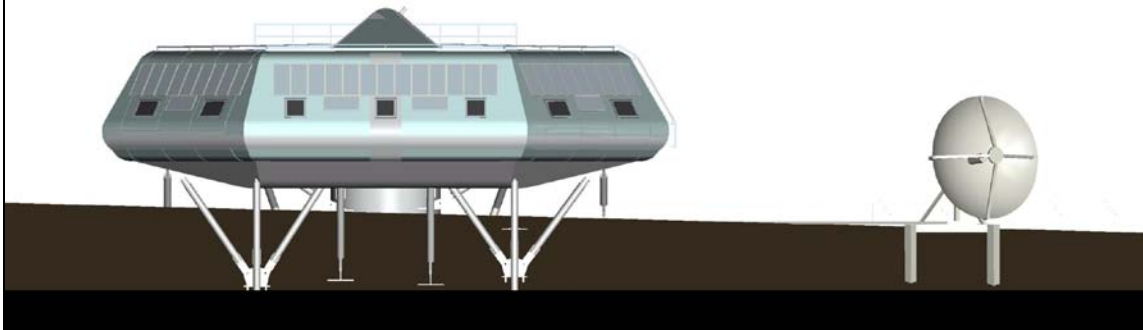

# UAV – instrumentation platform

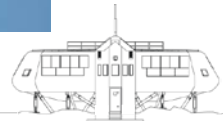
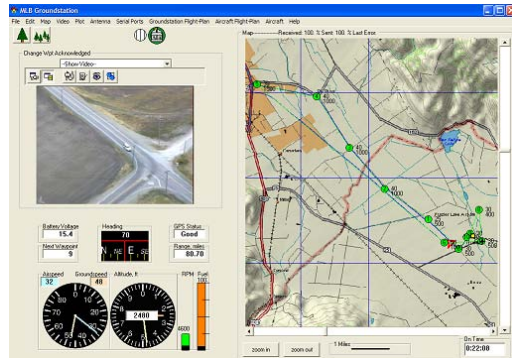



INTERNATIONAL  
POLAR FOUNDATION

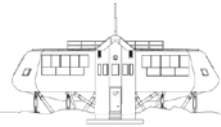

95

## **APPENDIX B: VEHICLES**

This appendix contains a further description of the vehicles used by the speakers in the Antarctic.

## Berco TL-6

Manufacturer: Berco Produktion AB, Skellefteå, Sweden

Description: The TL-6 is a dual car configuration; a forward car with either a 2- or 4-door cab and a rear car for cargo. The TL-6 can be outfitted with a number of different accessories and additions (e.g., power take off; winch; crane; loadchanger; platforms; cabin for passenger transport; fuel and water tanks; skylift; snowblade).



TL-6 used on the US-Norwegian Traverse during the IPY. (Source: Mary Albert).

### Characteristics of the Berco TL-6 (4 door cab)

Engine	Cummins B 5.9 ECHO, 6-cyl in-line, 250hp
Transmission	Automatic
Fuel capacity	245 l (65 gal)
Fuel consumption (S2)	3.5 l/km (with 25 t sled)
Load capacity	4,220 kg (9,300 lb)
Trailer capacity (S2)	> 25 t
Overall width	2.2 m (86.6 in)
Overall length	8 m (315 in)
Overall height	2.64 m (104 in)
Weight	6,780 kg (14,950 lb)
Pontoon and track	4 tracks 0.62 m (24.4 in) width Moulded rubber with cord
Turning radius	14 m (46 ft)
Speed	40 km/h (25 mph) in Antarctica run at 1800 RPM: 13 km/hr (8 mph)
Nominal ground pressure	18 kPa

Source: (unless otherwise noted above, data is from S1)

S1: Product Sheets at [www.berco.nu](http://www.berco.nu)

S2: [http://fimbul.npolar.no/en/nare0910/expedition-diary/entries/28\\_november.html](http://fimbul.npolar.no/en/nare0910/expedition-diary/entries/28_november.html)

## Prinoth Everest Power Antarctic

Manufacturer: Prinoth

Description: Based on the Prinoth Everest Power and modified for the Antarctic; an additional sleeping compartment, special insulation, an extremely powerful heating system, a custom made towing hook, a satellite telephone, steel tracks and is designed with the colors of the Norwegian flag.



Prinoth Everest Power Antarctic preparing to transport a cargo container in support of the construction of the Princess Elisabeth Station. (Source: Johan Berte)

### Characteristics of the Prinoth Everest Power (Antarctic version will vary somewhat from this).

Engine	Mercedes OM 501 LA
Transmission	Final drive hydrostatic pumps 180 cm <sup>3</sup> Bosch Rexroth
Fuel capacity	290 l
Fuel consumption	20 l/h
Load capacity	~3,000 kg
Trailer capacity	>20 mt
Overall width	4.26 m with blade: 5.58 m
Overall length	5.50 m with blade and hitch 6.80 m
Overall height	2.94 m
Weight	9,670 kg
Pontoon and track	
Turning radius	Turns on own axis
Speed	24 km/h
Nominal ground pressure	

Source:

Product information on [www.prinoth.com](http://www.prinoth.com).

## Sno-Cat Model 743

Manufacturer: Tucker Corporation, Medford, Oregon

Description: Enclosed 15-passenger carrier running on 4 ladder-tracked pontoons. Outstanding in soft snow. Climbs extremely well and conforms to terrain irregularities easily.



Two Sno-Cat Model 743s as used during the IGY. (Source: Charles Bentley)

### Characteristics of the Sno-Cat Model 743 and 743-A

	743	743-A
Engine	180-335 hp Chrysler VS	180-335 hp Chrysler VS
Transmission	3 & 1	5 & 1
Fuel capacity	50 gal	50 gal
Fuel consumption	3 - 5 mpg	3 - 4 mpg
Load capacity	2300 lb	2750 lb
Trailer capacity	6000 lb	7500 lb
Overall width	7 ft 5 in.	7 ft 5 in.
Overall length	20 ft	20 ft
Overall height	7 ft 9 in.	7 ft 9 in.
Weight	7200 lb	7400 lb
Pontoon and track	24 x 103 in.	24 x 103 in.
Turning radius	38 ft	38 ft
Speed	18 mph	18 mph
Nominal ground pressure (S2)	0. 71 psi (no load)	0. 71 psi (no load)

Flat-deck freighters are available, the 742 standard model and the 742-A heavy duty model. These have 3-passenger driving cabs, the load capacities are the same as the 743 series, and the trailer capacities are 7500 for both models. Both have 5 & 1 transmissions and the vehicle weights are 7100 and 7300 lb, respectively

Source:

S1: MELLOR, M. 1963. *Oversnow transport. US Army Cold Regions Research and Engineering Laboratory. Monograph, M III-A4*

S2: Fuchs, V.E. 1963. *Some Aspects of Tractor Performance in Symposium on Antarctic Logistics. National Academy of Sciences.*

## Sno-Cat Model 843 Antarctic

Manufacturer: Tucker Corporation,  
Medford, Oregon

Description: Special vehicle for long-distance scientific traverses in Antarctica. Large box body mounted on Sno-Cat pontoons, and fitted out for sleeping and for scientific work. Considerable towing capacity (up to 15,000 lb drawbar pull) permits fuel and supplies to be hauled in sleds, trailers, and rolling liquid transporters.



Sno-Cat Model 843 as used on the Queen Maud Land Traverses (1964-1968). (Source: Richard Cameron)

### Characteristics of the Sno-Cat Model 843 Antarctic

Engine	Cummins 6-cylinder diesel, 175 hp at 2,500 rpm (turbocharged)
Transmission	5 & 1
Fuel capacity	80 gal
Fuel consumption	(S2) 0.75 mpg loaded
Load capacity	6,000 lb
Trailer capacity	15,000 lb
Overall width	9 ft 5 in
Overall length	25 ft 0 in
Overall height	10 ft 10 in
Weight	21,000 lb
Pontoon and track	4 pontoons each 32 in. x 125 in. overall
Turning radius	44 ft
Speed	10 mph cruise 17 mph maximum
Nominal ground pressure	1.4 psi (light) 2.1 psi (fully laden)

Source:

S1: MELLOR, M. 1963. *Oversnow transport. US Army Cold Regions Research and Engineering Laboratory. Monograph, M III-A4*

S2: *Milwaukee Journal*, 27 January 1963,

## Weasel Amphibious Cargo Carrier (M29C)

Manufacturer: Studebaker

Description: General purpose amphibious tractor. Used for personnel and light freight carrying and for light sled haulage. (There is a non-amphibious version designated M29.) An outstanding vehicle that was the mainstay of oversnow transportation for many Western countries (1940s-1950s).



Weasel used during the Norwegian-British-Swedish Antarctic Expedition (1949-1952). (Source: Charles Swithinbank)

### Characteristics of the Weasel

Engine	Studebaker Champion 6-cylinder, 65 hp
Transmission	3 & 1 gearbox 2 axle ratios
Fuel capacity	35 gal
Fuel consumption	5 mpg
Load capacity	1200 lb (in standard ordnance condition)
Trailer capacity	3800 lb
Overall width	67 in
Overall length	192 in
Overall height	71 in with ordnance canopy
Weight	4800 lb (heavier with built-on cabin)
Pontoon and track	Steel track plates with flexible connectors and endless rubber bands. Vehicle weight carried on 32 bogey wheels. Track width: 15 in. (M29), 20 in. (M29C)
Turning radius	12 ft
Speed	36 mph (max.)
Nominal ground pressure	1.9 psi (light)

Source:

MELLOR, M. 1963. *Oversnow transport. US Army Cold Regions Research and Engineering Laboratory. Monograph, M III-A4*



## APPENDIX C: LIST OF PARTICIPANTS

Mary Albert	Dartmouth College
Troy Ames	NASA Goddard Space Flight Center
Dale Andersen	Carl Sagan Center
Alida Andrews	SAIC
Charles Bentley	University of Wisconsin
Johan Berte	International Polar Foundation
Karin Blank	NASA Goddard Space Flight Center
Jacob Bleacher	NASA Goddard Space Flight Center
Jesse Buffington	NASA Johnson Space Center
Andy Cameron	Intelligent Land Management
Richard Cameron	retired National Science Foundation
Doug Craig	NASA Headquarters
Chris Culbert	NASA Johnson Space Center
Bret Drake	NASA Johnson Space Center
Dean Eppler	SAIC
Sam Feola	Raytheon Polar Services Company
Chris Gerty	NASA Johnson Space Center
John Gruener	NASA Johnson Space Center
Jennifer Heldmann	NASA Headquarters
Steve Hoffman	SAIC
Fred Horz	retired NASA Johnson Space Center
Tim Kennedy	NASA Johnson Space Center
Joe Kosmo	NASA Johnson Space Center
David Kring	Lunar and Planetary Institute
Rob Landis	NASA Johnson Space Center
Ruthan Lewis	NASA Headquarters
Gary Lofgren	NASA Johnson Space Center
Mark Lupisella	NASA Goddard Space Flight Center
Natalie Mary	Booz Allen Hamilton (Houston/JSC)
Wendell Mendell	NASA Johnson Space Center
Kate Mitchell	NASA Johnson Space Center
Rob Mueller	NASA Kennedy Space Center
Liam Pedersen	NASA Ames Research Center
Don Petit	NASA Johnson Space Center
John Phillips	NASA Johnson Space Center
Pat Rawlings	SAIC
Jim Rice	Arizona State University
Barbara Romig	NASA Johnson Space Center
Amy Ross	NASA Johnson Space Center
Cal Seaman	NASA Johnson Space Center
Gary Spexarth	NASA Johnson Space Center
Charles Swithinbank	Scott Polar Research Institute
Karen Thompson	NASA Kennedy Space Center
Paul Thur	Raytheon Polar Services Company
Larry Toups	NASA Johnson Space Center
Terry Tri	NASA Johnson Space Center
Stephen Voels	SAIC

Brian Wilcox  
Julie Williams-Byrd  
Marie-Claude Williamson

Jet Propulsion Laboratory  
NASA Langley Research Center  
Canadian Space Agency



REPORT DOCUMENTATION PAGE			Form Approved OMB No. 0704-0188	
Public reporting burden for this collection of information is estimated to average 1 hour per response, including the time for reviewing instructions, searching existing data sources, gathering and maintaining the data needed, and completing and reviewing the collection of information. Send comments regarding this burden estimate or any other aspect of this collection of information, including suggestions for reducing this burden, to Washington Headquarters Services, Directorate for Information Operations and Reports, 1215 Jefferson Davis Highway, Suite 1204, Arlington, VA 22202-4302, and to the Office of Management and Budget, Paperwork Reduction Project (0704-0188), Washington, DC 20503.				
1. AGENCY USE ONLY (Leave Blank)	2. REPORT DATE February 2012	3. REPORT TYPE AND DATES COVERED NASA Conference Publication		
4. TITLE AND SUBTITLE Antarctic Exploration Parallels for Future Human Planetary Exploration: The Role and Utility of Long Range, Long Duration Traverses			5. FUNDING NUMBERS	
6. AUTHOR(S) Stephen J. Hoffman; Stephen A. Voels				
7. PERFORMING ORGANIZATION NAME(S) AND ADDRESS(ES) Lyndon B. Johnson Space Center Houston, Texas 77058			8. PERFORMING ORGANIZATION REPORT NUMBERS S-1117	
9. SPONSORING/MONITORING AGENCY NAME(S) AND ADDRESS(ES) National Aeronautics and Space Administration Washington, DC 20546-0001			10. SPONSORING/MONITORING AGENCY REPORT NUMBER CP-2012-217355	
11. SUPPLEMENTARY NOTES				
12a. DISTRIBUTION/AVAILABILITY STATEMENT Available from the NASA Center for AeroSpace Information (CASI) 7121 Standard Hanover, MD 21076-1320 Category: 91			12b. DISTRIBUTION CODE	
13. ABSTRACT (Maximum 200 words) This report describes a 2-day workshop at the NASA Johnson Space Center discussing lessons learned from traverses in the Earth's polar regions. Results from this and a previous workshop both indicate highly parallel activities and functional needs. It was also recognized that NASA's current approach for long-duration planetary surface operations has fundamental differences from any of the operational approaches described by the invited speakers. This workshop arranged for a direct interaction between those who created the history of Arctic and Antarctic traverses with those who are tasked with creating the future history of these traverses on other planets.  This report documents the presentations and discusses key findings or lessons. The presentations – visual materials and associated transcripts – are contained in appendices. These appendices are considered the principal knowledge captured during the workshop; the sections that precede these appendices provide background and context for the appendices and capture a summary of the discussions by attendees representing six different NASA Centers and several contractors or universities. A general recommendation is that interaction between the two exploration communities sides (i.e., the polar traverse community and the planetary surface traverse community) should continue with both informal and more formalized events.				
14. SUBJECT TERMS space exploration; planetary environments; planetary surfaces; long duration space flight; Arctic regions; Antarctic regions			15. NUMBER OF PAGES 318	16. PRICE CODE
17. SECURITY CLASSIFICATION OF REPORT Unclassified	18. SECURITY CLASSIFICATION OF THIS PAGE Unclassified	19. SECURITY CLASSIFICATION OF ABSTRACT Unclassified	20. LIMITATION OF ABSTRACT Unlimited	



---