

MODELING DELAMINATION IN POSTBUCKLED COMPOSITE STRUCTURES UNDER STATIC AND FATIGUE LOADS

Chiara Bisagni¹, Pietro Brambilla², Carlos G. Dávila³

¹Politecnico di Milano, Dep. of Aerospace Engineering, Via La Masa 34, 20156 Milano, Italy
currently at University of California San Diego, Dep. of Structural Engineering,
9500 Gilman Drive, La Jolla, CA, USA

²Politecnico di Milano, Dep. of Aerospace Engineering, Via La Masa 34, 20156 Milano, Italy

³NASA Langley Research Center, Structural Mechanics and Concepts Branch, Hampton,
Virginia 23681, USA

ABSTRACT

The ability of the Abaqus progressive Virtual Crack Closure Technique (VCCT) to model delamination in composite structures was investigated for static, postbuckling, and fatigue loads. Preliminary evaluations were performed using simple Double Cantilever Beam (DCB) and Mixed-Mode Bending (MMB) specimens. The nodal release sequences that describe the propagation of the delamination front were investigated. The effect of using a sudden or a gradual nodal release was evaluated by considering meshes aligned with the crack front as well as misaligned meshes. Fatigue simulations were then performed using the Direct Cyclic Fatigue (DCF) algorithm. It was found that in specimens such as the DCB, which are characterized by a nearly linear response and a pure fracture mode, the algorithm correctly predicts the Paris Law rate of propagation. However, the Abaqus DCF algorithm does not consider different fatigue propagation laws in different fracture modes. Finally, skin/stiffener debonding was studied in an aircraft fuselage subcomponent in which debonding occurs deep into post-buckling deformation. VCCT was shown to be a robust tool for estimating the onset propagation. However, difficulties were found with the ability of the current implementation of the Abaqus progressive VCCT to predict delamination propagation within structures subjected to postbuckling deformations or fatigue loads.

1. INTRODUCTION

To design a damage tolerant composite structure, it is necessary to have detailed knowledge of the damage and fatigue mechanisms that may cause its collapse. Therefore, the ability to predict crack propagation and fatigue life of a structural component according to the selected fatigue design philosophy is essential. Several studies were conducted in recent years to develop analysis methodologies that can account for the effect of post-buckling deformations on the initiation and propagation of damage [1-3].

Because of weak interlaminar strength, delamination is the most common and critical type of damage in laminated fiber-reinforced composites [4, 5]. Delaminations usually initiate from geometric discontinuities or from pre-existing small defects due to manufacturing defects.

Delamination onset and propagation can be predicted using the principles of linear elastic fracture mechanics, which state that energy needed to create a unit fracture surface is a constant that depends only on the material [5]. This material property, which is designated G_c , is the fracture toughness.

The most commonly used numerical method to calculate the energy release rate G is the virtual crack closure technique (VCCT) [6]. Using the finite element method, the energy release rate can easily be computed from the nodal forces at the crack tip and the displacements at the nodes immediately ahead of the crack tip. If the computed energy release rate G is greater than the fracture toughness of the material at any point along the delamination front, the delamination is assumed to propagate. The method has been shown to be useful to study delamination in specimens as well as complex structures [5, 6]. The major limitation of the VCCT method is that the energy release rate is not normally constant along a delamination front and determining the extent of a delamination is not normally possible without remeshing by trial and error [6].

The VCCT element recently proposed by Mabson et al. [7] represents a major enhancement to the VCCT method. The VCCT element is based on a procedure for the progressive release of nodal forces which allows the prediction of the propagation of delamination fronts along directions that are independent of the underlying finite element mesh. The VCCT element is capable of progressive damage, i.e., it can simulate the initiation of delamination propagation, as well as subsequent stages of delamination.

The Abaqus progressive VCCT method represents another recent evolution of the approach. To alleviate the need of building meshes of unusual VCCT elements, the Abaqus approach uses “contact surfaces” to tie and then progressively release nodal surfaces. In the present work, this Abaqus/Standard VCCT was used to model delamination in composite structures for static, postbuckling, and fatigue loads. In the following sections, the ability of the Abaqus/Standard progressive VCCT method to represent delamination propagation in fatigue will be described and its limitations will be discussed.

2. DELAMINATION UNDER STATIC LOADING

Figure 1 represents three typical specimens used for the material characterization of composite delamination. The specimen commonly used to characterize mode I fracture is the double cantilever beam (DCB), that has been used since the '60s (Figure 1a). Mode II is often characterized using the three-point bend-notched flexure (ENF). The ENF specimen, which has similar dimensions as the DCB specimen, is subjected to three-point bending, as shown in Figure 1b. The mixed-mode bending (MMB) test is typically used to investigate delamination under mixed-mode loading [8]. The test consists of a pre-damaged specimen, hinged at the tips and loaded with a lever arm that acts on the middle and on the tip of the upper arm (Figure 1c). Modifying the lever length and the fulcrum position, it is possible to get different mixed-mode ratios, varying between an almost pure mode I to pure mode II, where the mixed-mode ratio is defined as the ratio between the mode II energy release rate component and the total energy release rate.

Whereas the fracture toughness under pure mode I and mode II are defined as the G_{Ic} and G_{IIc} material properties, under a mixed-mode loading the resulting fracture toughness is an intermediate value which depends on the mixed-mode ratio. In order to express the mixed-mode delamination toughness, the Benzeggagh Kenane criterion is often used [9].

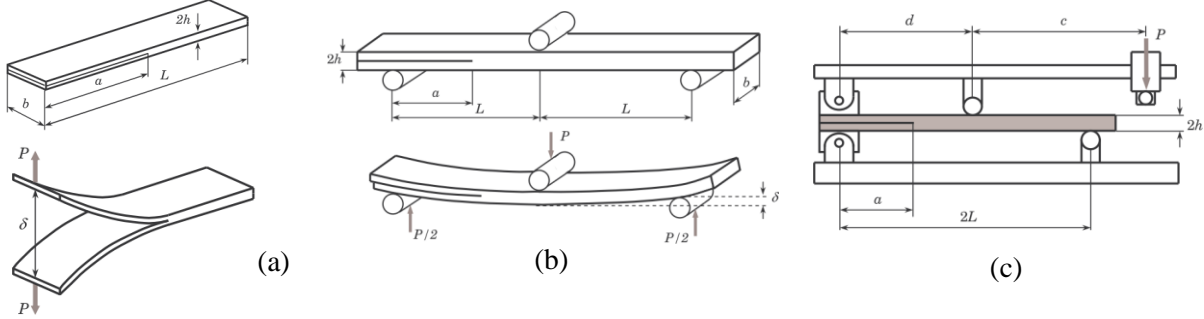

Figure 1. Delamination standard tests: (a) Double cantilever beam (DCB); (b) Three-point end-notched flexure (ENF); (c) Mixed mode bending (MMB).

Quasi-static delamination in DCB, ENF and MMB specimens were modeled in this study using the Abaqus/Standard progressive VCCT algorithm to identify the characteristics of the algorithm in terms of convergence and solution accuracy. As a reference, the specimens analyzed by Turon et al. [10] were considered. The load-displacement curves obtained from the numerical models were then compared to the analytical and experimental data also reported in [10].

2.1 Analysis of Quasi-Static Delamination in Mode I

The reference DCB specimen used in the present study is 25.4 mm wide, 102 mm long and each arm is made of 12 unidirectional plies 0.13 mm thick, for a total thickness of 1.56 mm. It is made of AS4/PEEK carbon fiber composite, whose properties are reported in Table 1, while the experimental data of fracture toughness and crack length are reported in Table 2.

Table 1. AS4/PEEK properties [10].

E_{11} (MPa)	E_{22} (MPa)	G_{12} (MPa)	G_{23} (MPa)	ν_{12}	ν_{23}
122 700	10100	5500	3700	0.25	0.45

Table 2. Experimental data [10].

G_{II}/G_T	0% (DCB)	20% (MMB)	50% (MMB)	80% (MMB)	100% (ENF)
G_C (kJ/m ²)	0.969	1.103	1.131	1.376	1.719
a_0 (mm)	32.9	33.7	34.1	31.4	39.3

The finite element model is composed of two coincident layers of four-node shell elements (S4R) with a regular mesh of 102x24 elements for each arm. The two layers of elements are connected using the default surface CONTACT PAIR definition and fracture surface interaction is specified with VCCT to tie the two arms. Moreover, the shell element sections are defined with an offset equal to the half thickness to allow the use of coincident nodes for both arms of the specimen.

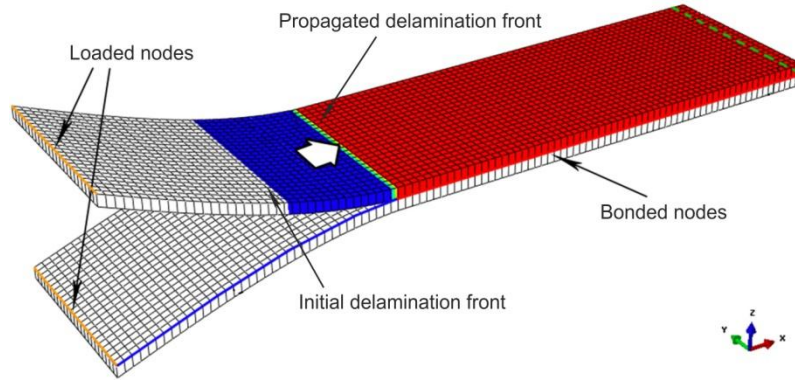

Figure 2. Finite element model of DCB specimen.

Two debonding options are available in Abaqus 6.11 [11]: nodal release = STEP (default) and nodal release = RAMP. Both options are discussed below and their results are compared.

When the STEP release is specified, the constraint holding the crack tip closed are released suddenly once the fracture toughness is reached. The resulting load displacement curve shows sudden load drops and reloading due to the discrete crack propagation, as can be seen in Figure 3. This jagged response is non-physical since stable delamination should be a continuous process associated with smooth crack propagation. In addition, the analysis presents numerical convergence difficulties that require extremely small integration load increments. However, the model reproduces the stiffness of the specimen and it describes the crack propagation process reasonably well. The critical point of delamination initiation that corresponds to the first non-linearity in the experimental load-displacement curve is also captured.

To reproduce a more physical gradual release phenomenon, a new feature was implemented in Abaqus 6.11: the gradual release of the VCCT. With the RAMP option, when the energy release rate exceeds the critical value at a crack tip, the tension is gradually released in such a way that the debonding force is brought to zero no later than the time at which the next node along the crack path begins to open. In this way, it is possible to model continuous crack propagation instead of the discontinuous process obtained from the immediate release technique. The resulting load displacement curve also shown in Figure 3 more accurately represents the continuous delamination process.

An added benefit of the gradual crack propagation associated with the ramp option is that it improves the convergence of the equilibrium solution, which results in larger time increments and fewer equilibrium iterations. Moreover, since RAMP option does not lead to a sudden nodal release, all the nodes along the same line do not simultaneously release as the crack propagates. Instead, the crack front can assume a curved shape (Figure 4) that represents more accurately the experimental data shown in Figure 5 [12].

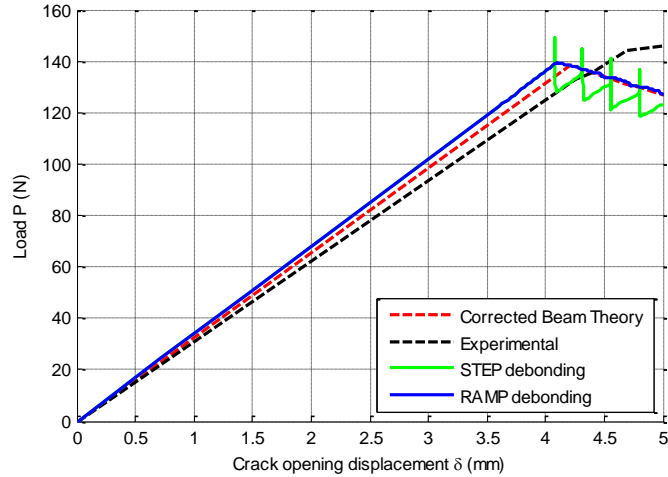

Figure 3. DCB quasi static delamination - STEP and RAMP debonding.

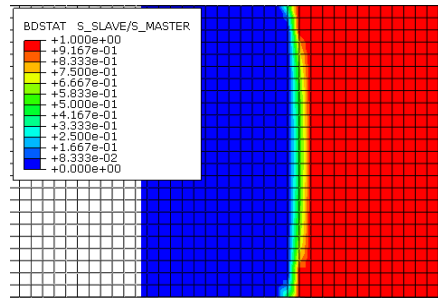

Figure 4. DCB quasi static delamination - RAMP debonding - Crack tip shape.

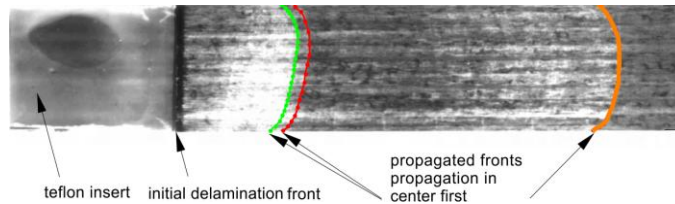

Figure 5. DCB experimental crack tip shape.

To predict correctly the propagation of delamination, the methodology used must be able to predict delamination fronts that are not aligned with the mesh. To investigate whether the Abaqus progressive VCCT algorithm is able to properly manage delamination fronts independently from the configuration of the underlying finite element mesh, the DCB specimen was modeled with an irregular mesh. It was found that the default sudden release debonding option does not properly take into account delamination in an irregular mesh (Figure 6a), while the gradual release formulation provides good results in such a configuration (Figure 6b). The results also indicate that in models with irregular meshes the RAMP option provides a correct load-displacement response (Figure 7), whereas the default STEP option results in an inconsistent delamination front aligned with the mesh and an irregular load-deflection response, although the delamination onset is predicted correctly.

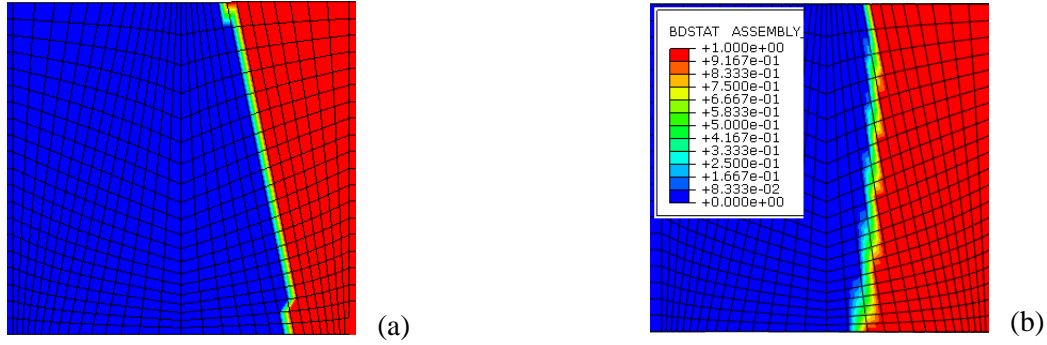

Figure 6. Crack tip shape in DCB with non-regular mesh: (a) Mesh; (b) Delamination front shape.

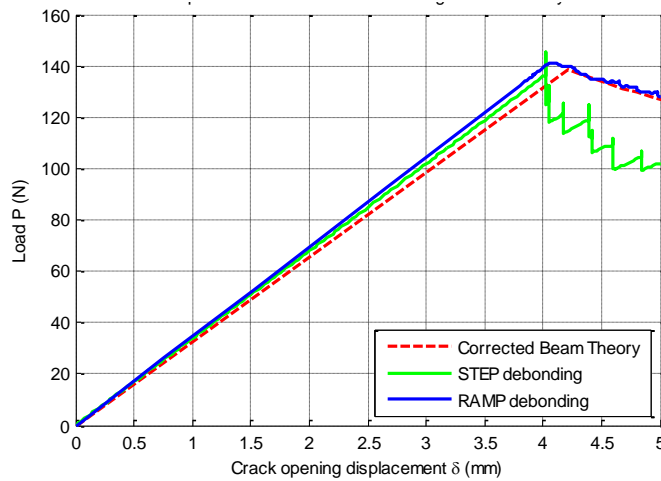

Figure 7. Load-displacement curves in DCB with non-regular mesh.

2.2 Analysis of Quasi-Static Delamination in Mode II and in Mixed-Mode

Abaqus/Standard was also used to investigate quasi-static delamination under mode II and mixed-mode. The configuration of the finite element models for the ENF and MMB specimens were identical to the DCB model, and the specific boundary and loading conditions for each specimen type were applied.

Modeling pure mode II with the standard STEP debonding option led to instabilities in crack propagation that required load increments of the order of 10^{-10} of the final load to achieve equilibrium.

Unlike the case of the DCB specimen, using the RAMP gradual release option did not improve the solution for mode II delamination. In addition, it appears that the RAMP option is unable to manage in-plane loading conditions. Although several mesh sizes, integration methods, time steps and other options were tried, the numerical convergence was never reached. The solver is not able to find a solution after the fracture toughness was reached, even if it correctly identifies the delamination onset.

A finite element model of the MMB was developed that allows the mode mixity to be varied. To express the mixed-mode critical energy release rate as a function of the mixed-mode ratio, the B-

K criterion was adopted [9]. The B-K parameter η can be computed by a least-square fit and results $\eta = 2.284$, as in [10].

An analysis of the MMB results indicates that delamination using the default STEP sudden release option has the same characteristics of the DCB and the ENF models: stable crack propagation is obtained under low mixed-mode ratios dominated by mode I, with load-displacement curves that well reproduce the analytical and experimental data. For MMB specimens with a higher mode II component, the convergence of the load incrementation procedure was found to be exceedingly slow.

Finally, an evaluation of the gradual RAMP release option indicated that, as with the ENF model, the MMB model was unable to reach convergence of the equilibrium iterations after the delamination onset is exceeded.

3. DELAMINATION UNDER FATIGUE LOADING

Delamination under fatigue loading occurs through several cycles, during which the crack propagates at a rate depending on load amplitude and material properties. The following sections describe the use of the DIRECT CYCLIC Analysis tool in Abaqus/Standard for fatigue crack propagation under different fracture mode mixities.

3.1 Abaqus Direct Cyclic Analysis

A DIRECT CYCLIC analysis in Abaqus is a quasi-static analysis that, using a combination of Fourier series and time integration, provides the stabilized cyclic response of a structure in which each successive cycle is the same as in the previous one. The aim of this analysis methodology is to avoid having to perform a transient analysis, which may require a large number of analyses when many load cycles must be applied to obtain the stabilized response. Abaqus DIRECT CYCLIC analysis takes into account material nonlinearities, but assumes geometrically linear behavior and fixed contact conditions. It can also be used in conjunction with the VCCT to predict progressive damage or delamination growth due to fatigue loading [11]. Given a cyclic load shape, the material fracture toughness, and the Paris law coefficients, the direct cyclic fatigue analysis can be used to compute the energy release rate experienced during the loading cycle and predict crack growth. Mixed-mode delamination is partially supported: while fracture toughness can be defined through a function of the mixed-mode ratio, only one Paris law can be defined and it is applied regardless of the mixed-mode ratio:

$$\frac{da}{dN} = C (\Delta G)^m \quad (1)$$

here ΔG is the change in the energy release rate between the maximum and minimum load along a loading cycle. If the energy release rate at any point along the loading cycle is higher than the threshold value, the fatigue delamination growth condition is satisfied and the crack is extended by releasing the nodes with the highest energy release rate at the crack tip. This propagation alters the response of subsequent analysis cycles due to the changes in contact conditions. The methodology can calculate how many cycles are necessary to advance the crack along that element. The methodology is evaluated below using a DCB, ENF, and MMB specimens.

3.2 Analysis of Fatigue Delamination in Mode I

The DCB, ENF and MMB specimens used by Asp et al. [13] in fatigue tests were modeled with the Abaqus and analyzed using the DCA technique. The specimens are made of HTA/6376C carbon/epoxy prepreg plies with the mechanical properties reported in Table 3.

The DCB specimen is 20 mm width and 150 mm long. A nearly unidirectional lay-up of $[0_{12}/(\pm 5/0_4)_S]$ was used, where the "/" identifies the delamination plane. Every ply has a thickness of 0.13 mm, resulting in a specimen nominal thickness $2t$ of 3.12 mm. The initial crack length a_0 is 35 mm. The unusual lay-up was chosen to avoid the fiber bridging in DCB and MMB tests. In order to simplify the problem and to be able to apply an existing analytical model, the whole specimen is considered with a Poisson's ratio equal to zero and made of unidirectional plies, resulting in a $[0_{12}/0_{12}]$ lay-up. Thus, it is possible to get a uniform pure mode I loading condition with a purely two-dimensional (cylindrical) response, as demonstrated in [14]. Considering the experimental data available measured by Juntti et al. [15], it is possible to compute the Paris law coefficients through a linear regression for all specimens, as was done in [16]. The resulting Paris curve coefficients are reported in Table 4.

Table 3. HTA/6376C elastic properties [16].

E_{11} (MPa)	E_{22} (MPa)	G_{12} (MPa)	G_{23} (MPa)	ν_{12}	ν_{23}
120000	10500	5250	3480	0.30	0.51

Table 4. HTA/6376C crack propagation properties.

k	G_c (kJ/m ²)	G_{th} (kJ/m ²)	M	C
0 – DCB	0.260	0.060	5.46	4.46
0.5 – MMB	0.447	0.066	6.24	23.8
1 – ENF	1.002	0.100	4.33	0.116

A comparison of the properties for crack propagation shown in Table 4 for three mode ratios illustrates the strong effect that mode mixity exerts on the crack propagation rates. Therefore, it is necessary to use the specific data corresponding to each loading condition, which is particularly difficult to accomplish in complex structures where the mode mixity varies throughout and may even change with time. Crack propagation models that can predict delamination propagation rates under such general conditions have not been developed yet.

The Abaqus fatigue damage model was evaluated using a finite element model of the DCB similar to the one used for the static analyses. The model is composed of two layers of S4R shell elements with coincident nodes and an offset equal to half the arm thickness. The mesh is homogeneous along the short edge, while along the specimen it is refined just in the delamination area to reduce the computational time without losing accuracy, so the elements involved in crack propagation are 1 mm wide and 0.5 mm long, as illustrated in Figure 8. The

total number of elements in the model is 2800. The element faces identify the delamination surfaces and the bonded elements are connected using the Abaqus CONTACT PAIR property.

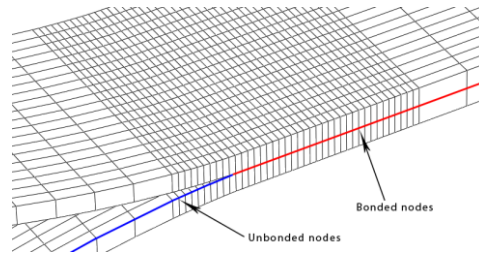

Figure 8. DCB finite element model for fatigue analyses (detail).

To ensure the convergence of the direct cyclic algorithm, the default control parameters regarding the stabilized state and the plastic ratcheting detection criteria were modified, as suggested by the Abaqus Example Problems Manual [17]. The results are compared to the analytical formula provided in by Juntti et al. [15].

The application of the DCA technique starts with the definition of a loading cycle using a pre-defined number of increments. To evaluate the number of time increments required, three analyses were conducted, using 10 load increments per cycle T , 20 increments per cycle, and 100 increments per cycle. The results shown in Figure 9 indicate that 10 increments per cycle is insufficient to properly characterize the cyclic response, as the crack propagation lags by the propagation rate of the other analyses by about 5 times the number of cycles. The results with a time increment of $1/20 T$ correlate well with the analytical model. No improvement in solution accuracy was found reducing the time increment to $1/100 T$.

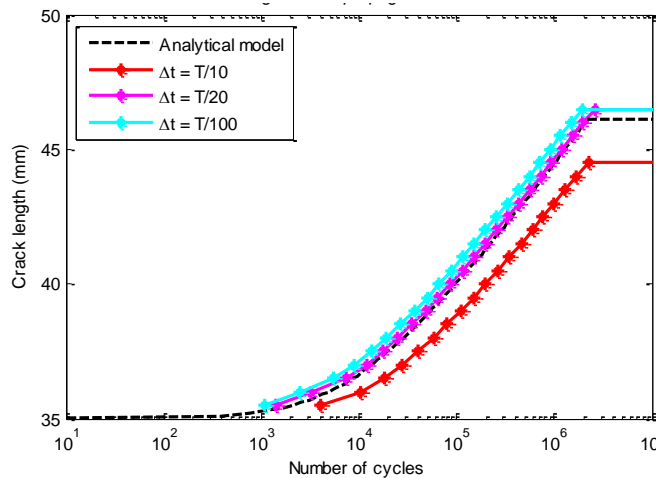

Figure 9. Fatigue DCB analysis.

During the delamination propagation, as the energy release rate range is higher in the middle, central nodes open first and then the crack propagates to the edges, with the same behavior observed in the static analyses. Figure 10 shows crack propagation of the $T/100$ time increment analysis. The number of cycles at several steps is shown in the caption.

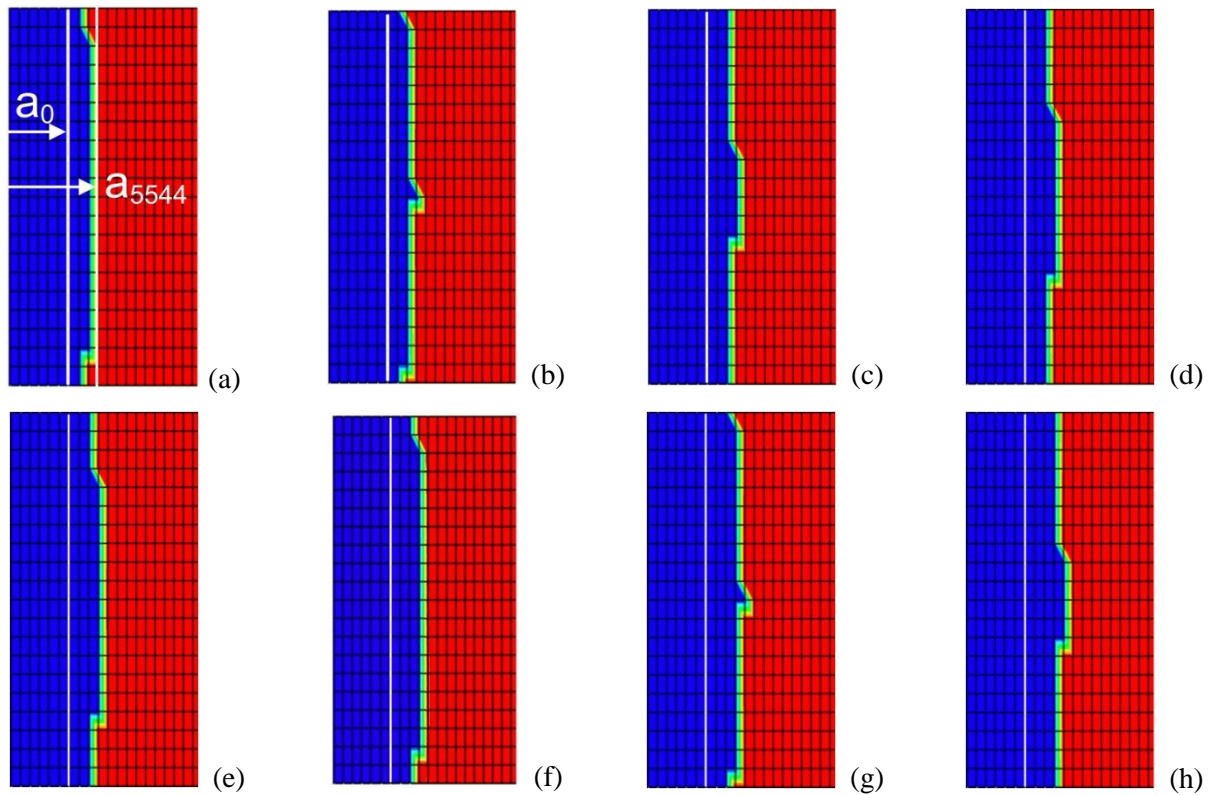

Figure 10. DCB fatigue crack growth: (a) 5544 cycles; (b) 7086 cycles; (c) 7142 cycles; (d) 7294 cycles; (e) 7804 cycles; (f) 8952 cycles; (g) 10780 cycles; (h) 10902 cycles.

3.3 Analysis of Fatigue Delamination in Mixed-Mode and in Mode II

To study the Abaqus/Standard capabilities in computing the fatigue life under mixed-mode loading cycles, a finite element model of the reference MMB specimen with 48% mode mixity was used. The results show that good correlation with the analytical solution is obtained when the cycle is represented by 20 or more load increments. However, some numerical issues were noticed in the fatigue crack propagation when, after crack onset on a new node line, the crack front propagates transversally towards the specimen edges.

Finally, the fatigue crack propagation in mode II was investigated using the ENF specimen and a finite element model similar to the one of the static analysis. However, the direct cyclic method does not predict the correct deformation of the specimen. The analysis does not take into account the contact conditions between the two arms, which results in the deformed shape shown in Figure 11. Indeed, the Abaqus Analysis User's Manual [11] states that the direct cyclic analysis assumes fixed contact conditions within each loading cycle.

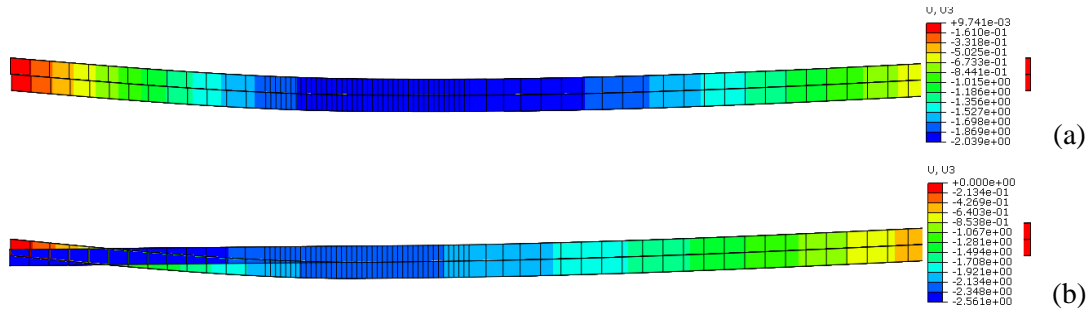

Figure 11. ENF out of plane displacement: (a) Static analysis; (b) Direct cyclic analysis.

4. SINGLE STRINGER COMPRESSION SPECIMEN

The design of damage tolerant thin stiffened structures that operate under compression loads is particularly challenging because the collapse of such structures is the results of interactions between the postbuckling deformations and the development of local damage mechanisms. To evaluate the ability of the progressive VCCT algorithm to predict the delamination mechanism that leads to the collapse of a postbuckled structure, a stiffened subcomponent was modeled in which delamination propagation occurs in the post-buckling field.

4.1 Description of the Specimen

The single-stringer compression specimen (SSCS) was developed by Bisagni et al. [1] to have a small and computationally tractable model to study failure in a relatively complex component subject to compression. The shape of the specimen was optimized such that the smaller specimen reproduces the postbuckling condition of the associated multistring panel. The stringer is made of IM7/8552, whose properties are shown in Table 5. Every ply is nominally 0.125 mm thick. The skin has a stacking sequence of $[45/90/-45/0]_s$, while the stringer has a $[-45/0/45/0/45/0/-45]$ lamination sequence. A pre-defined defect is obtained by inserting a 20 mm Teflon film between the stringer and the skin (Figure 12, dimensions in millimeters).

Table 5. IM7/8552 properties [1].

E_{11} (MPa)	E_{22} (MPa)	G_{12} (MPa)	ν_{12}	G_{Ic} (kJ/m ²)	G_{IIc} (kJ/m ²)
150000	9080	5290	0.32	0.277	0.788

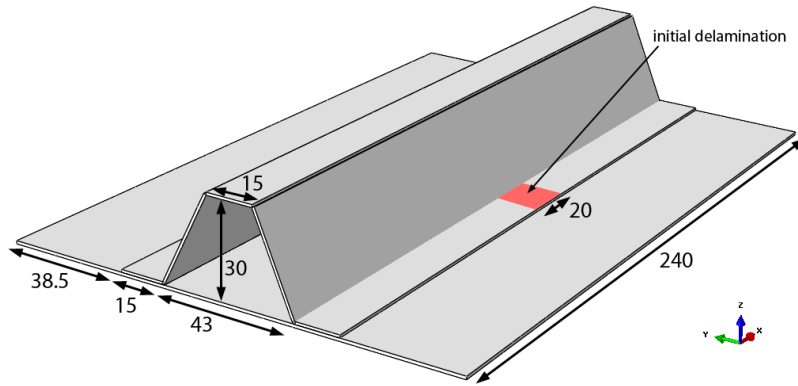

Figure 12. SSCS geometry.

4.2 Preliminary Analysis

The finite element model is composed of two shells. A flat shell represents the skin, and a hat-shaped shell represents the stiffener. Both shells are composed of four-noded shell elements with reduced integration (S4R). Wall offsets were used to allow the nodes along the contact surfaces between the skin and the stringer to be coincident. For simplicity the end tabs are not modeled, but they are simulated by constraining the translational and rotational degrees of freedom of the end nodes. The mesh is made of regular square elements 2.5 x 2.5 mm, for a total of 9888 elements. As for the DCB, ENF and MMB specimens described earlier, a contact pair with fracture surface interaction was specified to tie the skin and the stiffener nodes along the flange of the stiffener.

The experimental results indicate that damage propagates in an unstable manner. Immediately after the delamination initiates, the specimen completely loses its stiffness, as shown in Figure 13. The numerical results predict a pre-buckling linear stiffness of 67.5 kN/mm, which is 12% higher than the stiffness obtained experimentally. The buckling takes place at 9.5 kN, with good agreement with the experimental results (10 kN). The predicted ultimate load in this preliminary analysis is 34.5 kN, just 4% lower than the experimental value of 36 kN. Similar results were found by Bisagni et al. [1] in the numerical analysis of the SSCS using the cohesive zone model method.

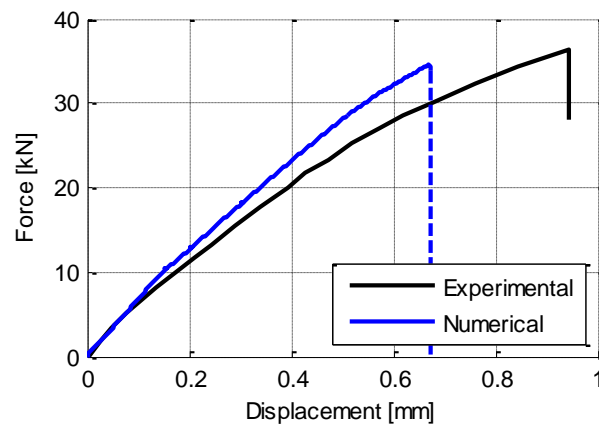

Figure 13. SSCS quasi-static analysis: load displacement curves.

An analysis of the debonding condition indicated that the energy release rate distribution is three-dimensional: the in plane shear components (II and III) usually present a concentration at the external nodes, while the mode I component has a non-uniform distribution along the whole crack tip. Therefore, the delamination process begins at the node with the highest energy release rate concentration and then, due to the subsequent stress redistribution, the propagation is driven by the mode I component and the delamination front advances at an angle of approximately 45°, as can be observed in Figure 14.

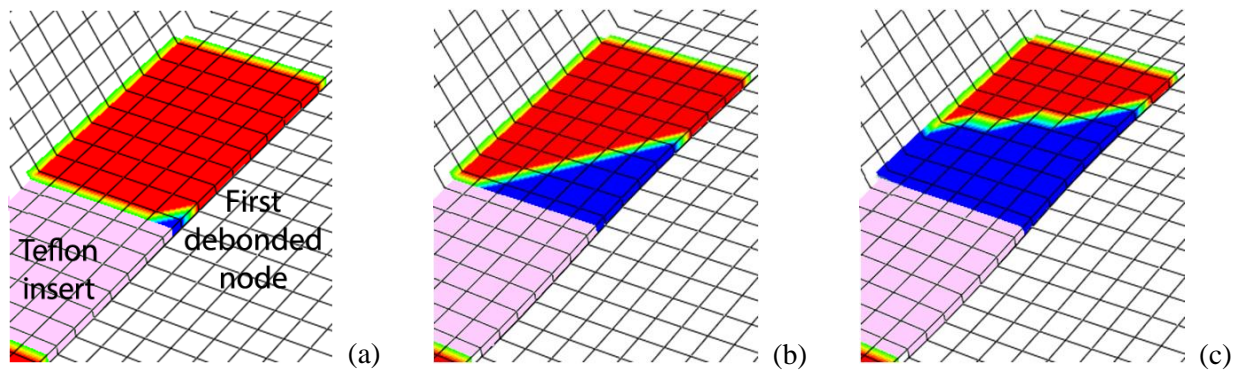

Figure 14. SSCS quasi static analysis - Debonding process.

4.3 Cyclic Load Analysis

To evaluate the DCA fatigue analysis capability on a structural component operating under postbuckling conditions, the single stringer composite specimen model was subjected to cyclic load analysis by applying a cyclic sinusoidal displacement with 0.5 mm amplitude. The results show that the direct cyclic technique is unable to recognize the buckling onset and the resulting deformed shape consists in a uniform compression. This result is not unexpected, since DCA is based on a geometrically linear response [11]. The difference in the linear and nonlinear response obtained with a standard quasi-static analysis can be observed in Figure 15: the direct cyclic analysis provides a pure cosine response that is directly proportional to the applied displacement, while the stiffness of the quasi-static analysis changes after buckling. An attempt to apply geometric imperfections to the direct cyclic analysis model failed, as the entire response of the model remained linear and proportional to the applied load.

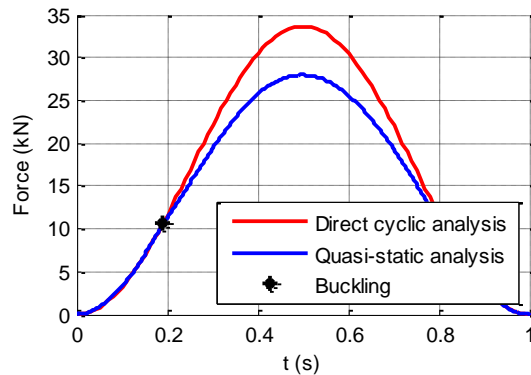

Figure 15. SSCS cyclic analyses: reaction force comparison.

Moreover, since the energy release rate components are not uniform along the delamination tip, it is not possible to find out a unique mixed-mode ratio to describe the loading condition. Since the Paris fatigue law is a function of the mode mixity and only a single law at a time can be specified, it is not possible to describe the fatigue propagation rate for all mode mixities. This inability of the current Abaqus DCA fatigue model implementation to account for variable fracture mode mixities is an additional limitation that prevents the technique from being applied to structural problems with anything other than the simplest levels of complexity.

5. CONCLUSIONS

The ability of the Abaqus progressive Virtual Crack Closure Technique (VCCT) to model delamination in composite structures was investigated for static, fatigue and post-buckling loads.

To evaluate the capabilities of the VCCT technique, simulations of delamination under static loading were performed. Both available nodal release methods, STEP and RAMP, as well as the effect of mesh alignment on delamination front propagation were investigated. The predicted delamination initiation was found to be in agreement with analytical results. The delamination propagation phase was also correctly predicted for simple structures with uniform stress and displacement distributions. However, critical problems were identified when the algorithm is applied to problems in which the delamination front propagates in directions that are not aligned with the mesh. In particular, the method was found to be reliable only for pure mode I cases, while it fails with pure mode II cases and high mixed-mode ratios.

Delamination under fatigue loading was investigated using the DIRECT CYCLIC fatigue algorithm coupled with the VCCT. The algorithm properly predicts the fatigue life of simple specimens, even if it has some limitations in modeling complex structures. Indeed, the procedure does not consider different fatigue propagation laws according to the mixed-mode ratio and supports just linear analyses. However, the algorithm can be fruitfully used for structures with linear behavior and a constant crack propagation mode shape.

Finally, a complex subcomponent consisting of a panel with a hat stringer was analyzed under compressive load, and results were compared to the experimental data. Experimental results show that delamination propagation occurs in the post-buckling field. The interface between skin and stiffener was modeled using the VCCT technique, and the analysis was conducted using non-linear quasi-static procedure. It was found that the Abaqus VCCT algorithm properly manages crack propagation onset even under the post-buckling deformations, which renders it a valuable tool for a preliminary estimation of ultimate load and damage pattern. However, the direct cyclic analysis algorithm was found to be unsuitable for fatigue analyses where nonlinear displacements are present and where the fracture mode mixity varies at different locations in the model.

6. REFERENCES

1. Bisagni, C., Vescovini, R., Dávila, C.G. “Single-Stringer Compression Specimen for the Assessment of Damage Tolerance of Postbuckled Structures.” *Journal of Aircraft* 48 (2011): 495–502.
2. Bisagni, C. “Progressive Delamination Analysis of Stiffened Composite Panels in Post-Buckling”. Proceedings of the 47th AIAA/ASME/ASCE/AHS/ASC Structures, Structural Dynamics, and Materials Conference AIAA 2006-2718. (2006).
3. Orifici, A., Ortiz de Zarate Alberdi, I., Thomson, R., Bayandor, J. “Compression and Post-Buckling Damage Growth and Collapse Analysis of Flat Composite Stiffened Panels.” *Composites Science and Technology* 68 (2008): 3150–3160.
4. Turon Travesa, A. Simulation of Delamination in Composites under Quasi-Static and Fatigue Loading using Cohesive Zone Models. PhD Thesis, Universitat de Girona, 2006.
5. O’Brien, K.T. Characterization of Delamination Onset and Growth in a Composite Laminate, *Damage in Composite Materials*. ASTM STP. 775 (1982): 140–167.
6. Krueger, R. Virtual Crack Closure Technique: History, Approach, and Applications. NASA Contractor Report. 211628 (2002).
7. Mabson, G.E., Deobald, L.R., Dopker, B., Hoyt, D., Baylor, J.S., Graesser, D.L. “Fracture Interface Elements for Static and Fatigue Analysis.” In: Proc. 16th Int. Conf. on Composite Materials (ICCM-16), Kyoto, Japan, CD-ROM, 2007: 1-10.
8. Reeder, J.R., Crews, J.H. Nonlinear Analysis and Redesign of the Mixed-Mode Bending Delamination Test, NASA Technical Memorandum. 102777 (1991).
9. Benzeggagh, M.L., Kenane, M. “Measurement of Mixed-Mode Delamination Fracture Toughness of Unidirectional Glass/Epoxy Composites with Mixed-Mode Bending Apparatus.” *Composite Science and Technology* 56(4) (1996): 439-449.
10. Turon, A., Camanho, P.P., Costa, J., Dávila C.G. “A Damage Model for the Simulation of Delamination in Advanced Composites under Variable-Mode Loading.” *Mechanics of Materials* 38 (2006): 1072-1089.
11. Simulia, Abaqus 6.11 Analysis User’s Manual, 2011.
12. Krueger, R. An Approach to Assess Delamination Propagation Simulation Capabilities in Commercial Finite Element Codes. NASA Technical Memorandum 215123 (2008).
13. Asp, L.E., Sjörgen, A., Greenhalgh, E.S. “Delamination Growth in a Carbon/Epoxy Composite under Fatigue Loading.” *Journal of Composite Technology Research* 23 (2001): 55–68.
14. Brambilla, P. Modeling of Delamination in Composite Structures under Static and Fatigue Loading. Master thesis, Politecnico di Milano, July 2012.
15. Juntti, M., Asp, L.E., Olsson, A.R. “Assessment of Evaluation Methods for the Mixed-Mode Bending Test.” *Journal of Composites Technology & Research* 21 (1999): 37–48.
16. Turon, A., Costa, J., Camanho, P.P. “Simulation of Delamination in Composites under High-Cycle Fatigue.” *Composites Part A: Applied* 38 (2007): 2270–2282.
17. Simulia, Abaqus 6.11 Example Problems Manual, 2011.