

Resolution of Forces and Strain Measurements from an Acoustic Ground Test

Andrew M. Smith
Vibroacoustics Specialist
Vehicle Loads and Strength Branch (EV31)
NASA Marshall Space Flight Center

Ronald Hunt, BRC Inc
Dynamics Loads & Vibroacoustics Specialist
ESSSA Contract Support to
Vehicle Loads and Strength Branch (ES22)
NASA Marshall Space Flight Center

Bruce T. LaVerde, ERC Inc
Vibroacoustics Lead Engineer
ESSSA Contract Support to
Vehicle Loads and Strength Branch (EV31)
NASA Marshall Space Flight Center

James M. Waldon
Jacobs Engineering,
Dynamics Loads & Vibroacoustics Specialist
ESSSA Contract Support to
Vehicle Loads and Strength Branch (EV31)
NASA Marshall Space Flight Centers

NASA/Marshall Space Flight Center/
Vehicle Loads and Strength Branch (EV31)
4-6 June 2013





Agenda

- Introduction/Motivation
- Introduce Validation of Force Measurements at Equipment Base Interfaces
- Conservatism in Typical Vibration Tests Conducted at the Avionics Component Level of Integration
 - *Acoustic ground test with integrated primary and secondary structures*
 - *Typical box level vibration test*
 - *Provide comparisons*
- Validation of Reaction Forces Estimated at the Base of Equipment using a Finite Element Based Method
 - *Acceleration and force response examples*
 - *Important analysis parameters for the response*
- Validation of Element Forces Estimated in secondary Structure Struts
 - *Strut members, measurement locations, and installation preloads*
 - *Dynamic response forces in struts from strain measurements*
- Conclusions and Forward Work



Introduction/Motivation

- Introduce and validate force measurements at the base of the components of a system level test.
- Evaluate conservatism in typical component vibration test.

from measured examples:

- *Specifying test levels in order to conduct vibration tests in one translational axis at a time includes conservatism that can be illustrated through comparative force measurements.*
- *How much does assuming a correlated input across the base affect conservatism?*
- *Is the impedance difference between the integrated primary and secondary structure example and the component test setup important?*
- Evaluate FEM Response Estimate Correlation
 - *Provide acceleration and force response example comparisons*
- Demonstrate the use of strain measurements to:
 - *Estimate installation preloads and assist model correlation.*
 - *Estimate dynamic response forces.*



Acceleration Response Example Comparison FEM to Measured on Vehicle Panel

Test 1 exposed the heavy configuration of the tandem shelf with 4 boxes to lower level acoustic excitation.

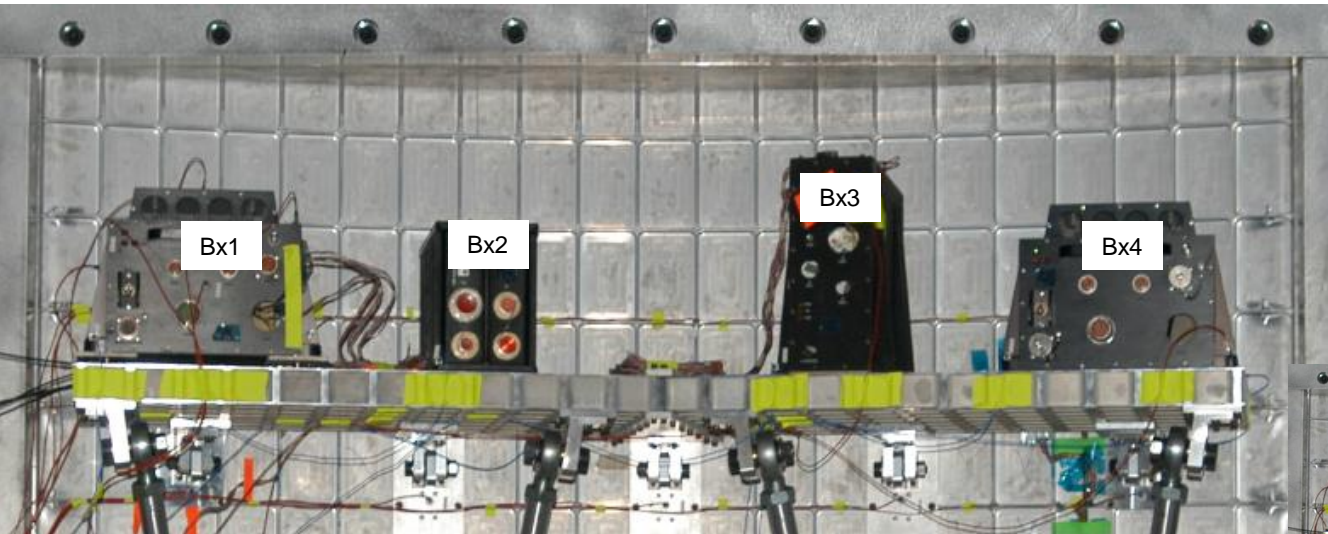

Strut numbers appear below.

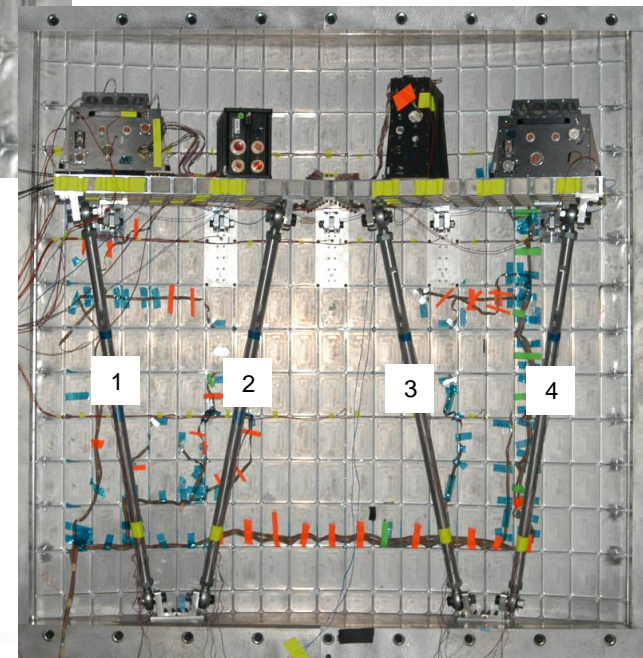

During test 1 a set of 4 tri-axial force transducers were located at the base of box 1

Kistler 9017A tri-axial load rings installed between avionics box and the orthogrid shelf.





Introduce Validation of Force Measurements at Equipment Base Interfaces

Four load cells (each measure forces in 3 directions) were verified using hammer impact trials before use in the acoustic response test. Lazor [2012]

Load Cells			
Node	X, in.	Y, in.	Z, in.
1001	-0.250	-5.594	-6.875
1002	-0.250	-5.594	6.875
1003	-0.250	5.594	-6.875
1004	-0.250	5.594	6.875

Hammer Impacts			
Node	X, in.	Y, in.	Z, in.
1Z	7.250	5.219	-6.875
2X	7.625	5.219	-6.875
3Y	7.250	5.594	-6.875
4Z	4.000	-0.031	-6.875
5X	7.625	-0.031	-6.875
6X	7.625	-5.219	-6.875
7Z	7.250	-5.219	-6.875
8X	10.000	0.000	0.000
9Z	0.375	0.000	-6.875
10Y	5.500	-5.594	0.375
11Y	0.125	-7.250	0.375

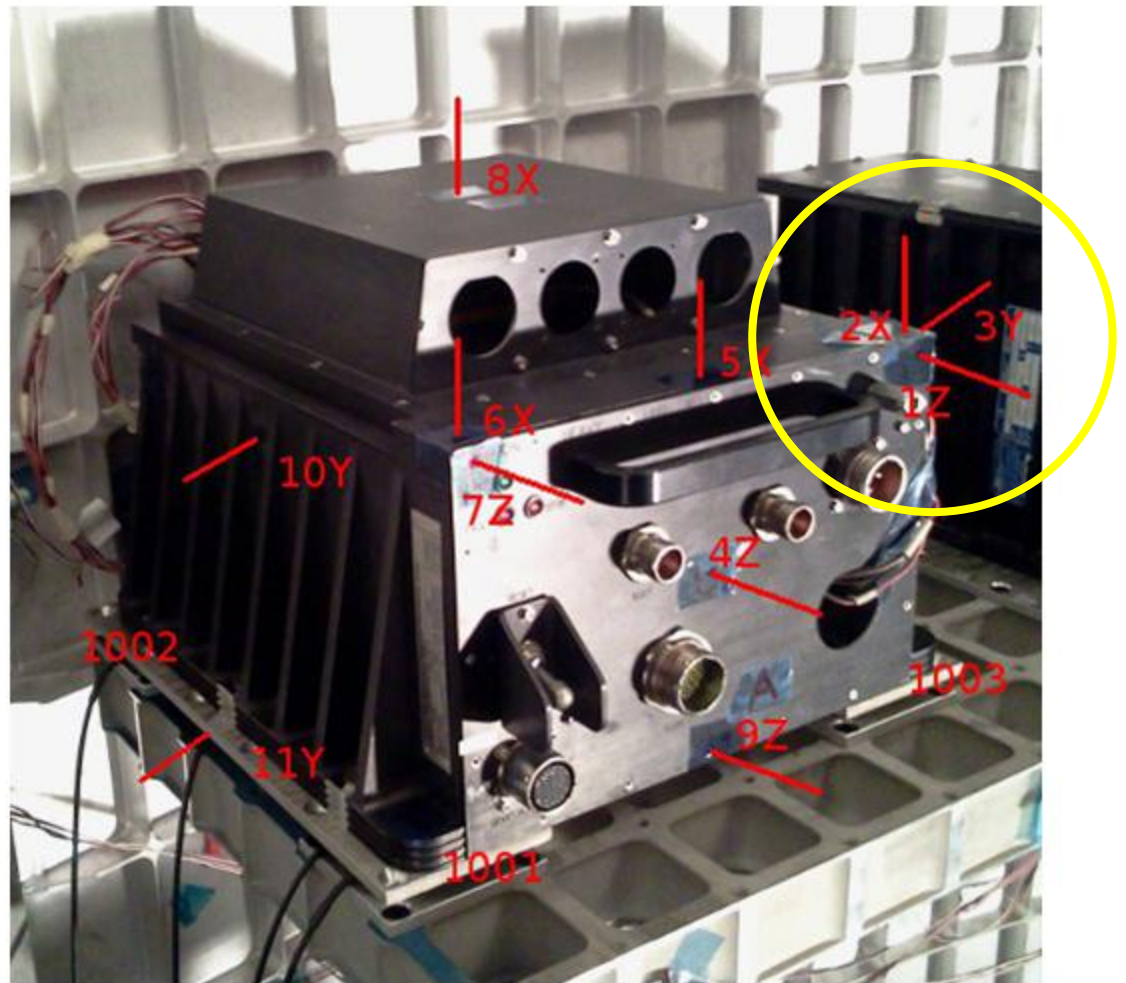



Introduce Validation of Force Measurements at Equipment Base Interfaces

Verification Results: A more complete table is presented in Reference 1

Input Loc.	DOF	Hammer Mean, lbf	Loadcells Mean, lbf	Difference lbf	% Err
1Z	X	0.00	-0.21	0.21	NA
1Z	Y	0.00	-0.09	0.09	NA
1Z	Z	5.08	5.03	0.05	0.93
2X	X	-4.64	-4.21	-0.43	9.31
2X	Y	0.00	0.63	-0.63	NA
2X	Z	0.00	-0.09	0.09	NA
3Y	X	0.00	-0.67	0.67	NA
3Y	Y	-3.99	-3.77	-0.22	5.46
3Y	Z	0.00	0.15	-0.15	NA

Verification Results: The resolved response from six hammer impacts were averaged in order to assess the accuracy of the force measurement system.

Verification Results: All the measured transients were low-pass filtered in order to study the peak impulse response. The 10th order Butterworth filter characteristics appear at the right

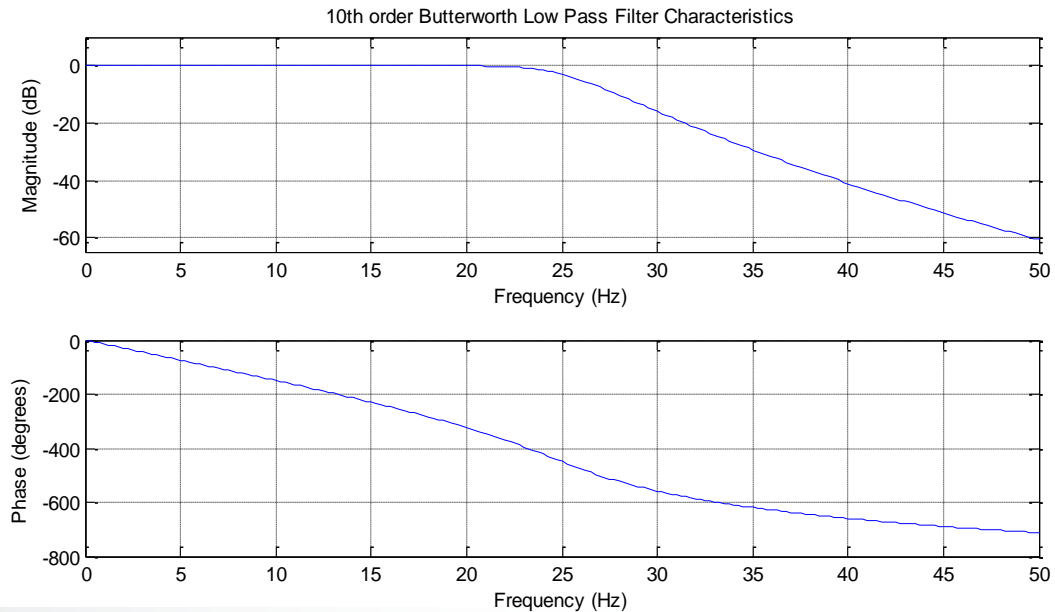



Introduce Validation of Force Measurements at Equipment Base Interfaces

Verification Results: Input Point 1 : Input direction Z : Response direction Z
Less than 1% error for resolved forces in Z direction

Pleased with wave form and magnitude of resolved forces

Dir Z : Impact 1

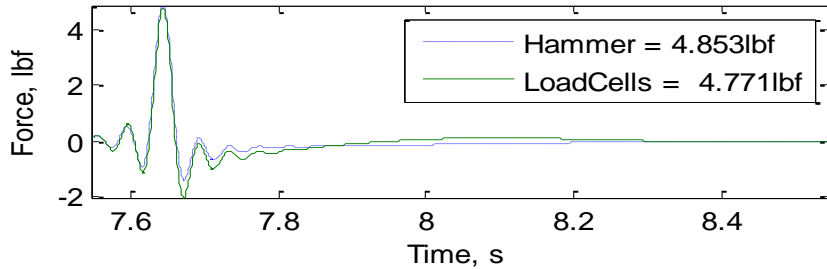

Dir Z : Impact 2

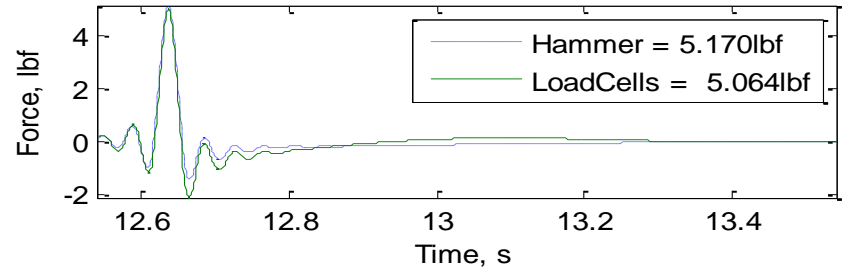

Dir Z : Impact 3

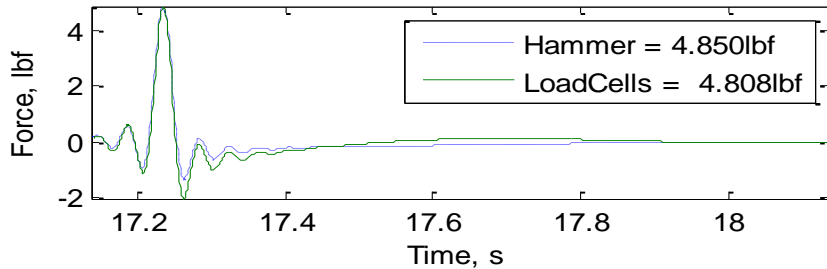

Dir Z : Impact 4

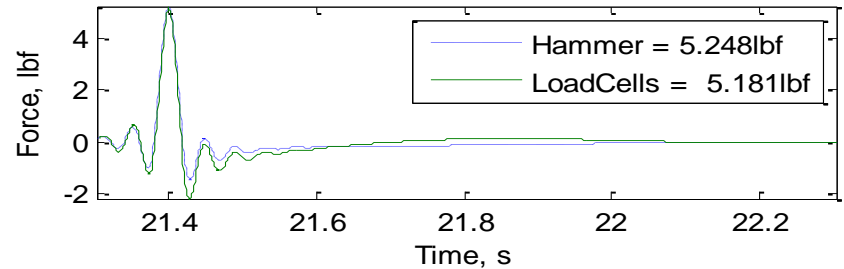

Dir Z : Impact 5

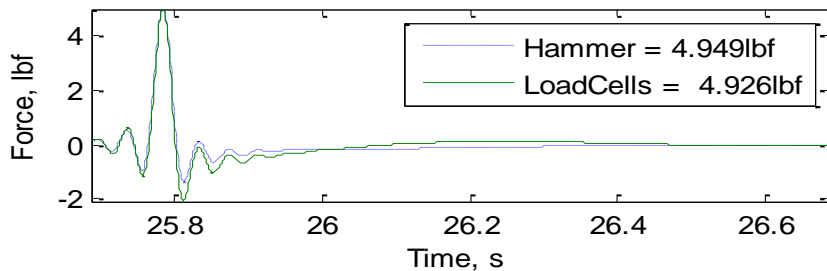

Dir Z : Impact 6

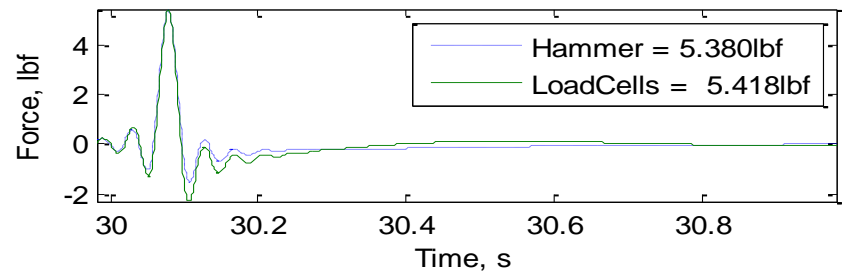



Conservatism in Typical Vibration Tests Conducted at the Avionics Component Level of Integration

- Evaluate conservatism in typical component vibration test. NASA-HDBK-7004C, Force Limited Vibration Testing, points out that:
 - *The major cause of over testing in aerospace vibration tests is associated with:*
 - The large mechanical impedance of the shaker
 - The standard practice of controlling the input acceleration to the frequency envelope of the flight data...
 - *This approach results in unrealistic, large base reaction forces and other large responses at the fixed base resonance frequencies of the test item.*
- A comparison of reaction forces measured at the base of an avionics box in the following configurations is provided.
 - *Observed during an integrated ground based acoustic test.*
 - This test included the primary structure and secondary structures.
 - Acceleration measurements from the ground based acoustic test were used to set the test criteria for the vibration tests that followed.
 - *Observed during a typical vibration test completed in 3 successive orthogonal axes of vibration input.*



Conservatism in Typical Vibration Tests Conducted at the Avionics Component Level of Integration

Test 5 exposed the light configuration of the system level tandem shelf with 2 boxes to full level acoustic excitation.

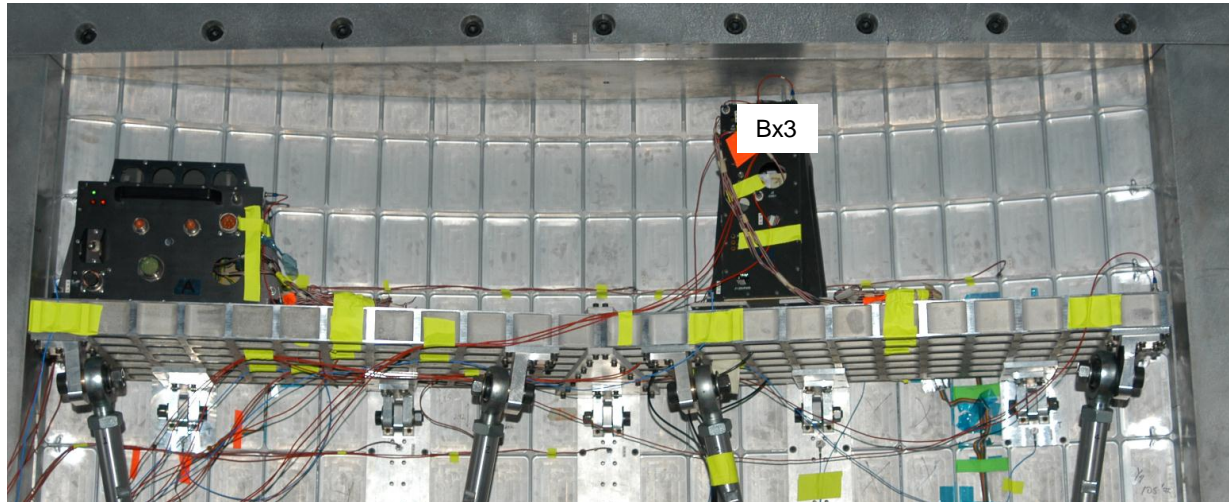

During test 5 a set of 4 tri-axial force transducers were located at the base of box 3

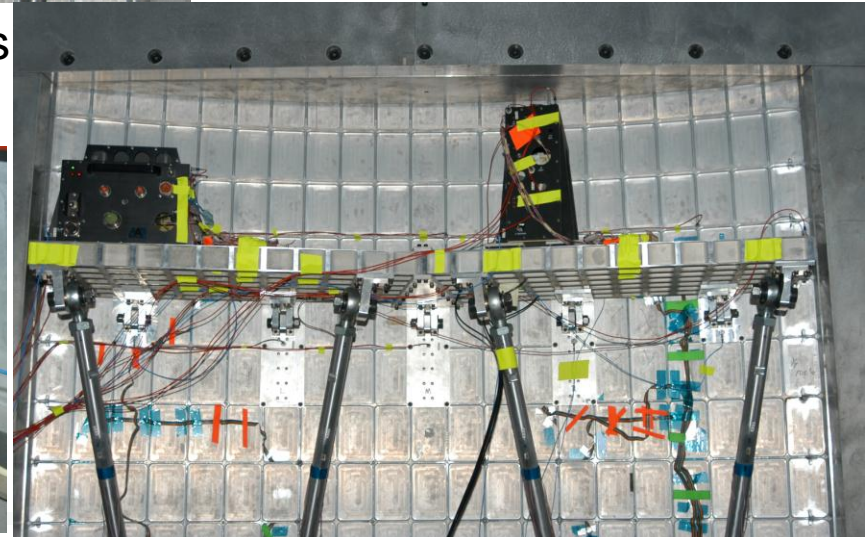
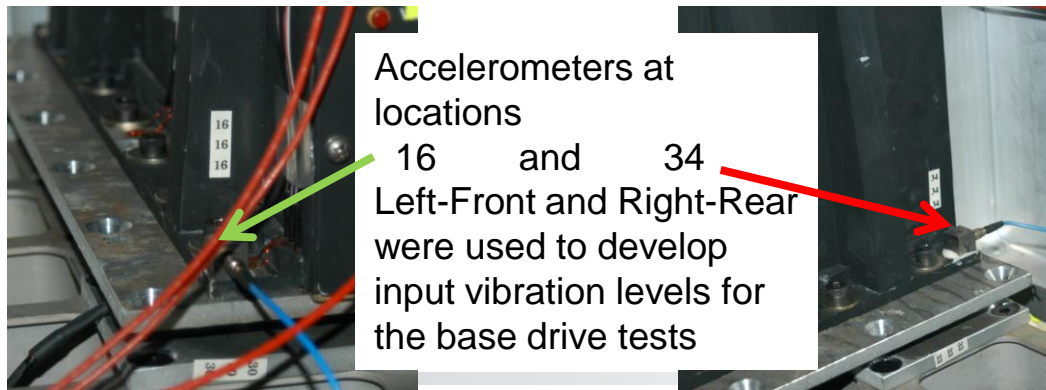

Kistler 9017A tri-axial load rings installed between avionics box and the orthogrid shelf.



Conservatism in Typical Vibration Tests Conducted at the Avionics Component Level of Integration

- Test Sequence:
 - *System Acoustic Test* :
 - Validate use of load cells to measure a known force input
 - Conduct a series of acoustic ground tests at the integrated system level. Five of these tests included force transducers at the base of avionics boxes. Test 5 is the example case provided with force sensors at the base of box 3 (28 lb).
 - *Single Axis Base Drive Vibration Tests*
 - Tangential direction base drive using box 3
 - Radial direction base drive using box 3
 - Axial direction base drive using box 3
- Present Observations from Tests in Reverse Order.
 - What are the apparent resonant frequencies of the box in each direction from the component level vibration test?
 - Does the system response at the base of the avionics box appear to be suppressed in the frequency range near these observed resonant frequencies of the box?
 - The vibration levels for the base drive vibration tests were set from measured response at base of box 3 during the system level acoustic test.
- Present a comparison of the net interface forces at the base of the avionics box.
 - Force spectral density, cumulative force RMS, Net 3 sigma load factors.



Conservatism in Typical Vibration Tests Conducted at the Avionics Component Level of Integration

Base drive vibration test data was used to determine the resonant frequency of the box in each of three directions.

Energy from input vibration criteria (non resonant)

	Resonant Box Frequency [Hz]
Tan	205
Rad	270
Axial	540

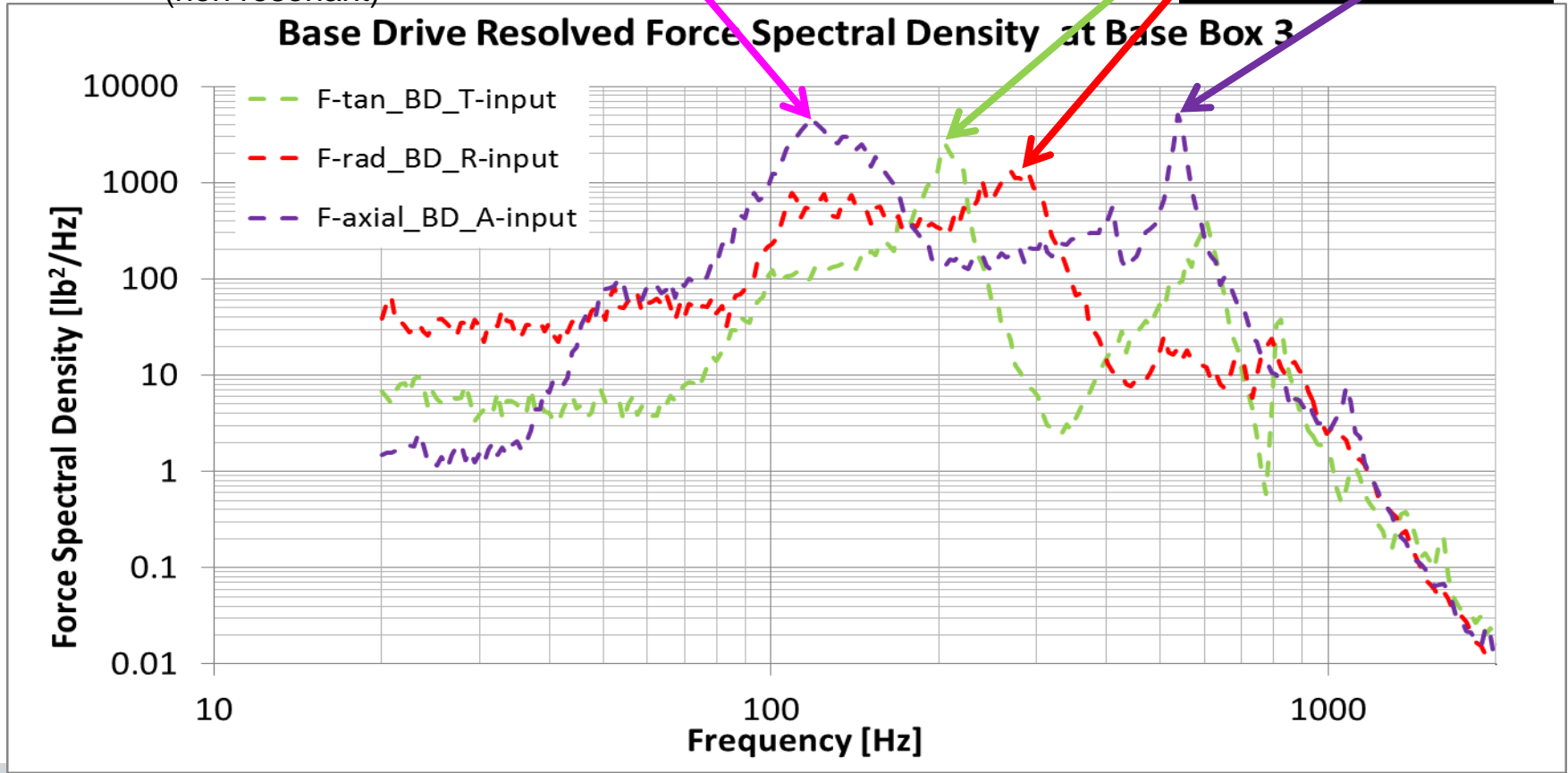



Conservatism in Typical Vibration Tests Conducted at the Avionics Component Level of Integration

Shelf Test Case 5 Tangential Direction

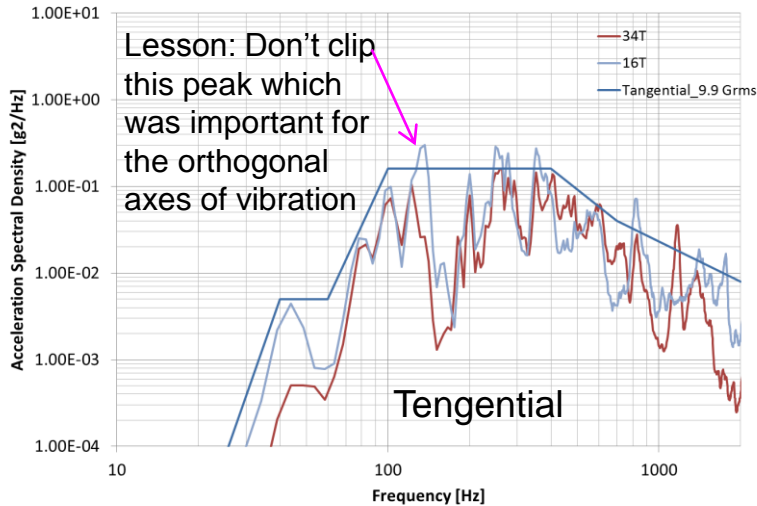

The vibration levels for the base drive vibration tests were developed from measured acceleration response at base of box 3 acquired during the system level acoustic test.

In retrospect, the tangential axis test criteria may have clipped peaks from 100-400 Hz too much.

Shelf Test Case 5 Radial Direction

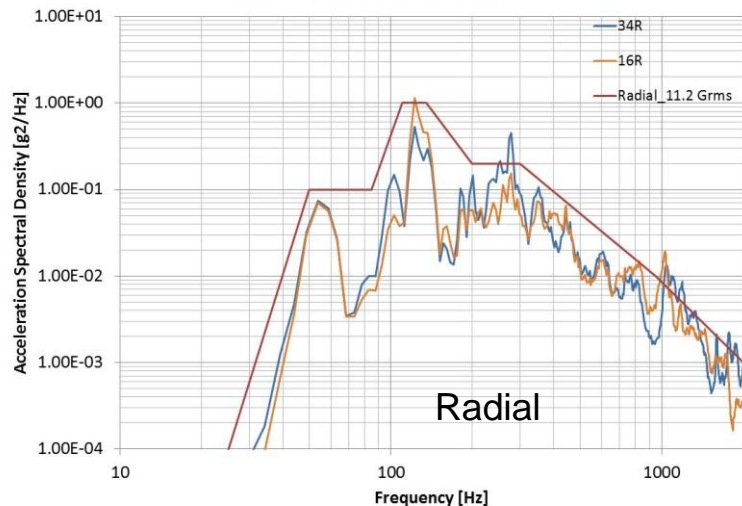

Shelf Test Case 5 Axial Direction

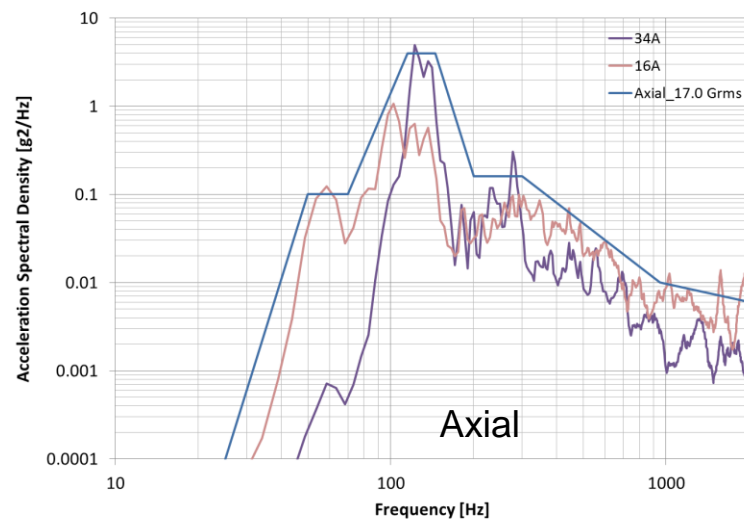



Conservatism in Typical Vibration Tests Conducted at the Avionics Component Level of Integration

Compare Base Drive to Acoustic System Test Resolved Force Spectral Density at Base Box 3

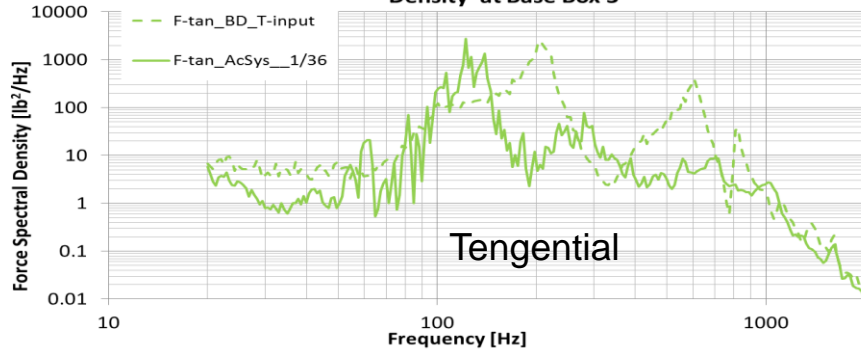

The tangential axis system test resulted in forces exceeding the single axis test. The system response force spectral density between 100-200 Hz exceeded those from the corresponding base drive - single axis test. This was an unexpected result.

Compare Base Drive to Acoustic System Test Resolved Force Spectral Density at Base Box 3

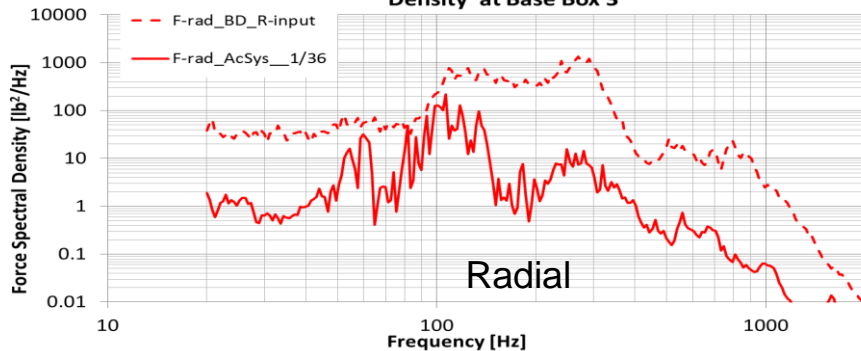

The resolved force spectral density comparisons reveals that the single axis base drive vibration tests produced quite conservative interface forces at the base of the electronics box in the radial and axial directions compared to what was measured during the integrated acoustic system test.

Compare Base Drive to Acoustic System Test Resolved Force Spectral Density at Base Box 3

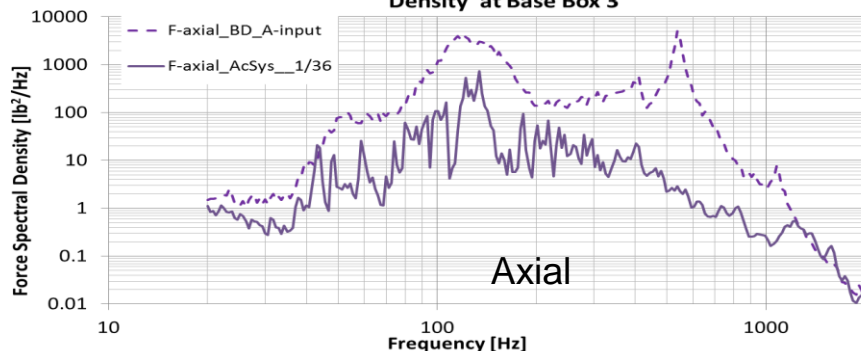

Test 5 exposed the light configuration of the tandem shelf with 2 boxes to full level acoustic excitation.



Conservatism in Typical Vibration Tests Conducted at the Avionics Component Level of Integration

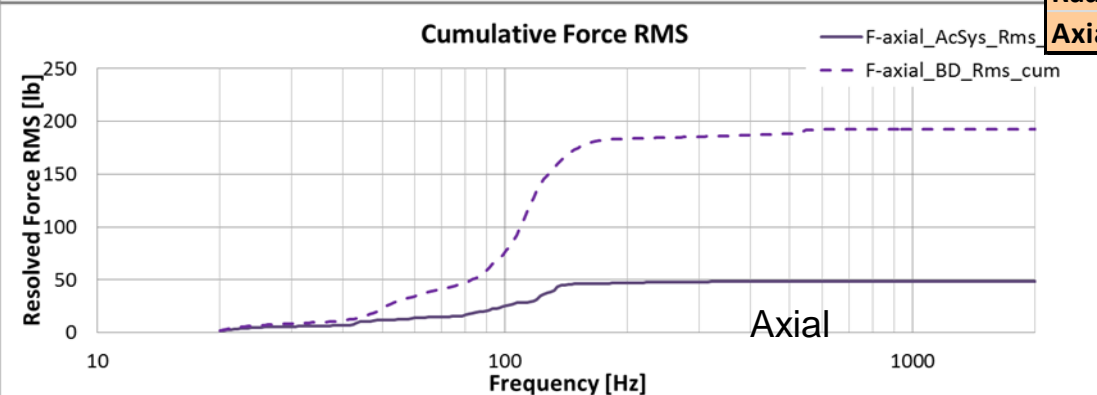
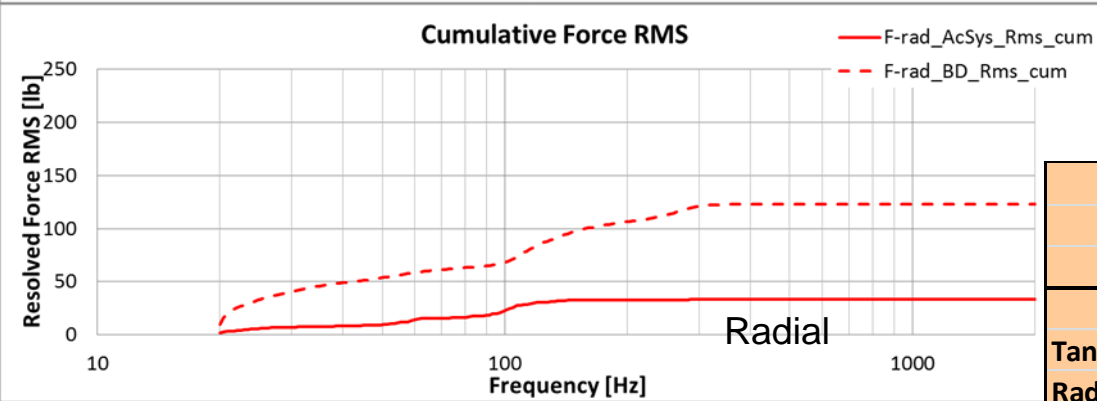
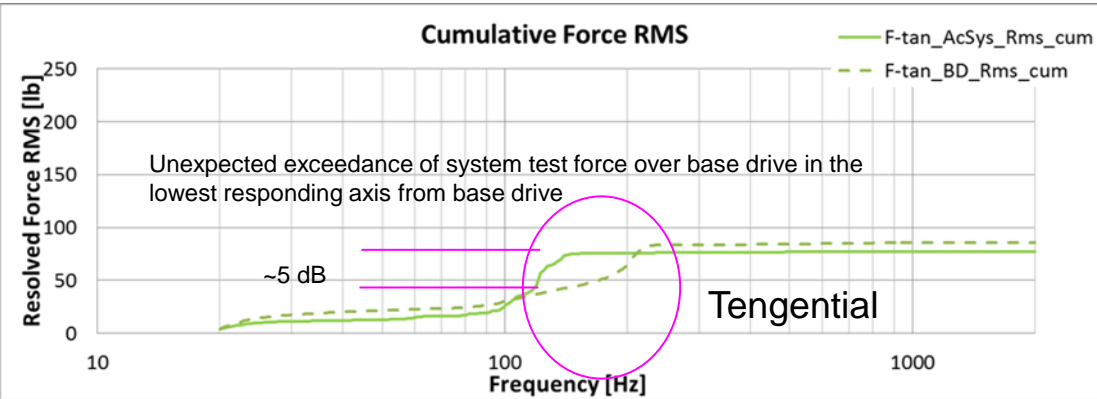

Compared:

Cumulative RMS force plots

- Resolved force data acquired during the base drive test response.
- Resolved force data acquired during the system level acoustic test.

	3 σ Random Load Factor		Load Factor Ratio	Percent Difference
	Base Drive [g]	System Response [g]		
Tangential	9.2	8.2	1.1	12.2%
Radial	13.2	3.6	3.7	266.7%
Axial	20.6	5.2	4.0	296.2%

The base drive overall response exceeded the system level by a factor of approximately 4 in two axes of vibration



Validation of Reaction Forces Estimated at the Base of Equipment using a Finite Element Based Method

- During the system acoustics tests forces were measured in three directions.
 - *There were four load cells at the base of the equipment. Each load cell provided a measurement in three directions. 12 channels of data were acquired at the base of one box in each of 5 test cases.*
 - *Tests 1,2,3 acquired force data at the base of box 1 at three different acoustic levels of excitation. Tests 1-3 represented our heavy configuration of hardware including boxes 1, 2, 3, and 4 on the tandem shelf. (Test 1 comparisons presented)*
 - *Tests 4 and 5 acquired force data at the base of box 3 at two different acoustic levels of excitation. Tests 4 and 5 represented our light configuration of hardware including only box 1 and box 3 on the tandem shelf.*
- Estimated reaction forces at the base of box 1 using a finite element based approach are compared to the measured at the base is provided.
- Kolaini et al [2012] pointed out that estimated forces from FEM analyses may prove to be a useful guide refinement of test criteria.
- Estimated acceleration on the primary structure panel are also presented as a system level validation that the damping assumption was a fair fit for all the response data.



Acceleration Response Example Comparison FEM to Measured on Vehicle Panel

Using the patch method to apply a Diffuse Acoustic Field (DAF) forcing function to the primary structure vehicle panel.

- Blue → measured response
 - Red → FEM response
- (Test 1 comparisons presented)

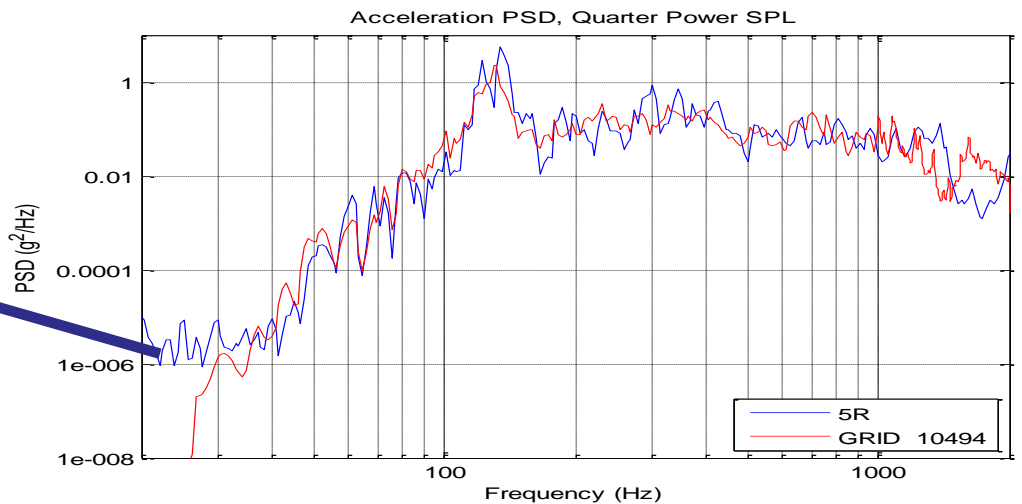
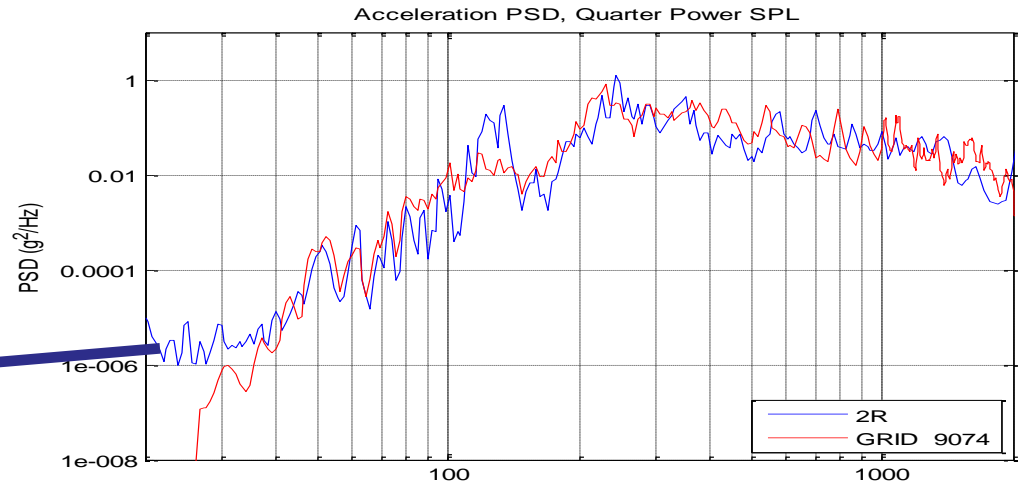
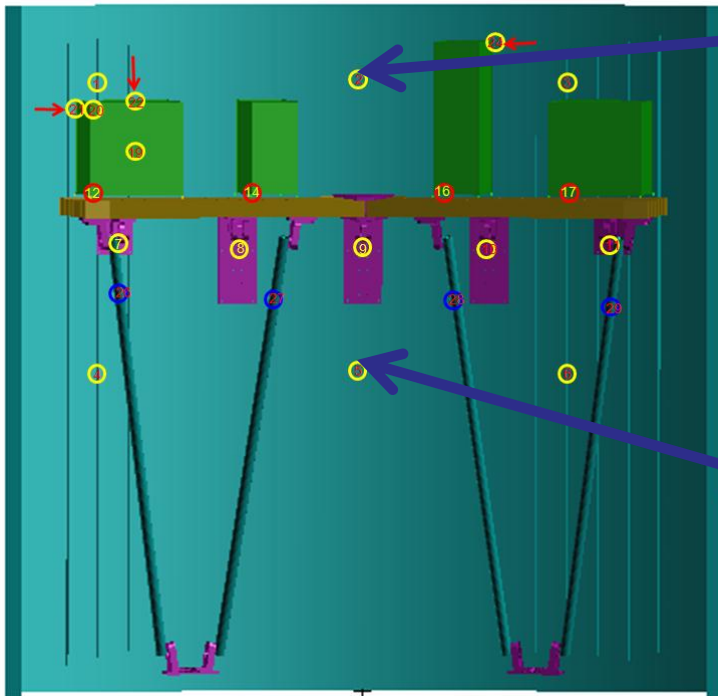



Force Response Example Comparison FEM to Measured at Equipment Base IF

Using the patch method to apply a DAF forcing function at test 1 levels to the primary structure vehicle panel.

- Solid → Measured response
- Dashed → FEM response estimate

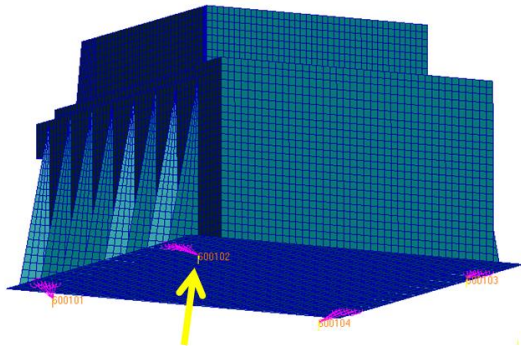

FEM based estimate of interface forces may be adequate to guide development of vibration test criteria with less conservatism.

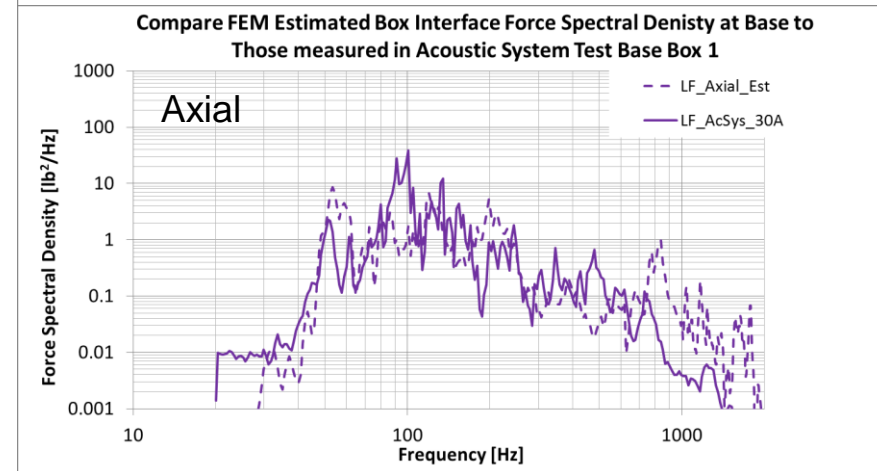
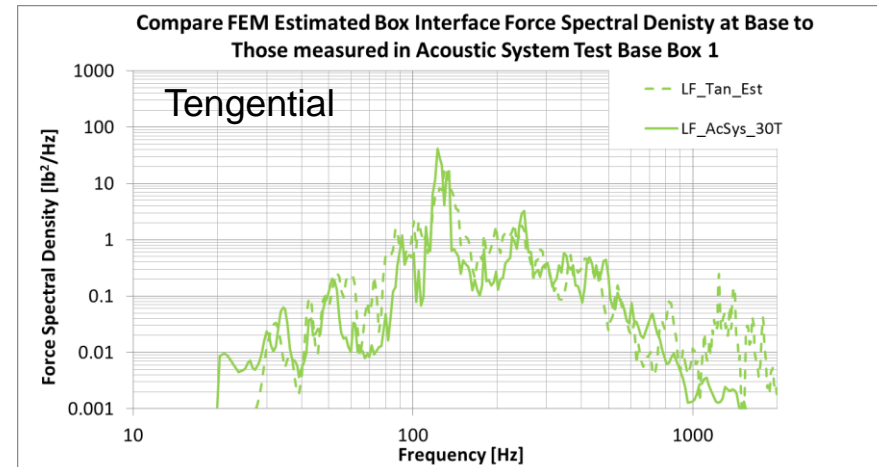
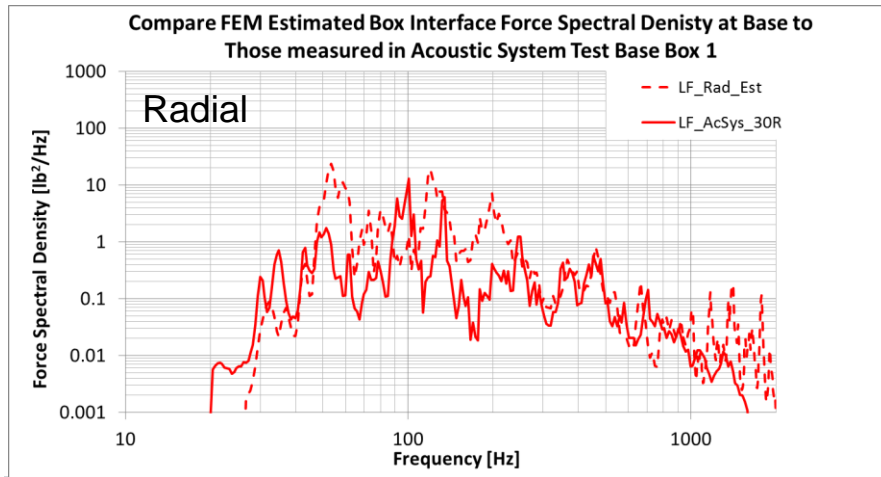

(Test 1 comparisons presented)



Acceleration Response Example Comparison FEM to Measured on Vehicle Panel

Test 1 exposed the heavy configuration of the tandem shelf with 4 boxes to lower level acoustic excitation.

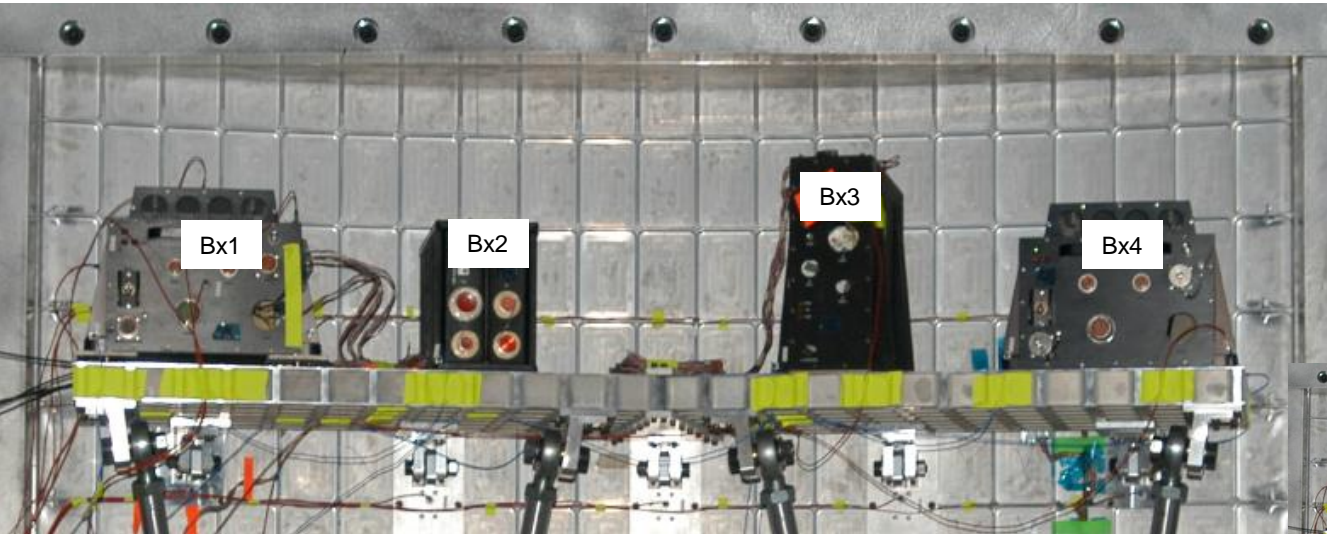

Strut numbers appear below.

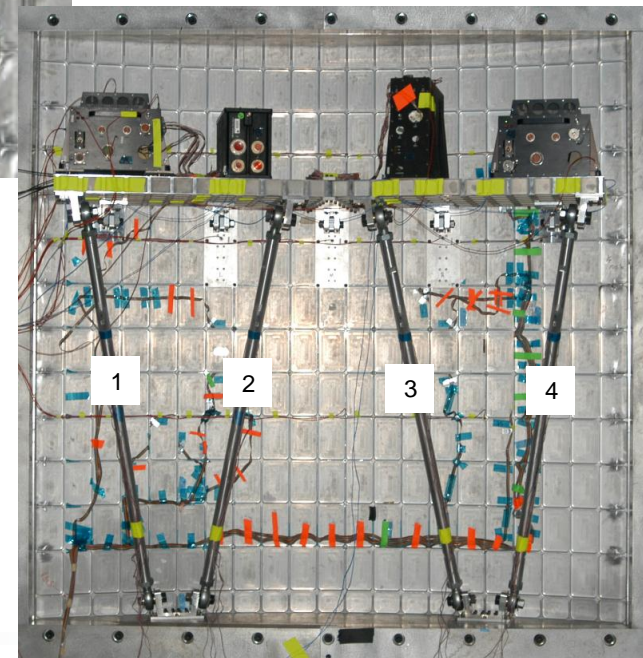

During test 1 a set of 4 tri-axial force transducers were located at the base of box 1

Kistler 9017A tri-axial load rings installed between avionics box and the orthogrid shelf.





Validation of Element Forces Estimated in Secondary Structure Struts using a Finite Element Based Method

Each of 4 struts was instrumented with 4 uniaxial strain gauges aligned with the long axis of the strut.

The average of the pairs (A-C, & B-D) provides a strain proportional to the Axial load.

The difference between the pairs provides a strain proportional to bending moment.

- For a given average micro-strain (-10.276in/in /1.00E+06)
- Cross-sectional area= 0.981748
- $E_{al} = 1.00E+07$
- $E = \sigma / \epsilon$
 $\sigma = 102 \text{ psi}$
- $\sigma = P/A$ (since axial load only, no bending)
 $P = (102 \text{ psi}) * (0.981748 \text{ in}^2)$
 $P = 100.9 \text{ lb}$

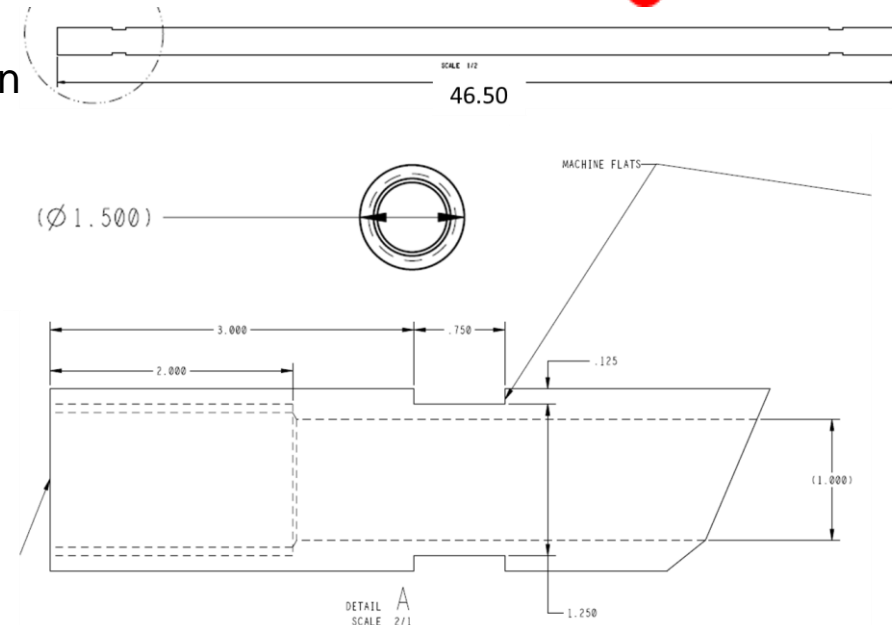
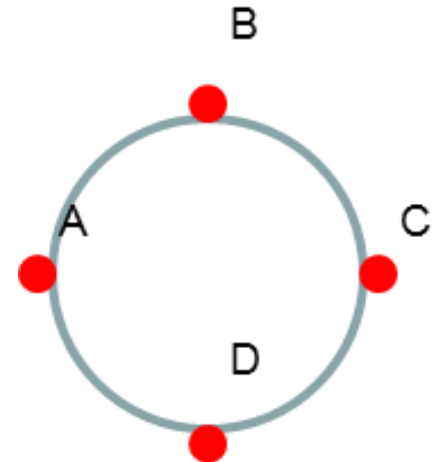



Force Response Example Comparison FEM to Measured Axial Force In Strut

Shelf Test 1 Axial Strut Force Spectral Density

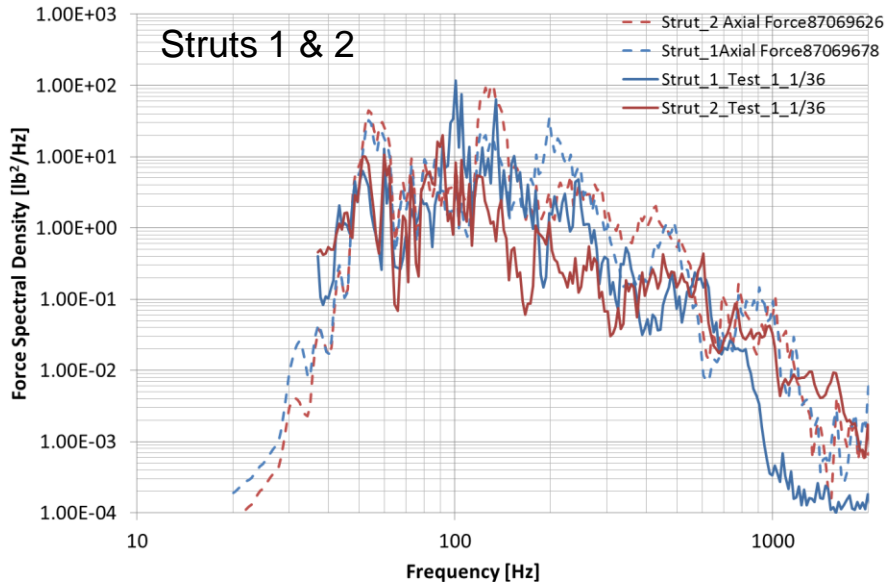

Shelf Test 1 Axial Strut Force Spectral Density

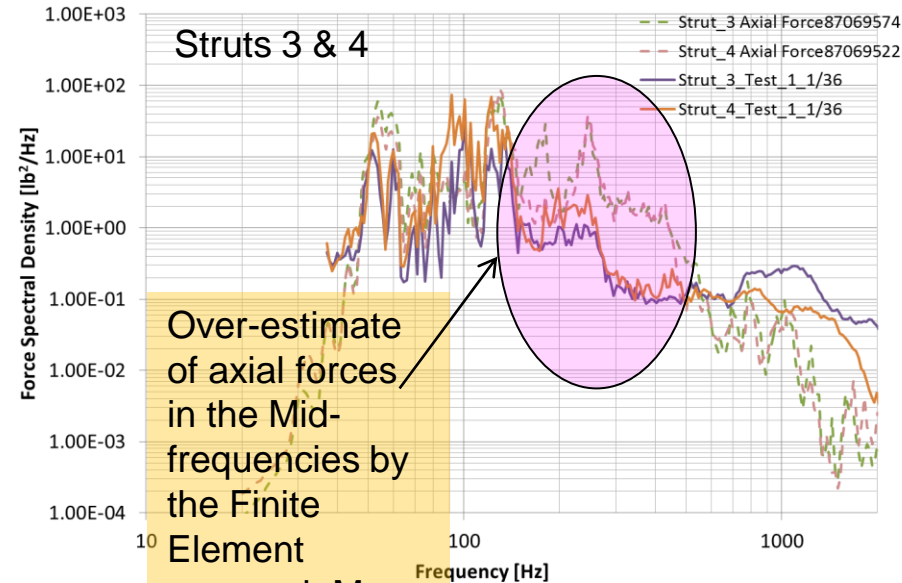

A matrix of strain measurements:

1. Distributed circumferentially
2. Located at the same location along the length of each strut

Used to indirectly measure the axial and bending forces in the struts that support the tandem shelf.

- The axial strut forces compared reasonably with finite element analyses. There were some noise issues that may have been related to free-play nonlinearities.
- Lumped mass assumption for 3 of 4 electronics boxes may contribute to the over estimate of axial forces in the mid-frequencies by the finite element approach.



Validation of Element Forces Estimated in Secondary Structure Struts using a Finite Element Based Method

Lumped mass assumption for 3 of 4 electronics boxes.

Model permitted effective mass of box 1 to diminish with increasing frequency. Not so for boxes 2, 3, & 4.

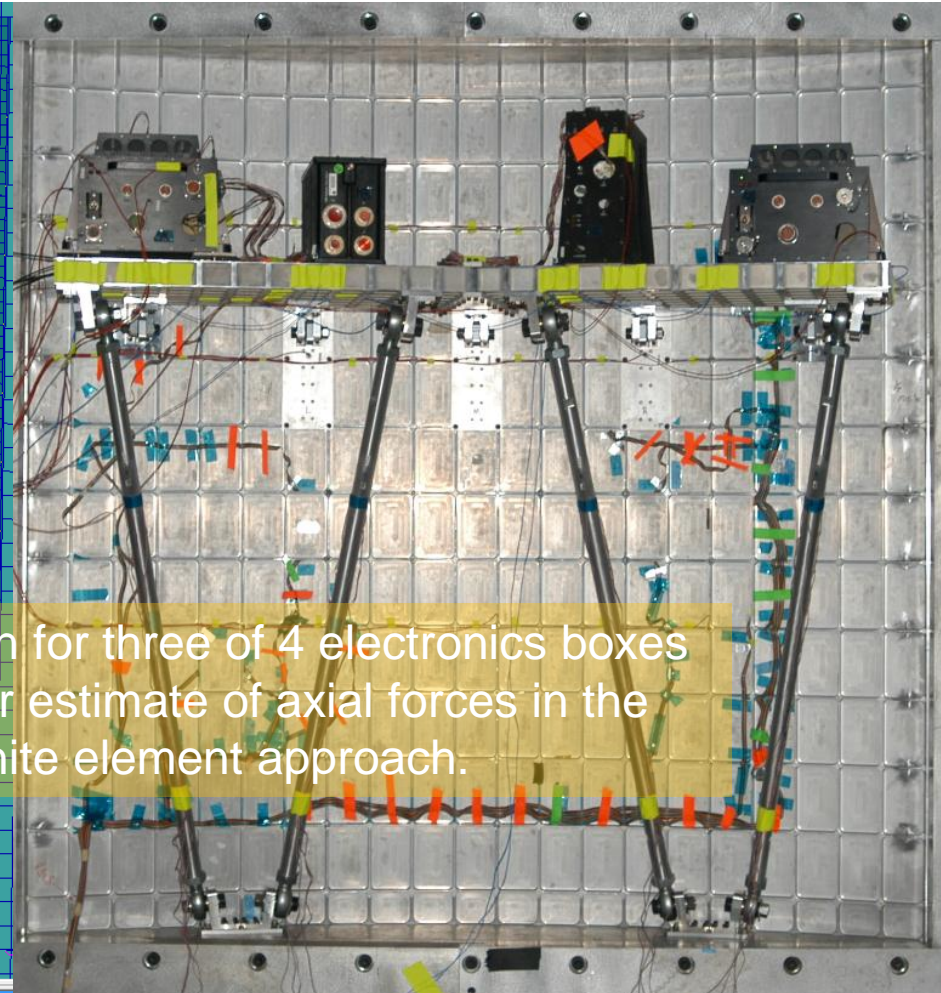
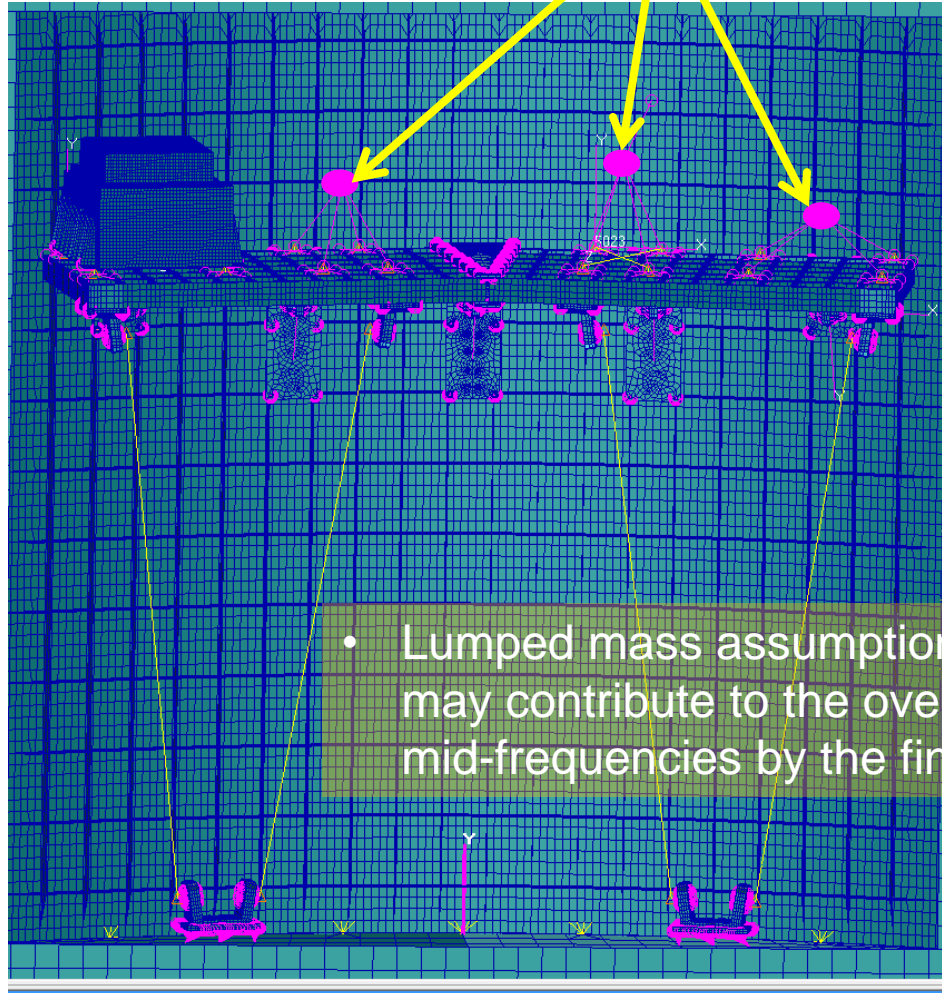

- Lumped mass assumption for three of 4 electronics boxes may contribute to the over estimate of axial forces in the mid-frequencies by the finite element approach.



Force Response Example Comparison FEM to Measured Bending Moment In Strut

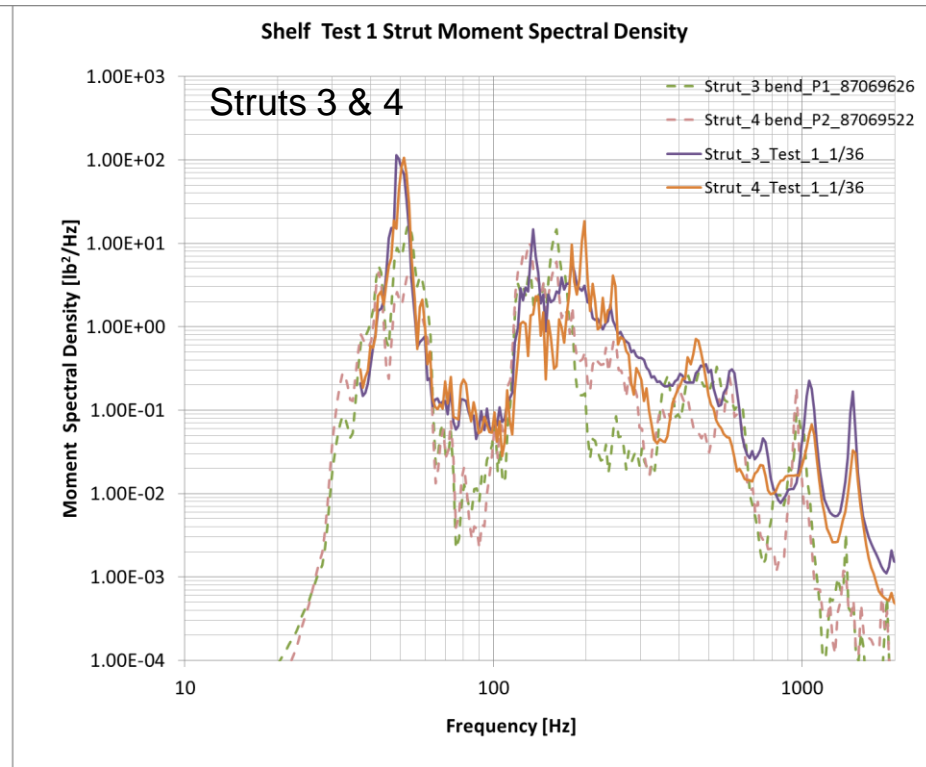
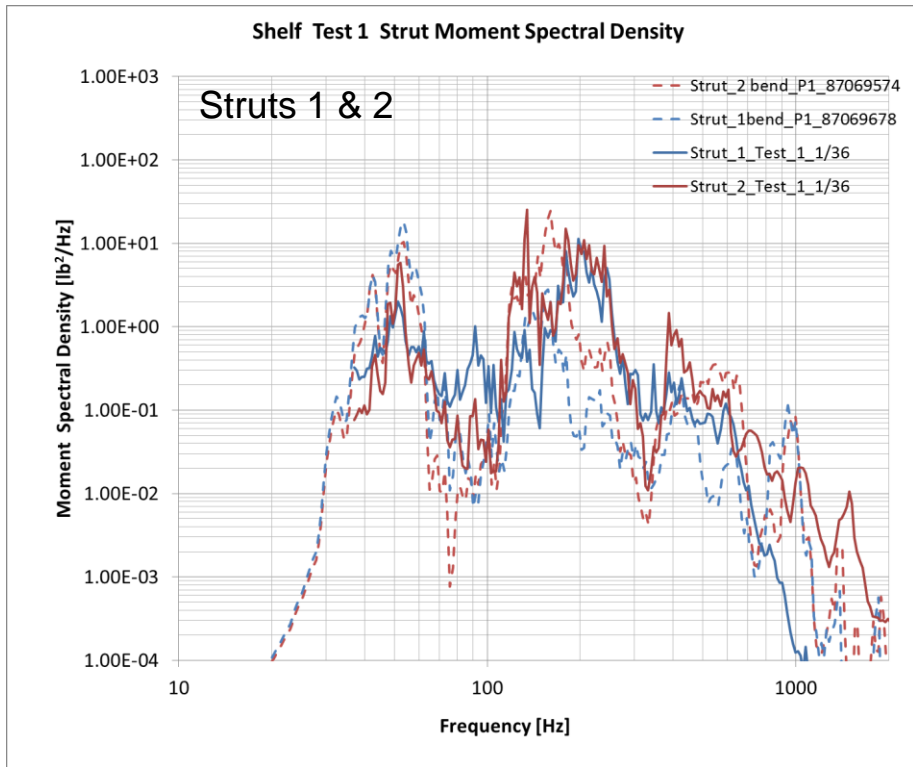

A matrix of strain measurements:

1. Distributed circumferentially
2. Located at the same location along the length of each strut

Used to indirectly measure the axial and bending forces in the struts that support the tandem shelf.

The moments compared very favorably with results from finite element analyses



Conclusions and Forward Work

- The Conservatism in Typical Vibration Tests was Demonstrated
 - *Vibration test at component level produced conservative force reactions by approximately a factor of 4 (~12 dB) as compared to the integrated acoustic test in 2 out of 3 axes.*
- Reaction Forces Estimated at the Base of Equipment Using a Finite Element Based Method were Validated
 - *FEM based estimate of interface forces may be adequate to guide development of vibration test criteria with less conservatism.*
- Element Forces Estimated in Secondary Structure Struts were Validated
 - *Finite element approach provided best estimate of axial strut forces in frequency range below 200 Hz where a rigid lumped mass assumption for the entire electronics box was valid.*
 - *Models with enough fidelity to represent diminishing apparent mass of equipment are better suited for estimating force reactions across the frequency range.*
- Forward Work
 - *Demonstrate the reduction in conservatism provided by*
 - Current force limited approach
 - An FEM guided Approach
 - *Validate proposed CMS approach to estimate coupled response from uncoupled system characteristics for vibroacoustics. (Dr. Robert B. Davis MSFC/ER41)*



References

- Blake, R. E., "The Need to Control the Output Impedance of Vibration and Shock Machines," Shock and Vibration and Associated Environments, Bulletin No. 23, 1954.
- Chang, K. Y. and Scharon, T.D., "Verification of Force and Acceleration Specifications for Random Vibration Tests of Cassini Spacecraft Equipment", Proc. of ESA/CNES Conference on Spacecraft Structures, Materials & Mechanical Testing, Noordwijk, NL, March 1996.
- Davis, R. B., Fulcher, C., "A Component Mode Synthesis Approach for Calculating the Vibroacoustic Response of Mass Loaded Panels," Presentation to the NESC Loads & Dynamics TDT Face-to-Face Meeting, NASA/MSFC/ER41, April 2013.
- Fraday, G., Duvall, L., Fulcher, C., LaVerde, B., Hunt, R., "Test-Anchored Vibration Response Predictions For An Acoustically Energized Curved Orthogrid Panel With Mounted Components," Proceedings of JANNAF's 8th Modeling and Simulation Subcommittee (MSS), December 2011.
- Heinricks, J. A., "Feasibility of Force-Controlled Spacecraft Vibration Testing Using Notched Random Test Spectra," Shock and Vibration Bulletin, No. 36, Pt. 3, January 1967.
- Kolaini, A., Kern, D., "New Approaches in Force-Limited Vibration Testing of Flight Hardware," Proceedings of 2012 Spacecraft and Launch Vehicle Dynamic Environments Workshop, Jet Propulsion Laboratory, June 2012.
- Kolaini, A., Kern, D., "A New Approach in Force-Limited Vibration Testing of Flight Hardware," 2012 Aerospace Testing Seminar, Jet Propulsion Laboratory, October 2012.
- Lazor, D. "AE01 Avionics Box Load Cell Verification Using Impact Testing," Draft Memo, NASA/MSFC/ET20, October, 2012.
- Murfin, W. B., "Dual Specifications in Vibration Testing," Shock and Vibration Bulletin, No. 38, Part 1, 1968, pp. 109-113.
- NASA-HDBK-7004C, Force Limited Vibration Testing, , November, 2012.
- Painter, G. W., "Use of Force and Acceleration Measurements in Specifying and Monitoring Laboratory Vibration Tests," Shock and Vibration Bulletin, No. 36, Pt. 3, January 1967.
- Peck, J., Smith, A., Fulcher, C., LaVerde, B., Hunt, R., "Development of Component Interface Loads on a Cylindrical Orthogrid Vehicle Section from Test-Related Models of a Curved Panel," Proceedings of 2011 Spacecraft and Launch Vehicle Dynamic Environments Workshop, June 2011.
- Ratz, A. G., "An Impedance Compensated Random Equalizer," Proceedings of the Institute of Environmental Sciences 12th Annual Technical Meeting, San Diego, CA, April 1966, pp. 353-357.
- Salter, J. P., "Taming the General-Purpose Vibration Test," Shock and Vibration and Associated Environments, Bulletin No. 33, Part III, 1964, pp. 211-217.
- Scharon, T. D., "Force-Limited Vibration Tests at JPL--A Perfect Ten", ITEA Jour. of Test and Evaluation, Vol. 14, No. 3, September 1993.
- Scharon, T. D., "Vibration-Test Force Limits Derived From Frequency-Shift Method", AIAA Journal of Spacecraft and Rockets 32(2), 1995, pp. 312-316.
- Scharon, T. D. and Chang K., Y., "Force Limited Vibration Testing of the CASSINI Spacecraft and Instruments", Proceedings of the Institute of Environmental Sciences, 43rd Annual Technical Meeting, 1997.
- Smith, A., Davis, R.B., LaVerde, B., Hunt, R., Fulcher, C., Jones, D., Band, J., "Calculation of Coupled Vibroacoustics Response Estimates from a Library of Available Uncoupled Transfer Function Sets," AIAA SDM April 2012.



Backup Slides



Force Response Example Comparison FEM to Measured at Equipment Base IF

Verification Results: Input point 1 : Input direction Z : Response direction Z
Less than 1% error for resolved forces in Z direction

Pleased with wave form and magnitude of resolved forces

Dir Z : Impact 1

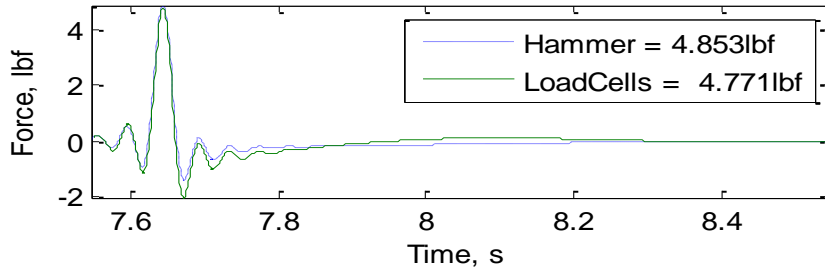

Dir Z : Impact 2

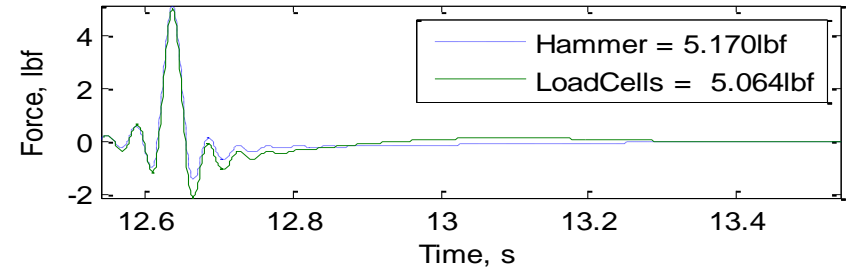

Dir Z : Impact 3

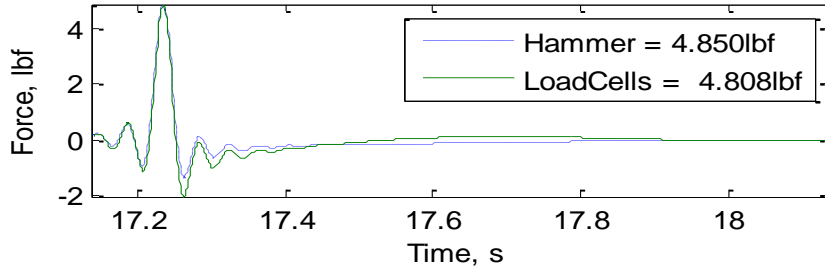

Dir Z : Impact 4

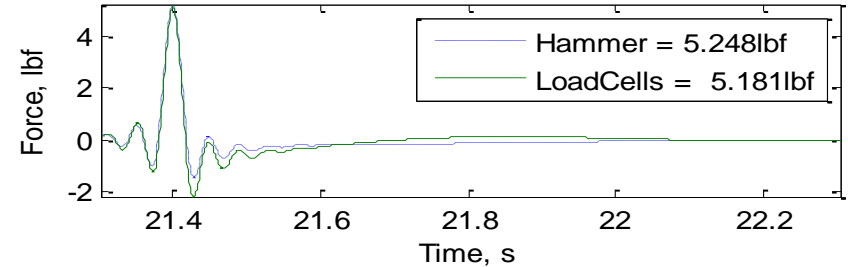

Dir Z : Impact 5

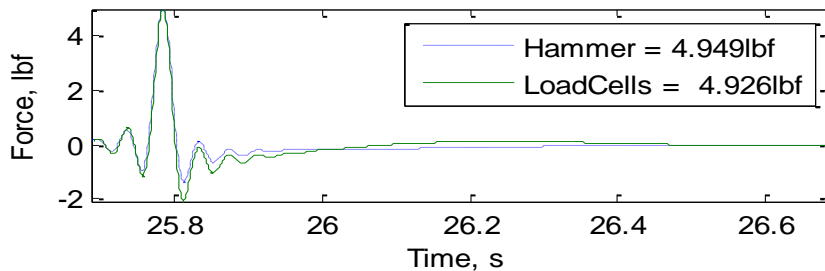

Dir Z : Impact 6

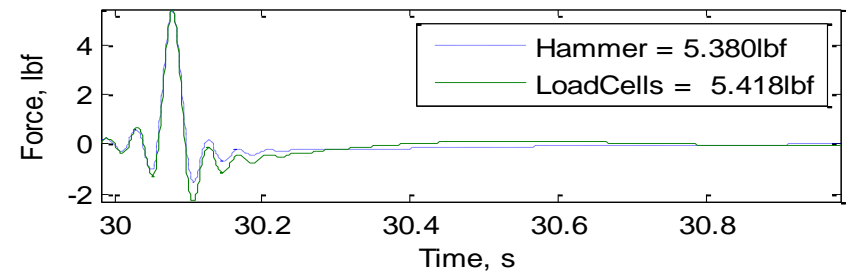



Force Response Example Comparison FEM to Measured at Equipment Base IF

Verification Results: Input point 2 : Input direction X : Response direction X
less than 10% error for resolved forces in X direction (under-predicted)

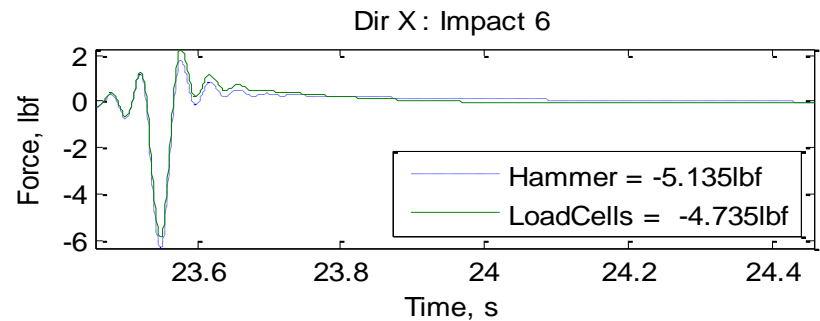
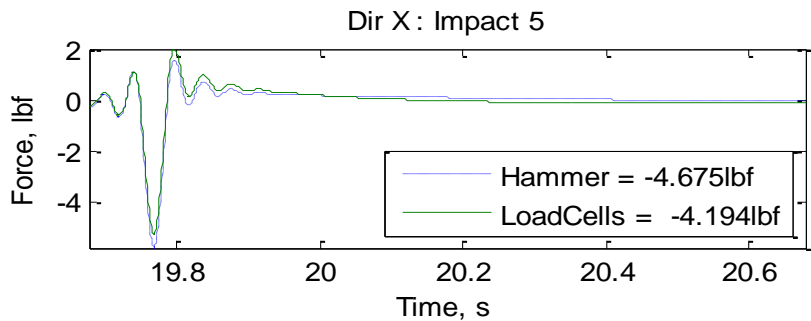
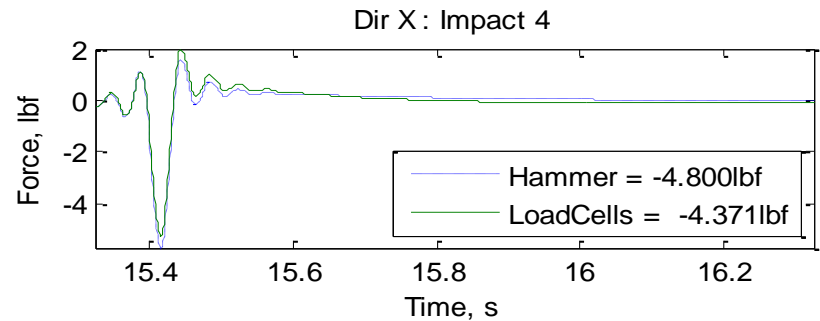
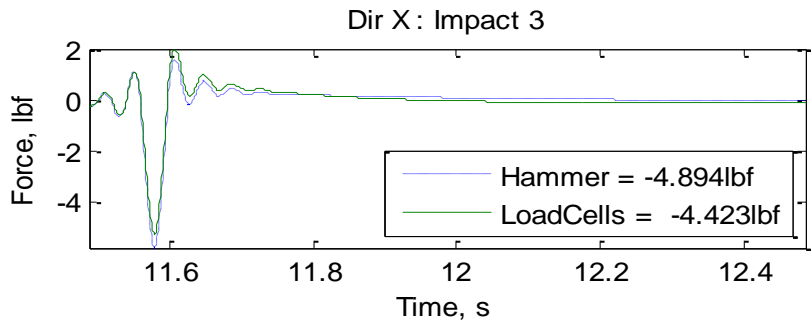
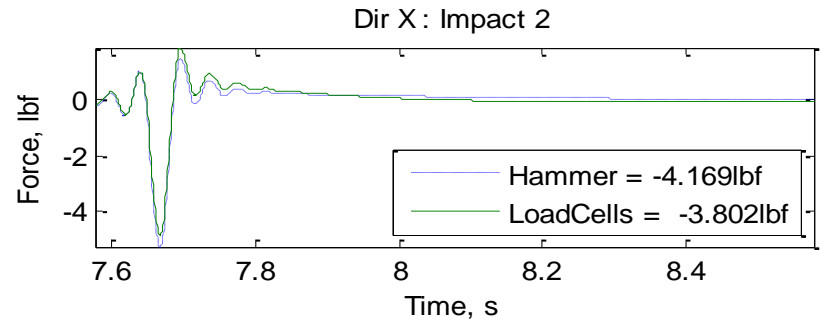
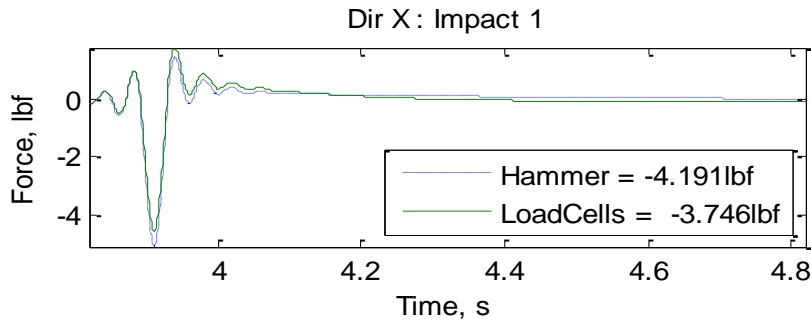



Force Response Example Comparison FEM to Measured at Equipment Base IF

Verification Results: Input point 3 : Input direction Y : Response direction Y
Less than 6% error for resolved forces in Y direction (under-predicted)

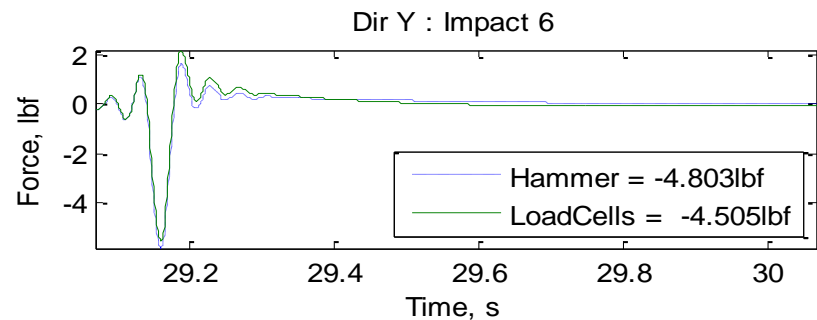
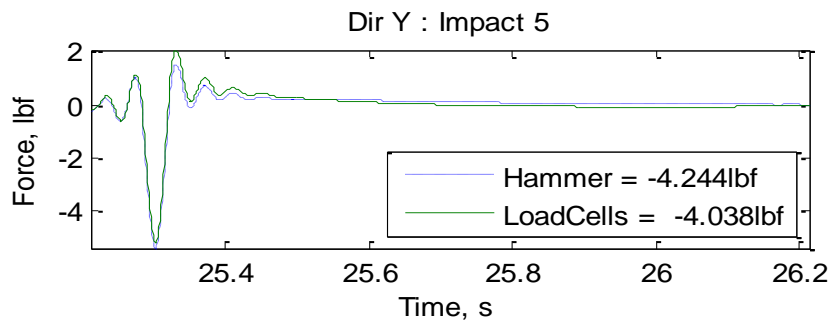
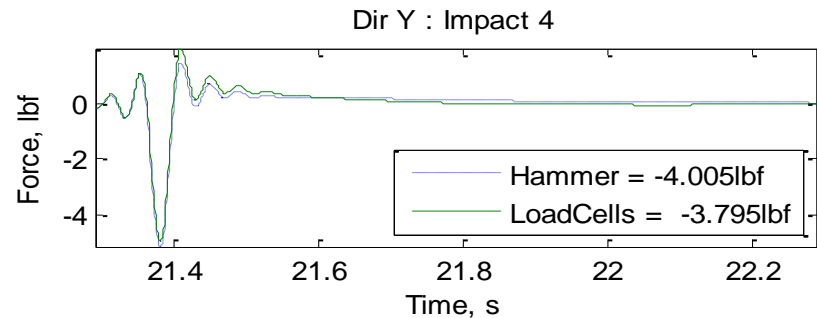
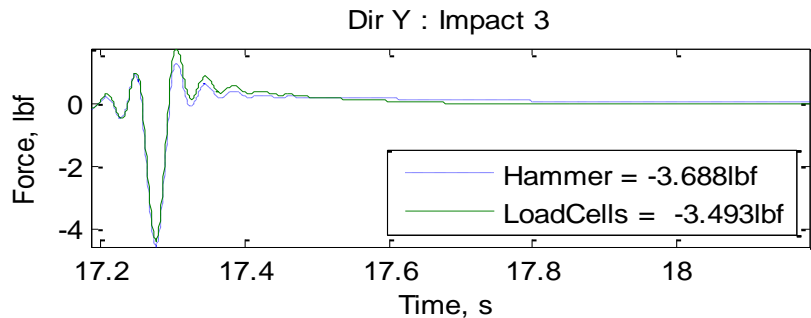
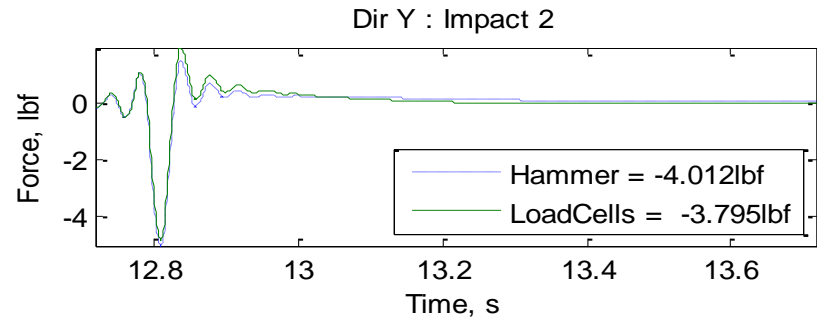
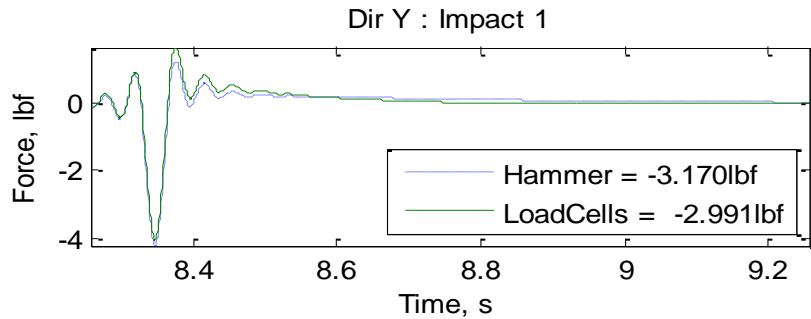



Acceleration Response Example Comparison FEM to Measured on Vehicle Panel

Test 3 exposed the heavy configuration of the tandem shelf with 4 boxes to full level acoustic excitation.

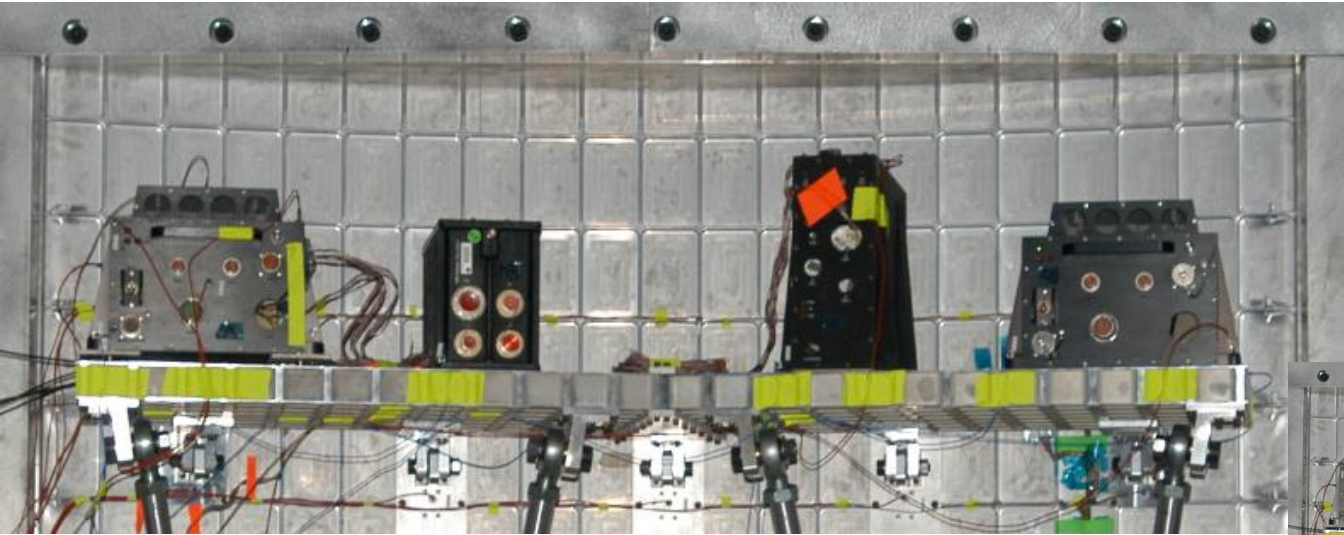

During test 3 a set of 4 tri-axial force transducers were located at the base of box 1

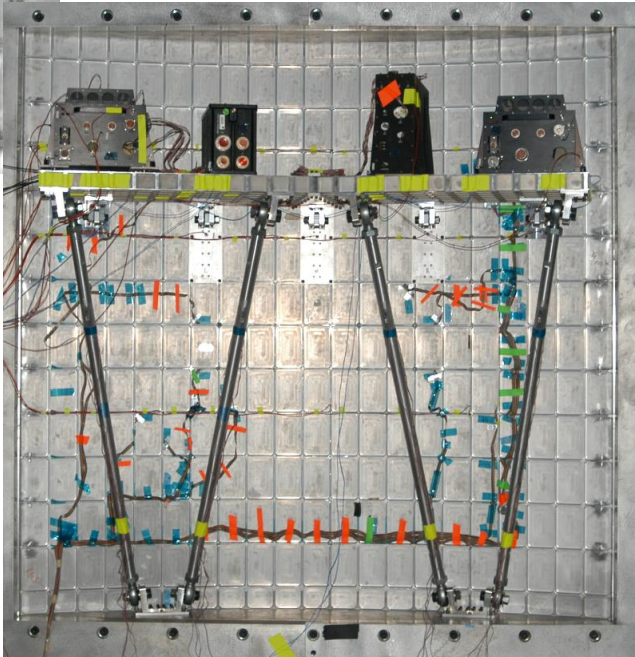

Kistler 9017A tri-axial load rings installed between avionics box and the orthogrid shelf.



Resolution of Forces and Strain Measurements from an Acoustic Ground Test

Andrew M. Smith
Vibroacoustics Specialist
Vehicle Loads and Strength Branch (EV31)
NASA Marshall Space Flight Center

Ronald Hunt, BRC Inc
Dynamics Loads & Vibroacoustics Specialist
ESSSA Contract Support to
Vehicle Loads and Strength Branch (ES22)
NASA Marshall Space Flight Center

Andrew Smith NASA/MSFC/
Vehicle Loads and Strength Branch (EV31)
4-6 June 2013
Andrew.M.Smith-2@nasa.gov
(256) 544-7319

Bruce T. LaVerde, ERC Inc
Vibroacoustics Lead Engineer
ESSSA Contract Support to
Vehicle Loads and Strength Branch (EV31)
NASA Marshall Space Flight Center

James M. Waldon
Jacobs Engineering,
Dynamics Loads & Vibroacoustics Specialist
ESSSA Contract Support to
Vehicle Loads and Strength Branch (EV31)
NASA Marshall Space Flight Centers

Bruce LaVerde ERC – Supporting
NASA/MSFC/
Vehicle Loads and Strength Branch (EV31)
4-6 June 2013
Bruce.T.Laverde@nasa.gov
(256) 961-2259

