

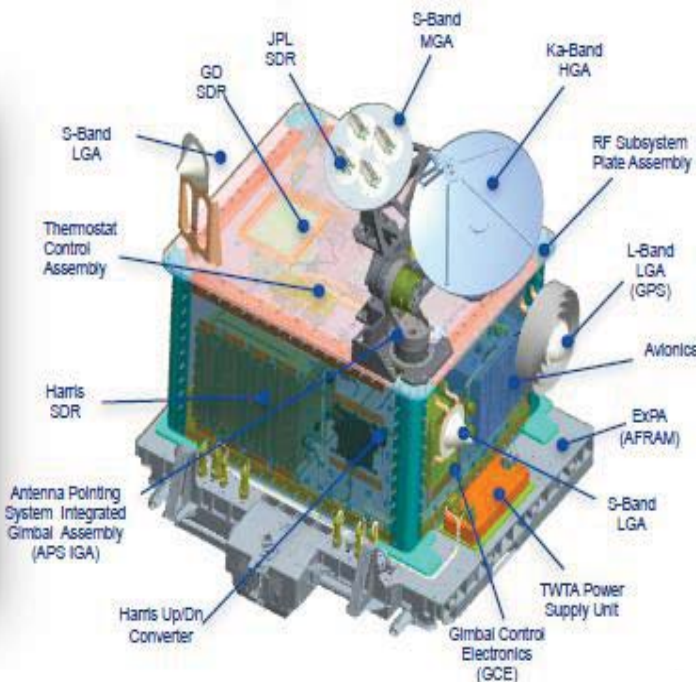

# Selected R&D Topics on Aerospace Communications at NASA Glenn Research Center



ACTS



ScaN Test Bed

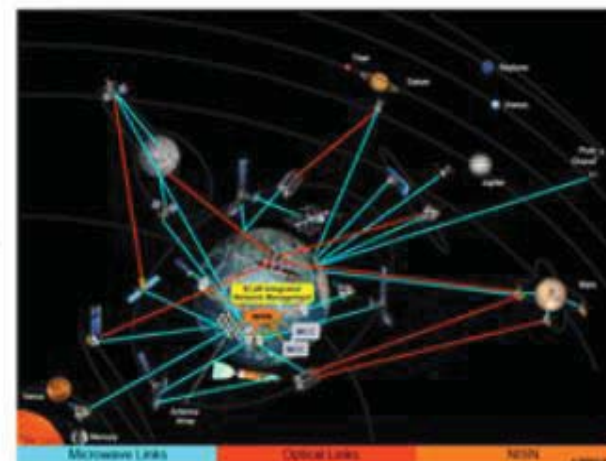

ScaN Next Generation Communications Architecture

Félix A. Miranda, Robert R. Romanofsky and James A. Nessel  
NASA Glenn Research Center, Cleveland OH 44135

NASA Glenn Research Center & ElectroScience Lab Technical Interchange Meeting  
The Ohio State University ElectroScience Laboratory  
February 24, 2014



## **Abstract**

This presentation discusses some of the efforts on communications R&D that have been performed or are currently underway at NASA Glenn Research Center. The primary purpose of this presentation is to outline some R&D topics to serve as talking points for a Technical Interchange Meeting with the Ohio State University. The meeting is scheduled to take place at The ElectroScience Laboratory of the Ohio State University on February 24, 2014



**RH Communications, Instrumentation and Controls Division**  
 Acting Division Chief: Dr. Mary V. Zeller  
 Acting Deputy Chief for Communications: Mr. Gene Fujikawa



**RHA Antennas and Optical Systems**  
 Chief: F.A. Miranda

Antenna Systems  
 Microwave Systems  
 Cryoelectronics  
 RF and Optical Propag.  
 Nanotechnology

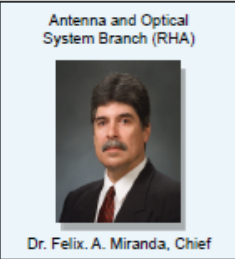

**RHD Digital Comm & Nav**  
 Chief: G. Fujikawa

Software Defined Radios  
 Model-Based Signal Process  
 Design, Simulation and Test  
 Digital and Wireless HW / SW  
 Prototyping  
 Advanced Navigation Tech.



**RHE Electronic Devices**  
 Chief: R.N. Simons

Space High Power TWT/SSPA  
 MW and Wireless Components  
 and Circuits  
 3-D Electromagnetic Modeling  
 Electronic Materials for Semicond.  
 & Vacuum Electronic Devices  
 Radiofrequency Photonics

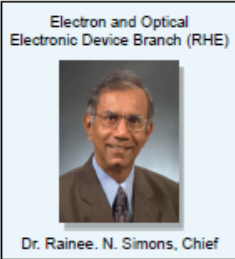

**RHN Networks and Architectures**  
 Chief: D.S. Ponchak

Aeronautical Comm Arch.  
 Network Technology  
 Communications Network  
 Architectures  
 Network-Centric Aero  
 Space-Based Protocols

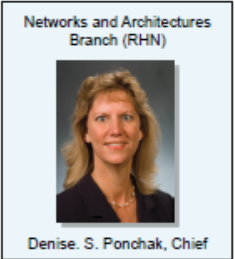

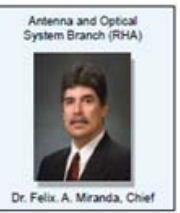

# Antenna and Optical Systems Branch (RHA)



## Overview

### Competencies

- Antenna Systems
- Microwave Systems
- RF (Ka-, V-, W-band) & Optical Propagation
- RF/Optical Communications
- Cryo-Electronics
- Nano-antennas and Nano-electronics

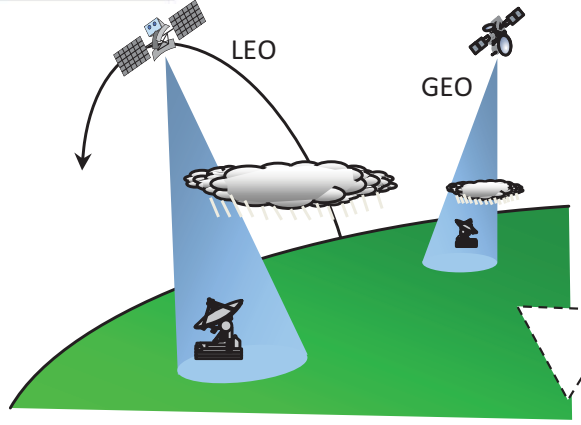

- Ka-Band Atmospheric Calibration
- RF and Optical Propagation Research

Material → Phase Shifter → Reflectarray

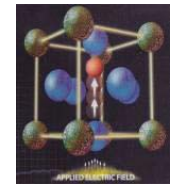

$Ba_xSr_{1-x}TiO_3$  Crystal

Thin Film Phase Shifter

Transmit or Receive Feed

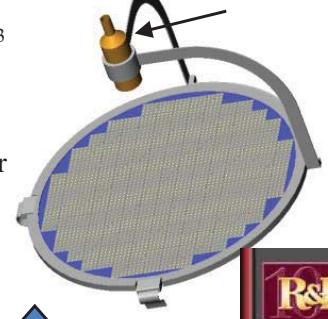

616 Element Reflectarray (12 in. diameter)

(2010 R&D100 Award Winner)



### Advanced Phased Arrays

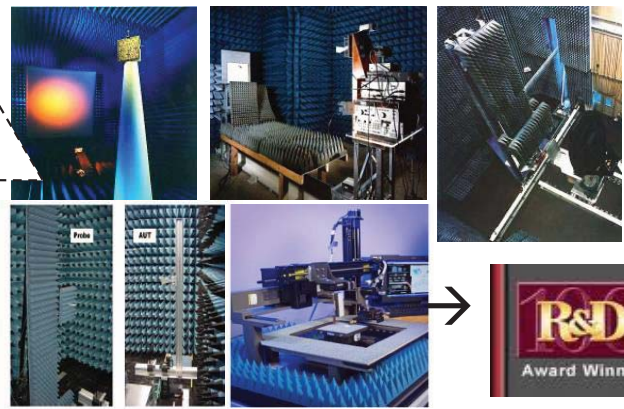

## Products

### Phased Arrays

- Bit Error Compensation Techniques
- Alternative Sub-Systems Designs
- Optimal Modulation Schemes

### Game Changing Technologies

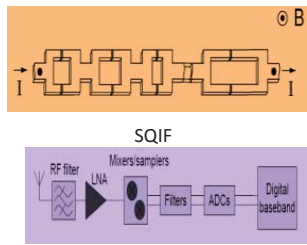

Tunable Receivers

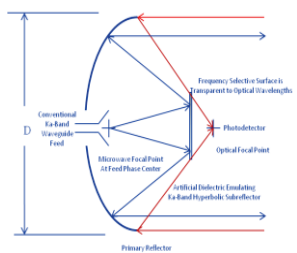

RF/Optical Shared Aperture Antennas

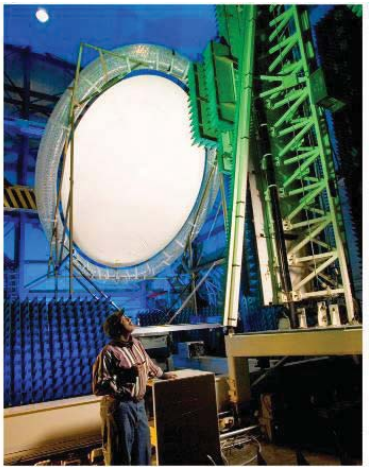

### Large Aperture Inflatable/Deployable Antennas

- Polymer Membranes
- Shape Memory Alloys
- Mesh Antennas

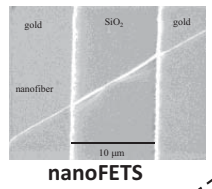

nanoFETS



(2010 R&D100 Award Winner)

### Antenna Characterization Facilities

- Compact Range
- Near Field Range
- Far Field Range
- Cylindrical Near Field Range
- Near Field Probe Station Scanner\*

\*(2007 R&D100 Award Winner)



Gene Fujikawa, Chief

# Digital Communication and Navigation

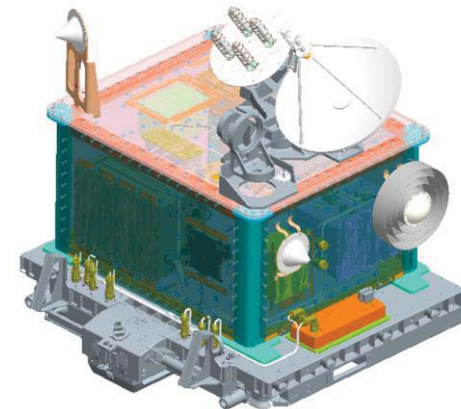
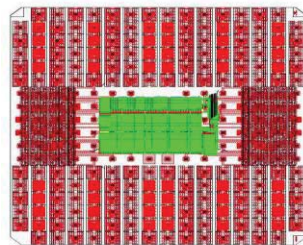

- High Speed Signal Processing
- Wireless and Microelectronic devices for communications



- Space Telecommunications Radio System (STRS)
- SDR Waveform development
- STRS-compliant Hardware and Software

- **Software-Defined and Cognitive Radio**
- **EVA Radio and Navigation**
- **STRS**
- **Integrated Audio**
- **SCaN Testbed Experiments**
- **Digital and Wireless Comm**
- **Signal Processing Research**



- Conformal audio microphone arraying
- EVA Radio and Surface Navigation
- Complex Analysis and Methods
- Computer modeling and simulation tools

- SCaN Testbed Flight Radio Experiments and Demonstrations
- Desert Research and Technology Studies (DRATS)





# Electron & Opto-Electronic Device Branch



Electron and Optical Electronic Device Branch (RHE) NASA and Space Administration

LRO and CoNeCT TWTA

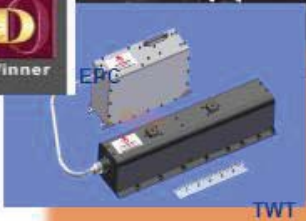

1.6kW LRO TWT

## Expertise

- High Power/HE TWTA/ SSPA
- Microwave and Wireless Components and Circuits
- 3-D Electromagnetic Modeling
- Electronic Materials for Semiconductor and Vacuum Electronic Devices
- Radiofrequency Photonics



## High Temp Wireless Circuit

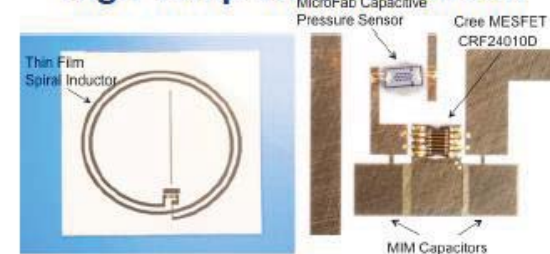

• 100 MHz Wireless Pressure Sensor System • Close up of MESFET, capacitive pressure sensor, and MIM capacitors.

## High Data Rate Communications

Validation of bandwidth efficient modulation techniques at Ka-band using software defined modem technology

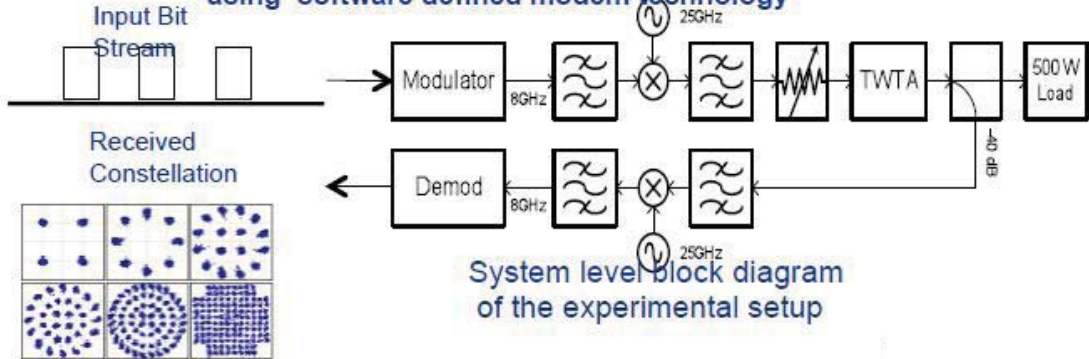

## Secure/High Data Rate Comm. Using V-band (71-76 GHz) and W-band (81-86 GHz) Frequencies

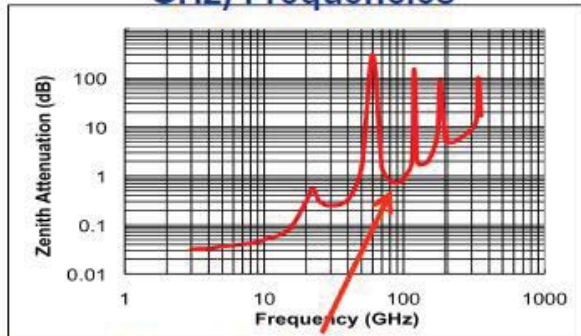

Atmospheric Window



Networks and Architectures Branch (RHN)

# Networks and Architectures Branch Major Technology Initiatives



## Expertise

- Comm-Network Arch / Analysis
- Aeronautical Comm.
- Comm-Net Mod-Sim
- Network-centric Ops for Space and Aeronautics
- Internet Protocols & Standards Development
- Mobile Network Security
- Interoperability Testbeds & Flight Experiments
- Network Management



## NextGen CNS Test Bed

Surveillance and communications test bed to evaluate 802.16e aeronautical mobile network profile and channelization of 5.1 GHz spectrum for airport surface applications.

**Delay Tolerant Networking Protocol**  
Enable an open method of performing network-based store-and-forward communications.

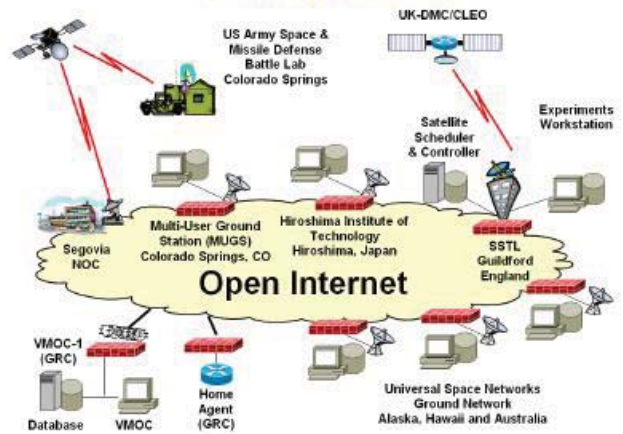

## UAS in the NAS Project

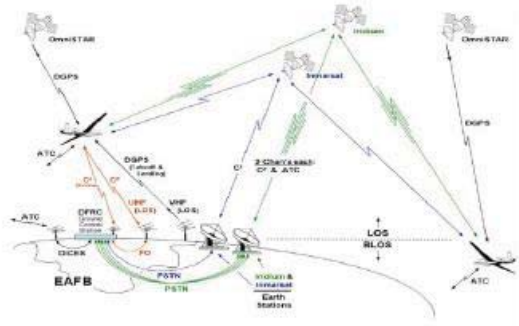
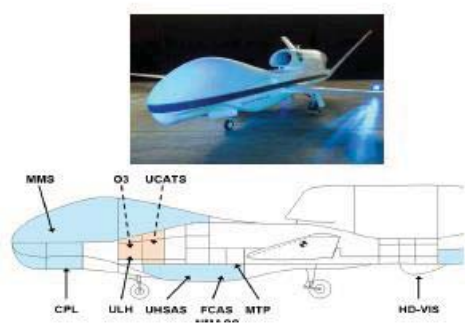

**Real-time and Store and Delivery  
of Unmanned Airborne Vehicle Sensor Data**



## **Some Examples of Technology Evolution from Idea to Deployment**





# Antenna Technology



# Ferroelectric Reflectarray Antenna— The Road From Idea to Deployment

## Modified 615 Element Scanning Ferroelectric Reflectarray: 2005-2009

Prototype antenna with practical low-power controller assembled and installed in NASA GRC far-field range for testing. Low-cost, high-efficiency alternative to conventional phased arrays

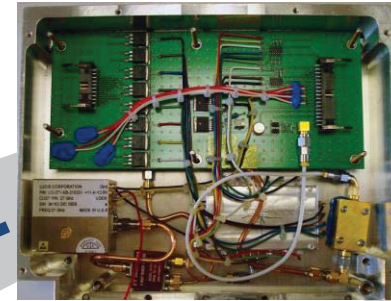

MISSE-8 ISS Space Exp.; STS-134, 05/16/ 2011



2010

## Cellular Reflectarray:

2010 Derivative attracts attention for commercial next generation DirecTV, etc. applications

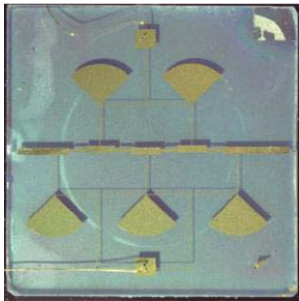

Thin film ferroelectric phase shifter on Magnesium Oxide

## Practical Phase Shifters : 2003-2004

Novel phased array concept based on quasi-optical feed and low-loss ferroelectric phase shifters refined. 50 wafers of  $Ba_{0.5}Sr_{0.5}TiO_3$  on lanthanum aluminate processed to yield over 1000 ferroelectric K-band phase shifters. Radiation tests show devices inherently rad hard in addition to other advantages over GaAs

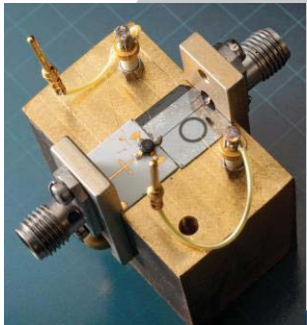

First Ku-Band tunable Oscillator based on thin ferroelectric films

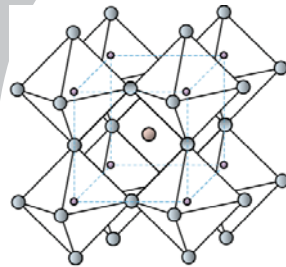

Parent crystal: Strontium Titanate

## Fundamental Research: 2000-2003

Agile microwave circuits are developed [using room temperature Barium Strontium Titanate ( $Ba_{0.5}Sr_{0.5}TiO_3$ )], including oscillators, filters, antenna elements, etc., that rival or even outperform their semiconductor counterparts at frequencies up to Ka-band

## Seedling Idea: 1995-1999

Basic experiments with strontium titanate at cryogenic temperatures suggest loss tangent of ferroelectric films may be manageable for microwave applications

# Beach Ball Antenna – The Road From Idea to Deployment



Prototype Inflatable Radome Antenna System at GRC



## In The Field: 2009-2010

*Popular Science's – Invention of the Year 2007, listed as one of the "Inc. 500: The Hottest Products" of 2009. GATR continues to field units which enable high-bandwidth Internet, phone and data access for deployments and projects in Afghanistan, South Africa, South America, Haiti, Korea, as well as assisting hurricane disaster recovery here on our own soil.*

## First Practical System: 2008

*Through the help of NASA Glenn, the SCAN project, a reimbursable Space Act Agreement, material refinements through Air Force Research Laboratory (AFRL) and the Space and Missile Defense Command (SMDC), GATR Technologies markets World's first FCC certified inflatable antenna*



2011



2011



2010

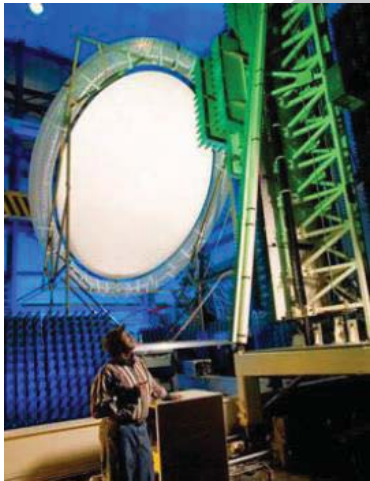

4m x 6m parabolic membrane reflector derived from solar concentrator in GRC near-field



0.3 meter prototype Membrane reflector

## Fundamental Research: 2004-2007

*Designed and fabricated a 4x6m off-axis inflatable thin film antenna with a rigidized support torus. Characterized the antenna in the NASA GRC Near Field Range at X-band and Ka-band. Antenna exhibited excellent performance at X-band. Ka-band surface errors are understood.*

## Seedling Idea: 2004

*Circa 2004 need for large aperture deployable antenna identified for JIMO and Mars Areostationary relay platform. Antenna technology adapted from 1998 Phase II SBIR solar concentrator project.*



# RF Propagation

# RF Propagation – The Road From Idea to Deployment

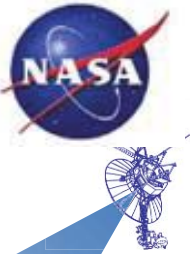

## mm-wave Propagation Studies: 2012-Future

GRC undertakes expansion of mm-wave frontier via propagation activities in the Q/V/W bands

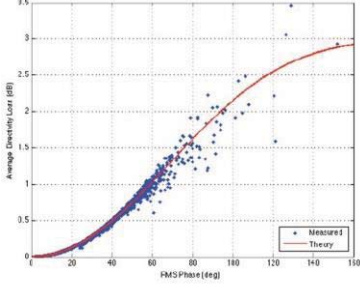
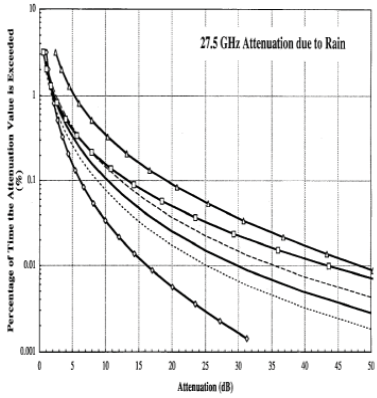

Phase measurements implemented in array loss predictions



Q-band Radiometer

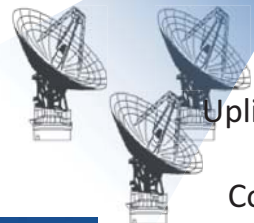

Uplink Array/ Rain Fade Compensation



Evolution of GRC Propagation Terminals



Guam (SN)



White Sands, NM (SN)



Goldstone, CA (DSN)

## Real-Time Compensation: 2012-2016

SCaN funded effort to integrate real-time compensation techniques into NASA network operations

## Atmospheric Phase Studies: 2004 – Present

Characterization of atmospheric phase noise is studied to identify suitable sites for Uplink Arraying Solution to large aperture 70-m class antenna issues with Deep Space Network. GRC, in collaboration with JPL and GSFC, leads the characterization of atmospheric-induced phase fluctuations for future ground-based arraying architecture

## Atmospheric Attenuation Studies: 1993 – 2002

Propagation studies were undertaken by NASA to determine the effects of atmospheric components (e.g., gaseous absorption, clouds, rain, etc.) on the performance of space communication links operating in the Ka-band. Sites throughout the Continental US and Puerto Rico were characterized.

ACTS Propagation Data instrumental in development of ITU-R attenuation models



ACTS Propagation Terminal

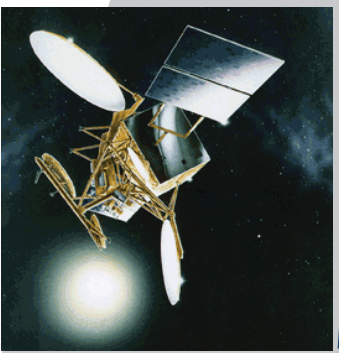

ACTS Satellite

# NASA Glenn Research Center



## RF Propagation Studies

GRC has proven its role as lead center for NASA in the area of propagation characterization for space communications through expansion of funded efforts.



**Svalbard**  
• Gaseous Absorption  
• Brightness Temperature



**Madrid, Spain**  
• Phase



**GRC Testbed**  
**Cleveland, OH**



**Guam**  
• Gaseous Absorption  
• Brightness Temperature  
• Rain Fade  
• Phase  
• Site Diversity



**Canberra, Australia**  
• Phase



**Goldstone, CA**  
• Gaseous Absorption  
• Rain Fade  
• Phase



**White Sands, NM**  
• Gaseous Absorption  
• Rain Fade  
• Phase



# Software Define Radio



# Software Defined Radios – STRS Architecture: The Road From Idea to Deployment

2010 – SCaN Testbed Flight Radios Developed by General Dynamics, Harris Corp., JPL

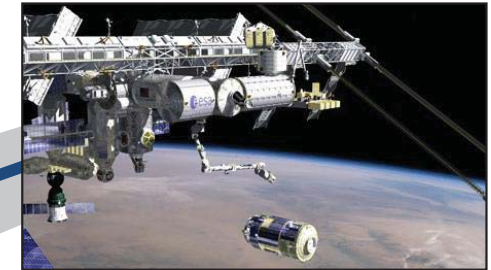
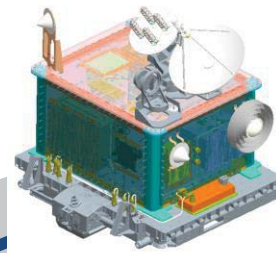
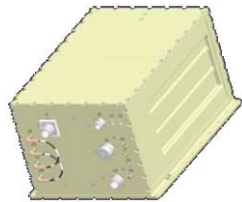

SCaN Testbed Launch to ISS – July 20, 2012

**Technology Experiments: 2013 – 2017**

**Flight Technology Demonstration: 2008 – 2012**

Communications, Navigation and Networking re-Configurable Testbed (CoNNECT) Project, now known as SCaN Testbed, established to perform system prototype demonstration in relevant environment (TRL-7)

**SDR Technology Development: 2005 – 2007**

Development of design tools and validation test beds.  
Development of design reference implementations and waveform components.  
Establish SDR Technology Validation Laboratory at GRC.  
NASA/Industry Workshops conducted

**Open Architecture Development and Concept Formulation: 2002 – 2005**

Develop common, open standard architecture for space-based software defined radio (SDR) known as Space Telecommunications Radio Architecture (STRS).  
Allow reconfigurable communication and navigation functions implemented in software to provide capability to change radio use during mission or after launch.  
NASA Multi-Center SDR Architecture Team formed.

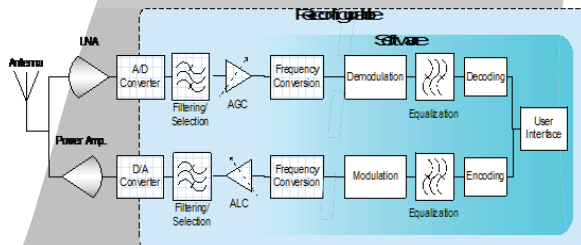





# **Traveling-Wave Tube Amplifiers (TWTA)**

# High Power & Efficiency Space Traveling-Wave Tube Amplifiers (TWTAs) - A Huge Agency Success Story



**200 Watt TWT**



**LRO TWT**



**CoNeCT TWT**



Q - V- & W-band TWTAs & Gbps Data Rates: 2012 & beyond

**100 Watt TWT**



**Lunar & ISS Missions: 2007-2011**

- *Delivered K-band 40 W space TWTAs to the Lunar Reconnaissance Orbiter & CoNeCT missions*

**Jupiter Mission – Higher FoM: 2004-2006**

- *Space qualified a Ka-Band TWT, output power 200 W, efficiency 62 %, mass 1.5 kg. Output power 20X higher than Cassini TWT and FoM is 133*

**Mars Mission – Higher Power & Efficiency: 2001-2003**

- *Demonstrated a Ka-Band space TWT, output power 100 W, efficiency 60 %, mass 2.3 kg. Output power 10X higher than the Cassini TWT and FoM is 43*

**Cassini Mission: 1996-2000**

- *Delivered a Ka-Band space TWT, output power 10 W, efficiency 41 %, mass 0.750 kg. Figure of Merit (FoM) is power/mass = 13*

**Modeling & Simulations: 1980-1995**

- *Basic design studies on traveling-wave tube (TWT) slow wave interaction circuits, collector circuit, focusing structure, electron gun and cathode*

**Cassini TWT**

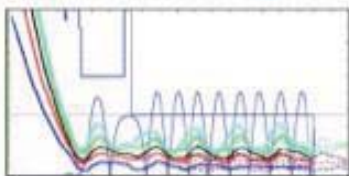



## **Two Examples Ongoing Efforts**



# Superconducting Quantum Interference Filter (SQIF) [Receiver]

POC: Robert Romanofsky, (216) 433-3507, robert.r.romanofsky@nasa.gov

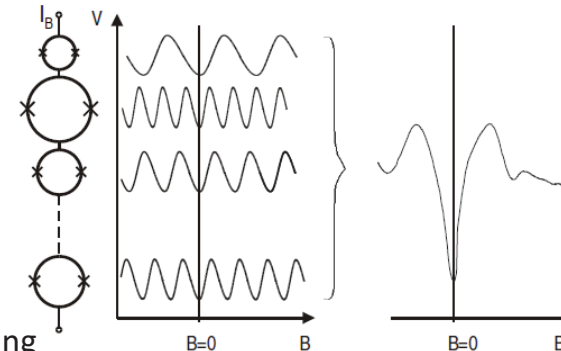
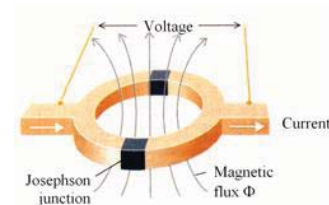
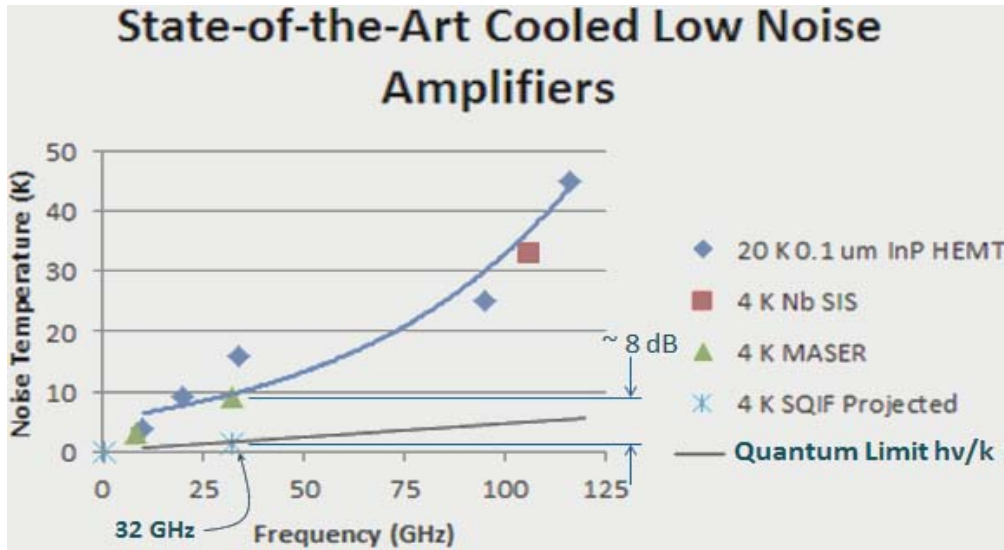

When a SQUID is biased with a constant current, the voltage across it oscillates with increasing  $\phi$  and period  $\phi_0$  ( $h/2e$ ). SQUIDs can detect magnetic fields lower than one flux quantum  $h/(2e)$  ( $\approx 10^{-15}$  Wb), with  $10^{-18}$  Wb reported in the literature.

## Objectives:

- Investigate sensitivity of 2D dc SQUID (SQIF) array
- Design and fabricate 2D X-band SQIF array and characterize sensitivity and noise relative to the state-of-the-art receiver technology
- Verify that as gain scales with increasing numbers of SQUIDs, noise temperature can be made arbitrarily low

## Approach:

- Develop in-house capability to assess performance of 4 K Niobium SQIF
- Co-design X-band 2d SQIF with domestic foundry (Hypres); Proceed to Ka-band if warranted
- Quantify potential of SQIF technology to provide disruptive architecture for futuristic deep-space comm

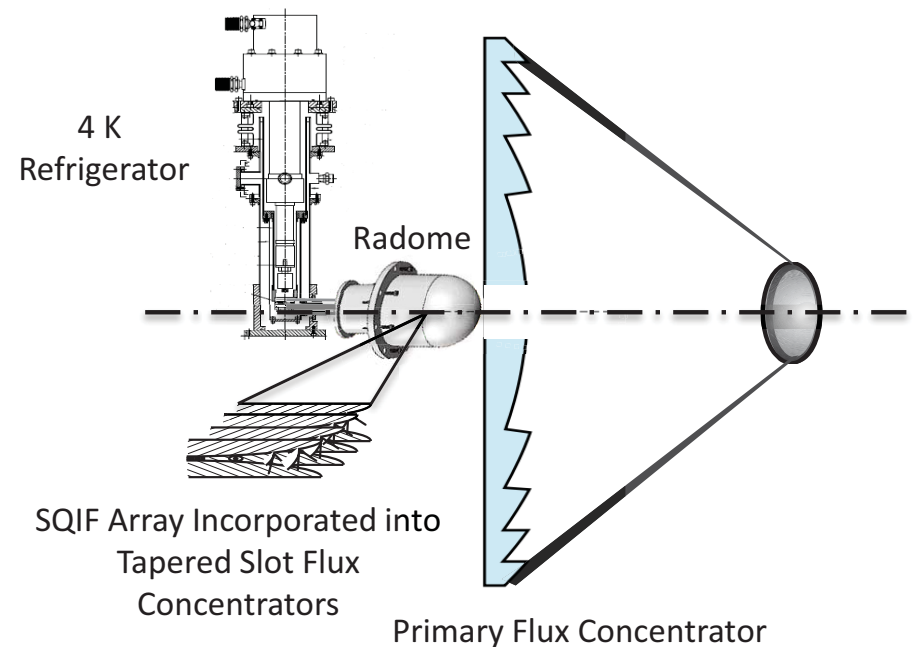

# Integrated Radio and Optical Communications (iROC)

## *Revolutionary Capability in an Evolutionary Manner*



### TSD Objectives:

- Combine the best features of select deep space RF and optical communications elements into an integrated system
- Realize Ka-band RF and 1550 nanometer optical capability within the MRO payload envelope
- Prototype and demonstrate performance of key components to increase TRL, leading to integrated hybrid communications system demonstration

### Findings:

- Offers potential 40x (optical) and 16x (RF) data rates with comparable MRO payload mass
- Reduces deep space mission risk for transition to optical comm technology by integrating highly capable and robust RF system
- Operates without requirement for uplink laser beacon
- Provides extensible system design beyond Mars distances

### Key enabling technologies recommended for integration:

- Precision beaconless pointing through sensor fusion
- Combined RF/optical Teletenna
- RF/optical Software Defined Radio (SDR)
- Networked RF/optical link management

### Phase:

- Technology Development/Pre-Phase A
- Targeted circa 2020 demonstration

GRC Project Manager: Monica Hoffmann

Co-Principal Investigator: Dr. Daniel Raible

Co-Principal Investigator: Dr. Robert Romanofsky

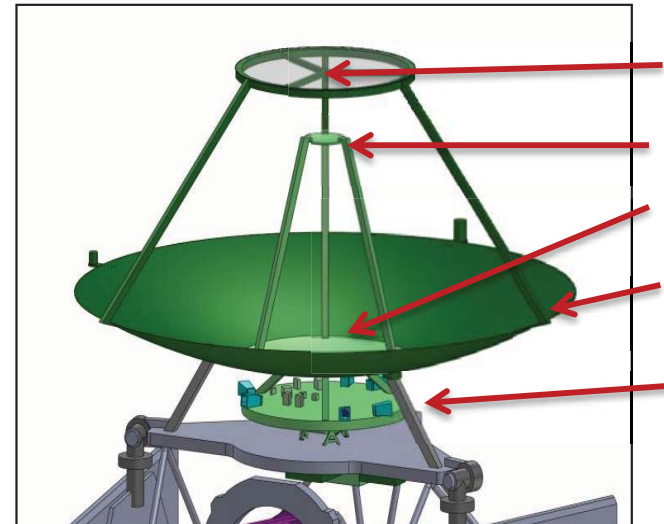

*Lightweight 3 meter Ka-band Mesh / 25cm Optical Composite Mirror Teletenna Subsystem*

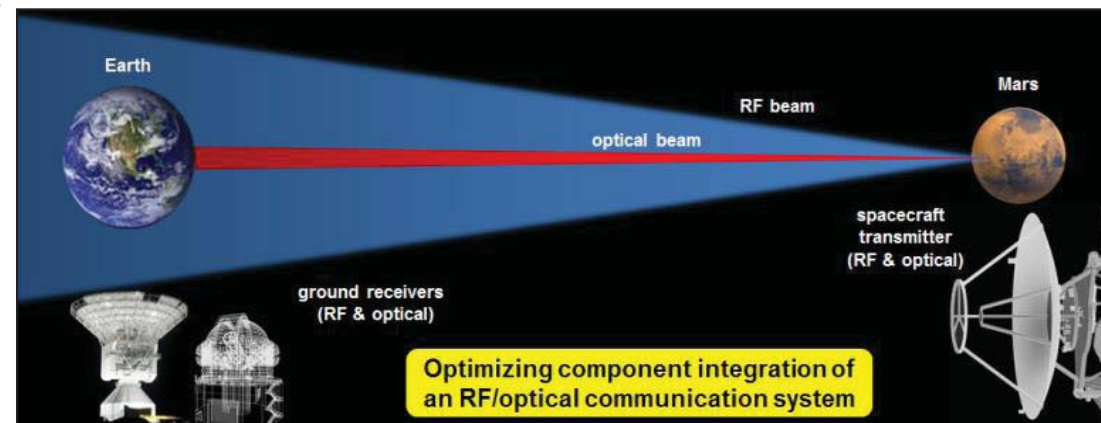



## **Examples of Some Facilities**



# Aero-Space Communications Competency

## Technical Areas and Labs/Facilities

### Advanced Antennas & Propagation

- Antenna & MW Components & Systems
- Antenna Metrology/Characterization & Cryo-electronics
- RF and Optical Propagation
- Nanotechnology (nanoantennas & nanoelectronics)



### Communications Components/Devices

- High Power TWTA/SSPAs
- MW and Wireless Components and Circuits
- 3-D Electromagnetic Modeling
- Electronic Materials for Semiconductors
- Electronic Devices & RF Photonics



### Digital Communications & Navigation

- Software Defined Radios/EVA Radio Development
- Advanced Navigation Technology
- Surface Wireless Communications
- Integrated Audio Technology
- Model-Based Signal Processing



### Network Architectures and Protocols

- Network Protocols and Technology
- Aerospace Comm Architectures & Systems
- Network-Centric Operations & Technology
- Simulation and Modeling
- System of Systems Comm Arch Development



### Space Flight Communications

- Communications, Navigation, Networking re-Configurable Testbed (CoNNeCT) on ISS
- Space Communications Compatibility Test Sets
- EVA spacesuit communications
- Orion vehicle communications



### Communications Systems Engineering

- Architecture Development and Planning
- System Con Ops, Requirements, V & V Development
- Network/System Level Trades/Analyses, Mod & Simulation



# Microwave Systems Laboratory



## Antenna Ranges

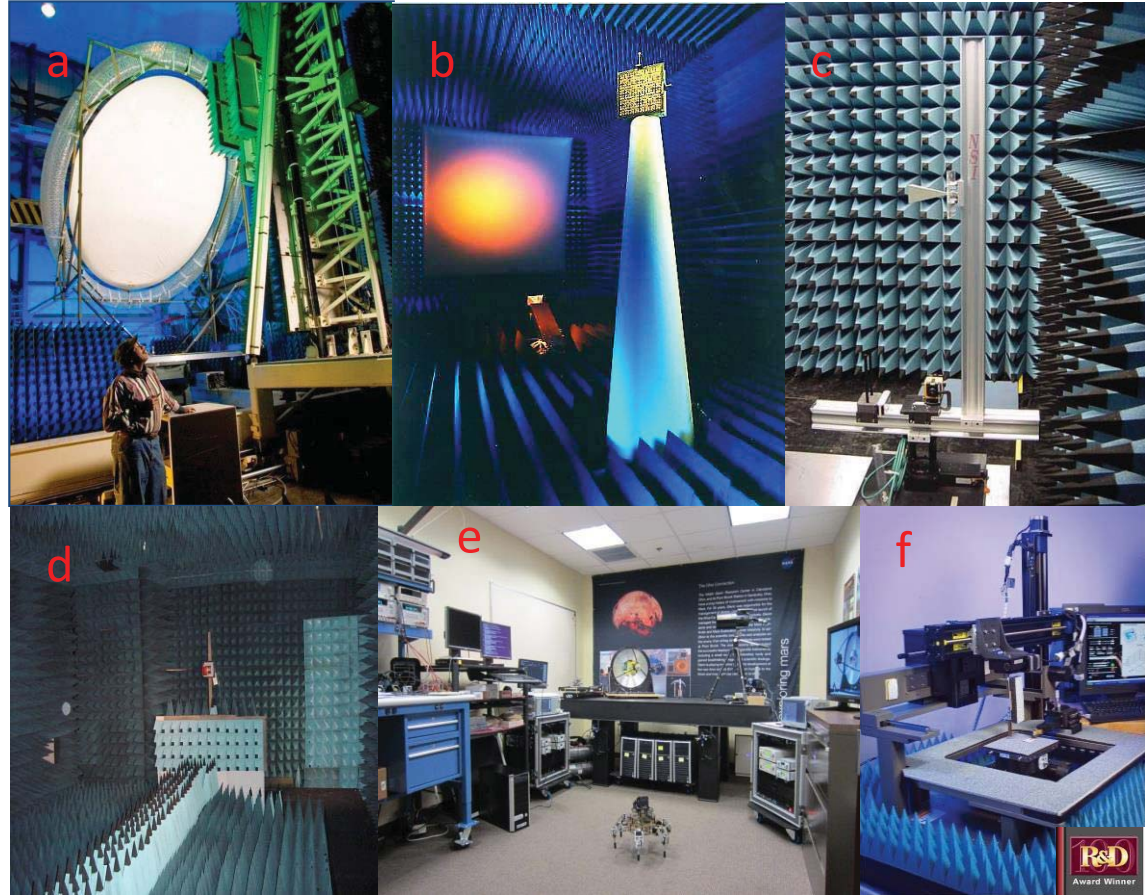

The Microwave System Laboratory (MSL) houses five RF antenna measurement ranges which are available for use by Glenn staff and their industrial and academic associates. The ranges support the work being done at the center in the research and development of communication systems. Although used primarily to observe and characterize the performance of microwave antennas, the ranges can be used for communication system studies and to study other types of electromagnetic phenomena such as scattering.

Examples of measurements which have been performed at the facility include:

- Satellite communication antennas for space and ground segment terminals
- Aeronautical terminal antennas
- Phased array antennas, reflectarray antennas
- Large aperture inflatable antennas
- Electromagnetic scattering
- Multibeam antennas
- Mobile antennas
- Bit Error Rate performance of scanning antennas
- Miniaturized antennas
- Electromagnetic scattering of antenna structures & materials

(a) Near Field Range Antenna; (b) Compact Range Antenna; (c) Cylindrical Near Field Range; (d) far Field Range; (e) Optical Communications Laboratory; (f) Antenna Near Field Probe Station Scanner

The MSL also houses a newly created Optical Communications Laboratory to support emerging efforts such as the Integrated Radio and Optical Communications (iROC) Project.



# RF Propagation Research Laboratory

## Laboratory Objectives

- Evaluate GEO and LEO propagation links and validate models that will enable NASA, DoD and commercial communication system designers to optimize spacecraft power requirements and reduce cost.
- Fabricate, characterize, and perform systems performance verification on in-house or commercially available instruments such as radiometers, beacon receivers, and interferometers.
- Developed one-of-kind digital receiver techniques and radiometry sensing techniques for characterizing radio frequency waves at Ka-band and millimeter waves (e.g., Q/V/W bands).

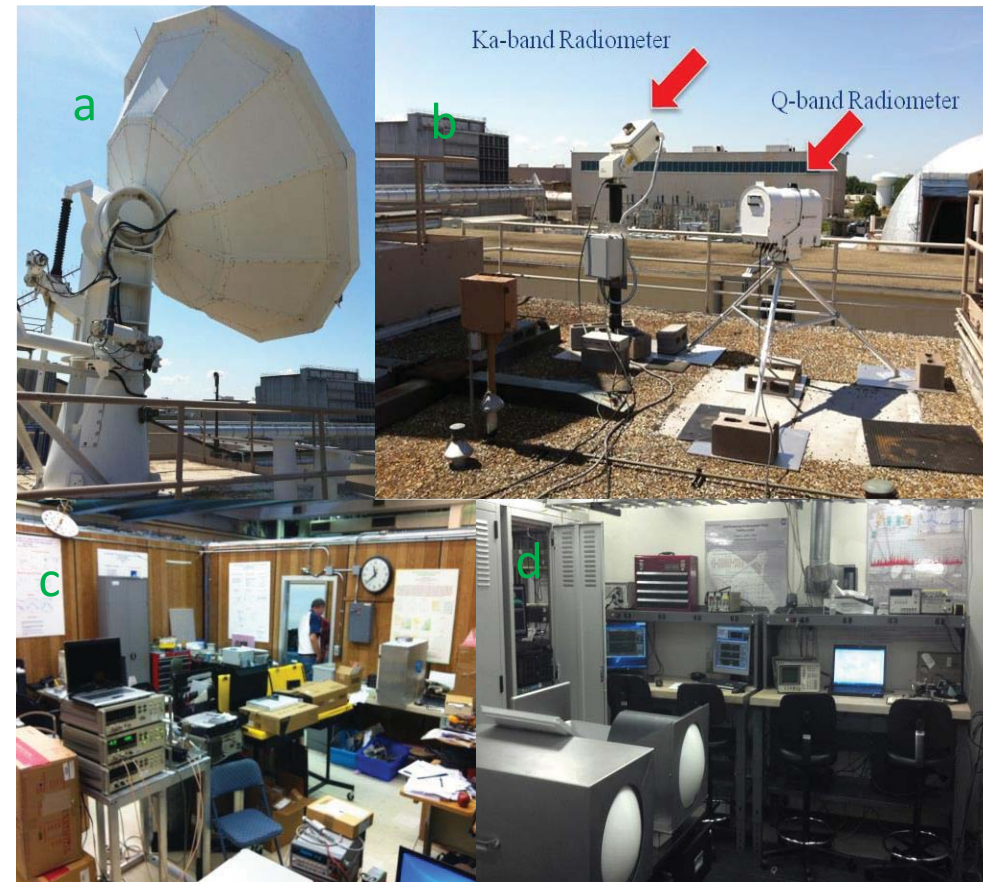
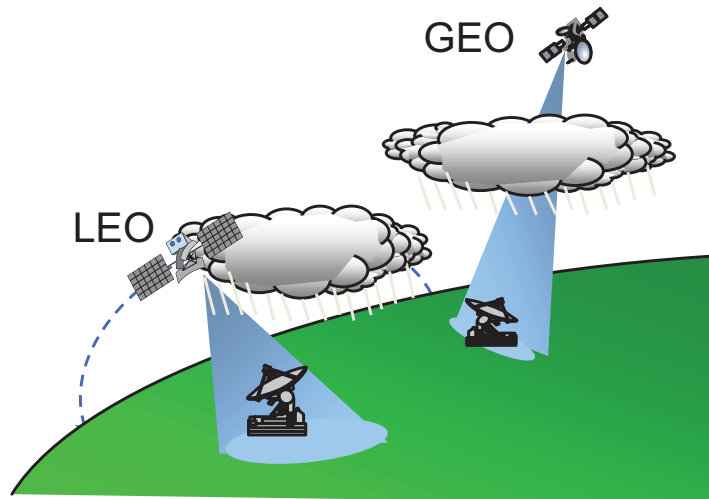

(a) 5.5 Meter Diameter Beam Waveguide Antenna on top of Bldg. 55  
(b) K-band and Q-band radiometers collecting Data in roof of bldg 55;  
(c) & (d) RF Propagation assembly, component test, and station monitoring areas in bldg. 55



# Cryogenic Microwave Laboratory (CML)

## Description:

The Cryogenic Microwave Electronics Laboratory is used to evaluate innovative microwave materials, devices, and circuit technologies in support of the Communications, Instrumentation and Controls Division's effort to develop next generation communications systems for Space Exploration. The facility has been used to evaluate space qualified cryogenic receiver components, superconducting phased array antennas, tunable thin-film ferroelectric based oscillators, filters and phase shifters, ferroelectric/semiconductor heterostructures, SiGe low noise amplifiers, InP HEMT low noise amplifiers, and more.

## Capabilities:

- S-parameters from 100 MHz to 40 GHz at temperatures from 30 K to 300 K (room temperature to 67 GHz)
- Noise parameters up to 40 GHz at temperatures from 30 K to 300 K
- Magnetoresistance
- Hall and Van der Pauw measurements (plus mobility spectra)
  - Shubnikov deHass
  - Resistance to  $10^{11}$  Ohm
- Antenna Far Field Patterns up to 10 cm apertures cooled to 30 K
- 3D measurements at nanometer scale using phase-shift interferometry
- AFM/STM

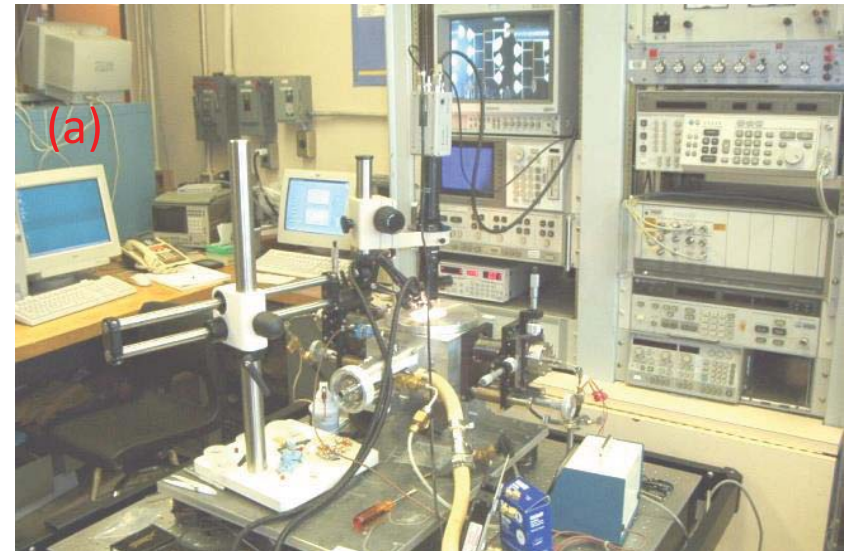

(a) 40 GHz Cryogenic On-Wafer Probe Station; (b) 2.5 K, 9 T Hall system

# Digital Communication and Navigation Labs/Facilities



STRS/ SDR Laboratory



SCaN Testbed  
Ground Integration  
Unit

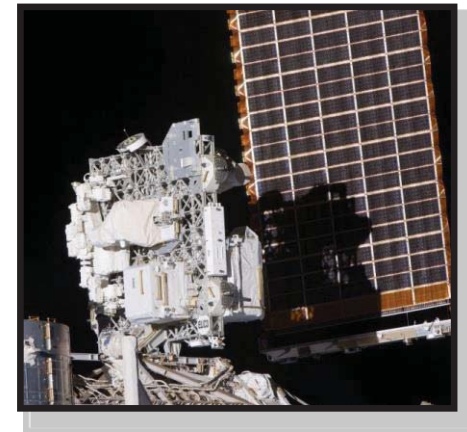

ISS SCaN Testbed  
Flight System

EVA Spacesuit  
Integrated Audio



EVA Radio  
Development Lab

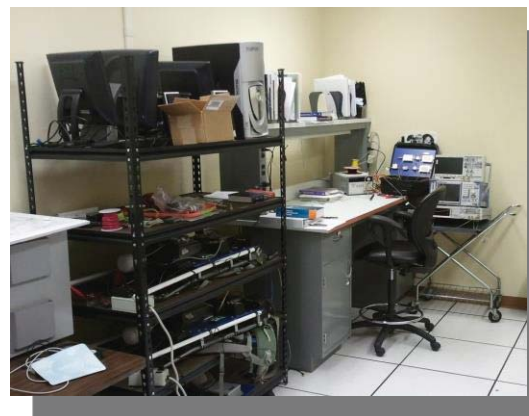

Desert RATS  
Field Demos



# Clean Room Facility for Fabrication of Microwave Integrated Circuits

---

## Description:

- The Micro-Electronic Fabrication Facility of the Communications Technology Division at NASA Glenn Research Center is a class 100 clean room. The facility is equipped to provide extensive material characterization studies as well as develop the current state-of-the-art thin film devices, passive or active

## Capabilities

- Photolithography Room
- Electron-beam evaporators
- Interferometer station
- Optical microscope with Digital Spot Imaging system
- Scanning electron microscope





# Network and Architecture Labs Facilities

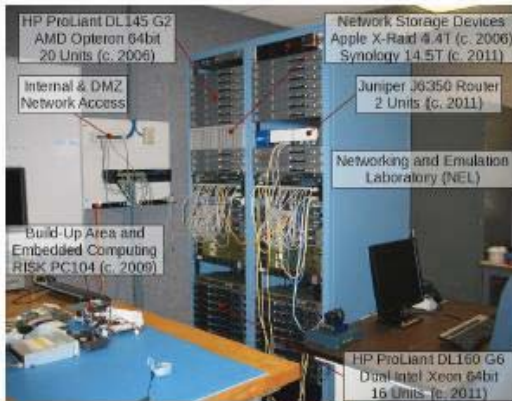

## Networking and Emulation Lab (NEL)

- Evaluate communication protocols over different network topologies
- Heterogeneous builds provides flexibility to experimenters
- Virtual Machines and GPU Parallel Computing
- Segregated Internal and DMZ Networks, Connections to Protocol Lab
- Software & Services: NS3, OPNET, OS Patch Mirror, NTP, svn, git, cvs, etc
- Current Use: Software Development, Network Simulations, Test Bed
  - Channel Emulator, DTN / DTNBone, FAA NAS Simulations, CUDA LDPC



## Multi-Node/Multi-Hop, Free-Space Optical DTN Testbed

- Investigate the performance of DTN in a Mars-to-Earth communication scenario.
- Emulate direct-to-earth links to the three Deep Space Network sites using both software and free-space optical transceivers
- Future Use: Development of new optical modulation schemes
- Software: LTP, ION 3.0.1, STK



## Protocol Lab

- Develop and test new and upcoming communication protocols
- Support partnerships with other Networking Assets
  - DOE Advanced Networking Initiative Lab
  - Ohio University
- Mobile IPv4 and IPv6 Networking; Network Mobility (NEMO), Sensorweb
- Saratoga Protocol testing and development
- VMOC - Virtual Mission Operations Center

# Network and Architecture Labs Facilities



## Secure Communication Lab

- Physically secured environment
- Suitable for work on projects requiring a clearance
- Test, evaluate, and engineer communication setups for operational systems
- Current efforts with Department of Homeland Security (DHS)
- Wireless and cellular networking
- Emulation of air-to-ground communication systems



## NASA-CLE Airport Communication, Navigation, and Surveillance Test Bed

- Study mobile extensions to airport surface communication systems
- WiMAX (IEEE 802.16e) evaluation and validation
- Wireless surveillance radar testing
- Aeronautical Mobile Airport Communications System (AeroMACS)
- Research mobile and fixed applications of AeroMACS
- Air-Ground validation testing using specially equipped 737-700 aircraft



## UAS Control and Communication Lab

- New communication methods for Unmanned Aircraft Systems (UAS)
- Aircraft and Ground Radio Development
- Simulations of UAV in the National Airspace System (NAS)
- Evaluating proper security protocols for end-to-end communications
- Test equipment build-up area including ruggedized aircraft racks
- Permission to perform tests at different airports nationwide
- Burke, Snyder Field, Cedar Rapids, ...