

Design Evolution of Hot Isostatic Press Cans for NTP Cermet Fuel Fabrication



NASA Advanced Exploration System (AES) Project

NETS
26 February 2014

O. Mireles, J. Broadway, R. Hickman
NASA Marshall Space Flight Center
omar.r.mireles@nasa.gov

Background

- NTP fuels under development
 - W-60vol%UO₂ CERMET
 - W coated UO₂ spherical kernels
 - W coolant channel, perimeter, face clad
 - Inherent stability of W clad in hot H₂ minimize fuel erosion and fission product release during NTP operation
- HIP Manufacture Advantages
 - Near net-shape
 - Full scale
 - High density
 - Existing industrial base

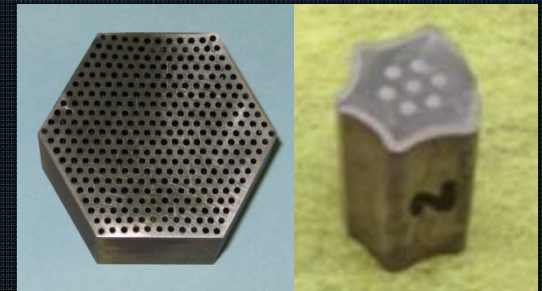

331 and 7 channel fuel samples



HIP Furnace

Problem & Objective

- Fuel Element Constraints
 - Fully encapsulated fuel kernels
 - Long length
 - Numerous coolant channels
 - Integral claddings
 - Limited to refractory alloys (Nb, Ta, Mo)
 - Powder metallurgical constraints
- Develop a sub-scale and full-scale HIP cans that can be used to fabricate NTP fuel elements for process development and fuel element evaluation.

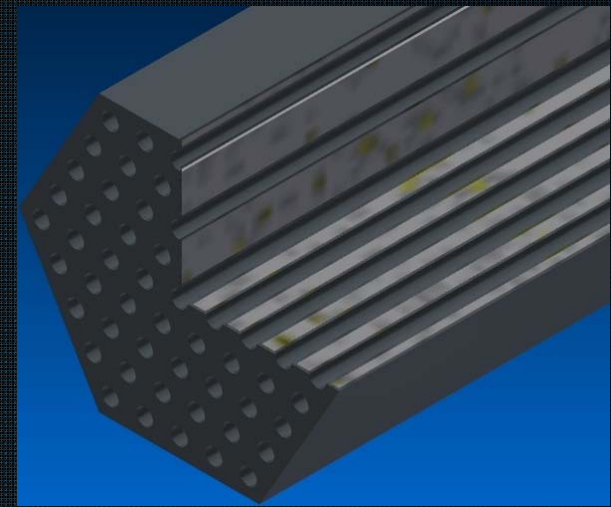

61 channel cermet fuel element concept (ANL-200 reference)

Consolidation

- Powder Characteristics
 - Appropriate coarse, medium and fine grain distribution
 - Green packing density drives shrinkage/dimensional tolerance
- Sinter Temperature
 - 80% of powder melting temperature
- Pressure
 - >15 ksi for consolidation onset
- Atmosphere
 - Compatible with can: argon
- Time
 - T /P ramp rates and hold times influence microstructure

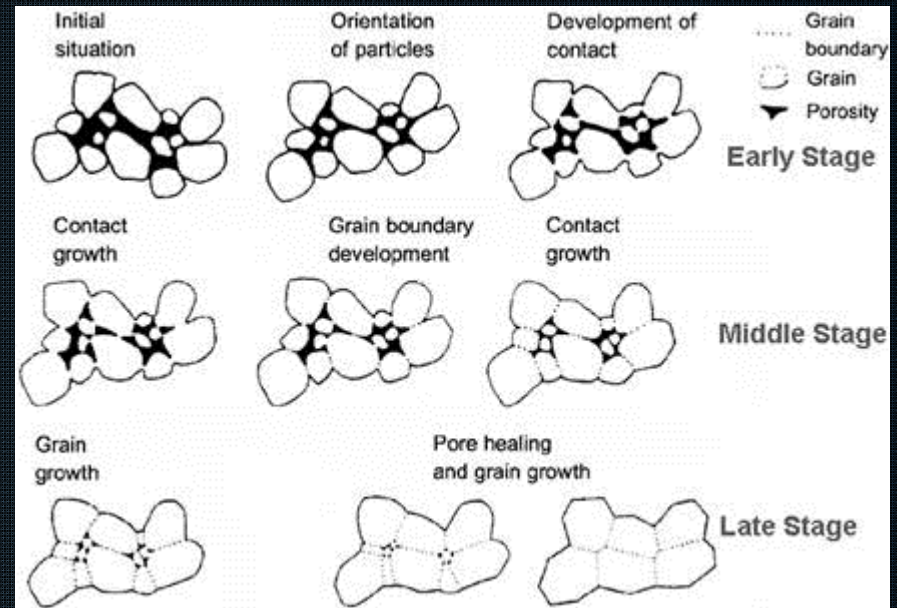

Consolidation process

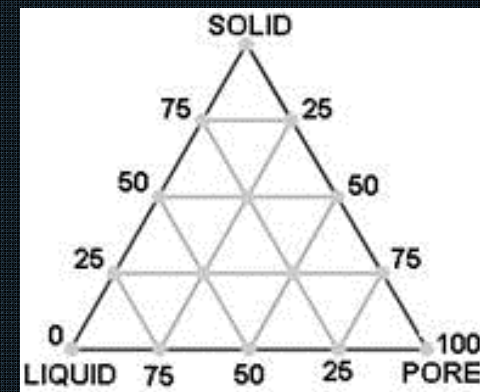

Ternary phase diagram

HIP Can Design

- Design features
 - Complex hexagonal can/mandrel geometry
 - 19-61 channels
 - 50-100 cm length
 - Perimeter clad
 - Coolant channel & face clad
- Design constraints
 - 10-20% shrinkage
 - Channels must not bow or twist
 - Sufficient flow area for viable powder fill

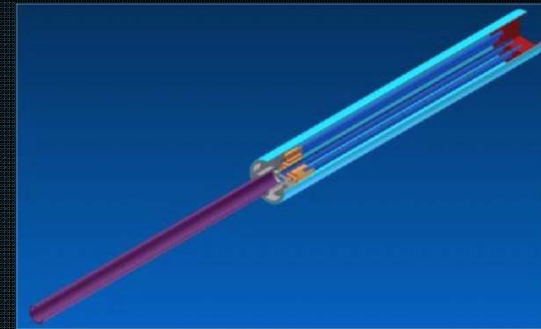

Circular 7 channel can design

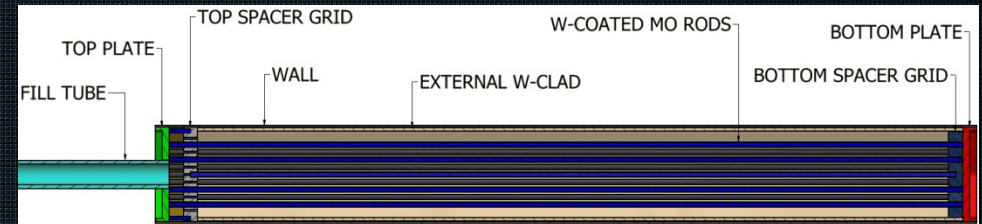
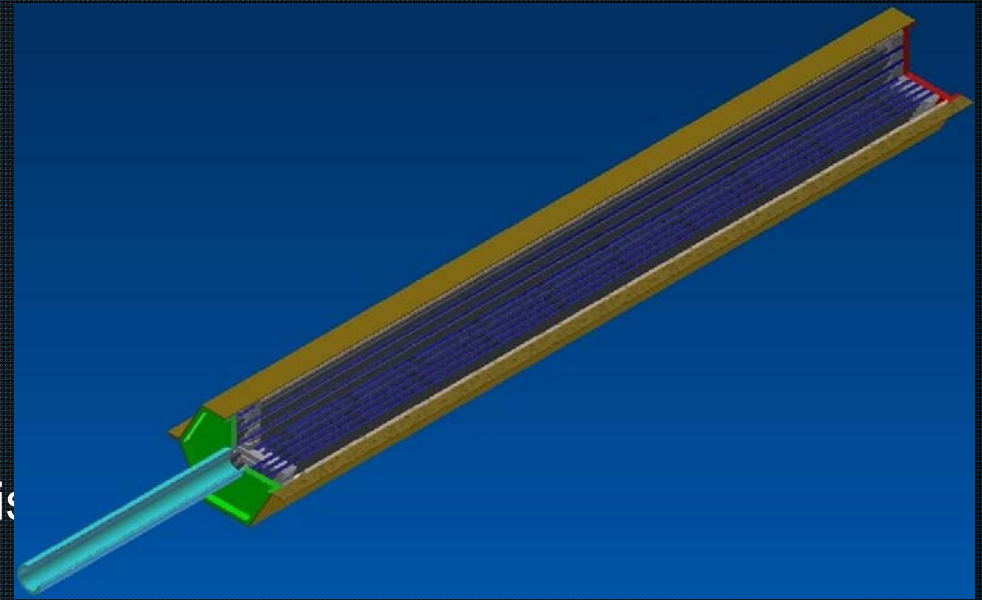

61 channel HIP can design (ANL-200 reference)

HIP Can Manufacture

- CNC milling
 - Specialized techniques for Nb
 - Time consuming
 - Expensive (time and materials)
- Water jet machining
 - Iterative development process
 - Non-specialized techniques
 - Significant time reduction
 - Sufficient dimensional tolerance
 - Minimal material waste
 - Minor milling required
- CNC sheet metal break
 - Axial tolerance difficult to achieve
 - Tolerance variation proportional to length



Water-Jet

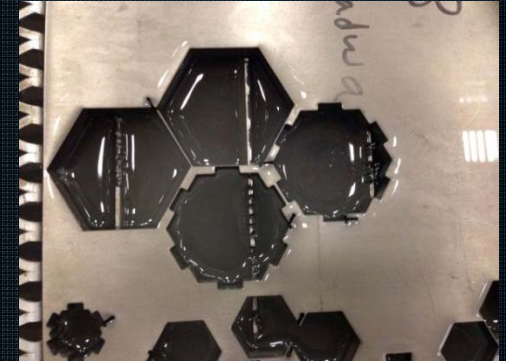

Material Optimization

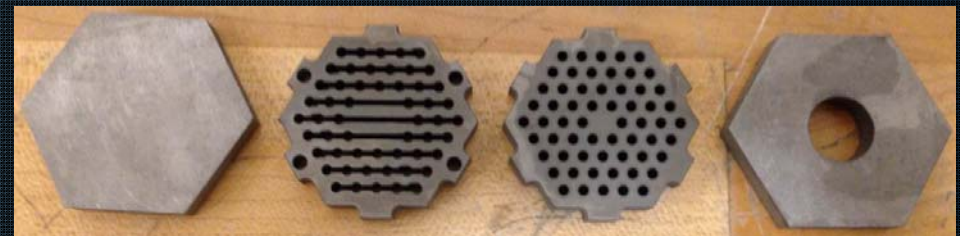

Water-jet cut niobium HIP can components (43 min prod. Time)



Can component fit-checks

Integral Clad

- Coolant channel clad
 - Vacuum plasma spray (VPS)
 - W onto Mo mandrel rods
 - Thickness uniformity and adhesion
 - Completed through a Phase I SBIR by Plasma Processing Inc. (PPI)
- Perimeter Clad
 - Electro (EL)-form
 - W onto a graphite mandrel
 - High density and hermiticity
 - Developed under same PPI effort



W coated Mo rods (EL-form)



External W clads (VPS)

Can Assembly

- Can wall welded
- Mandrel rods stacked between spacer grids
- Enclose mandrel in wall
- Can top welded to can
- Vacuum leak check



61 Channel Full Size HIP Can



7 Channel Subscale HIP Can



Weld in a argon glove box

Fill & Close-Out

- Can surface cleaned
- Can weighed and measured
- Can vibratory filled in a glove box
- Filled can weighed
- Can evacuated
- Fill tube crimped
- Seam weld and fill tube excess cut



61 channel near full
scale HIP can: filled
and closed out

HIP Operations

- HIP can placed in can jig
- Jig placed in HIP furnace
- HIP schedule initiated
- Remove jig
- Weigh and measure can



HIP Jig



Jig in furnace



Subscale Can Removal

Results

- 2013 HIP Trials
 - Circular 7 channel W-ZrO₂
 - Hex 61 channel, near full length W-ZrO₂: Fail
 - Circular slug W-dUO₂ x 2
 - Hex 7 channel W-dUO₂
 - Hex 61 channel, full length W-ZrO₂: Fail
- Failure Analysis
 - Wall cracking observed at can base
 - Significant reduction in ductility of HIP can coupons when compared to control samples
 - SEM/EDS revealed significant C embrittlement
 - Nb can interaction with graphite jig or furnace



W-dUO₂ filled HIP can



Failed HIP can

Conclusions

- HIP is viable for NTP fuel cermet fabrication
- Fundamental mechanisms are well understood
- Difficulty to meet NTP engine requirements proportional to length
- Design optimization highly iterative
- Significant opportunity for process and design improvement

Recommendations for Future Work

- Develop mitigation strategy to prevent Nb-C interaction
 - Mandrel coating?
 - Sacrificial getter foil?
- 19 channel Rover/NERVA geometry
 - Develop HIP can design
 - Fabricate prototype
 - Fabricate fuel element
- Optimize can designs
 - Finalize can geometry based on nominal green powder packing density
 - Establish fuel dimensional tolerance and NDE requirements
- Investigate methods for W can fabrication
 - Water jet of W sheet
 - VPS?
 - EL-forming?
 - Additive Manufacture?
 - Dip & HIP?

Acknowledgements

- The authors would like to thank Daniel Cavender, Brad Anders, Dave Vermillion and Jim Martin of NASA MSFC; Scott Odell of Plasma Processes Inc.
- Funding was provided by the “Advanced Exploration Systems – Nuclear Cryogenic Propulsion Stage” project.
- The opinions expressed in this presentation are those of the author and do not necessarily reflect the views of NASA or any NASA Project.