

The Challenges of Developing a Nutritious Food System for a Mars Mission

Michele Perchonok, Ph.D.

Manager, Human Research Program Science Management Office



Human Research Program Goal

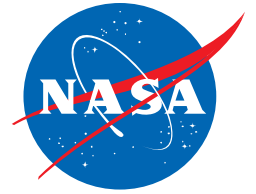

Human Research Program

The goal of HRP is to provide human health and performance countermeasures, knowledge, technologies, and tools to enable safe, reliable, and productive human space exploration.



HRP 2013



Food System Considerations

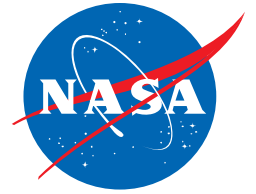

International Space Station:

- 6 month microgravity missions
- No refrigerators or freezers for food storage, all food processed and prepackaged
- Regularly scheduled resupply
- Eight day standard menu cycle augmented by crew preference foods



Mars Expedition Scenario:

- 2.5 year mission; microgravity and reduced gravity
- No refrigerators or freezers for food storage
- No resupply; food may be prepositioned to accommodate high mass and volume
- Current food system is mass constraining and will not maintain nutrition/acceptability



Human Research Program Organization

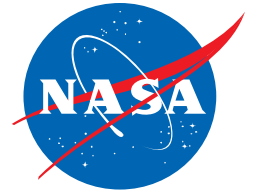

Human Research Program

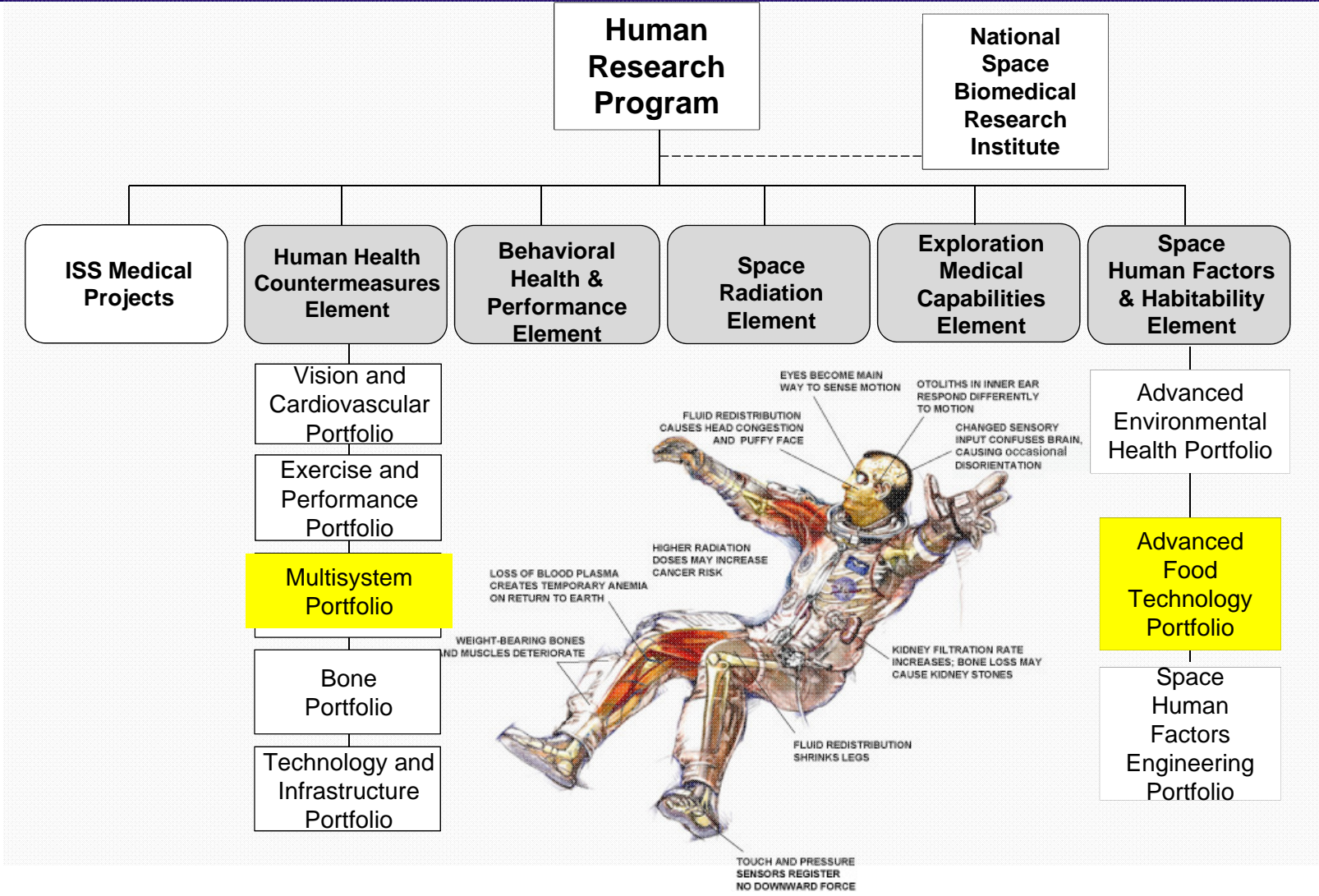

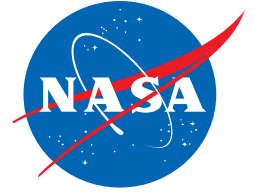

HRP is Focused on Risks

Human Research Program

Understand and mitigate risks to crew
health and performance in exploration missions

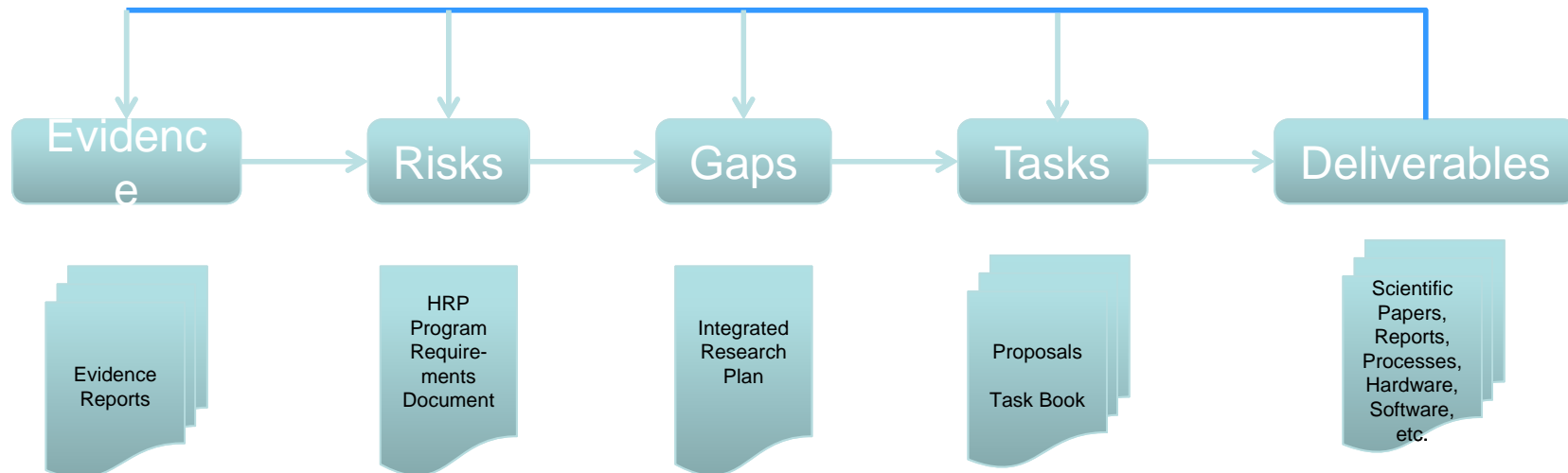

humanresearchroadmap.nasa.gov

Nutrient Requirements

Energy
CHO (fiber), Fat, Protein
Fat-soluble vitamins
Water-soluble vitamins
Minerals
Fluid

Systems

Muscle
Cardio
Fluid/Electrolyte
Immunology
Hematology
Neurovestibular
Endocrine
GI
BHP
Vision

Earth

Physiology
Medicine
Technology
Education

Countermeasures

Energy	Bisphosphonates
Amino acids	KCitate
Protein	Other Meds
Sodium	Exercise
Fatty acids	Other
Antioxidants	
Other	

Vehicle/Mission

Duration
Radiation
EVA
Schedule





Space Nutrition

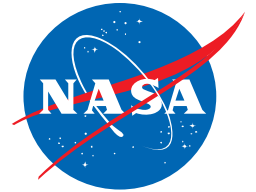

Human Research Program

Nutrition played a significant role in historical exploration missions.

- In the roughly 400 year time period between Columbus' voyage and the invention of the steam engine, scurvy (Vitamin C deficiency) killed more sailors than all other causes of death combined (including shipwreck). It is estimated that >2 million sailors died from scurvy.

Food and its delivered nutrition must be planned carefully

Space explorers are unlikely to find food sources

Food must deliver the nutrient requirements

Food sources

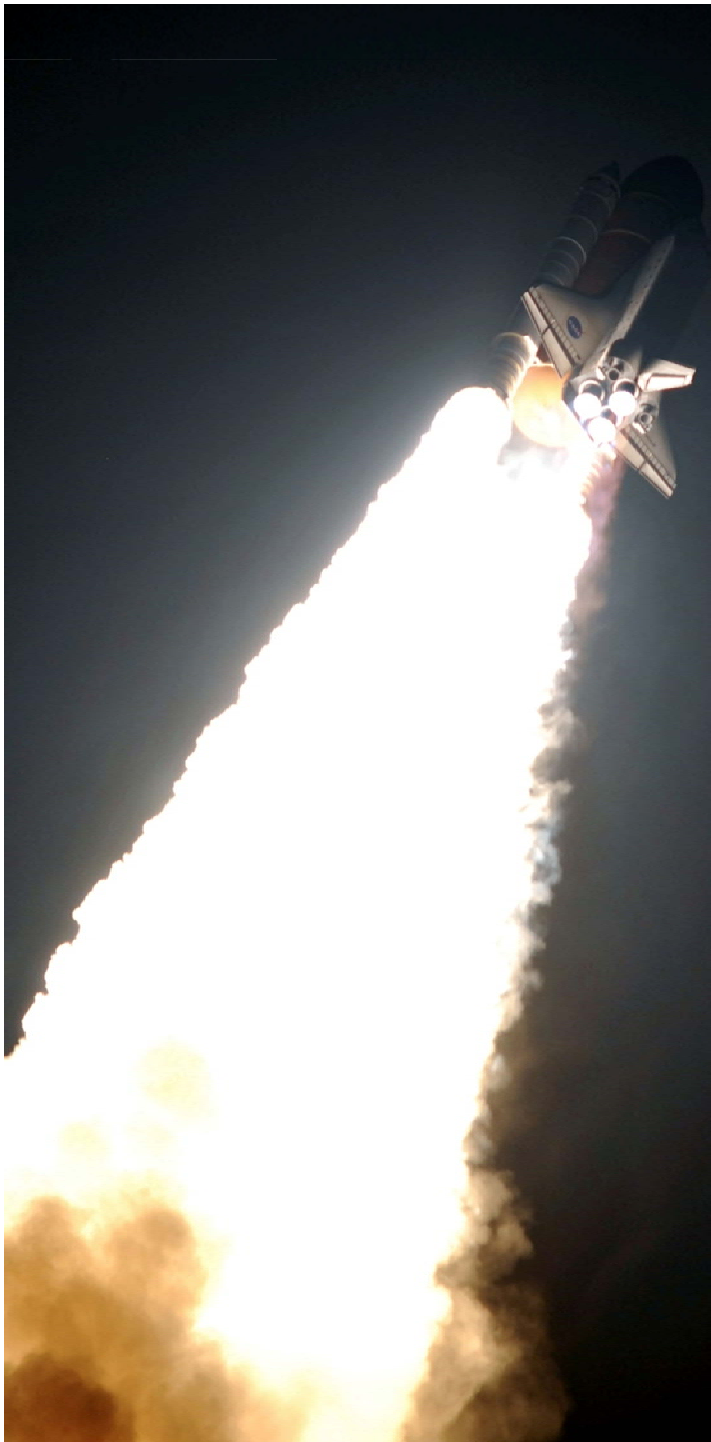

Nutrition Food Frequency Questionnaire

User: SMS Expedition 15 Number of Packets

Fruit-----

Dried fruit, fruit roll-ups, prunes

Kuraga, mashed dried apricots, prunes

Cobbler, cranapple dessert

Other fruit, like apples with spice, applesauce, berry medley, fruit cocktail, mandarin oranges, mixed fruit, peach ambrosia, peaches, pears, pineapple, strawberries

Apple cranberry sauce, apple dessert, cherries with cream sauce, foiberries, peach dessert

Raw fresh fruits or vegetables, like apples, onions, oranges, tomatoes

Beans, Soups-----

Black beans

Chicken consommé, cream of mushroom, hot and sour, minestrone, potato, tomato basil, vegetarian vegetable soup

Pureed pea soup, pureed vegetable soup

Chicken noodle soup

Borsch with meat, cucumber soup, Kharcho mutton soup, meat and vegetable soup, noodle soup with meat

Red beans and rice, split pea soup

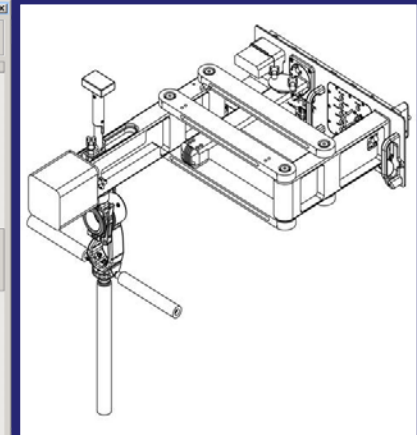



Energy

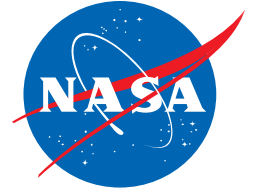

Human Research Program

- Energy intake is a primary concern.
 - Getting enough calories will allow for maintenance of body mass.
 - Consuming adequate calories is accompanied by adequate consumption of vitamins and minerals. Vitamin D is one exception.
 - Insufficient energy intake leads to weight loss, muscle and bone loss, cardiovascular decrements, oxidative damage, and more.
 - Dietary intake is monitored using a questionnaire (iPad App has been developed for future missions)
 - Body mass is measured during flight using



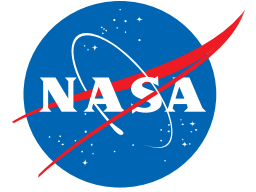

Vitamin D and Bone Health

Human Research Program

- Avoiding vitamin D deficiency can have profound effects on disease incidence, including bone, and potentially other systems as well.
 - NASA sponsored research in the Antarctic helped support evaluation of vitamin D doses in individuals with limited sunlight exposure.
 - Research documented that supplementing a marginal diet with 800 IU vitamin D/day maintained vitamin D levels in ISS crewmembers.

Vitamin D Stores
(25(OH)Vitamin D)

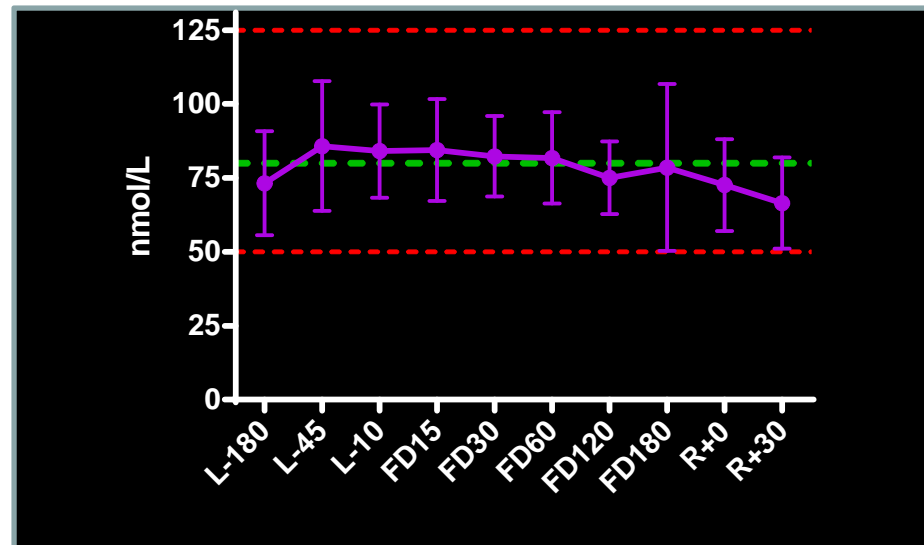

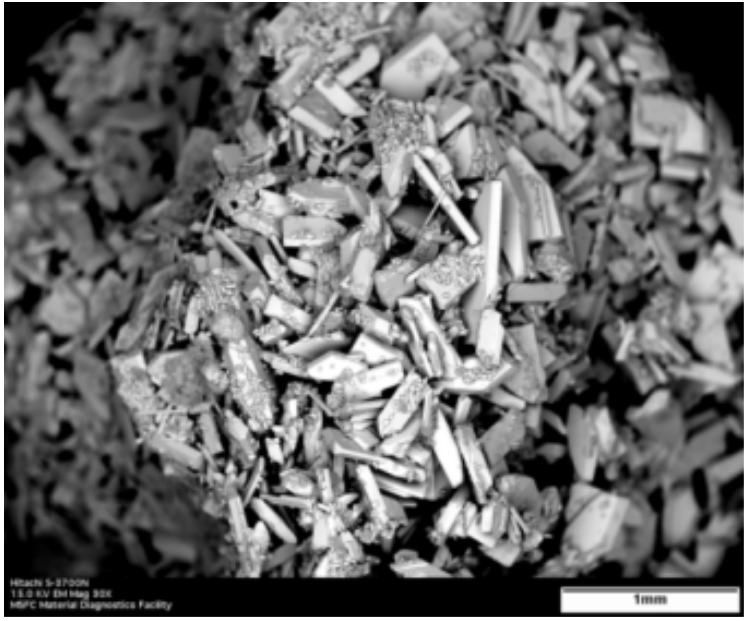



Fluid

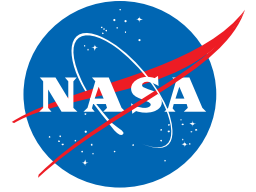

Human Research Program

- Fluid intake is critical for:
 - Maintaining hydration
 - Minimizing kidney stone risk (which is typically high during flight)
 - Keeping the urine processor from failing due to calcium precipitation.



Bone Mineral Density

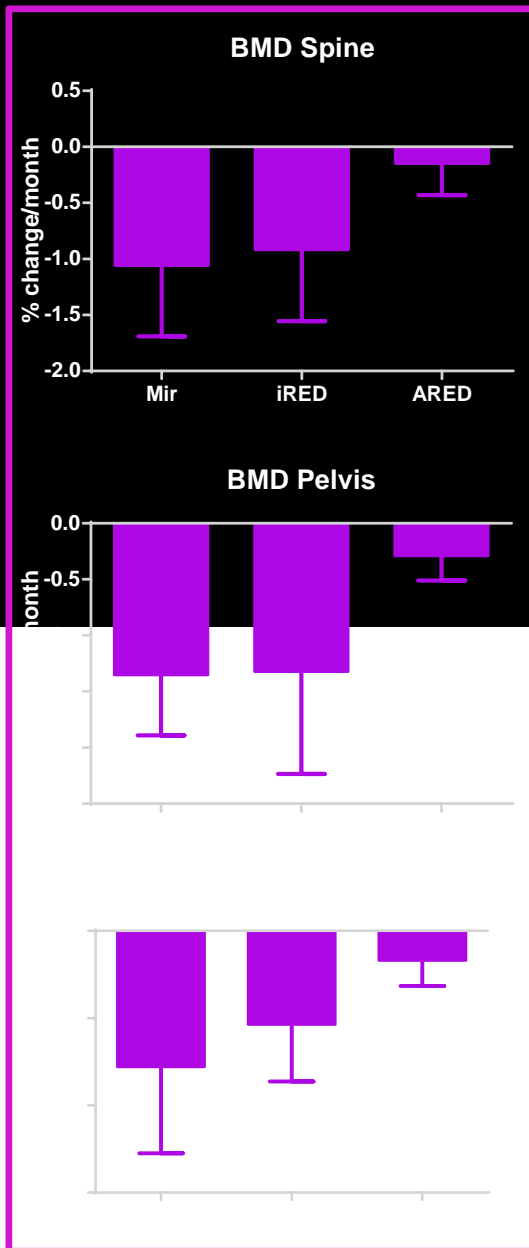

Whole Body BMD





Bone

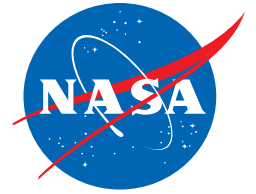

Human Research Program



Advanced Resistive Exercise Device (ARED)

- Recent ISS research shows that good nutrition, including maintenance of body mass and good vitamin D status, and heavy resistance exercise (ARED (Advanced Resistive Exercise Device)) will protect bone mineral density.
 - First evidence from flight that good nutrition and exercise can have a positive influence on bone.
 - Quality of bone may not be the same.



Vision Issues

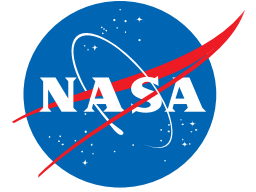

Human Research Program

- Some ISS crews were found to have vision issues during and after flight which is believed to be related to intracranial pressure.
 - Fluid shifts, cabin carbon dioxide levels, exercise, etc. could influence vision issues.
 - A nutrition/biochemical pathway may explain why some crewmembers are predisposed to these vision issues.







Diet and Bone

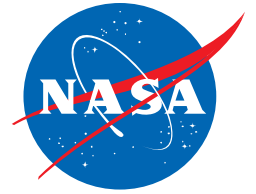

Human Research Program

- While exercise and nutrition have helped maintain bone density in some ISS crew, there are other ways that nutrition can help bones:
 - Omega-3 fatty acids (fish) have many health benefits. Fish intake was shown to be associated with less bone loss in ISS crews.
 - Altering the ratio of animal protein (e.g., meat) to potassium (fruits/veggies) in the diet may mitigate bone loss during flight. Studies underway on ISS
 - Higher iron stores during flight was associated with increased oxidative damage and bone loss. Minimizing iron the food system is a goal.

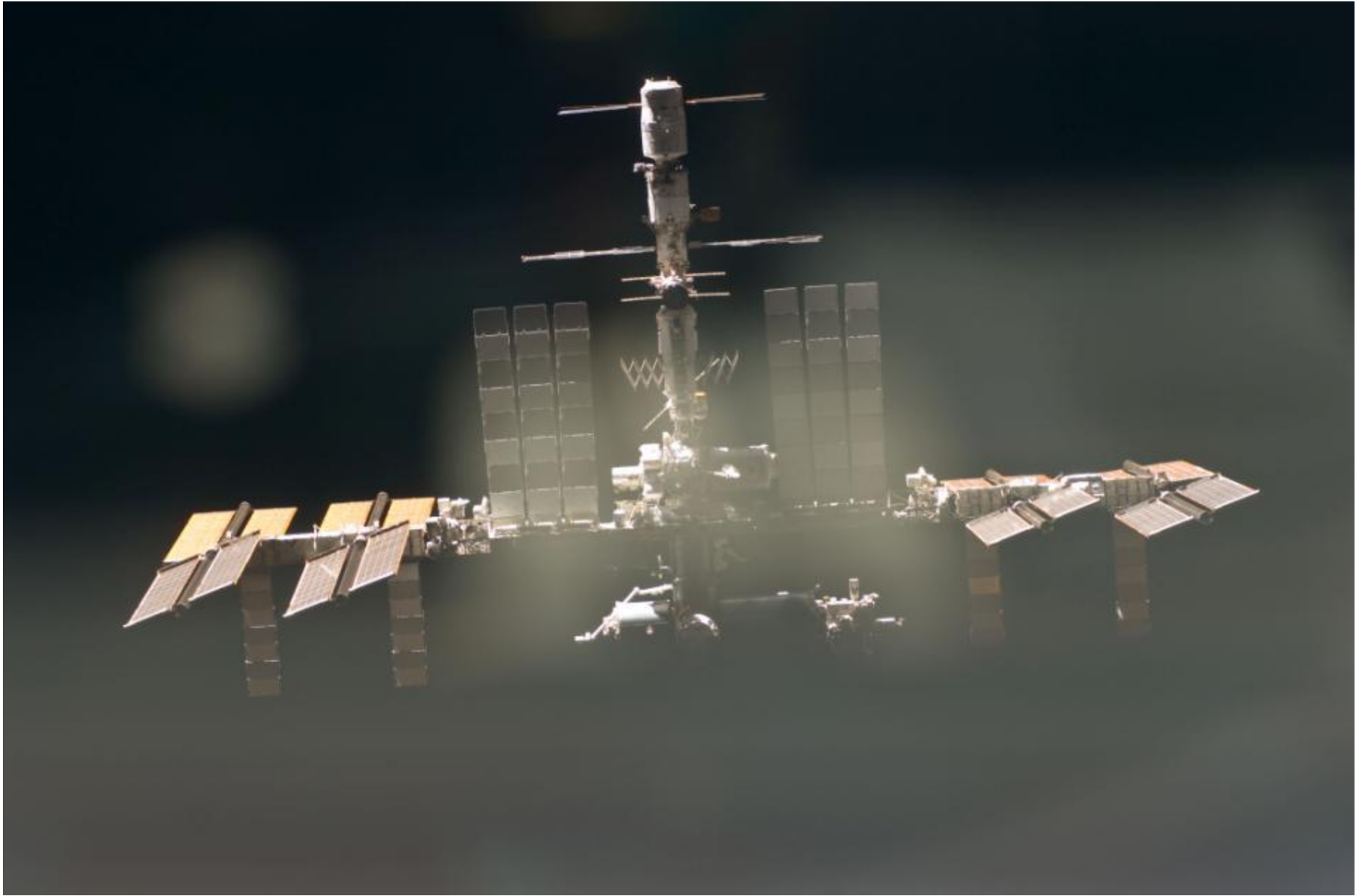



Spinoffs Ed/Out

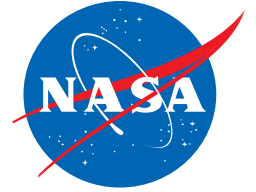

Human Research Program

- Findings from NASA nutrition research have significant application across the nation.
 - From a better understanding of human physiology in a unique environment, we better understand health and disease in Earth-based populations
 - Technology to study nutrition during space missions has applicability on Earth.
 - Education/outreach efforts raise awareness of nutrition, and science, and space research to students of all ages. From scientific papers in peer-reviewed journals to newsletters and books aimed at elementary/intermediate school kids, there is a lot of material available.



National Aeronautics and Space Administration

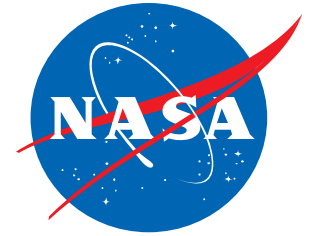

Questions?

Human Research Program

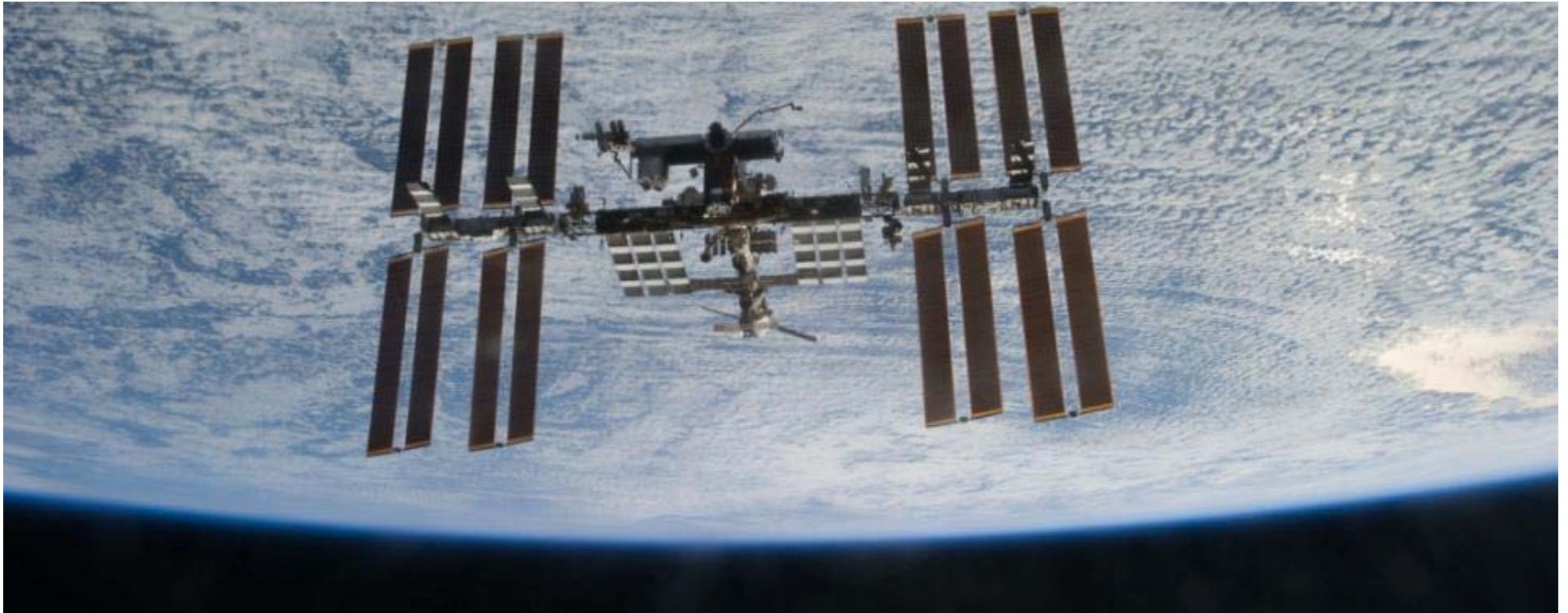



Future Missions: The Flexible Path

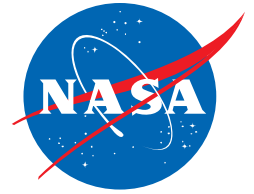

Human Research Program

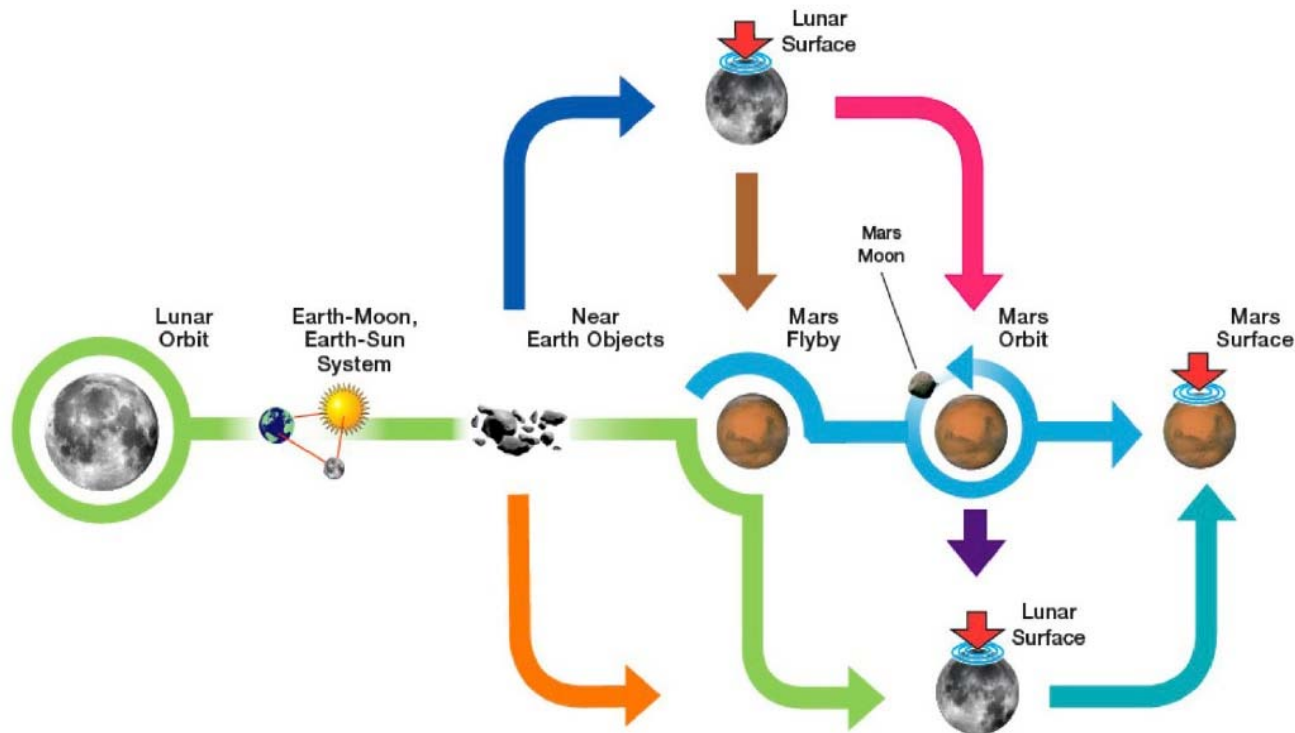

Schedules for the next destinations are unknown, but the goals are all beyond Low Earth Orbit (LEO)



Recent Exploration Activities

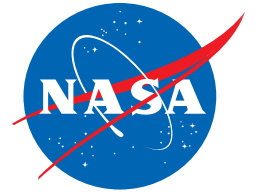

Human Research Program

- ISS International Partners
 - Maximize human system risk reduction by 2020
 - Multilateral Human Research Panel for Exploration (MHRPE)
 - Sharing human subjects, data, hardware, protocols
- Orion Multi-Purpose Crew Vehicle (MPCV)
 - HRP research to target test flights in 2017 & 2021
 - Low frequency vibration, rotational oscillations, acoustics & dosimetry, exploration exercise hardware
- Asteroid Redirect Mission (ARM)

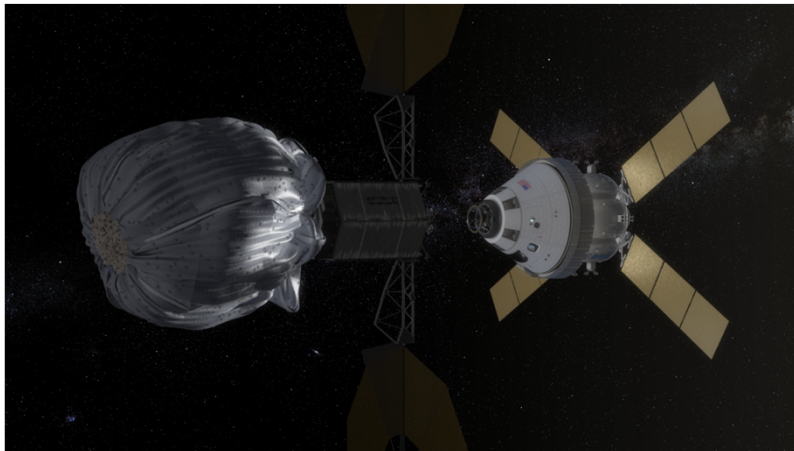



The Human Research Program

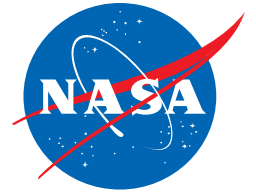

Human Research Program

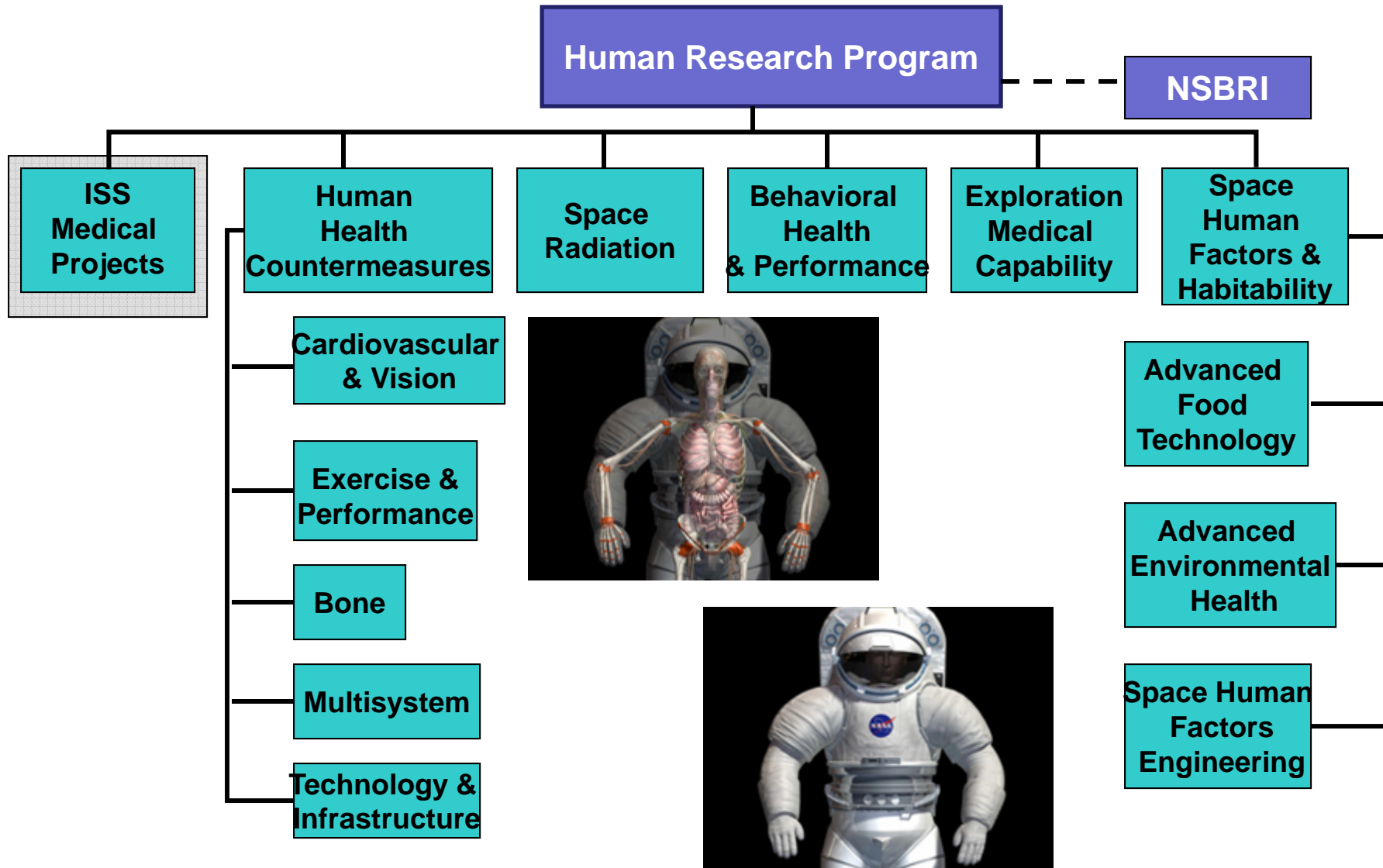

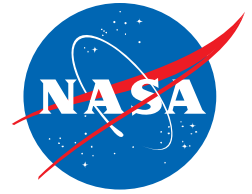

Integration With Other Organizations

Human Research Program

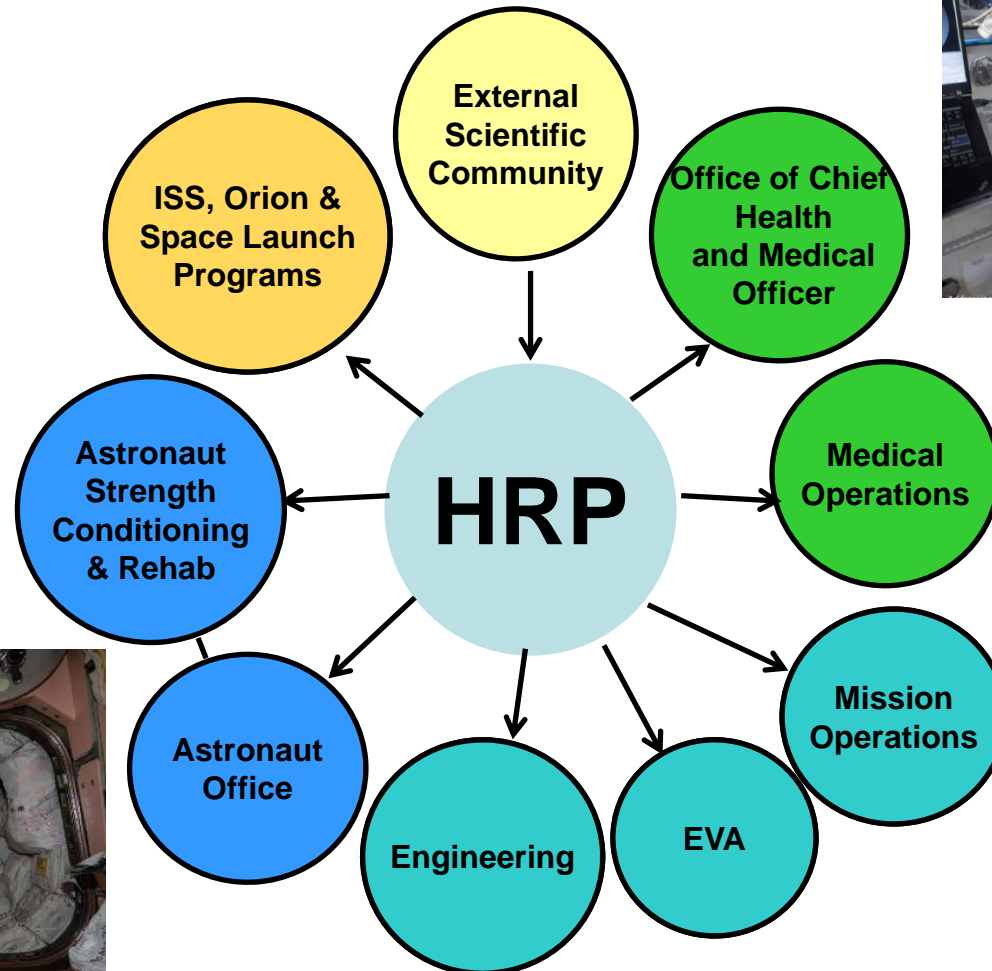



Human Research Program Architecture

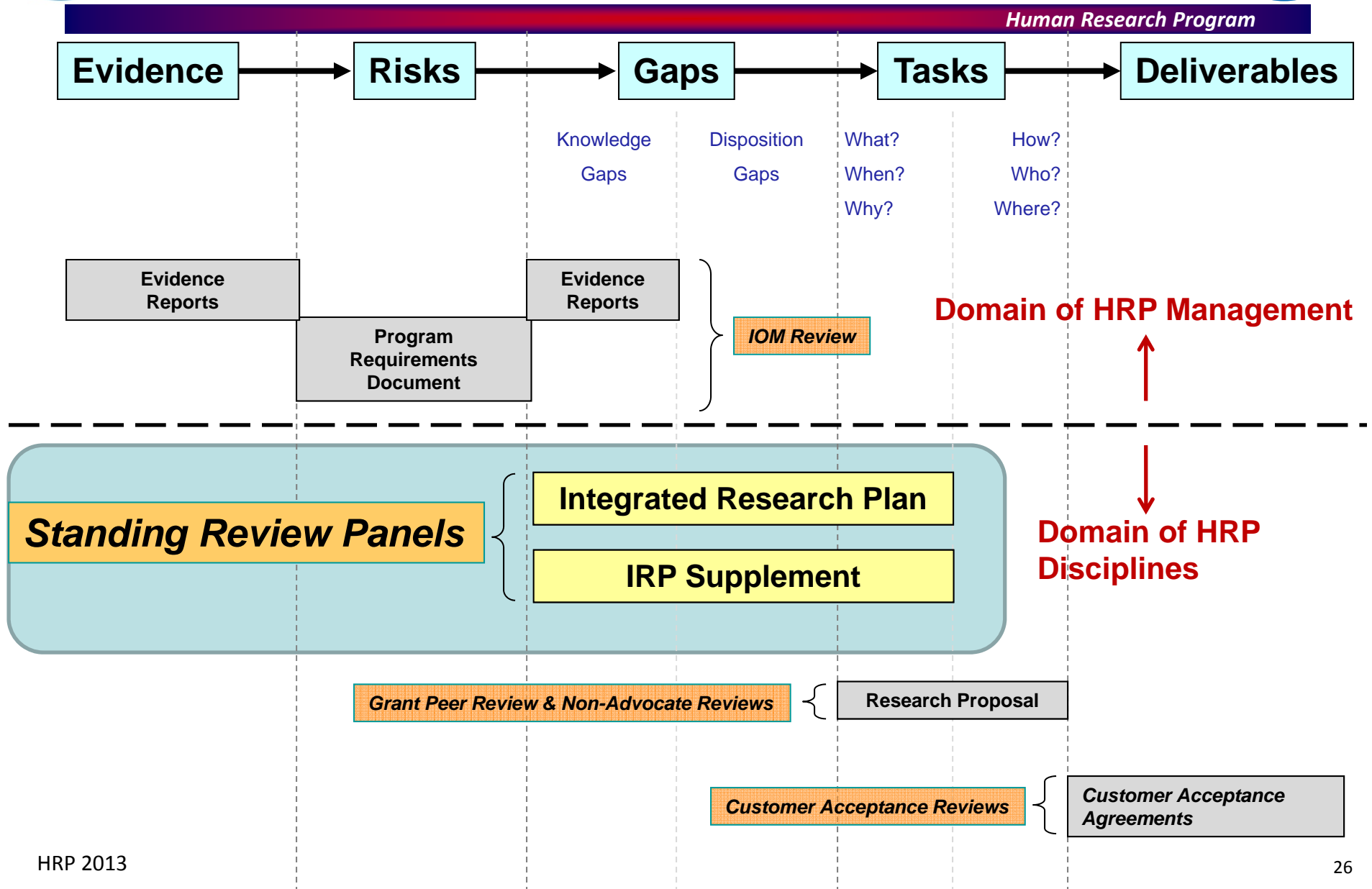
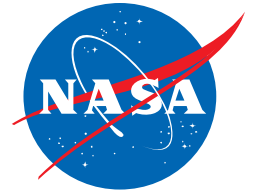



Human Research Program 2013

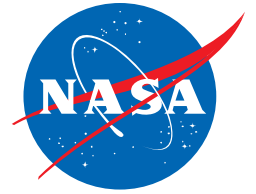

Human Research Program

- **Maximizing Utilization of ISS**
 - 1 year mission and Twins study
 - Test countermeasures: Determine long term response
 - Autonomous operations
 - Maximizes resources by combining individual investigations into integrated studies
 - **Subject number**
- **Human Exploration Research Analog**
- **Gap Metrics & Path to Risk Reduction**
- **Data accessibility**
 - Life Sciences Data Archive (LSDA)
 - Lifetime Surveillance of Astronaut Health (LSAH)
 - Human Performance Data (HPDP)
- **Some research informs vehicle design**





HRP Research Environment

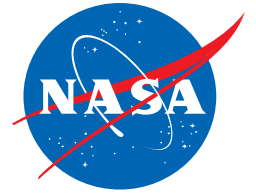

Human Research Program

- HRP conducts risk based research.
- Flexibility to replan or address new issues as needed.
- Limited time to get the “best” answer.
- Unique constraints.
 - Small “n”
 - HRP considers ISS 1 year mission and ‘n’= 1 worthwhile
 - Constrained environments and often poorly controlled, less than ideal research conditions
- HRP & NASA must make important decisions based on current information available.
- While awaiting a specific design reference mission HRP proactively defines critical mission attributes to guide research.
 - Example: Duration (< 6 mo., > 6 mo.), communication delay
- Obtain information and devices that have an immediate benefit to planned NASA exploration missions.
- Require access to exploration conditions, microgravity and space radiation.
 - ISS and appropriate terrestrial analogs

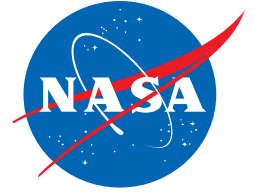

How large does 'n' need to be?

Human Research Program

- Detecting meaningful changes/effects, for example, the ability of a novel intervention to reduce negative consequences of spaceflight on the human by XX %, relative to current standards.
- Flexibility for NASA to balance research resources across identified risks given low 'n' and constrained research conditions

NASA → can be a leader in refining and promoting approaches to small 'n' research

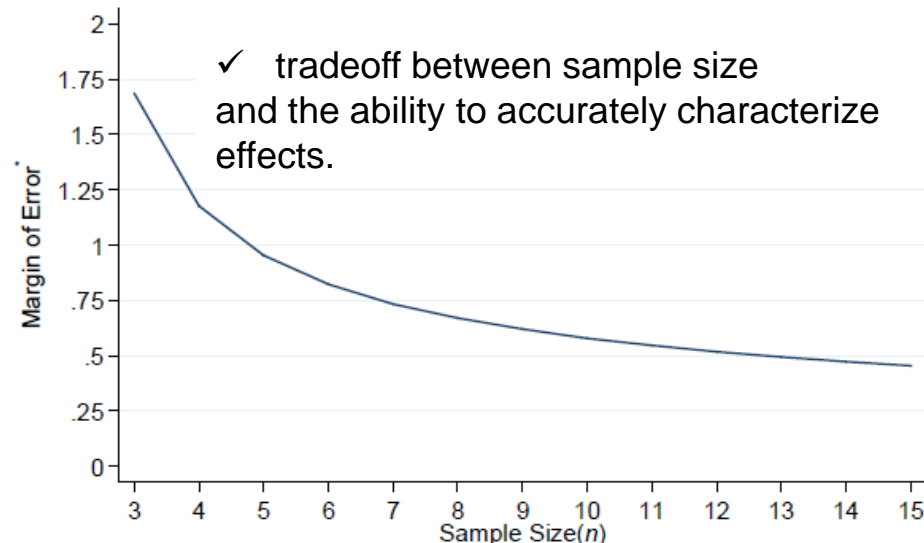
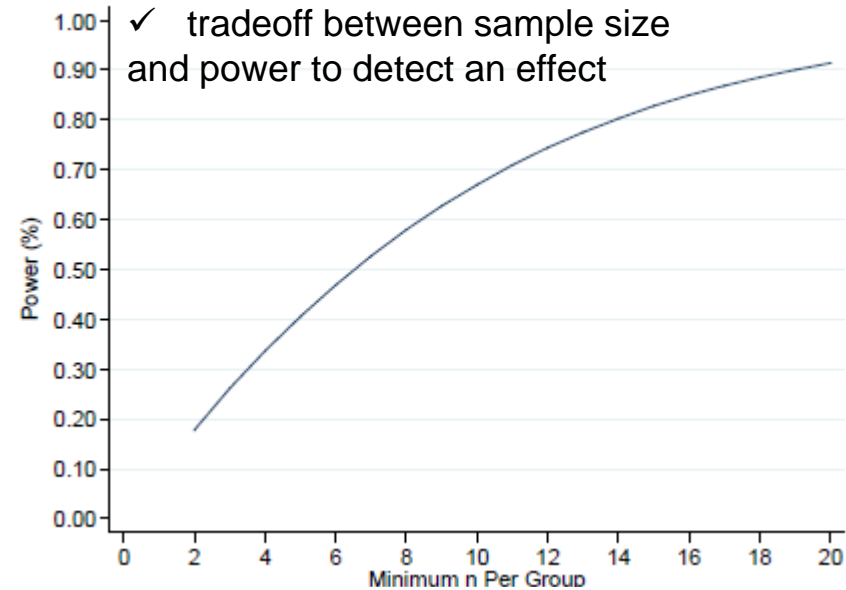



Human Exploration Research Analog HERA

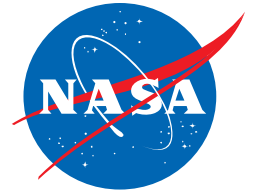

Human Research Program

- Analog for simulation of isolation, confinement and remote conditions of mission exploration scenarios.



To support studies such as:

- ✓ Behavioral health and performance assessments
- ✓ Communication and autonomy
- ✓ Human factors evaluations
- ✓ Exploration medical capabilities assessments and operations

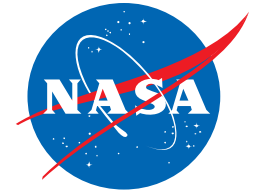

Human Research Program Metrics for Research Gap/Risk Closure

Human Research Program

Gap Metrics

- Requires focus on risk reduction
- Identify
 - Initial state of knowledge
 - Target for Closure
 - Interim steps and associated tasks required to close the gap including schedule
 - Research approach – logic and relationship of tasks and deliverables leading to gap closure and risk reduction

Gap Closure

- Requires demonstration of significance to risk reduction
 - Completion of deliverables per the HRP Integrated Research Plan (or Customer Supplier Agreement)
 - Scientific assessments
 - Changes to evidence/knowledge base
 - Impacts to risk posture
 - Research replanning – changes to gaps and metrics

Risk Reduction

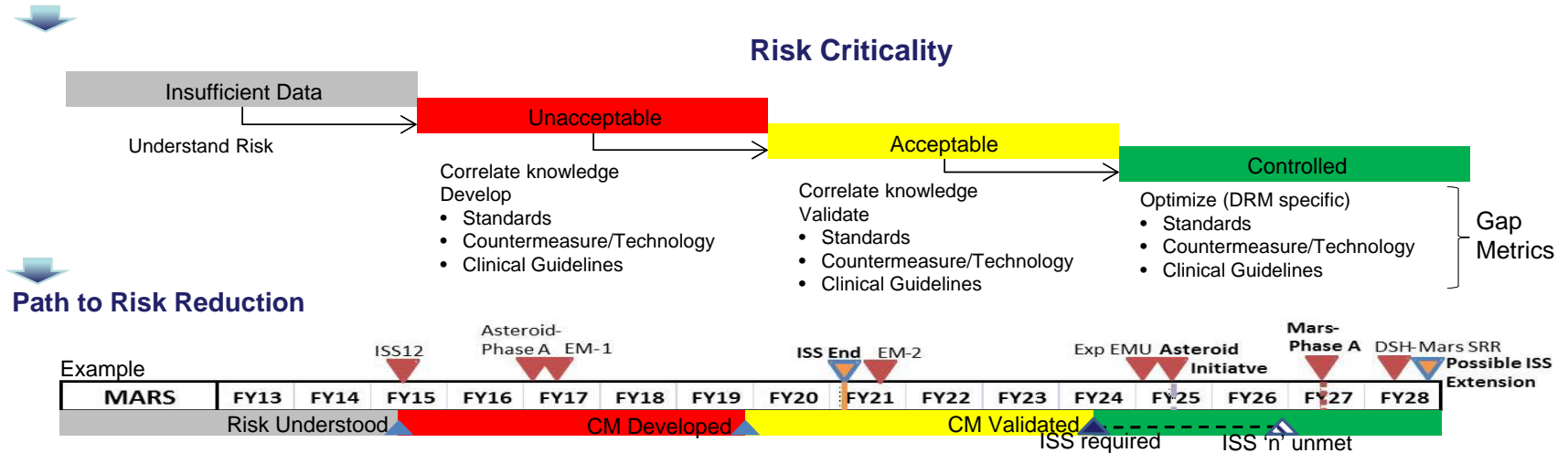



HRP Path To Risk Reduction

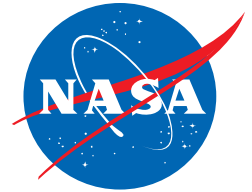

Human Research Program

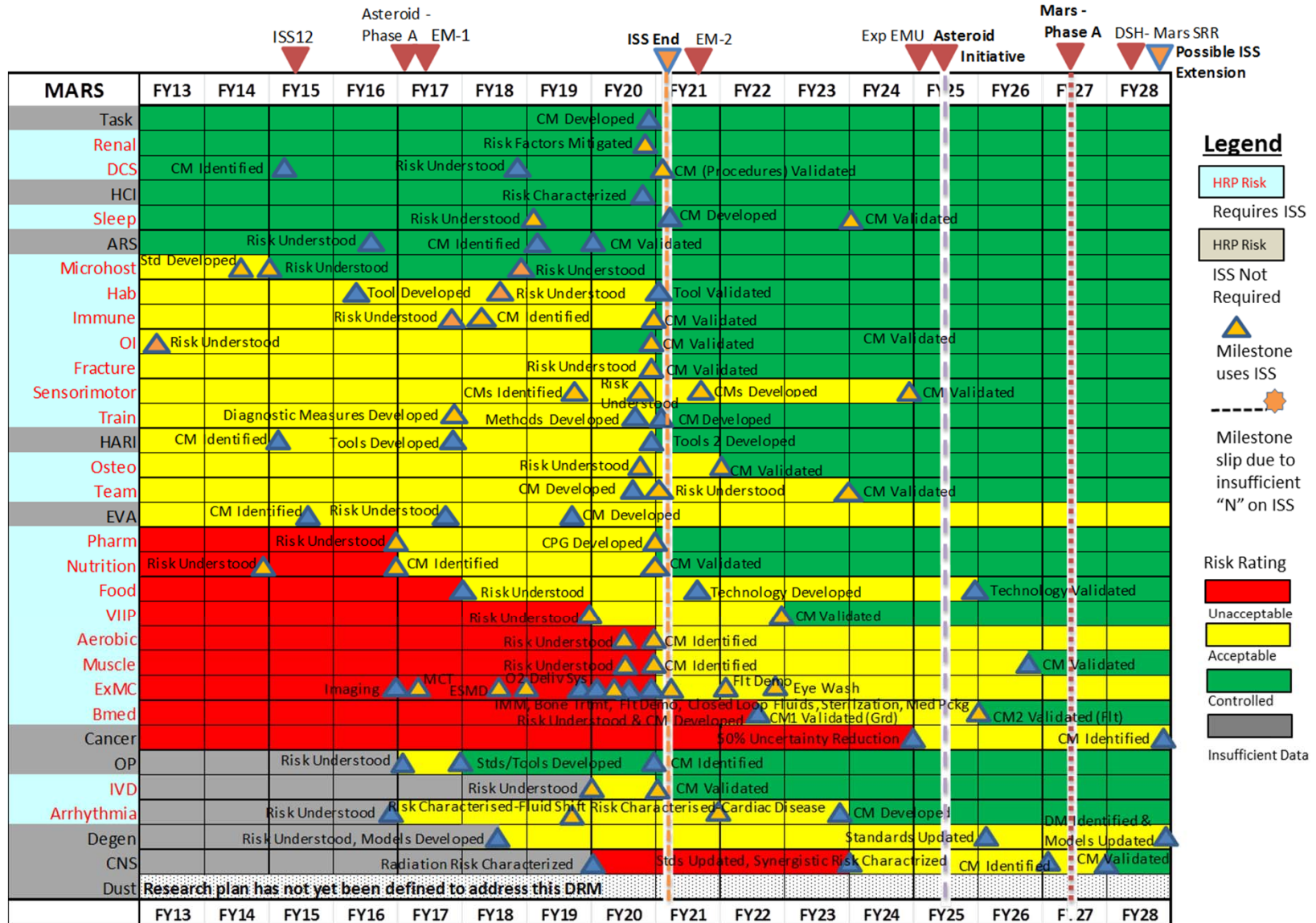

Legend

- HRP Risk (Red box)
- Requires ISS (Green box)
- HRP Risk (Yellow box)
- ISS Not Required (Grey box)
- Milestone uses ISS (Blue triangle)
- Milestone slip due to insufficient "N" on ISS (Orange star)

Risk Rating

- Unacceptable (Red)
- Acceptable (Yellow)
- Controlled (Green)
- Insufficient Data (Grey)



Conclusion

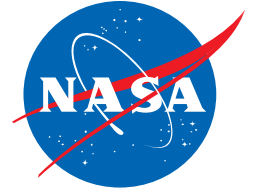

Human Research Program

- The Human Research Program is an applied research program
 - Focus on solving problems
 - Subject to many types of constraints (example: budget, subject availability, operational restrictions)
 - Primary customers are the Chief Health & Medical Officer, ISS, Orion Program, Mission Operations, Astronaut Office, and Astronaut Strength Conditioning & Rehabilitation Specialists
- humanresearch.roadmap.nasa.gov
 - Captures Evidence → Risks → Gaps → Tasks → Deliverables
- Major HRP efforts
 - ISS Utilization (international coordination, 12-month mission)
 - Reformulating Gaps & Path to Risk Reduction
 - Subject number
 - Exploration Analogs
 - Data Accessibility



Statement of Task – Evidence Review

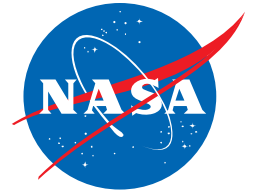

Human Research Program

1. Evaluate the 2013 Evidence Report based on each of the following criteria:
 - A. Does the Evidence Report provide sufficient evidence that the Risk is relevant to long-term space missions?
 - B. Is the Risk properly stated in the HRP Program Requirements Document (PRD)?
 - C. Is the text of the short description of the Risk provided in the HRP PRD clear?
 - D. Does the evidence make the case for the knowledge-type gaps presented ?
 - E. Are there any additional knowledge-type gaps in knowledge that should be considered for this specific Risk?
 - F. Does the Evidence Report address relevant interactions between this Risk and others in the HRP PRD/IRP (Integrated Research Plan)?
 - G. Are the qualifications of the author(s) appropriate for identifying the evidence necessary to characterize the given Risk?
 - H. Is there information from other disciplines that need to be included in the Evidence Report?
 - I. Is the breadth of the cited literature sufficient?
 - J. What is the overall quality and readability of the Evidence Report?

2. Provide comments on any important issues that are not covered by the criteria above.



Statement of Task – Status Review

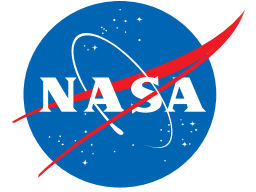

Human Research Program

1. Receive an update by the HRP Chief Scientist or Deputy Chief Scientist on the status of NASA's current and future exploration plans and the impact these will have on the HRP.
2. Receive an update on any changes within the HRP (example... HERA) since the 2012 SRP meeting.
3. Receive an update by the Element or Project scientist on progress since the 2012 SRP meeting.
4. Participate in a discussion with the HRP Chief Scientist, Deputy Chief Scientist, and the Element regarding possible topics to be addressed at the next SRP meeting.



Statement of Task- Research Plan Review

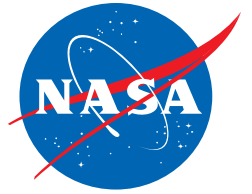

Human Research Program

1. Evaluate the ability of the IRP to satisfactorily address the Risk by answering the following questions:
 - A. Have the proper Gaps been identified to address the Risk?
 - Are all the Gaps relevant?
 - Are any Gaps missing?
 - B. Has the appropriate target for closure for the Gap been identified?
 - Are the interim stages appropriate to close the Gap?
 - C. Have the proper Tasks been identified to fill the Gaps?
 - Are the Tasks relevant?
 - Are any Tasks missing?
 - D. If a Gap has been closed, does the Rationale for Gap Closure provide the appropriate evidence to support the closure?
 - E. The Risk is nearing completion, but the last task will not be completed until 2018. Are there any additional tasks that should be done prior to the Risk closing? Is the remaining task necessary to complete for Risk closure?
2. Identify the strengths and weaknesses of the IRP *and* identify remedies for the weaknesses, including answering these questions:
 - A. Is the Risk addressed in a comprehensive manner?
 - B. Are there obvious areas of potential integration across disciplines that are not addressed?
3. Evaluate the progress in the IRP since your 2012 SRP meeting.
4. Comment on any important issues that are not covered in #1, #2, or #3 above. If addendum questions are provided please address each of the questions as fully as possible.



What Do We Want From The SRP?

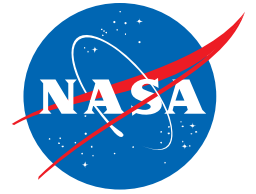

Human Research Program

Help us determine:

- **Are we doing the right science?**
 - **Are we doing it the right way?**
- ✓ Please review our strategy not tactics for mitigating risk.
- Do we have the right gaps?
 - Do we have the right tasks?
- ✓ Are there areas of fundamental knowledge or mechanism that would allow us to better assess our tasks and gaps that we don't have?



Back Up

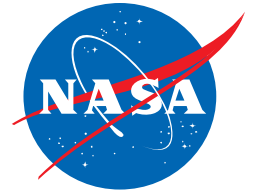

Human Research Program

Supporting or additional explanatory materials



ARM

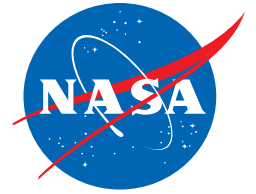

Human Research Program

- **Asteroid Redirect Mission (ARM)**
 - Asteroid Identification Segment
 - Ground and space based NEA target detection, characterization, and selection
 - Asteroid Redirection Segment
 - Solar electric propulsion (SEP) based robotic asteroid redirect to trans-lunar space
 - Asteroid Crewed Exploration Segment
 - Orion and SLS ^{W5} based sampling mission to the relocated asteroid

Slide 39

W5

BH: acronym needs definition please

Wyleuser, 9/13/2013



TWINS STUDY

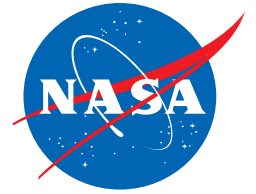

Human Research Program

- Differential Effects on Homozygous Twin Astronauts Associated with Differences in Exposure to Spaceflight Factors
 - NNJ13ZSA002N-TWINS
 - Released: July 30, 2013
 - singular opportunity to propose limited, short-term investigations of the differences in genetic, proteomic, metabolomic and related functions in twin male monozygous astronauts associated with differential exposure to spaceflight conditions
 - opportunity has emerged from NASA's decision to fly veteran NASA astronaut Scott Kelly aboard the International Space Station (ISS) for a period of one year commencing in March 2015, while his identical twin brother, retired NASA astronaut Mark Kelly, remains on Earth.



UNIQUE CONSTRAINTS

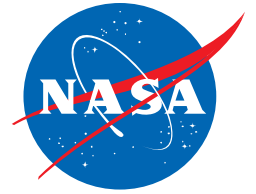

Human Research Program

- Currently the maximum number of crewmembers on board the ISS at any given time is six (three Russian crewmembers and three United States Operations Segment crewmembers (includes International Partner agencies Europe, Canada, and Japan))
- On-orbit durations are approximately six months and crew rotation is staggered
- Periods when only three crewmembers are onboard the ISS
- The maximum number of subjects per year for any one experiment is six, but plan of four due to other constraints (e.g., non-interference investigations, resource limitations) and crew consent

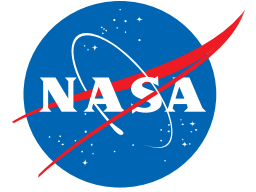

Data Accessibility

Human Research Program

- NASA continues to recognize the imperative of astronaut data accessibility by researchers and clinicians to improve astronaut health care and spaceflight risks, as well as to increase knowledge base in general
- **NEW: Coordinate and improve data sharing among the international partners**
- Continuing efforts to improve data accessibility
 - Astronaut clinical database: Lifetime Surveillance of Astronaut Health (LSAH, formerly Longitudinal Study of Astronaut Health)
 - Astronaut-based research database: Life Sciences Data Archive (LSDA).
 - Access to both via <http://lsda.jsc.nasa.gov/>
 - Requestor describes required data without need to specify source.
 - Epidemiologist(s) identify data source, availability and sensitivity, and provide data set
 - Improve data accessibility with minimum impediments while complying with federal regulations and NASA policies on confidentiality, informed consent, etc



HRP Element Path to Risk Reduction

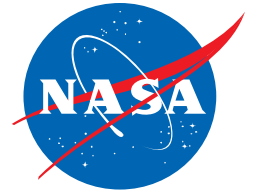

Human Research Program

Human Research Program
Integrated Research Plan, Revision E

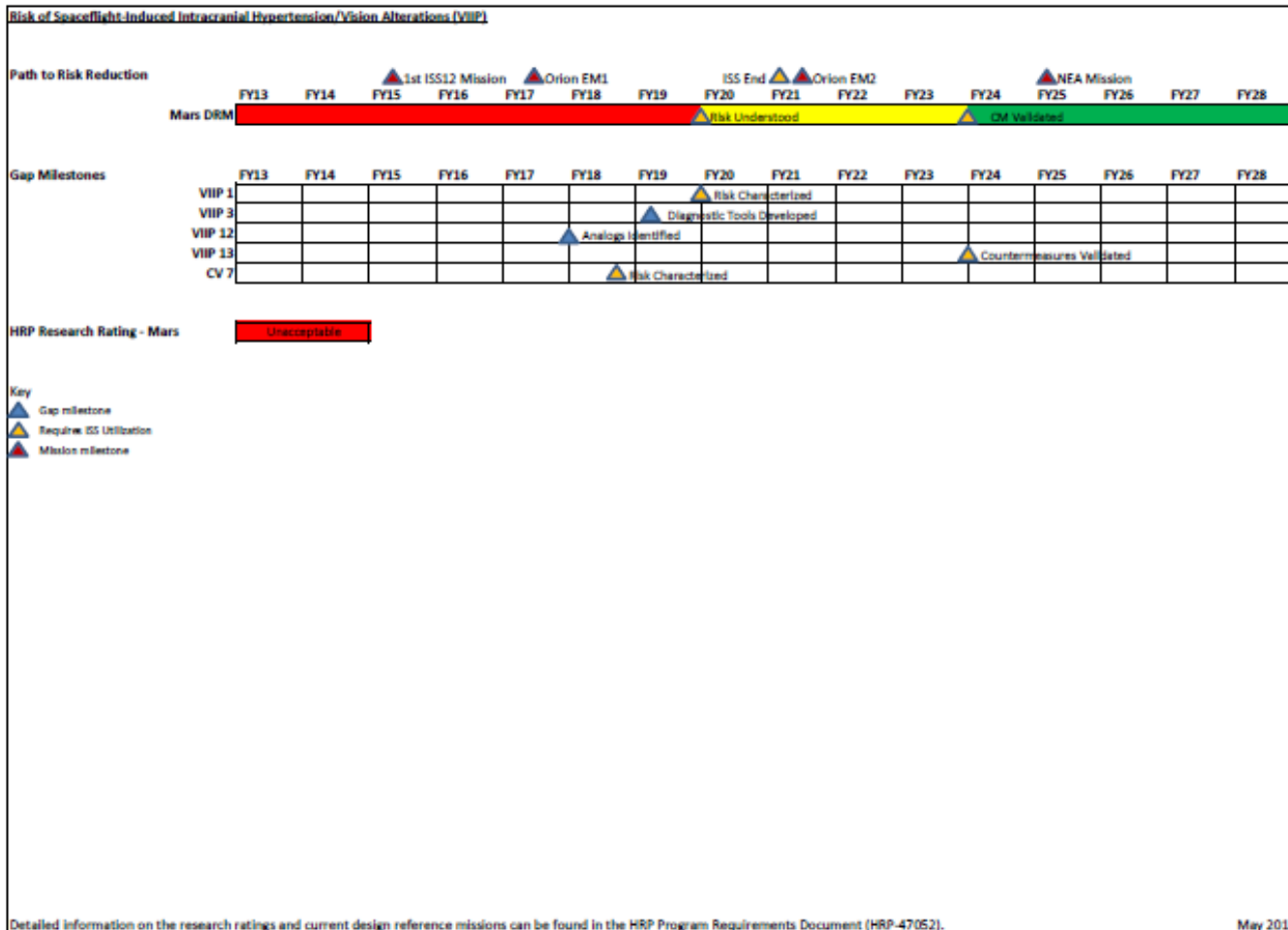



Nutrition and Acceptability Impacts of Room Temperature Storage

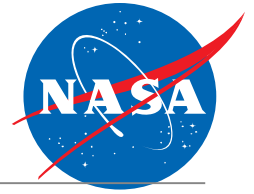

- Critical micronutrients show concerning degradation in space food system after 1 year of storage.
- Only 7 out of 65 thermostabilized foods are expected to be palatable after 5 years of storage. (Catauro. JFS. 2011)
- Current mass requirement for 3000 kcal per crewmember per day is 1.83 kg. Total mass for a Mars scenario (6 crewmembers, 1095 days) is 12,023 kg.

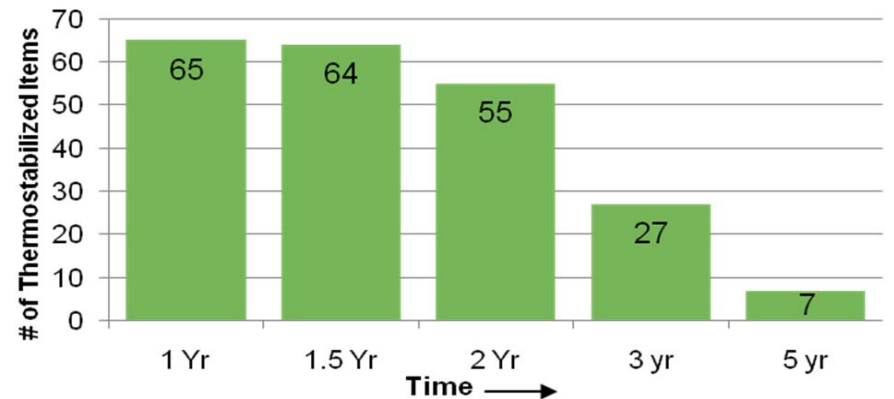
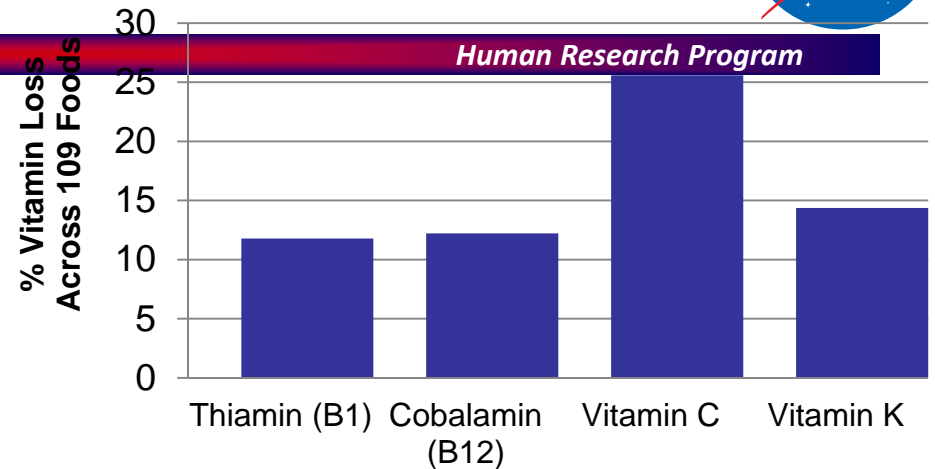



Prepackaged Food – 5 Year Shelf Life Challenge

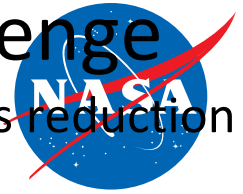

Focus on nutritional stability, acceptability, health promotion, and mass reduction

Human Research Program

Processing



Pressure Assisted Thermal Sterilization (PATS)

Lyophilization Improvement

Microwave Sterilization

3D Printing Technology (SBIR)

Packaging



Improve clarity
Improve barrier
Mass reduction

Formulation



Fortification
Food Matrix
Functional Foods
Meal Replacement

Environment



21°C

-80°C

Atmosphere
Temperature
Radiation

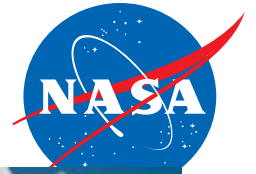

Integrate Bioregenerative Foods

- ISS: Supplement prepackaged with “Pick and Eat” in microgravity transit
- Mars Scenario: Optimize mission specific phased implementation and balance with prepackaged foods – based on nutrition, acceptability, resources
- Benefits: initial food upmass, nutrition, variety, acceptability, psychosocial
- Research gaps: infrastructure, resource use, radiation effects, safe handling/micro procedures, system integration, crew time usage



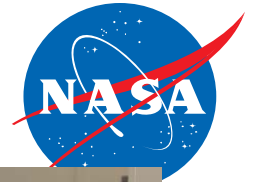

Completed AFT Projects FY12-13

- Food Processing vs. Packaged Food Study
Analyzed mass and crew time trades for bioregenerative food system compared to prepackaged; developed 90 formulations from 15 crops and 11 ingredients
- Mass Reduction Technology Development
Developed meal replacement bar and beverage prototypes with significant mass reduction capability
- Suited Contingency Ops Food - 2
Developed delivery system prototype, both package and beverage requirements





Space Food System Sodium Reduction Challenge

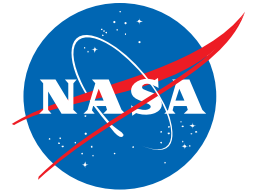

Human Research Program

- Sodium exacerbates bone loss, possible factor in intracranial induced vision changes
- Reformulated 90 foods and reduced sodium content to ~3300 mg/d
- Maintained sensory acceptability similar to or better than original formulations (score of 6.0 or greater on a 9.0 point hedonic scale).

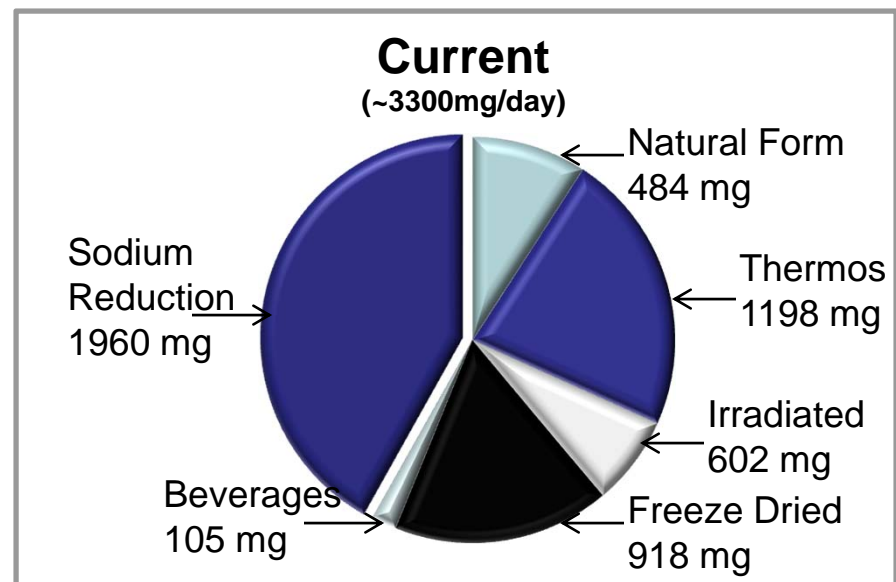
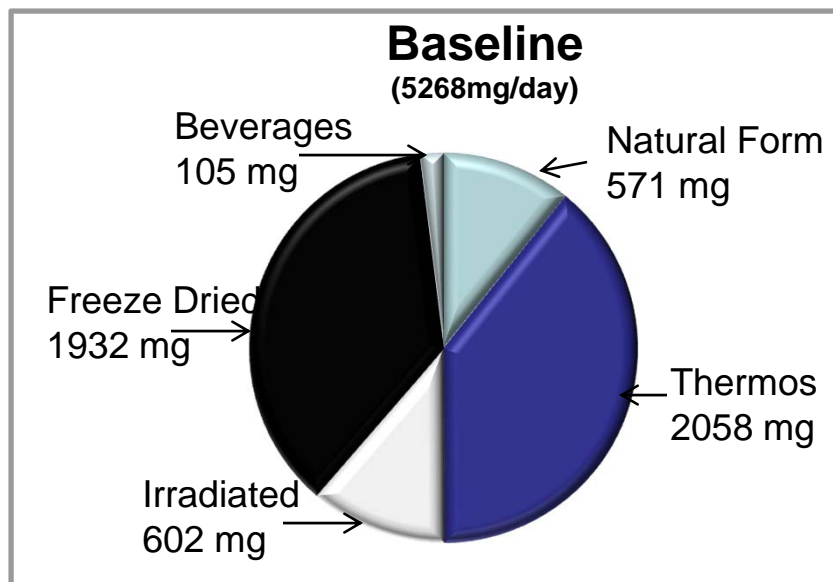



Acknowledgments

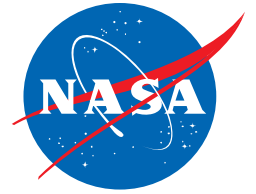

Human Research Program

- Maya Cooper
- Monica Leong
- John Glass
- Vickie Kloeris
- Donna Nabors
- Kimberly Glaus-Late
- Michele Perchonok, Ph.D. (former AFT Project Scientist)



Questions

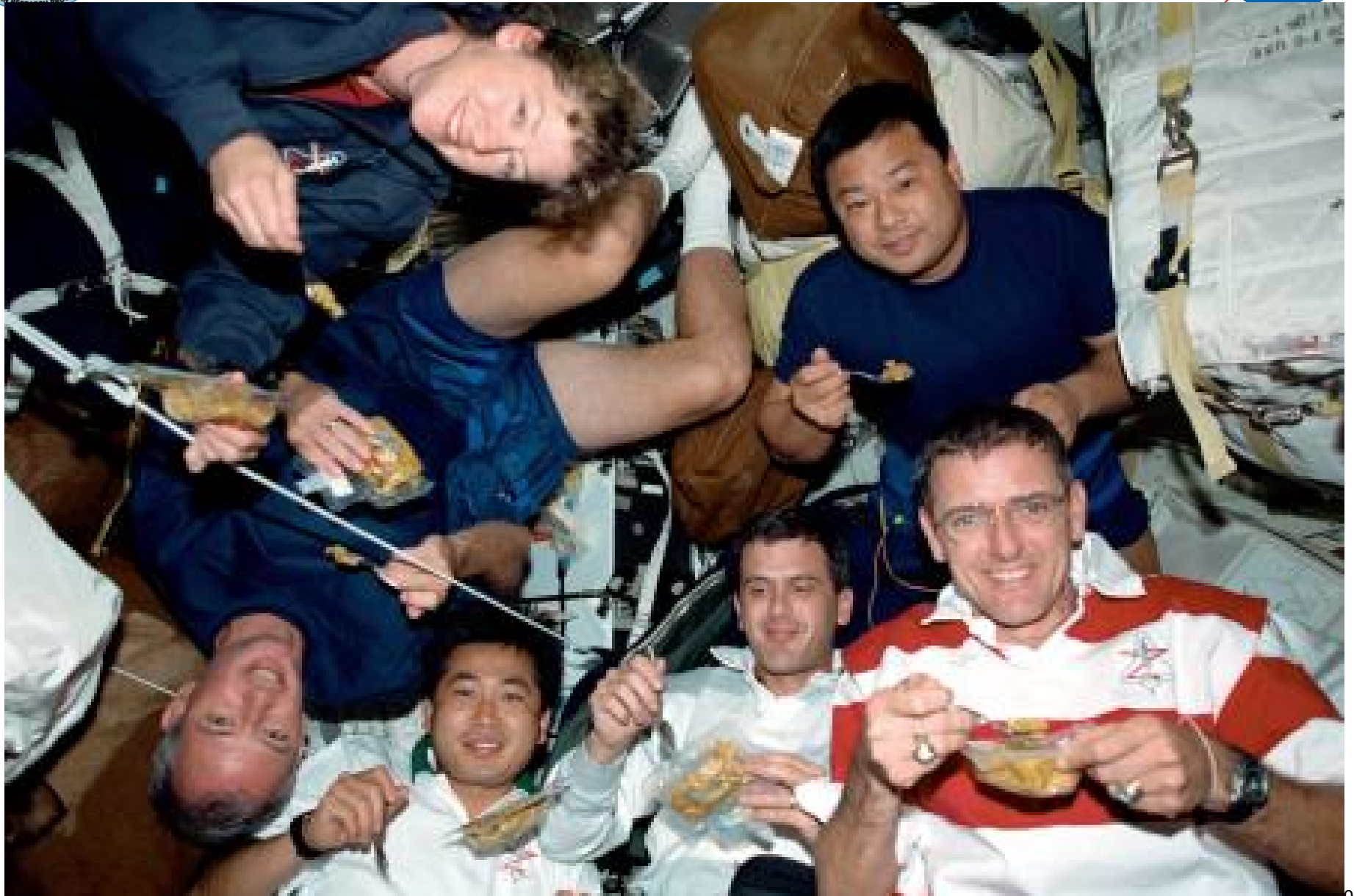
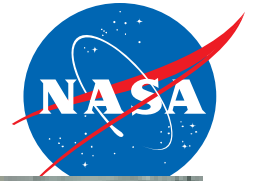

7/9/2014