

Design Concepts for a Small Space-Based GEO Relay Satellite for Missions between Low Earth and Near Earth Orbits

Kul Bhasin,¹ Joseph Warner,² Steven Oleson³
NASA Glenn Research Center, Cleveland, OH 44135

and

James Schier,⁴
NASA Headquarters, Washington, DC, 20546

The main purpose of the Small Space-Based Geosynchronous Earth orbiting (GEO) satellite is to provide a space link to the user mission spacecraft for relaying data through ground networks to user Mission Control Centers. The Small Space Based Satellite (SSBS) will provide services comparable to those of a NASA Tracking Data Relay Satellite (TDRS) for the same type of links. The SSBS services will keep the user burden the same or lower than for TDRS and will support the same or higher data rates than those currently supported by TDRS. At present, TDRS provides links and coverage below GEO; however, SSBS links and coverage capability to above GEO missions are being considered for the future, especially for Human Space Flight Missions (HSF). There is also a rising need for the capability to support high data rate links (exceeding 1 Gbps) for imaging applications. The communication payload on the SSBS will provide S/Ka-band single access links to the mission and a Ku-band link to the ground, with an optical communication payload as an option. To design the communication payload, various link budgets were analyzed and many possible operational scenarios examined. To reduce user burden, using a larger-sized antenna than is currently in use by TDRS was considered. Because of the SSBS design size, it was found that a SpaceX Falcon 9 rocket could deliver three SSBSs to GEO. This will greatly reduce the launch costs per satellite. Using electric propulsion was also evaluated versus using chemical propulsion; the power system size and time to orbit for various power systems were also considered.

This paper will describe how the SSBS will meet future service requirements, concept of operations, and the design to meet NASA users' needs for below and above GEO missions. These users' needs not only address the observational mission requirements but also possible HSF missions to the year 2030. We will provide the trade-off analysis of the communication payload design in terms of the number of links looking above and below GEO; the detailed design of a GEO SSBS spacecraft bus and its accommodation of the communication payload, and a summary of the trade study that resulted in the selection of the Falcon 9 launch vehicle to deploy the SSBS and its impact on cost reductions per satellite.

Nomenclature

| | |
|---------|---|
| COMPASS | = Collaborative Modeling for Parametric Assessment of Space Systems |
| C&DH | = Command and Data Handling |
| DARPA | = Defense Advanced Research Projects Agency |
| DPAF | = Dual Payload Attach Fitting |
| Eb/N0 | = Energy per bit to noise power spectral density ratio |
| EIFP | = Effective Isotropic Radioactive Power |
| EM | = Earth-Moon |
| EML | = Earth-Moon LaGrange Point |

¹ Sr. Space Communications Architect, Space Operations Projects Office, NASA Glenn Research Center, M.S. 142/4 21000 Brookpark Road, Cleveland, OH 44135, AIAA Associate Fellow

² Microwave Physicist, Aerospace Communications Systems Branch, NASA Glenn Research Center, M.S. 54/4 21000 Brookpark Road, Cleveland, OH 44135

³ Collaborative Modeling for Parametric Assessment of Space Systems Team Lead, Mission Design and Analysis Branch, NASA Glenn Research Center, M.S. 142/6 21000 Brookpark Road, Cleveland, OH 44135

⁴ Chief Architect and Planning Systems Manager, Space Communications and Navigation Office, Human Exploration and Operations Mission Directorate, 300 E Street NW, Washington, D.C. 20546, AIAA Senior Member

| | |
|-------|---|
| G/T | = Gain/System Noise Temperature |
| GEO | = Geosynchronous Earth Orbiting |
| HSF | = Human Space Flight Missions |
| IF | = Intermediate Frequency |
| L1 | = LaGrange Point 1 |
| L2 | = LaGrange Point 2 |
| LCRD | = Laser Communications Relay Demonstrations |
| LEO | = Low Earth Orbit |
| LNA | = Low Noise Amplifier |
| LRO | = Lunar Reconnaissance Orbiter |
| MA | = Multiple Access |
| Mbps | = Megabits per second |
| MEL | = Master Equipment List |
| MPCF | = Multi-Purpose Crew Vehicle |
| NASA | = National Aeronautics and Space Administration |
| NEA | = Near-Earth Asteroids |
| NEO | = Near-Earth Orbit |
| NSSK | = Needham-Schroeder Shared-Key protocol |
| PEL | = Power Equipment List |
| QPSK | = Quadrature Phase Shift Key |
| RF | = Radio Frequency |
| SA | = Single Access |
| SCaN | = NASA's Space Communications and Navigation |
| SGL | = Space to Ground Link |
| SSBS | = Small Space-Based Satellite |
| TDRS | = Tracking Data Relay Satellite |
| TDRSS | = Tracking Data Relay Satellite System |
| TRL | = Technology Readiness Level |
| TT&C | = Telemetry Tracking and Command |
| TWT | = Traveling Wave Tube |
| TWTA | = Traveling Wave Tube Amplifier |
| UNS | = User Needs Study |

I. Introduction

Several initiatives have taken place within NASA¹ and international space agencies² to create a human exploration strategy for expanding human presence into the solar system; these initiatives have been driven by multiple factors to benefit Earth. Of the many elements in the strategy one stands out: to send robotic and human missions to destinations beyond Low Earth Orbit (LEO), including cis-lunar space, Near-Earth Asteroids (NEAs), the Moon, and Mars and its moons.^{3, 4} The time frame for human exploration to various destinations, based on the public information available,^{1, 4} is shown in Figure 1. Advance planning is needed to define how future space communications services will be provided in the new budget environment to meet future space communications needs. The spacecraft for these missions can be dispersed anywhere from below LEO to beyond GEO, and to various destinations within the solar system. NASA's Space Communications and Navigation (SCaN) program office provides communication and tracking services to space missions during launch, in-orbit testing, and operation phases. Currently, SCaN's space networking relay satellites mainly provide services to users below GEO, at Near Earth Orbit (NEO), below LEO, and in deep space. The potential exists for using a space-based relay satellite, located in the vicinity of various solar system destinations, to provide communication space links to missions both below and above its orbit. Such relays can meet the needs of human exploration missions for maximum connectivity to Earth locations and for reduced latency. In the past, several studies assessed the ability of satellite-based relays working above GEO in conjunction with Earth ground stations. Many of these focused on the trade between space relay and direct-to-Earth station links^{5,6,7}. Several others focused on top-level architecture based on relays at various destinations^{8,9,10,11,12}. Much has changed in terms of microwave and optical technology since the publication of the referenced papers; Ka-band communication systems are being deployed, optical communication is being demonstrated, and spacecraft buses are becoming increasingly more functional and operational. A design concept

study was undertaken to access the potential for deploying a Small Space-Based Satellite (SSBS) relay capable of serving missions between LEO and NEO.

The needs of future human exploration missions were analyzed, and a notional relay-based architecture concept was generated as shown in Fig. 1. Relay satellites in Earth through cis-Lunar orbits are normally located in stable orbits requiring low fuel consumption. Relay satellites for Mars orbit are normally selected based on the mission requirement and projected fuel consumption. Relay satellites have extreme commonalities of functions between them, differing only in the redundancy and frequencies used; therefore, the relay satellite in GEO was selected for further analysis since it will be the first step in achieving a relay-based architecture for human exploration missions (see Fig. Figure 2). The mission design methodology developed by the Collaborative Modeling for Parametric Assessment of Space Systems (COMPASS) team¹³ was used to produce the satellite relay design and to perform various design trades. At the start of the activity, the team was provided with the detailed concept of the notional architecture and the system and communication payload drivers.

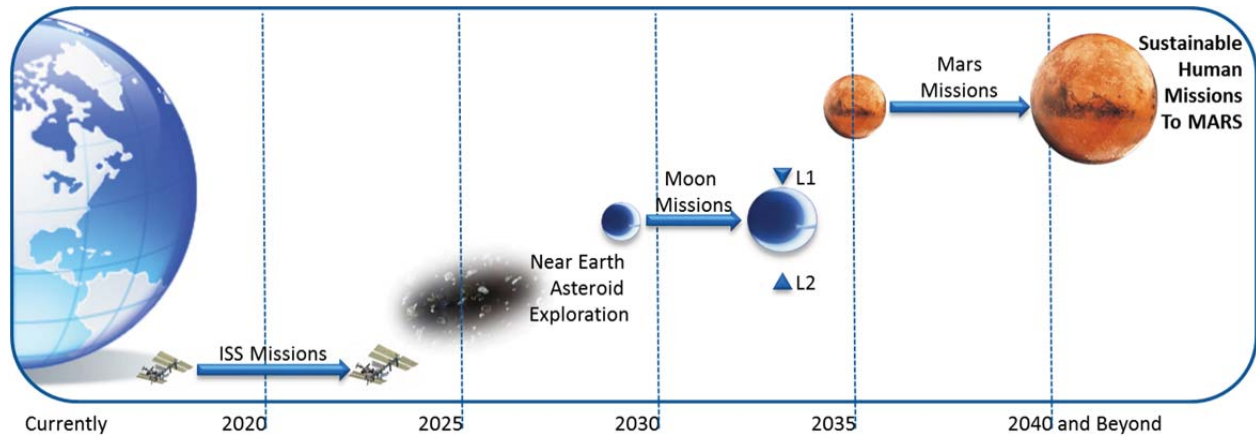

Figure 1. Human exploration destinations timeline

The total COMPASS effort takes about two weeks, after which a report is generated. The report includes a detailed design of the spacecraft, a description of each sub-system and its properties, a mission feasibility determination based on the design effort, a list of possible launch vehicles, the total mass and power requirements during the various phases, and a final cost estimate for the entire mission, including non-recurring engineering costs.

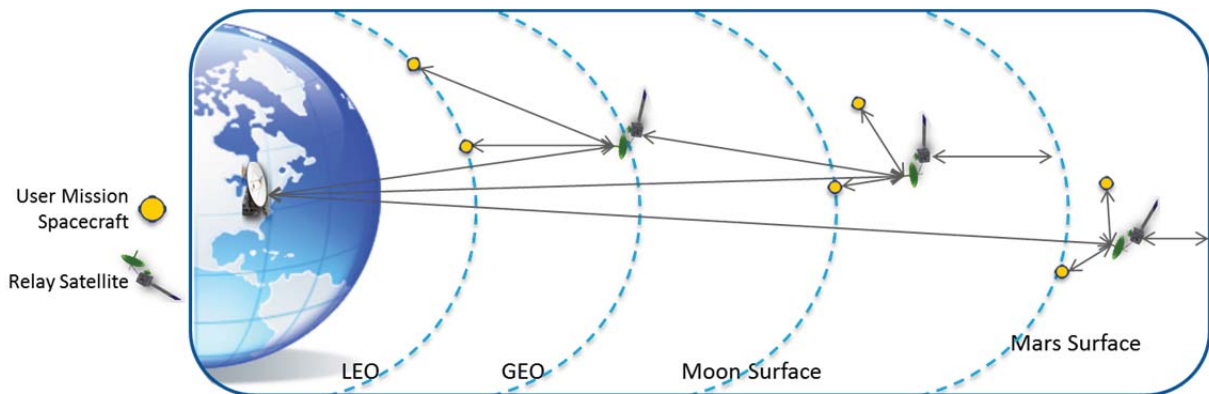

Figure 2. Spaced-based relay communication infrastructure concept

This paper presents an SSBS design concept capable of filling the needs of the future NASA SCaN communication¹⁴ missions while also reducing costs. It will describe:

- The notional architecture, top-level requirements and constraints (Section II)
- System design drivers (Section III)
- SSBS architecture at GEO (Section IV)

- Details of the communication payload and SSBS design (Sections V and VI)
- SSBS design with an optical payload (Section VII)
- Launch vehicle selection (Section VIII)
- Final analysis and risks (Sections IX)
- Conclusions (Section X)

II. Mission Users Needs and Assumed Requirements

A. User Needs

User needs are identified based on the NASA future mission plans⁴ and projection of current mission needs. The user communication needs in the key locations in Fig. Figure 2 were identified based on the mission being planned for human space exploration. For below GEO, mission needs for weather satellites, science, and other missions were considered as well. The level of certainty in identifying user needs decreases with respect to the time period for the planned missions.

Table 1 shows the summary of user communication needs by location. The need for 24/7 real-time services at high data rates is independent of the locations.

Table 1. Summary of human user communication needs by location

| USE CASE | LEO Ops | LEO Ops Servicing | Asteroid Retrieval | Asteroid Examination | Cis-Lunar Crewed Mission | MARS |
|---|---|---|--|---|---|---|
| DESCRIPTION | Services for operations and other systems (e.g., “hosted service payloads) on a large spacecraft with humans and large Earth observing missions | Services for short durations (<1 week) missions servicing LEO orbiting HSF platforms (e.g., ISS) with special needs during critical maneuvers (e.g., docking) | Robotic spacecraft to examine and direct a rock (asteroid) in space | Large spacecraft with humans (e.g., Multi-Purpose Crew Vehicle (MPCV)) to examine a rock (asteroid) in space. | Long duration missions with a spacecraft hosting humans (e.g., habitat) | Long duration missions with a large spacecraft with humans visiting Mars. |
| MAXIMUM DATA RATE: | [TBD] | [Continuous at 350 kb/s] | [TBD] | [TBD] 24/7: a few hours of continuous HDTV | [TBD] 24/7: a few hours of HDTV | Intermittent and continuous [HDTV + all status sensor data] |
| Maximum data rate found was 1.2 Gbps | [TBD] | [TBD] | [TBD] | [TBD] | [TBD] | [TBD] |
| MAXIMUM LATENCY: (Return) Min | “real-time” 24/7 (core data) [Note: ISS does not always schedule 24/7 coverage] | “real-time” data during docking and other critical maneuvers | [TBD] [May require “near real-time” turnaround for tele-robotic ops] | “real-time” (core data) TBD other | “real-time” (core data) TBD other | “real-time” (core data) TBD other |

B. Assumed Requirements

To generate the assumed requirements for this design, the following assumptions were made.

- The satellite payload design provides the same services as current TDRS single access (SA) links at the chosen frequency bands with the same or lower user burden.
- The architecture will provide the service capability to meet the highest user need and most needs of other users.

- There will be sufficient design margins to meet expanding needs, and the satellite system will fulfill these needs.
- The frequency bands used will not be decided until the interface properties between different systems within the architecture are defined. The frequency bands selected to meet the interface requirements will be compatible to the international assignment of frequencies and applicable laws.
- Spacecraft power and size will allow multiple satellites to be launched at the same time.
- The best technology that provides reductions in cost, power, and mass and that is at Technology Readiness Level (TRL) 8 by the mission approval date will be used to define the internal satellite architecture's functions.

C. Constraints

Because of the flat budget environment in the foreseeable future, affordability is a major constraint. The design concepts will fully address extensibility, sustainability, and interoperability. Advance technologies which have potential to reduce costs will be fully considered.

D. Notional Relay-Based Architecture

The needs of the emerging Human Space Flight missions guided an architecture solution where the SSBS in GEO can link with the dedicated lunar-based relay or with missions in Earth-Moon (EM) L1/L2 locations. The top-level dedicated SSBS architecture is depicted in Fig. 3. It provides service for users above and below GEO. The potential human space flight missions currently in planning are the basis for this extension of the architecture.

The dedicated SSBS architecture will provide the most service capability for the future NASA communication infrastructure system, as defined by the user needs, when compared to the alternative options studied. To provide robustness and account for user uncertainty, the initial SSBS design will provide services that are significantly beyond the needs identified in the User Needs Study (UNS). The chosen implementation technologies will provide reductions in cost, power, and the mass of the SSBS; will decrease or maintain the user burden; and will have a maturity that is minimally at TRL 8 in 2017. The interface properties among different systems defined within the architecture will determine the frequency bands used.

In addition to providing current TDRS-like capabilities at possible enhanced data rates, several other options studied address new user needs or cost reductions. One of the design options considered was a small GEO with SA and Multiple-Access (MA) capabilities, with Low and High Data Rate SA Links, MA Arrays, and was deployable on a Falcon class launch vehicle. SA capability provides higher data rate services to user missions in space. MA capability will provide low data rate and tracking services to missions in space. Another option considered was an SSBS that has current TDRS capabilities with an added single access link capability to provide above GEO coverage for HSF missions. The list of other satellite configurations that were considered, but not designed for, in this study are:

- Small GEO with SA and MA capability deployed on a Falcon 9 class launch vehicle
- Small TDRS-like SSBS with an additional single aperture to communicate above GEO for support of HSF missions
- Hosted MA communication system on a command satellite

Several other SSBS options between these extremes with various combinations of optical links were also considered. Some of these options had limited technical analysis done for this study but have been noted in this report.

In addition to communications, this architecture will provide navigation services and will have the capability of providing non-coherent or coherent Doppler and PN ranging. SSBSs will be deployed in three regions with two slots per region. The different satellites in the slots will be of different generations to allow technology to evolve. This deployment scheme will meet the future mission needs below GEO.

Full integration of the dedicated SSBS with the ground infrastructure will be through future SCaN integrated network¹⁵ architecture. The future SCaN ground infrastructure will have rapid integration capability to the SSBSs, which will reduce complexity and cost. Each ground station contains multiple ground terminals and can be dedicated to a specific relay satellite at any given time. The ground terminals operate with a high degree of autonomy.

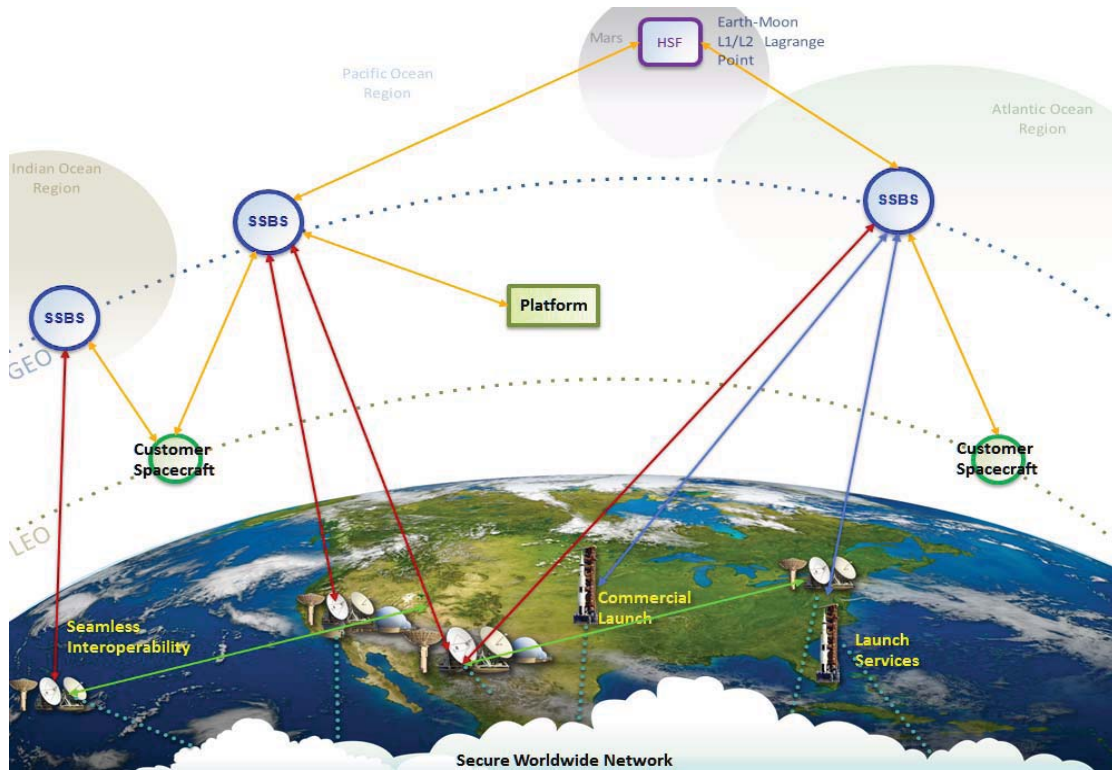

Figure 3. Notional relay-based architecture

Red line = space to ground links / Blue line = launch tracking service links / Yellow line = space to space link

E. Spacecraft and Communication Payload Requirements

Based on the assumed user needs, the following requirements for the spacecraft and communication payload were assumed.

- Single fault-tolerant system
- Propellant tanks that can be pressurized individually
- Adequate propulsive performance to carry out mission maneuvers
- Data rates
 - 1.2 Gbps from single earth orbit user
 - 80Mbps from lunar users
- Frequency bands
 - Single Access (SA)
 - One aperture
 - Dual band aperture
 - S-band
 - Ka-band
- Space to Ground Link (SGL)
 - Single band aperture
 - One aperture
 - Ku-band
- Provide at least the same Effective Isotropic Radioactive Power (EIFP) and Gain/System Noise Temperature (G/T) for SA as current TDRS have at S and Ka band. Provide at least the same EIRP for SGL.
- Incorporation of the optical communication link is based on the Laser Communications Relay Demonstrations (LCRD) Project¹⁶

III. SSBS System Design Drivers

A. Objectives and Design Drivers

The prime objective of the SSBS design concept is to reduce costs by utilizing a smaller dedicated bus based on the small GEO bus class and on developments in commercial launch to meet the user's requirements. The top-level drivers for this design concept are presented in Table 2.

Table 2. Spacecraft design requirements and summary

| Item | Assumptions and requirements | Trades |
|-------------------------------------|---|---|
| Top-Level | One single dual band (S/Ka) aperture to provide communication relay with maximum data rate of 1.2 Gbps to the SSBS from user and 80 Mbps to user | Antenna size, placement, launch options |
| System | Off-the-shelf equipment where possible; push technology to save mass and cost; cutoff date for components to be at TRL 6; single-fault tolerant spacecraft design; mass growth estimates per AIAA 2-120-2006 (add growth to make system level margin to be 30%) | Add an optical communication package |
| Communications | TDRS package S/Ka - SA deployable 4.8 m antenna to/from single users ~1.2 Gbps for Ka-band | Antenna type, packaging, option to re-use package for lunar space users |
| Mission, Ops, ACS | Nominal launch/insertion to GTO by launcher, three satellites per launch, accuracy of pointing the antenna of 0.04° | |
| Launch Vehicle | Falcon 9, launch loads: ~10gs for this size payload | Atlas 5xx |
| Power | ~700 W provided for transponders and other additional equipment, Li-ion batteries | 100V, 28V, other voltages |
| C&DH (includes software) | No storage, bent pipe, gimbal drivers, For optical link: on-board processing | |
| Thermal and Environment | Thermal heat rejection of 500 W, dedicated radiators for deck mounted communication/avionics boxes | Size of radiators was determined |
| Mechanical | Al boom, dual gimbal, umbrella deployable array | Location North or South side of vehicle |

B. Spacecraft Design Drivers

The Space to Ground Links (SGL) were assumed to be the current ones used by the NASA SCaN space network. The current RF frequency bands with the current modulation and coding schemes that are used for the SGL are sufficient for all future missions except those future missions with the highest data volumes because of the larger bandwidth needed. If those proposed missions materialize, having the future SGL at the upper Ka-Band (37GHz) or optical link would be advantageous.

Consideration was given to alternative architectures to support optical communication below GEO for future missions that may want to use this technology. Architectures were also developed for RF, optical, and RF/Optical communications beyond GEO (Earth-Moon LaGrange Point (EML)1, EML2 and Moon in the near term, and to Mars in later years). The point design of an SSBS with a single RF aperture looking beyond GEO supports the architecture design and was done to estimate the mass, power, and cost.

Other design decisions on the communication payload included:

- Maintaining the antenna size at the current TDRS antenna size of 4.8 meters. It is understood that commercial vendors of large antennas with deployable sizes of 9 meters or larger can be manufactured for S- and Ka-bands, although there is a development cost to make them dual band. If a larger antenna size is used, then the user burden at all locations can be reduced by the ratio of antenna area (or more) for LEO through Terrestrial missions.
- Maintaining the current SGL at Ku-band. This allows use of existing ground infrastructure.
- Using the bent-pipe satellite design to make it backwards compatible with TDRS system.
- Deriving the mass for the communication subsystems from current TDRS masses without the current SA Ku components, where possible.

C. Communication Payload Design Drivers

The key payload design drivers for the SSBS were to:

- provide a dual frequency band link to assets below
- be able to track orbiting spacecraft

- have low-to-medium data rate capability in one of the dual frequency bands
- have the band used for low-to-medium data rates have at least the capability of the current TDRS single assets S-band link
- have the other band provide high-to-very high data rates that users will need after 2020 (as identified by users)
- have the ability to launch multiple spacecraft on a rocket that is smaller than what is used for the current TDRS

The requirements for the communications payload are presented in

The SSBS was designed to be as compatible as possible with the current TDRS's SA functions while enhancing its performance and preparing for future user needs. The user needs studies indicate that the current TDRS system can provide all the performance and capabilities needed for SA Ku-band links; therefore, SA Ku-band services were not included in the SSBS design. Another reason not to include SA Ku-band is that the needs studies indicate that after the ISS is retired, the need for the SA Ku-band capability will approach zero or go away. The S-band MA capability was not included in the payload design as that capability can possibly be filled through commercial services or as a hosted payload on another satellite.

The design of the SSBS offers low-to-medium and very-high data rate services for the anticipated missions in the 2020 decade. It consists of one large antenna to communicate with the user's spacecraft and one medium-size antenna to provide the SGL. This is similar to the current TDRS system except it has only one Single Access (SA) antenna and no Multiple Access (MA) antenna.

Limiting the SA antenna to dual frequencies instead of triple frequencies makes it easier to maximize the gain of the antenna at Ka-Band.

The design parameters of the communication payload are as follows:

- Single fault-tolerant, bent-pipe design
- Assumes that other GEO SSBSs will provide fault tolerance and alternate visible paths
- Large mesh antenna, capable of being stowed compactly for launch
 - 5m antenna for S/Ka-Band
- Maximum data rate at Ka-band of 1.2 Gbps
- Same radiometric tracking services as currently supported by the TDRS system
- Capable of looking outward to the Moon or Moon-Earth L2
- Potential for some level of re-use to support some missions in lunar space
 - Reduces Ka-Band maximum data rate to 50 Mbps return assuming an EIRP of 61dB-W
 - Reduces S-band maximum data rate to 300 kbps return assuming an EIRP of 40dB-W
 - Assumes a user with a 40W RF power transmitter and a one-meter parabolic dish
 - Assumes a 6 dB engineering margin for human space flight missions
- Provide up/downlink from/to Earth control stations
 - 1.5 m SGL antenna similar to TDRS
 - 1.2 Gbps at Ku-band
 - Uses high-level modulations like 8PSK or 16QAM to meet bandwidth restrictions
- Option to provide optical uplink from LEO user to GEO
 - 10 cm telescope, body mounted
 - Maximum data rate at 1.2 Gbps
 - Coherent communication
- Frequency bands
 - Ka-Band (23/26GHz): SA
 - S-Band (2.0/2.2GHz): SA
 - Ku-Band: SGL

Table 3. Communication payload requirements and trades

| Item | Assumptions and Requirements | Trades |
|---------------------|--|--|
| Top-level | Provides tracking and position determination and low-to-medium data rates to users through S-band link. Provides high data rate services to users through Ka-band link. | Aperture size, user burden, user receive data needs, satellite power, packaging of satellite in launch vehicle |
| System | Bent-pipe configuration, room temperature electronics, current TRL 7+ components and subsystem except for antenna, single fault-tolerant, Ku-band SGL, S- and Ka-band dual band SA aperture, tracking of launch and Leo spacecraft | Optical payload package, transmit power, inward looking only versus inward and outward looking aperture |
| Transponder | S-band for SSBS position determination | |
| Transceivers | S-band, Ka-band for communication with users, Ku-band for space to ground link | 37 GHZ for SGL |

IV. SSBS Architecture at GEO Location

The COMPASS team was provided with the information in Section I to Section III to carry out the SSBS mission design and cost analysis. The team generated an initial design which can meet the user needs and also reduce costs. From a cost perspective, the team quickly determined that it is feasible to launch multiple SSBS spacecraft simultaneously on a single-launch vehicle, thereby reducing the average total cost per spacecraft delivery to GEO. To take advantage of this, the COMPASS team designed the SSBS to accommodate launching multiple relays together on a SpaceX Falcon 9-type launch vehicle. The mass of the structure and the mass of the propulsion systems reflect this design decision. The team then produced a high-level SSBS architecture and its systems; the operational and technology views are described below.

A. System View

Figure 4 provides the schematic of the spacecraft. The communication payload on this spacecraft consists of four communication systems controlled through the spacecraft’s avionics. The communication systems consists of Ka- and S –band transponders and associated antennas. It also has Ku-band sub-system to downlink the user data to the ground infrastructure. The key spacecraft sub-systems for power generation, power storage, spacecraft propulsion, avionics and thermal are identified.

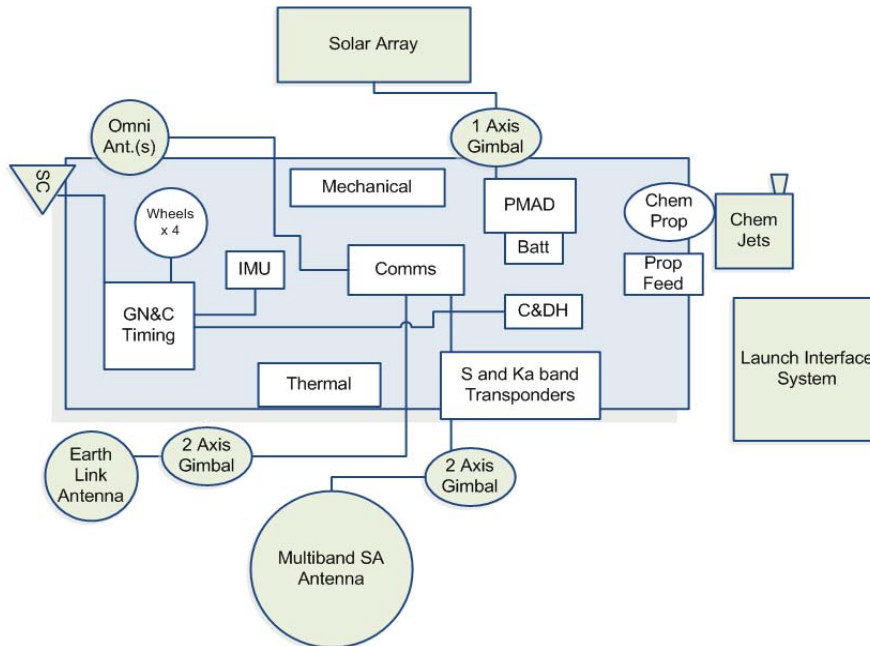

Figure 4. Spacecraft block schematic

B. .Operational View

The SSBs will be operational in 2022 and will be a smaller version of TDRS with only one dual band aperture capable of communicating above and below GEO. The current TDRS SA S-band and SA Ka-Band services are maintained or enhanced. The SGL will be the same as the current TDRS. There are options to add optical communication without changing the SSBS size or packaging on a launch vehicle.

Figure 5 shows an operational concept for how the SSBS will be supported for a LEO customer. The SSBS will be able to support the customer's need for communication and tracking service. The SSBS will acquire low-to-high data rate signals from the customer at either S- or Ka-Band, or both, and relay that information to a ground segment at Ku-band. In addition, the SSBS will relay commands and provide tracking information to the customer.

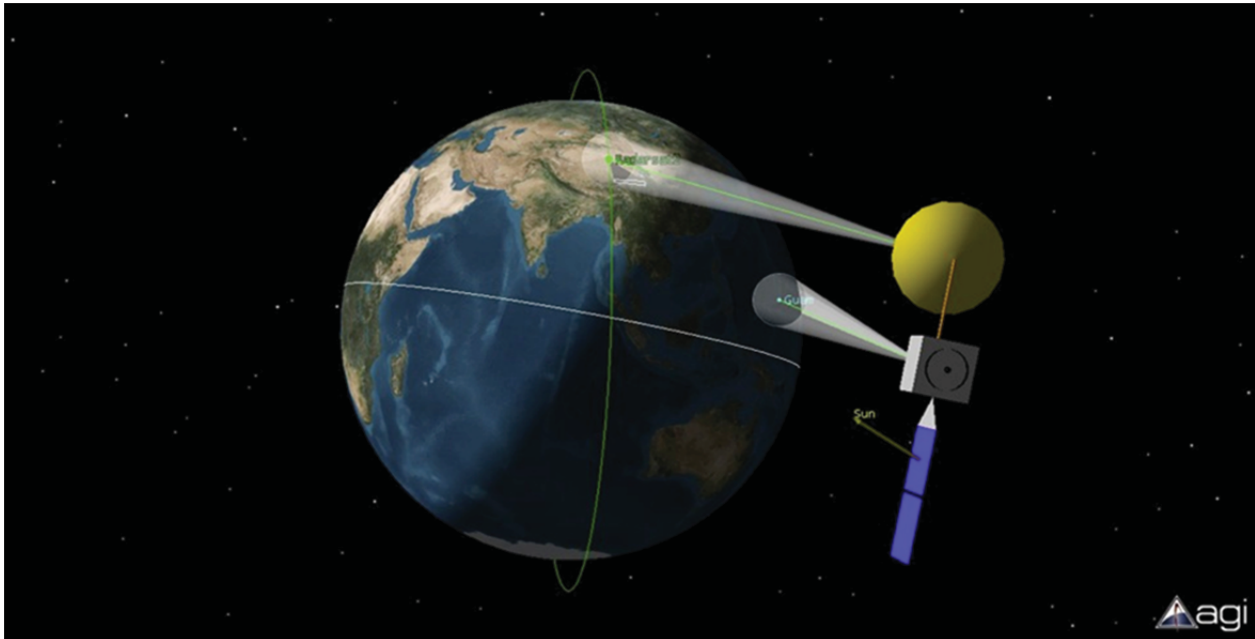

Figure 5. Operation concept for LEO users

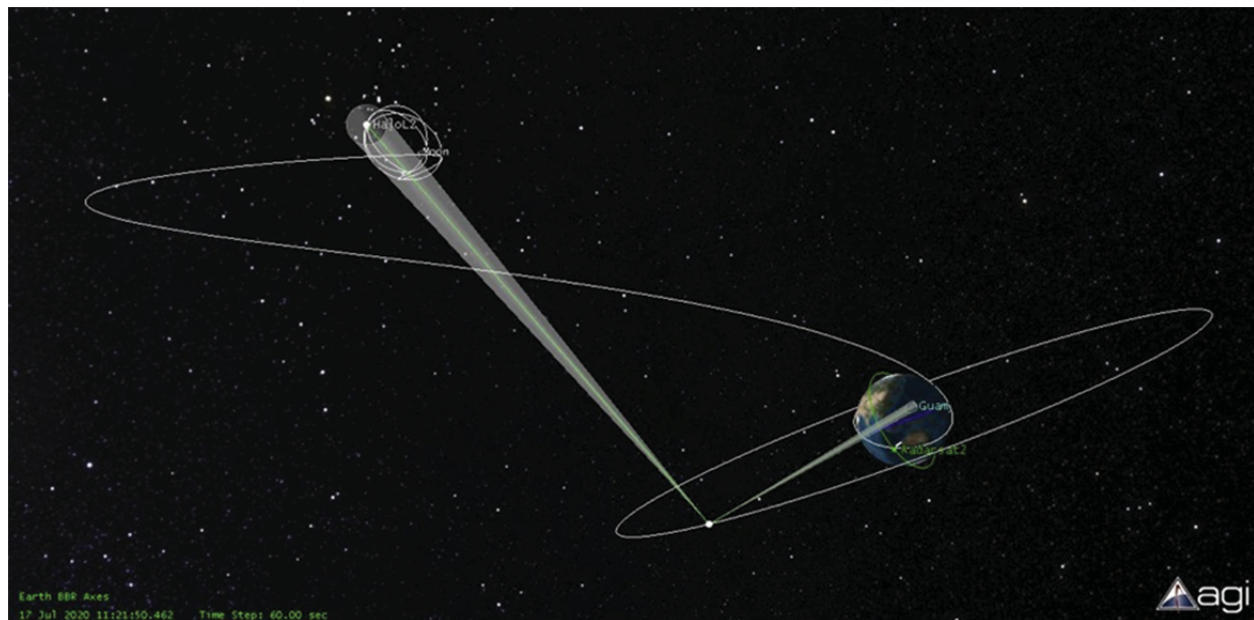

Figure 6. Operation concept for optional EML2 users

Figure 6 illustrates the SSBS capability for tracking a mission continuously from launch to orbit insertion into halo

orbit about L2. During the entire time, the SSBS allows one ground station to be in full communication with the mission vehicle.

V. Communication Payload Design

A. Overview

Comparing the SSBS communication payload's expected performance for links to L1/L2 to the direct to ground network is beyond the scope of this study, but a few salient features are worth noting. The SSBS will not have the rain fade of 3 to 4 dB or more that must be taken into consideration. The ground stations can use the 34-meter or the 18-meter dishes, giving them a gain advantage over the SSBS, but more of these stations may need to be built. The ground stations must switch off covering the Multi-Purpose Crew Vehicle (MPCV) compared to the SSBS; this adds complexity. The outage per day for the SSBS when not in communication with the MPCV is small to none compared to a single ground station. For the SSBS communication payload on-station in GEO, the following assumptions were made:

- Maintain +/- 7° inclination (no burns needed during 15 year life)
- EWSK burns, momentum dumps (from solar pressure) as needed
- Provide bent-pipe Communication Relay / Tracking – simultaneously (including eclipse)
- Earth down-link beam width 1.4° with 0.14° pointing accuracy
- Below LEO Users
 - 5m SA (antenna LH/RH dual circular polarization): S-Band (300-6000 kbps) ,Ka-Band (300-1000 Mbps) BW [+/-0.025° pointing accuracy], Ku also - 1 user
 - Launchers (1Mbps)
- Beyond LEO User (not baseline)
 - Same 5 m SA to Lunar/L1/L2 piloted users (3 Mbps at Ka-Band), [.14° pointing] – 1 user (MPCV with 1 m dish) 25Mbps forward and 80Mbps reverse
 - NO support for legacy deep space missions

Add optical as an option using LCRD package for basis for mass and power needs.

This payload consists of four communications systems controlled through the spacecraft's avionics. The communications systems are:

- Ku-band SGL, which downlinks the user data to the ground infrastructure
- An S-band OMNI TT&C antenna, which provides contingency communications
- A Ka-band communications system for high-to-very high data rate communications with user platforms through dual S/Ka-band single access antenna
- An S-band communications system for low-to-medium data rate communications to user platforms through the dual S/Ka-band single access antenna

The communication payload design details are provided in the following sections.

B. Communication Payload Description

The single-string tolerant design without the redundancy is shown in Fig. 7. It is a basic bent-pipe design with the received signals converted to intermediate frequencies (IF) and then routed around. The design has three apertures. The space-to-ground links consist of links at Ku-band and S-band as shown in Fig. 7. The S-band link is for the SSBS to determine its position and velocity, to receive commands from the ground, and to supply the ground with telemetry data. The SSBS with its position knowledge can maintain its orbit position and track other spacecraft. The Ku-band SGL sends up a frequency multiplexed signal with one set of data going to the Ka-band transmitter and the other to the S-band transmitter. The splitters in the system design separate out the frequency multiplexed signals that are routed to either the S-band or Ka-band transmitter while the frequency combiners multiplex signals from the S-band and Ka-band receivers into a single IF at the IF frequencies band that is routed to the Ku-band SGL transmitter.

The payload design assumes TWTAs similar to the Lunar Reconnaissance Orbiter (LRO) Traveling Wave Tube (TWT). Currently L3 offers space qualified LRO like Traveling Wave Tube Amplifier (TWTA) in Ka-band with a power range of 20 W to 200 W. The antenna efficiencies are assumed to be 55% for the link budget calculations. This assumption of the antenna efficiency may be low, as LRO antenna at 26 GHz had an efficiency of ~75%. The system noise temperature on both the user spacecraft and the SSBS is assumed to be 300 K.

In Fig. 7 the transceivers include the following: the receiver, the Low Noise Amplifier (LNA), the transmitter exciter, and the transmit power amplifier. These four items do not need to be in the same box, although they normally are except for the power amplifier. It is assumed that the transceivers input and outputs are at various IF frequencies. The avionics sub-system is tied to the S-band transponder, and it will control and monitor the rest of the communication package as commanded from the ground.

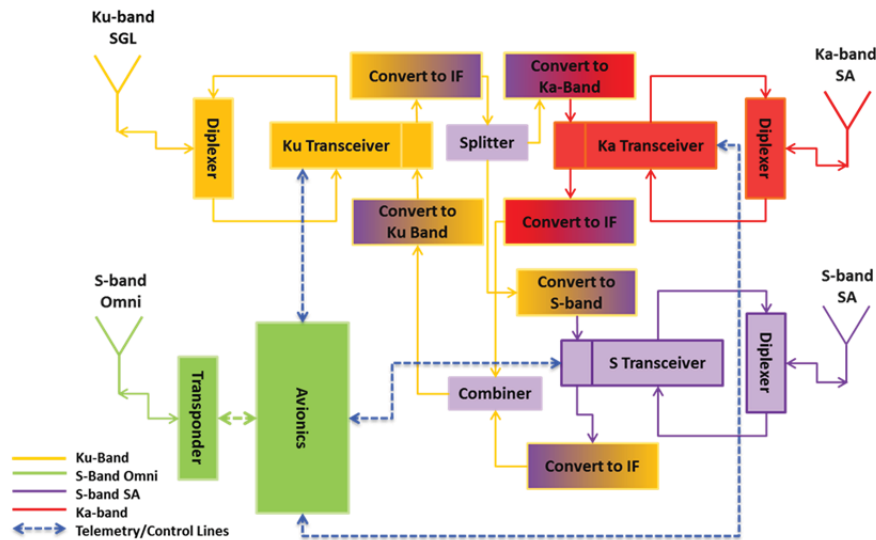

Figure 7. Small SSBR communication schematic shown without redundancy

The link budget calculations for the different links used the following parameters to trade between:

- Frequency band
- User satellite antenna gain
- User satellite RF transmit power
- Data rates

The parameters in the link calculations held constant per user site were:

- Modulation type (QPSK)
- SSBS antenna gain
- Coding method that had an E_b/N_0 of 4.5 dB
- Transmit power

The calculations found that without increasing user burden for below GEO missions, the maximum data rate for S-Band was 3Mbps and for Ka-Band, 1.2Gbps. For human missions at L2 with the user having an Effective Isotropic Radiated Power (EIRP) of 61.2 dB-w, the data rate for Ka-Band was 86 Mbps, when using a 3dB engineering margin, which exceeds the mission's needs. For S-Band with an EIRP of 40 dB-w, that data rate is 620Kbps. Higher data rates are possible without increasing mass or power significantly by using the new low density parity check coding schemes. The link analysis summary is provided in Table 4, for the forward link and in Table 5, for the receive link.

Table 4: SBR to Mission - Forward Link

| Mission Location | Range (km) | Band | S/C antenna size (m) | S/C ant. Gain (dB) | Power (W) | Data rate (Mbps) |
|------------------|------------|------|----------------------|--------------------|-----------|------------------|
| LEO | 41000 | K | .5 | 38.6 | 20 | 1200 |
| LEO | 41000 | K | --- | 0 | 20 | .164 |
| L2 | 510000 | K | 1 | 45.0 | 20 | 33 |
| LEO | 41000 | S | .5 | 17.8 | 20 | 3 |

Table 5: Mission to SBR Reverse Link

| Mission Location | Range (km) | Band | S/C antenna size (m) | S/C ant. Gain (dB) | Power (W) | Data rate (Mbps) |
|------------------|------------|------|----------------------|--------------------|-----------|------------------|
| L2 | 510000 | Ka | 1 | 46.1 | 40 | 86.5 |
| L2 | 510000 | S | 1 | 24.6 | 40 | .62 |
| L2 | 510000 | S | 1 | 24.6 | 20 | .31 |
| LEO | 41000 | S | --- | 0 | 20 | .164 |

For the COMPASS design, total dry mass of the communication system with margin, not including booms and mechanism except for the gimbals, was determined to be 131.5 kg for Ka-band, 24 kg for S-band, 54.5 kg for Ku band, and .5 kg for IF. The total mass was approximately 210.5 kg. The maximum power the communication payload needed was 192.2 W.

All of the components on the SSBS aperture looking at L2 are space qualified. The mass, the power, and the number of each component are listed in the master equipment list and master power equipment list (see Table 7). For power-budget purposes, the backup components are assumed to be off.

C. Payload Design with Optical Links to Connect Beyond GEO

The optical option was not designed into the satellite by the COMPASS team. This option was considered an add-on. The parameters for this option were derived and scaled from the optical payload Laser Communication Demonstration program that is scheduled to fly as a hosted payload in the future. The optical aperture size and the laser power were sized for the data rate needs of a human space flight mission to Earth-Moon L2. The effect of adding the optical option to SSBS in terms of additional mass and power will be discussed.

The first of the two options is a one-way link from HSF to SSBS as shown in Fig. 8a, and the second option is a two-way link as shown in Fig. 8b. The reliability and lifetime of the optical components are unknown at this time; but the reliability and the lifetime of optical sub-systems will be better understood after the operational phase of the Laser Communications Relay Demonstration program has been completed. Some of the other assumptions being made for the optical option are:

- Thermoelectric cooling for the optical detector
- 4W optical beacon on the SSBS, which is needed for the HSF mission to lock onto the SSBS signal
- Link margins > 3dB at 1550 nm
- 160 Mbps maximum data rate from L2 to SSBS
- 160 Mbps maximum data rate from SSBS to ground

Following are the common design parameters for the SSBS:

- 12.5cm optical aperture on the SSBS for the L2 to GEO Link.
- 2.0 W laser transmitter from GEO to L2, when used
- 10.7cm aperture for GEO to ground
- 0.5 W laser transmitter from GEO to ground
- 4 W optical laser beacon
- For the user spacecraft near L2, optical transmitter aperture of 12.5 cm and 2.0 W of output laser power
- For the ground station, optical transmitter aperture of 20cm and 1 W output laser power for possible enhancement to the RF communication package

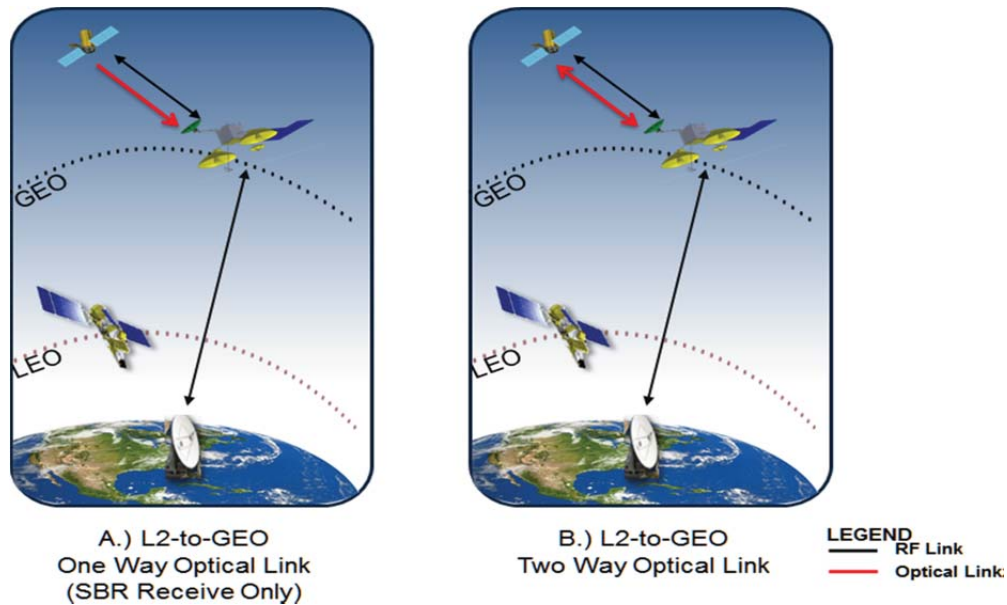

Figure 8. L2 to GEO sub-alternatives conceptual design

D. Possible Enhancement to the RF Communication Package

For enhanced performance, especially when looking away from Earth, using cryocooling can lower the system noise temperature to ~ 75 K or less, thus gaining a 6 dB or more margin in the link budget. The cryocooling of a Ka-band receiver was demonstrated by a DARPA-funded NASA co-operative research agreement in the middle 1990s where a space-quantifiable 15-year life-time Ka-band cryocooled receiver was developed that operated at 75 K.¹⁷

VI. SSBS Design

To accommodate the communication payloads detailed above, a Small Spaced Based Satellite (SSBS) design was developed. The conceptual designs with different views of a deployed SSBS in GEO orbit are shown in Fig. 9 and Fig. 10. The vehicle uses a simple and cost-effective design that requires only a single large antenna for single user communications and a single solar array. The position of the large antenna and the solar cells were purposely made to balance out the torque from the solar winds and radiation. Only the outside panel of the solar cell stretcher array has solar cells; the other three panels balance the solar pressure. Having the large antenna above the bus also allows for servicing users in higher orbits. Besides using a standard layout, the vehicle also uses existing spacecraft components. The actual spacecraft design is for a 15-year life cycle with the standard redundancy necessary to achieve such life on the reaction wheels, batteries, station keeping fuel, and the electronics. The analysis of the spacecraft design includes all possible eclipses and how long the eclipses will last for the spacecraft. The spacecraft is expected to be capable of fully communicating during eclipse periods. The power system was designed to provide over 600 W during sunlit periods. The propulsion system uses simple bipropellants (NTO/N₂H₄) for both the apogee burn and station-keeping/wheel dumps. While electric propulsion has become attractive for many *geostationary* spacecraft, the SSBS need only be *geosynchronous-inclined*; orbit drift is allowed, as with the TDRSS (so no large north/south station-keeping burns are required). The thermal system uses a single radiator with the facing edge toward the sun in the “south” direction. The spacecraft could easily be flipped 180° for deep space users (so that the solar array faces in the north direction.) The structure of the vehicle is stiffened so it can carry two vehicles on top for launching three SSBSs on a single Falcon 9 spacecraft. Also shown in Fig.9, on the top of the spacecraft, is the mounting structure for attaching the next spacecraft during stowage and launch. The dimensions of the SSBS are shown in Fig. 10 the left panel consists of a drag-flap and solar cells with an area sufficient to compensate for the solar drag that results from using the large single access antenna. Power needed for additional communication equipment can easily be accommodated by switching out the drag-flaps for additional solar panels without increasing the spacecraft’s size.

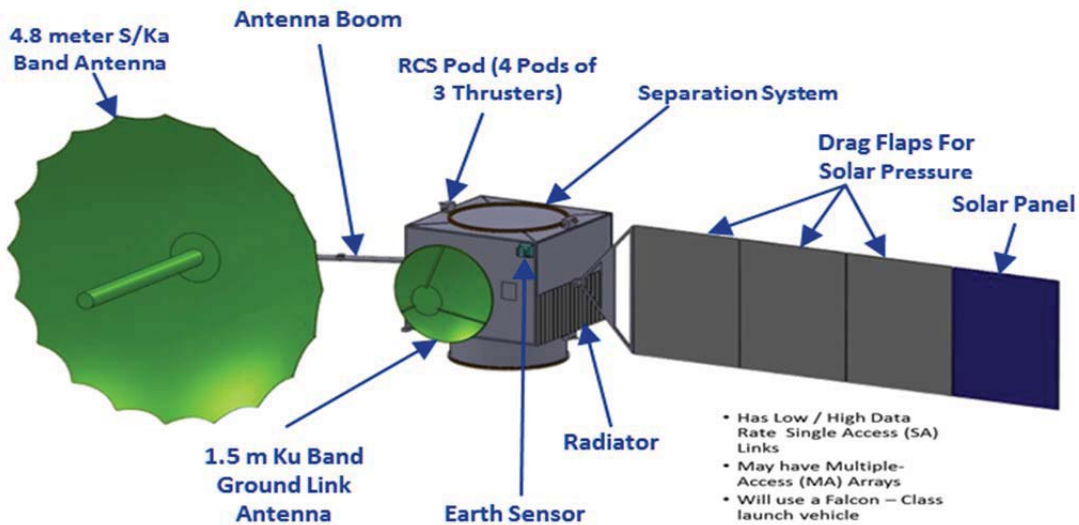

Figure 9. Deployed SSBS in GEO orbit (conceptual design by GRC COMPASS team)

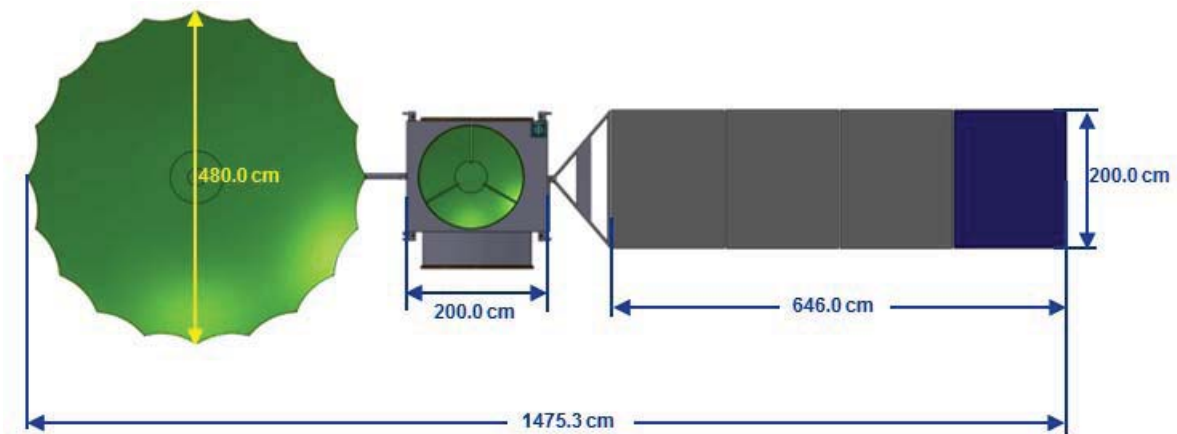

Figure 10. Dimensions of deployed SSBS (conceptual design by the GRC COMPASS team)

VII. Preliminary SSBS Design Concept with an Optical Payload

Figure 11 shows one of the options for adding an optical communication system to the SSBS. In this option the satellite provides optical communication for below GEO missions. As can be seen in Fig. 11, the optical communication telescope assembly fits nicely with the SGL antenna; therefore, the spacecraft bus does not need to be significantly changed. The extra power for the optical communications comes from replacing the drag flaps with additional solar cells panels. If optical communication beyond GEO is desired, then the optical telescope can be placed on the opposite side of the spacecraft, as shown in Fig.11. One of the other options considered for the study, but not presented here, was to add up to four optical communication heads and still be able to get three SSBSs on a single launch vehicle. A complete design exercise was not performed for this concept.

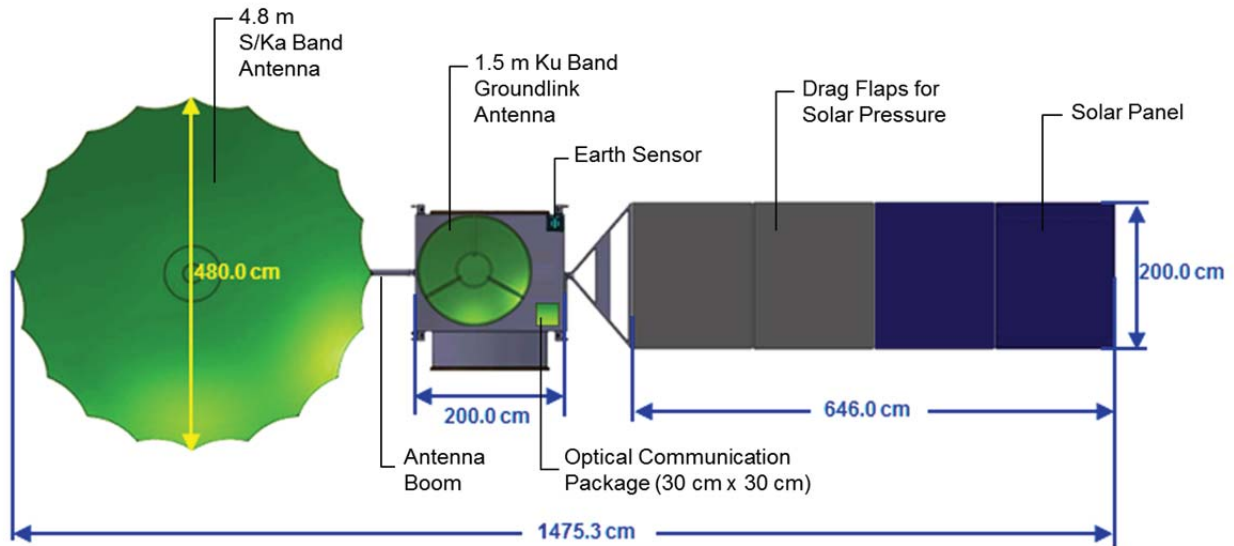

Figure 11. SSBS with notional optical payloads

VIII. Launch Vehicle Selection

Figure 12 shows the three SSBSs, without the optical option, stowed on a Falcon 9 rocket built by SpaceX. This is for illustration purposes only, as there is no assurance that any specific launch system will be available in the future. The mass and size of the SSBS is sufficient for this rocket to deploy three of them into GTO orbit. Once the rocket reaches insertion orbit, then each SSBS will inject itself into GEO orbit and perform drift operations to get to its assigned position. If larger cross-section rocket envelopes are available in the future, then SSBSs with larger antennas will be possible.

By designing the SSBS to carry its fellows above it, the need for dual (or triple) attached fairing systems is eliminated. Thus, launch of a complete array of SSBSs to provide low-earth-orbit coverage can be completed in a single low-cost launch. The launch of single replacement SSBS on a smaller launcher, such as Antares, would necessitate redesign of the SSBS to fit the smaller shroud. A single SSBS might be launched above another GEO spacecraft if a dual-payload-attach fitting (DPAF) is used on a Falcon 9 or an Atlas V class vehicle.

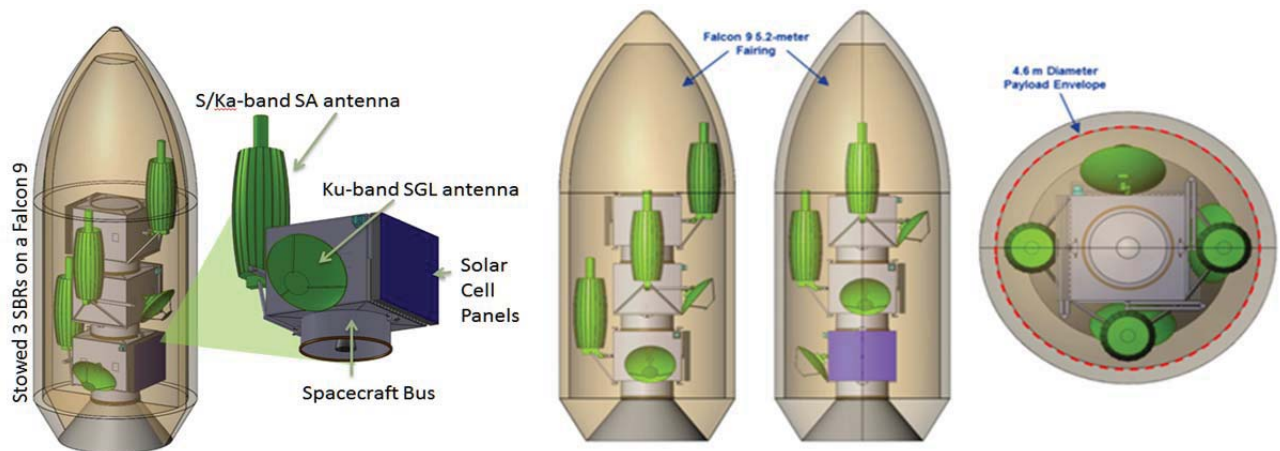

Figure 12. Conceptual design for three SSBSs stowed in a Falcon 9 envelop with blow-ups of stowed SSBS

Table 6 provides the top-level requirements for the SSBS for multiple deployments from one spacecraft. With current spacecraft, the SSBS mass must be approximately 1500kg or less and be capable of being stowed three at a time on a medium-size class rocket, similar to a Falcon 9.

Table 6. Top-level spacecraft specifications for the SSBS

| SPECIFICATION | DESCRIPTION |
|-------------------|--|
| Services Provided | Equivalent TDRS Single Antenna S-band/Ka-Band Single Access Antenna, Ku SGL |
| Platform | Very Small Geosynchronous Bus - ~Orbital GEO Star or less |
| Launch Vehicle | Three on single Falcon 9 |
| Wet Mass/Power | ~1500 kg / ~700 W |
| Advantages | Dedicated spacecraft, launched 3 at a time on Falcon 9, satellite placed and maintained at desired geo-location, can provide 3 Mbps Lunar communications |
| Challenges | Launch integration, Requires dedicated Ground Systems |

The mission to GEO can be summarized as follows: The Falcon 9 launch vehicle inserts into a 185 km x GEO orbit; from there each SSBS uses its on-board bipropellant system to insert into a geosynchronous orbit with 7 degree inclination. As mentioned earlier, this inclination does not require the expensive north-south station-keeping of geostationary spacecraft but does require that the ground systems be able to track the SSBS similar to the existing TDRS. East/west station-keeping is still provided, as are periodic wheel dumps, but the ΔV for 15 years of these burns is quite small at less than 75 m/s. (This includes a disposal to super-GEO burn.)

IX. Analysis and Risks

A. Analysis

Based on the SSBS Master Equipment List (MEL) and Power Equipment List (PEL) data, up to three SSBSs are capable of launching on one reasonably sized rocket. These satellites will be able to provide the single access Ka-band and S-band services that SCA will need well into the 2030 decade. The small dedicated SSBSs are easily adaptable to a hybrid SCA communication system that uses hosted payloads to provide any necessary multiple access services as well.

The ~4.8 m antenna that provide S-band services drives the spacecraft size; in the future advanced deployable antenna technologies that will be available can offer more possibilities. Placing SA antenna on the north side allows for sweeping the entire Earth space (+/- 30° N/S, +/- 90° E/W) and allows polar coverage similar to TDRSS, unlike hosted payloads. There might be some users “to the south > -30°” as well as some potential lunar users that might require flipping the s/c north/south. The single large antenna area is purposely offset by “solar sail” blank solar array flaps. Electric propulsion for orbit insertion and NSSK is not attractive as with other high power comsats; the SSBS is a Small GEO SA system with less than 1000W for the payload and no N/S station keeping requirements (over ten times the other on-orbit propulsion requirements). Until cheaper domestic single-launch providers exist, launching three SSBSs on a Falcon 9 is much more cost efficient (compared to the Antares, which could only launch a single SSBS to GTO at roughly the same launch price).

A summary of the MEL and PEL data follows in Table 7.

Table 7. Summary of the SSBS high-level master equipment and power list

| Subsystem | Maximum Power (W) without Margin | Mass (kg) |
|--|----------------------------------|--|
| Ka-Band Communication Payload | 78 | 132 (includes antenna and gimbal masses) |
| S-Band Communication Payload | 78 | 24 |
| Ku-Band Communication Payload | 37 | 55 |
| Attitude Control | 0 | 50 |
| Electrical Power System | 16 | 83 |
| Propulsion | 69 | 88 |
| Propellant | 0 | 768 |
| Command and Data Handling | 87 | 37 |
| Thermal | 7 | 62 |
| Structures | 0 | 214 |
| TOTAL without Spacecraft Margin | 372 | 1513 |

The risks associated with the design include the following: using a mesh-like antenna system with 20 plus ribs, fitting the antenna inside the launch vehicle *and* on the side to allow three satellites to be launched at the same time, and deploying the antenna.

Another risk is centering the mass along the thrust vectors of the individual satellites and the launch vehicle. This risk arises because of the size of the mesh-like antenna compared to the size of the main part of the spacecraft.

X. Conclusions

The design of SSBS shows that small dedicated GEO platforms can provide reconfigurable service to/from single access users and critical missions (e.g., HSF) when and where needed. The communications links to L1/L2 locations can meet the human exploration mission requirements in addition to meeting the below GEO requirements. Using an SSBS to link to spacecraft in the locations above GEO can reduce or supplement the number of ground stations required on Earth. Launching SSBSs in groups of three can also reduce the cost significantly. The recent developments in optical communications payload demonstrations offer additional opportunities for the small satellite in the GEO locations to offer high data rate links for below and above GEO and cross-links to other GEO spacecraft as well. Although preliminary analysis based on this design work looks promising for using the SSBS, especially for the human exploration missions, a number of trades are needed before making the final determination.

XI. Acknowledgments

The authors would like to thank Dr. Robert Manning, Mr. James Budinger and Dr. Robert Romanofosky for their technical support and Ms. Sherry Peck-Breen for her administrative support. Also, the COMPASS Team at NASA Glenn Research Center, participating COMPASS Team members were: Melissa Mcguire (System Integration); Jeff Woytach (CONOPs, Launch Vehicle); Mike Martini (Mission, GN&C); James Fittje (Propulsion); John Gyekenyesi (Structures); Tony Colozza (Environmental); Kristen Bury (Power); Glenn Williams (C&DH/Software); Joe Warner (Communications); Tom Packard (Configuration) and Jon Drexler (Cost). In addition, the authors would like to acknowledge the contributions of Mr. Gregory Heckler, Mr. William Horne, Dr. Gabriel Karpati, Ms. Robin Mauk, Dr. Antonios Seas, and Mr. Bernard Seery, from the NASA Goddard Space Flight Center.

XII. References

- ¹ Gerstenmair, W., *AIAA Space 2013 Conference*, San Diego, CA, September 2013, website.
- ² International Space Exploration Coordination Group, "The Global Exploration Road Map," August 2013, website.
- ³ Oleson, J., Culbert, C., and Laurini, K. C., "NASA's Human Space Exploration Plans and Architecture," presented at *62nd International Astronautical Congress*, Cape Town, South Africa, October 2011.
- ⁴ Troutman, P., et al., "ISECG Mission Scenarios and Their Role in Informing Next Steps for Human Exploration Beyond Low Earth Orbit," presented at *62nd International Astronautical Congress*, Cape Town, South Africa, October 2011.
- ⁵ Hunter, J. A., "Orbiting Deep Space Relay Station Study Final Report, Volume II. Conceptual Design," NASA/CP-158816, 1979.
- ⁶ Koerner, M. A., "A Bent Pipe Design for Relaying Signals Received by an Orbiting Deep Space Relay Station to a Ground Station," NASA/DSN Progress Report 42-56, 1980.
- ⁷ Wilson, K. E., Wright, M., Cesarone, R., Cenicerros, J., and Shea, K., "Cost and Performance Comparison of an Earth-Orbiting Optical Communication Relay Transceiver and a Ground-Based Optical Receiver Subnet," NASA/IPN Progress Report, 42-153, 2003.
- ⁸ Chandler, C. W., "The Case for Deep Space Telecommunications Relay Stations," NASA/CR-2004-213053, 2004.
- ⁹ Sands, O. S., and Bhasin, K. B., "Relay Station Based Architecture and Technologies for Space Missions to Outer Planets," *20th AIAA International Communications Satellite Conference*, Montreal, Canada, 12-15 May 2002.
- ¹⁰ Kularni, T., Dharne, A., and Mortanri, D., "Communication Architecture and Technologies for Missions to Moon, Mars, and Beyond," *AIAA Exploration Conference*, 25 February, Orlando, FL, 2005.
- ¹¹ Flanagan, M., et al., "Small Satellite Implementation of a Lunar Relay Satellite," *AIAA/USU Conference on Small Satellite*, Future Mission 1, SSC07-11-2, 2007, <http://digitalcommons.usu.edu/smallsat/2007/all2007/9/>
- ¹² Edwards, C. D., "Relay Communications for Mars Exploration," *International J. of Sat. Comm and Networking*, Vol. 25, pages 111-145, 2007.
- ¹³ McGuire, M. L., Oleson, S. R., and Sarver-Verhey, T. R., "Concurrent Mission and Systems Design at NASA Glenn Research Center: The Origins of the COMPASS Team, NASA/TM-2012-217283, 2012.
- ¹⁴ Liebrecht, P., Schier, J., Bhasin, K., Bibyk, I., Butler, M., Hudiburg, J., Tai, W., and Shames, P., "NASA's Space Communication Integrated Architecture," *Proceedings of Space Ops 2010 Conference, AIAA*, Huntsville, AL, 25-30 April.
- ¹⁵ Tai, W., Wright, M., Prior, M., and Bhasin, K., "NASA Integrated Space Communications Network," *Proceedings of Space Ops 2010 Conference, AIAA*, Stockholm, Sweden, 11-15 June 2010.
- ¹⁶ Edwards, B. L., Israel, D., Wilson, K., Moores, J., and Fletcher, A., "Overview of the Laser Communications Relay Demonstration Project," *Proceedings of Space Ops 2010 Conference, AIAA*, Stockholm, Sweden, 11-15 June 2010.
- ¹⁷ Mansour, R. R., Romano, T., Ye, S., Peik, S., Nast, T., Enlow, D., Wilker, C., and Warner, J., "Development of Space Qualifiable HTS Communication Subsystems," *IEEE Transactions on Applied Superconductivity*, Vol. 11, No. 1 March 2001.