

Overview of NASA GRC's Green Propellant Infusion Mission Thruster Testing and Plume Diagnostics

Matthew C. Deans¹, Brian D. Reed, John T. Yim, Lynn A. Arrington
NASA Glenn Research Center, Cleveland OH

George J. Williams, Jun J. Kojima
Ohio Aerospace Institute, Cleveland OH

Christopher H. McLean
Ball Aerospace and Technologies Corporation, Boulder CO

Abstract

The Green Propellant Infusion Mission (GPIM) is sponsored by NASA's Space Technology Mission Directorate (STMD) Technology Demonstration Mission (TDM) office. The goal of GPIM is to advance the technology readiness level of a green propulsion system, specifically, one using the monopropellant, AF-M315E, by demonstrating ground handling, spacecraft processing, and on-orbit operations. One of the risks identified for GPIM is potential contamination of sensitive spacecraft surfaces from the effluents in the plumes of AF-M315E thrusters. NASA Glenn Research Center (GRC) is conducting activities to characterize the effects of AF-M315E plume impingement and deposition. GRC has established individual plume models of the 22-N and 1-N thrusters that will be used on the GPIM spacecraft. The models describe the pressure, temperature, density, Mach number, and species concentration of the AF-M315E thruster exhaust plumes. The models are being used to assess the impingement effects of the AF-M315E thrusters on the GPIM spacecraft. The model simulations will be correlated with plume measurement data from Laboratory and Engineering Model 22-N, AF-M315E thrusters. The thrusters will be tested in a small rocket, altitude facility at NASA GRC. The GRC thruster testing will be conducted at duty cycles representatives of the planned GPIM maneuvers. A suite of laser-based diagnostics, including Raman spectroscopy, Rayleigh spectroscopy, Schlieren imaging, and physical probes will be used to acquire plume measurements of AF-M315E thrusters. Plume data will include temperature, velocity, relative density, and species concentration. The plume measurement data will be compared to the corresponding simulations of the plume model. The GRC effort will establish a data set of AF-M315E plume measurements and a plume model that can be used for future AF-M315E applications.

Introduction

NASA's Space Technology Mission Directorate (STMD) has funded the Green Propellant Infusion Mission (GPIM), a technology demonstration mission (TDM) that will demonstrate the operation of a green monopropellant, AF-M315E. The GPIM project intends to fly an operational AF-M315E green propulsion system on a Ball Aerospace-built BCP-100 spacecraft [1]. AF-M315E is from a family of monopropellant formulations composed of an ionic salt aqueous solution, which acts as an oxidizer, and one or more fuel elements. These ionic salt monopropellant formulations have been referred to as "green", because they have reduced toxicity hazards compared to hydrazine (the current state-of-art monopropellant), potentially resulting in lower ground handling and transportation costs [2]. These

green monopropellants can also be formulated to provide higher density and specific impulse than hydrazine.

GPIM is led and managed by Ball Aerospace & Technologies Corp (Ball), with partners including Aerojet Rocketdyne, the Air Force Research Laboratory (AFRL), NASA's Glenn Research Center (GRC), Kennedy Space Center (KSC), and Goddard Space Flight Center (GSFC). STMD programmatic and technology oversight is provided by the Marshall Space Flight Center (MSFC).

One of the primary goals of the TDM program office is the application of the new technologies demonstrated in these missions into future spacecraft. These TDM projects serve as a means by which to establish spaceflight heritage of technology. GPIM is focused on the infusion of AF-M315E propulsion systems into industry, NASA, and Department of Defense market sectors. As a matter of course during the GPIM program, AF-M315E compatible propulsion system components will be developed, qualified, and flown. On-orbit experiments will also be performed characterizing thruster performance, repeatability, and the ability to perform RCS and delta-V maneuvers required for normal spacecraft operations.

One of the concerns of AF-M315E thrusters are the plume impingement impacts. The AF-M315E decomposition products include a high percentage of water, which could condense on solar arrays or optical surfaces. Carbon monoxide, methane, and ammonia have also been identified as contamination concerns. Prior to the activities outlined in this paper, there has not been any significant plume modeling or characterization of AF-M315E thrusters. Proper infusion of this technology is therefore highly dependent on understanding the composition and distribution of AF-M315E thruster plumes and the ability to predict the deposition rates of effluents on spacecraft surfaces.

GRC will mitigate the AF-M315E plume risk under GPIM through plume modeling and characterization. Plume models of 22-N and 1-N AF-M315E thrusters have been developed using two different numerical simulation methods. The impacts of the AF-M315E thruster plumes on the BCP-100 spacecraft have been assessed, by predicting impingement effects and deposition rates onto the spacecraft surfaces. The plume impingement effects on the spacecraft's solar array power generation capability will also be evaluated. Plume measurements will be made during hot-fires of two (2) 22-N, AF-M315E thrusters. The plume measurements will be compared to the plume model results.

If necessary, the plume modeling will be adjusted based on the plume characterization data. The plume risk mitigation effort, then, will result in an assessment of the AF-M315E plume impacts on the GPIM spacecraft, a baseline set of AF-M315E plume measurement data, and an AF-M315E plume model that can provide plume impingement analysis for future applications. Figure 1 summarizes the GRC plume modeling and characterization activity.

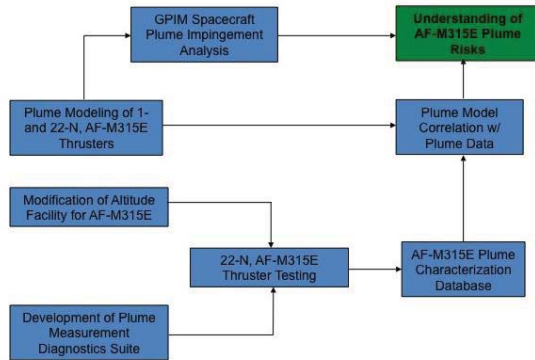

Figure 1: NASA GRC Plume Risk Reduction Activity

GPIM Background

Figure 2 shows the conceptual design of the GPIM propulsion system. The propulsion system will have a single 22-N thruster for delta-V maneuvers and four (4), 1-N thrusters for attitude control, operating in blow-down mode. The propulsion system will perform typical on-orbit operations representative of spacecraft flight requirements.

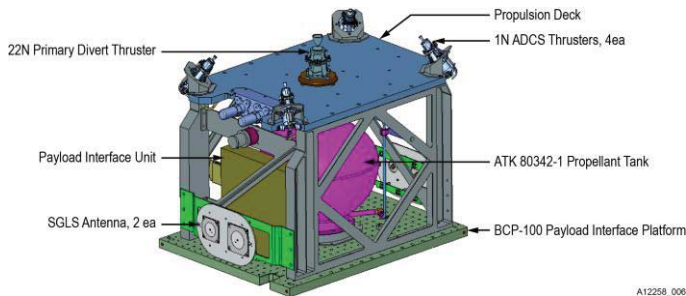

Figure 2: Conceptual Design of AF-M315E Propulsion System [1]
ADCS: Attitude Determination and Control
SGLS: Space to Ground Link System

The AF-M315E propulsion system will be a payload on the BCP-100 spacecraft. The BCP-100 is a spacecraft developed and flown as a technology demonstration platform for the Air Force Space Test Program. The small, modular spacecraft was designed to interface on an Evolved Expendable Launch Vehicle (EELV) Secondary Payload Adapter (ESPA), where it can be launched as a secondary payload. Figure 3 shows the BCP-100 with the GPIM payload after deployment.



Figure 3: GPIM Payload on the BCP-100 Spacecraft
BCP: Ball Configurable Platform

Plume Modeling Results

The AF-M315E plume modeling efforts under GPIM have been summarized previously [3]. Two modeling tools were used to examine the plume properties of the GPIM thrusters. The first used the Reacting And Multi-Phase (RAMP2) / PLume IMPingment (PLIMP) program combination. RAMP2 is an axisymmetric, method-of-characteristics code that calculates the flow field from the throat to the nozzle exit plane and into the plume. RAMP2 results are used as input to PLIMP, which calculates surface impingement properties. The second method used the Hypersonic Aerothermodynamics Particle (HAP) code, which calculates the flow field from the throat into the plume using Direct Simulation Monte Carlo (DSMC) method, a particle-gas flow simulation technique.

The plume flow fields of both the 22-N (50:1 area ratio) and the 1-N (100:1 area ratio) thrusters operating in vacuum are examined. For both thrusters, both of the model approaches are applied. In addition, two different chamber pressures (400 and 100 psia, 2758 and 689 kPa) and two chemistry assumptions (equilibrium and frozen chemistry flow) are also examined. Contour plots of the plume density and temperature in vacuum for the 22-N thruster at 400 psia (2758 kPa) chamber pressure and equilibrium flow are shown in Figure 4. The RAMP2 density results are higher than the HAP results, particularly near the thruster and in the backflow region. However the results between the two codes are generally within the same order of magnitude. As would be expected, the number density is strongly correlated to the chamber pressure, with approximately a four to one ratio corresponding to the 400 and 100 psia (2758 and 689 kPa) cases. In general, the RAMP2 results have been well characterized in the downstream region, whereas a DSMC approach would expect to provide improved accuracy in rarefied flow regions, particularly at high expansion angles behind the nozzle exit plane.

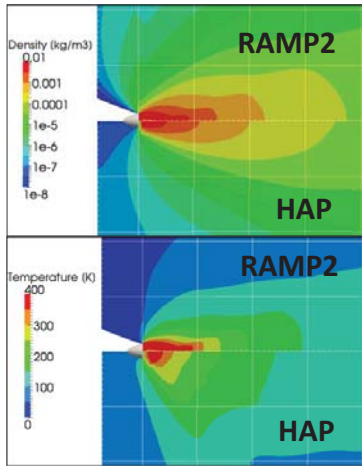

Figure 4: Plume density (top) and temperature (bottom) for 22-N thruster with a chamber pressure of 400 psia and equilibrium flow as calculated by RAMP2 (top) and HAP (bottom). 10 cm grid line spacing.

Similar to the analyses performed on the 22-N thruster, the 1-N thruster (with a 100:1 area ratio) was also examined. The simulated plume flow field density and temperature of the 1-N thruster in a vacuum environment is shown in Figure 5. The results shown correspond to a 400 psia (2758 kPa) chamber pressure and equilibrium flow. As with the 22-N thruster simulation results, the two codes are fairly comparable downstream but with differences in the very near field and at large angles from the thrust axis.

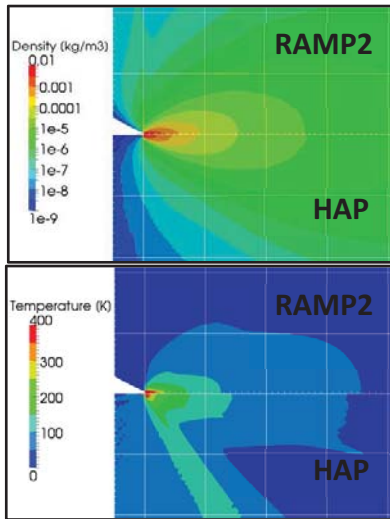

Figure 5: Plume density (top) and temperature (bottom) for the 1-N thruster with a 400 psia (2758 kPa) chamber pressure and equilibrium flow as calculated by RAMP2 (top) and HAP (bottom). 10 cm grid line spacing.

Figure 6 shows the distribution of species molar fraction. Water vapor is noted to comprise more than half of the plume by molar fraction within approximately 45° of the thrust axis, with a notable presence of both carbon dioxide and nitrogen gas. As typically expected with alternate propellants, at large angles from the thrust axis, hydrogen gas was found to be the dominant species. The azimuthal distribution of chemical species was found to correlate to the molecular weight of the species, with the lighter molecules having a greater probability of being scattered at larger

angles. These same trends were observed for the species impinging on the GPIM spacecraft bus and solar array surfaces.

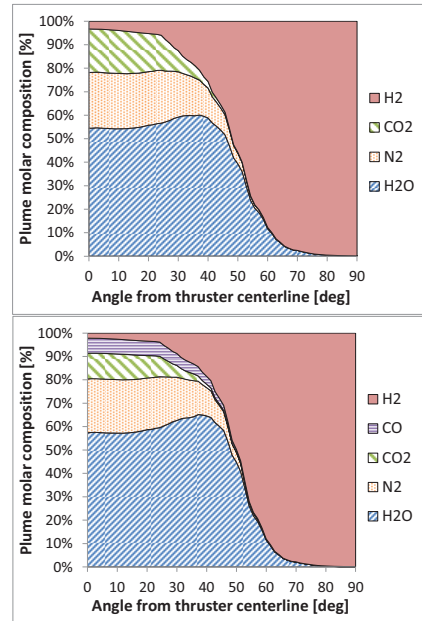

Figure 6: Plume species molar fractions assuming equilibrium flow (top) and frozen flow (bottom) at a 40 cm radius from the center of the 22-N thruster exit plane.

The thermal aspects of the plume and plume impingement were also examined. The AF-M315E thrusters were found to generally obey a rule of thumb also seen for hydrazine where 90% of the thermal energy of the plume is contained within a cone with a half-angle of approximately 30° from the thrust vector (Figure 7).

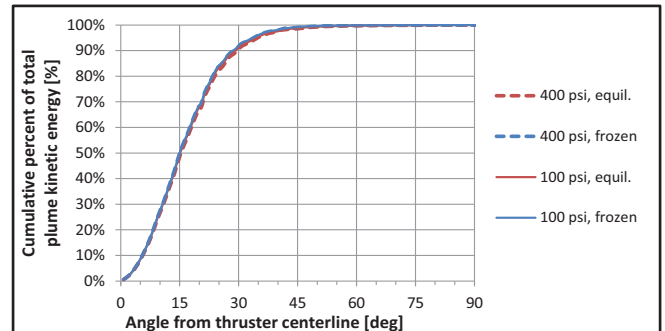

Figure 7: Cumulative percent of total plume kinetic energy for the 22-N thruster

The heating rates imparted on the GPIM spacecraft due to the AF-M315E plume impingement were also calculated (Figure 8). The modeled heating rates were benign; a maximum heating rate of 127 W/m² was observed with the RAMP2 / PLIMP results.

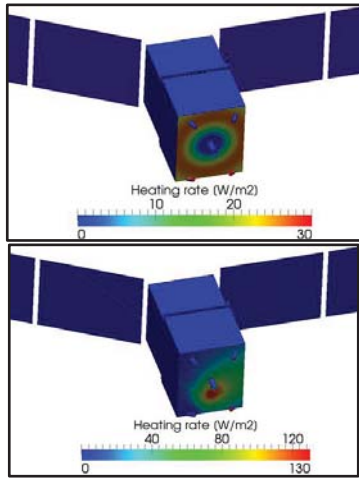

Figure 8: Heating rates calculated by RAMP2/PLIMP on the BCP-100 spacecraft from the 22-N thruster firing (top) and the lower left 1-N thruster firing (bottom).

Both RAMP2/ PLIMP and HAP can calculate the flux of the plume onto various spacecraft surfaces. The next question is how much of that flux will accumulate onto a spacecraft surface through deposition. A general rule of thumb is that contaminants will not accumulate unless the local impingement pressure is greater than the vapor pressure of the contaminant species. From an accumulative condensation standpoint, most species in the GPIM plumes can be ignored due to relatively high vapor pressures compared to the local plume pressure, unless spacecraft surfaces are expected to reach very low temperatures.

Figure 9 shows the results of a calculation of the net deposition of species with higher vapor pressures as a function of surface temperature. As can be seen, water accumulation may be an issue at temperatures less than 200 K. Table 1 shows the minimum expected temperature of several GPIM spacecraft surfaces. Only the Multi-Layer Insulation (MLI) on the top and side surfaces is expected to see temperatures that low. No spacecraft surfaces are expected to see temperatures where ammonia, NH_3 and carbon dioxide, CO_2 would pose any threat of deposition.

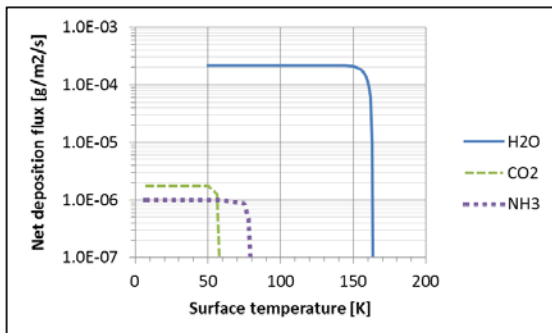

Figure 9: Net deposition flux as a function of surface temperature

| Component | Minimum expected temperature [K] |
|---------------------|----------------------------------|
| Star tracker base | 277 |
| Star tracker baffle | 268 |
| Side radiators | 261 |
| Sun sensors | 258 |
| SGLS antennas | 248 |
| Solar array | 203 |
| MLI payload top | 183 |
| MLI payload sides | 113 |

Table 1: GPIM Spacecraft Temperatures

In addition to condensation, chemisorption or other chemical reactions between an impinging species and a surface material may be possible. This should be considered especially for atomic hydrogen, as it can be particularly reactive. Other considerations to account for is that this analysis only examines a fully combusted plume. Compounds in a non-fully combusted plume have relatively high molar masses compared to H_2 . These other species are expected to have a very low presence in the backflow region of the plume where most sensitive spacecraft surfaces are expected to be located. To highlight this effect, the maximum calculated surface number fluxes for the complete combustion cases are normalized by their respective flux at the nozzle exit plane and plotted against molar mass in Figure 10. A general decreasing trend with molar mass is seen. This is a way of showing that in the backflow region, where spacecraft impingement occurs, molecules with less molecular mass may be the only significant species by orders of magnitude. Species typically generated by incomplete combustion have molecular masses greater than that of H_2 thus the likelihood of their presence is diminished.

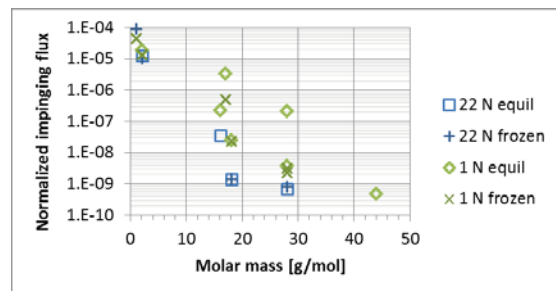

Figure 10: Normalized GPIM spacecraft impingement flux versus species molar mass.

The effect of AF-M315E plume impingement impacts on the spacecraft solar array power generation capability will be assessed. The analysis will leverage both the plume model of the AF-M315E thrusters and the geometric model of the BCP-100. Solar array degradation due to chemical contamination, erosion, thermal loading, and force loading will be evaluated. Chemical contamination is caused when plume constituents form deposits on the solar array surface; the contamination layer reduces the amount of incident sunlight that can reach the solar cells and results in a loss of power. Erosion is caused when uncombusted droplets in the plume impact the array at

A simplified flow system diagram is shown in Figure 14. Note that not all instrumentation and flow components are shown for clarity. The assembled panel is shown in Figure 15. This panel is adjacent to the vacuum chamber, shown in Figure 16. The system consists of a 0.4 gallon run tank. The maximum allowable working pressure is 1440 psi (9928 kPa) with reliefs set at 1200 psi (8274 kPa). The system is able to be vacuum purged and pressurized with nitrogen. The system will operate at discrete controlled pressurization set points. Flow rate is measured by a coriolis flow meter. An optional thruster body purge shroud system has also been installed utilizing argon gas. Additionally, there are separate gaseous feeds to the test chamber for laser calibration with nitrogen.

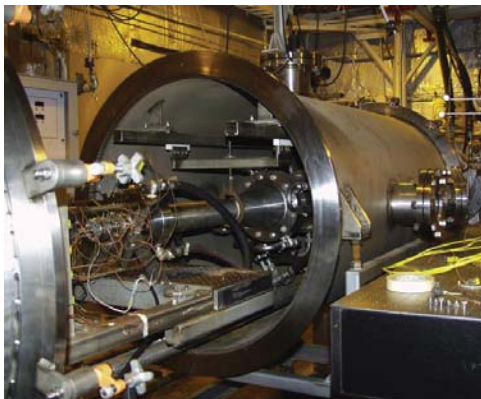

Figure 16: Vacuum Chamber in Open Position

In order to accommodate the testing of AF-M315E the issues of storage, flow system, handling, and disposal have been addressed. Storage of the propellant will be located adjacent to the facility. When defining specifications for the magazine, accommodations for a variety of new propellants other than AF-M315E were also considered. An ATF Type II magazine was selected. The climate control, comprised of a heater and blower, was specified so as to accommodate AF-M315E as well as potentially more controlled propellants such as of LMP-103S and other energetic ionic liquids. The magazine, shown in Figure 17, has been sited based on quantity-distance regulations to allow storage of up to 1000 lbs (453 kg) of a Class 1.3C type explosive.



Figure 17: Propellant Storage Magazine

Handling and disposal considerations have been established for this propellant. In proper packaging, the propellant ships as a 1.4S class explosive which conforms to established NASA GRC receiving procedures. Personal

protective equipment (PPE) consists of nitrile gloves, lab coats, and goggles. Spill cleaning processes have been defined and the requisite equipment has been procured. Dilution and disposal procedures for the AF-M315E propellant and any potential contaminated waste water have been developed.

GPIM testing at GRC will utilize two different AF-M315E 22-N class thrusters. These thrusters were manufactured by Aerojet Rocketdyne – Redmond. The first thruster to be tested is a Laboratory Model (LM) thruster; this is essentially a heavyweight and highly instrumented thruster with a relatively small nozzle expansion ratio. Denser gasses emitted from this sized nozzle may yield greater diagnostic signal strength relative to the lower pressure products emitted from a larger nozzle. Additionally, this thruster will provide detailed thermal and pressure information of the thruster. Thrust measurement will also be performed as part of the LM thruster firings. Testing with this thruster will occur in May to July of 2014.

The second thruster is an Engineering Model (EM) thruster; this is essentially a flight-like thruster. This thruster will have a larger nozzle expansion ratio. Despite the lower exit pressures associated with the larger nozzle, the improved GRC laser diagnostics may still be able to detect valid signals. Thrust will continue to be measured. Testing with this thruster will occur in September and October of 2014. Both thrusters will be modeled and corroborated individually to provide greater insights into plume behavior.

Plume Measurement Diagnostics

Multiple plume diagnostic approaches are being conducted in order to attempt to provide a wide range of parameters to corroborate testing to the models. To provide a wide range of data, the diagnostic approaches will be carried out throughout thruster catalyst life, through the blowdown pressure range of the GPIM spacecraft, and with firings ranging from approximately 0.5 to 5.0 seconds at various duty cycles. Success of laser diagnostics and discovery of behaviors will drive the test matrix.

Physical probes such as thermocouples or pitot tubes may be used in the plume to examine the plume, however, the laser and optical diagnostics are the primary intended methods of data collection. Success of those means may preclude testing with physical probes.

Schlieren flow visualization will be used to provide information on the structure and relative density of the plume flow field. Schlieren may also provide velocity information via the structure of expansion angles. Not only will this provide a qualitative correspondence to the simulated models, it will aid in defining potential zones of interest for other diagnostic methods.

Rayleigh spectroscopy will be utilized to establish further information on velocity and density. This technique will also be used to analyze the temperature of the plume.

Raman spectroscopy is likely the technique of greatest interest to this program due to the unique insights it may provide. Raman yields not only temperature data but is the only technique that will provide species concentration data. The anticipated detection threshold should capture the concentrations of the major species and potentially minor species from incomplete combustion. These species will

provide insights into the chemistry and degree of combustion. For example, the presence and degree of CO concentration relative to CO₂ may give insights into the combustion efficiency of the thruster.

Due to the relatively low signal strength predicted, Raman may present the greatest challenge of these diagnostics. Recent advances in camera technology have increased the potential collection sensitivity the GRC Raman system by 100 to 1000 times and may increase the likelihood of success with the EM thruster; this should provide the ability to detect signals generated in a sub-0.2 psi (1.38 kPa) plume. The results of this are that multiple point interrogation can be conducted with goals of time resolution of less than 1 second. This should result in both location and time resolved data.

A simplified diagram illustrating the setup of the laser diagnostics in the test cell is shown in Figure 18. The laser will enter through the upper optical access of the chamber and vertically pass through the thruster plume near to the nozzle exit plane. The collection optics are located on the optical table horizontally in line with the side optical access. The system has been designed such that multiple points of interrogation within the plume will be acquired at the same time. One of the interrogation points will target a reference nitrogen stream for calibration.

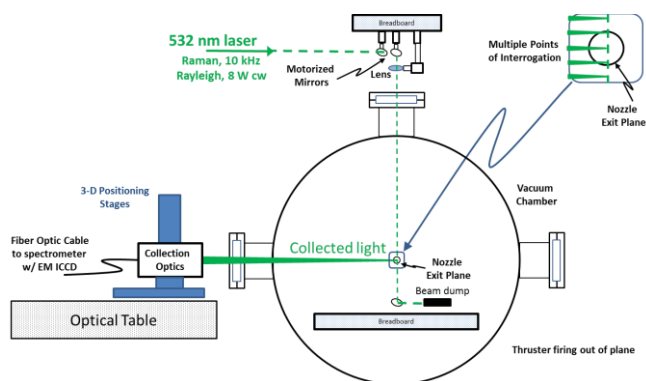

Figure 18: Diagram of Laser Diagnostic Methodology in RCL-11

Model Correlation

The data acquired during the test campaign will be used to anchor the models. The results of the diagnostics will be used to numerically calculate improved model starting conditions. Simulations with the improvements will be conducted under both experimental and flight conditions. These results may show which approaches or assumptions are best suited to capturing the behavior of this type of thruster and propellant. These models will also confirm which general design guidelines are still applicable. In addition to providing useful simulation tools and design guidance for future flight applications, the results may also provide a more fundamental understanding of the behaviors of these propellants for future research and development.

Concluding Remarks

The simulation and experimental work conducted through GPIM at NASA Glenn Research Center are technology risk reduction and infusion aiding tasks so that

this advanced propellant may be applied in other missions. This testing, the first firing of these GPIM thrusters at a NASA center, will provide valuable information correlating plume simulation models to the experimental work. These validated and anchored models will provide guidance for not only the Green Propellant Infusion Mission but for the future implementation of the AF-M315E green monopropellant in enhancing future spacecraft.

Bibliography

- [1] McLean, C., Hale, M., Deininger, W., Spores, R., Frate, D., Johnson, W., et al. (2013). **Green Propellant Infusion Mission Program Overview**. 49TH AIAA/ASME/SAE/ASEE Joint Propulsion Conference. San Jose: AIAA 2013-3847.
- [2] Marshall, W. M., & Deans, M. C. (2013). **Recommended Figures of Merit for Green Monopropellants**. Cleveland: NASA/TM—2013-216560.
- [3] Yim, J., Reed, B., & McLean, C. (2013). **Green Propellant Infusion Mission Plume Impingement Analysis**. 49TH AIAA/ASME/SAE/ASEE Joint Propulsion Conference. San Jose: AIAA 2013-3850.



Overview of NASA Glenn Research Center's Green Propellant Infusion Mission (GPIM) Thruster Testing and Plume Diagnostics

**Presented by Dr. George R. Schmidt
Chief – Propulsion Division, NASA Glenn
on behalf of:**

**Matthew C. Deans, Brian D. Reed, John T. Yim, Lynn A. Arrington
NASA Glenn Research Center, Cleveland OH**

**George J. Williams, Jun J. Kojima
Ohio Aerospace Institute, Cleveland OH**

**Christopher H. McLean
Ball Aerospace and Technologies Corporation, Boulder CO**

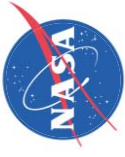

GPIM Overview

Objective:

To advance the technology readiness level of a green propulsion system using the monopropellant AF-M315E by demonstrating ground handling, spacecraft processing, and on-orbit operations

Team:

- Ball Aerospace & Technologies Corp (Ball) – Principal Investigator
- Aerojet Rocketdyne
- Air Force Research Laboratory (AFRL)
- NASA Glenn Research Center (GRC)
- NASA Kennedy Space Center (KSC)
- NASA Goddard Space Flight Center (GSFC)

Program:

- The Green Propellant Infusion Mission (GPIM) is a Technology Demonstration Mission (TDM) within the Space Technology Mission Directorate (STMD)
- STMD programmatic oversight provided by the NASA Marshall Space Flight Center (MSFC)

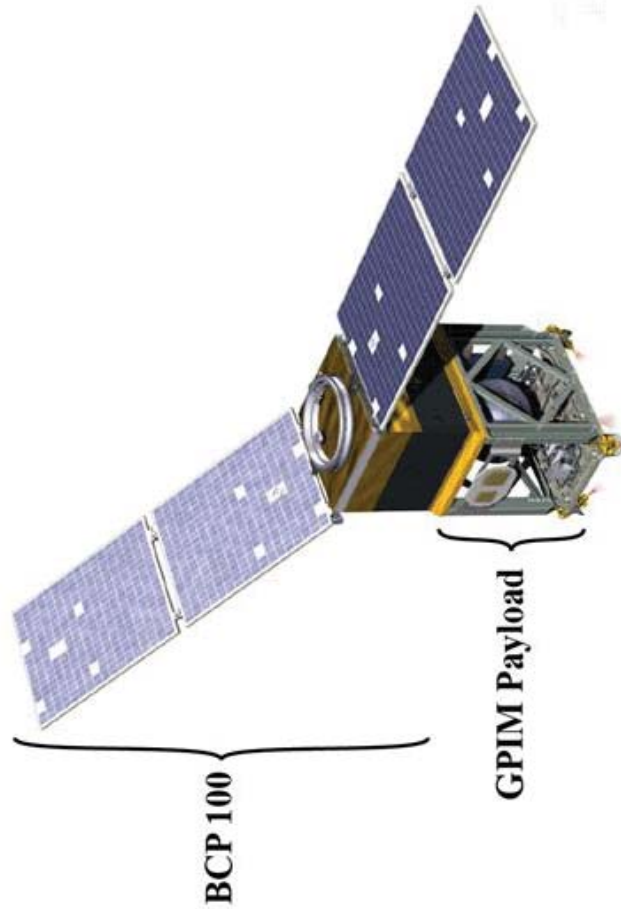

GPIM Payload on BCP 100 Spacecraft
BCP: Ball Configurable Platform



GPIM Overview (continued)

Approach:

- GPIM will fly an AF-M315E green propulsion system on a Ball Aerospace-built BCP-100 spacecraft.
- The propulsion system will have a single 22-N thruster for primary propulsion and four (4), 1-N thrusters for attitude control, operating in blow-down mode.
- The propulsion system will perform operations characterizing:
 - Thruster performance
 - Repeatability
 - Ability to perform requisite RCS and delta-V maneuvers

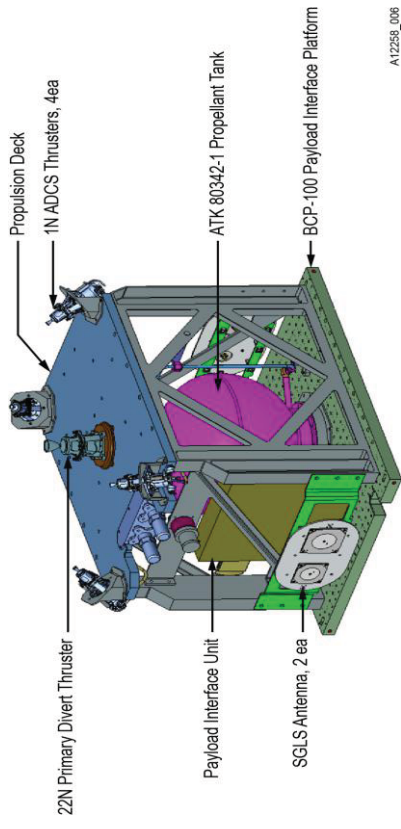

Conceptual Design of AF-M315E Propulsion System

ADCS: Attitude Determination and Control
SGLS: Space to Ground Link System

Infusion Efforts:

- One primary goal of the TDM program office is the application of these newly demonstrated technologies into future spacecraft
- The projects seek to address and allay any concerns that may prevent this acceptance or further infusion
- One concern with any thruster may be the impingement impacts of the plume on the spacecraft
- AF-M315E decomposition products include water, which could condense on solar arrays or optical surfaces
- Carbon monoxide, methane, and ammonia have also been identified as contamination concerns
- Prior to the activities outlined in this paper, there has not been any significant plume modeling or characterization of AF-M315E thrusters
- The efforts at NASA GRC are specifically focused on this concern



GRC's Role

- GRC will conduct plume modeling and characterization
- Plume models of AF-M315E thrusters have been developed
- Impacts of the AF-M315E thruster plumes on the BCP-100 spacecraft have been assessed by predicting deposition rates onto the spacecraft surfaces
- Impingement effects on the spacecraft's solar array power generation capability will also be evaluated
- Plume measurements will be made during the testing of 22-N thrusters and corroborated to the plume models

- Results will be:
 - Assessment of the AF-M315E plume impacts on the GPIM spacecraft
 - Baseline set of AF-M315E plume measurement data
 - An AF-M315E plume model that can provide plume impingement analysis for future applications

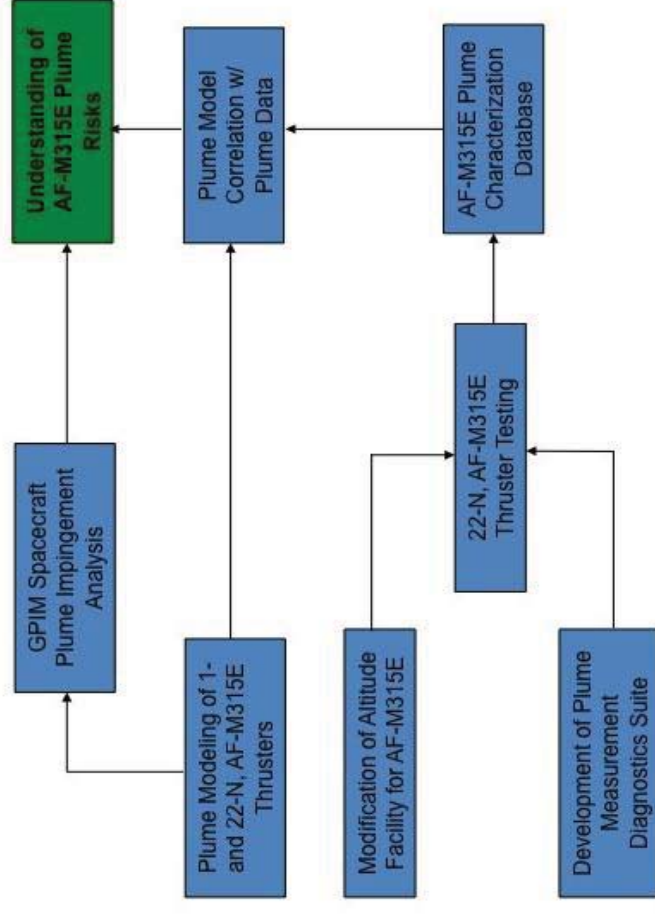

NASA GRC Plume Risk Reduction Activity



Plume Modeling

- Two modeling tools were used to examine the plume properties
- 1) A combination of Reacting And Multi-Phase (RAMP2) / PLume IMPingment (PLIMP) program
 - RAMP2 is an axisymmetric, method-of-characteristics code that calculates the flow field from the throat to the nozzle exit plane and into the plume
 - RAMP2 results are used as input to PLIMP, which calculates surface impingement properties
- 2) Hypersonic Aerothermodynamics Particle (HAP) code
 - HAP calculates the flow field from the throat into the plume using Direct Simulation Monte Carlo (DSMC) method, a particle-gas flow simulation technique.
- Plume flow fields of both the 22-N (50:1 area ratio) and the 1-N (100:1 area ratio) thrusters operating in vacuum are examined
- Two different chamber pressures (400 and 100 psia) are examined
- Two chemistry assumptions (equilibrium and frozen chemistry flow) are examined



Plume Results

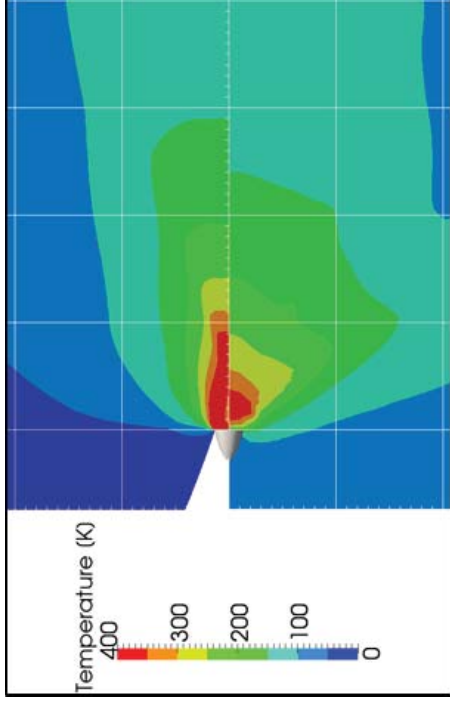
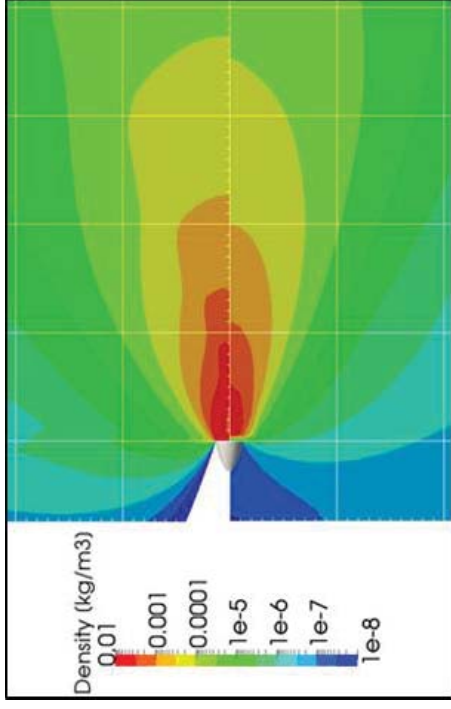

Plume density (left) and temperature (right) for the 22-N thruster with a chamber pressure of 400 psia (2758 kPa) and equilibrium flow as calculated by RAMP2 (top) and HAP (bottom). Grid lines use a 10 cm spacing.

- Results between the two codes are generally within the same order of magnitude
 - RAMP2 results have been well characterized in the downstream region
 - DSMC would expect to provide improved accuracy in rarefied flow regions, particularly upstream of the thruster.
- RAMP2 density results are higher than the HAP results, particularly near the thruster and in the backflow region
- As expected, number density is strongly correlated to the chamber pressure, with about a four to one ratio corresponding to the 400 (2758 kPa) and 100 psia (689 kPa) cases.
- 1-N thruster results (not shown) similarly show two codes are fairly comparable downstream, but with differences in the very near field and at large angles from the thrust axis



Plume Results (continued)

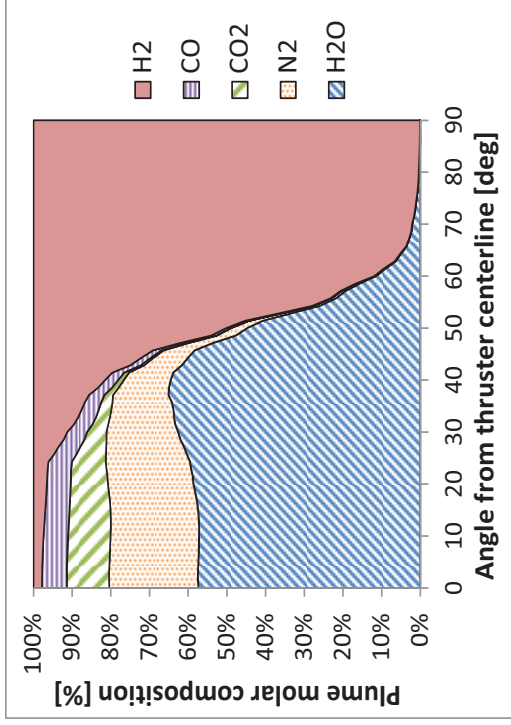

Plume species molar fractions assuming frozen flow at a 40 cm radius from the center of the 22-N thruster exit plane

- Species and thermal analysis also conducted
- Water vapor comprises >50% of the plume by molar fraction within $\sim 45^\circ$ of the thrust axis
- At large angles from the thrust axis, hydrogen gas was found to be the dominant species
- The azimuthal distribution of chemical species correlates to the molecular weight of the species
 - Lighter molecules have a greater probability of being scattered at larger angles
 - Same trends observed for the species impinging on the GPIM spacecraft bus and solar array surfaces
- AF-M315E thrusters were found to generally obey guidelines typical of hydrazine:
 - 90% of the thermal energy of the plume is contained within a cone with a half-angle of approximately 30° from the thrust vector

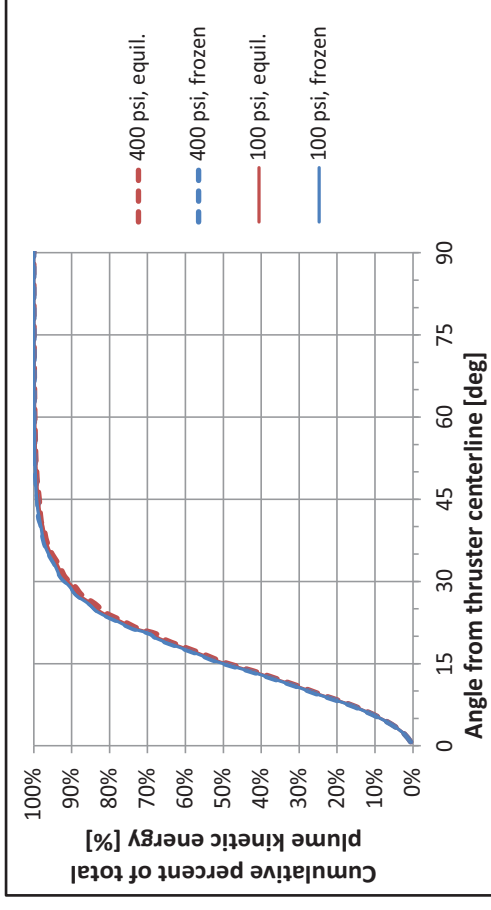

Cumulative percent of total plume kinetic energy for the 22-N thruster



Plume Results (continued)

- Heating rates of GPIM spacecraft surface were benign
 - Maximum heating rate of 127 W/m^2 was observed with the RAMP2 / PLIMP results
- Species deposition analysis conducted
 - Only Multi-Layer Insulation on some surfaces expected to see temperatures low enough where water accumulation may potentially occur
 - No surfaces are expected to see temperatures where ammonia ($< 90 \text{ K}$) and carbon dioxide ($< 70 \text{ K}$) would pose any threat
- Effect of plume impingement impacts on the solar array power generation to be assessed.
- Analysis will leverage both the plume model of the AF-M315E thrusters and the geometric model of the BCP-100
- The solar array degradation will be evaluated accounting for:
 - Chemical contamination
 - Erosion
 - Thermal loading
 - Force loading

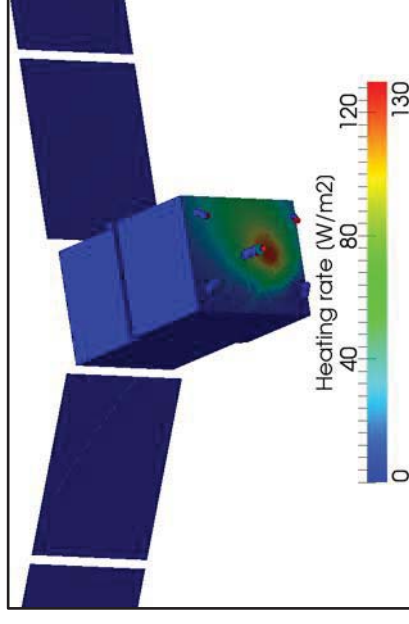
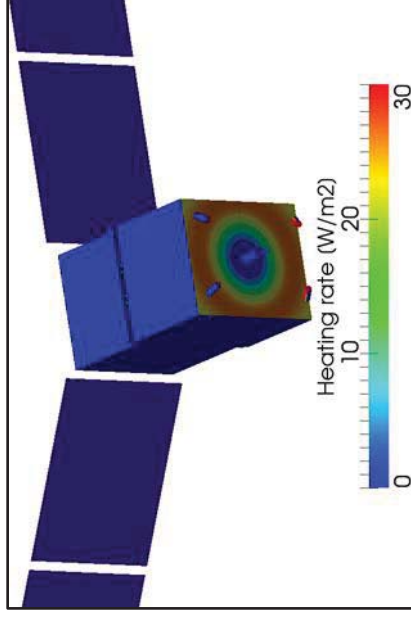

Heating rates calculated by RAMP2/PLIMP on the BCP-100 spacecraft from the 22-N thruster firing (top) and the lower left 1-N thruster firing (bottom)



Thruster Testing and Plume Diagnostics

- Testing will be conducted at GRC's Research Combustion Laboratory – Cell 11 (RCL-11)
- RCL-11 is a small rocket (<220-N), altitude (36.6 km) facility designed with optical access to incorporate the use of laser-based diagnostics
- The facility uses a six-foot long, three-foot diameter cylindrical vacuum tank
- Thrust is measured via load cells
- Vacuum is achieved by the use of a two-stage ejector system
- The thruster is fired horizontally into a water-cooled diffuser
- Like other test cells in the Research Combustion Laboratory, RCL-11 has the ability to be reconfigured for a variety of mono- and bipropellants

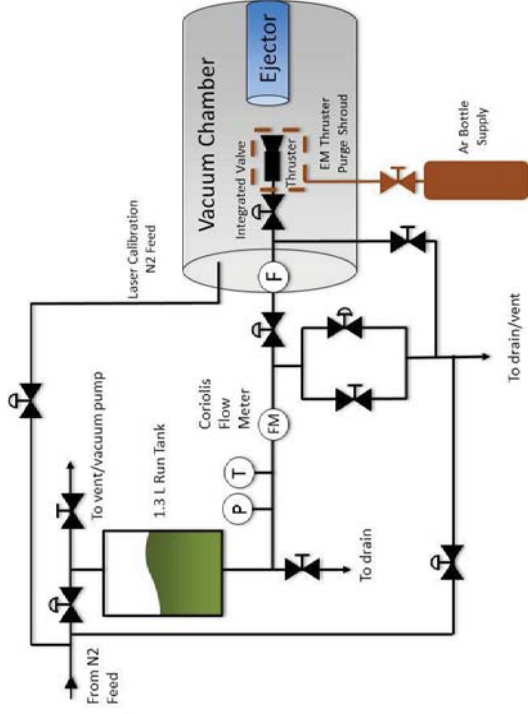

Simplified Green Propellant Flow System Diagram



Green Propellant Flow Panel

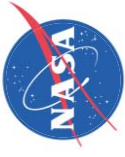

Thrustor Testing and Plume Diagnostics (continued)

Storage:

- Storage of the propellant will be located adjacent to the facility
- The climate control, comprised of a heater and blower, was specified so as to accommodate both AF-M315E and LMP-103S among other energetic ionic liquid propellants
- Magazine has been sited based on quantity-distance regulations to allow the storage of up to 1000 lbs (454 kg) of a Class 1.3C type explosive

Handling and Disposal:

- In proper packaging, AF-M315E ships as a 1.4S class explosive
 - Conforms to established receiving procedures at NASA GRC
- Personal protective equipment (PPE) consists of nitrile gloves, lab coats, and goggles
 - Spill cleaning processes have been defined
- Dilution and disposal procedures for the AF-M315E propellant and any potential contaminated waste water have been developed

Thrustors:

- GRC testing for GPIM will utilize a pair of thrustors manufactured by Aerojet Rocketdyne – Redmond
- Both thrustors are 22-N class thrustors designed for AF-M315E
- The first thrustor to be tested is a Laboratory Model (LM) thrustor: May to July of 2014
- The second thrustor is an Engineering Model (EM) thrustor: September and October of 2014



Propellant Storage Magazine



Thrustor Testing and Plume Diagnostics (continued)

Plume Measurement Diagnostics:

- Diagnostics will be carried out throughout thruster catalyst life, through the blowdown pressure range of GPIM, and with firings ranging from approximately 0.5 to 5.0 sec. at various duty cycles
- Success of laser diagnostics and discovery of behaviors will drive the test matrix
- Multiple techniques will be used:
 - Schlieren flow visualization – Relative density and velocity
 - Rayleigh spectroscopy - Velocity, density, and temperature
 - Raman spectroscopy - Species concentration and temperature
 - Recent advances in camera technology have increased the potential collection sensitivity of our system by 100 to 1000 times and may increase the likelihood of success
 - Multiple point interrogation can be conducted with goals of <1 second time resolution
 - May yield sensitivity to signals generated in a sub-0.2 psia plume
 - Physical plume probes – Pending success of laser diagnostics

Model Correlation:

- Data acquired to be used to anchor the models; results used to numerically calculate improved model starting conditions
- Updated simulations will be conducted under both experimental and flight conditions
- Updated models will confirm that the design standards still hold



Thank you!

Questions? Comments?