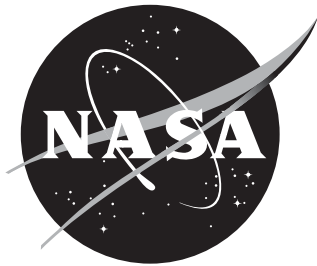


NASA/TP-2014-217522



# International VLBI Service for Geodesy and Astrometry 2013 Annual Report

*Karen D. Baver (ed.)*  
*NVI, Inc., Greenbelt, Maryland*

*Dirk Behrend (ed.)*  
*NVI, Inc., Greenbelt, Maryland*

*Kyla L. Armstrong (ed.)*  
*NVI, Inc., Greenbelt, Maryland*

# NASA STI Program ... in Profile

Since its founding, NASA has been dedicated to the advancement of aeronautics and space science. The NASA scientific and technical information (STI) program plays a key part in helping NASA maintain this important role.

The NASA STI program operates under the auspices of the Agency Chief Information Officer. It collects, organizes, provides for archiving, and disseminates NASA's STI. The NASA STI program provides access to the NTRS Registered and its public interface, the NASA Technical Reports Server, thus providing one of the largest collections of aeronautical and space science STI in the world. Results are published in both non-NASA channels and by NASA in the NASA STI Report Series, which includes the following report types:

- TECHNICAL PUBLICATION. Reports of completed research or a major significant phase of research that present the results of NASA Programs and include extensive data or theoretical analysis. Includes compilations of significant scientific and technical data and information deemed to be of continuing reference value. NASA counterpart of peer-reviewed formal professional papers but has less stringent limitations on manuscript length and extent of graphic presentations.
- TECHNICAL MEMORANDUM. Scientific and technical findings that are preliminary or of specialized interest, e.g., quick release reports, working papers, and bibliographies that contain minimal annotation. Does not contain extensive analysis.
- CONTRACTOR REPORT. Scientific and technical findings by NASA-sponsored contractors and grantees.
- CONFERENCE PUBLICATION. Collected papers from scientific and technical conferences, symposia, seminars, or other meetings sponsored or co-sponsored by NASA.
- SPECIAL PUBLICATION. Scientific, technical, or historical information from NASA programs, projects, and missions, often concerned with subjects having substantial public interest.
- TECHNICAL TRANSLATION. English-language translations of foreign scientific and technical material pertinent to NASA's mission.

Specialized services also include organizing and publishing research results, distributing specialized research announcements and feeds, providing information desk and personal search support, and enabling data exchange services.

For more information about the NASA STI program, see the following:

- Access the NASA STI program home page at <http://www.sti.nasa.gov>
- E-mail your question to [help@sti.nasa.gov](mailto:help@sti.nasa.gov)
- Phone the NASA STI Information Desk at 757-864-9658
- Write to:  
NASA STI Information Desk  
Mail Stop 148  
NASA Langley Research Center  
Hampton, VA 23681-2199

---

Available from:

NASA Center for AeroSpace Information  
7115 Standard Drive  
Hanover, MD 21076-1320  
443-757-5802

## Preface

This volume of reports is the 2013 Annual Report of the International VLBI Service for Geodesy and Astrometry (IVS). The individual reports were contributed by VLBI groups in the international geodetic and astrometric community who constitute the permanent components of IVS.

The IVS 2013 Annual Report documents the work of the IVS components for the calendar year 2013, our fifteenth year of existence. The reports describe changes, activities, and progress of the IVS. Many thanks to all IVS components who contributed to this Annual Report.

With the exception of the first section and the last section, the contents of this Annual Report also appear on the IVS Web site at

<http://ivscc.gsfc.nasa.gov/publications/ar2013>

This book and the Web site are organized as follows:

- The first section contains general information about IVS, a map showing the locations of the components, information about the Directing Board members, and the annual report of the IVS Chair.
- The second section holds four special reports. The first report, “Final Report of IVS Working Group 4 (WG4) on Data Structures”, presents the work of Working Group 4, which was established in 2007 to design a data structure to meet requirements for VLBI sessions and to prepare for the transition to the new structure. This report gives the history of Working Group 4’s efforts, a description of the final data structure, and the remaining steps needed to implement it. The second report,

“IVS WG6 Final Report”, presents the work of Working Group 6, which was established in 2009 to promote education and training within the IVS. Working Group 6’s specific mandates were to develop contacts at educational institutions related to VLBI in order to raise interest in VLBI among students, to develop educational material that could be distributed to educational institutions, and to seek funding, develop a concept, and prepare for providing training, e.g., through VLBI schools. The WG6 report assesses how well WG6 has met its mandates. The report lists contacts identified under the first mandate, material collected under the second mandate, and funding efforts made under the third mandate. The report concludes by discussing and evaluating its first training school, which was held in Helsinki, Finland in conjunction with the EVGA meeting in March 2013, co-sponsored by the European Geosciences Union (EGU), Onsala Space Observatory, and RadioNet, and supported by Aalto University and the Finnish Geodetic Institute. The third report, “VGOS Data Recorder Comparison”, presents tables that assess data recorders for compliance with the VGOS (VLBI Global Observing System) standards. The fourth report, “Proposal for VGOS Observing Plan”, presents the plan of the VPEG (VGOS Project Executive Group) to gradually introduce VGOS observing over the next several years. By means of trial sessions and pilot projects, the proposed observing plan transitions from basically no VGOS observing in 2014 to a fully established 24/7 VGOS observing program by the end of the decade. The plan was endorsed by the IVS Directing Board at its most recent meeting and will be implemented by the IVS Coordinating Center and the OPC (Observing Program Committee).

- The next seven sections hold the reports from the Coordinators and the reports from the IVS Permanent Components: Network Stations, Operation Centers, Correlators, Data Centers, Analysis Centers, and Technology Development Centers.
- The next section contains a compilation of publications in the field of geodetic and astrometric VLBI during 2013.
- The last section includes reference information about IVS. This year the information section has been streamlined, and the majority of it will only be provided on-line. This change conserves paper, but it also recognizes that some categories of information (most notably the list of Associate Members) change within a year, rendering

the printed information out-of-date. Therefore, this year the information section only includes the Terms of Reference and a table of links to the Member and Affiliated organizations, the Associate Members, and the permanent components.

As a replacement for the list of acronyms previously included in the Annual Report, the Coordinating Center plans to develop an on-line list of acronyms to be posted on the IVS web site in the future. The list of addresses of institutions that contributed to this year's Annual Report has been discontinued.

# Table of Contents

Preface .....	iii	Kashima and Koganei 11-m VLBI Stations .....	126
<b>About IVS</b> .....	<b>1</b>	Matera CGS VLBI Station 2013 Annual Report .	130
IVS Organization .....	2	Medicina Station Status Report .....	133
IVS Component Map .....	4	Metsähovi Radio Observatory Network Station 2013 Annual Report .....	135
IVS Directing Board .....	6	VERA 2013 Geodetic Activities .....	139
IVS Chair's Report .....	8	Noto Station Status Report .....	142
<b>Special Reports</b> .....	<b>9</b>	Ny-Ålesund Geodetic Observatory 2013 Annual Report .....	145
Final Report of IVS Working Group 4 (WG4) on Data Structures .....	11	German Antarctic Receiving Station (GARS) O'Higgins .....	148
IVS WG6 Final Report .....	26	Onsala Space Observatory – IVS Network Station Activities During 2013 .....	151
VGOS Data Recorder Comparison .....	64	Korea Geodetic VLBI Station, Sejong .....	155
Proposal for VGOS Observing Plan .....	70	Sheshan VLBI Station Report for 2013 .....	158
<b>IVS Coordination</b> .....	<b>81</b>	The Simeiz Fundamental Geodynamics Area ....	160
Coordinating Center Report .....	83	Svetloe Radio Astronomical Observatory 2013 IVS Annual Report .....	164
The 2013 Analysis Coordinator Report .....	86	JARE Syowa Station 11-m Antenna, Antarctica .	167
Network Coordinator Report .....	89	Status of the TIGO VLBI Station in Concepción .	171
IVS Technology Coordinator Report .....	95	Tsukuba 32-m VLBI Station .....	173
<b>Network Stations</b> .....	<b>99</b>	Nanshan VLBI Station Report 2013 .....	177
Badary Radio Astronomical Observatory 2013 IVS Annual Report .....	101	Warkworth Radio Astronomical Observatory, New Zealand .....	180
Effelsberg Radio Observatory 2013 Annual Re- port .....	104	Westford Antenna 2013 Annual Report .....	184
Fortaleza Station 2013 Annual Report .....	106	Geodetic Observatory Wettzell - 20-m Radio Tele- scope and Twin Telescopes .....	187
Goddard Geophysical and Astronomical Observa- tory .....	108	Instituto Geográfico Nacional of Spain .....	191
Hartebeesthoek Radio Astronomy Observatory (Har- tRAO) .....	111	Zelenchukskaya Radio Astronomical Observatory 2013 IVS Annual Report .....	195
AuScope VLBI Project and Hobart 26-m Antenna	115	<b>Operation Centers</b> .....	<b>199</b>
Kashima 34-m VLBI Station .....	119	The Bonn Geodetic VLBI Operation Center .....	201
Kokee Park Geophysical Observatory .....	123	CORE Operation Center 2013 Annual Report ...	203
		NEOS Operation Center .....	206

<b>Correlators</b> .....	<b>207</b>	U.S. Naval Observatory VLBI Analysis Center ..	325
The Bonn Astro/Geo Correlator .....	209	USNO Analysis Center for Source Structure Re-	port .....
Haystack Observatory VLBI Correlator .....	213	Vienna Special Analysis Center Annual Report	2013 .....
IAA Correlator Center 2013 Annual Report .....	217		330
Correlation Processing in NICT Kashima .....	221	<b>Technology Development Centers</b> ..	<b>335</b>
Shanghai VLBI Correlator 2013 Annual Report ..	224	Canadian VLBI Technology Development Center	Report .....
Tsukuba VLBI Correlator .....	227		337
Washington Correlator .....	231	GSFC Technology Development Center Report ..	338
<b>Data Centers</b> .....	<b>233</b>	Haystack Observatory Technology Development	Center .....
BKG Data Center .....	235		341
CDDIS Data Center Summary for the IVS 2013	Annual Report .....	NICT Technology Development Center 2013 Annual	Report .....
	237		345
Italy INAF Data Center Report .....	240	Onsala Space Observatory – IVS Technology Devel-	opment Center Activities during 2013 .....
Data Center at NICT .....	241		349
Paris Observatory (OPAR) Data Center .....	244	<b>Bibliography</b> .....	<b>353</b>
<b>Analysis Centers</b> .....	<b>247</b>	Bibliography .....	355
Analysis Center of Saint Petersburg University ..	249	<b>IVS Information</b> .....	<b>367</b>
Geoscience Australia Analysis Center 2013 Annual	Report .....	IVS Terms of Reference .....	369
	251	Links to Additional IVS Information .....	376
Report for 2013 from the Bordeaux IVS Analysis	Center .....		
	253		
BKG/DGFI Combination Center Annual Report	2013 .....		
	257		
Matera CGS VLBI Analysis Center .....	261		
DGFI Analysis Center Annual Report 2013 .....	263		
GFZ Analysis Center 2013 Annual Report .....	265		
The BKG/IGGB VLBI Analysis Center .....	268		
GSFC VLBI Analysis Center Report .....	272		
Haystack Observatory Analysis Center .....	276		
IAA VLBI Analysis Center Report 2013 .....	280		
Italy INAF Analysis Center .....	283		
JPL VLBI Analysis Center Report for 2013 .....	285		
KASI Combination Center 2013 Annual Report ..	288		
KTU-GEOD IVS Analysis Center Annual Report	2013 .....		
	292		
Analysis Center at National Institute of Information	and Communications Technology .....		
	295		
NMA Analysis Center 2013 Annual Report .....	299		
Paris Observatory (OPAR) Analysis Center .....	301		
Onsala Space Observatory – IVS Analysis Center	Activities during 2013 .....		
	304		
PMD Analysis Center 2013 Annual Report .....	308		
Pulkovo IVS Analysis Center (PUL) 2013 Annual	Report .....		
	312		
SAI VLBI Analysis Center 2013 Annual Report ..	316		
SHAO Analysis Center 2013 Annual Report .....	318		
Tsukuba VLBI Analysis Center .....	321		

# About IVS



# IVS Organization

## Objectives

IVS is an international collaboration of organizations which operate or support Very Long Baseline Interferometry (VLBI) components. The goals are:

1. To provide a service to support geodetic, geophysical and astrometric research and operational activities.
2. To promote research and development activities in all aspects of the geodetic and astrometric VLBI technique.
3. To interact with the community of users of VLBI products and to integrate VLBI into a global Earth observing system.

## The IVS

- Interacts closely with the IERS, which is tasked by IAU and IUGG with maintaining the international celestial and terrestrial reference frames (ICRF and ITRF),
- coordinates VLBI observing programs,
- sets performance standards for the observing stations,
- establishes conventions for data formats and products,
- issues recommendations for analysis software,
- sets standards for analysis documentation,
- institutes appropriate product delivery methods in order to insure suitable product quality and timeliness.

## Realization And Status Of IVS

### IVS consists of

- 32 Network Stations, acquiring high performance VLBI data,
- 3 Operation Centers, coordinating the activities of a network of Network Stations,
- 7 Correlators, processing the acquired data, providing feedback to the stations and providing processed data to analysts,
- 5 Data Centers, distributing products to users, providing storage and archiving functions,
- 28 Analysis Centers, analyzing the data and producing the results and products,
- 6 Technology Development Centers, developing new VLBI technology,
- 1 Coordinating Center, coordinating daily and long term activities.

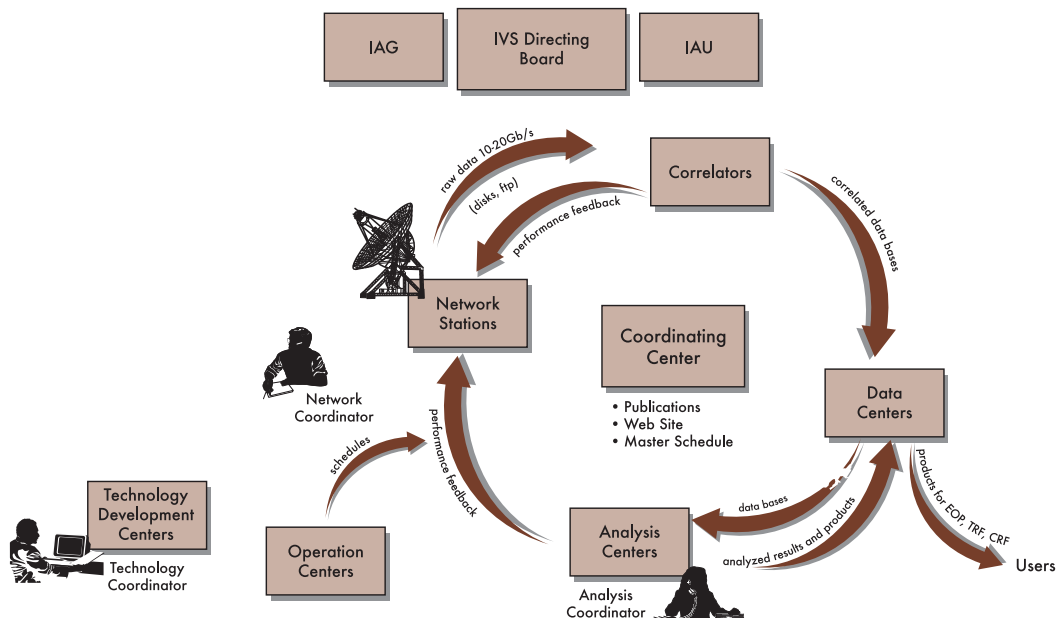
### Altogether

- 82 Permanent Components, representing 43 institutions in 21 countries,
- ~280 Associate Members.

### In addition the IVS has:

- Directing Board, determining policies, standards and goals; the board is composed of 16 members (elected and ex officio), including
- Coordinators for the network, analysis and technology.

## ORGANIZATION OF INTERNATIONAL VLBI SERVICE





## IVS Member Organizations

The following organizations contribute to IVS by supporting one or more IVS components. They are considered IVS Members. Listed alphabetically by country.

Organization	Country
Geoscience Australia	Australia
University of Tasmania	Australia
CSIRO	Australia
Vienna University of Technology	Austria
Centro de Rádio Astronomia e Aplicações Espaciais	Brazil
Geodetic Survey Division, Natural Resources Canada	Canada
Dominion Radio Astrophysical Observatory	Canada
Universidad de Concepción	Chile
Instituto Geográfico Militar	Chile
Chinese Academy of Sciences	China
Finnish Geodetic Institute, Aalto University	Finland
Observatoire de Paris	France
Laboratoire d'Astrophysique de Bordeaux	France
Deutsches Geodätisches Forschungsinstitut	Germany
Bundesamt für Kartographie und Geodäsie	Germany
Institut für Geodäsie und Geoinformation der Universität Bonn	Germany
Forschungseinrichtung Satellitengeodäsie, TU-Munich	Germany
Max-Planck-Institut für Radioastronomie	Germany
GeoForschungsZentrum Potsdam	Germany
Istituto di Radioastronomia INAF	Italy
Agenzia Spaziale Italiana	Italy
Politecnico di Milano DIAR	Italy
Geospatial Information Authority of Japan	Japan
National Institute of Information and Communications Technology	Japan
National Astronomical Observatory of Japan	Japan
National Institute of Polar Research	Japan
Auckland University of Technology	New Zealand
Norwegian Mapping Authority	Norway
Astronomical Institute of St.-Petersburg University	Russia
Institute of Applied Astronomy	Russia
Pulkovo Observatory	Russia
Sternberg Astronomical Institute of Moscow State University	Russia

Organization	Country
Hartebeesthoek Radio Astronomy Observatory	South Africa
Korea Astronomy and Space Science Institute	South Korea
National Geographic Information Institute	S. Korea
Instituto Geográfico Nacional	Spain
Chalmers University of Technology	Sweden
Karadeniz Technical University	Turkey
Main Astronomical Observatory, National Academy of Sciences, Kiev	Ukraine
Laboratory of Radioastronomy of Crimean Astrophysical Observatory	Ukraine
NASA Goddard Space Flight Center	USA
U. S. Naval Observatory	USA
Jet Propulsion Laboratory	USA

## IVS Affiliated Organizations

The following organizations cooperate with IVS on issues of common interest, but do not support an IVS component. Affiliated Organizations express an interest in establishing and maintaining a strong working association with IVS to mutual benefit. Listed alphabetically by country.

Organization	Country
Australian National University	Australia
University of New Brunswick	Canada
FÖMI Satellite Geodetic Observatory	Hungary
Joint Institute for VLBI in Europe (JIVE)	Netherlands
Westerbork Observatory	Netherlands
National Radio Astronomy Observatory	USA

## Products

### The VLBI technique contributes uniquely to

- Definition and realization of the International Celestial Reference Frame (ICRF)
- Monitoring of Universal Time (UT1) and length of day (LOD)
- Monitoring the coordinates of the celestial pole (nutation and precession)

### Further significant products are

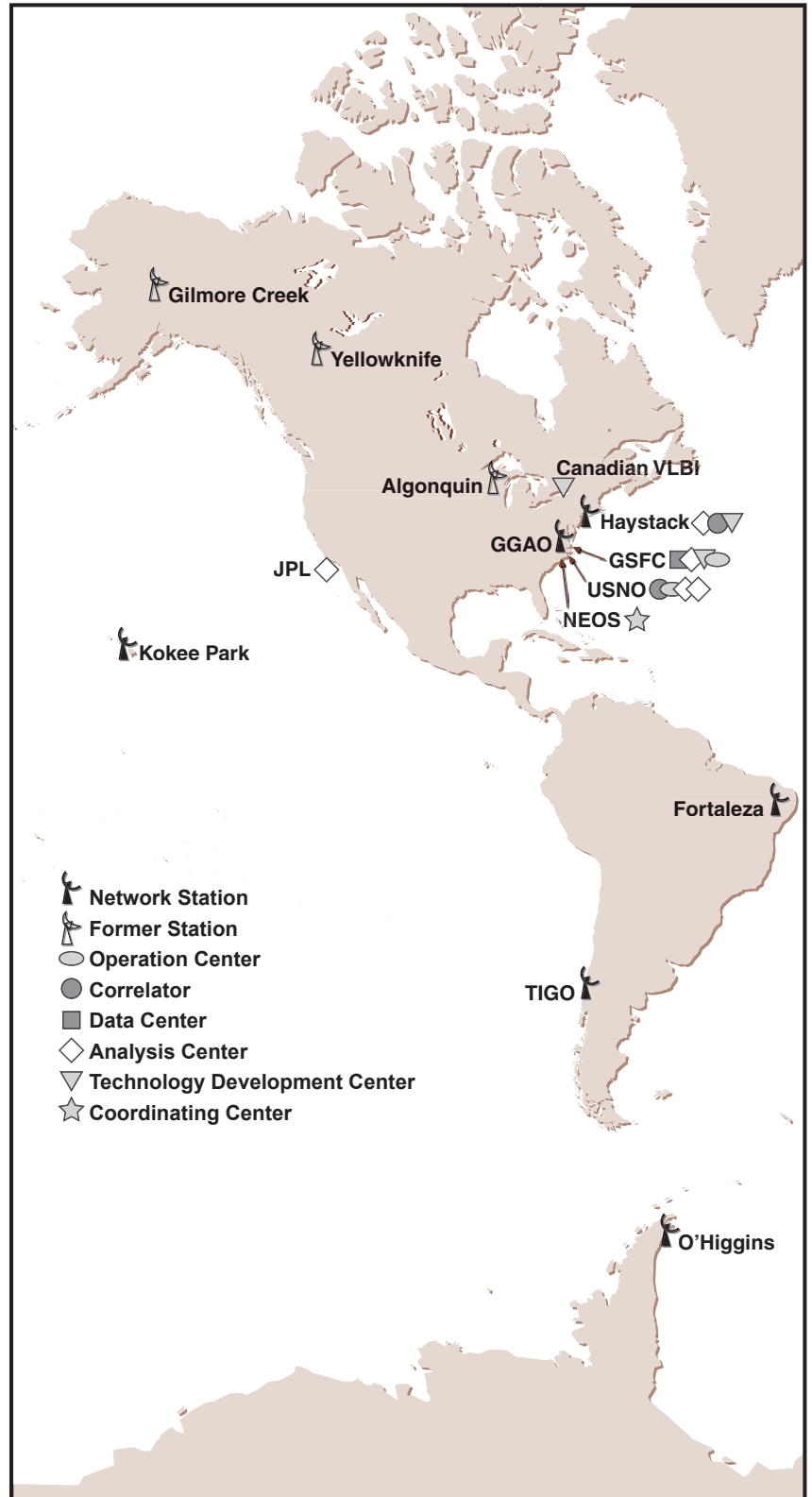
- All components of Earth Orientation Parameters at regular intervals
- Station coordinates and velocity vectors for the realization and maintenance of the International Terrestrial Reference Frame (ITRF)

All VLBI data and results in appropriate formats are archived in data centers and publicly available for research in related areas of geodesy, geophysics and astrometry.

# IVS Component Map

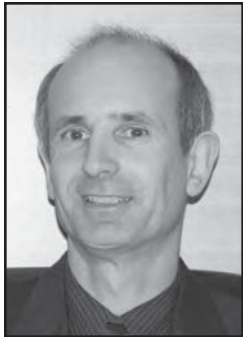
## IVS Components by Country

Country	Qty.
Australia	3
Austria	1
Brazil	1
Canada	1
Chile	1
China	4
Finland	1
France	3
Germany	10
Italy	7
Japan	12
New Zealand	1
Norway	2
Russia	9
South Africa	1
South Korea	2
Spain	1
Sweden	3
Turkey	1
Ukraine	2
USA	16
<b>Total</b>	<b>82</b>





# IVS Directing Board



NAME: Axel Nothnagel  
AFFILIATION: University of Bonn, Germany  
POSITION: Chair, Analysis and Data Centers Representative  
TERM: Feb 2013 to Feb 2017



NAME: John Gipson  
AFFILIATION: NVI, Inc./Goddard Space Flight Center, USA  
POSITION: Analysis Coordinator  
TERM: permanent



NAME: Dirk Behrend  
AFFILIATION: NVI, Inc./Goddard Space Flight Center, USA  
POSITION: Coordinating Center Director  
TERM: ex officio



NAME: Rüdiger Haas  
AFFILIATION: Chalmers University of Technology, Sweden  
POSITION: Technology Development Centers Representative  
TERM: Feb 2013 to Feb 2017



NAME: Alessandra Bertarini  
AFFILIATION: University of Bonn, Germany  
POSITION: Correlators and Operation Centers Representative  
TERM: Feb 2011 to Feb 2015



NAME: Hayo Hase  
AFFILIATION: Bundesamt für Kartographie und Geodäsie/TIGO, Germany/Chile  
POSITION: Networks Representative  
TERM: Feb 2011 to Feb 2015



NAME: Patrick Charlot  
AFFILIATION: Laboratoire d'Astrophysique de Bordeaux, France  
POSITION: IAU Representative  
TERM: ex officio



NAME: Ed Himwich  
AFFILIATION: NVI, Inc./Goddard Space Flight Center, USA  
POSITION: Network Coordinator  
TERM: permanent



NAME: Alexander Ipatov  
 AFFILIATION: Institute of Applied Astronomy, Russia  
 POSITION: At Large Member  
 TERM: Feb 2013 to Feb 2015



NAME: Arthur Niell  
 AFFILIATION: MIT Haystack Observatory, USA  
 POSITION: Analysis and Data Centers Representative  
 TERM: Feb 2013 to Feb 2015



NAME: Shinobu Kurihara  
 AFFILIATION: Geospatial Information Authority, Japan  
 POSITION: At Large Member  
 TERM: Feb 2013 to Feb 2015



NAME: William Petrachenko  
 AFFILIATION: Natural Resources Canada, Canada  
 POSITION: Technology Coordinator  
 TERM: permanent



NAME: James Lovell  
 AFFILIATION: University of Tasmania, Australia  
 POSITION: Networks Representative  
 TERM: Feb 2013 to Feb 2017



NAME: Harald Schuh  
 AFFILIATION: GFZ German Research Center for Geosciences, Germany  
 POSITION: IAG Representative  
 TERM: ex officio



NAME: Chopo Ma  
 AFFILIATION: NASA Goddard Space Flight Center, USA  
 POSITION: IERS Representative  
 TERM: ex officio



NAME: Fengchun Shu  
 AFFILIATION: Shanghai Astronomical Observatory, China  
 POSITION: At Large Member  
 TERM: Feb 2013 to Feb 2015

## Axel Nothnagel

Institut für Geodäsie und Geoinformation der Universität Bonn

On March 8, 2013 at the 29th IVS Directing Board Meeting, I was elected the third chair of the IVS following my successful predecessors, Wolfgang Schlüter and Harald Schuh. In the last six years, Harald has done a tremendous job, pushing the IVS forward in our initiative which is now called VGOS, the VLBI Global Observing System. I should state that Harald's name will always be linked directly to the VGOS acronym.

For my own person, I am proud to be chairing the IVS with its many motivated and active individuals, as I indicated at various occasions already. I hope that I will be a chair who fulfills most if not all expectations which the community puts onto me.

Since my election, only a few but still noteworthy activities fell into my responsibility. Most of them are rather of administrative nature which also have to do with seeking approval of the directing board. The most important one certainly is that the VGOS Observing Plan was adopted and is now available on the IVS web site for reference. The VGOS Observing Plan should guide us during the transition period from legacy to VGOS operations which is purely based on wide-band observations.

Another highlight in 2013 was the approval of the South African Government to fund the construction of a fully equipped VGOS telescope at the Hartebeesthoek Radio Astronomy Observatory near Johannesburg, South Africa. We are really looking forward to this new contributor which will be fundamental to VGOS in the southern hemisphere. Independently of this, the Directing Board also voted unanimously for holding the 9th IVS General Meeting scheduled for 2016 in South Africa.

In my function as the IVS Chair I attended the IERS Local Tie Workshop in Paris, France, on May 21/22, 2013, and presented the IVS status and prospects at the IAG Scientific Assembly in Potsdam, Germany, on September 4, 2013.

All in all, I can state that I have taken over a well functioning entity from my predecessor, Harald Schuh, where there is little to no necessity for fundamental changes. Our way of developing the IVS further by the establishment of VGOS is certainly something which will need our full attention in the next few years. However, we should not forget that there is ample scope of application also for the legacy antennas with the current setup of S/X

band observations in the future. We should try to keep and operate them as long as possible. In between the two standard configurations, there may be a need for mixed-mode operations to link the VGOS telescopes into the VLBI terrestrial reference frame. All of this requires strong endeavors of research and development. At the same time, however, let us always remember that we are a service which serves quite a number of customers and that the majority of activities has to follow the concept of a service.

In this respect, I thank already all contributors to this annual report and our colleagues at the IVS Coordinating Center for compiling, printing and distributing this issue. The timely appearance and distribution of the annual report has always been a trademark of the IVS.

# Special Reports







## Final Report of IVS Working Group 4 (WG4) on Data Structures

John Gipson<sup>1</sup>, Johannes Böhm<sup>2</sup>, Sergei Bolotin<sup>1</sup>, David Gordon<sup>1</sup>, Thomas Hobiger<sup>3</sup>, Chris Jacobs<sup>4</sup>, Sergey Kurdobov<sup>5</sup>, Axel Nothnagel<sup>6</sup>, Ojars Sovers<sup>7</sup>, Oleg Titov<sup>8</sup>, Hiroshi Takiguchi<sup>9</sup>

<sup>1</sup>NVI, Inc at NASA Goddard Spaceflight Center, United States,

<sup>2</sup>Department of Geodesy and Geoinformation, Vienna University of Technology, Austria

<sup>3</sup>National Institute of Information and Communications Technology, Japan

<sup>4</sup>Jet Propulsion Laboratory, United States

<sup>5</sup>Institute of Applied Astronomy, St. Petersburg, Russia

<sup>6</sup>Institute of Geodesy and Geoinformation, University of Bonn, Germany

<sup>7</sup>Remote Sensing Analysis, Inc., United States

<sup>8</sup>Geosciences Australia, Australia

<sup>9</sup>Auckland University of Technology, New Zealand

### 1 History

At the 15 September 2007 IVS Directing Board meeting I proposed establishing a “Working Group on VLBI Data Structures”. The thrust of the presentation was that, although the VLBI database system has served us very well these last 30 years, it is time for a new data structure that is more modern, flexible, and extensible. This proposal was unanimously accepted, and the board established IVS Working Group 4. Quoting from the IVS Web site [1]:

*“The Working Group will examine the data structure currently used in VLBI data processing and investigate what data structure is likely to be needed in the future. It will design a data structure that meets current and anticipated requirements for individual VLBI sessions including a cataloging, archiving, and distribution system. Further, it will prepare the transition capability through conversion of the current data structure as well as cataloging and archiving softwares to the new system.”*

### 2 Organization of the Working Group

Any change to the VLBI data format affects everyone in the VLBI community. Therefore, it is important that the working group have representatives from a broad cross-section of the IVS community. The initial membership was arrived at in consultation with the IVS Directing Board. Table 1 lists the current and past members of WG4 together with the

John Gipson	Chair/Solve
Sergei Bolotin	Steelbreeze
Roger Capallo	Correlators
Axel Nothnagel	Analysis Coordinator

David Gordon	Calc/Solve
Chris Jacobs Ojars Sovers	Modest
Oleg Titov Volker Tesmer	Occam
Johannes Böhm	Views
Sergey Kurdobov	IAA
Anne-Marie Gontier	PIVEX
Thomas Hobiger Hiroshi Takiguchi	NICT/C5++

We were all saddened at the premature death of Anne-Marie Gontier during this period. In addition some members left the Working group because of a change in professional status or retirement.

### 3 Earlier Related Work

There have been proposals to redesign how geodetic VLBI data is stored and archived. We want to particularly mention two of these. We want to particularly mention:

1. A memo written by Leonid Petrov “Specifications of a geo-VLBI format” in the late 1990s. [See reference to undated memo by L. Petrov in Reference.]
2. The work of Anne-Marie Gontier on the Gloria database.

In addition, at the second IVS Analysis Workshop in February 2001, a working group was set up to develop a VLBI exchange format independent of platforms and operating systems. This working group included Gontier and Petrov, as well as other members of the VLBI community. The working group resulted in the definition of the PIVEX format [Gontier, 2002]. Several Mark3 databases, including an Intensive (01DEC31XU), a NEOS (01DEC11XE) and an RDV session (01MAY09XA) were converted to PIVEX format. Unfortunately, PIVEX was never widely adopted in the VLBI community.

Since the goals of this earlier working group were substantially similar to IVS Working Group 4 It is not surprising that WG4 was strongly influenced by this earlier work since the goals of this earlier working group were so similar. We learned from both the successes and failures of this earlier work. In terms of success much of the way the data is organized is similar to the organization proposed by Petrov and/or Gontier. In particular, organizing data by scope (how broadly applicable is the data) and the concept of wrapper are very similar to L. Petrov. Both of these are discussed below. A major difference is that WG4 proposes relying on an established format (NetCDF) to store the VLBI data instead of defining an entirely new format.

### 4 History and Goals

WG4 held its first meeting at the 2008 IVS General Meeting in St. Petersburg, Russia. This meeting was open to the general IVS community. Roughly 25 scientists attended: ten WG4 members and fifteen others. This meeting was held after a long day of proceedings. The number

of participants and the lively discussion that ensued is strong evidence of the interest in this subject.

A set of design goals, displayed in Table 1, emerged from this discussion. In some sense the design goals imply a combination and extension of the current VLBI databases, the information contained on the IVS session Web-pages, and much more information [2].

During the next year the working group communicated via email and telecon and discussed how to meet the goals that emerged from the St. Petersburg meeting. A consensus began to emerge about how to achieve most of these goals.

**Table 1. Design Goals of Working Group IV**

<b>Goal</b>	<b>Description</b>
<b>Provenance</b>	Users should be able to determine the origin of the data and what was done to it.
<b>Compactness</b>	The data structure should minimize redundancy and the storage format should emphasize compactness.
<b>Speed</b>	Data retrieval should be fast.
<b>Platform/OS/ Language Support</b>	Data should be accessible by programs written in different languages, running on a variety of computers and operating systems.
<b>Extensible</b>	It should be easy to add new data types.
<b>Open</b>	Data should be accessible without the need of proprietary software.
<b>Decoupled</b>	Different types of data should be separate from each other.
<b>Multiple data levels</b>	Data should be available at different levels of abstraction. For example, levels most users are only interested in the delay and rate observables. Specialists may be interested in correlator output.
<b>Completeness</b>	All VLBI data required to process (and understand) a VLBI session from start to finish should be available: schedule files, email, log-files, correlator output, and final 'database'.
<b>Web Accessible</b>	All data should be available via the Web.

The next face-to-face meeting of WG4 was held at the 2009 European VLBI Meeting in Bordeaux, France. This meeting was also open to the IVS community. At this meeting a proposal was put forward to split the data contained in the current Mark3 databases into smaller files which are organized by a special ASCII file called a wrapper. Overall the reaction was positive. In the summer of 2009 we worked on elaborating these ideas, and in July a draft proposal was circulated to Working Group 4 members. The ideas continued to be refined over the next years.

Because of the desire for the new format to be open, and as a nod to Mark3 database structure, we originally called the new format openDB. A subsequent internet search revealed that this name was already taken, and the new format was renamed to vgosDB.

## 5 Current Organization of VLBI Data

Currently the smallest piece of VLBI data that is routinely analyzed is a VLBI session. This information is archived and stored in Mark3 database. These databases contain information used in the analysis of a VLBI session, which are usually 1-hour (intensives) or 24-hours. With very few exceptions, there are usually gaps between sessions, and hence a VLBI session is a natural piece of VLBI data to work with.

### 5.1 Mark3 Databases

The Mark3 database organizes data by “Lcodes” with each Lcode corresponding to a different data item. The data associated with a given Lcode can be stored as ASCII Strings, Integer\*2, Integer\*4 or Real\*8. The Mark3 database was designed to contain all<sup>1</sup> the data necessary to analyze a VLBI session within a single file. The database file contains the observables but it also contains theoretical values, partials and calibrations.

There are two types of Lcodes:

1. Type-1 Lcodes contain data that is applicable for the entire session.
  - a. Examples: station names and positions, source names and positions, session name, etc.
  - b. This information occurs only once in the database.
  - c. There are roughly 100 different Lcodes.
2. Type-2 and -3 Lcodes are conceptually identical. Type-3 Lcodes were introduced because of limitations of the HP operating system in the 1980s. These Lcodes contain observation dependent data:
  - a. Examples: EOP data, a priori nutation, various partials, delay, rate, sigmas.
  - b. The database contains data for each Lcode and each observation, e.g., each observation has an associated EOP value, met values, etc.
  - c. There are around 400 different Type-2 and Type-3 Lcodes.

The Mark3 databases are fundamentally organized by observation, as illustrated below.

**Table 2. Mark3 databases are organized by session- and observation-dependent data.**

Type 1 Lcodes: Session Data						
Source List	Station List	Correlator	Principle Investi- gator	Flags	Etc...	
Type 2 and 3 Lcodes: Observation Data						
	Lcode1 SourceName	Lcode2 1 <sup>st</sup> Station	Lcode3 2 <sup>nd</sup> Station	Lcode3 EOP	...	LcodeM Observable
Obs1						
Obs2						
...						
ObsN						

<sup>1</sup> Over time this proved impractical, and some of data is now stored in external files. Examples include EOP files, pressure loading, episodic motion, etc.

It is important to note that the Mark3 database format is both a method of organizing data and a means of storing data. Data is organized by Lcodes, where the Lcodes are Session-dependent or Observation dependent. The data is stored in a proprietary format.

The Mark3 database format has some nice features which we do not want to lose. Among these are:

1. Table of Contents. You can easily see what data is available in a given database.
2. Self-descriptive data. Each data item has a brief description of what it is.
3. History. Each database contains a history of its processing.

The specific Lcodes within a database vary depending on the age of the database and how the data was processed. Older databases contain obsolete Lcodes which are relics of how the data was analyzed at the time. In addition databases contain information about the fringing process, and this information is different for each kind of correlator. The number of Lcodes has increased over time as a result of model changes, the desire to use new kinds of data, etc. A consequence of this is that a Mark3 database contains data that is obsolete and never used.

Some problems associated with Mark3 databases are:

1. Requires proprietary software.
2. Only used by the *calc/solve* user community.
3. Redundancy.
  - a. Much VLBI data is really scan-dependent, not observation dependent.
  - b. There is one database for each band.
4. Mixing of observations and theoretical models.
5. Changing a model or adding new kinds of data means updating the entire database.
6. Difficult or impossible to exchange partial information, i.e., ambiguity resolution or editing criteria.
7. Contains obsolete data and models.
8. Contains data that is very seldom used.
9. Contains data that is *calc/solve* specific.
10. Slow data access which makes it prohibitively time-consuming to use the Mark3 database in large VLBI solutions.

In spite of the above problems, the Mark3 database has been in use for over 35 years which is a testament to the many virtues it has.

## **5.2 NGS Card Format**

Because of the proprietary nature of the Mark3 database an alternative format called "NGS card" format was developed to exchange VLBI information. This consists of a single ASCII file with a series of lines. The top of the file contains header information which describes the session as a whole, such as stations, sources and their positions. This is analogous to the Type-1 Lcodes in the Mark3 database. This is followed by information about the observations. This is analogous to the information contained in the Type-2 Lcodes.

The advantage of the NGS format is that it is fairly easy to write software to parse the file. Some of the disadvantages are:

1. Inflexible. Hard to add new data types.
2. Does not contain all of the VLBI data needed to analyze a solution from the beginning. Hence errors in the initial data editing and ambiguity resolution are 'baked-into' the data and become impossible to fix down-stream.
3. Machine access is slower than for binary files.

### **5.3 PIVEX Format**

Pivex was an ASCII format designed to archive and store VLBI data [Gontier 2002]. It was never widely adopted.

### **5.4 Other Formats**

Because of the speed advantages that storing data in binary files has, most VLBI analysis software uses a custom format specific to the particular software.

For doing large global solutions which combine data from many sessions, *solve* stores data in 'superfiles'. These superfiles are essentially binary dumps of Fortran common blocks which contain subsets of the data in a Mark3 database. The organization is also roughly similar to that of Mark3 databases. One common block contains information common to the session as a whole. Another common block contains information applicable to a given observation. Solve uses this information by reading in the common-block for a particular observation *en-masse*.

Other software packages such as Steelbreeze, Occam and VieVs use their own proprietary format. This makes it difficult to exchange data.

As mentioned above, one of the primary reasons for using a proprietary format is that Mark3 database access is slow. Proprietary binary formats were developed in part as a reaction to this. On the other hand the NetCDF format is designed for fast access. One of the goals of the vgosDB is to encourage the use of a common format for data processing and exchange.

## 6 Overview of vgosDB format

In this section we present a brief overview of the new format.

### 6.1 Organizing Data by Sessions

The smallest piece of VLBI data routinely analyzed is the data contained in a Mark3 database. Each database contains the data for a single session. Sessions are usually 24 hours (standard sessions) or 1 hour (intensives). With a few exceptions such as the CONT series (campaigns where VLBI data is taken over an extended period of time, usually around 2 weeks), there are usually gaps between sessions, and hence a VLBI session is natural piece of VLBI data to work with.

In the most optimistic VLBI2010 scenario, there are never gaps in the observing. Some stations may stop observing for a time (for example, for scheduled maintenance), but there will always be a number of stations observing. This is analogous to the situation in GPS and SLR, where some instruments are always on. However, both of these techniques find it useful to divide data into smaller pieces for analysis.

A crucial difference between VLBI and the other space-geodetic techniques is that VLBI is a cooperative venture—stations must observe in a coordinated manner, i.e., two or more stations must observe the same source at the same time, and the observing modes must be the same or similar. If the observing mode is substantially different, then you cannot correlate the data between two stations, and hence there are no observables.

We propose to continue to organize data by session. However, instead of storing most of the data related to a particular session in a Mark3 database, the vgosDB format breaks the data into smaller pieces which are stored in files (see below). All of the data associated with a particular session is stored under a directory named after that session, e.g., 10JAN04XA would contain all of the information related to IVS session R1412.

### 6.2 Modularization

A solution to many of the design goals of Table 3 is to modularize the data, that is to break up the data associated with a session into smaller pieces. These smaller pieces are organized by ‘type’; e.g., group delay observable, pressure data, temperature data, editing criteria, station names, and station positions. In many, though not all, cases, each ‘type’ corresponds to a Mark3 database Lcode. We refer to each data item as **an vgosDB variable**.

Different data types are stored in different files, with generally only one or a few closely related data types in each file. For example, it is logical to store all of the met-data for a station together in a single file. This data usually comes from a single instrument. However, there is no compelling reason to store the met-data together with pointing information. Splitting the data in this way has numerous advantages, some of which are outlined below. The first three directly address the design goals. The last was not originally specified, but is a consequence of this design decision.

1. Separable. Users can retrieve only that part of the data in which they are interested.

2. Extensible. As new data types become used, for example, source maps, they can be easily added without having to rewrite the whole scheme. All you need to do is specify a new data type and the file format.
3. Decoupled. Different kinds of data are separated from each other. Observables are separated from models. Data that won't change is separated from data that might change.
4. Partial Data Update. Instead of updating the entire database, as is currently done, you only need to update that part of the data that has changed.

### **6.2.1 Reducing Redundancy.**

Data will also be organized by 'scope', that is how broadly applicable it is: A) The entire session (for example, source position); B) A particular scan (EOP); C) A particular scan and station (met-data); D) or for a particular observation (delay observable and sigma). The current Mark3 database is observation oriented: all data required to process a given observation is stored once for each observation. This results in tremendous redundancy for some data. For example, in an N-station scan, there are  $N*(N-1)/2$  observations, and each station participates in  $N - 1$  observations. Scan dependent data, such as EOP or source information, is the same for all observations in a scan. However in Mark3 databases, this information is stored once for each observation, resulting in an  $N*(N-1)/2$  times redundancy. Station dependent data which is the same for all observations in a scan, such as pointing or met-data, is stored  $N-1$  once for each observation the station participates in the scan, resulting in an  $(N - 1)$ -fold redundancy. Organizing data by scope allows you to reduce redundancy.

### **6.3 NetCDF as Default Storage Format**

Working Group 4 reviewed a variety of data storage formats including NetCDF, HCDF, CDF, and FITS. In some sense, all of these formats are equivalent—there exist utilities to convert from one format to another. Ultimately we decided to use NetCDF, because it has a large user community since numerical weather models are stored in NetCDF files. Several members of the Working Group have experience using NetCDF. In addition, Thomas Hobiger [Hobiger 2008] wrote a program to store Mark3 databases in NetCDF format and developed analysis software that uses the NetCDF format [Hobiger 2010].

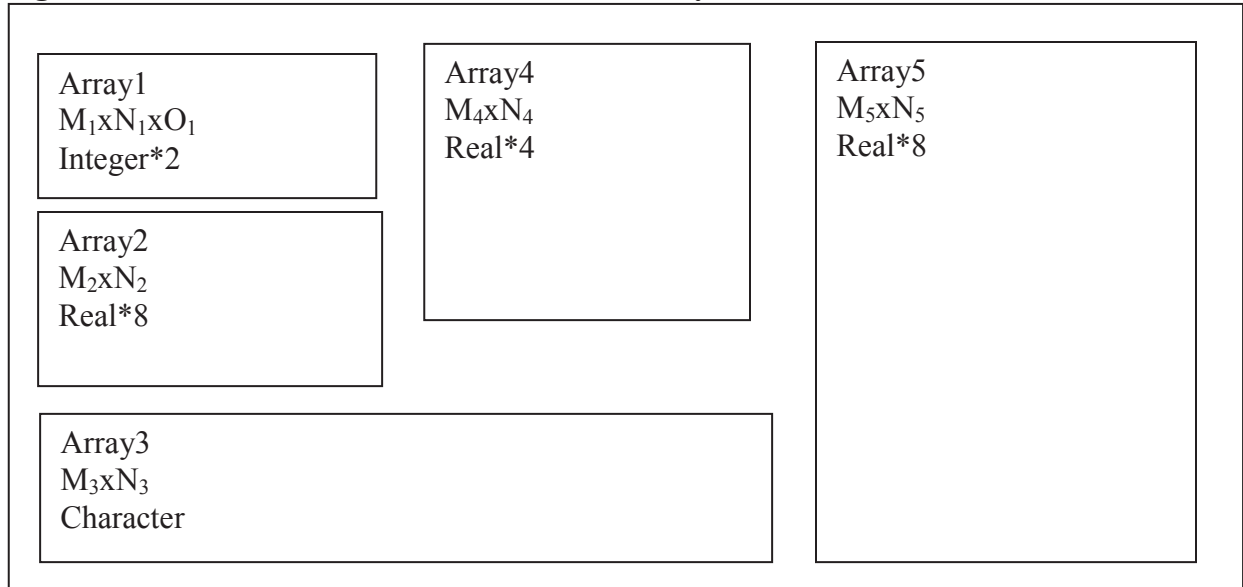
At its most abstract, NetCDF is a means of storing arrays in files. The arrays can be of different sizes and shapes, and contain different kinds of data—strings, integer, real, double, etc. Most VLBI data used in analysis is some kind of array. From this point of view using NetCDF is a natural choice. These files can contain history entries which aid in provenance. Storing data in NetCDF format has the following advantages:

1. Platform/OS/Language Support. NetCDF has interface libraries to all commonly used computer languages running on a variety of platforms and operating systems.
2. Speed. NetCDF is designed to access data fast.
3. Compactness. The data is stored in binary format, and the overhead is low. A NetCDF file is much smaller than an ASCII file storing the same information.
4. Open. NetCDF is an open standard, and software to read/write NetCDF files is freely available.



5. Transportability. NetCDF files use the same internal format regardless of the machine architecture. Access to the files is transparent. For example, the interface libraries take care of automatically converting from big-endian to little-endian.
6. Large User Community. Because of the large user community, there are many tools developed to work with NetCDF files.

**Figure 1. A NetCDF file is a container to hold arrays.**



### 6.3.1 NetCDF Attributes.

Another feature of NetCDF is the ability to easily store meta-data related to a variable. This meta data is called an ‘attribute’ arbitrary, and can be used to store information such as:

1. Units
2. Definition
3. Creation date of data.
4. Corresponding LCODE name if any.
5. Any other used-specified characteristic.

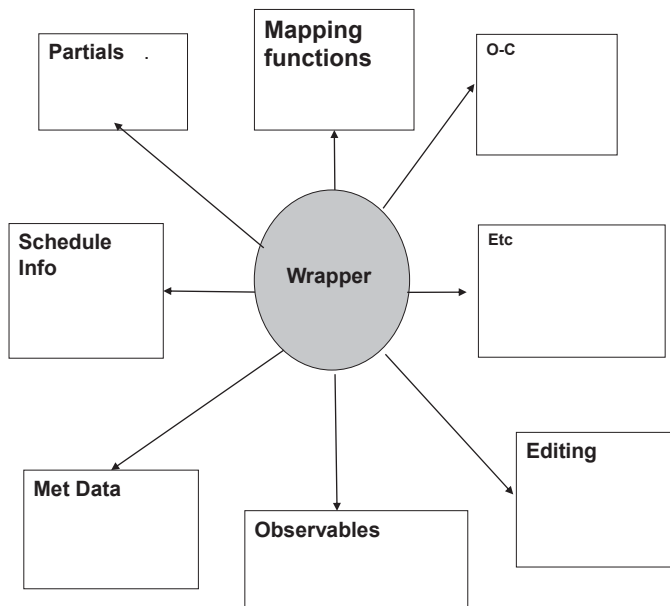
## 6.4 Organizing Data Within a Session Using Wrappers

In contrast to the current Mark3 databases where all (actually most) of the data required to analyze a data is one file, the new scheme proposes dividing the data up into smaller pieces. This allows updating the individual pieces separately and gives great flexibility in what is used. Because we split the data into smaller pieces, there must be another means of organizing the data. Wrappers solve this problem.

1. A wrapper is an ASCII file which contains
  - a. Information about the session
  - b. Pointers to files which contain the actual data

2. A wrapper file is distinguished by the extension “.wrp”.
3. Wrappers are never over written. Instead, as the results of analysis, or as needs change, a new wrapper is created.

## openDB Format



The wrapper is an ASCII file that contains pointers to other files in netCDF format that contain the data. Typically each of these other files contain a ‘few’ data items corresponding to different Lcodes.

Wrappers have many advantages, a few of which are mentioned below.

1. Ability to easily test different models by pointing to different netCDF files.
2. Ability to only update that part of the data which has changed.
3. Ability to try different editing criteria.

### 6.5 VgosDB Manual

The above is mentioned as an overview of the vgosDB format. It is not meant to completely define the format—instead it is meant to give the flavor of the format. A preliminary manual is available via anonymous ftp from:

[ftp://gemini.gsfc.nasa.gov/pub/misc/jmg/vgosDBv\\_v2013Jun11.pdf](ftp://gemini.gsfc.nasa.gov/pub/misc/jmg/vgosDBv_v2013Jun11.pdf)

The final version of the manual will be put on the IVS website when it is completed.

## 7 Feasibility Demonstrations

In August of 2009 John Gipson began a partial implementation of these ideas and wrote software to convert a subset of the data in a Mark3 database into the new format. This subset of data included all of the data available in NGS card format. The subset was chosen because many VLBI analysis packages including Occam, Steelbreeze, and *VieVS* use NGS cards as input. The GSFC VLBI group made available via anonymous FTP an Intensive, an R1 and a RDV session.

In the fall of 2010, Andrea Pany of the Technical University of Vienna developed an interface to *VieVS* working with the draft proposal. During this process the definition of a few of the data items needed to be clarified, which emphasizes the importance of working with the data hands on. With these changes *VieVS* was able to process data in the new format without problem.

At roughly the same time at NASA's Goddard Spaceflight center, Sergei Bolotin interfaced a variant of this format to *Steelbreeze*. *Steelbreeze* uses its own proprietary format, and one motivation for interfacing to the new format was to see if there was a performance penalty associated with using the new format. Bolotin found a small performance penalty of  $40\mu\text{s}$ / observation. Processing all 7 million then-available VLBI observations would result in a total performance penalty of 280 seconds, or 6 minutes 40 seconds. This seemed to be a relative modest price to pay for the many advantages of this format.

In late 2010 and early 2011 Gipson modified the VLBI analysis program *solve* to use a subset of the data stored in *vgosDB* format. This subset contained some observation dependent data such as the delay observable and pointing information. The remaining data was extracted from the *solve-superfiles*. (A superfile is a binary file containing a sub-set of all the data in the Mark3 database that is used in global solutions. Superfiles lack the flexibility of Mark3 databases, but data access is much faster.) This test had two distinct purposes. First, it was a demonstration of the feasibility of using *netCDF* files to store VLBI data. Second, it was a required first step in the conversion of *solve* to use the new format.

## 8 Conversion of Mark3 Database to VgosDB format

In 2011 and 2012 Gipson worked on a utility *db2openDB* to convert all of the data in all of Mark3 databases into the *openDB* format. As mentioned above, this format was subsequently renamed to *vgosDB*. (A modified version of this program called *db2vgosDB* is available as part of the *calc/solve* distribution.) As there approximately 500 different Lcodes this process took longer than anticipated. In addition many of the Mark3 databases, especially the older ones, had problems that needed to be fixed. A partial listing of some of the problems follows:

1. All of the Mark3 databases have an LCODE 'NUM OBS' that is supposed give the total number of observations in the database. However, several of the older databases actually had fewer observations than indicated, while a few had more.
2. Many of the Mark3 databases had duplicated data. There were two different Lcodes (a type-2 and a type-3 lcode) containing exactly the same data. In these cases the duplicate data was removed.

3. Many databases had bad or incorrect values for some of the data items. Each case had to be examined to determine how to handle the situation. In some cases the missing data could be inferred from data that was present in the database. In other cases the observation had to be flagged as bad.

In the spring of 2012 the conversion was essentially complete. All of the existing Mark3 databases were converted to openDB format and the results made accessible via anonymous ftp at: <ftp://gemini.gsfc.nasa.gov/pub/openDB>.

## **8.1 Conversion of Calc/Solve to Use vgosDB Format**

Historically the default storage format for geodetic VLBI sessions is Mark3 databases. This is the data format that the VLBI data is archived in, and the format that many IVS analysis centers use to process and store their results in. Other formats, such as NGS cards, or the custom format used by other analysis packages are all derived either directly or indirectly from the Mark3 databases. The software that produces edited and fully resolved Mark3 databases is the *Calc/Solve* analysis suite. Because of this, as part of the transition to the vgosDB format it is *necessary* to modify *Calc/Solve* to use the new format.

Figure 3 on the following pages lists the necessary processing steps before VLBI data is ready for use. We give a brief summary of each of the steps below. Depending on the VLBI analysis package the names of the programs involved may differ, but the steps remain the same.

1. The correlator takes the recorded data from the stations and produces correlator output files.
2. *dbedit* reads the correlator files, extracts the relevant information, and produces an initial Mark3 database. It actually produces both an X-band and S-band database.
3. *Calc* adds additional information to the X-band database. Some of this information, such as pointing information, is used by all analysis packages. Other information is specific to the solve.
4. Cable-cal and met-data is added to the X-band database by *dbcal*. The order of steps two and three can be reversed.
5. The data is read into *solve*. An analyst performs an initial solution where they resolve ambiguities and edit the data. The X-band database is written out and now includes a subset of the S-band data.

At this stage the Mark3 database is ready to be used in geodetic analysis. Many analysis packages use NGS-card format as input. (NGS cards contain a subset of the data in the Mark3 database in an ASCII file). Most analysis software, including *calc/solve*, convert the data into a proprietary binary format before using it. In the case of *calc/solve* this format is called ‘superfiles’.

In converting to the vgosDB format we need to develop software that reproduces all of the above steps. Since the Goddard VLBI group is the group that maintains *calc/solve*, this work was undertaken at Goddard.

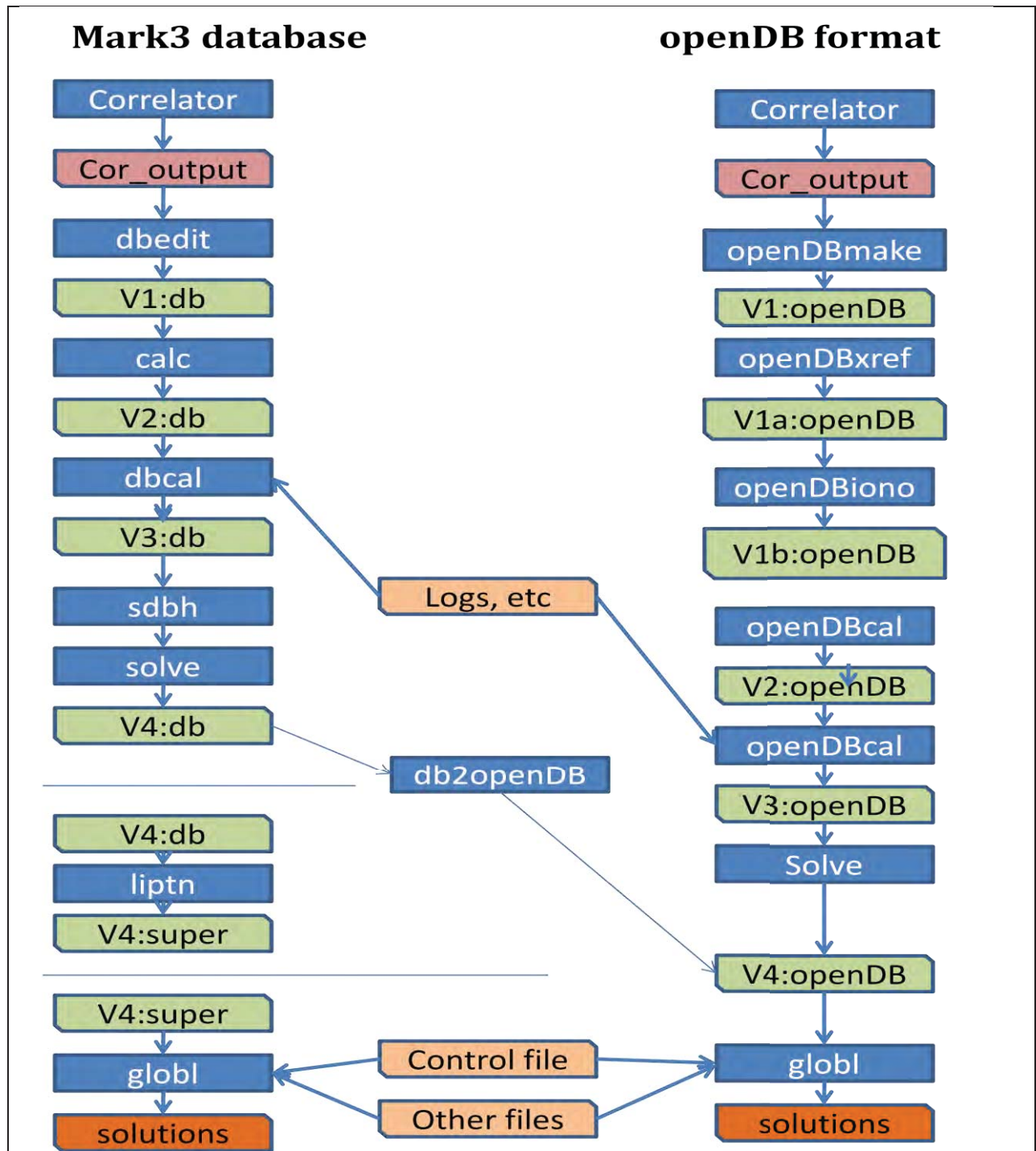


Figure 2. VLBI processing steps.

The approach was to start at the end of the processing chain and work backwards. The first step was to modify the *globl* mode of solve to use the vgosDB format instead of superfiles. The utility *db2vgosDB* read in edited and fully resolved Mark3 databases and produced vgosDB format sessions. Conversion of *globl* to use vgosDB sessions was completed in the summer of 2012. Timing tests showed that smaller sessions such as intensives run somewhat slower using the vgosDB format. In contrast larger sessions such as the RDV sessions or CONT11 sessions run up to 40% faster. A solution using all of the VLBI runs slightly faster using the vgosDB format.

The remaining programs displayed on the right-hand-side of Figure 2 were developed at Goddard during late 2012 and early 2013. Several sessions including an R1s, RDVs and intensives were processed completely, starting from correlator output and ending in fully resolved vgosDB sessions. The results were consistent with or identical with the normal processing using Mark3 databases. (In the process of developing this software the Goddard VLBI group found and fixed some bugs in the normal processing chain.)

The process of developing the processing software was very useful and lead to some refinements in the vgosDB specification. One example of this involves changing which NetCDF files contain some particular data items. For example, in the first implementation of the vgosDB format, both the Names and Positions of stations were stored in the file ‘Head.nc’ which contains general information about the session. This worked satisfactorily when we were starting with a version 4 a fully resolved Mark3 database which contains all of this information. However if we are creating the vgosDB session by scratch the station position information is not available until after the data has been *calc*-ed. Because of this it is logical to remove the station position (and source position) information from Head.nc and store it separately. Other examples include renaming vgosDB variables and filenames to make them more consistent.

## 9 Next Steps

In this section we describe next steps in the implementation and decimation of the vgosDB format to the IVS community.

The ‘development’ version of the *Calc/Solve* analysis suite at Goddard has the ability to use either superfiles or vgosDB files in global solutions. In addition, *vSolve*, the replacement for interactive solve, can read and write vgosDB files. These capabilities will be made widely available with the next general release of *Calc/Solve* scheduled for fall 2013.

Beginning in 2014, the Goddard VLBI group will take on responsibility for producing vgosDB versions of all VLBI sessions available to IVS. This includes sessions for which Goddard has primary responsibility (e.g., R1s and RDVs) and also sessions for which other analysis centers have primary responsibility. This will be done by using the utility *db2vgosDB* to convert fully edited and resolved Mark3 databases to vgosDB format. As the year progresses and as other *Calc/Solve* analysis centers (which are responsible for producing the Mark3 databases) get familiar with the handling and producing vgosDB sessions Goddard will reduce the number of vgosDB sessions it produces. For at least 1-year both Mark3 databases and vgosDB sessions will be available on the IVS website.

The VLBI analysis software suite VieVs, developed at the Technical University of Vienna, can use vgosDB sessions in its analysis. This capability will be maintained and enhanced as time permits. For example, currently VieVs must start with a fully resolved Mark3 database. As time permits this capability will be added to VieVs and it will use the vgosDB format to store the related information.

It is hoped that other software packages such as Occam, C5++ are modified to read and write vgosDB format. This will allow the easy exchange of information among these software packages.

## 10 References

1. Petrov, L. "Specifications of a proposed geo-VLBI dataformat", <http://gemini.gsfc.nasa.gov/development/gvf/gvf.html>. Undated memo
2. Abdekar, K., Gontier, A-M, "The Gloria VLBI tables", [http:](http://)
3. Gontier, A-M. and Feissel, M., "PIVEX: a Proposal for a Platform Independent VLBI Exchange Format", The 2<sup>nd</sup> IVS General Meeting Proceedings, 2002 p. 248-254.
4. Gipson, J., "IVS Working Group 4 on VLBI Data Structures", The 5<sup>th</sup> IVS General Meeting Proceedings, 2008 p. 143-152
5. Hobiger, et al, "MK3TOOLS – Seamless Interfaces for the Creation of VLBI Databases from Post-Correlation Output", The 5<sup>th</sup> IVS General Meeting Proceedings, 2008 p. 143-153-156.
6. Gipson, J., "IVS Working Group 4 on VLBI Data Structures", The 6<sup>th</sup> IVS General Meeting Proceedings, 2010 p. 187-191
7. Hobiger, et al., "C5++ - Multi-technique Analysis Software for Next Generation Geodetic Instruments", The 6<sup>th</sup> IVS General Meeting Proceedings, 2010 p. 212-216.
8. Gipson, J., Report on IVS-WG4, 20<sup>th</sup> EVGA Meeting, p 142-146.
9. Gipson, J., IVS Working Group 4 on VLBI Data Structures, The 7<sup>th</sup> IVS General Meeting Proceedings, 2012 p. 212-221.
10. Gipson, J. IVS Working Group 4 on VLBI Data Structures,
11. Draft openDB Manual version 2013Jun11:  
[ftp://gemini.gsfc.nasa.gov/pub/misc/jmg/openDBv\\_v2013Jun11.pdf](ftp://gemini.gsfc.nasa.gov/pub/misc/jmg/openDBv_v2013Jun11.pdf)

# IVS WG 6

## Final report

Rüdiger Haas

September 2013

### **Introduction**

The IVS Directing Board established on its meeting in March 2009 in Bordeaux a working group on Education and Training. This working group is IVS WG6 and its work was to be reviewed regularly by the IVS DB at its meeting. The general aim of IVS WG6 is to support education and training in the field of geodetic and astrometric VLBI, in order to hand over and maintain expertise in this field for the next generations.

The Terms of Reference (ToR) of IVS WG6 were:

to establish contacts to education institutions in geodesy, geosciences and astrometry worldwide with the aim to raise interest in geodetic and astrometric VLBI among students

to develop education material that can be distributed to education institutions

to seek funding and to develop a concept and prepare the organization of training in form of for example IVS summer schools for master and PhD students

The WG was chaired by Rüdiger Haas: other initial members were Oleg Titov, Hayo Hase, Bjørn Engen, Johannes Böhm, Dirk Behrend, and Alan Whitney. Further candidate members were to be asked later to support the group.



## ToR-1

The task was to establish contacts to education institutions in geodesy, geosciences and astrometry worldwide with the aim to raise interest in geodetic and astrometric VLBI among students. For this purpose several experts were asked to take care of the different continents:

### Continent

North America  
South America  
Europe  
Asia  
Australia and Oceania  
Africa

### Responsible team

Alan Whitney and Dirk Behrend  
Hayo Hase and Alan Whitney  
Rüdiger Haas and Johannes Böhm  
Dirk Behrend and Oleg Titov  
Oleg Titov and Bjørn Engen  
Lucia Plank and Rüdiger Haas

The responsible teams collected information on educational institutes that provide student education in geodesy, geosciences and astrometry. Unfortunately is the distribution of such institutions not equal for all continents. For some of the continents only a few contact addresses could be collected so far. There is more work to be done to collect potential contacts. Below we give a list of so far collected contacts addresses.

## a) NORTH AMERICA:

### Canada

- York University, Earth and Space Science Engineering, Spiros Pagiatakis, spiros (at) yorku.ca
- University of Calgary, Department of Geomatics Engineering, Prof. Michael G. Sideris, sideris (at) ucalgary.ca

### México

- Universidad Autonoma de México, Departamento de Geodesia y Cartografía, Ing. Bartolo Lara Andrade, larandraba (at) gmail.com
- Instituto Politécnico Nacional, Unidad Ticomán Ciencias de la Tierra (ESIA), Ing. Julio Morales de la Garza, jmoralesd (at) ipn.mx

### USA

- University of Colorado, Prof. Kristine Larson, kristinem.larson (at) gmail.com
- University of Nevada, Prof. Jeff Blewitt, gblewitt (at) unr.edu
- Lamont-Doherty Earth Observatory, Prof. James Davis, jdavis (at) ldeo.columbia.edu
- Ohio State University, Prof. Michael Bevis, mbevis (at) osu.edu

## b) SOUTH AMERICA:

### Argentina

- Universidad Nacional de La Plata – UNLP, Carrera de Ingeniería en Agrimensura, Dr. Ing. Marcos Actis, depagrim (at) ing.unlp.edu.ar
- Universidad Nacional de La Plata – UNLP, Carrera de Geofísica, Decano Dr. Adrián Brunini,

agrimen (at) fi.uba.ar

– Universidad Nacional de Buenos Aires – UNBA, Carrera de Ingeniería en Agrimensura, Dr. Ing. Carlos Rosito, agrimen (at) fi.uba.ar

– Universidad Nacional de Tucumán – UNT, Carrera de Ingeniería Geodésica y Geofísica, Decano Ing. Sergio José Pagani, Dr. José Luis Vacafior, jvacafior (at) herrera.unt.edu.ar

– Universidad Nacional de Córdoba – UNC, Carrera de Ingeniería en Agrimensura, Decano Hector Gabriel Tavella, Ing. Susana Talquenca, comunicaciones (at) efn.uncor.edu

– Universidad Santiago del Estero, Carrera de Ingeniería en Agrimensura, Decano Héctor Rúben Paz, info-fce (at) unse.edu.ar

– Universidad Nacional del Sur – UNS, Carrera de Ingeniería en Agrimensura, Decano Carlos Rossit, dtoinge (at) criba.edu.ar

– Universidad Nacional de Catamarca – UNCA, Carrera de Ingeniería en Agrimensura, Rector Ing. Flavio Fama

– Universidad de Morón, Carrera de Ingeniería en Agrimensura, Rector Héctor Norberto Porto Lemma, ingenieria (at) unimoron.edu.ar

– Universidad Nacional Juan Maza, Carrera de Ingeniería en Agrimensura, Decano Vicente Gonzalo Cremades, gorelo (at) umaza.edu.ar

– Universidad Nacional del Litoral – UNL, Carrera de Ingeniería en Agrimensura, Decano Ing. Mario Schreider, fich (at) fich.unl.edu.ar

– Universidad Nacional del Nordeste – UNNE, Carrera de Ingeniería en Agrimensura, Decana Dra. Lidia Itatí Ferraro de Corona, estudios (at) exa.unne.edu.ar sae (at) exa.unne.edu.ar

– Universidad Nacional del Nordeste – UNNE, Carrera de Ingeniería Civil, Decano Dr. Jorge Victor Pilar, info (at) ing.unne.edu.ar

– Universidad Nacional de Rosario – UNR, Carrera de Ingeniería en Agrimensura, Decano Ing. Elect. Oscar Enrique Peire, secdec@fceia.unr.edu.ar many (at) fceia.unr.edu.ar

## **Brazil**

– UNESP - Universidade Estadual Paulista Júlio de Mesquita Filho, Departamento de Cartografia, Dr. João Carlos Chaves, jchaves (at) fct.unesp.br

– USP - Universidade de São Paulo, Departamento de Engenharia de Transportes, Dr. Edvaldo Simões da Fonseca Junior, edvaldoj (at) usp.br

– UFRGS - Universidade Federal do Rio Grande do Sul, Departamento de Geodésia, Dra. Andrea Lopes Iescheck, andrea.iescheck (at) ufrgs.br

– UFPE - Universidade Federal de Pernambuco, Departamento de Engenharia Cartográfica, Dr. Carlos A. Pessoa M. Galdino, galdino (at) ufpe.br

– IME - Instituto Militar de Engenharia, Seção de Ensino de Engenharia Cartográfica, Dr. Leonardo Castro de Oliveira, se6\_chefia (at) ime.eb.br

– UERJ - Universidade do Estado do Rio de Janeiro, Departamento de Engenharia Cartográfica, Dr. Amauri Ribeiro Destri, destri (at) uol.com.br

– INPE - Instituto Nacional de Pesquisas Espaciais, Serviço de Pós-Graduação, Jose Carlos Becceneri, becce@lac.inpe.br posgraduacao (at) pgrad.inpe.br

– ON – Observatório Nacional, Geofísica, Dr. Sergio Luiz Fontes, sergio (at) on.br

– UFPR - Universidade Federal do Paraná, Engenharia Cartográfica e de Agrimensura, Dr. Luís Augusto Koenig Veiga, kngveiga (at) ufpr.br

## **Chile**

– ACAPOMIL – Academia Politécnica Militar, Jefatura de Estudios, Teniente Coronel Neira,

geografía (at) acapomil.mil

– Universidad de Concepción, Ingeniería Geomática, Dr. Juan Carlos Báez Soto, jbaez (at) udec.cl

– Universidad de Santiago de Chile, Ingeniería en Geomensura, Dr. Belfor Portal Valenzuela, belfor.portal (at) usach.cl

– Universidad Técnica Metropolitana, Escuela de Geomensura, Luis del Canto Harboe, geomensura (at) utem.cl

– Universidad de Antofagasta, Ingeniería en Geomensura, Luis Fernández San Martín, uovando (at) uantof.cl

– Universidad Bernardo O'Higgins, Ingeniería en Geomensura y Cartografía, Sr. Abel Fuentes, geomensura (at) ubo.cl

– Universidad de Talca, Geomática, Yony Ormazábal, yormazabal (at) utalca.cl

– INACAP Maipú, Ingeniería en Geomensura, Sr. René Martínez Muñoz, maipu (at) incap.cl

### **Colombia**

– Universidad Distrital Francisco José de Caldas, Ingeniería Catastral y Geodesia, Coordinador - Ingeniería Catastral y Geodesia, ingcatastral (at) udistrital.edu.co

### **Costa Rica**

– Universidad Nacional, Escuela de Topografía Catastro y Geodesia, Steven Oreamuno Herra, soreamun (at) una.ac.cr

### **Ecuador**

– Escuela Politecnica del Ejercito, Carrera de Ingeniería Geográfica y Medio Ambiente, Dr Alfonso Tierra, fleon (at) espe.edu.ec

– Instituto Geográfico Militar, Proceso de Geodesia, Capitan Nicolay Vaca, nicolay.vaca (at) mail.igm.gob.ec

### **Honduras**

--

### **Panamá**

– Universidad Tecnológica de Panamá, Escuela de Geotecnia Ingeniería en Geomática, Chun Quan Huang Lin, chun.huang (at) utp.ac.pa

### **Venezuela**

– Universidad de Zulia, Departamento de Geodesia Superior, Escuela de Ingeniería Geodésica, Prof. Dr.-Ing. Eugen Wildermann, Prof. Msc-Ing. Karina Acurero, ewildermann (at) fing.luz.edu.ve kacurero (at) fing.luz.edu.ve

## **c) EUROPE:**

### **Albania**

– Tirana University, Department of Geography, Prof. Dr. Pal Nikolli, palnikolli (at) yahoo.com

### **Andorra**

--

## **Austria**

- TU Graz, Institute of Theoretical Geodesy and Satellite Geodesy, Prof. Dr. Torsten Mayer-Gürr: mayer-guerr (at) tugraz.at
- TU Wien, Institute of Geodesy and Geophysics, Prof. Dr. Johannes Böhm: johannes.boehm (at) tuwien.ac.at

## **Belarus**

--

## **Belgium**

- Royal Observatory of Belgium, Prof. Veronique Dehant, v.dehant (at) oma.be

## **Bosnia and Herzegovina**

--

## **Bulgaria**

- University of Architecture, Civil Engineering and Geodesy, Department of Geodesy, Prof. Georgi Mitrev, gmitrev\_fgs (at) uacg.bg

## **Croatia**

- University of Zagreb, Faculty of Geodesy, Institute of Geomatics, Prof. Zeljko Bacic, zbacic (at) geof.hr

## **Cyprus**

--

## **Czech Republic**

- Research Institute of Geodesy Topography and Cartography, Department of Geodesy and Geodynamics, Prof. Dr. Jakub Kostelecky, kakub.kostelecky (at) pecny.cz
- Czech Technical University in Prague, Department of Advanced Geodesy, Prof. Dr.Ing. Leoš Mervart, k152 (at) fsv.cvut.cz
- Brno University of Technology, Institute of Geodesy, Prof. Otakar Svabensky, svabensky.o (at) fce.vutbr.cz
- VSB – Technical University of Ostrava, Faculty of Mining and Geology, Institute of Geoinformatics, Prof. Dr. Zdenek Divis, zdenek.divis (at) vsb.cz
- Charles University in Prague, Faculty of Mathematics and Physics, Department of Geophysics, Prof. Zdenek Martinec, zdenek (at) hervam.troja.mff.cuni.cz

## **Denmark**

- Aalborg University (AAU), Kai Borre, borre (at) es.aau.dk
- Technical University of Denmark (DTU), Niels Andersen, na (at) space.dtu.dk
- Technical University of Denmark (DTU), Per Knudsen, pk (at) space.dtu.dk

## **Estonia**

- University of Tartu,
- University of Tallinn, Artu Ellman, Harli Jurgensen

## **Finland**

- Aalto University, Martin Vermeer, martin.vermeer (at) aalto.fi
- Finnish Geodetic Institute (FGI), Markku Poutanen, martin.poutanen (at) fgi.fi

## **France**

--

## **Georgia**

--

## **Germany**

- Bonn University, PD Axel Nothnagel, nothnagel (at) uni-bonn.de
- TU München, Prof. Hugentobler, urs.hugentobler (at) bv.tum.de
- Karlsruhe Institute of Technology, Prof. Heck, bernhard.heck (at) kit.edu
- Stuttgart University, Prof. Nico Sneuw
- Leibniz University Hannover, Prof. Jürgen Müller, mueller (at) ife.uni-hannover.de

## **Greece**

--

## **Hungary**

--

## **Iceland**

--

## **Ireland**

--

## **Italy**

--

## **Kazakhstan**

--

## **Latvia**

- Univerity of Latvia, Prof. Janis Kaminski, janis.kaminski (at) gmail.com

## **Liechtenstein**

--

## **Lithuania**

--

## **Luxembourg**

- University of Luxembourg, Prof. Olivier Francis, olivier.francis (at) uni.lu
- University of Luxembourg, Prof. Felix Norman Teferle, norman.teferle (at) uni.lu
- University of Luxembourg, Prof. Tonie van Dam, tonie.vandam (at) uni.lu

## **Republic of Macedonia**

- State University of Tetova, Faculty of Natural Sciences and Mathematics, Prof. Dr. Bashkim Idrizi, bashkim.idrizi (at) unite.edu.mk

**Malta, Moldova, Monaco, Montenegro**

--

**Netherlands**

– Delft University of Technology, Prof. Ambrosius, b.a.c.ambrosius (at) tudelft.nl

**Norway**

– University Ås, Geomatics, Bjørn Rangvald Pettersson  
– University Ås, Oddgeir Kristiansen

**Poland**

– Polish Academy of Sciences, Space Research Centre, Prof. Dr. Aleksander Brzezinski, alek (at) cbk.waw.pl

**Portugal**

--

**Romania**

--

**Russia**

– St.Petersburg University, St Petersburg, Prof. Veniamin Vityazev

**San Marino, Serbia, Slovakia, Slovenia**

--

**Spain**

--

**Sweden**

– Royal Institute, Stockholm, Prof. Lars Sjöberg  
– Högskolan i Gävle, Stieg-Göran Mårtensson

**Switzerland**

– ETH Zürich, Prof. Markus Rothacher,  
– University Bern, Rolf Dach

**Turkey**

--

**Ukraine**

--

**United Kingdom**

– University of Nottingham, Prof. Terry Moore  
– Newcastle University, Prof. Matt King, m.a.king (at) ncl.ac.uk

**Vatican City**

--

**d) ASIA:**

**Afghanistan**

--

**Armenia**

--

**Azerbaijan**

--

**Bahrain**

--

**Bangladesh**

--

**Bhutan**

--

**Brunei**

--

**Burma (Myanmar)**

--

**Cambodia**

--

**China**

– Wuhan University, Prof. Erhu Wei, ehwei (at) sgg.whu.edu.cn

**Hong Kong**

--

**India**

--

**Indonesia**

--

**Iran**

--

**Iraq**

--

**Israel**

--

**Japan**

– Sapporo University, Prof. Kosuke Heki

**Jordan**

--

**Kazakhstan**

--

**Korea, North**

--

**Korea, South**

--

**Kuwait**

--

**Kyrgyzstan**

--

**Laos**

--

**Lebanon**

--

**Malaysia**

--

**Maldives**

--

**Mongolia**

--

**Myanmar**

--

**Nepal**

--

**Oman**

--



**Pakistan**

--

**Philippines**

--

**Qatar**

--

**Saudi Arabia**

--

**Singapore**

--

**Sri Lanka**

--

**Syria**

--

**Taiwan**

--

**Tajikistan**

--

**Thailand**

--

**Turkey**

--

**Turkmenistan**

--

**United Arab Emirates**

--

**Uzbekistan**

--

**Vietnam**

--

**Yemen**

--

**e) Australia and Oceania**

**Australia**

--

**Fiji**

--

**Kiribati**

--

**Marshall Islands**

--

**Micronesia**

--

**Nauru**

--

**New Zealand**

--

**Palau**

--

**Papua New Guinea**

--

**Samoa**

--

**Solomon Islands**

--

**Tonga**

--

**Tuvalu**

--

**Vanuatu**

--

**f) Africa**

**Algeria**

--

**Angola**

--

**Benin**

--

**Botswana**

--

**Burkina Faso**

--

**Burundi**

--

**Cameroon**

--

**Cape Verde**

--

**Central African Republic**

--

**Chad**

--

**Comoros**

--

**Congo-Brazzaville**

--

**Congo-Kinshasa**

--

**Cote d'Ivoire**

--

**Djibouti**

--

**Egypt**

--

**Equatorial Guinea**

--

**Eritrea**

--

**Ethiopia**

--

**Gabon**

--

**Gambia**

--

**Ghana**

--

**Guinea**

--

**Guinea Bissau**

--

**Kenya**

--

**Lesotho**

--

**Liberia**

--

**Libya**

--

**Madagascar**

--

**Malawi**

--

**Mali**

--

**Mauritania**

--

**Mauritius**

--

**Morocco**

--

**Mozambique**

--

**Namibia**

--

**Niger**

--

**Nigeria**

--

**Rwanda**

--

**Senegal**

--

**Seychelles**

--

**Sierra Leone**

--

**Somalia**

--

**South Africa**

– Hartebeesthoek Radio Astronomical Observatory, Prof. Ludwig Combrinck, ludwig (at) hartrao.ac.za

**South Sudan**

--

**Sudan**

--

**Swaziland**

--

**São Tomé and Príncipe**

--

**Tanzania**

--

**Togo**

--

**Tunisia**

--

**Uganda**

--

**Western Sahara**

--

**Zambia**

--

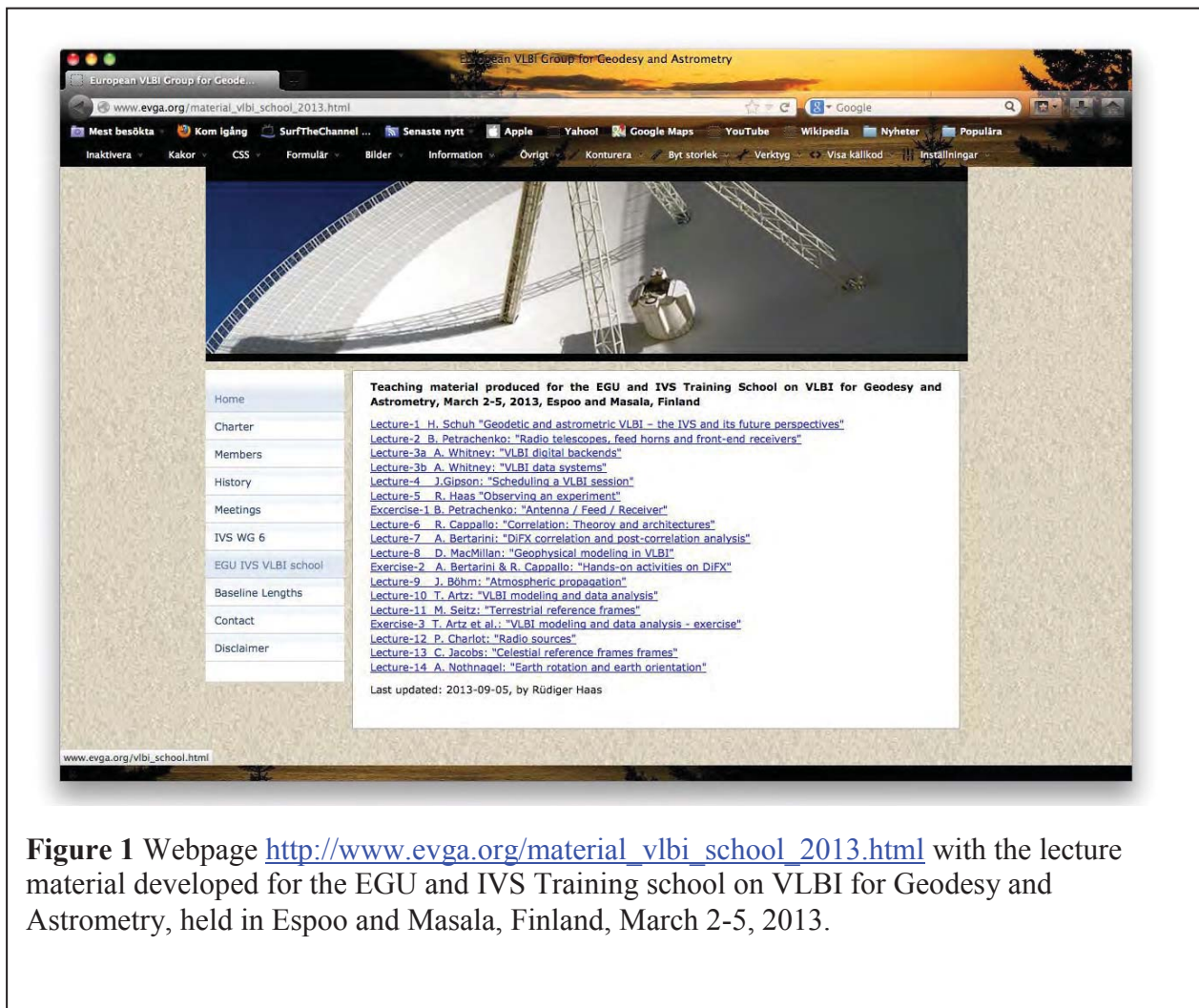
**Zimbabwe**

## ToR-2

The task was to develop education material that can be distributed to education institutions.

The WG decided to start by collecting existing educational material. Material provided by Johannes Böhm and Harald Schuh from the Vienna Technical University, Austria, Chris Jacobs from the Jet Propulsion Laboratory, USA, and Rüdiger Haas from Chalmers University of Technology, Sweden. The material consists of pdf-files and is available at <http://www.evga.org/edumaterial.html>

As a next step, the plan was to collect and compile the material presented at the IVS VLBI school. This material consists of 14 lectures and 3 exercises and is available at [http://www.evga.org/material\\_vlbi\\_school\\_2013.html](http://www.evga.org/material_vlbi_school_2013.html), see Figure 1 below.



**Figure 1** Webpage [http://www.evga.org/material\\_vlbi\\_school\\_2013.html](http://www.evga.org/material_vlbi_school_2013.html) with the lecture material developed for the EGU and IVS Training school on VLBI for Geodesy and Astrometry, held in Espoo and Masala, Finland, March 2-5, 2013.

### ToR-3

The task was to seek funding and to develop a concept and prepare the organization of training in form of for example IVS summer schools for master and PhD students.

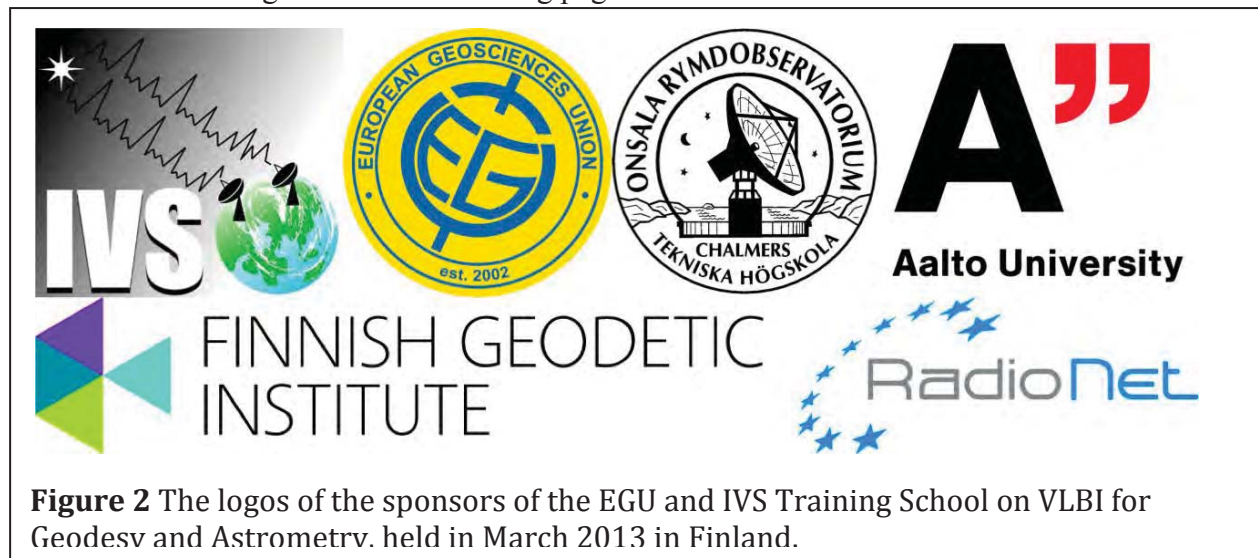
Several attempts were done to apply for funding for a VLBI-school:

The first attempt was directed in the spring of 2011 towards NordForsk. NordForsk is an organisation under the Nordic Council of Ministers that provides funding for Nordic research cooperation as well as advice and input on Nordic research policy. We sent in an application to NordForsk's call for "Research Training Courses 2011" and applied for about 230 kNOK funding of a VLBI-school that was planned for the summer of 2011. For this call, NordForsk received in total 52 applications, out of which 20 were funded. Unfortunately, our application did not get any support.

The second attempt was an application to the "Training of Radio Astronomers" program of RadioNet. RadioNet is a project supported by the European Commission under the 7th Framework Programme (FP7). A support by RadioNet on the order of up to 2 k€ was granted for the organisation of a VLBI-school.

The third attempt was an application to the European Geosciences Union (EGU) in the fall of 2011. We submitted a proposal for a VLBI-school to the "Topical Meetings and Training Schools for 2012" program of the EGU outreach committee. We applied for a total budget of 23.5 k€ to organise a VLBI-school in the late summer of 2012 at Onsala. In November 2011 the EGU informed us that they would support the VLBI-school by 5 k€.

Since we so far had only 7k€ support from RadioNet and EGU, we decided to organise the VLBI-school not as a stand-alone occasion, but in connection to another VLBI-related meeting. We anticipated that this would make it easier for teachers and students to participate. We chose the EVGA meeting in March 2013 in Finland and EGU agreed to move the VLBI-school to 2013. We also discussed further support for the VLBI-school with the Aalto University in Espoo, the Finnish Geodetic Institute in Masala, and the Onsala Space Observatory. These three institutions granted additional support in terms of access to lecture halls, bus transport, coffee breaks, lunches, and a school dinner. The logos of the sponsors of the VLBI-school are presented in Figure 2. IVS supported the VLBI-school though teachers that are members of IVS. A report on the VLBI-school is given on the following pages.



**Figure 2** The logos of the sponsors of the EGU and IVS Training School on VLBI for Geodesy and Astrometry, held in March 2013 in Finland.



Report on the

# **EGU and IVS Training School on VLBI for Geodesy and Astrometry**

**Held 2013, March 2-5, at Aalto University, Espoo (Finland) and the Finnish  
Geodetic Institute, Masala (Finland)**

Rüdiger Haas, Markku Poutanen, Minttu Uunila, 2013-04-22

## **A) GENERAL INFORMATION**

The “EGU and IVS Training School on VLBI for Geodesy and Astrometry” was held March 2-5, 2013, in Finland. It was organized by Rüdiger Haas, head of IVS Working Group 6 on VLBI Education, in collaboration with Markku Poutanen, head of the geodesy division at the Finnish Geodetic Institute (FGI), and Minttu Uunila from Aalto University, Metsähovi Radio Observatory, Finland. The main goal of the VLBI school was to educate and provide training for the next generation VLBI researchers that will work with the next generation VLBI system for Geodesy and Astrometry. For that purpose, four days of lectures and exercises were arranged, with the intention to cover the VLBI system for Geodesy and Astrometry as complete as possible.

The lectures covered technical aspects, scheduling and observations, details of the correlation process, modeling and data analysis, and interpretation of the results. There were in total 14 lectures and 3 hands-on exercises. Some impressions on the activities during the VLBI-school are shown in Figures 3-6. The final session of the VLBI-school was held together with the 14<sup>th</sup> IVS Analysis Workshop.

The teachers that were giving lectures at the VLBI school are international experts in their fields and come from several research institutions worldwide:

- Thomas Artz (University of Bonn, Germany)
- Alessandra Bertarini (Max Planck Institute for Radioastronomy, Germany)
- Johannes Böhm (Vienna Technical University, Austria)
- Roger Cappallo (MIT Haystack Observatory, USA)
- Patrick Charlot (Bordeaux Observatory, France)
- John Gipson (NASA, NVI Inc., USA)
- Rüdiger Haas (Chalmers University of Technology, Sweden)
- Chris Jacobs (JPL, NASA, USA)
- Dan MacMillan (NASA, NVI Inc., USA)
- Axel Nothnagel (University of Bonn, Germany)
- Bill Petrachenko (National Resources Canada, Canada)
- Harald Schuh (GeoForschungsZentrum Potsdam, Germany)
- Manuela Seitz (DGFI, Germany)
- Alan Whitney (MIT Haystack Observatory, USA)

There were more than 60 applications for participation in the VLBI school, from interested students worldwide, including all continents. Finally, more than 50 students really could attend the VLBI-school, see the list of participants in Section 3. More than 50 % of the participants are active in educational programs on master's or PhD level, while the rest were more senior researchers. More than 35 % of the participants were female. The lecture slides are available via the webpages of the European VLBI Group for Geodesy and Astrometry (EVGA, [www.evga.org/material\\_vlbi\\_school\\_2013.html](http://www.evga.org/material_vlbi_school_2013.html)).

The VLBI-school received some financial support from the European Geosciences Union (EGU) that was entirely used to support parts of the travel expenses of the master's and PhD students. The Onsala Space Observatory provided support for food in terms of coffee breaks and lunches during the VLBI-school. Aalto University provided the lecture room on Saturday, Monday and Tuesday, while the Finnish Geodetic Institute provided the lecture room on Sunday and some food. A small number of master's and PhD students sent in claims to RadioNet3 and were refunded for additional travel expenses.



**Figure 3:** Students listening to a lecture during the VLBI-school in the lecture hall at Aalto University, Espoo.



**Figure 4:** Alessandra Bertarini giving a lecture for the VLBI-school at the Finnish Geodetic Institute, Masala.



**Figure 5:** Roger Cappallo (right) advising a student group during Exercise-2 on software correlation.



**Figure 6:** Axel Nothnagel (left) supervising a student group during Exercise-3 on data analysis.

## **B) THE PROGRAM OF THE TRAINING SCHOOL**

### **Day-1 (Saturday, 2013-03-02, @ Aalto University, Espoo)**

09:00-09:15 Welcome and practical information (R. Haas, M. Poutanen)  
09:15-10:00 "General overview on geodetic and astrometric VLBI and the IVS" (H. Schuh)  
10:00-10:30 --- coffee break ---  
10:30-12:00 "Radio telescopes, feed horns and receivers" (B. Petrachenko)  
12:00-13:00 --- lunch break ---  
13:00-14:30 "Digital backends and data acquisition" (A. Whitney)  
14:30-15:00 --- coffee break ---  
15:00-16:30 "Experiment scheduling" (J. Gipson)  
16:30-17:15 "Observing an experiment" (R. Haas)  
17:15-18:00 Exercise-1 (theoretical calculations, B. Petrachenko)

### **Day-2 (Sunday, 2013-03-03, @ FGI, Masala)**

08:30-09:00 bus leaves from Helsinki downtown to Radisson blu Otaniemi Espoo  
09:00-09:30 bus leaves from Radiosson blu Otaniemi Espoo to FGI Masala  
09:30-11:00 "Correlator Architectures and VLB2010" (R. Cappallo)  
11:00-11:30 --- coffee break ---  
11:30-13:00 "Correlation preparation and post-correlation analysis" (A. Bertarini)  
13:00-14:00 --- lunch break ---  
14:00-15:30 "Geophysical models" (D. MacMillan)  
15:30-16:00 --- coffee break ---  
16:00-17:30 Exercise-2 (software correlation) (A. Bertarini & R. Cappallo)  
17:30-20:00 "VLBI-school dinner"  
20:00-21:00 bus transport back to Radiosson blu Otaniemi Espoo & Helsinki downtown

### **Day-3 (Monday, 2013-03-04, @ Aalto University, Espoo)**

09:00-10:30 "Atmospheric propagation" (J. Böhm)  
10:30-11:00 --- coffee break ---  
11:00-12:30 "Data modeling and analysis" (Th. Artz)  
12:30-13:30 --- lunch break ---  
13:30-15:00 "Terrestrial reference frame" (R. Haas on behalf of M. Seitz)  
15:00-15:30 --- coffee break ---  
15:30-17:00 Exercise-3 (data analysis) (Th. Artz et al.)

### **Day-4 (Tuesday, 2013-03-05, @ Aalto University , Espoo)**

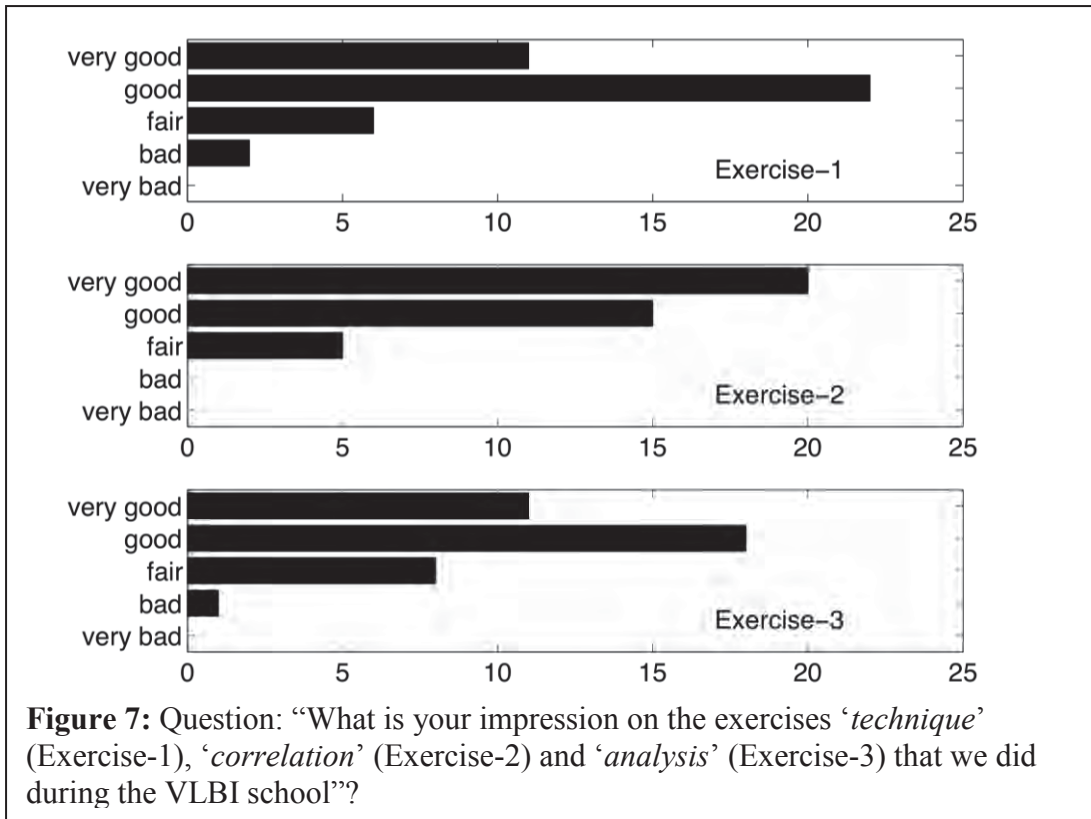
09:00-10:30 "Radio sources" (P. Charlot)  
10:30-11:00 --- coffee break ---  
11:00-12:30 "Celestial Reference Frames" (Ch. Jacobs)  
12:30-13:30 --- lunch break ---  
13:30-15:00 "Earth rotation and orientation" (A. Nothnagel)  
15:00-15:30 --- coffee break ---  
15:30-18:00 14th IVS Analysis Workshop (A. Nothnagel et al.)

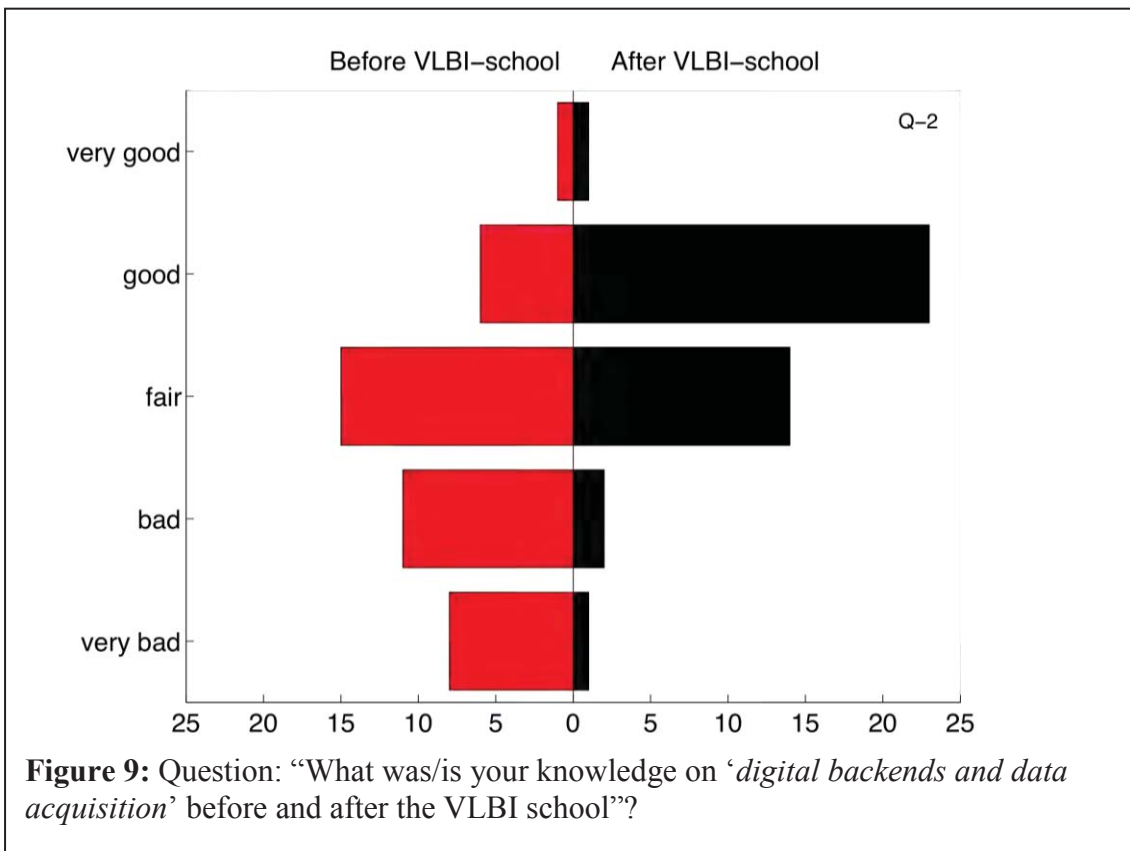
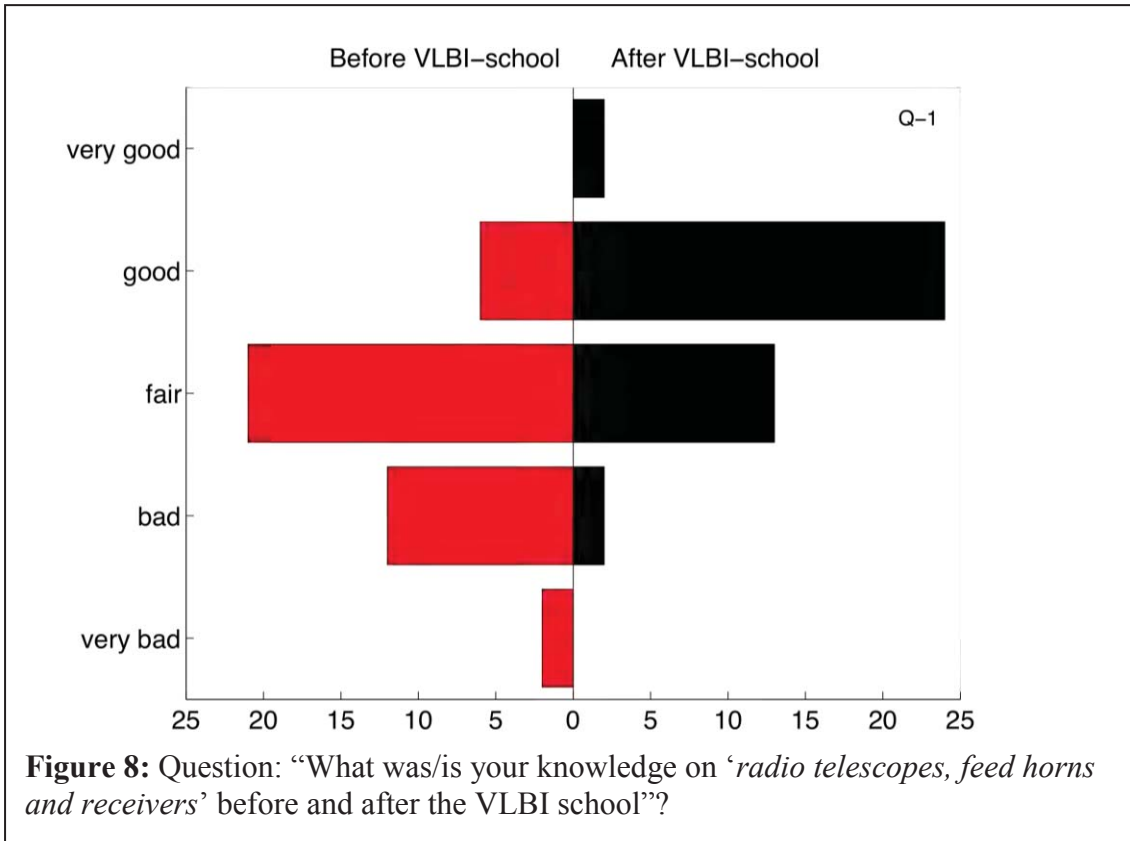
### C) DISCUSSION AND EVALUATION OF THE TRAINING SCHOOL

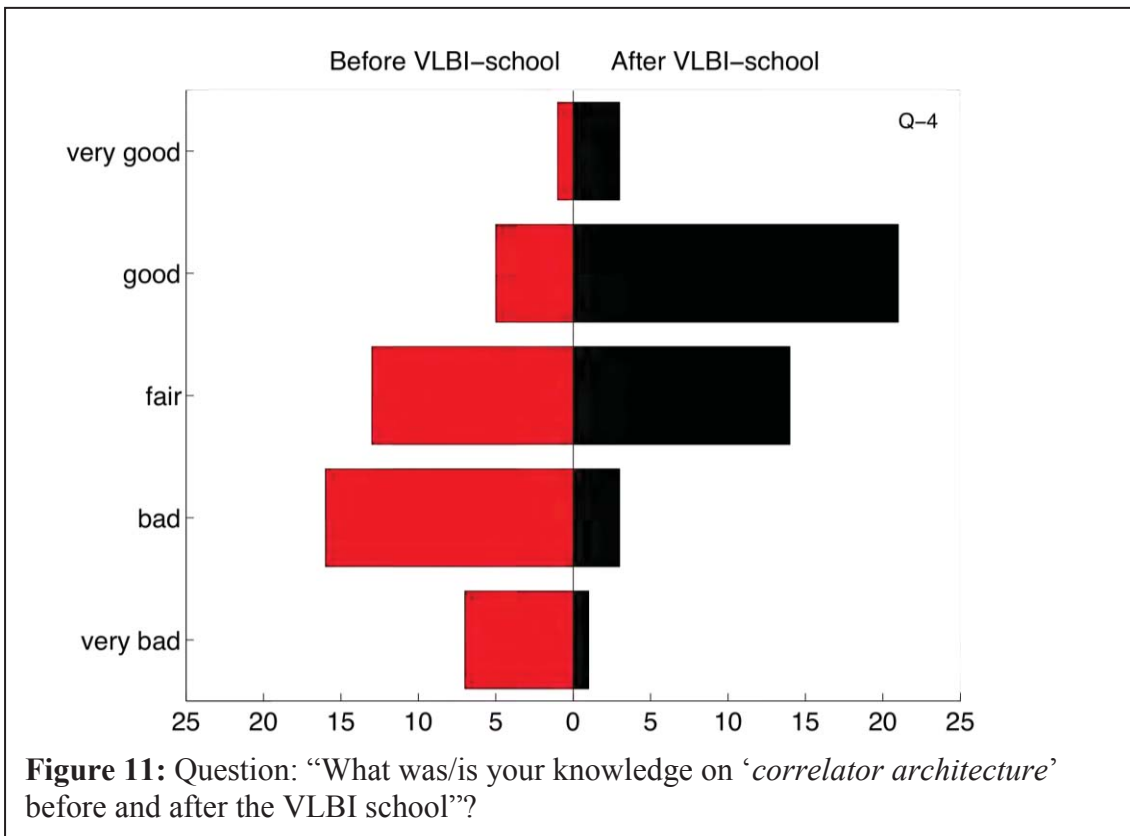
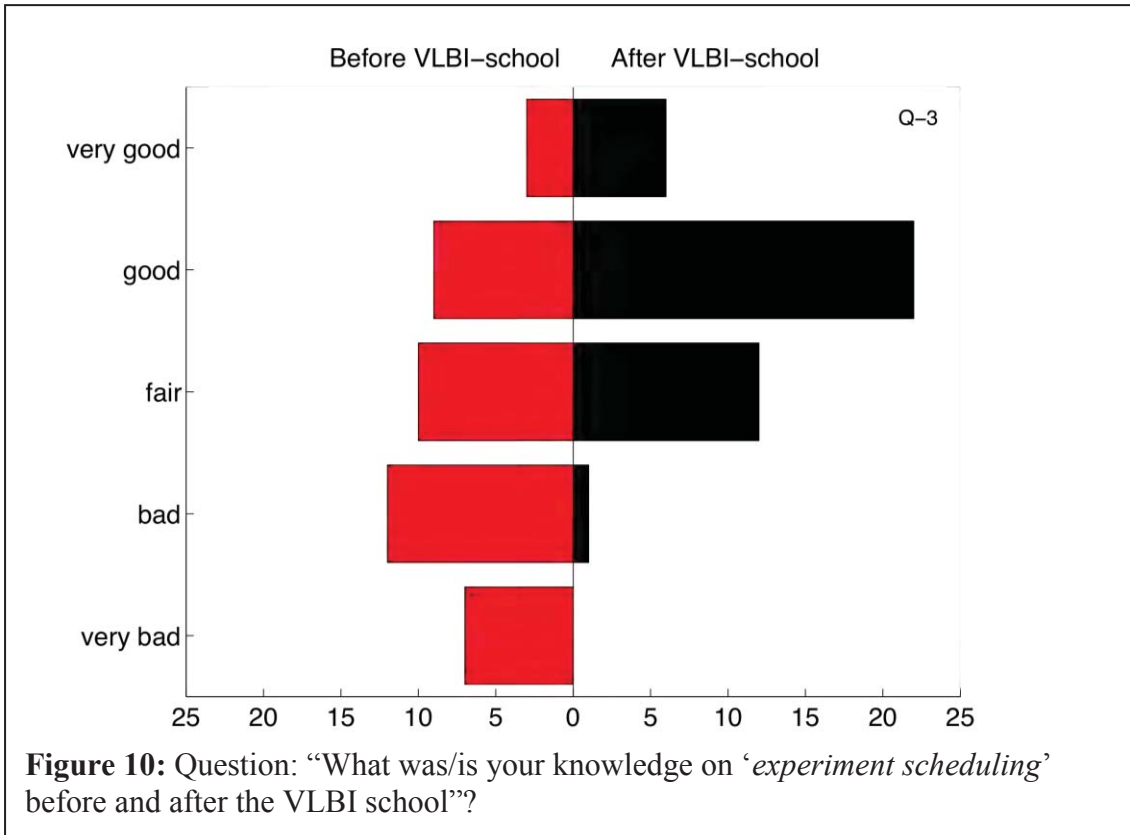
The event was a Training School on VLBI for Geodesy and Astrometry with in total 14 lectures and 3 exercises. All lectures were 90 minutes long, except one that was only 45 minutes long. The exercises were between 45 and 90 minute long, and very much appreciated by the students. The first exercise covered purely technical aspects and focused on aspects like the calculation of sensitivity of radio astronomical systems. The students worked individually and had to solve several small tasks. The second exercise was on software correlation. The students worked in small groups of 4-5 persons and used the DiFX software correlator and the Haystack fringe-fitting software to derive VLBI group delay observables for the baseline Wettzell-Onsala of a real experiment. The third exercise then concentrated on the analysis of geodetic VLBI data. The students worked again in small groups of 4-5 people and performed the necessary ambiguity resolution and ionospheric corrections, and the final parameter estimation.

There was plenty of opportunity for the students to ask questions after the lectures, and there were lively discussions in the coffee breaks and lunch breaks. The students had access to all teachers and could ask questions and discuss various topics.

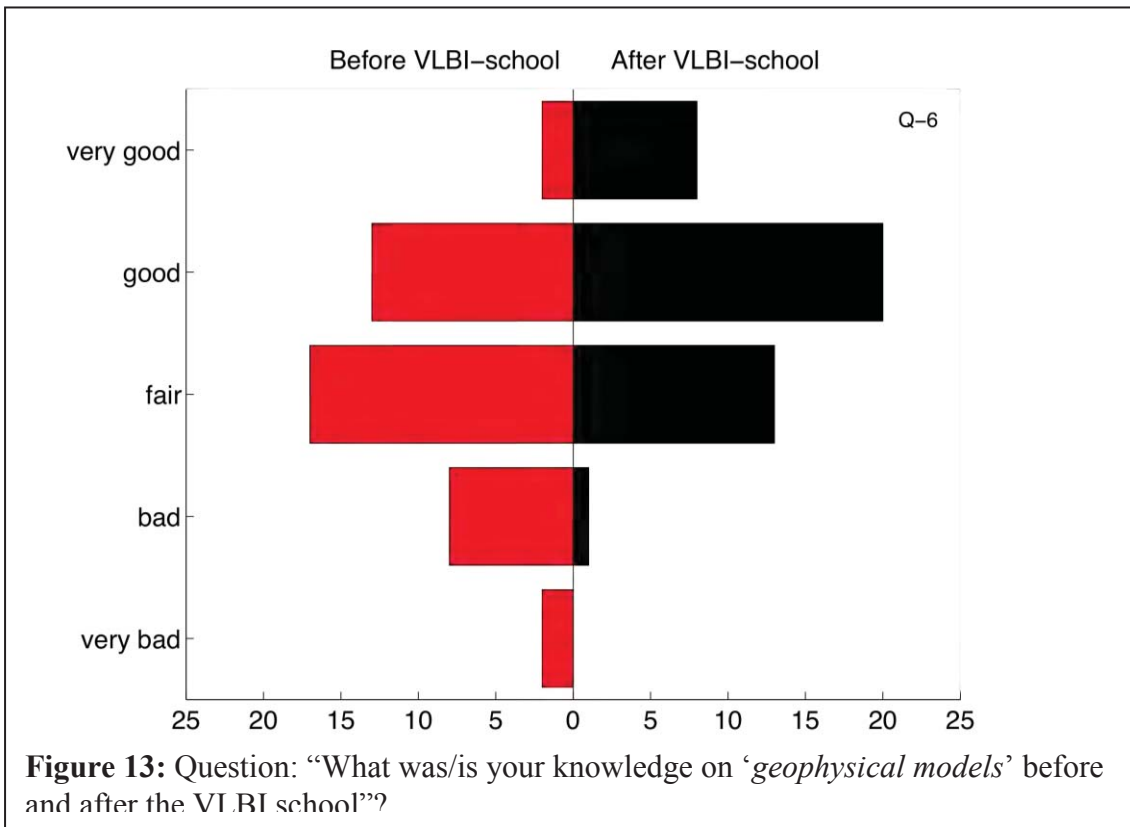
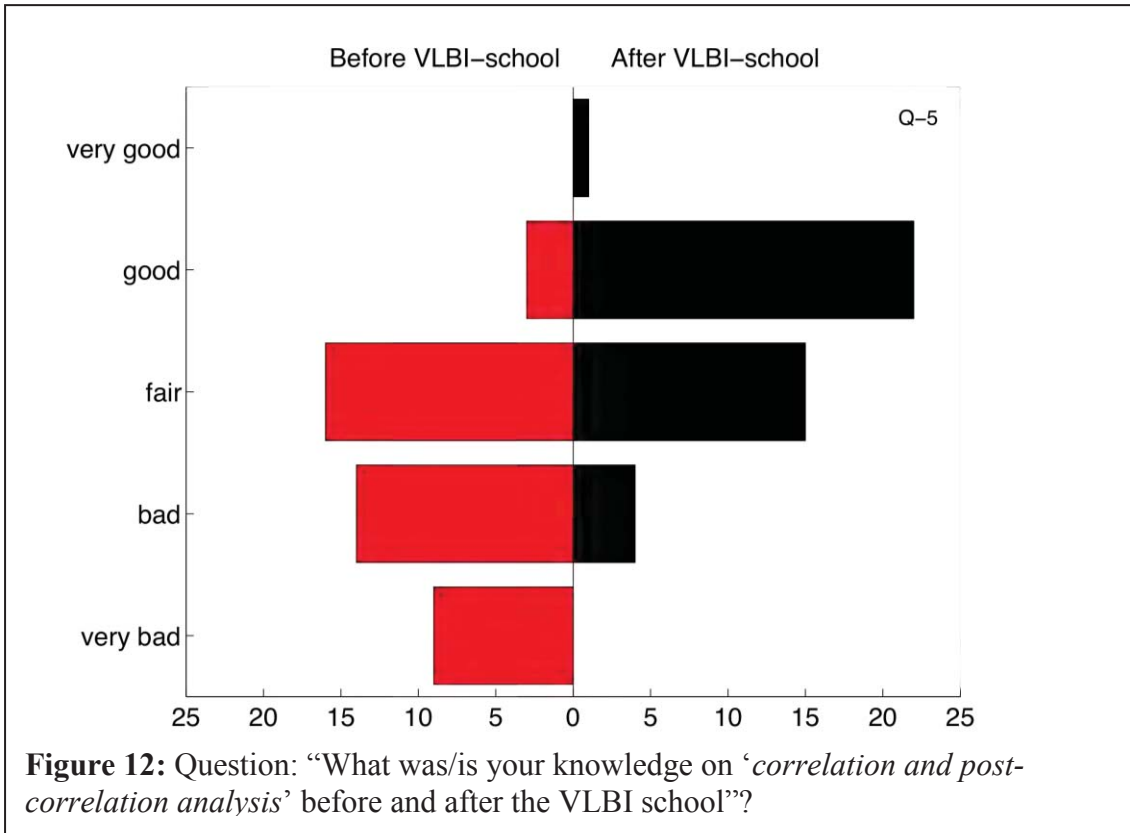
At the end of the last day an evaluation questionnaire was handed out to the students and they were asked to evaluate the VLBI Training School. Copies of the original answers can be provided on request. A summary of the results of the evaluation is presented below.

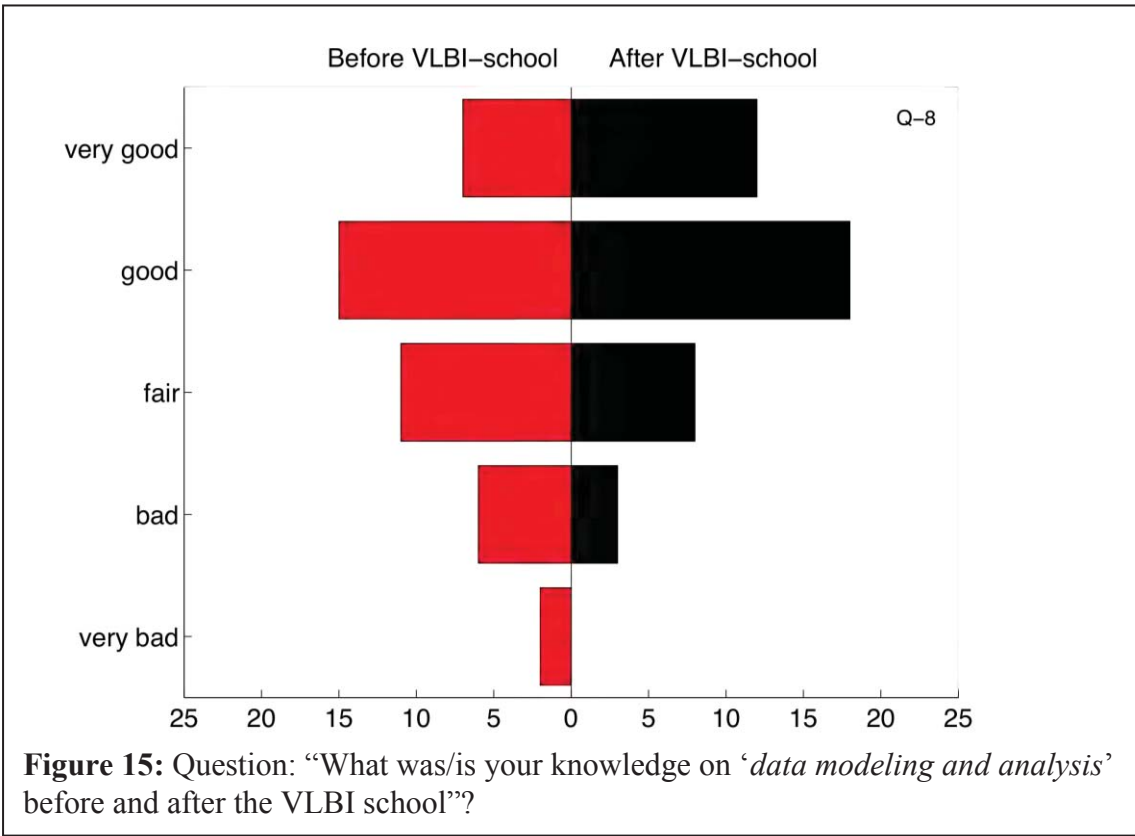
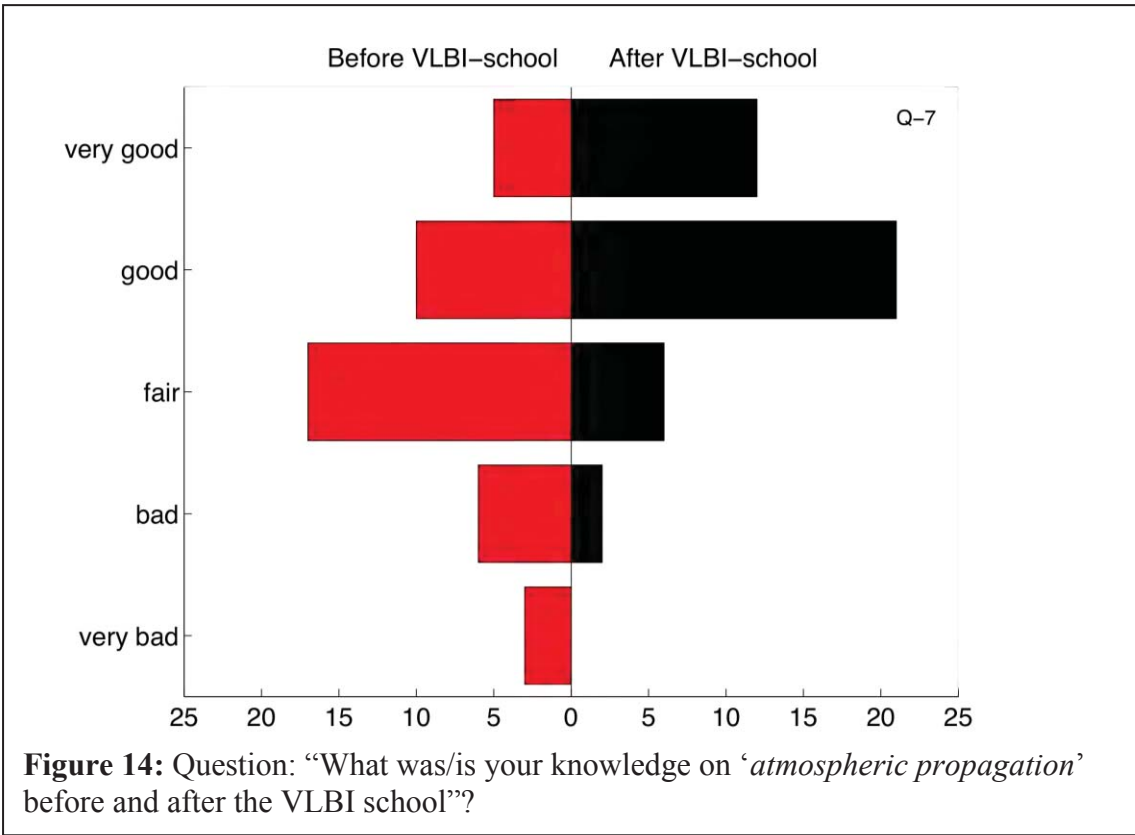


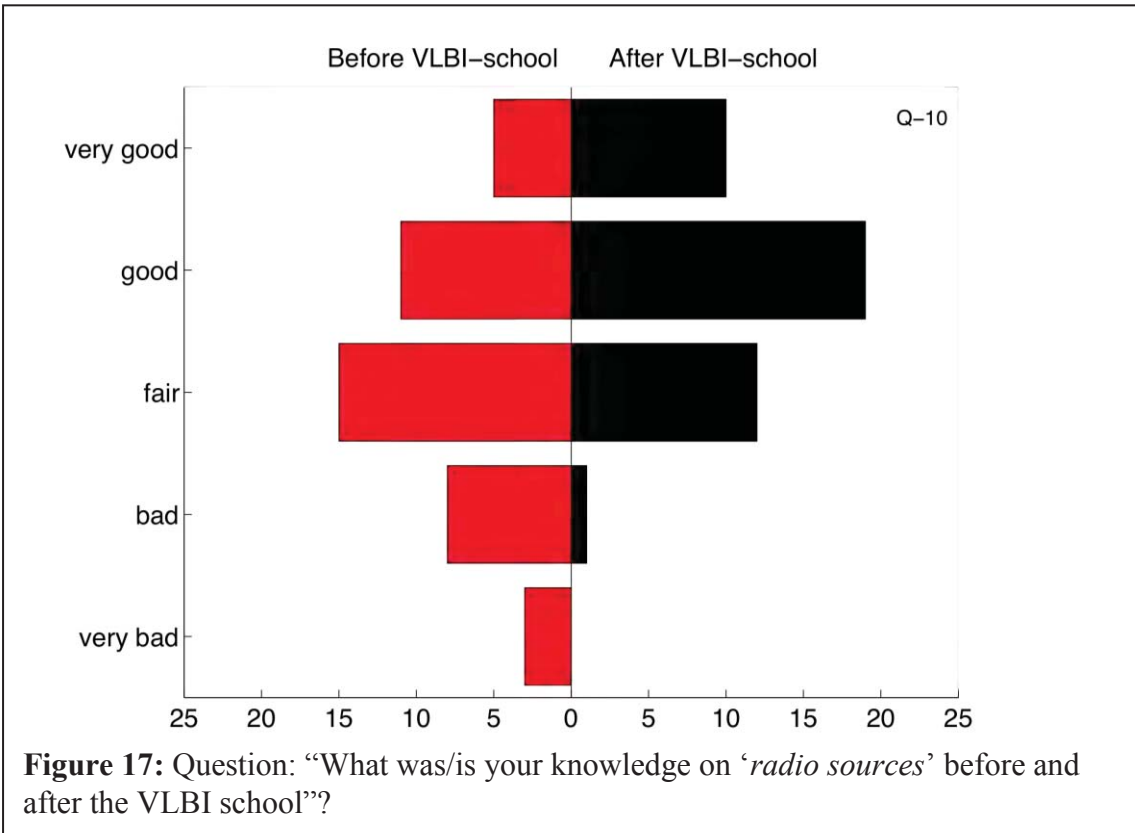
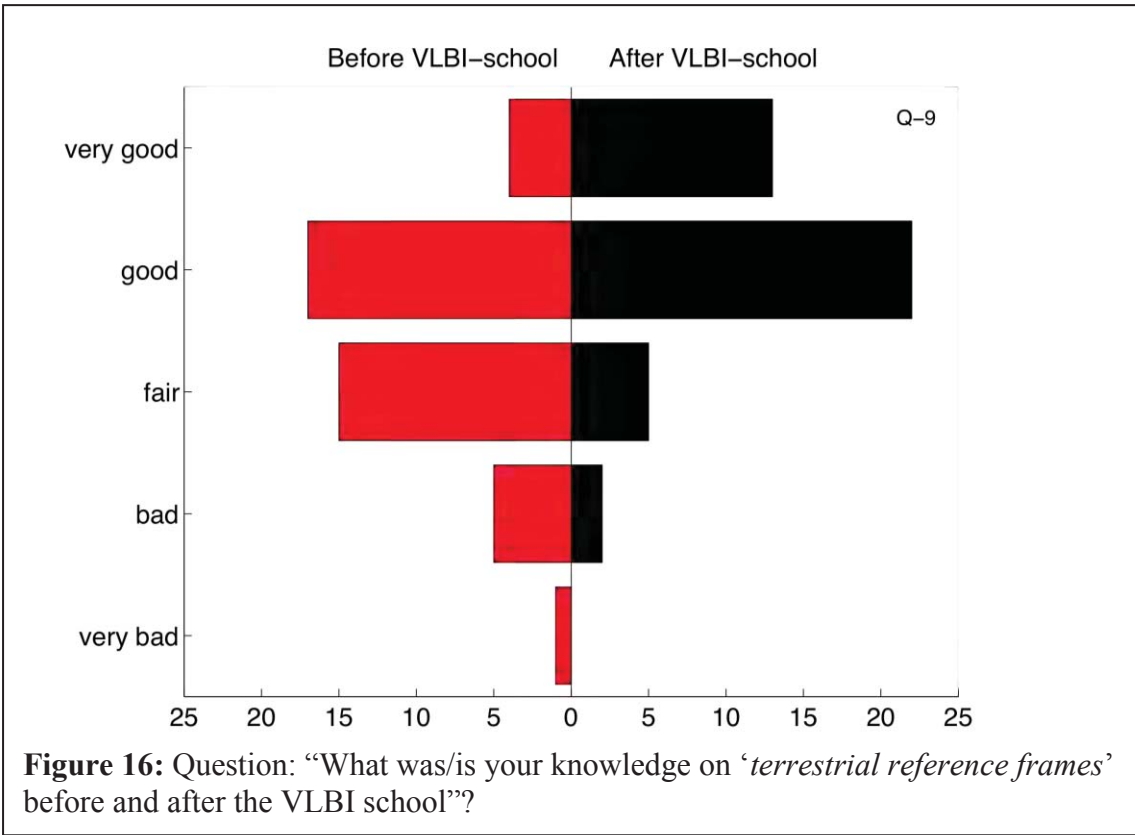


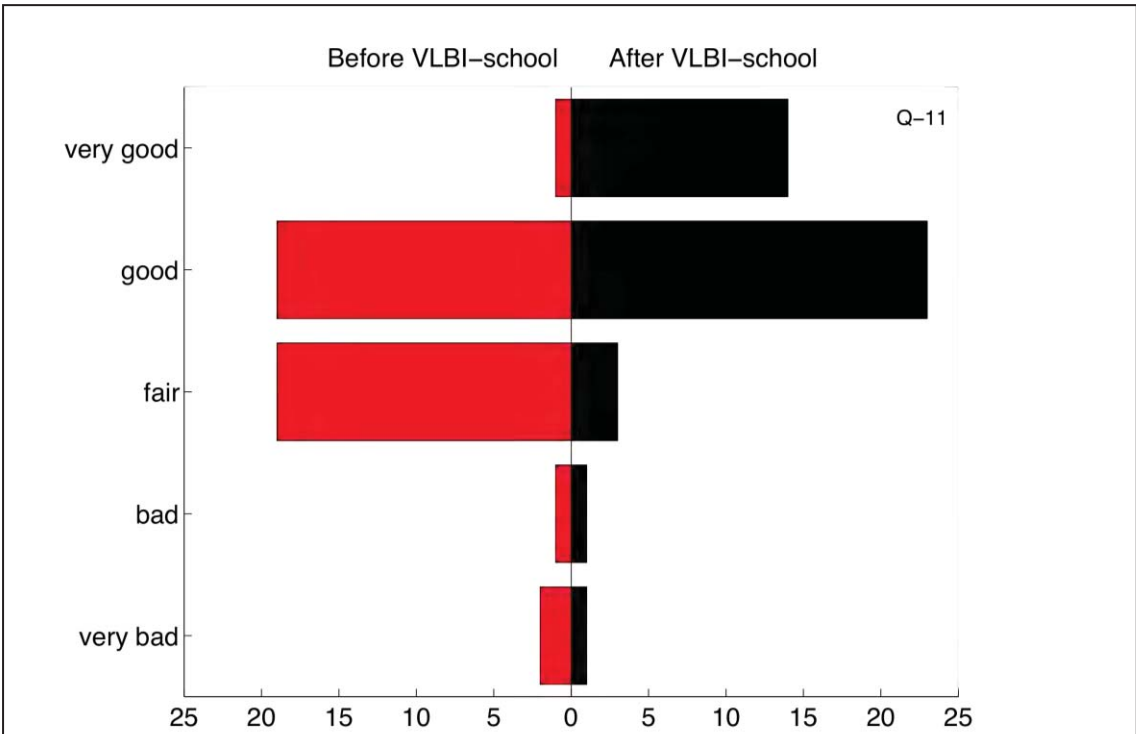




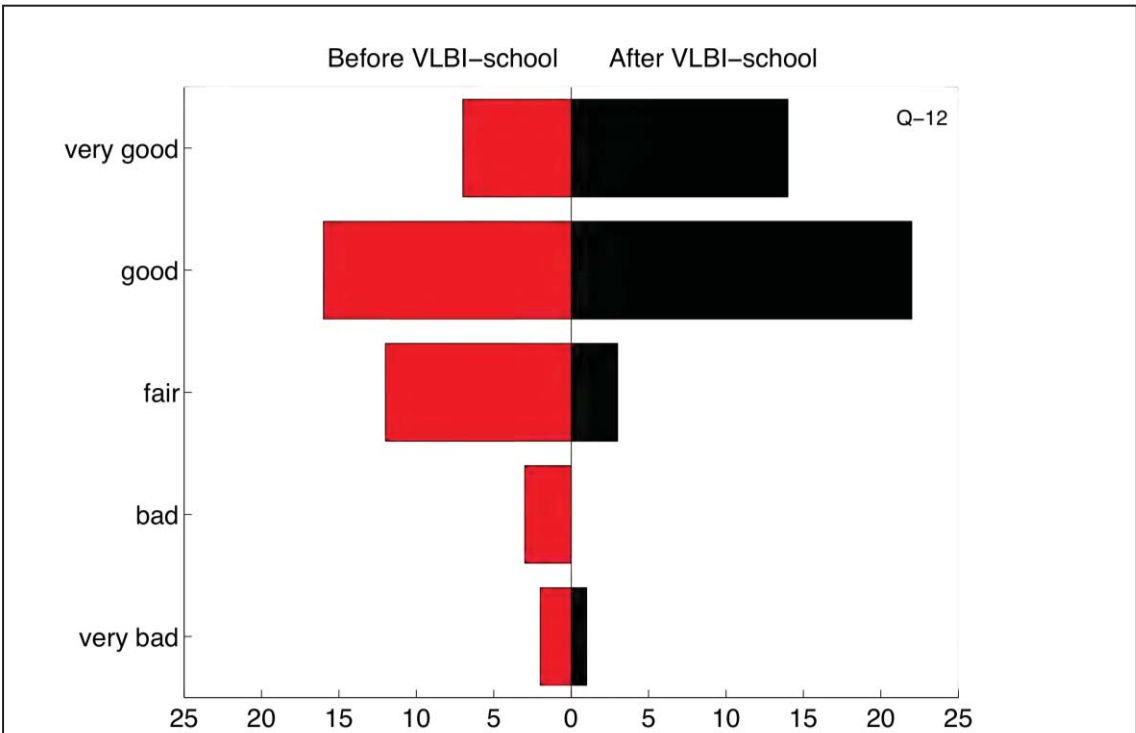








**Figure 18:** Question: “What was/is your knowledge on ‘*celestial reference frames*’ before and after the VLBI school?”



**Figure 19:** Question: “What was/is your knowledge on ‘*earth rotation and orientation*’ before and after the VLBI school?”

The evaluation shows that the three exercises were appreciated by the students and evaluated as ‘good’ to ‘very good’. Several participants answered in the free-text comments of the evaluation questionnaire that the practical exercises were the best part of the VLBI Training School. There was however also some concern that the time was too short to work on some of the exercises. Some participants thought that there should be even more exercises during potential future VLBI Training Schools.

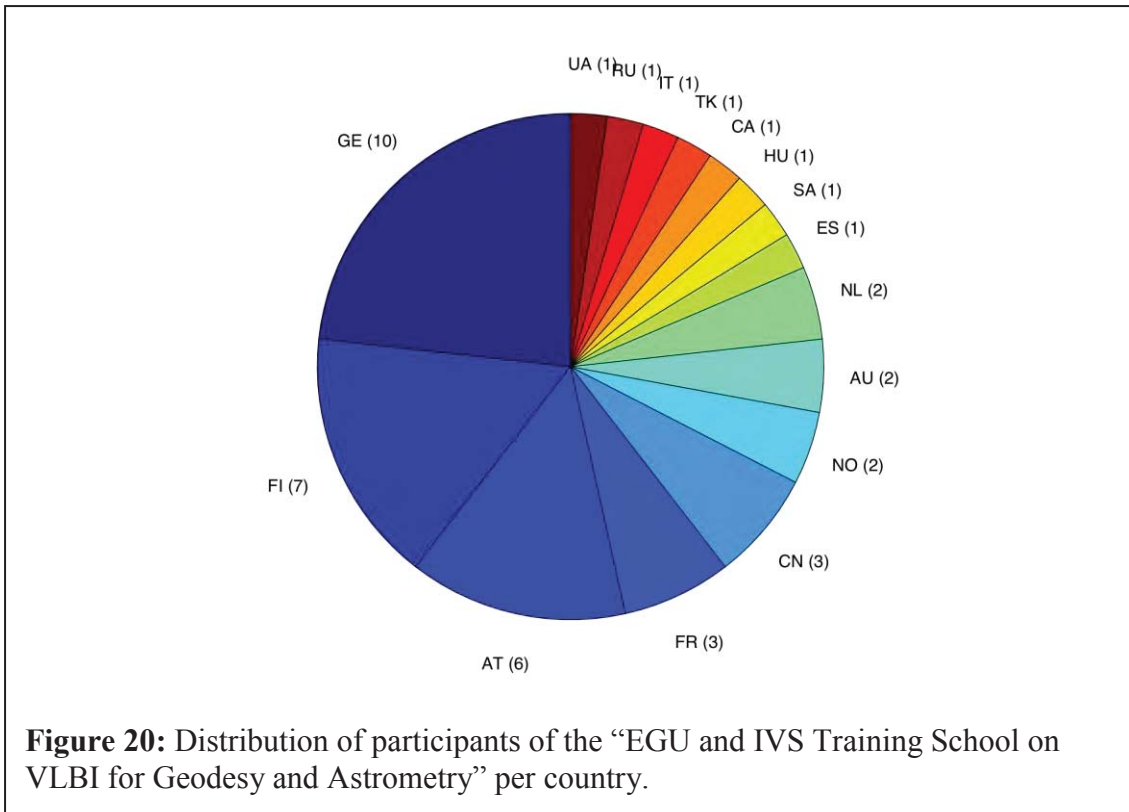
The evaluation also shows that the personal impression of the participants is that they know more on the particular topics after the VLBI Training School than before. More people feel that they have ‘good’ and ‘very good’ knowledge after the VLBI Training School. So there appears to be again in knowledge and the goal to provide education and training has been achieved to a large extend. Many of the free-text comments on the lectures said that the lectures gave a very good overview of all features of VLBI.

The lecture slides are available at the webpages of the European VLBI Group for Geodesy and Astrometry (EVGA, [www.evga.org/material\\_vlbi\\_school\\_2013.html](http://www.evga.org/material_vlbi_school_2013.html)). The intention is that they can be used as a basis for teaching at educational institutes.

The IVS Directing Board had a directing board meeting in Metsähovi on March 8, after the “EGU and IVS Training School on VLBI for Geodesy and Astrometry”. The IVS DB regarded that the “EGU and IVS Training School on VLBI for Geodesy and Astrometry” held in Espoo and Masala was a success. For the next IVS DB in the fall of 2013 a final report of the IVS WG 6 needs to be prepared, so that IVS WG 6 can be closed down. However, then an IVS Committee on Training and Education shall be established, with the task to continue the work started by IVS WG 6. It is anticipated to organize VLBI Training Schools on a regular basis, preferably every third year alternating in connection with the IVS General Meetings and the European VLBI meetings.

## D) ATTENDANCE LIST

There were 43 participants in the VLBI Training School coming from 16 different countries. The countries with more than 1 participant were Germany (10), Finland (7), Austria (6), France (3), China (3), Norway (2), Australia (2) and the Netherlands (2). The distribution of the countries is presented in Figure 20. A group photo taken on the second day of the VLBI Training School when lectures and exercise were held at the headquarters of the Finnish Geodetic Institute (FGI) in Masala, is shown in Figure 21.



## LIST OF PARTICIPANTS:

Bachmann, Sabine  
Federal Agency for Cartography and Geodesy  
Richard-Strauss-Allee 11  
DE-60598 Frankfurt am Main  
Germany  
(Sabine.Bachmann@bkg.bund.de)

Bocanegra-Bahamón, Tatiana Marcela  
Joint Institute For VLBI In Europe  
P.O. Box 2  
NL-7990 AA Dwingeloo  
The Netherlands  
(bocanegra@jive.nl)

Bouffet, Romuald  
Laboratoire d'Astrophysique de Bordeaux (LAB)  
Observatoire Aquitain des Sciences de l'Univers  
Université Bordeaux 1 - CNRS UMR 5804  
2 rue de l'Observatoire  
BP89  
FR-33271 Floirac Cedex  
France  
(bouffet@obs.u-bordeaux1.fr)

Collilieux, Xavier  
IGN/LAREG  
Université Paris Diderot  
35 rue Hélène Brion  
FR-75013 Paris  
France  
(xavier.collilieux@ign.fr)

de Witt, Aletha  
Hartebeesthoek Radio Astronomy Observatory  
Farm 502 JQ, Hartebeesthoek  
Broederstroom Road  
Krugersdorp District, Gauteng  
South Africa  
(alet@hartrao.ac.za)

Esch, Christina  
Kirschenallee 7  
DE-53879 Euskirchen  
Germany  
(christina.esch@web.de)

García-Espada, Susana  
Centro de Desarrollos Tecnológicos  
Subdirección General de Astronomía, Geodesia y Geofísica  
D.G.IGN (Ministerio de Fomento)  
Cerro de la Palera s/n  
ES-19141 Yebes (Guadalajara)  
Spain  
([s.gespada@oan.es](mailto:s.gespada@oan.es))

Halsig , Sebastian  
Institut für Geodäsie und Geoinformation  
Nußallee 17  
DE-53115 Bonn  
Germany  
([halsig@igg.uni-bonn.de](mailto:halsig@igg.uni-bonn.de))

Iddink , Andreas  
Institut für Geodäsie und Geoinformation  
Nußallee 17  
DE-53115 Bonn  
Germany  
([aiddink@uni-bonn.de](mailto:aiddink@uni-bonn.de))

Kallio, Ulla  
Finnish Geodetic Institute  
Geodeetinrinne 2  
P.O. Box 15  
FI-02431 Masala  
Finland  
([ulla.kallio@fgi.fi](mailto:ulla.kallio@fgi.fi))

Karbon, Maria  
Advanced Geodesy Institute of Geodesy and Geophysics (E128)  
TU Wien  
Gußhausstr. 27-29  
AT-1040 Wien  
Austria  
([mkarbon@mail.zserv.tuwien.ac.at](mailto:mkarbon@mail.zserv.tuwien.ac.at))

Kareinen, Niko  
Aalto University  
Metsähovi Radio Observatory  
Metsähovintie 114  
FI-02540 Kylmäla  
Finland  
([nkareine@kurp.hut.fi](mailto:nkareine@kurp.hut.fi))



Kirkvik Ann-Silje  
Kartverket  
Kartverksveien 21  
NO-3511 Hønefoss  
Norway  
(Ann-Silje.Kirkvik@kartverket.no)

Krásná Hana  
Department für Geodäsie und Geoinformation  
Technische Universität Wien  
Gußhausstraße 27-29  
AT-1040 Wien  
Austria  
(hana.krasna@tuwien.ac.at)

Kunkel, Annemarie  
Institut für Geodäsie und Geoinformation  
Nußallee 17  
DE-53115 Bonn  
Germany  
(s6ankunk@uni-bonn.de)

Madzak, Matthias  
Department für Geodäsie und Geoinformation  
Technische Universität Wien  
Gusshausstraße 27-29  
AT-1040 Wien  
Austria  
(matthias.madzak@tuwien.ac.at)

McCallum Jamie  
University of Tasmania  
School of Mathematics and Physics  
Private Bag 37  
Hobart TAS 7001  
Australia  
(Jamie.McCallum@utas.edu.au)

Meschini, Diego  
Finnish Geodetic Institute  
Geodeetinrinne 2  
P.O. Box 15  
FI-02431 Masala  
Finland  
(diego.meschini@fgi.fi)

Mishra, Aum Niranjana

Franz-Mehring-Platz 3  
Zi. Nr. 27.30.16.82  
DE-10243 Berlin  
Germany  
(niranjana.mishra@yahoo.com)

Molera-Calvés, Guifré  
Joint Institute for VLBI in Europe  
Oude Hoogeveensedijk 4  
NL-7991 Dwingeloo  
The Netherlands  
(molera@jive.nl)

Mora-Diaz, Julian Andres  
Technische Universität München  
Fachgebiet Satellitengeodäsie  
Arcisstraße 21  
DE-80333 München  
Germany  
(Mora@dgfi.badw.de)

Orosz, Gábor  
Department of Geodesy and Surveying  
Budapest University of Technology and Economics  
Müegyetem rkp. 3  
HU-1111 Budapest  
Hungary  
(gabor.orosz@gmail.com)

Plank, Lucia  
Technische Universität Wien  
Department für Geodäsie und Geoinformation  
Forschungsgruppe Höhere Geodäsie, E120/4  
Gußhausstraße 27-29,  
AT-1040 Wien  
Austria  
(lucia.plank@tuwien.ac.at)

Ramakrishnan, Venkatesh  
Aalto University  
Metsähovi Radio Observatory  
Metsähovintie 114  
FI-02540 Kylmälä  
Finland  
(venkatesh.ramakrishnan@aalto.fi)

Raposo-Pulido, Virginia

Helmholtz-Zentrum Potsdam  
DeutschesGeoForschungsZentrum GFZ  
Telegrafenberg, A17  
DE-14473 Potsdam  
Germany  
(raposo@gfz-potsdam.de)

Rastorgueva-Foi, Elizaveta  
Aalto University, Metsähovi Radio Observatory  
Metsähovintie 114  
FI-02540 Kylmälä  
Finland  
(elizaveta.rastorgueva@aalto.fi)

Schönberger, Caroline  
Josef-Gall-Gasse 3/5  
AT-1020 Wien  
Austria  
(casch@gmx.at)

Searle, Anthony  
Natural Resources Canada  
Geodetic Survey Division  
615 Booth Street  
Ottawa, Ontario  
K1A 0E9  
Canada  
(Anthony.Searle@NRCan-RNCan.gc.ca)

Shabala, Stanislav  
University of Tasmania  
School of Mathematics and Physics  
Private Bag 37  
Hobart TAS 7001  
Australia  
(Stanislav.Shabala@utas.edu.au)

Shang, Luyao  
VLBI Laboratory  
Shanghai Astronomical Observatory  
Chinese Academy of Sciences  
80 Nandan Road  
Xuhui District  
Shanghai City  
China  
(shly@shao.ac.cn)

Siebert, Moritz Ny-Ålesund  
Geodetic Observatory  
NO-9173 Ny-Ålesund  
Norway  
(moritz.sieber@kartverket.no)

Soja, Benedikt  
Forschungsgruppe Höhere Geodäsie / E-120-4  
Department für Geodäsie und Geoinformation  
Technische Universität Wien  
AT-1040 Wien  
Austria  
(b.soja@gmx.at)

Stetter, Monika  
Forschungseinrichtung Satellitengeodäsie (FESG)  
Technische Universität München (TUM)  
DE-80290 München  
Germany  
(m.stetter@tum.de)

Teke, Kamil  
Hacettepe University  
Department of Geomatics Engineering  
Beytepe  
TR-06800 Ankara  
Turkey  
(kteke@hacettepe.edu.tr)

Tornatore, Vincenza  
DIIAR Politecnico di Milano  
(Sezione rilevamento)  
Piazza Leonardo da Vinci 32  
IT-20133 Milano  
Italy  
(vincenza.tornatore@polimi.it)

Trofimov, Dmitrii  
Astronomical Institute St. Petersburg State University  
Universitetskaya nab 7-9  
St. Petersburg  
Russia  
(dm.trofimov@gmail.com)

Tkachuk, Vadym  
Taras Shevchenko National University of Kyiv  
Glushkova ave. 4  
UA-03127 Kyiv

Ukraina  
(vadimol92@gmail.com)

Ullrich, Dieter  
Bundesamt für Kartographie und Geodäsie  
VLBI-Gruppe  
Karl-Rothe-Straße 10-14  
DE-04105 Leipzig  
Germany  
(dieter.ullrich@bkg.bund.de)

Uunila, Minttu  
Aalto University, Metsähovi Radio Observatory  
Metsähovintie 114  
FI-02540 Kylmälä  
Finland  
(minttu.uunila@aalto.fi)

Verma, Ashok Kumar  
Observatoire de Besançon  
BP 1615  
FR-25010 Besançon  
France  
(ashok@obs-besancon.fr)

Zhang, Jinwei  
Shanghai Astronomical Observatory  
Chinese Academy of Sciences  
80 Nandan Road  
CN-200030 Shanghai  
China  
(jwzhang@shao.ac.cn)

Zubko, Nataliya  
Finnish Geodetic Institute  
Geodeetinrinne 2  
P.O. Box 15  
FI-02431 Masala  
Finland  
(nataliya.zubko@fgi.fi)

Xu, Minghui  
Shanghai Astronomical Observatory  
Chinese Academy of Sciences  
80 Nandan Road  
CN-200030 Shanghai  
China  
(mhxu@shao.ac.cn)

## VGOS Data Recorder Comparison

Compiled by Bill Petrachenko (NRC Canada) & Alan Whitney (MIT Haystack Observatory)  
June 2013

### Introduction.

The minimum VGOS data rate requirements are 16 Gbps 'burst' for 10 sec with ~4 Gbps sustained average rate. This is based on a typical VGOS schedule which alternates between on-source and slew/wait/cal periods with antennas being on source about 25% of the time (but could be greater under some circumstances) and the network slewing to the next source the rest of the time. The maximum on-source period for normal operations is set to 10 s but could be longer at times to achieve greater sensitivity.

At the present time only two VLBI data recorders fully satisfy VGOS operational requirements, the Mark 6 (already available) and the K6/iDAS (still under development). Because the K6/iDAS does not support removable media, it can only be used for e-transfer and not for physical transport of media. See Table 1 for more details.

Another pair of recorders, the Mark 5C and K5/VSI do not themselves meet VGOS data rate requirements. They are however close enough that if preceded by an external RAM buffer or combined in a group of four (plus some format conversions for the K5/VSI), they would become compliant. This solution is neither cost effective nor convenient and hence the Mark 5C and K5/VSI are not recommended for use in VGOS. See Table 2 for more details.

For completeness, other VLBI data recorders that are still in use but not suitable for VGOS are summarized in Tables 3a and 3b.

### Fully Compliant VGOS Data Recorders, Table 1

**Mark 6.** The Mark 6 recorder is an outgrowth of the Haystack/Conduant Mark 5 development. Like its predecessor, the Mark 5C, I/O is based on fixed length Ethernet packets (e.g. VDIF), with the output being an exact replica of the input. Like all Mark 5/6 systems, recording media is removable and packaged as 8-disk SATA modules. Mechanically the Mark 6 includes a system enclosure, a disk module enclosure, and a cable management panel, all produced by Conduant. In terms of data electronics there has been a marked shift toward COTS components with only the disk-module-related hardware produced by Conduant; the motherboard (MB), NIC, and disk interface cards are all COTS. In contrast to the Mark 5 family that uses a proprietary Conduant media file-system format, the Mark 6 uses standard Linux files with 'scattered' data. All software has been developed at Haystack and is open source. The Mark 6 is ideally suited for use in VGOS. It has four 10GigE inputs (one per VGOS band), a maximum aggregate input data rate of a minimum of 16 Gbps into ~64GB of high-speed RAM, and a sustained record rate per installed disk module of ~7 Gbps (for mechanical disks; much higher for SSDs). Hence, it is possible to achieve a sustained record rate significantly greater than the VGOS requirement (~4 Gbps) using only a single 8-disk module, thus minimizing shipping costs. In order to support sustained rates up to 16Gbps or to support unattended operation over longer periods at lower rates, as many as four 8-disk media modules can be simultaneously mounted. Options are available to upgrade existing Mark 5 systems to Mark 6, as well as to upgrade existing Mark 5 SATA disk modules to Mark 6 compatibility.

**K6/iDAS.** The K6/iDAS means the "K6 intelligent Data Acquisition and Streaming" system, which is the name of the sampler with DBBC for VGOS operation developed in Japan. There is no dedicated recorder to the K6/iDAS sampler because it allows us to use itself with a fully COTS server, 10GigE-network switch, and storage system as recorder. You can adopt a server with a 10GigE network interface and a large amount of RAID as a recorder for K6/iDAS. GSI adopted IBM System x3650 M3, Arista 7050S64-T, Data Direct Networks (DDN) Storage with StorNext to be compliant with a sustained record rate of 32 Gbps, which leaves room for future enhancement of the VGOS requirements. The recording system adopted by GSI does not support removable media so it can only be used for e-transfer and not for physical transport of media. It also does not support the IVS standard VSI-S control protocol but is controlled directly by logging into the system.

	<b>Mark 6</b>	<b>K6/iDAS (the recording system adopted by GSI)</b>
<b>VGOS Compatibility</b>	Full	eVLBI (yes) Media physical transport (no)
<b>Data Input Connection</b>	4x10GigE	2x10GBASE-SR
<b>Max data-rate per input connection</b>	8 Gbps	8 Gbps
<b>Max aggregate input data rate</b>	16 Gbps	32 Gbps (4 sampler units/8 servers)
<b>Max sustained record rate</b>	~7 Gbps x # of media packages installed (for hard disks); much faster for SSDs	32 Gbps
<b>RAM buffer size</b>	64 Gbytes (~30 s at 16 Gbps)	N. A.
<b>Removable media?</b>	Y	N
<b>Recording media packaging</b>	Mk6 8-disk SATA module	SATA & SAS Linux RAID with StoreNext
<b>Max # of media packages per system</b>	4	1
<b># media packages for max recording data rate</b>	2 to 4 depending on speed of disks	1
<b>Input data format</b>	VDIF or Mk5B Ethernet packets	VDIF (UDP/IP)
<b>Record-data format</b>	VDIF	VDIF
<b>Media file-system format</b>	Linux files w/'scattered' data	Linux files
<b>Resilient to slow recording media?</b>	Y	Y
<b>Max aggregate playback rate</b>	Up to 16 Gbps (depends on playback system details)	32 Gbps
<b>Playback data interface type</b>	10GigE or Infiniband	1x10GigE x 16 servers
<b>Playback data format</b>	Recorded data payload in Ethernet frame	VDIF
<b>OS type</b>	Linux	Linux
<b>Software developer ('proprietary' or 'open')</b>	Haystack (open)	GSI/Nitsuki (open by GSI)
<b>Command interface connection</b>	GigE	GigE
<b>Command language</b>	VSI-S	Direct control by logging into the system
<b>Current status</b>	Available	Under development, partially available
<b>Cost (USD)</b>	~\$14K USD	depend on rate and capacity
<b>Contact</b>	<mark6@haystack.mit.edu>	Shinobu Kurihara <skuri@gsi.go.jp>

**Table 1.** VGOS Data Recorders – systems fully meeting the VGOS specification. However, the K6/iDAS does not support removable media and hence only works at stations dedicated to eVLBI.

**Potentially Compliant (but not recommended) VGOS Data Recorders, Table 2**

**Mark 5C.** The Mark 5C recorder is an outgrowth of the Haystack/Conduant Mark 5 development. In contrast to its predecessors, I/O is based on fixed length Ethernet packets (e.g. VDIF) with the output being an exact replica of the input. Like all Mark 5 systems, recording media is removable and packaged as Mk5 8-disk PATA or SATA modules. Mechanically the Mark 5C includes a system and disk-module enclosure produced by Conduant. Its data electronics include a standard COTS motherboard and disk array interface, 10GigE daughterboard and data distributor produced by Conduant. The Mark 5C could conceivably be adapted to support VGOS if four Mark 5's were used at each station or if it were preceded in the signal chain by a burst mode RAM buffer, but these options are neither cost effective nor convenient; hence the Mark 5C is not recommended for VGOS.

**K5/VSI.** The K5/VSI is a VSI-H based VLBI recorder using K5 data-frame format. It is housed in a standard PC enclosure with a proprietary PC-VSI board from Digital Link and a COTS NIC and disk interface. The K5/VSI could conceivably be adapted to support VGOS if four K5/VSI's were used at each station if it were preceded in the signal chain by a burst mode RAM buffer, but these options are neither cost effective nor convenient. Hence the K5/VSI is not sufficient for VGOS. The K5/VSI does not support removable media so it can only be used for e-transfer and not for physical transport of media. Finally, it does not support the standard IVS VSI-S control protocol but is controlled directly by logging into the system at present. Since the recording is totally controlled by the software on standard linux, this feature can be improved by software cording on the linux OS without any difficulty.

	<i>Mark 5C</i>	<i>K5/VSI</i>
<b>VGOS Compatibility</b>	Requires 4 systems or the addition of a burst mode buffer.	Requires 4 systems or the addition of a burst mode buffer, plus VSI-H to VDIF converter.
<b>Data Input Connection</b>	10GigE	VSI-H
<b>Max data-rate per input connection</b>	4 Gbps	2 Gbps
<b>Max aggregate input data rate</b>	4 Gbps	4 Gbps (with 2 PC's)
<b>Max sustained record rate</b>	4 Gbps	4 Gbps (with 2 PC's)
<b>RAM buffer size</b>	N.A.	N.A.
<b>Removable media?</b>	Y	N
<b>Recording media packaging</b>	Mk5 8-disk PATA or SATA module	RAID array in commercial pkg.
<b>Max # of media packages per system</b>	2	N.A.
<b># media packages for max recording data rate</b>	2	2 (with 2 PC's)
<b>Input data format</b>	Any fixed-length Ethernet package (e.g. VDIF)	VSI-H
<b>Record-data format</b>	Ethernet-frame data payload (typically Mk5B or VDIF)	VDIF, K5/VSSP, Mark5B
<b>Media file-system format</b>	Proprietary	Linux files
<b>Resilient to slow recording media?</b>	Y	Y
<b>Max aggregate playback rate</b>	~1 Gbps	Depends on speed of PC ~6 Gbps



<b>Playback data interface type</b>	GigE	1GigE or 10GigE
<b>Playback data format</b>	Same as input format	1GigE or 10GigE
<b>OS type</b>	Linux	Linux
<b>Software developer ('proprietary' or 'open')</b>	Conduant (prop) and Haystack (open)	Data Link (prop) NICT (open)
<b>Command interface connection</b>	GigE	GigE
<b>Command language</b>	VSI-S	Direct control by logging into the system
<b>Current status</b>	Available	Available
<b>Cost (USD)</b>	~23K USD	~20K USD
<b>Contact</b>	<mark5@haystack.mit.edu>	Mamoru Sekido <sekido@nict.go.jp>

**Table 2.** Potentially compliant (but not recommended) VGOS Data Recorders.

**VLBI Data Recorders that are not VGOS compliant, Table 3a**

**Mark 5A/B.** The Mark 5A recorder was the first entry in the Mark 5 family and as such was designed to have minimal disruption from existing tape based systems. Hence it used a VLBA/Mark4 input data format and a recorded data-frame format that is based on the VLBA/Mark4 tape systems. The Mark5B represents a move towards IVS standards and uses a VSI-H input data format and a Mark 5B data-frame format. In both cases, recording media is removable and packaged as Mk5 8-disk PATA or SATA modules and the media file-system format is proprietary to Conduant. Mechanically, the Mark 5A/B uses a system and disk module enclosure produced by Conduant. Its data electronics include a standard COTS motherboard with proprietary disk array interface and data distributor produced by Conduant. Mark 5A/B data rates are too low to be useful for VGOS and the systems are no longer available.

	<b>Mark 5A</b>	<b>Mark 5A+</b>	<b>Mark 5B</b>	<b>Mark 5B+</b>
<b>VGOS Compatibility</b>	No	No	No	No
<b>Data Input Connection</b>	VLBA	VLBA	VSI-H	VSI-H
<b>Max data-rate per input connection</b>	1 Gbps	1 Gbps	1 Gbps	2 Gbps
<b>Max aggregate input data rate</b>	1 Gbps	1 Gbps	1 Gbps	2 Gbps
<b>Max sustained record rate</b>	1 Gbps	1 Gbps	1 Gbps	2 Gbps
<b>RAM buffer size</b>	N.A.	N.A.	N.A.	N.A.
<b>Removable media?</b>	Yes	Yes	Yes	Yes
<b>Recording media packaging</b>	Mark 5 8-disk PATA or SATA module			
<b>Max # of media packages per system</b>	2	2	2	2
<b># media packages for max recording data rate</b>	1	1	1	1
<b>Input data format</b>	VLBA/Mark 4	VLBA/Mark	VSI-H	VSI-H

<b>Record-data format</b>	VLBA/Mark 4 data frame format	Mark 5B data frame format		
<b>Media file-system format</b>	Proprietary (Conduant)			
<b>Resilient to slow recording media?</b>	Yes	Yes	Yes	Yes
<b>Max aggregate playback rate</b>	1 Gbps	1 Gbps	1 Gbps	1 Gbps
<b>Playback data interface type</b>	GigE	GigE	GigE	GigE
<b>Playback data format</b>	VLBA	VLBA	Mark 5B	Mark 5B
<b>OS type</b>	Linux	Linux	Linux	Linux
<b>Software developer ('proprietary' or 'open')</b>	Conduant (proprietary); Haystack (open)			
<b>Command interface connection</b>	GigE	GigE	GigE	GigE
<b>Command language</b>	VSI-S	VSI-S	VSI-S	VSI-S
<b>Current status</b>	obsolete	obsolete	obsolete	Obsolete
<b>Cost (USD)</b>	N.A.	N.A.	N.A.	N.A.
<b>Contact</b>	<a href="mailto:mark5@haystack.mit.edu">mark5@haystack.mit.edu</a>			

**Table 3a.** Legacy Mark 5 Data Recorders – not compatible with VGOS and obsolete.

**VLBI Data Recorders that are not VGOS compliant, Table 3b.**

**LBADR.** The LBADR is a data recorder designed for the Australian LBA. It uses VSI-H data interfaces and Linux files with 'scattered' data. It is packaged as a Standard PC (with optional disk array) and uses standard PC electronics plus a PCI data-capture board from Metsahovi (which is no longer available). LBADR data rates are too low to be useful for VGOS.

**K5/VSSP32.** The K5/VSSP32 is a highly COTS recorder. Its input connection is USB, its file system is linux, and it uses a standard COTS PC system with NIC disk interface. It does not support the standard IVS VSI-S control protocol but is controlled directly by logging into the system. K5/VSSP32 data rates are too low to be useful for VGOS.

	<i>LBADR</i>	<i>K5/VSSP32</i>
<b>VGOS Compatibility</b>	No	No
<b>Data Input Connection</b>	2xVSI-H	USB
<b>Max data-rate per input connection</b>	512 Mbps	256 Mbps
<b>Max aggregate input data rate</b>	512 Mbps	256 Mbps
<b>Max sustained record rate</b>	512 Mbps	256 Mbps
<b>RAM buffer size</b>	N.A.	N.A.
<b>Removable media?</b>	?	Y
<b>Recording media packaging</b>	RAID array in commercial pkg.	PC removable disk
<b>Max # of media packages per system</b>	?	Flexible

# media packages for max recording data rate	1	1
Input data format	?	K5-VSSP32
Record-data format	?	K5/VSSP *
Media file-system format	Linux files w/'scattered' data	Linux files
Resilient to slow recording media?	Y	Y
Max aggregate playback rate	?	Depends on speed of PC ~6 Gbps
Playback data interface type	GigE	1GigE or 10GigE
Playback data format	VSI-H or optional software defined through 1GigE	1GigE or 10GigE
OS type	Linux	Linux
Software developer ('proprietary' or 'open')	?	Nitsuki (prop) NICT (open)
Command interface connection	?	GigE
Command language	?	Direct control by logging into the system
Current status	PCI data-capture board no longer available	Available
Cost (USD)	N.A.	Price of a PC with USB
Contact	Chris Phillips <chris.phillips@csiro.au>	Mamoru Sekido <sekido@nict.go.jp>

\* K5/VSSP Data Format: [http://www2.nict.go.jp/aeri/sts/stmg/K5/VSSP/vssp32\\_format.pdf](http://www2.nict.go.jp/aeri/sts/stmg/K5/VSSP/vssp32_format.pdf)

**Table 3b.** Other VLBI Data Recorders – not compatible with VGOS

## Proposal for VGOS Observing Plan

Bill Petrachenko, Dirk Behrend, Hayo Hase, Chopo Ma,  
Arthur Niell, Axel Nothnagel, Xiuzhong Zhang

February 13, 2014

Over the past several years, VGOS development has been guided by the VLBI2010 Project Executive Group (V2PEG) and VLBI2010 Committee (V2C) with the V2C focusing on completion of the VLBI2010 system and the V2PEG concentrating on network expansion. In this document the V2PEG presents an operational plan to bridge the gap between the bold targets of VGOS and the current operational programmes of the IVS.

As an initial operational target, VGOS aims for sustained daily product performance at the level of the CONT sessions or better by the end of 2017. This represents a daily performance improvement that gives the IVS an unambiguous direction for the next four years; and it makes clear the IVS's resolve for a significantly improved VLBI component in a tangible time frame.

This plan provides an operational context for VGOS broadband stations and hence motivates both new and legacy stations to seek funds to upgrade to broadband capability. It places a priority on early high quality but cost effective *daily* operations with performance improving as operational capacity increases. It assumes that most of the new broadband antennas will be dedicated to VGOS operations and will not be shared with other applications such as astronomy or spacecraft tracking.

### Deployment of VGOS Systems

The VGOS system design is described in detail in the VLBI2010 project specification (Petrachenko et al. 2009). Over the past year a number of actions have been undertaken in the realization of the concept:

- Broadband feed, digital back end (DBE) and recorder comparisons have been completed including information on commercial availability.
- The broadband systems have been improved—specifically towards increased reliability and greater compliance with VLBI2010 specifications.
- Geodetic tests have been successfully undertaken (so far only on the GGAO to Westford baseline).
- An RFI study was undertaken indicating that:
  - A large number of stations will be able to operate in the full 2–14 GHz range without front end saturation.
  - A small number of sites will be limited to operating in the 3-14 GHz range to avoid front end saturations.

Over the next year it is recommended that the following further steps be encouraged:

- RFI studies continue at potential VGOS sites.

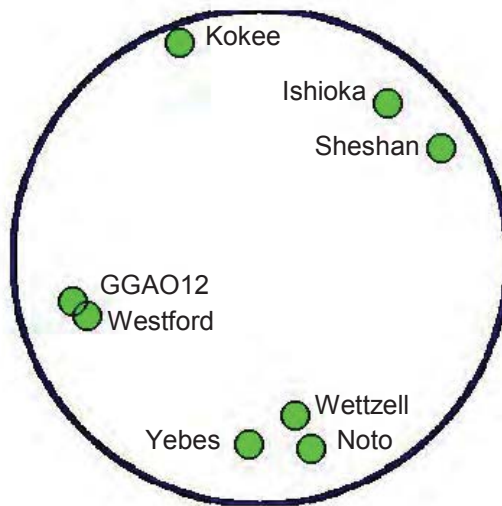
- The DORIS/SLR RFI co-location problem is addressed.
- Geodetic broadband observations continue on the GGAO-Westford baseline.
- Broadband observations begin with a third more distant station (e.g. Kokee or Wettzell) to demonstrate performance over longer baselines.
- Broadband development continues with the goal of achieving full VLBI2010 compliance (with commercial availability wherever possible), specifically including
  - cryogenic front ends for both QRFH and Eleven Feed.
  - DBE's with 1-GHz bandwidth.
  - flexible down converters with full 2–14 GHz.
  - completion of high capacity data systems.
  - a cable calibration system.
  - demonstration of the DBBC3 direct sample system.
  - demonstration of a Stirling cycle cryogenic system.
- A convenient and effective 'mixed-mode' methodology (i.e., legacy S/X with VGOS broadband in S/X mode) needs to be developed so that strong geodetic ties can be developed between new VGOS stations and the legacy S/X network.
- Short baseline phase delay measurements be made between new antennas and co-located legacy antennas.

### Expansion and Testing of the VGOS Network in 2014

By the end of 2014 as many as eight antennas are expected to have achieved broadband capability (see Table 1 and Figure 1).

*Table 1. Antennas achieving broadband capability by the end of 2014.*

<b>Station</b>	<b>When</b>	<b>Antenna</b>	<b>Notes</b>
GGAO12	Now	Fast	
Ishioka	Mid-2014	Very fast	2 years of S/X/Ka legacy ties
Kokee	2014	Legacy	Very fast antenna in 2015
Noto	2014	Legacy	Direct sampling approach
Sheshan	2014	Very fast	
Westford	Now	Legacy	Shared with Lincoln Laboratory
Wettzell	Mid-2014	Very fast	
Yebe	Mid-2014	Very fast	



*Figure 1. North polar projection of antennas achieving broadband capability by the end of 2014.*

Throughout 2014 there will be four main VGOS-related activities:

1. the qualification of new VGOS stations as they come on line in broadband and (if RFI permits) S/X modes;
2. preparations for the VGOS trial operations scheduled for 2015 (see next section for details of the trials). Preparations include ensuring that adequate station, media and correlator resources are available and that as many processes as possible are automated for smooth and sustained operations;
3. the development and testing of processes for mixed-mode (legacy S/X with VGOS broadband in S/X mode) operations including the qualification of digital back ends at legacy S/X stations; and
4. the execution of mixed-mode sessions (i.e., VGOS broadband stations in S/X sessions, e.g., T2, R1, R4) to establish strong ties between legacy and VGOS sites.

To help achieve the first two items, the OPC has scheduled seven sessions in 2014 specifically for VGOS operations. If needed other ad hoc sessions (e.g., for fringe tests) can also be added. In order to have a clean spectrum for VGOS broadband observing, the VGOS sessions are planned to operate solely in the 3–14 GHz range. The V2PEG encourages stations to seek the required funding to join the VGOS sessions of 2014 and the VGOS trial operations of 2015.

For the latter two items it is recognized that RFI around the current S-band frequency may preclude the use of a full 2–14 GHz broadband receiver at certain locations, so that these broadband stations will not be able to participate in mixed-mode observations. If RFI does not inhibit observation at 2–3 GHz, however, broadband conversions and new broadband facilities should be encouraged to cover the full 2–14 GHz VGOS range.

## Trial Operations of the VGOS Network in 2015

During 2015 there will be three trial VGOS campaigns to evaluate and improve aspects of VGOS operations. To properly assess the sustainability of the three aspects of operations, each trial will last at least 6–8 weeks thus ensuring that the full ‘schedule–acquire–ship/transmit–correlate/process/analyse–ship/transmit’ cycle can be completed without developing a back-log. Each trial should further be separated by 8–10 weeks to allow for the eventuality of a back-log, to assess performance, to recommend improvements, and to prepare for the next trial. This effort will be coordinated by the IVS Coordinating Center.

**Trial 1:** *Sustained Weekly 24-hour Sessions, Jan–Feb.* This trial involves observing one 24-hour session each week in VGOS broadband mode. The network will include all available qualified VGOS stations, i.e., about 8 stations. Schedules will be optimized to best use all VGOS characteristics, in particular the very fast slewing of the new antennas. It is recommended that the broadband day be inserted as day 7 (e.g., B7nnn) to best bridge the largest gap in the week between R4 and R1 and start at 0 hr UT to match the satellite geodetic techniques (see Figure 2). Although an observation on the weekend is required, this should not be a problem for a fully qualified VGOS antenna that can safely operate in automated or remote control mode. As broadband operations mature, it should be possible to record a full 24-hour session on a single recording module. [Given a detection limit of SNR=10 per band, a typical source flux distribution and a minimum correlated flux of 250 mJy, the average observation at a station should require only about 10 GB. At 10 GB per observation, a single 32-TB module will record up to 3200 observations (i.e., 1 observation every 27 s), more than enough to record a full 24-hour session on a single module even for “very fast” VGOS antennas.] For sustained operations, a pool of four 32-TB modules per station will be required along with funds to ship one module per station per week back and forth between the correlator and station.

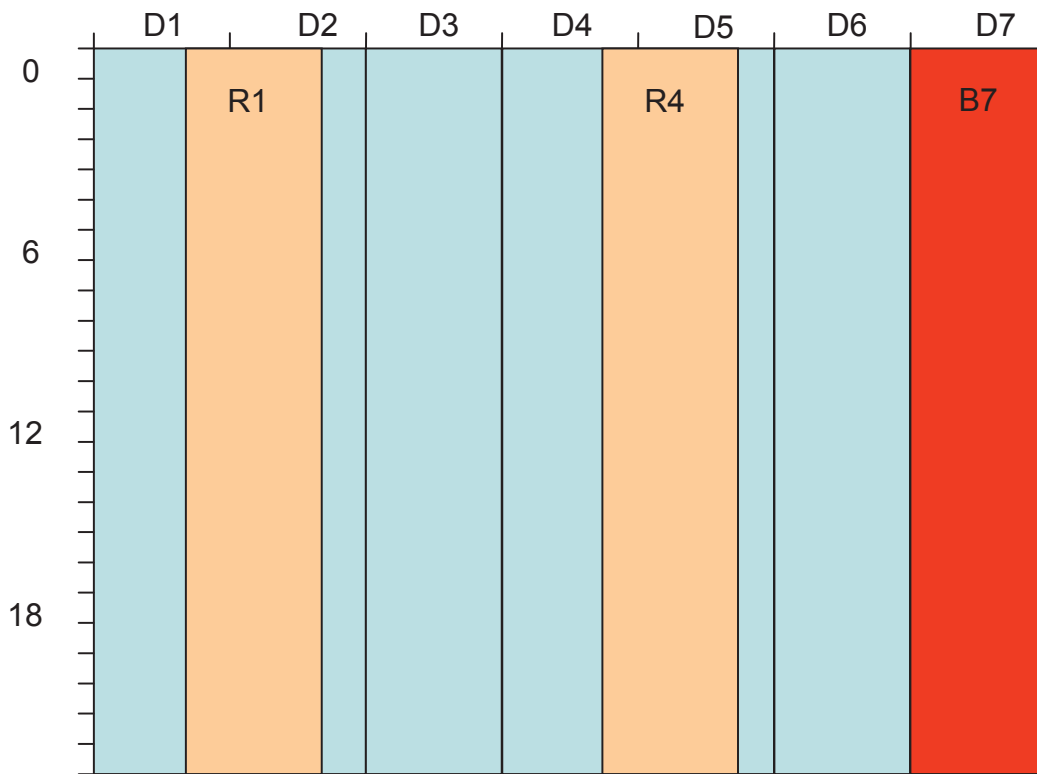


Figure 2. Trial 1: Sustained Weekly 24-hour Session, Jan–Feb. The VGOS Day 7 (B7nnn) broadband session is represented in red.

**Trial 2: Sustained Daily VGOS EOP Sessions, May–June.** VGOS broadband observations will be carried out on a daily basis using a consistent network. VGOS stations that cannot guarantee daily availability because of additional other roles (e.g., Noto and Westford) can be added when available on a tag-along basis, which does not impact the scheduling of the core network. In recognition of the fact that, at the start of VGOS operations, some stations will not have the resources to maintain full 24/7 observing, this trial involves a reduced duty cycle schedule in which daily sessions are made up of four one-hour bursts spaced equally in time, i.e., one burst every six hours (see Figure 3). This type of schedule still allows determination of all EOP, strongly attenuates diurnal and semi-diurnal signals, and reduces both time variable network biases and source selection biases. Aliasing of high frequency EOP due to the gaps between bursts in the daily sessions is not expected to be a major negative factor. For this type of schedule, all operational costs including data transmission, wear and tear on equipment, and power consumption will be equivalent to scarcely more than a single day of operations per week. It is assumed that the bursts can be turned on and off in an unattended mode so that additional staffing resources will be minimal. The purpose of this trial is to exercise sustained daily operations at the stations without regard to timely transmission of data to the correlator. Data will be shipped once per week to the correlator and will require only a single module per station. Hence the media pool and shipping requirements are the same as for Trial 1.



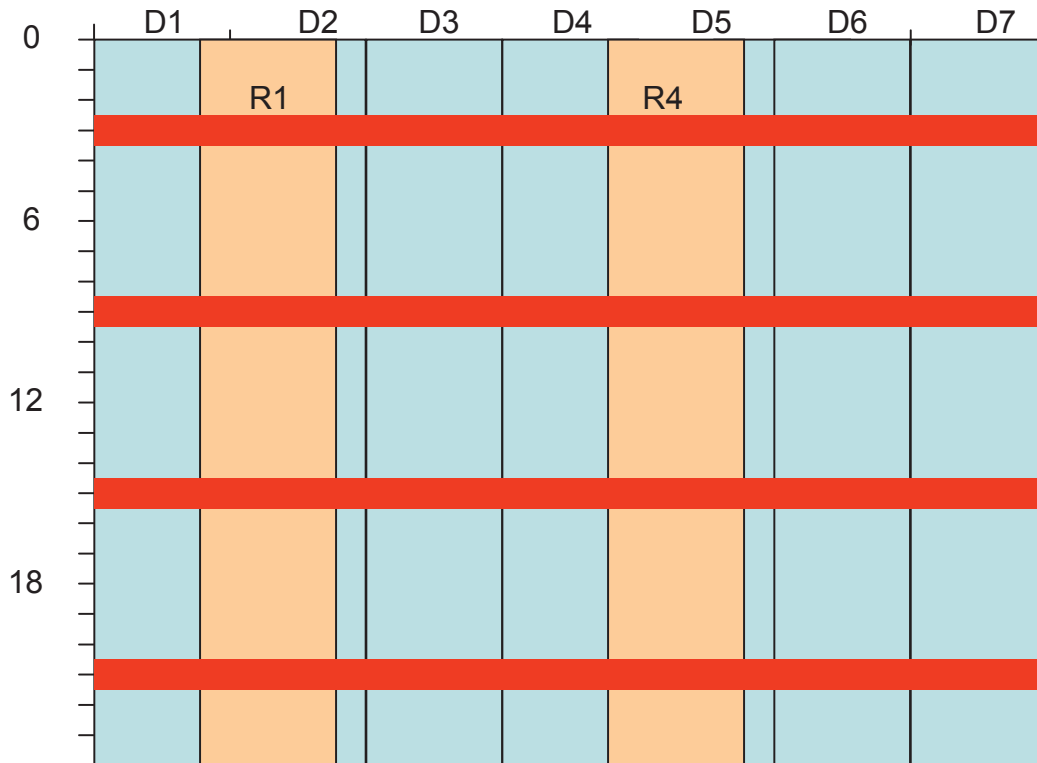


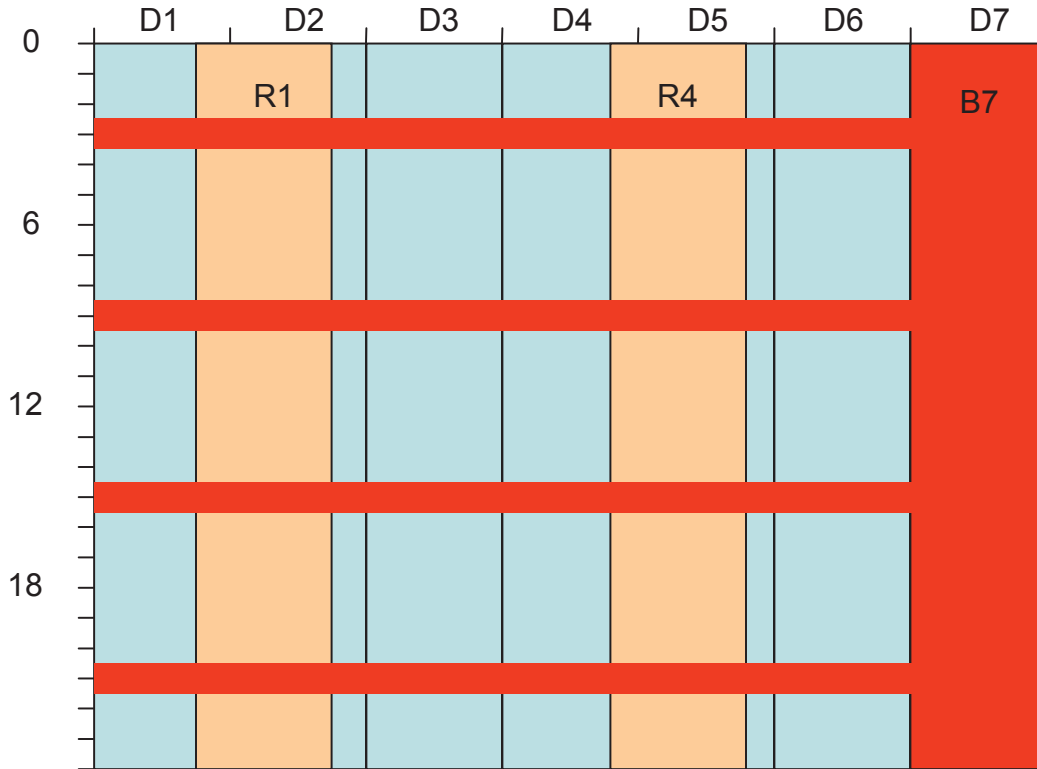
Figure 3. Trials 2 & 3: Sustained Daily VGOS EOP Sessions, May-June and Sept-Oct. Daily hour-long VGOS bursts are represented in red.

**Trial 3:** Repeat of Sustained Daily VGOS EOP Sessions but with Timely Transmission of Data, Sept-Oct. The observations for Trial 2 and Trial 3 are identical (see Figure 3). However, the focus of Trial 3 is the timely transport of data to the correlator. As much as possible, the data will be transported electronically. With this reduced duty cycle mode of operation, a sustained data rate of 500 Mbps will be sufficient to transmit the full 4 hour data volume within a day, even for the fastest antennas. For stations where the required data rate cannot be sustained, media will need to be physically transported. Daily shipment of disk packs only ~15% full is highly inefficient. Efficiency can be increased by transferring data to a single disk before shipping. [Note: In the future, as more hours of data are collected per day, higher data rates will be required with 3 Gbps being sufficient to transmit a full 24 hour session within a day.]

### VGOS Pilot Project in 2016

Given the successful completion of the three sets of trial operations, a VGOS Pilot Project can begin at the start of 2016 and continue throughout the year. The purpose of a pilot project is to gain experience with an operational mode without making a full commitment to product delivery. Operations in this period will be a combination of all aspects of the trial campaigns. There will be a single 24-hour VGOS session per week and daily VGOS EOP sessions on the remaining days (see Figure 4). Data will be

transmitted to the correlator in a timely fashion with as much data transmitted electronically as possible.



*Figure 4. VGOS Pilot Project: One 24-hour VGOS Session and six Daily VGOS EOP Sessions per week, 2016.*

As new VGOS stations come on line, they will initially be qualified by tagging along with the B7nnn 24-hour sessions. This mode of operation leaves six days a week for the newly introduced antenna to deal with problems as they arise. After weekly operations smooth out, the antenna can be added to the daily VGOS EOP sessions.

As more operational resources become available at a particular station, the number of hour-long burst periods at that station can be increased (Figure 5), providing a smooth transition to full 24/7 operation. This can be done on a station-by-station basis, provided enough stations are available to form baselines.

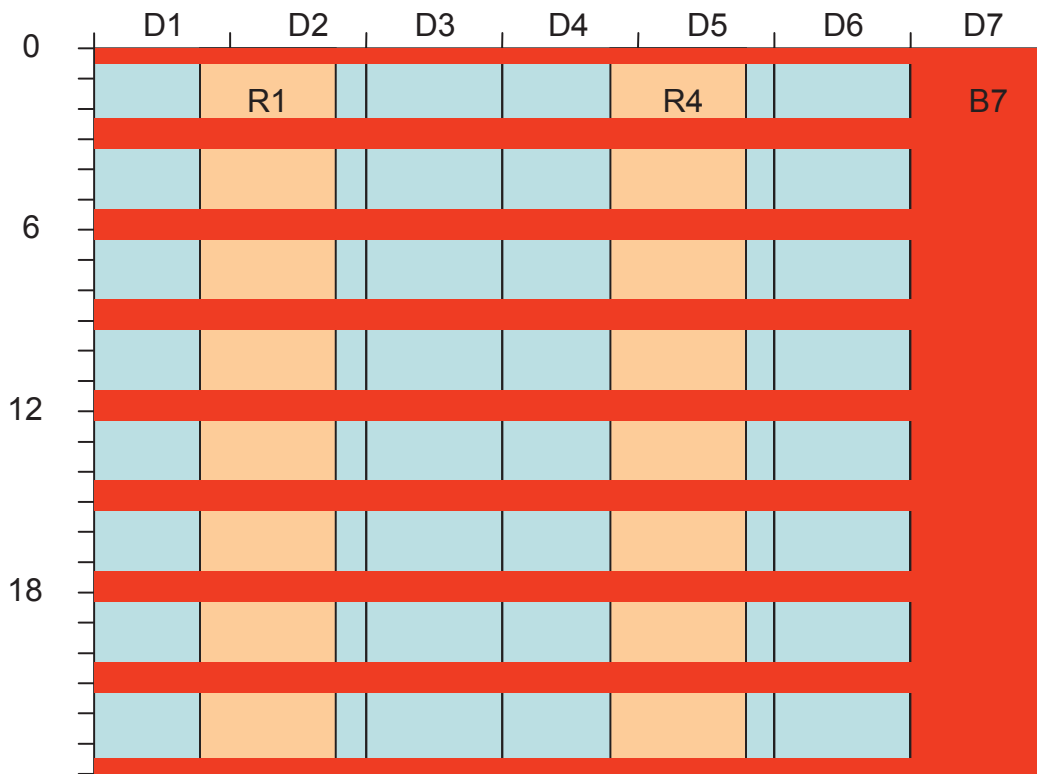


Figure 5. As operational resources increase at a station, the number of hourly bursts can be increased.

### Operations of the VGOS Network in 2017 and Beyond

Given the successful completion of the VGOS Pilot Project in 2016, the pilot project can be converted to standard operations.

By the end of 2017, it is anticipated that a substantial VGOS network will be in place (first column in Table 2 and Figure 6). Based on information available today, the network could include as many as 16 stations, 13 of which will be very fast slewing (full VGOS slew rate) antennas. The four Russian antennas will however operate in S/X/Ka-band mode. The network will be unbalanced geographically with 15 antennas in the Northern Hemisphere, one in the Southern Hemisphere, and a significant concentration in Europe. By the end of 2019 the network will be augmented by Ny Ålesund which will be operational by then; in the same time frame it is expected that the NASA Space Geodesy Project (SGP) will also have constructed a number of new VGOS antennas as part of multi-technique GGOS sites (second column in Table 2 and Figure 7). In terms of antennas available, the list represents a fairly conservative estimate since it mainly counts antenna projects that have already been funded. All the same, it represents a significant extrapolation with respect to the number of antennas outfitted with full broadband systems. This is an area where the V2PEG needs to participate actively by organizing and promoting the acquisition of broadband systems as stations become available.

<b>Station</b>	<b>2017</b>	<b>2019</b>
Yebes	1	1
Santa Maria	1	1
Tenerife	1	1
Flores	1	1
Onsala	2	2
Metsahövi	1	1
Wetzell	2	2
Noto	1	1
Ny Alesund		2
Badary		1
Zelenchukskaya		1
Ussurisk		1
Kaliningrad		1
Kazan	?	?
Ishioka	1	1
Changchun	1	1
Kunming	1	1
Sheshan	1	1
Greenbelt	1	1
Westford	1	1
Kokee	2	2
NASA (new stations)		~3
<b>Total Stations – North Hemisphere</b>	<b>15</b>	<b>23</b>
Hobart		1
Katherine		1
Yarragadee		1
Warkworth		1
Hartebeesthoek	1	1
NASA (new stations)		~2
<b>Total Stations – South Hemisphere</b>	<b>1</b>	<b>7</b>
<b>Total – South and North</b>	<b>16</b>	<b>30</b>

*Table 2. Projection of VGOS broadband network that might be available by 2017 and 2019. [Note: As can be seen in the table, some stations incorporate more than one broadband antenna. Performance benefits are expected at these sites. However, for the purpose of calculating station totals, each pair is considered a single station.]*

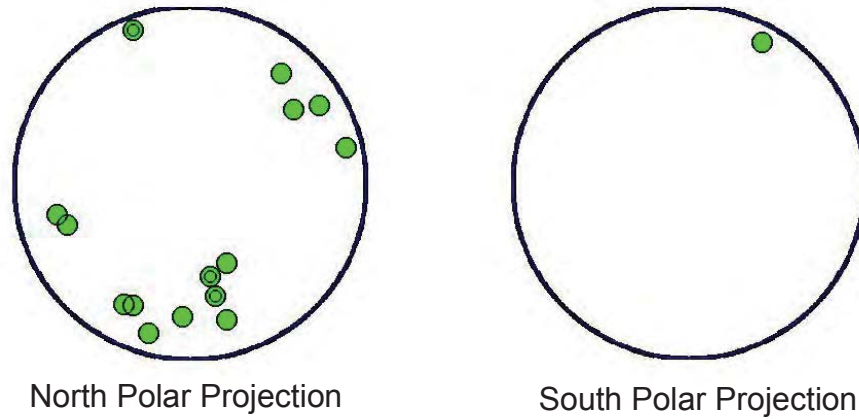


Figure 6. Projected VGOS broadband network at the end of 2017. Concentric circles represent sites that incorporate two broadband antennas.

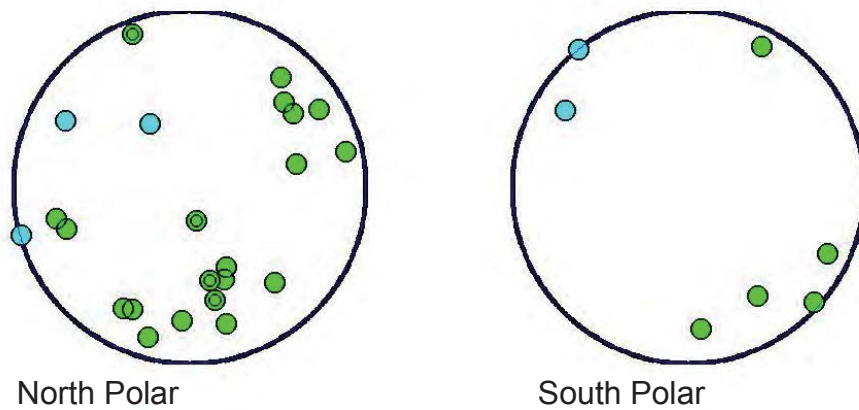


Figure 7. Projected VGOS broadband network for the end of 2019. Concentric circles represent sites that incorporate two broadband antennas. Cyan dots represent new NASA sites hypothetically placed in Colombia, California, and Alaska in the Northern Hemisphere and Brazil and Argentina in the Southern Hemisphere.

Petrachenko B et al.(2009): [Design Aspects of the VLBI2010 System. Progress Report of the VLBI2010 Committee.](#) NASA Technical Memorandum [NASA/TM-2009-214180.](#)



# IVS Coordination







# Coordinating Center Report

Dirk Behrend

**Abstract** This report summarizes the activities of the IVS Coordinating Center during the year 2013 and forecasts activities planned for the year 2014.

## 1 Coordinating Center Operation

The IVS Coordinating Center is based at the Goddard Space Flight Center and is operated by NEOS (National Earth Orientation Service), a joint effort for VLBI by the U.S. Naval Observatory and the NASA Goddard Space Flight Center.

The mission of the Coordinating Center is to provide communications and information for the IVS community and the greater scientific community and to coordinate the day-to-day and long-term activities of IVS.

The Web server for the Coordinating Center is provided by Goddard. The address is

<http://ivscg.gsfc.nasa.gov>.

## 2 Activities during 2013

During the period from January through December 2013, the Coordinating Center supported the following IVS activities:

- Directing Board support: Coordinated, with local committees, two IVS Directing Board meetings, in

---

NVI, Inc.

Coordinating Center

IVS 2013 Annual Report

Metsähovi, Finland (March 2013) and Potsdam, Germany (September 2013). Notes from each meeting were published on the IVS Web site.

- Meetings: Coordinated, with the Local Committee, the seventh IVS Technical Operations Workshop, held at Haystack Observatory in May 2013. Chaired the Program Committee for the meeting.



Fig. 1 Logo of the seventh IVS Technical Operations Workshop.

Coordinated, with the Local Committee, the eighth IVS General Meeting, to be held in Shanghai, China in March 2014. Chaired the Program Committee for the meeting.

- Communications support: Maintained the Web pages, e-mail lists, and Web-based mail archive files. Generated analysis reports and included them into the 24-hour session Web pages. Maintained Intensive session Web pages.

- Publications: Published the 2012 Annual Report in summer 2013. Published three editions of the IVS Newsletter in April, August, and December 2013. All publications are available electronically as well as in print form.
- Observing Program Committee (OPC): Coordinated meetings of the OPC to monitor the observing program, review problems and issues, and discuss changes.
- 2013 Master Schedule: Generated and maintained the master observing schedule for 2013. Coordinated VLBI resources for observing time, correlator usage, and disk modules. Coordinated the usage of Mark 5 systems at IVS stations and efficient deployment of disk modules.
- 2014 Master Schedule: Generated the proposed master schedule for 2014 and received approval from the Observing Program Committee.
- VGOS: Supported the activities for establishing the VLBI Global Observing System (VGOS) through participation in the VLBI2010 Committee (V2C) and the VLBI2010 Project Executive Group (V2PEG).

### 3 CONT14 Campaign

The Continuous VLBI Campaign 2014 (CONT14) is being organized for observation in early May 2014. Sixteen IVS stations (see Figure 2) will observe for 15 consecutive days at a rate of 512 Mbps from 6 - 20 May 2014. The observing will be done on the basis of UT days with each CONT14 day running from 0 UT to 24 UT. UT day observing will allow for the most accurate combination and comparison of results with other techniques.

The Coordinating Center, in collaboration with the OPC, is responsible for:

- the overall planning and coordination of the campaign,
- the media usage and shipment schedule, and
- the preparation of the detailed observing schedules and notes.

More information about the CONT14 campaign can be found on the IVS Web site under the URL <http://ivscc.gsfc.nasa.gov/program/cont14>.



Fig. 2 Geographical distribution of the sixteen CONT14 sites.

### 4 Staff

The staff of the Coordinating Center is drawn from individuals who work at Goddard. The staff and their responsibilities are listed in Table 1.

Table 1 IVS Coordinating Center staff.

Name	Title	Responsibilities
Dirk Behrend	Director	Web site and e-mail system maintenance, Directing Board support, meetings, publications, session Web page monitoring
Cynthia Thomas	Operation Manager	Master schedules (current year), resource management and monitoring, meeting and travel support, special sessions
Frank Gomez	Web Manager	Web server administration, mail system maintenance, Data Center support, session processing scripts, mirror site liaison
Karen Baver	General Programmer and Editor	Publication processing programs, LaTeX support and editing, session Web page support and scripts
Kyla Armstrong	Data Technician	Publications support and Web site support

### 5 Plans for 2014

The Coordinating Center plans for 2014 include the following:

- Maintain IVS Web site and e-mail system.
- Publish the 2013 Annual Report (this volume).

- Coordinate, with the local committee, the eighth IVS General Meeting to be held in Shanghai, China in March 2014.
- Support Directing Board meetings in 2014.
- Coordinate the 2014 master observing schedules and IVS resources.
- Publish Newsletter issues in April, August, and December.
- Support the VGOS activities within the V2C and the V2PEG.

# The 2013 Analysis Coordinator Report

John Gipson

**Abstract** This report presents the IVS Analysis Coordination issues of 2013. The IVS Analysis Coordinator is responsible for generating and disseminating the official IVS products. This requires consistency of the input data by strict adherence to models and conventions.

## 1 Changing of the Guard

In September 2012, Axel Nothnagel gave notice to the IVS Directing Board that he was resigning as the IVS Analysis Coordinator effective February 2013. Axel had been the Analysis Coordinator for 13 years. During this time, the IVS matured from a young, untried organization into a mature organization providing scientific data for use by geodesists and geophysicists. His contributions as Analysis Coordinator were many. The annual IVS Analysis Workshops were an important way for different groups to exchange information and to advance the VLBI technique. Axel's insistence on consistency of models used in different software packages, adherence to the IERS standards, and continual improvement in geophysical modeling resulted in high-quality VLBI data. Fortunately Axel is not going away; instead he took a position with more responsibility. At the IVS Directing Board meeting on March 8, 2014, Axel was elected chair of the IVS Directing Board, and I was elected Analysis Coordinator. I will endeavor to be as successful an Analysis Coordinator as Axel.

---

NVI, Inc./GSFC

IVS Analysis Coordinator

IVS 2013 Annual Report

## 2 IVS Analysis Workshop

Axel's last role as Analysis Coordinator was to chair the "14th IVS Analysis Workshop" held in Helsinki, Finland on Tuesday, March 5, 2013. As always, this workshop provided an informal means for everyone involved in VLBI data processing and analysis to exchange information, voice concerns, and decide how to proceed.

One of the items that surfaced at this meeting was the apparent reversal of time-tags in some recent databases. Explicitly, you would have a situation where two Scans A and B appear in this order in the schedule file, with Scan B starting after Scan A. However, the observations for Scan B had a time tag in the database before Scan A. Further investigation revealed that this only happened with databases that were processed using the DiFX software correlator. This was ultimately traced to the way the DiFX software correlators were handling time-tags; the epoch assigned to all observations in a scan was halfway through the longest observation in the scan. In contrast, the Mark IV correlator used a time-tag which was halfway through the shortest observation in the scan. Roger Cappallo agreed to modify the software difx2mk4 that converted correlator output into a format that could be read by fourfit. That would make the time-tags consistent with the old hardware correlator. Alessandra Bertarini agreed to reprocess some databases using the new time-tags. When these were analyzed using Calc/Solve, the Goddard VLBI group found a slight improvement in session fit. As a consequence of this, all sessions processed after mid-2013 with DiFX use the same time-tag convention as the Mark IV hardware correlator.

The above paragraph is a perfect example of how the IVS Analysis Workshop should run. An issue is raised and discussed. People volunteer to do some work. After further discussion and feedback the VLBI technique is improved. I hope to encourage this sort of activity in future Analysis Workshops.

### 3 ITRF2013

In March 2013, Zuheir Altamini issued a call for participation in ITRF2013 made by Altamini. The last ITRF was generated in 2008. A major difference between the ITRF2008 and the ITRF2013 call for participation was the introduction of changes to the IERS standards. The new IERS standards have better models for high-frequency EOP, UT1 in particular. These include the effects of libration in UT1. The IERS2010 standards also have a different nutation model.

An area of controversy in generating solutions for ITRF2013 is the application of atmospheric pressure loading corrections. VLBI has been a leader in applying atmosphere loading effects, first using local pressure data in the early 1990s to develop empirical loading corrections [1] and then using numerical weather models to determine the a priori loading at a site [2]. In principal there are two ways of applying pressure loading corrections. You could determine the a priori pressure loading corrections at the epoch of the observations and apply them at the observation level. Alternately, you could determine the average pressure loading for a station and apply it a posteriori, after the analysis was done. As [3] shows, there are many arguments that applying a priori pressure loading at the observation level is the correct thing to do. This is exactly what the current generation of VLBI analysis packages does.

It was the strong desire of the IVS Directing Board that the VLBI contribution to ITRF2013 include atmosphere pressure loading effects at the observation level; however GPS does not do so. After extended conversations with Zuheir, I decided to recommend that the VLBI solutions also not apply a priori atmosphere pressure loading. One reason for not doing so was to make it easier for Zuheir to combine results. If VLBI had applied a priori pressure loading, Zuheir would have had to remove the effect of pressure loading using the a posteriori correction before he combined our VLBI results with those of other techniques. By not

including the effect of atmosphere pressure loading at the observation level, we reduce the chance that errors would be made in removing it.

In preparation for the VLBI solution to ITRF2013 I wrote submission instructions and a submission checklist. I drew upon instructions that Axel had sent out for ITRF2008. Unlike ITRF2008, I asked Analysis Centers to submit their solutions to the IVS Data Centers. That way all of the data submitted is publicly available. Frank Gomez at GSFC wrote and debugged scripts to handle the submissions. Karen Bayer, also at GSFC, helped to design an ITRF2013 web page, <http://lupus.gsfc.nasa.gov/IVS-AC.ITRF2013.htm> which gathers all information related to VLBI submissions for ITRF2013.

### 4 Analysis Coordinator Web Pages

One of the first things I did as Analysis Coordinator was, together with Karen Bayer, to design a set of IVS Analysis Coordinator Web pages, accessible through [http://lupus.gsfc.nasa.gov/IVS-AC\\_contact.htm](http://lupus.gsfc.nasa.gov/IVS-AC_contact.htm). Our starting point was the excellent AC Web site of Axel Nothnagel. My long term goal for these pages is to gather all VLBI data required or useful for VLBI solutions. Examples include information about the sources, stations, etc, as well as links to other sites, for example the IERS. If there is information that you think should be on this page, please let me know.

### 5 Conclusions

At the end of 2013, I completed my first ten months as the Analysis Coordinator, and I still have much to learn. This is a position with a lot of responsibility — both within IVS and outside of IVS. One goal is to promote the advancement of the VLBI technique with the IVS — making sure that we use the best models, making sure that our data is of high quality, and encouraging new ways of doing things. Another goal is to promote the use of VLBI data to the broader scientific community. This is an impossible task for one person to do alone, and I am aided in this by people both within Goddard and within the wider IVS community.

I welcome your support and suggestions on how I can do things better.

## References

1. MacMillan, D. S. and J. M. Gipson, Atmospheric Pressure Loading Parameters from Very Long Baseline Interferometric Observations. *J. Geophys. Res.*, 99, 1994. pp. 18,081.
2. Petrov L., J. P. Boy, Study of the Atmospheric Pressure Loading Signal in VLBI Observations, *Journal of Geophysical Research* Vol. 109, No. B03405, 2004.
3. Böhm, J., Heinkelmann, R., Cervera, P., Pany, A., Schuh, H. Atmospheric Loading Corrections at the Observation Level in VLBI Analysis. *Journal of Geodesy*, 2009, 83: 1107-1113.

# Network Coordinator Report

Ed Himwich, Rich Strand

**Abstract** This report includes an assessment of the network performance in terms of lost observing time for the 2013 calendar year. Overall, the observing time loss was about 16.2%, which is about 4% higher than the previous year due primarily to scheduled antenna maintenance. A table of relative incidence of problems with various subsystems is presented. The most significant identified causes of loss were the scheduled antenna maintenance (accounting for about 40% of the losses), followed by electronics rack problems (20%), miscellaneous problems (9%), receiver problems (8%), and RFI (6%). About 6% of the losses occurred for unknown reasons. New antennas are under development in the USA, Germany, and Spain. There are plans for new telescopes in Norway and Sweden. Other activities of the Network Coordinator are summarized.

## 1 Network Performance

The overall network performance was for the most part good. As was the case last year, we have returned to reporting a detailed assessment, which was not provided for 2010 and 2011.

This network performance report is based on correlator reports for experiments in calendar year 2013. This report includes results for the 159 24-hour experiments that had detailed correlator reports available as of March 4, 2014. The data set examined includes approximately 515,000 dual frequency observations. Re-

sults for 29 experiments were omitted because either they were correlated at the VLBA, they were not correlated yet, or correlation reports were not available on the IVS data centers. Experiments processed at the VLBA correlator were omitted because the information provided for them is not as detailed as that from Mark IV correlators. The experiments that were not correlated or did not have correlator reports available yet include some JADE, CRF, APSG, AUST13, OHIG, R&D, T2, and EUR experiments. In summary, roughly 90% of the data from scheduled 24-hour experiments for 2013 are included in this report. That is similar to the coverage of reports for many previous years.

An important point to understand is that in this report, the network performance is expressed in terms of lost observing time. This is straightforward in cases where the loss occurred because operations were interrupted or missed. However, in other cases, it is more complicated to calculate. To handle this, a non-observing time loss is typically converted into an equivalent lost observing time by expressing it as an approximate equivalent number of recorded bits lost. As an example, a warm receiver will greatly reduce the sensitivity of a telescope. The resulting performance will be in some sense equivalent to the station having a cold receiver but observing for (typically) only one-third of the nominal time and therefore recording the equivalent of only one-third of the expected bits. In a similar fashion, poor pointing can be converted into an equivalent lost sensitivity and then equivalent fraction of lost bits. Poor recordings are simply expressed as the fraction of total recorded bits lost.

Using correlator reports, an attempt was made to determine how much observing time was lost at each station and why. This was not always straightforward to do. Sometimes the correlator notes do not indicate

---

NASA Goddard Space Flight Center

IVS Network Coordinator

IVS 2013 Annual Report

that a station had a particular problem, while the quality code summary indicates a significant loss. Reconstructing which station or stations had problems—and why—in these circumstances does not always yield accurate results. Another problem was that it is hard to determine how much RFI affected the data, unless one or more channels were removed and that eliminated the problem. It can also be difficult to distinguish between BBC and RFI problems. For individual station days, the results should probably not be assumed to be accurate at better than the 5% level.

The results here should not be viewed as an absolute evaluation of the quality of each station's performance. As mentioned above, the results themselves are only approximate. In addition, some problems such as weather and power failures are beyond the control of the station. Instead the results should be viewed in aggregate as an overall evaluation of what percentage of the observing time the network is collecting data successfully. Development of the overall result is organized around individual station performance, but the results for individual stations do not necessarily reflect the quality of operations at that station.

Since stations typically observe with more than one other station at a time, the average lost observing time per station is not equal to the overall average loss of VLBI data. Under some simplifying assumptions, the average loss of VLBI data is roughly twice the average loss of station observing time. This approximation is described in the Network Coordinator's section of the IVS 2001 Annual Report. For 2013, this agrees reasonably well with the number of (single frequency: S or X) single baseline observations on which the correlator reported failure, approximately 36%, but other factors, particularly the dual frequency nature of useful geodetic observations, complicate the picture. For 2013, the actual percentage of data (dual frequency) that was not included by the analysts was approximately 41%. This is even larger (by approximately 5%) than the single baseline observations reported lost by the correlator. It is expected that this number should be higher both because of the dual frequency nature of the final observable and the fact that analysts use additional criteria beyond what is discussed here to decide when to exclude observations. However, it means in effect that only about 59% of the observations we attempted to collect were useful.

For the 159 experiments from 2013 examined here, there were 1,432 station days or approximately 9.0 sta-

tions per experiment on average. This compares to 148 experiments considered in the report for 2011, which included 1,261 station days with 8.5 stations per experiment. The increase in the number of analyzed experiments mostly reflects the increase in the number of experiments from 2013. The increase in the average number of stations per experiment is due to the scheduling of large networks in experiments. Of the station days for 2013, approximately 16.2% (or approximately 231 days) of the observing time was lost, which is about 4% higher than last year. For comparison to reports from earlier years, please see Table 1.

**Table 1** Lost observing time.

Year	Percentage
1999-2000*	11.8
2001	11.6
2002	12.2
2003	14.4
2004	12.5
2005	14.4
2006	13.6
2007	11.4
2008	15.1
2009	21.5
2012	12.3
2013	16.2

\* The percentage applies to a subset of the 1999-2000 experiments.

Percentages for 2010 and 2011 are omitted but should be 10-20%.

The lost observing time for 2013 is in line with results from 2012 and years before 2009. The results for 2009 may be artificially high due to a change in the way the results were tabulated for that year. We believe this year's calculations are more in line with how they were made before 2009.

An assessment of each station's performance is not provided in this report. While individual station information was presented in some previous years, this practice seemed to be counter-productive. Although many caveats were provided to discourage people from assigning too much significance to the results, there was feedback that suggested that the results were being over-interpreted. Additionally, some stations reported that their funding could be placed in jeopardy if their performance appeared bad, even if it was for reasons beyond their control. Last and not least, there seemed to



be some interest in attempting to “game” the analysis methods to apparently improve individual station results. Consequently, only summary results are presented here. Detailed results are presented to the IVS Directing Board. Each station can receive the results for their station by contacting the Network Coordinator (Ed.Himwich@nasa.gov).

For the purposes of this report, the stations were divided into two categories: **large N**: those that were included in 25 or more network experiments among those analyzed here and **small N**: those in 16 or fewer (no stations were in the 17-24 experiment range). The distinction between these two groups was made on the assumption that the results would be more meaningful for the stations with more experiments. The average observing time loss from the large N group was much smaller than the average from the small N group, 14.6% versus 26.0%. There are many more station days in the large N group than the small N group, 1,306 versus 161, so the large N group is dominant in determining the overall performance.

There are 22 stations in the large N group. Ten stations observed in 50 or more experiments. Of the 22 stations, 13 successfully collected data for approximately 90% or more of their expected observing time. Four more stations collected 80% or more of the time. Four more stations collected data about 70% or more of the time. The remaining stations collected data for about 42% of their observing time. These results are not significantly different from previous years.

There are 24 stations in the small N group. The range of lost observing time for stations in this category was 0%-100%. The median loss rate was approximately 15%, a little worse than last year.

The losses were also analyzed by sub-system for each station. Individual stations can contact the Network Coordinator (Ed.Himwich@nasa.gov) for the sub-system breakdown (and overall loss) for their station. A summary of the losses by sub-system (category) for the entire network is presented in Table 2. This table includes results since 2003 sorted by decreasing loss in 2012.

The categories in Table 2 are rather broad and require some explanation, which is given below.

**Antenna** This category includes all antenna problems, including mis-pointing, antenna control computer failures, non-operation due to wind, and me-

chanical breakdowns of the antenna. It also includes scheduled antenna maintenance.

**Clock** This category includes situations where correlation was impossible because the clock offset either was not provided or was wrong, leading to “no fringes”. Maser problems and coherence problems that could be attributed to the Maser were also included in this category. Phase instabilities reported for Kokee were included in this category. DBBC clock errors are included in this category.

**Miscellaneous** This category includes several small problems that do not fit into other categories, mostly problems beyond the control of the stations, such as power (only prior to 2012), (non-wind) weather, cables, scheduling conflicts at the stations, and errors in the observing schedule provided by the Operation Centers. For 2006 and 2007, this category also includes errors due to tape operations at the stations that were forced to use tape because either they did not have a disk recording system or they did not have enough media. All tape operations have since ceased. This category is dominated by weather and scheduling conflict issues.

**Operations** This category includes all operational errors, such as DRUDG-ing the wrong schedule, starting late because of shift problems, operator (as opposed to equipment) problems changing recording media, and other problems.

**Power** This category includes data lost due to power failures at the sites. Prior to 2012, losses due to power failures were included in the Miscellaneous category.

**Rack** This category includes all failures that could be attributed to the rack (DAS), including the formatter and BBCs. There is some difficulty in distinguishing BBC and RFI problems in the correlator reports, so some losses are probably mis-assigned between the Rack category and the RFI category.

**Receiver** This category includes all problems related to the receiver, including outright failure, loss of sensitivity because the cryogenics failed, design problems that impact the sensitivity, LO failure, and loss of coherence that was due to LO problems. In addition, for lack of a more clearly accurate choice, loss of sensitivity due to upper X-band Tsys and roll-off problems were assigned to this category.

**Recorder** This category includes problems associated with data recording systems. Starting with

**Table 2** Percentage of observing time lost by sub-system.

Sub-System	2013	2012	2009	2008	2007	2006	2005	2004	2003
Antenna	39.6	18.1	29.4	19.2	34.6	19.0	24.4	32.9	17.8
Rack	19.5	21.8	6.6	8.7	11.4	16.3	5.1	6.8	5.0
Miscellaneous	9.4	6.9	15.3	12.8	7.6	18.0	8.0	8.0	6.0
Receiver	7.7	11.7	18.6	13.8	14.9	20.8	24.2	18.0	25.2
RFI	6.4	11.8	5.9	14.8	10.4	11.6	6.2	5.0	9.3
Unknown	5.7	14.2	14.2	17.7	14.9	4.0	3.3	10.1	12.6
Clock	3.5	1.8	1.9	0.5	0.3	4.9	14.5	0.5	3.4
Recorder	3.3	5.7	2.9	4.1	4.6	3.3	8.9	11.1	10.9
Operations	2.5	2.0	1.2	2.3	0.0	2.0	4.7	6.1	3.6
Software	1.0	0.3	0.1	0.1	0.4	0.1	0.5	0.1	0.1
Shipping	0.9	3.6	4.0	5.4	1.0	0.0	0.2	1.4	6.1
Power	0.4	2.1							

Percentages for 2010 and 2011 were not calculated.

2006, no problems associated with tape operations are included in this category.

**RFI** This category includes all losses directly attributable to interference, including all cases of amplitude variations in individual channels, particularly at S-band. There is some difficulty in distinguishing BBC and RFI problems in the correlator reports, so some losses are probably mis-assigned between the Rack category and the RFI category.

**Shipping** This category includes all observing time lost because the media were lost in shipping or held up in customs or because problems with electronic transfer prevented the data from being correlated with the rest of the experiment's data.

**Software** This category includes all instances of software problems causing observing time to be lost. This includes crashes of the Field System, crashes of the local station software, and errors in files generated by DRUDG.

**Unknown** This category is a special category for cases where the correlator did not state the cause of the loss and it was not possible to determine the cause with a reasonable amount of effort.

Some detailed comments on the most significant issues for this year's data loss are given below.

- The largest source of data loss for 2013 was antenna related at 39.6%, up from 18.1% last year. This includes losses for antennas that were down for scheduled maintenance, particularly Tsukuba and Wettzell, which account for about 80% of the loss in this category. Both observatories are used in

the R1 and R4 experiments each week. The losses due to these two scheduled maintenance periods account for most of the increase in this category from last year and most of the increase in the overall loss for the whole network.

- The data rack was the next largest source of loss at 19.5%, about the same as last year. This loss was usually caused by missing channels due to broken converters or samplers. Many were repaired this year after it was undertaken to bring all stations up to all 14 working converters. The increased availability of spare parts for old systems as stations make the switch to digital back-ends helped complete this project. AuScope and Warkworth contributed data rack loss caused by the DBBC. Early reports for 2014 indicate these systems are now stable.
- The Miscellaneous category is a little higher at 9.4% from 6.9% in 2012 due primarily to Westford's use for broadband testing of the new VGOS system. This added 12 station days of loss for 2013.
- Receiver problems contributed about 7.7% to the overall loss. The was mostly due to cryogenics issues at Fortaleza, which have since been repaired.
- RFI contributed about 6.4% — down from 11.8% of station days loss — almost all in S-band due to commercial systems. The stations with the most significant RFI losses are Fortaleza, Medicina, and Matera.
- The proportion of losses attributed to Unknown, RFI, and Receiver decreased this year, primarily because of improvements in classifying the cause of losses

Overall, while the network operated well for the most part, there are a few notable issues (in alphabetical order of station), while some situations improved from the previous year:

- Crimea had a problem related to a previous repair of a sampler. This caused the lower four channels of X-band to be lost in 2013. The problem was found and repaired.
- Fortaleza had a significant cryogenic problem, which has since been repaired.
- Hobart12 and Hobart26 have a new and serious RFI issue.
- Hobart, Katherine, and Yarragadee timing issues in the DBBCs have improved due to local maintenance work including improved grounding.
- Kokee Park had a power outage that caused some damage that was difficult to repair. The station was able to observe with somewhat reduced sensitivity until the repair was completed.
- Matera's Mark 5 samplers for S-band channels 5 and 6 were repaired. A rare and intermittent unidentified loss of fringes from 2012 and 2013 were diagnosed in 2014 as being due to the first LO unlocking and re-locking at the wrong frequency due to a power supply issue. This has been repaired.
- The cryogenic system in the receiver at Medicina was repaired on September 2013 (after initially failing in November 2011). The station is now able to observe with normal sensitivity.
- TIGO has shown higher than normal SEFDs for several years. There has been no success in resolving this issue.
- The Tskuba32 telescope underwent scheduled antenna maintenance for a period of several weeks.
- Warkworth lost a few station days due to a maser failure.
- The Westford azimuth antenna drives continue to trip off sometimes when the site is unattended. They also lost several days supporting broadband testing and a few days for a maser failure.
- The Wettzell telescope underwent scheduled antenna maintenance for a period of several weeks.
- Yarragadee lost several days due to a filter problem in their DBBC. This has been repaired.

## 2 New Stations

There are prospects for new stations on several fronts. These include (in approximate order of how soon they will start regular observations):

- At Wettzell in Germany, the new Twin Telescope Wettzell (TTW) for VGOS has been commissioned.
- At GSFC in the USA, a new 12-m antenna has been erected and is undergoing testing. While this antenna is primarily for use in the development of the VGOS system, it is expected that it will eventually join the network for regular observing.
- South Korea has a new antenna for geodesy at Sejong, built by the National Geographic Information Institute (NGII). There is also interest in geodetic use of the Korean VLBI Network (KVN), which consists of three stations intended primarily for astronomy.
- At Arecibo in Puerto Rico, a new 12-m antenna has been erected and is expected to be used for geodetic observing.
- In Spain/Portugal, the RAEGE (Atlantic Network of Geodynamical and Space Stations) project aims to establish a network of four fundamental geodetic stations including radio telescopes that will fulfill the VGOS specifications: Yebes (1), Canary Islands (1), and Azores (2).
- In Norway, the Norwegian Mapping Authority (NMA) is in the process of procuring a twin telescope.
- Onsala has applied for funds for a twin telescope system.
- In Russia, an effort is underway to get 12-m VGOS antennas at some of the QUASAR network sites.
- There is interest in India in building a network of four telescopes that would be useful for geodesy.
- Saudi Arabia is investigating having a combined geodetic observatory, which would presumably include a VLBI antenna.
- Colombia is investigating having a combined geodetic observatory, which would presumably include a VLBI antenna.

Many of these antennas will become available for use in the next few years. Efforts are being made to ensure that these antennas will be compatible with VGOS.

### 3 Network Coordination Activities

Network coordination involved dealing with various network and data issues. These included:

- Reviewing all experiment “ops” messages, correlator reports, and analysis reports for problems and working with stations to resolve them
- Responding to requests from stations for assistance
- Identifying network station issues and working with the IVS Coordinating Center and the stations to resolve them. This year these included:
  - Encouraging timely delivery of log files
  - Providing a DBBC Validation Plan
  - Maintaining the FS PC kernel
- Participating in development of the new VEX2 schedule file standard.
- Providing catalog update information for station equipment and track lay-outs.
- Recognizing and reporting DBBC issues to station observing staff.
- Reviewing Mark 5 recording error checks for problems and informing correlator staff and station staff.
- Assisting in troubleshooting the Kokee X-band IF failure.
- Troubleshooting power supplies and identifying the correct parts for shipping.
- Troubleshooting video converters and organizing shipments to stations.
- Providing telescope pointing analysis and advice.
- Support, including software development, for the 12-m antenna at GSFC and VGOS observing system.

- Updating Network Station configuration files.
- Helping to coordinate a Mark 5A/5B firmware update for large module directories and bigger disks.
- Helping to plan and support CONT14 observing.
- Providing support, including software development, for the 12-m antenna at GSFC and the VGOS observing system.
- Other activities as needed.

### 4 Future Activities

Network coordination activities are expected to continue next year. The activities will largely be a continuation of the previous year’s activities:

- Reviewing all experiment “ops” messages, correlator reports, and analysis reports for problems and working with stations to resolve them.
- Responding to requests from stations for assistance.
- Identifying network station issues and working with the IVS Coordinating Center and the stations to resolve them.

# IVS Technology Coordinator Report

Bill Petrachenko

**Abstract** Highlights of IVS technology development of the past year are summarized. This includes VGOS technology development, mixed mode observing issues, global VLBI standards, the VGOS technical committee (VTC) and its Wiki, the 2nd International VLBI Technology Workshop (IVTW), and the IVS Geodetic VLBI School.

## 1 VGOS Observing Plan

Over the past year, the VGOS Project Executive Group (VPEG) developed an observing plan to guide the transition from current S/X to future VGOS broadband operations. The plan spans five years. It begins with a series of test campaigns in 2015 with as many as eight sites expected to participate. IVS technology development over the next year focuses on ensuring that systems and processes are ready for the test campaigns.

Each campaign introduces a different aspect of the new VGOS mode of operation so that by 2016 the IVS will be ready to begin the VGOS pilot project. All campaigns will be roughly six weeks in duration to exercise the full “schedule to final products” operational chain in a sustained format.

- The first campaign focuses on automation of processes unique to broadband operations. It uses a single 24-hour session per week, which has the benefit of allowing six days per week to prepare for the

next session. Data will be recorded and shipped after each session.

- The second campaign focuses on producing a full set of EOP products on a daily basis. It involves observing four hours per day in equispaced one-hour bursts. As with the first campaign, data will be recorded and shipped once per week.
- The final campaign focuses on producing initial EOP products within 24 hours. Observationally, it will be identical to the second campaign but with the exception that data will be e-transferred instead of being shipped.

## 2 VGOS Technology Development

Development of the VGOS broadband system began in a serious way in about 2008 when the Eleven Feed was identified as a suitable candidate for use in the next generation VLBI system. As a result of work carried out in the subsequent years, the system is now in a useable state although not completely finalized. Several broadband test sessions were carried out on the ~600 km Westford to GGAO baseline with the first 24-hour geodetic session having been carried out in late May 2013.

The new broadband system required nearly a complete reworking of the legacy S/X system including the frontend, backend, and even the connection between them. There has been significant progress over the past year in a number of areas.

---

Canadian Geodetic Survey, Natural Resources Canada

IVS Technology Development Coordinator

IVS 2013 Annual Report

## 2.1 Broadband Feeds

It is no surprise that active research into broadband feeds continues today because it is one of the key technological innovations that makes the new VGOS broadband system possible. The workhorse feeds for the Westford/GGAO broadband baseline are Quadridge Feed Horns (QRFH) developed at CalTech. These feeds perform at a high level, are cost effective and are easy to integrate into cryogenic front ends. So far they are the only broadband feeds that have been successfully deployed in a working VGOS system. Although the QRFH is naturally a dual linear polarization feed, circular polarization is handled more naturally by VLBI and is hence preferred. Chris Beaudoin recently suggested a method for effectively combining the QRFH linear outputs, post-LNA, into dual circular outputs. There is also an Auscope/Callisto collaboration to build a QRFH feed into a cryogenic system based on a Stirling cycle cooler. This configuration promises to be cost effective, to be very low maintenance, and to still meet the VGOS SEFD spec when used with a 12-m antenna.

Work continues on the integration of the Eleven Feed developed at Chalmers University into a cryogenic front end; a broadband feed developed in Italy is being tested at Noto, and an innovative conical feed that naturally produces circular polarized output is being proposed for the Spanish/Portuguese RAEGE antennas.

## 2.2 Digital-backends (DBEs)

Digital-backend (DBE) development continues in China, Europe, Japan, Russia, and the United States. A VLBI Digital-backend Intercomparison Workshop was conducted at Haystack Observatory in October 2012 to test inter-compatibility between independently developed DBE units. The results were very positive showing that in most cases the systems can operate successfully together.

In addition, to help understand the similarities and differences between various DBEs, a document named the VLBI Receiver Back End Comparison, in which the features of all known DBEs are compared in a table, was produced. The document can be found on the IVS Website and the VTC Wiki. Of the DBEs compared,

the ROACH-based DBE (RDBE) and DBBC2010 were the most applicable to the VGOS system.

Gino Tuccari is prototyping a new cutting edge DBE system, the DBBC3-H, in which an 8-bit 28 Gbps digitizer samples the complete VGOS 2-14 GHz RF spectrum. Unfortunately, the project has been delayed due to a requirement by the manufacturer that only very large orders will be filled. To get around this problem, Gino is looking into the possibility of a joint order with the the Square Kilometer Array (SKA). In the meantime he is moving forward with a less aggressive broadband sampler, the DBBC3-L, which needs to be coupled with external analog electronics in order to satisfy VGOS requirements.

## 2.3 The Mark 6 Data System

The Mark 6 data system is now ready to enter operational service. It is an excellent fit for VGOS. It can accept data at the VGOS data rate of 16 Gbps, writing it directly into a 30 s RAM buffer and then moving it from the buffer to a (single) disk pack at a sustained rate just under 8 Gbps. With proper care in the development of a schedule it should be easy to ensure that the buffer is ready to be refilled by the time the VGOS antenna has slewed to the next source. This mode of operation opens the possibility of writing a complete 24-hour VGOS session onto a single 32 Tbyte disk pack that is very efficient for media shipment.

## 2.4 Delay Calibrator

Phase calibration (PCAL) has always been an important aspect of geodetic VLBI, required both to account for independent local oscillator (LO) offsets and to compensate for delay and phase drifts in the system. It was hoped that the advent of DBEs, with their deterministic linear phase response, would reduce the dependence on PCAL. But for the VGOS broadband system where phase is connected between bands, the need for PCAL is as great as ever.

A modern PCAL pulse generator has recently been successfully designed and deployed. However, PCAL performance is also limited by the stability of the reference signal that drives the pulse generator. The stability

of this signal is corrupted by thermal and mechanical drifts in the cable that connects the hydrogen maser frequency reference to the pulse generator (which is typically located near the receiver frontend). Although it was initially hoped that a very stable cable could be found for this purpose, tests over the past year have shown that the required stability could not be achieved.

As a result, a next generation delay calibrator system is under development at Haystack Observatory. The principle behind the new system is very similar to that of the old Mark 3 delay calibrator, although detailed implementation is significantly different. Initial tests indicate that performance of the new design already nearly meets VGOS requirements.

## 2.5 Correlator

Although a number of different types of correlators are currently used for geodetic VLBI, the most commonly used is the DiFX software correlator. DiFX was originally developed at Swinburne University in Australia by Adam Deller for use in astronomical VLBI. As its popularity increased, a global DiFX user group was formed to coordinate continued improvements and additions. A recent addition is an interface that allows DiFX output to be input to the Mark IV post-correlation software. This opened the door for the use of DiFX in geodetic VLBI, and since then DiFX correlators have become operational at the Bonn, Haystack, and Washington IVS Correlation Centers. Features that benefit geodetic VLBI continue to be added to DiFX, but equally important are the additions to the Mark IV post-correlation software that are needed to handle VGOS broadband modes. Some noteworthy additions include: the use of all available PCAL tones to seamlessly connect interferometer phase across the full 2-14 GHz input frequency range; the use of a total electron content (TEC) search parameter to account for the curvature of phase vs. frequency caused by the ionosphere; and the addition of the ability to form a pseudo total intensity observable out of the linear polarized outputs that are naturally produced by broadband QRFH feeds. New features continue to be added to both DiFX and the post correlation software, and these are tested using data from the Westford/GGAO broadband baseline.

## 3 Mixed Mode Observing

In order to establish robust geodetic ties between new broadband stations and the legacy S/X network, a series of observing sessions that include both broadband and S/X stations is required. These sessions are referred to as mixed mode sessions. There is nothing fundamental that makes these sessions difficult. However, in practice they are complicated by restrictions built into the details of the systems being used. There are a number of different types of backends that need to be considered: analog Mark IV; analog VLBA; DBBC in either digital down converter (DDC) or polyphase filter bank (PFB) mode; and RDBE in DDC or PFB mode. Beyond that, S/X stations use a number of different fixed IF down conversion schemes. This proliferation of backends and down conversion schemes makes compatibility in terms of net LO frequency, sideband, and channel bandwidth difficult to achieve. To help navigate these issues, a document was prepared entitled Mixed Mode (Broadband vs. S/X) Configuration Issues. It can be found on the VTC Wiki. Many of these incompatibilities can be handled in the correlator, but for now most of the relevant correlator features are not yet fully tested.

Mixed mode observing also suffers from a sensitivity issue. VGOS broadband antennas are generally smaller than S/X antennas (which was done to make it easier for them to achieve high slew rates). For VGOS observations, this lack of sensitivity is more than compensated by the 16 Gbps instantaneous VGOS data rate. But when VGOS antennas co-observe with S/X antennas, data rate is limited to less than 1 Gbps by the S/X systems. This results in long on-source periods for mixed mode baselines, and this in turn degrades schedules and geodetic performance. The obvious solution is to increase the S/X data rate. However, this is currently not possible because the analog systems still commonly used at many S/X sites are operationally limited to 8 MHz channel bandwidths which corresponds to a maximum total data rate of about 1 Gbps. To solve this problem there is currently an effort to decommission analog systems and replace them with DBEs.

## 4 Global VLBI Standards

Over the past decade, the previous IVS Technology Coordinator, Alan Whitney, did a great service by coordinating the definition of a number of Global VLBI standards, including VSI-H, VSI-S, VDIF, VDIF2, and VTP. Most recently it was recognized that VEX, the pseudo-language that describes the detailed configuration of each station (as well as the schedule of observations), needs to be upgraded to handle new components that are part of the VGOS system. For obvious reasons, VEX2, the next generation VEX program, must be in place before automation of VGOS processes (which in turn is required to reduce operational costs and hence enable the VGOS goal of 24/7 operation) can begin. VEX2 is now nearly complete; its imminent release is eagerly awaited.

## 5 The VGOS Technical Committee (VTC) and its Wiki

The VLBI2010 Committee (V2C), was established in 2006 to encourage the realization of VLBI2010. Over the years its focus narrowed towards the technical aspects of the next generation system with the following seven main topic areas identified: system development, RFI, automation, schedule optimization, source structure, site ties, and the atmosphere. Recently, to reflect the approaching transition to the operational phase of the project, the name of the committee was changed to the VGOS Technical Committee (VTC).

As more VGOS systems are designed and built, there is an increasing need for communication and coordination between groups. To serve this purpose, the VTC established a Wiki that can be found at <https://wikis.mit.edu/confluence/display/VTC/Home>. Wiki contributions related to all VGOS activities are welcome. Everyone is encouraged to access the wiki to learn about VGOS developments. But its usefulness obviously depends on the quality and completeness of the information on it. So please think about what documents you have that might be of interest to the VGOS world. For more information on the Wiki, please see the related article written by Brian Corey in the April 2014 issue of the IVS Newsletter.

## 6 2nd International VLBI Technology Workshop (IVTW)

The 2nd IVTW was hosted by the Korean Astronomy and Space Science Institute (KASI) at Seogwipo on Jeju Island, South Korea. The workshop focused on four topics: station status reports, e-VLBI/Science, wideband developments, and frequency standards. Attendees at this very well organized workshop were treated to a field trip to the nearby 21-m Tamna radio telescope which is an element in the Korean VLBI Network (KVN).

The 3rd IVTW will be held on November 10-13, 2014 at JIVE, Groningen, Netherlands. I encourage anyone who is interested in VLBI technology to attend this very informative and useful workshop. Strong representation from the IVS will ensure that geodetic VLBI has a voice in defining a coherent direction for global multidisciplinary VLBI technology development.

## 7 Geodetic VLBI School at Aalto University

On March 2-5, 2013, just prior to the 21st EVGA Working Meeting, a geodetic VLBI school was held at Aalto University, Espoo, Finland. The school was sponsored by the IVS, the EGU, Onsala Observatory, the Finnish Geodetic Institute, Aalto University, and RadioNet. It was part of the activities of IVS Working Group 6, "VLBI Education", led by Rüdiger Haas.

Lectures and exercises were prepared on a wide range of topics from Radio Telescopes, Feed Horns, and Receivers to the Terrestrial Reference Frame. It was an opportunity for young participants to get a broad introduction to the field and at the same time for technology experts to learn about analysis and vice versa. Since this was the first running of the school, an important result was the production of learning material on a broad range of topics related to geodetic VLBI. It was agreed that a school of this type should be held roughly every three years.



# Network Stations





# Badary Radio Astronomical Observatory 2013 IVS Annual Report

Sergey Smolentsev, Valery Olifirov

**Abstract** This report provides information about the Badary network station: general information, facilities, staff, present status, activities during 2013, and outlook.

## 1 General Information

The Badary Radio Astronomical Observatory (Figure 1) was founded by the Institute of Applied Astronomy (IAA) as one of three stations of the Russian VLBI network QUASAR. The sponsoring organization of the project is the Russian Academy of Sciences (RAS). The Badary Radio Astronomical Observatory is situated in the Republic Buryatia (East Siberia) about 130 km east of Baikal Lake (see Table 1). The geographic location of the observatory is shown on the IAA RAS Web site (<http://www.ipa.nw.ru/PAGE/rusipa.htm>). Basic instruments of the observatory are a 32-m radio telescope equipped with special technical systems for VLBI observations, GPS/GLONASS/Galileo receivers, a DORIS antenna, and an SLR system.

**Table 1** Badary Observatory location and address.

Longitude	102°14'
Latitude	51°46'
<hr/>	
Republic Buryatia	
671021, Russia	
oper@badary.ipa.stbur.ru	

Institute of Applied Astronomy of RAS

Badary Network Station

IVS 2013 Annual Report



**Fig. 1** Badary observatory.

## 2 Technical Staff

**Table 2** Staff related to VLBI operations at Badary.

Valery Olifirov	observatory chief
Roman Sergeev	chief engineer, FS, pointing system control
Roman Kuptsov	engineer
Andrey Mikhailov	FS, pointing system control

### 3 Component Description

#### 3.1 Technical and Scientific Information

Characteristics of the radio telescope are presented in Table 3.

**Table 3** Technical parameters of the radio telescope.

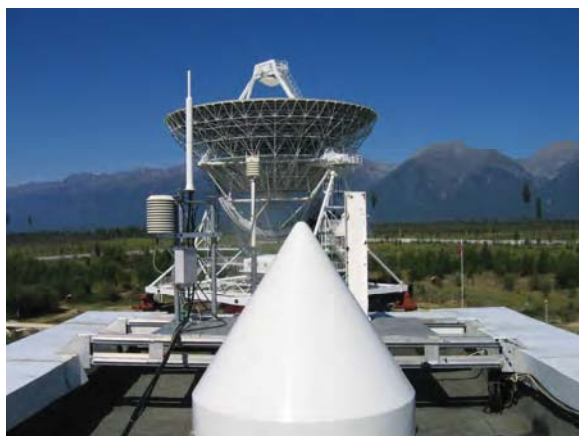
Year of construction	2005
Mount	AZEL
Azimuth range	$\pm 270^\circ$ (from south)
Elevation range	from $-5^\circ$ to $95^\circ$
Maximum azimuth	
- velocity	$0.83^\circ/s$
- tracking velocity	$2.5''/s$
- acceleration	$12.0''/s^2$
Maximum elevation	
- velocity	$0.5^\circ/s$
- tracking velocity	$0.8''/s$
- acceleration	$12.0''/s^2$
Pointing accuracy	better than $10''$
Configuration	Cassegrain (with asymmetrical subreflector)
Main reflector diameter	32 m
Subreflector diameter	4 m
Focal length	11.4 m
Main reflector shape	quasi-paraboloid
Subreflector shape	quasi-hyperboloid
Main reflector surface accuracy	$\pm 0.5$ mm
Frequency range	1.4–22 GHz
Axis offset	$3.7 \pm 2.0$ mm

#### 3.2 Co-location of VLBI, GPS/GLONASS, DORIS, and SLR System

Badary observatory is equipped with the Javad GPS/GLONASS/Galileo receiver, The SLR system “Sazhen-TM” (Figure 3), beacon “DORIS”, and automatic meteorological station WXT-510 are in operation (Figure 2).

### 4 Current Status and Activities during 2013

Badary observatory participates in IVS and domestic VLBI observing programs. During 2013, Badary sta-



**Fig. 2** Javad GPS/GLONASS/Galileo receiver and beacon “DORIS” at the Badary observatory.



**Fig. 3** “Sazhen-TM” SLR system at Badary observatory observed 1278 passes of Lageos, GLONASS et al. and obtained 11430 normal dots.

tion participated in 31 diurnal IVS sessions — IVS-R4, IVS-T2, and EURO.

Badary participated in 48 diurnal sessions in the frame of the domestic Ru-E program for determination of all Earth orientation parameters and in 191 one-hour Ru-U sessions for obtaining Universal Time using e-VLBI data transfer. Since April 2013 we have used e-VLBI data transfer for Badary observation data for Ru-E sessions.

Finally, an antenna tower for the 13.2-m dish was built.



**Fig. 4** Autumn 2013, building in progress.



**Fig. 5** Antenna tower for 13.2-m dish.



**Fig. 6** Main reflector 13.2-m and antenna tower.

## 5 Future Plans

Our plans for the coming year are the following:

- To participate in IVS observations including CONT14 IVS campaign,
- To carry out domestic observing programs for obtaining Universal Time daily and for obtaining Earth orientation parameters with e-VLBI data transfer weekly,
- To carry out SLR observations of geodetic and navigation satellites,
- To participate in EVN and RADIOASTRON observing sessions,
- To continue geodetic monitoring of the RT-32 parameters,
- To install a WVR, and
- To finish VLBI2010 antenna installation in 2014.

## References

1. Finkelstein A., Ipatov A., Smolentsev S. The Network “Quasar”: 2008-2011 // “Measuring the future”, Proc. of the Fifth IVS General Meeting, A. Finkelstein, D. Behrend (eds.), St. Petersburg, “Nauka”, 2008. pp. 39–46.

# Effelsberg Radio Observatory 2013 Annual Report

Uwe Bach, Alex Kraus

**Abstract** The 100-m radio telescope of the Max-Planck-Institut für Radioastronomie (MPIfR) is one of the two largest fully steerable single-dish radio telescopes in the world and a unique high-frequency radio telescope in Europe. The telescope can be used to observe radio emission from celestial objects in a wavelength range from 90 cm ( $\sim 300$  MHz) down to 3.5 mm ( $\sim 90$  GHz).

## 1 General Information

The Effelsberg radio telescope was inaugurated in 1971 and was (for almost 30 years) the largest fully steerable single-dish radio telescope in the world. It is situated in a protected valley near Bad Münstereifel (about 40 km southwest of Bonn) and operated by the Max-Planck-Institut für Radioastronomie (MPIfR) on behalf of the Max-Planck-Society (MPG). To this day, it is the largest radio telescope in Europe and is mostly used for astronomical observations.

The extremely versatile and flexible instrument can be used to observe radio emission from celestial objects in a wavelength range from about 1 m (corresponding to a frequency of  $\sim 300$  MHz) down to 3.5 mm (86 GHz). The combination of the high surface accuracy of the reflector (the mean deviation from the ideal parabolic form is  $\sim 0.5$  mm RMS) and the construction principle of ‘homologous distortion’ (i.e., the reflector in any tilted position has a parabolic shape with a well-

defined, but shifted, focal point) enables very sensitive observations at high frequencies (i.e.,  $\nu > 10$  GHz).

The wide variety of observations with the 100-m radio telescope is made possible by the good angular resolution, the high sensitivity, and a large number of receivers which are located either in the primary or in the secondary focus. Together with a number of distinguished backends dedicated to different observing modes, this provides excellent observing conditions for spectroscopic observations (atomic and molecular transitions in a wide frequency range), and also for high time-resolution (pulsar observations), mapping of extended areas of the sky and participation in a number of interferometric networks (mm-VLBI, EVN, and Global VLBI etc.).

**Table 1** Telescope properties.

Name	Effelsberg
Coordinates	6:53:01.0 E,+50:31:29.4 N
Mount	azimuthal
Telescope type	Gregorian (receivers in prime and secondary focus)
Diameter of main reflector	100 m
Focal length of prime focus	30 m
Focal length of secondary focus	387.7 m
surface accuracy	0.55 mm RMS
Slew rates	Azi: 25 deg/min, Elv: 16 deg/min
Receivers for Geodetic observations	3.6 cm/13 cm secondary-focus (coaxial)
T <sub>sys</sub> (3.6 cm/13 cm)	25 K, 200 K
Sensitivity (3.6 cm/13 cm)	1.4 K/Jy, 0.5 K/Jy
HPBW (3.6 cm/13 cm)	81 arcsec, 350 arcsec

Max-Planck-Institut für Radioastronomie, Bonn, Germany

Effelsberg Network Station

IVS 2013 Annual Report



**Fig. 1** Aerial image of the Effelsberg radio observatory. Shown are the 100-m Effelsberg antenna and the institute building. Effelsberg hosts also a station of the European Low Frequency Array (LOFAR), seen in the lower part of the picture.

## 2 Activities during the Past Year

About 30% of the observing time of the Effelsberg antenna is used for VLBI observations. Most of them are astronomical observations for the European VLBI Network (EVN), High Sensitivity Array (HSA), Global MM VLBI Array (GMVA) or other global networks, but also geodetic VLBI observations are performed. Effelsberg has regularly participated in the EUROPE IVS sessions since 1991. In autumn 2013, the slew rates of the antenna had to be reduced because of work at the main power supply of the station. Therefore the schedule for EUR126 had to be adapted to the slower speeds.

## 3 Current Status

Effelsberg is using the DBBC2 and a Mark 5B+ recorder for all EVN, global, and geodetic VLBI observations. In addition, there are two NRAO RDBEs

and a Mark 5C recorder that are used for observations with the VLBA and HSA. The observatory is connected via a 10 GE optical fiber to the e-VLBI network and can do real time e-VLBI observations and e-transfer of data to Bonn and JIVE.

## 4 Future Plans

Upgrades for several receiving systems are planned for 2014. In January, a new K-band receiver (18 to 26 GHz) was installed into the secondary focus and is just being commissioned. The construction of a new C-band system (4-8/9.3 GHz) for wide band observations and the installation of a new Q-band receiver (38 to 50 GHz) are planned for 2014 as well. The new receivers will provide wide band IF signals of 2.5 GHz band width which can be used with the next generation of digital VLBI backends and recorders, like the DBBC3 and Mark 6, to record data at recording rates of up to 16 Gbps.

# Fortaleza Station 2013 Annual Report

Pierre Kaufmann <sup>1</sup>, A. Macilio Pereira de Lucena <sup>2</sup>, Adeildo Sombra da Silva <sup>1</sup>

**Abstract** This is a brief report about the activities carried out at the Fortaleza geodetic VLBI station (ROEN: Rádio Observatório Espacial do Nordeste), located in Eusébio, CE, Brazil, during the period from January until December 2013. The total observed experiments consisted of 99 VLBI sessions and continuous GPS monitoring recordings.

## 1 General Information

The Rádio Observatório Espacial do Nordeste, ROEN, located at INPE facilities in Eusébio, nearly 30 km east of Fortaleza, Ceará State, Brazil, began operations in 1993. Geodetic VLBI and GPS observations are carried out regularly, as contributions to international programs and networks. ROEN is part of the Brazilian space geodesy program, which was initially conducted by CRAAE (a consortium of the Brazilian institutions Mackenzie, INPE, USP, and UNICAMP) in the early 1990's. The program began with antenna and instrumental facilities erected, with activities sponsored by the U.S. agency NOAA and the Brazilian Ministry of Science and Technology's FINEP agency.

ROEN is currently coordinated by CRAAM, Center of Radio Astronomy and Astrophysics, Engineering School, Mackenzie Presbyterian University, São Paulo, in agreement with the Brazilian National Space Research Institute, INPE. The activities are cur-

rently carried out under an Agreement of Cooperation signed between NASA—representing research interests of NOAA and USNO—and the Brazilian Space Agency, AEB, which has been extended until 2021. Under the auspices of the NASA-AEB Agreement, a contract was signed between NASA and CRAAM, Mackenzie Presbyterian Institute and University to partially support the activities at ROEN.

The counterpart of the operational costs, staff, and support of infrastructure are provided by INPE and by Mackenzie.



Fig. 1 14.2-m radio telescope.

1. Universidade Presbiteriana Mackenzie, CRAAM and INPE, Rádio Observatório Espacial do Nordeste, ROEN
2. Instituto Nacional de Pesquisas Espaciais, ROEN

Fortaleza Network station

IVS 2013 Annual Report



## 2 Main Instruments

The largest instrument at ROEN is the 14.2-m radio telescope, on an alt-azimuth positioner. It is operated at S- and X-bands, using cryogenic radiometers. The system is controlled by the Field System, version 9.10.4. Observations are recorded with a Mark 5 system. One Sigma-Tau hydrogen maser clock standard is operated at ROEN. GPS monitoring is performed within a cooperative program with NOAA (USA). There is a Leica System 1200 installed at the station that operates continuously. The collected data are provided to the NOAA/IGS center and to the Brazilian IBGE center. ROEN has all basic infrastructures for mechanical, electrical, and electronic maintenance of the facilities.

## 3 Staff

The Brazilian space geodesy program is coordinated by one of the authors (PK), who is Brazil's AEB representative in the NASA-AEB Agreement. The coordination receives support from the São Paulo office at CRAAM/Instituto and Universidade Presbiteriana Mackenzie, with administrative support from Valdomiro M. S. Pereira and Lucíola Melissa Russi. The Fortaleza Station facilities and geodetic VLBI and GPS operations are managed on site by Dr. Antonio Macilio Pereira de Lucena (INPE), assisted by Eng. Adeildo Sombra da Silva (Mackenzie), and the technicians Avicena Filho (INPE) and Francisco Renato Holanda de Abreu (Mackenzie).

## 4 Current Status and Activities

### 4.1 VLBI Observations

In the year 2013, Fortaleza station participated in geodetic VLBI experiments as listed in Table 1.

Most of the recorded data are being transferred to the correlators through a high speed network from the Mark 5A recorder unit. The data from the Fortaleza station is uploaded either to the correlators in the U.S. through FIU (Florida International University) or directly to the Bonn correlator.

**Table 1** 2013 session participation.

Experiment	Number of Sessions
IVS-R1	40
IVS-R4	45
IVS-T2	06
IVS-R&D	01
IVS-RDV	01
IVS-CRF	02
IVS-CRMS	02
IVS-OHIG	04

### 4.2 Operational and Maintenance Activities

The summary of activities performed in the period is listed below:

- 1) Repair and maintenance of the cryogenic system, Mark IV video converters, and antenna pointing system;
- 2) Survey on RFI in S-band;
- 3) Maintenance and adjustment of DC azimuth and elevation motors;
- 4) Operation and maintenance of geodetic GPS (NOAA within the scope of the NASA contract);
- 5) Operation and maintenance of power supply equipment at the observatory (main and diesel driven standby);
- 6) Welding at some points of the antenna structure;
- 7) Maintenance of the Web site and the local server computer (<http://www.roen.inpe.br>).

### 4.3 GPS Operations

The IGS network GPS receiver operated regularly at all times during 2013. Data were collected and uploaded to an IGS/NOAA computer.

# Goddard Geophysical and Astronomical Observatory

Ricardo Figueroa, Jay Redmond, Katherine Pazamickas

**Abstract** This report summarizes the technical parameters and the technical staff of the VLBI system at the fundamental station GGAO. It also gives an overview about the VLBI activities during the 2013 report year. The outlook lists the outstanding tasks to improve the performance of GGAO.

## 1 GGAO at Goddard

The Goddard Geophysical and Astronomical Observatory (GGAO) consists of a 5-meter radio telescope for VLBI, a new 12-meter radio telescope for VLBI2010 development, a 1-meter reference antenna for microwave holography development, an SLR site that includes MOBLAS-7, the NGSLR development system, a 48'' telescope for developmental two-color Satellite Laser Ranging, a GPS timing and development lab, a DORIS system, meteorological sensors, and a hydrogen maser. In addition, we are a fiducial IGS site with several IGS/IGSX receivers.

GGAO is located on the east coast of the United States in Maryland. It is approximately 15 miles NNE of Washington, D.C. in Greenbelt, Maryland (Table 1).

---

NASA Goddard Space Flight Center

GGAO Network Station

IVS 2013 Annual Report

**Table 1** Location and addresses of GGAO at Goddard.

Longitude	76.4935° W
Latitude	39.0118° N
MV3 Code 299.0 Goddard Space Flight Center (GSFC) Greenbelt, Maryland 20771	
<a href="http://cddisa.gsfc.nasa.gov/ggao/vlbi.html">http://cddisa.gsfc.nasa.gov/ggao/vlbi.html</a>	

## 2 Technical Parameters of the VLBI Radio Telescopes at GGAO

The 5-m radio telescope for VLBI at MV3 was originally built as a transportable station; however, it was moved to GGAO in 1991 and has been used as a fixed station. In the winter of 2002 the antenna was taken off its trailer and permanently installed at GGAO.

In October of 2010, construction of the new 12-meter VLBI2010 developmental antenna was completed. This antenna features all-electric drives and a Cassegrain feed system. Integration of the broadband receiver and the associated sub-systems is underway as a joint effort between Exelis and the MIT Haystack Observatory.

The technical parameters of the radio telescopes are summarized in Table 2.

## 3 Technical Staff of the VLBI Facility at GGAO

GGAO is a NASA R&D and data collection facility. It is operated under the Space Communication Network Services (SCNS) contract by Exelis Inc. The staff

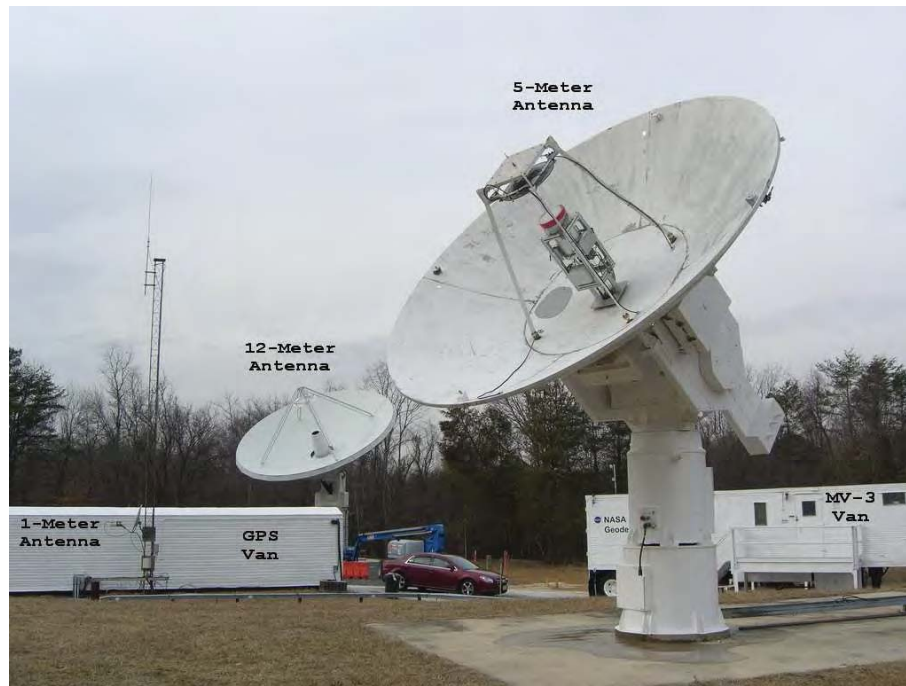


Fig. 1 Goddard Geophysical and Astronomical Observatory.

Table 2 Technical parameters of the radio telescopes at GGAO.

Parameter	5-m	12-m
Owner and operating agency	NASA	NASA
Year of construction	1982	2010
Diameter of main reflector $d$	5 - m	12 - m
Azimuth range	$\pm 270^\circ$	$\pm 270^\circ$
Azimuth velocity	$3^\circ/s$	$5^\circ/s$
Azimuth acceleration	$1^\circ/s^2$	$1^\circ/s^2$
Elevation range	$\pm 90^\circ$	$5 - 88^\circ$
Elevation velocity	$3^\circ/s$	$1.25^\circ/s(Avg.)$
Elevation acceleration	$1^\circ/s^2$	$1^\circ/s^2$
Receiver System		
Focus	Cassegrain	Cassegrain
Receive Frequency	2 - 14GHz	2 - 14GHz
$T_{sys}$	100 K	50 K(Theoretical)
Bandwidth	512MHz, 4 bands	512MHz, 4 bands
$G/T$	26 dB/K	43 dB/K
VLBI terminal type	CDP	VLBI2010
Recording media	Mark IV	Mark 5C

at GGAO consists mainly of two operators and one backup engineer. The Exelis staff includes Jay Redmond and Katherine Pazamickas conducting VLBI operations and maintenance at GGAO with the support of Ricardo Figueroa.

#### 4 Status of MV3 and VLBI2010 at GGAO

Having ceased VLBI operations in May 2007, MV3 continues on a full time basis to be a major component in the program to demonstrate the feasibility of the VLBI2010 broadband delay concept. Working un-

der the guidance of the Exelis team, the majority of MV3's S/X components have been upgraded, and antenna refurbishing should be completed by early 2014 to provide additional support to the VLBI2010 System. The 2013 accomplishments for the 5-m antenna include:

- The 017 Electronic Box was refurbished and installed with new wiring and upgraded components.
- The Cryogenic Dewar and the components were restored for X-band operations. Also, the cryogenic thermometer, vacuum gauge, and bias voltage box were installed and tested.
- The FSS Subreflector and Feed assembly, including the FSS, was recoated with a highly reflective surface, repaired, and placed back on the antenna.
- The ACU and control panel are in the process of upgrade and troubleshooting.
- Two of the Sargent Welch Director Model 8816-B were refurbished using a repair kit. One was mounted and tested in the antenna.

Much of the 2013 activities at GGAO have been focused on performance testing and upgrading of the VLBI2010 12-m antenna. However, there were some other activities worth noting:

- Installation of the new Broadband self-retractable feed positioner for the 12-meter antenna. The positioner is controlled remotely to lower the cryogenics and perform receiver maintenance.
- Continuation of wideband system testing and characterization of the 12-m antenna.
- Procurement of new test equipment for characterization of the wideband RF hardware.
- Continuation of Broadband Phase Cal performance testing.
- Integration of RDBEs, Mark 5Cs, and Field System computer software.
- Installation of receiver radome.
- VLBI observations between Westford and GGAO and processing of data.
- Monitoring and Control Interface (MCI) installation and testing. The MCI is currently used for remote cryogenics and electronic status.
- Performance testing of the 16 Gbps VLBI recording, demonstrated using Mark 6.
- Installation of the high frequency optical fiber link system.

## 5 Outlook

GGAO will continue to support VLBI2010, e-VLBI, and other developmental activities during the upcoming year. Tentative plans for 2014 include:

- Continuing to upgrade the VLBI2010 broadband receiver system on the 12-m antenna.
- Conducting IVS observations using the Mark 5C and Mark 6 recorders to demonstrate the VLBI2010 capabilities.
- Continuing testing of the new broadband phase calibrator for the VLBI2010 system.
- Continuing the upgrade of the 5-m antenna ACU and initiating testing of the S/X band.
- Continuing to measure the baseline between the 5-m and the 12-m antennas for position ties to the reference frame.
- Trying to understand the source of the azimuth and elevation gearboxes' oil contamination.
- Trying to understand why the antenna will not move in elevation under computer control when first started up on cold mornings.

# Hartebeesthoek Radio Astronomy Observatory (HartRAO)

Marisa Nickola, Jonathan Quick, Ludwig Combrinck

**Abstract** HartRAO provides the only fiducial geodetic site in Africa, and it participates in global networks for VLBI, GNSS, SLR and DORIS. This report provides an overview of geodetic VLBI activities at HartRAO during 2013, including the 15-m radio telescope officially joining geodetic VLBI operations as well as the funding of the first African VGOS site.

## 1 Geodetic VLBI at HartRAO

Hartebeesthoek is located 65 km northwest of Johannesburg, just inside the provincial boundary of Gauteng, South Africa. The nearest town, Krugersdorp, is 32 km away. The telescopes are situated in an isolated valley which affords protection from terrestrial radio frequency interference. HartRAO currently uses both a 26-meter and a 15-meter radio telescope. The 26-m is an equatorially mounted Cassegrain radio telescope built by Blaw Knox in 1961. The telescope was part of the NASA deep space tracking network until 1974 when the facility was converted to an astronomical observatory. The 15-m is an alt-az radio telescope built as a Square Kilometre Array (SKA) prototype during 2007 and converted to an operational geodetic VLBI antenna during 2012. The telescopes are collocated with an ILRS SLR station (MOBLAS-6), an IGS GNSS station (HRAO), and an IDS DORIS station (HBMB) at the adjoining South African National

---

HartRAO

HartRAO Network Station

IVS 2013 Annual Report

Space Agency Earth Observation (SANSA EO) site. HartRAO is also a full member of the EVN.



**Fig. 1** The HartRAO 26 m under repair after a thunderstorm and lightning strike during the Ultra-rapid R1579 on 2 April 2013 (with the 15 m in the background).

## 2 Technical Parameters of the 26-m and 15-m Telescopes of HartRAO

Table 1 contains the technical parameters of the HartRAO 26-m and 15-m radio telescopes, while Table 2 and Table 3 contain technical parameters of the HartRAO 26-m and 15-m receivers, respectively. The current data acquisition systems consist of a DBBC terminal and a Mark 5B+ recorder for both the 26 m and the 15 m. A Mark 5B and a Mark 5C recorder are used for e-transfer of data and conditioning and testing of disk packs. Three hydrogen masers are available for use,

namely the iMaser 72, which is currently employed for VLBI on the 26 m, as well as two spares — EFOS-28, currently employed on the 15 m, and the resuscitated EFOS-6.

**Table 1** Antenna parameters.

Parameter	HartRAO	Hart15M
Owner and operating agency	HartRAO	HartRAO
Year of construction	1961	2007
Radio telescope mount	Offset equatorial	Az-El
Receiving feed	Cassegrain	Prime focus
Diameter of main reflector $d$	25.914 m	15 m
Focal length $f$	10.886 m	7.5 m
Focal ratio $f/d$	0.42	0.5
Surface error of reflector (RMS)	0.5 mm	1.6 mm
Short wavelength limit	1.3 cm	2 cm
Pointing resolution	0.001°	0.001°
Pointing repeatability	0.004°	0.004°
Slew rate on each axis	HA: 0.5° s <sup>-1</sup> Dec: 0.5° s <sup>-1</sup>	Az: 2° s <sup>-1</sup> El: 1° s <sup>-1</sup>

**Table 2** 26-m receiver parameters (degraded performance due to dichroic reflector being used for simultaneous S-X VLBI).

Parameter	X-band	S-band
Feeds	dual CP conical	dual CP conical
Amplifier type	cryo HEMT	cryo HEMT
$T_{\text{sys}}$ (K)	52	40
$S_{\text{SEFD}}$ (Jy)	849	1190
PSS (Jy/K)	16.3	29.8
3 dB beamwidth (°)	0.096	0.418

**Table 3** 15-m co-axial receiver parameters.

Parameter	X-band	S-band
Feeds	stepped horn	wide-angle corrugated horn
Amplifier type	cryo HEMT	cryo HEMT
$T_{\text{sys}}$ (K)	40	42
$S_{\text{SEFD}}$ (Jy)	1400	1050
PSS (Jy/K)	35	25
3 dB beamwidth (°)	0.16	0.57

### 3 Current Status

The 15 m was operating in test mode at the start of 2013, participating in three Ultra-Rapid sessions with

Tsukuba and Onsala during January and February 2013. One of these sessions, R1573 on 18 February 2013, was run in tag-along mode. The 15 m made its official debut during another Ultra-rapid session with Tsukuba and Onsala — R1580 on 8 April 2013. It joined the 26 m for the first time on 5 August 2013 during the Ultra-rapid, R1597, with Onsala and Yarragadee. Another seven dual experiments were performed during the year with the 15-m maser having to be offset in frequency to prevent PCAL cross-correlation. R1597 was also to be the first formal session with HART15M using the DBBC under FS control. On the 19th of September, the 15 m participated in its first official R4, followed by another three R4s for 2013, with the last one, R4616 on 19 December 2013, wrapping up 2013 observing session proceedings at HartRAO. The 15 m also replaced the 26 m in the penultimate session of the year adding an RD session to its tally. The 15 m participated in the AUSTRAL sessions, a Southern Hemisphere observing program, together with the AuScope antennas and Warkworth's 12 m. AUSTRAL sessions 10-16 were run over a period stretching from July to November 2013 with a 15-day continuous AUSTRAL-CONT campaign starting on the 28th of November and finishing up on 16 December 2013. All AUSTRALs, and most other sessions in which the 15 m participated, were run under remote control by Jonathan Quick. During 2013, the 26 m participated in, amongst others, nine Ultra-rapid sessions (R1/T2/RD) — seven together with Onsala and Tsukuba and two with Onsala and Yarragadee. The 26 m switched to using DBBC and Mark 5B+ in its penultimate session for 2013, R1616 on the 16th of December. Geodetic VLBI data for all but the RDV sessions (excluding those sessions where disk packs failed) were e-transferred to the correlators. Telescope time allocation for geodetic VLBI in 2013 consisted of 56 and 37 24-hour experiments for the 26 m and 15 m, respectively (Table 4). Webcams installed for both telescopes may be accessed via HartRAO's webpage. During September 2013, Ludwig Combrinck installed a tide gauge on Gough Island. A seismic vault containing a seismometer, gravimeter, and accelerometer has also been installed on site at HartRAO.

**Table 4** Geodetic VLBI experiments in which HartRAO participated during 2013.

Experiment	No. of sessions on 26 m	No. of sessions on 15 m
R1	25	10
RD	8	1
T2	7	0
CRDS	6	0
CRF	4	0
OHIG	3	0
RDV	3	0
R4	0	4
AUST	0	7
AUST13	0	15
Total	56	37

## 4 Personnel

Table 5 lists the HartRAO station staff who are involved in geodetic VLBI. Jonathan Quick (VLBI friend) provides technical support for the Field System as well as for hardware problems. Radio astronomer Alet de Witt attended the VLBI Training School and the 21st European VLBI for Geodesy and Astrometry (EVGA) Working Meeting held in Espoo, Finland in March 2013. During this meeting and the subsequent Journées 2013 “Systèmes de Référence Spatio-Temporels” at the Observatoire de Paris, France in September 2013, Alet represented HartRAO in the IAU’s ICRF3 working group. Alet and microwave engineer Ronnie Myataza participated in the Seventh IVS Technical Operations Workshop presented at Haystack Observatory in May 2013. Space Geodesy student Denise Dale and Marisa Nickola (geodetic VLBI support) attended the VieVS Fourth User Workshop in Vienna, Austria during September 2013.

**Table 5** Staff supporting geodetic VLBI at HartRAO.

Name	Function	Program
L. Combrinck	Program Leader	Geodesy
J. Quick	Hardware/Software	Astronomy
R. Botha	Operator	Geodesy
J. Grobler	Operator	Technical
L. Masongwa	Operator	Technical
R. Myataza	Operator	Technical
M. Nickola	Logistics/Operations	Geodesy
P. Stronkhorst	Operator	Technical
C. Zondi	Operator	Technical

## 5 Future Plans

Looking at the preliminary schedule for 2014, the 26-m antenna’s geodetic workload has been reduced significantly, with only 25 of the 131 sessions allocated to HartRAO being run on the 26 m. Hart15M will participate in both the CONT14 and AUST14 continuous campaigns during May 2014 and November/December 2014, respectively. The good news is that funds have been allocated for the VLBI2010 VGOS antenna. It is to be built on site, and an appropriate location for the antenna has already been identified to the north of the 26 m and the SLR station. With funding for the VGOS antenna having been allocated over the next three years (2014-2016), the process of procuring the antenna is expected to start in 2014. A VGOS site investigation, including geotechnical and RFI studies, will be pursued during 2014. A site tie is also planned for the early part of the year. Work on the Lunar Laser Ranger (LLR) project will continue during 2014. HartRAO intends sending a sizeable delegation to the 8th IVS General Meeting to be held in Shanghai, China, in early March 2014, in order to put in a bid for hosting the next IVS General Meeting in 2016. During this meeting, Alet will once again participate in the IAU’s ICRF3 working group discussions.

## Acknowledgements

HartRAO is a National facility operating under the auspices of the National Research Foundation (NRF), South Africa. The Space Geodesy Programme is an integrated program, combining VLBI, SLR, and GNSS, and it is active in several collaborative projects with GSFC, JPL, and GFZ (Potsdam) as well as numerous local institutes. Collaboration also includes CNES/GRGS/OCA and the ILRS community in a Lunar Laser Ranger (LLR) project with local support from the University of Pretoria and the National Laser Centre (CSIR), among others. General information as well as news and progress on geodesy and related activities can be found at <http://geodesy.hartrao.ac.za/>.



**Fig. 2** Ronnie and Lerato in the microwave lab measuring  $T_{rec}$  of the 26 m's 3.5-cm Dicke switch cryogenically cooled receiver.



**Fig. 5** Ludwig installing a tide gauge on Gough Island in the South Atlantic Ocean.



**Fig. 3**  $T_{sys}$  measurements of the 26-m antenna's 3.5-cm Dicke switch cryogenically cooled receiver and feed.



**Fig. 6** Hardware gecko — luckily these days data are being e-transferred.



**Fig. 4** Ronnie at the entrance to the vault with the 26 m and the 15 m behind him and the SLR and the LLR to his right.



# AuScope VLBI Project and Hobart 26-m Antenna

Jim Lovell <sup>1</sup>, John Dickey <sup>1</sup>, Brett Reid <sup>1</sup>, Jamie McCallum <sup>1</sup>, Stas Shabala <sup>1</sup>, Christopher Watson <sup>2</sup>, Lucia Plank <sup>1</sup>, Simon Ellingsen <sup>1</sup>, Anthony Memin <sup>1</sup>

**Abstract** This is a report on the activities carried out at the University of Tasmania in support of the three AuScope VLBI observatories and the Hobart 26-m antenna. In 2013 the antennas participated in 110 IVS sessions for a total of 262 antenna days of observing, 116 more than in 2012. An increase in operations funding in 2013 has enabled us to increase our observing load, including 60 days per year for AUSTRAL which is focused on high priority geodetic and astrometric programs in the southern hemisphere. In this report we also briefly highlight our research activities during 2013 and our plans for 2014.

## 1 General Information

As part of AuScope ([www.auscope.org.au](http://www.auscope.org.au)), the University of Tasmania (UTAS) operates the AuScope VLBI Array (Lovell et al., 2013), three 12-m diameter radio telescopes on the Australian continent, located near Hobart (Tasmania), Yarragadee (Western Australia), and Katherine (Northern Territory).

The Hobart telescope (Hb) is co-located with the existing 26-m telescope (Ho) to preserve the more than 20-year VLBI time series at the site. Midway between the 26-m and 12-m telescopes is the HOB2 GNSS installation which has been a core site of the International GNSS Service (IGS) since its conception. A hut capable of housing a mobile gravimeter is also co-located

on the site. The Yarragadee telescope (Yg) provides a far western point on the continent and is co-located with multiple existing geodetic techniques including SLR, GNSS, DORIS, and gravity. The Katherine site (Ke) is new and provides a central longitude, northern site. The telescope at Katherine is co-located with a new GNSS site that forms part of the AuScope GNSS network.

Each AuScope VLBI observatory is equipped with a 12.1-m diameter main reflector. The telescope specifications include: 0.3 mm of surface precision (RMS), fast slewing rates (5 deg/s in azimuth and 1.25 deg/s in elevation), and acceleration (1.3 deg/s/s). All three sites are equipped with dual polarization S- and X-band feeds with room temperature receivers covering 2.2 to 2.4 GHz at S-band and 8.1 to 9.1 GHz at X-band. System Equivalent Flux Densities (SEFDs) are 3500 Jy in both bands. Data digitization and formatting is managed by the Digital Base Band Converter (DBBC) system, and data are recorded using the Mark 5B+ system. Each site is equipped with a Hydrogen maser time and frequency standard.

All three observatories were designed and constructed to be remotely controlled and monitored to keep operating costs at a minimum. Operation of the AuScope VLBI array is being carried out from a dedicated operations room on the Sandy Bay campus of the University of Tasmania.

## 2 Staff

Staff at UTAS consists of academics Prof. John Dickey (director), Dr. Simon Ellingsen, Dr. Christopher Watson, and Prof. Peter McCulloch. Dr. Jim Lovell is

1. School of Mathematics and Physics, University of Tasmania

2. School of Geography and Environmental Studies, University of Tasmania

Project Manager for the AuScope VLBI project. Dr. Jamie McCallum, Dr. Stas Shabala, Dr. Lucia Plank, and Dr. Anthony Memin are post-doctoral fellows who are carrying out research aimed at improving geodetic solutions in the southern hemisphere. Mr. Brett Reid is the Observatory Manager whose position is funded by the university. In addition we have an electronics technical officer, Mr. Eric Baynes. For operation of the observatories during geodetic observations we rely heavily on support from astronomy PhD and post graduate students. Logistical and maintenance support at Katherine is provided by Mr. Martin Ephgrave and at Yarragadee by Mr. Randall Carman and team at the MOBLAS5 SLR station.

### 3 AuScope VLBI Project Status

The AuScope VLBI array is currently funded for operations at the level of up to 170 observing days per year until mid 2015. This includes 60 days per year for the AUSTRAL program and, in 2014, the CONT14 campaign. The Hobart 26-m antenna will continue to participate in IVS observations at the level of twelve days per year, primarily to assist in the maintenance and enhancement of the Celestial Reference Frame in the southern hemisphere. The 26 m will also participate in CONT14.

### 4 Geodetic VLBI Observations

In 2013 the AuScope and Hobart 26-m antennas participated in 110 IVS sessions (up from 72 in 2012) for a total of 262 antenna days of observing, 116 more than the previous year. A summary of the observations is presented in Table 1.

#### 4.1 The AUSTRAL Program

The 60 day per year AUSTRAL Program commenced in July 2013 and will run for two years initially. Observations are being made with the three AuScope antennas as well as the Warkworth 12 m and Hartebeesthoek 15 m (Figure 1). The Hobart 26 m and Hartebeesthoek

**Table 1** AuScope and Hobart 26-m antenna participation (number of days) in IVS sessions in 2013. The AUST13 series of observations was a 15-day CONT-like session as part of the AUSTRAL program.

Session	Antenna			
	Ho	Hb	Ke	Yg
APSG		2		
AUST13		15	15	15
AUSTRAL		9	9	9
CRDS	6	5	5	3
CRF	1	3	3	4
OHIG		3	3	3
R&D	6	1	1	1
R1		28	26	22
R4		27	22	23
T2		2	2	1
Total	13	95	86	81

26 m also participate for some observations. Scheduling is carried out in VieVS, and data are correlated at the Curtin University software correlator.

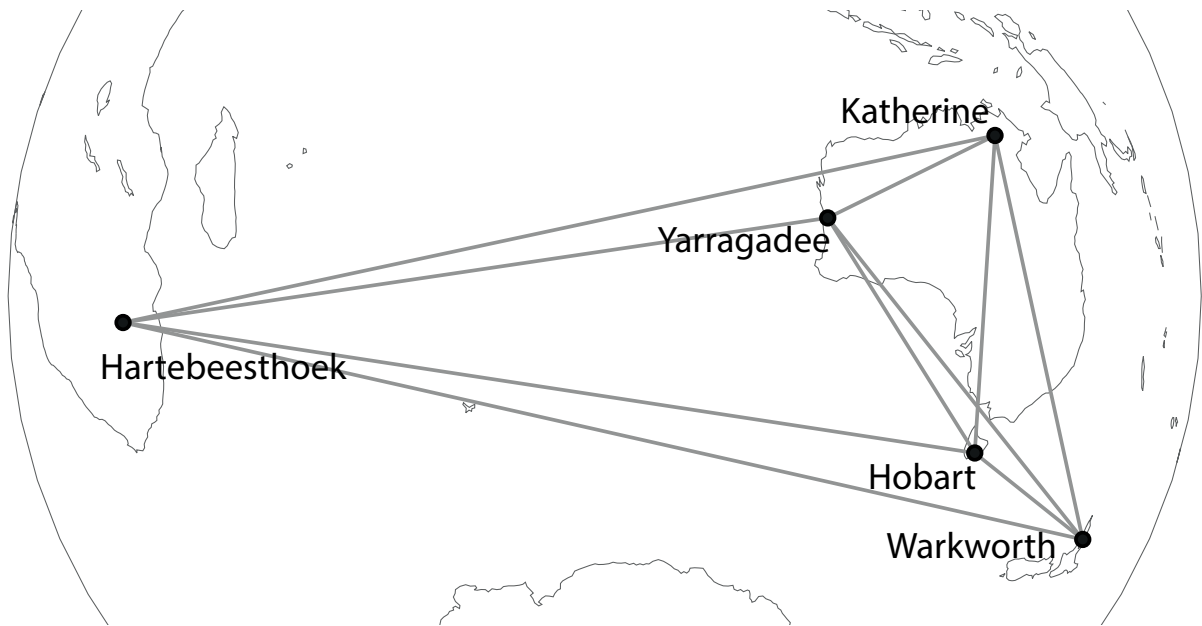
The AUSTRAL observing program is divided into three streams focused on high priority geodetic and astrometric aims in the southern hemisphere:

1. astrometric observations to monitor and enhance the southern hemisphere reference frame in preparation for ICRF3;
2. regular observations to improve the density of the geodetic time series for the southern antennas and measure and monitor the motion and deformation of the Australian plate;
3. four 15-day CONT-like sessions over two years to demonstrate the full capabilities of the array, characterize the level of systematic errors caused by the troposphere and source structure, and develop and try error mitigation strategies.

For four experiments during 2014, the 26-m antennas at Hartebeesthoek and Hobart will join the AUSTRAL array. With the same atmosphere and clocks at each site, and with baselines to each pair observing the same source structure, we hope to further understand the systematic uncertainties due to troposphere and source structure.

#### 4.1.1 Post-correlation Data Processing

Starting in late 2012, the University of Tasmania has begun handling the post-correlation processing



**Fig. 1** The AUSTRAL array comprising the AuScope VLBI array, Hartebeesthoek and Warkworth.

of the AUSTRAL experiments correlated at Curtin University. After the Mark IV data are made available from Curtin, they are processed using fourfit, and a correlation report is drafted. We would like to thank Alessandra Bertarini from Bonn for her extensive assistance with these procedures. The database creation is currently handled by David Gordon at NASA GSFC, as the University of Tasmania does not have CALC/SOLVE currently installed. When the standalone version of dbedit is available, this will be used to generate and submit the NGS databases directly. AUSTRAL experiments AUST10 — AUST15 and the first two sessions of the AUST13 campaign have been processed and submitted as NGS databases to date.

## 5 Research Activities

### 5.1 Source Structure

A key area of research over the past year has involved investigating the effects of quasar structure and evolution on geodetic solutions. In particular, we have investigated a number of astrophysical metrics relating to quasars, to see whether these are good predictors of position stability. In Schaap et al. (2013)

we found that scintillating sources (sources that twinkle, showing flux density variability of a few percent on timescales of days) are significantly more stable than non-scintillating sources. We have also considered multi-frequency variability of radio sources on longer timescales in Shabala et al. (2014) and found that sources which show small time lags between S and X-band light curves have more stable positions. We plan to develop this work further in the coming year, with the ultimate goal of helping schedulers decide which quasars should be included in a given IVS session.

With TU Wien colleagues Lucia Plank and Johannes Böhm, we have also developed a source structure simulator to assess the impact of structure in geodetic VLBI observations. This simulator is implemented in the VieVS software, and it allows for studies of different analysis and scheduling strategies. In the coming year, we plan to use the simulator to investigate various analysis and scheduling-based source structure mitigation techniques, including “clever” scheduling that takes into account some a priori knowledge of source structure.

## **5.2 Antenna Structural Deformation Study**

Preliminary terrestrial surveys of the Hobart 12-m telescope were undertaken in 2013 in order to:

1. assess our ability to resolve time dependent refraction coefficients throughout a longer automated survey and
2. test the limits of Automated Target Recognition (ATR) on the Australian Geophysical Observing System (AGOS) robotic telescope monitoring infrastructure (Leica TDRA6000).

Progress was slower than hoped; however the survey has now been integrated with local site tie surveys undertaken by Geoscience Australia, with the Hobart survey underway at the time of writing. We aim to compare time dependent IVP determinations using both the traditional circle fit and the transformation approach, with results to be submitted in 2014. This submission will include an analysis of a telescope-wide deployment of thermistors used to characterize the spatial variability of temperature throughout the small 12-m steel and aluminium structure. Further work is required to complete the Finite-Element Analysis of the structure.

## **References**

1. Lovell, J. E. J. et al., 2013, *J. Geod* 87, 527.
2. Schaap et al. 2013, *MNRAS*, 434, 585.
3. Shabala et al. 2014, *J. Geod.* in press, arXiv:1306.0696.

# Kashima 34-m VLBI Station

M. Sekido, E. Kawai

**Abstract** The Kashima 34-m radio telescope has recovered from the damages to the azimuth wheel and rail caused by the ‘Tohoku Earthquake’ in March 2011. VLBI observations, including IVS sessions and single dish observations, have restarted from April 2013. A newly developed wideband feed was mounted on the antenna. The frequency range of 6.4-14 GHz observations in single linear polarization became available. Further development of the improved feed for the 2-18 GHz frequency range is under progress and expected to be ready in 2014.

## 1 General Information



**Fig. 1** The Kashima 34-m Radio Telescope in November 2013.

NICT Space-Time Standards Laboratory/Kashima Space Technology Center

NICT Kashima Network Station

IVS 2013 Annual Report

The main facility of the Kashima VLBI station is the 34-m diameter antenna of modified Cassegrain focus type. This antenna is maintained and operated by the VLBI group of Space Time Standard Laboratory in the National Institute of Information and Communications Technology (NICT). The station is also a part of the Kashima Space Technology Center (KSTC) as a local branch of the NICT.

Kashima city is located on the east coast of the main island of Japan. The ‘‘Tohoku earthquake’’ that occurred in March 2011 affected Kashima city and the KSTC by destruction of some buildings and a tsunami. An azimuth wheel and rails of the 34-m antenna were damaged by the earthquake. The replacement work of the four azimuth wheels and all the azimuth rail wear-strip plates was done by the end of March 2013. Figure 2 shows the new wheel installed in March 2013. Alignment of each wheel was adjusted by using a telescope attached at the wheel axis, so that the wheel axis is exactly aligned to the central axis of azimuth circle with accuracy of  $1.e-5$  radians. It is important so that the



**Fig. 2** Installation work of new azimuth wheel.

wheel rolls on the azimuth rail circle without stress. The flatness of the rail height was required to be within 0.1 mm RMS over the 10-m radius azimuth circle, which comes from the requirement of antenna tracking accuracy within a tenth beam width for the 43 GHz receiver. The repair work was completed by the end of March 2013, and work began with the same performance as before the earthquake.

## 2 Component Description

### 2.1 Receivers

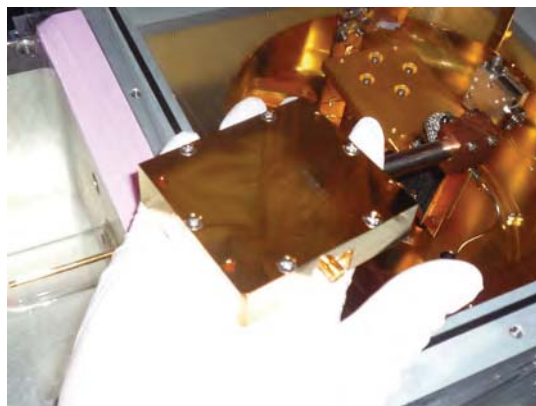
The Kashima 34-m antenna is equipped with multiple receivers from its lowest frequency in L-band up to Q-band. The performance parameters for each frequency are listed in Table 1. Multiple receivers are changed by exchanging receiver systems at the focal point of the antenna. Each receiver is mounted on one of the four trolleys and only one trolley can be at the focal position. The focal position can also be moved by changing the position and direction of sub-reflector via five axes of actuators. Thus optimum sub-reflector positions are adjusted for each receiver. When a feed system is newly mounted the sub-reflector position is adjusted for that.

#### L-band:

Radio Frequency Interference (RFI) from the cell phone base station (1,480 MHz) has become too strong even to saturate the low noise amplifier (LNA) of the first stage in the L-band receiver. We installed a superconductor filter in front of the LNA, whose pass-band is 1405-1440 MHz and 1600-1720 MHz. Installation of the filter was completed in December 2013, and we confirmed that the problem of LNA saturation has been solved.

#### S-band:

A high temperature superconductor filter has been used in the S-band receiver since 2002 to avoid RFI of cell phone IMT-2000. It was located after the LNA instead of before it because the RFI was not severe enough to saturate the LNA. On 12 November 2013, the super-



**Fig. 3** Superconductor Filter installed inside L-band receiver dewar.

conductor filter lost its function because of the increase of the filter temperature caused by aging of the cryogenic system. We replaced the filter with a standard bandpass filter in December. Consequently, its observation frequency range was slightly changed to 2,210-2,350 MHz.

#### Wideband:

As one of the important components of the Gala-V project, which is aimed to make precise frequency comparisons over a long baseline, a new feed system (code name: IGUANA) with wideband observation capability was developed and mounted in place of the C-band receiver trolley of the 34-m antenna. Room temperature wideband LNA is used for one linear polarization in that receiver. The current performance of this antenna is 20-40% efficiency for the 6.4-14 GHz frequency range [1]. A more improved feed is planned to be installed in 2014.

#### 32 GHz and 43 GHz Receivers:

Startup work on these two receivers is currently not completed. Therefore, system performance parameters are not measured in this report.

**Table 1** Antenna Performance parameters of the Kashima 34-m telescope.

Receiver	Pol.	Frequency	Parameter (2013)
L-band	RHCP/LHCP	1405-1440MHz, 1600-1720MHz	SEFD $\sim$ 500Jy
S-band	RHCP/LHCP	2210-2350MHz	SEFD $\sim$ 250Jy
X-band	RHCP/LHCP	8180-9080MHz	SEFD $\sim$ 370Jy
WIDE	V-Linear Pol.	6.4-15GHz	SEFD $\sim$ 1500 Jy
K-band	LHCP	22 - 24 GHz	SEFD $\sim$ 1300 Jy
Ka-band	RHCP	31.7-33.7GHz	NA
Q-band		42.3-44.9GHz	NA

**Fig. 4** Wideband (IGUANA) feed installed in the receiver room of Kashima 34m telescope.

## 2.2 Data Acquisition System

Several VLBI data acquisition systems have been developed and installed in the Kashima 34-m telescope.

K5/VSSP32 [2]: has been employed for all geodetic VLBI observations as a multi-channel data acquisition system.

K5/VSI data recording systems: is composed of a PC-VSI data capture card (PCI-X interface) and a PC with raid disk systems. This system has been used in combination with an ADS3000+ sampler for wideband observations (1024Msps/1ch/1bit, 128Msps/1ch/8bit).

K6/OCTAD-G (code name 'GALAS') sampler: is the newly developed sampler for the Gala-V project [3]. The GALAS samples the RF signal without frequency conversion and acquires four wideband signals with 1024 MHz bandwidth via the digital filter function implemented in it. This sampler

is under evaluation and will be employed for the project in 2014.

K4/VSOP terminal: has been used for joint astronomical observations with JVN [4].

### Network Connections and Data Server

Due to the collaboration with JGN-X, a high speed research network provider hosted by NICT, the 10 Gbps network is available between the Kashima and Koganei stations. Due to the limiting of network switch and connection, the VLBI data server used for e-VLBI data transfer is connected via 1 Gbps network to the Internet. Therefore about 600 Mbps in/out transfer speed is constantly available. Currently three data servers are operated for e-VLBI data exchanges (Table 2).

**Table 2** Data servers at Kashima Station and its capacity.

Hostname	Path	Disk Size
vlbi2.jp.apan.net	/vlbi2/	12 T Bytes
k51b.jp.apan.net	/vlbi3/	26 T Bytes
k51c.jp.apan.net	/vlbi4/	24 T Bytes

## 3 Staff

Kawai Eiji: is the main engineering researcher in charge of the hardware maintenance and the operation of the Kashima 11-m and 34-m antennas [5]. He is responsible for routine geodetic VLBI observations for IVS.

Hasegawa Shingo: is supporting staff for IVS observation preparation and maintenance of file servers for e-VLBI data transfer.

Tsutsumi Masanori: is supporting staff for data acquisition PCs and networks.

Takefuji Kazuhiro: is a researcher using the 34-m antenna for the Gala-V project and the Pulsar observations. He performed startup work of the wideband IGUANA receiver including adjusting sub-reflector position and measured the SEFD of the new receiver.

Ujihara Hideki: has designed the new wideband IGUANA feed.

Ichikawa Ryuichi: is in charge of keeping GNSS stations and GNSS observations.

Sekido Mamoru: is responsible for the Kashima 34-m antenna as the group leader. He is maintaining Field System FS9 software for this station and operating the Kashima and Koganei 11-m antennas [5] for IVS sessions.

#### 4 Current Status and Activities

The Kashima 34-m telescope has completely recovered from the damage of the “Tohoku earthquake” and has rejoined VLBI observations (IVS-T2, IVS-CRF, JADE, and JVN) and single dish observations (Sgr-A\* and Jupiter) since April 2013. Strong RFIs in L-band became more severe from cell phone base stations. We observed saturation of LNA in the worst case scenario and decided to introduce a superconductor filter in front of the LNA as a countermeasure. Production and installation of the filter was completed in December 2013. Now we confirmed that the filter suppresses RFI signal from cell phone base stations and receiver performance was recovered.

The main mission of the VLBI group of NICT is the development of VLBI systems for distant frequency comparison. That project, named GALA-V [3], includes upgrading the receiver of the 34-m telescope to enable wideband observation in frequency range 2.2 - 18 GHz, which covers the frequency range (2-14 GHz) of VGOS [6]. Based on the requirement of narrow beam width on the wideband feed, original designing of the feed system was made for the 34-m telescope.

#### 5 Future Plans

Evaluation of the wideband receiver system will be performed in 2014. Additionally, an improved version of the feed is under development and expected to be ready in the first half of 2014. Wideband VLBI observations in combination with small diameter antennas and the Kashima 34-m telescope will be performed, and engineering evaluation including feed, sampler, and phase calibration systems will be made.

#### Acknowledgements

The development of the wideband feed was supported by the “Joint Development Research” fund provided from the National Astronomical Observatory of Japan in 2013. We acknowledge Professor K. Fujisawa of Yamaguchi University and M. Honma and M. Matsumoto of NAOJ for supporting this development. We thank the research network JGN-X and the Information System Section of NICT for supporting the network environment for e-VLBI.

#### References

1. Takefuji, K., H. Ujihara, “NICT Technology Development Center 2013 Annual Report”, International VLBI Service for Geodesy and Astrometry 2013 Annual Report, edited by K. D. Baver, D. Behrend, and K. L. Armstrong, this volume, 2014.
2. Kondo, T., Y. Koyama, R. Ichikawa, M. Sekido, E. Kawai, and M. Kimura, Development of the K5/VSSP System, *J. Geod. Soc. Japan*, Vol. 54, No 4, pp. 233-248, 2008.
3. Sekido M., et al., Development of Wide-band VLBI system (Gala-V), *IVS NICT-TDC News No 33*, pp.11-14, 2013.
4. Doi, A., Japanese VLBI Network, *Proceedings of the 8th European VLBI Network Symposium*. September 26-29, 2006, Torun, Poland., pp.71-74, 2006.
5. Sekido, M., E. Kawai, “Kashima and Koganei 11-m VLBI Stations”, *International VLBI Service for Geodesy and Astrometry 2013 Annual Report*, edited by K. D. Baver, D. Behrend, and K. L. Armstrong, this volume, 2014.
6. Petrachenko, B.: VLBI2010: Progress and Challenges, *IVS 2012 General Meeting Proceedings*, edited by D. Behrend and K. D. Baver, NASA/CP-2012-217504, p.42-46, 2012.



# Kokee Park Geophysical Observatory

Ron Curtis

**Abstract** This report summarizes the technical parameters of the VLBI system at the Kokee Park Geophysical Observatory and provides an overview of the activities that occurred in 2013.

## 1 Location

The Kokee Park Geophysical Observatory (KPGO) is located at Kokee State Park on the island of Kauai in Hawaii at an elevation of 1,100 meters near the Waimea Canyon, often referred to as the Grand Canyon of the Pacific. KPGO is located on the map at longitude  $159.665^\circ$  W and latitude  $22.126^\circ$  N.

## 2 Technical Parameters

The receiver is of NRAO (Green Bank) design (dual polarization feed using cooled 15 K HEMT amplifiers). The antenna is of the same design and manufacture as those used at Green Bank and Ny-Ålesund. A Mark 5B+ recorder is currently used for all data recording.

Timing and frequency is provided by a Sigma Tau Maser with a NASA NR Maser providing backup. Monitoring of the station frequency standard performance is provided by a CNS (GPS) Receiver/Computer

- 
1. USNO
  2. NASA GSFC

Kokee Park Network Station

IVS 2013 Annual Report

system. The Sigma Tau performance is also monitored via the IGS Network.

## 3 Staff

The staff at Kokee Park consists of six full time people employed by ITT Exelis under the SCNS contract to NASA for the operation and maintenance of the observatory. Chris Coughlin, Lawrence Chang, Kiah Imai, and Ron Curtis conduct VLBI operations and maintenance. Ben Domingo is responsible for antenna maintenance, with Amorita Apilado providing administrative, logistical, and numerous other support functions. Kelly Kim also supports VLBI operations and maintenance during 24-hour experiments and as backup support.

## 4 Mission Support

Kokee Park has participated in many VLBI sessions including IVS R4 and R1. KPGO also participates in the RDV, CRF, and OHIG sessions. KPGO averaged two experiments of 24-hour duration each week, with daily Intensive experiments, in 2013. KPGO began supporting the Saturday INT2 weekend Intensive experiments in May 2013 while the Tsukuba VLBI station was performing repairs. The KPGO support of the weekend Intensive experiments concludes in January 2014.

Kokee Park hosts other systems — a Doppler Orbitography and Radiopositioning Integrated by Satellite (DORIS) beacon and remote control, a Quasi-Zenith Satellite System (QZSS) monitoring

station, a Two-Way Satellite Time and Frequency Transfer (TWSTFT) relay station, and a Turbo-Rogue GPS receiver. Kokee Park is an IGS station.

## 5 Recent Activities

The KPGO 20-m antenna has been in service for 21 years and continues to show signs of its age. In April 2013, the KPGO 20-m antenna construction contractor, GD Satcom, made a site visit to KPGO to implement some changes to the KPGO 20-m antenna configuration in an effort to reduce the wear on the azimuth bull gear teeth due to the axial play in the azimuth bearing. Those changes included re-alignment of the azimuth drives to improve teeth mesh between the azimuth pinions and the bull gear. They also tuned the servo system to decrease the acceleration and deceleration of both the azimuth and elevation drive systems. Plans are moving forward to upgrade the KPGO 20-m telescope for broadband observation. KPGO received a new broadband receiver box from MIT under contract from USNO in October 2013. The digital backend is in the process of being configured with four each RDBE's, UP/DOWN converters, and Mark 5C recorders in addition to an Optical Receiver/Splitter/Amplifier (ORCA). Only one of the four Mark 5C recorders has been received so far. InterTronic Solutions was awarded a contract to build and install a 12-m high precision VLBI2010-style radio antenna at KPGO in support of USNO. The broadband feed to be used on this 12-m telescope will be of MIT design. Installation is projected for completion in 2015.

The e-transfer of the INT1 sessions from KPGO to USNO continues to be transmitted over the microwave infrastructure provided by the Pacific Missile Range Facility (PMRF) and connects KPGO to DREN. Plans to migrate to a dedicated fiber connection to DREN at PMRF have been delayed due to damage to the fibers by a wildfire. MIT is working with the Hawaii Intranet Consortium (HIC) and DREN to improve the KPGO e-transfer rate. Long term plans are still to make real-time VLBI data transfers from KPGO a reality.

## 6 Outlook

KPGO will continue with efforts to upgrade the 20-m antenna signal path to VLBI2010 specifications. KPGO staff, ITT Exelis personnel at GSFC, USNO personnel, and MIT personnel are in the process of planning the 20-m antenna modifications and the installation of a new broadband front end for the KPGO 20-m antenna.

PMRF is working on acquiring funding for repairs to the fiber runs that were damaged by a wild fire in 2012. Those repairs, as well as the dedicated fiber path to HIC/DREN for KPGO e-transfers, are on hold until funding is acquired. USNO, NASA, InterTronic Solutions, MIT, and Exelis will continue working throughout 2014 on the construction process for the high precision VLBI2010-style radio telescope at KPGO.



Fig. 1 20-m digital backend.



**Fig. 2** 20-m broadband feed.

**Table 1** Technical parameters of the radio telescope at KPGO.

Parameter	Kokee Park
owner and operating agency	USNO-NASA
year of construction	1993
radio telescope system	Az-EI
receiving feed	primary focus
diameter of main reflector $d$	20m
focal length $f$	8.58m
$f/d$	0.43
surface contour of reflector	0.020inchesrms
azimuth range	0...540°
azimuth velocity	2°/s
azimuth acceleration	1°/s <sup>2</sup>
elevation range	0...90°
elevation velocity	2°/s
elevation acceleration	1°/s <sup>2</sup>
X-band (reference $\nu = 8.4\text{GHz}$ , $\lambda = 0.0357\text{m}$ )	8.1 – 8.9GHz
$T_{\text{sys}}$	40 K
$S_{\text{SEFD}}(\text{CASA})$	900 Jy
$G/T$	45.05 dB/K
$\eta$	0.406
S-band (reference $\nu = 2.3\text{GHz}$ , $\lambda = 0.1304\text{m}$ )	2.2 – 2.4GHz
$T_{\text{sys}}$	40 K
$S_{\text{SEFD}}(\text{CASA})$	665 Jy
$G/T$	35.15 dB/K
$\eta$	0.539
VLBI terminal type	VLBA/VLBA4-Mark 5
Field System version	9.11.1

# Kashima and Koganei 11-m VLBI Stations

M. Sekido, E. Kawai

**Abstract** The Kashima and Koganei 11-m stations have been used for geodetic and astronomical monitoring observations and as an R&D test bed of VLBI technology. Unfortunately the Kashima 11-m station has stopped due to an accidental cable break that happened in October 2013. This will be fixed in early March 2014. The Koganei 11-m antenna has been constantly operated for VLBI and satellite down-link observations.

## 1 General Information

A pair of 11-m diameter antennas is operated by the VLBI group of Space-Time Standard Laboratory (STSL) of the National Institute of Information and Communications Technology (NICT). The Kashima 11-m antenna is located in Kashima Space Technology Center (KSTC), on the east coast of the Japanese main island. The Koganei 11-m antenna is located in the headquarters of the NICT in Tokyo (Figure 1). The 11-m VLBI antennas at Kashima and Koganei (Figure 2) were established and have been operated for the monitoring of crustal deformation of the Tokyo metropolitan area (Key Stone Project) since 1995 [1]. After regular VLBI observations, the KSP VLBI Network terminated in 2001. Since then, the 11-m VLBI stations at Kashima and Koganei have mainly been used for research and technology developments. “The Tohoku earthquake” that occurred in March 2011

NICT Space-Time Standards Laboratory/Kashima Space Technology Center

NICT KSP Network Station

IVS 2013 Annual Report

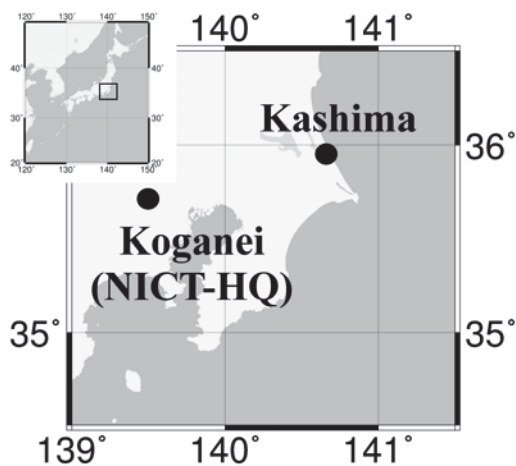


Fig. 1 Location of NICT-Koganei Headquarters, and Kashima.

affected Kashima city and the KSTC by the destruction of some buildings and by a tsunami. Fortunately the damage to the Kashima 11-m antenna was not as severe as that of the Kashima 34-m antenna. The Koganei 11-m antenna in Tokyo was also safe. Thus two antennas could be used for measurements of post-seismic crustal deformation of the Kashima-Koganei baseline. The Kashima and Koganei 11-m stations participated in IVS-R1, T2, and APSG sessions from May 2011 and August 2011, respectively.

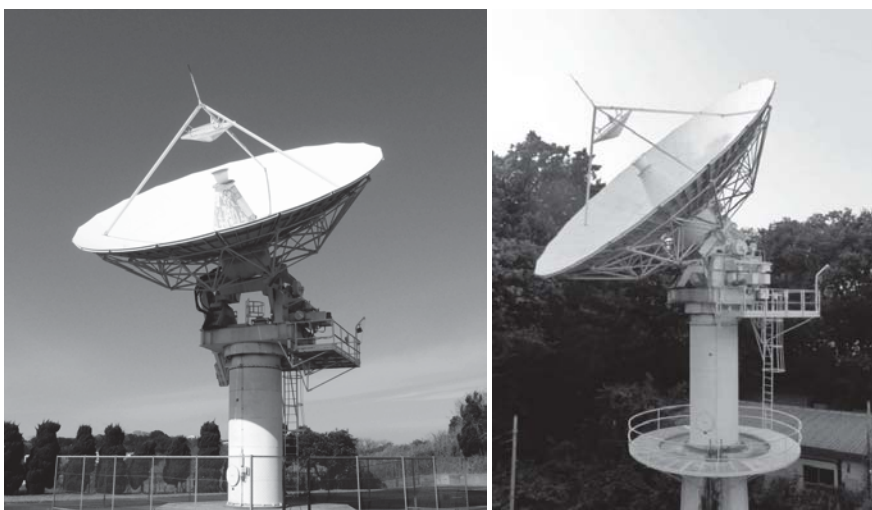


Fig. 2 11-m VLBI antennas at Kashima (left panel) and Koganei (right panel).

Table 1 The antenna parameters of the 11-m antennas.

		Kashima	Koganei
Antenna Type		Cassegrain type	
Diameter		11-m	
Mount Style		Az El mount	
Latitude		N 35° 57' 19.46"	N 35° 42' 37".89
Longitude		E 140° 39' 26.86"	E 139° 29' 17".06
Altitude		62.4 m	125.4 m
Rx Freq. [ MHz ]	S band	2212 ~ 2360	2212 ~ 2360
	X Low band	7700 ~ 8200	7700 ~ 8200
	X High band	8180 ~ 8680	8100 ~ 8600
Local Freq. [ MHz ]	S band	3000	3000
	X Low band	7200	7200
	X High band	7680	7600
SEFD [ Jy ]	X-band	5700	9500
	S-band	3300	5500

## 2 Component Description

### 2.1 Antenna

The antenna parameters of Kashima-11 and Koganei-11 are summarized in Table 1. The band-pass filters for S-band (2212-2360 MHz) were installed in 2010 for radio frequency interference mitigation at both stations.

### 2.2 Data Acquisition System: Sampler

Two sorts of sampler are available at both stations as summarized in Table 2. The K5/VSSP32 [2] has four channels of video band signal input per unit. Four units of K5/VSSP32 constitute one geodetic VLBI terminal with 16 inputs. This system is constantly used for geodetic VLBI observations. This sampler has digital filter functionality realized by FPGA in it. The input video signal is digitized with 8-bit quantization with 64 MHz sampling. Then the frequency bandwidth is restricted and output by reduced data rate for requested sampling mode. The output data is written to a standard Linux file system in K5/VSSP32 format. Data format conversion from K5/VSSP32 to Mark IV, VLBA, and Mark 5B are possible with conversion tools<sup>1</sup>.

The ADS3000+ [3] is a sampler with digital base-band conversion (DBBC) function. Several kinds of data acquisition modes (personalities) are switchable by loading FPGA program. The DBBC mode enables flexible selection of 16 video frequency channels with any of 4/8/16/32 MHz bandwidth. Therefore this can be compatible with conventional 16 channels of geodetic VLBI observations. One channel of 8 bits with 128 MHz sampling mode has been used for astronomical observations with a higher dynamic range, such as pulsar observations. Another channel of 1/2-bit 1024 MHz

<sup>1</sup> Observation and data conversion software for K5/VSSP is freely available from <http://www2.nict.go.jp/aeri/sts/stmg/K5/VSSP/index-e.html>

**Table 2** VLBI data sampler/DAS system available at the Kashima and Koganei 11-m stations.

System	K5/VSSP32(4 units)	ADS3000+(K5/VSI)
Video Converter	K4/KSP 16ch	not necessary
# of Input Channels	4 /unit x 4 units	1 or 2
# of Output Channels	16	1,2, 16
Input Freq. Range	0 - 300 MHz	0 - 2 GHz
Sampling Rate [Msps]	0.04,0.1,0.2,0.5,1, 2,4,8,16,32,64	128, 256, 1024, 2048,4096
Quantization bit	1,2,4,8 bit	
Max. data rate [Mbps]	256 /unit x 4	4096
Output Interface	USB 2.0	VSI-H

sampling is used for wide-band single channel VLBI observations. This mode is going to be used in the Gala-V project [4].

### 2.3 Network Connection

The local area network connections from the Kashima 34-m antenna site to the Kashima 11 m and the Koganei 11 m are 10 Gbps and 1 Gbps, respectively. The observational data of IVS sessions are gathered to the e-VLBI data server at the Kashima 34-m site, and then those data are provided to the correlator through a 1 Gbps network link of the Japanese research network JGN-X.

### 3 Staff

Kawai Eiji: In charge of station care/maintenance and IVS observations.

Hasegawa Shingo: Supporting staff for IVS observation preparation, operation, and maintenance of file servers for e-VLBI data transfer.

Ichikawa Ryuichi: In charge of GNSS station care and GNSS observations.

Sekido Mamoru: In charge of overall activities of the Kashima and Koganei VLBI stations.

## 4 Current Status and Activities

The Kashima and the Koganei 11-m stations are participating in geodetic VLBI sessions IVS-T2, APSG, and JADE, about once a month. These two stations are used as a test bed of R&D experiments including a feasibility study of frequency comparison with VLBI. In addition, flux monitoring of Sgr-A\* with the Kashima — Koganei baseline has been performed in collaboration with S. Takekawa and T. Oka of Keio University [5].

However a tear of cables (coaxial cables and status-control lines) happened at the Kashima 11-m antenna in October 2013 by accident. It was caused by aging and the breaking of strings for cable binding. Loosened cables were caught on the antenna structure during observing. Then they were stretched and torn by antenna motion. The work of replacing the cables was contracted and expected to be finished by early March 2014.

The Koganei 11-m antenna is jointly operated by two groups in the NICT; the STSL and the Space Weather and Environment Informatics Laboratory (SWEIL). When the antenna is not used for VLBI observations, it is used for down link observations from the Stereo satellite<sup>2</sup> by the SWEIL.

## 5 Future Plans

As medium size radio telescopes, the Kashima and the Koganei 11-m antennas have good slew speed (3 degrees/sec) and stable observation performance. This interferometer will be continuously used for good R&D VLBI experiments.

## Acknowledgements

We thank the research network JGN-X and the Information System Section of NICT for supporting the network environment for e-VLBI.

<sup>2</sup> [http://www.nasa.gov/mission\\_pages/stereo/main/index.html](http://www.nasa.gov/mission_pages/stereo/main/index.html)

## References

1. Special issue for the Key Stone Project, J. Commun. Res. Lab., Vol. 46, No. 1, pp.1-221, 1999.
2. Kondo,T., Y. Koyama, R. Ichikawa, M. Sekido, E. Kawai, and M. Kimura, Development of the K5/VSSP System, J. Geod. Soc. Japan, Vol. 54, No 4, pp. 233-248, 2008.
3. Takefuji, et al., “Next-generation A/D Sampler ADS3000+ for VLBI2010”, in VLBI2010: From Vision to Reality, Proceedings from the Sixth IVS General Meeting. Held 7-13 February, 2010 in Hobart, Tasmania, Australia. Edited by D. Behrend and K.D. Baver. NASA/CP 2010-215864., p.378-382, 2010.
4. Sekido M., et al., Development of Wide-band VLBI system (Gala-V), IVS NICT-TDC News No.33, pp.11-14, 2013.
5. Takekawa, S.; Oka, T.; Sekido, M., “Progress Report of the NICT VLBI Monitoring Observations of Sgr A\* at 2 GHz and 8 GHz”, The Astronomer’s Telegram, #5467, 2013.

# Matera CGS VLBI Station 2013 Annual Report

Giuseppe Bianco <sup>1</sup>, Giuseppe Colucci <sup>2</sup>, Francesco Schiavone <sup>2</sup>

**Abstract** This report presents the status of the Matera VLBI station. An overview of the station, some technical characteristics of the system, and staff addresses are also given.

## 1 General Information

The Matera VLBI station is located at the Italian Space Agency's 'Centro di Geodesia Spaziale G. Colombo' (CGS) near Matera, a small town in the south of Italy. The CGS came into operation in 1983 when the Satellite Laser Ranging SAO-1 System was installed. Fully integrated into the worldwide network, SAO-1 was in continuous operation from 1983 up to 2000, providing high precision ranging observations of several satellites. The new Matera Laser Ranging Observatory (MLRO), one of the most advanced Satellite and Lunar Laser Ranging facilities in the world, was installed in 2002, replacing the old SLR system. CGS also hosted mobile SLR systems MTLRS (Holland/Germany) and TLRs-1 (NASA).

In May 1990, the CGS extended its capabilities to Very Long Baseline Interferometry (VLBI), installing a 20-m radio telescope. Since then, Matera has observed in 876 sessions up through December 2012.

In 1991 we started GPS activities, participating in the GIG 91 experiment and installing at Matera a permanent GPS Rogue receiver. In 1994, six TurboRogue SNR 8100 receivers were purchased in

order to create the Italian Space Agency GPS fiducial network (IGFN). At the moment 12 stations are part of the IGFN, and all data from these stations, together with 24 other stations in Italy, are archived and made available by the CGS Web server GeoDAF (<http://geodaf.mt.asi.it>).

In 2000, we started activities with an Absolute Gravimeter (FG5 Micro-G Solutions). The gravimeter operates routinely at CGS and is available for external campaigns on request.

Thanks to the co-location of all precise positioning space based techniques (VLBI, SLR, LLR, and GPS) and the Absolute Gravimeter, CGS is one of the few "fundamental" stations in the world. With the objective of exploiting the maximum integration in the field of Earth observations, in the late 1980s, ASI extended CGS' involvement to include remote sensing activities for present and future missions (ERS-1, ERS-2, X-SAR/SIR-C, SRTM, ENVISAT, and COSMO-SkyMed).

The Matera VLBI antenna is a 20-meter dish with a Cassegrain configuration and an AZ-EL mount. The AZ axis has  $\pm 270$  degrees of available motion. The slewing velocity is 2 deg/sec for both the AZ and the EL axes.

The technical parameters of the Matera VLBI antenna are summarized in Table 1.

The Matera time and frequency system consists of three frequency sources (two Cesium beam and one H-maser standard) and three independent clock chains. The iMaser 3000 H-maser from Oscilloquartz is used as a frequency source for VLBI.

1. Agenzia Spaziale Italiana 1

2. e-geos - an ASI/Telespazio company





**Fig. 1** VLBI antenna and MLRO dome.

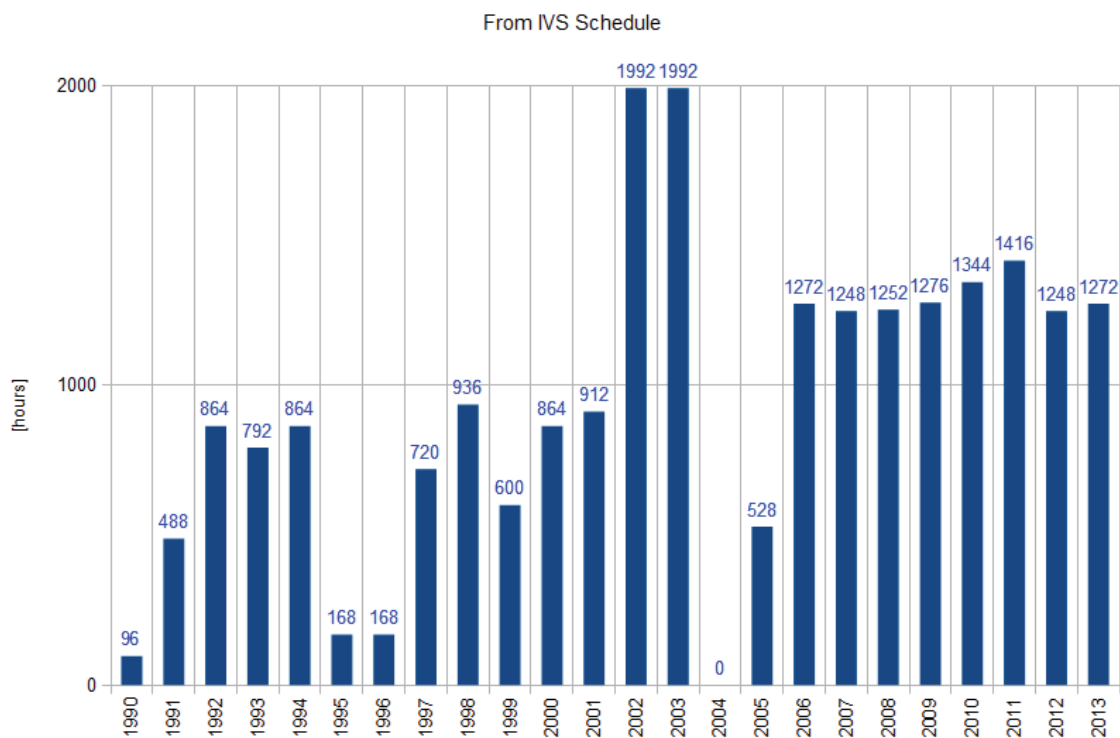
**Table 1** Matera antenna technical specification.

Parameter name	Values (S/X)
Input frequencies	2210–2450 MHz / 8180–8980 MHz
Noise temperature at dewar flange	<20 K
IF output frequencies	190–430 MHz 100–900 MHz
IF Output Power (300 K at inp. flange)	0.0 dBm to +8.0 dBm
Gain compression	<1 dB at +8 dBm output level
Image rejection	>45 dB within the IF passband
Inter modulation products	At least 30 dB below each of 2 carriers at an IF output level of 0 dBm per carrier
$T_{\text{sys}}$	55/65 K
SEFD	800/900 Jy

## 2 Activities during the Past Year

At the end of 2013, the new T4SCIENCE iMaser 3000 was installed. It replaced the >20 years old EFOS-8 maser that was installed at the beginning of the VLBI activities in Matera.

Specifications for this new maser can be found here: [http://www.t4science.com/product/imaser\\_3000](http://www.t4science.com/product/imaser_3000)



**Fig. 2** Observation time.

### 3 Current Status

In 2013, 52 sessions were observed. Figure 2 shows a summary of the total acquisitions per year, starting in 1990.

In 2004, in order to fix the existing rail problems, a complete rail replacement was planned. In 2005, due to financial difficulties, it was instead decided that only the concrete pedestal under the existing rail would be repaired. From then on, no rail movements have been noted [1]-[3].

### 4 Future Plans

In order to plan the eventual building of a VLBI2010 system, the fund raising investigation process has begun. At this moment it is not clear when the budget for starting the project will be ready.

# Medicina Station Status Report

Andrea Orlati, Alessandro Orfei, Giuseppe Maccaferri

**Abstract** General information about the Medicina Radio Astronomy Station, the 32-m antenna status, and the staff in charge of VLBI observations are provided. Updates to the hardware were performed and are briefly described.

## 1 The Medicina 32-m Antenna: General Information

The Medicina 32-m antenna is located at the Medicina Radio Astronomy Station. The station is run by the Istituto di Radioastronomia and is located approximately 33 km east of Bologna. The Consiglio Nazionale delle Ricerche was the funding agency of the Istituto di Radioastronomia until the end of 2004. Since January 1, 2005, the funding agency has been the Istituto Nazionale di Astrofisica (INAF). The antenna, which was inaugurated in 1983, has regularly taken part in IVS observations since 1985 and is an element of the European VLBI network.

A permanent GPS station (MEDI), which is a part of the IGS network, is installed in the vicinity. Another GPS system (MSEL) is installed near the VLBI telescope and is part of the EUREF network.

---

Istituto di Radioastronomia INAF, Medicina

Medicina Network Station

IVS 2013 Annual Report

## 2 Current Status and Activities

- Antenna - VLBI and e-VLBI experimental tests were performed by using fiber optic link instead of coaxial cables to send receiver outputs to VLBI data acquisition system. Fringes were found and compared to the fringes obtained by the coaxial link, nothing of significantly different was observed. Fiber optic link allows much less band disequalization with respect to coaxial connection when using large bandwidth receivers, so Medicina will use fiber optics from now on.
- DBBC - Many VLBI tests were performed in combination with a Mark 5C in parallel with the Mark IV. We are currently running version 104 (Aug14) of the firmware. The FILA10G is now equipped with a new release of the firmware (provided by *HAT LAB*), in order to work around the problem related to the decimation and the track mapping of the Mark 5C (see below).
- Mark 5C - After the repair and upgrade by Condquant, the unit still showed many problems, even if the larger part of them has been solved. The crucial issues still under investigation are:



**Fig. 1** View of the Medicina 32-m dish taken during a geodetic VLBI observations.

- decimation and track mapping capabilities are not yet implemented in Mark 5C software, This prevents the unit to work fully compliant to Mark 5B mode.
- reliability and robustness of *drs* program. We are currently running a buggy version 0.9.9 – 1. The latest release 0.9.9 – 19 is not usable at all, the system crashes every time `reset=erase` is performed.
- Field System - Release 9.11.4 was installed and almost completed with testing. In order to make our FS able to command our Mark 5C, we put in place some ad-hoc solutions. Hopefully we are now able to run a VLBI observation fully compliant to other Mark 5B stations.

The new H-Maser was installed and is regularly used for observation.

The cryogenics of the S/X receivers were restored.

### 3 Staff

Giuseppe Maccaferri returned to his full-time position during 2013.

### 4 Geodetic VLBI Observations

In 2013, Medicina took part in 31 24-hour routine geodetic sessions (namely three IVS-T2, 20 IVS-R4, three EUROPE, two RDV, and three R&D experiments).

# Metsähovi Radio Observatory Network Station 2013 Annual Report

Minttu Uunila <sup>1</sup>, Nataliya Zubko <sup>2</sup>, Markku Poutanen <sup>2</sup>, Juha Kallunki <sup>1</sup>, Ulla Kallio <sup>2</sup>

**Abstract** In 2013, Metsähovi Radio Observatory, together with Finnish Geodetic Institute, observed seven IVS sessions, five T2 sessions, and two EUROPE sessions. Old analog BBCs and Mark 5A were retired during the year, and were replaced by a DBBC and a Mark 5B+. In September, Metsähovi participated in a 4 Gbps e-VLBI demo with a FlexBuff recorder and vlbi\_streamer software that were both developed at the site. Both worked perfectly. A new axis offset for the antenna was calculated.

1992-1994. The radome was replaced with a new one, and new surface panels were installed. Metsähovi and FGI began observing IVS T2 sessions and EUROPE sessions in 2004. Approximately six to eight sessions are observed per year. The surface accuracy of the present telescope is 0.1 mm (rms). The speed of the Metsähovi antenna is 1.2 degrees per second.

Metsähovi is known for its long-term quasar monitoring. Astronomical VLBI observations are carried out with the 22 GHz receiver. The geodetic VLBI receiver of Metsähovi uses right circular polarization and 8.15-8.65 and 2.21- 2.35 GHz frequency bands.

## 1 General Information

Aalto University Metsähovi Radio Observatory and Finnish Geodetic Institute (FGI) are two separate institutes which together form the Metsähovi IVS Network Station. Metsähovi Radio Observatory operates a 13.7 meter radio telescope on the premises of Aalto University at Metsähovi, Kylmälä, Finland, about 35 km from the university campus. In the same area near Metsähovi Radio Observatory, there is the Metsähovi Fundamental Geodetic Station of FGI.

### 2.1 Metsähovi Fundamental Station

Finnish Geodetic Institute is running the Metsähovi Fundamental Station. It is a part of the IAG GGOS Core station network. The instrumentation includes geodetic VLBI (in co-operation with Aalto University), Satellite Laser Ranging (SLR), DORIS, GNSS, and absolute and superconducting gravimeters. Currently, instrumentation is being renewed based on special funding from the Ministry of Agriculture and Forestry. During the next four years, the plan includes a new VGOS compatible radio telescope. FGI is committed to maintain and develop Metsähovi as a geodetic fundamental station.

## 2 Component Description

The Metsähovi Radio Observatory has been operational since 1974. The telescope was upgraded between

1. Aalto University Metsähovi Radio Observatory
2. Finnish Geodetic Institute

Metsähovi Network Station

IVS 2013 Annual Report



Fig. 1 Metsähovi Radio Observatory (photo by Riku Pihlanto).

### 3 Staff

FGI is responsible for the geodetic VLBI observations and is the owner of the S/X receiver. The radio telescope is owned and operated by the Aalto University, and an annual agreement is made on its use for geodetic VLBI sessions. It is not possible to increase the number of annual sessions (currently six to eight) because the telescope is mainly used for astronomical observations. Operation during the geo-VLBI sessions and technical questions are handled jointly; all other technical work, telescope maintenance, and maintenance of instrumentation are done by the personnel of the radio telescope.

Metsähovi Radio Observatory personnel working with IVS observations are listed in Table 1. From June 2013 D.Sc.(tech.) Minttu Uunila has been in charge of IVS VLBI observations at Metsähovi replacing, Dr. Elizaveta Rastorgueva-Foi. The preparation, operation of IVS observations, and submission of data are provided by staff from FGI. The personnel engaged in the work are listed in Table 1.

### 4 Current Status and Activities

#### 4.1 IVS Sessions

Metsähovi and FGI observed seven IVS sessions, five T2 sessions and two EUROPE sessions in 2013. The first session, T2089, was observed with two recording systems in parallel: the old system with analogue BBCs and Mark 5A and the new one with DBBC and Mark 5B. During the T2089, some problems with the DBBC in channels 05-08 were detected. The data with an analog system were of better quality and were used by correlators. All next sessions were recorded only with the new system (DBBC and Mark 5B). The problems with the DBBCs channels 05-08 continued throughout 2013. DBBC boards will be repaired in 2014 (see in BBC/DBBC status). Due to problems with DBBC and Mark 5 during session T2090, the amount of correlated data was only 40 %. T2093, EUR126 and T2094 were almost problem free. However, during some scans, the antenna was slewing.

**Table 1** Staff at Metsähovi Radio Observatory and at FGI involved in geodetic observations during 2013.

Staff at Metsähovi Radio Observatory		
Name	Title	Responsibility
Dr. Juha Kallunki	Laboratory manager	VLBI equipment, NEXPreS
M.Sc.(tech.) Ari Mujunen	Laboratory manager	NEXPreS
Dr. Elizaveta Rastorgueva-Foi	VLBI friend	VLBI observations
D.Sc.(tech.) Minttu Uunila	post-doctoral researcher, IVS on-site technical contact	VLBI equipment, IVS observations
M.Sc.(tech.) Petri Kirves	Operating engineer	Receivers
Tomi Salminen	Research assistant (until 6/2013)	NEXPreS
Staff at Finnish Geodetic Institute		
Name	Title	Responsibility
Prof. Markku Poutanen	Head of the Department of Geodesy and Geodynamics	Metsähovi research station
Dr. Nataliya Zubko	Senior research scientist	IVS observations, analysis
M.Sc. Veikko Saaranen	Special research scientist	operation of IVS observations
M.Sc. Ulla Kallio	Senior research scientist	Local ties measurements
M.Sc. Simo Marila	Research scientist	operation of IVS observations
Dr. Diego Meschini	Research scientist	research on correlation
Dr. Jyri Näränen	Special research Scientist	Metsähovi infrastructure

## 4.2 Technical Activities and Issues

### 4.2.1 BBC/DBBC status

The old analog rack retired in early 2013. The DBBC arrived in September 2012 with the stand-alone FILA10G. We had some issues with one group-of-four BBCs (BBC05-08) and the boards will be repaired in January 2014.

### 4.2.2 Recording systems

We developed a new DAQ system, the FlexBuff, using COTS components. Local UDP streaming performance tests were performed with wirespeed 10GE. Long (30 minute) tests demonstrated the ability to write at maximum wire speed with zero packet loss. Writing 34 disks without a network (using local machines), the architecture can handle 40 Gbps, and it can always handle >30 Gbps. A 4 Gbps e-VLBI demo in September proved that the FlexBuff and its recording software `vlbi_streamer` work impeccably. Also FILA10G was employed in the test to enable 4 Gbps recording.

Our old Mark 5A was retired. We had problems with our Mark 5B+ Stream Stor board, but now at the end of the year we received it back from warranty repair by Conduant. We have loaned a Mark 5C Stream-Stor board from the Max Planck Institute for Radio Astronomy. 2014 will start with testing the repaired board.

We have switched to using JIVE's `jive5ab` instead of DIMino.

## 4.3 Data Analysis

In 2010, FGI and Metsähovi Radio Observatory received funding for four years from the Academy of Finland to start geodetic VLBI data analysis. In 2013, one doctoral dissertation was finished (M. Uunila: "Improving geodetic VLBI: UT1 accuracy, latency of results and data quality monitoring").

Data analysis at FGI is performed by N. Zubko. The project of source structure study and its influence on estimated geodetic VLBI parameters has been continued in cooperation with E. Rastorgueva-Foi. Diego Meschini is responsible for correlation.



**Fig. 2** Metsähovi radio telescope.

### 4.3.1 Axis offset calculations

The new value of the axis offset  $-3.6$  mm was estimated from local tie measurements performed by Ulla Kallio during the geo-VLBI sessions since 2008. The offset is different from the earlier value  $+5.1$  mm estimated using the time delay observations. We investigated the effect of changing the offset on the coordinates by analyzing the geodetic VLBI campaigns with the old and the new axis offset values [1]. The difference between the old and new coordinates show that the agreement between the vectors from the IGS GPS point METS to the reference point of the VLBI telescope Metsähovi calculated from ITRF coordinates and estimated from local tie data could improve when using the new value.

### 4.3.2 Local Ties between VLBI and GPS at Metsähovi

The local tie measurements between the co-located instruments at Metsähovi are provided by Ulla Kallio. A local tie between IGS station METS and the VLBI antenna reference point was regularly performed with kinematic GPS measurements during the geo-VLBI campaigns starting in 2008. Testing shows that a millimeter level accuracy can be achieved in local tie vector determination with the kinematic GPS method. In 2013, the influence of thermal deformations in the local tie vector were studied and taken into account in data processing. In June 2013, the GPS antennas were taken down and sent to Gottfried Wilhelm Leibniz Universität Hannover and Rheinische Friedrich-Wilhelms-Universität Bonn for calibration as a part of the EMRP SIB60 (European Metrology Research Programme, Metrology for long distance surveying). The antennas will be re-established in January 2014.

### 4.3.3 Meetings

An IVS training school on VLBI for Geodesy and Astrometry was organized at Aalto University in Espoo, Finland on March 2–5, 2013. The meeting was sponsored by IVS, the European Geosciences Union (EGU), Onsala Space Observatory (OSO), RadioNet, Aalto University and the Finnish Geodetic Institute. A total of 60 people participated in the School.



Fig. 3 Group photo of EVGA excursion to Metsähovi.

The school was followed by the 21st Meeting of the European VLBI Group for Geodesy and Astrometry (EVGA) and the 14th IVS Analysis Workshop on March 5–8, 2013. The number of participants was 70. A half-day trip to Metsähovi was made on the last day of the meeting.

## 5 Future Plans

In 2014, Metsähovi is scheduled to participate in three EUROPE sessions and four T2 sessions. Minttu Uunila will be EVN VLBI and technical friend for Metsähovi starting from January 2014 and will be in charge of all VLBI observations at Metsähovi Radio Observatory. The DBBC boards will be repaired in January 2014.

## Acknowledgements

FGI and Metsähovi teams acknowledge support from the Academy of Finland (grant number 135101).

## References

1. U. Kallio and N. Zubko. The effect of the systematic error in the axis offset value on the coordinates estimated in VLBI data analysis. Proceedings of the 21th Meeting of the EVGA, edited by N. Zubko and M. Poutanen, p. 237-241, 2013.



# VERA 2013 Geodetic Activities

Takaaki Jike, Yoshiaki Tamura, Makoto Shizugami

**Abstract** The geodetic activities of VERA in the year 2013 are briefly described. The regular geodetic observations are carried out both in K- and S/X-bands. The frequency of regular observations are three times a month—twice for the VERA internal observations in K-band. The networks of the S/X sessions are JADE of GSI and IVS-T2. The raw data of the T2 and JADE sessions are electronically transferred to the Bonn, Haystack, and GSI correlators via Internet. Gravimetric observations are carried out at the VERA stations. Superconducting gravimeters installed at Mizusawa and Ishigakijima in order to monitor precise gravity change, and the observations continued throughout this year. The crustal movements generated by the 11-March-2011 earthquake off the Pacific coast of Tohoku continued during 2013, and displacement of the VERA-Mizusawa position by post-seismic creeping continued.

## 1 General Information

VERA is a Japanese domestic VLBI network consisting of the Mizusawa, Iriki, Ogasawara, and Ishigakijima stations. Each station is equipped with a 20-m radio telescope and a VLBI backend. The VERA Mizusawa 20-m antenna is shown on the left in Figure 1. The small antenna on the right is the Mizusawa 10-m antenna. The VERA array is controlled from the Array Operation Center (AOC) at Mizusawa via Internet.

Mizusawa VLBI Observatory, National Astronomical Observatory of Japan

VERA Network Station

IVS 2013 Annual Report

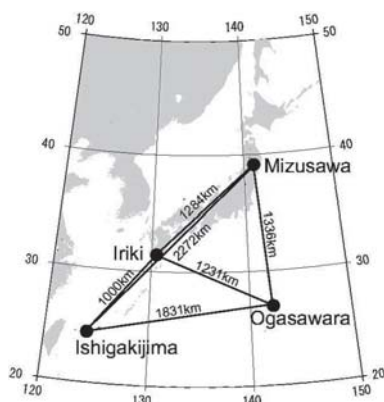


Fig. 1 VERA Mizusawa 20-m antenna (left) and 10-m antenna.

The primary scientific goal of VERA is to reveal the structure and the dynamics of our galaxy by determining three-dimensional force field and mass distribution. Galactic maser sources are used as dynamical probes, the positions and velocities of which can be precisely determined by phase referenced VLBI relative to extragalactic radio sources. The distance is measured as a classical annual trigonometric parallax. The observing frequency bands of VERA are S and X, K (22 GHz), and Q (43 GHz). Geodetic observations are made in S/X- and K-bands. Q-band is currently not used for geodesy. Only a single beam is used even in K-band in geodetic observations, although VERA can observe two closely separated ( $0.2^\circ < \text{separation angle} < 2.2^\circ$ ) radio sources simultaneously by using the dual beam platforms.

General information about the VERA stations is summarized in Table 1, and the geographic locations are shown in Figure 2. The lengths of the baselines range from 1000 km to 2272 km. The skyline at Ogasawara station ranges from  $7^\circ$  to  $18^\circ$  because it is located at the bottom of an old volcanic crater. The north-east sky at Ishigakijima station is blocked by a nearby

high mountain. However, the majority of the skyline is below  $9^\circ$ . The skylines at Mizusawa and Iriki are low enough to observe sources with low elevation. Since Ogasawara and Ishigakijima are small islands in the open sea and their climate is subtropical, the humidity in the summer is very high. This brings about high system temperatures in the summer, in particular in K and Q bands. These stations and Iriki station are frequently hit by strong typhoons. The wind speed sometimes reaches up to 60–70 m/s.



**Fig. 2** Distribution of the stations in the VERA Network.

**Table 1** Location.

Site name	Longitude	Latitude	Altitude
Mizusawa	141° 07' 57".199 E	39° 08' 00".726 N	75.7 m
Iriki	130° 26' 23".593 E	31° 44' 52".437 N	541.6 m
Ogasawara	142° 12' 59".809 E	27° 05' 30".487 N	223.0 m
Ishigakijima	124° 10' 15".578 E	24° 24' 43".834 N	38.5 m

## 2 Current Status

Parameters of the antennas and front- and back-ends are summarized in Tables 2 and 3, respectively. Two observing modes are used in geodetic observations. One is the VERA internal observation in K-band with the recording rate of 1 Gbps. The other is the conventional S/X-band observation with K5-VSSP. JADE, which is GSI's domestic observation project, and IVS-T2 sessions belong to this class. Only Mizusawa and Ishigakijima participated in these sessions.

**Table 2** Antenna parameters.

Diameter of main reflector	20-m	
Mount type	AZ-EL	
Surface accuracy	0.2mm (rms)	
Pointing accuracy	<12" (rms)	
	Azimuth	Elevation
Slew range	-90° – 450°	5° – 85°
Slew speed	2.1°/sec	2.1°/sec
Acceleration	2.1°/sec <sup>2</sup>	2.1°/sec <sup>2</sup>
	S	X K
HPBW	1550"	400" 150"
Aperture efficiency	0.25	0.4 0.47

**Table 3** Front-end and back-end parameters.

Front-end parameters			
Frequency band	S	X	K
Frequency range (GHz)	2.18–2.36	8.18–8.60	21.5–24.5
Receiver temperature	>100 °K	100 °K	39±8 °K
Polarization	RHC	RHC	LHC
Receiver type	HEMT	HEMT	cooled HEMT
Feed type	Helical array		Horn
Back-end parameters			
Observation type	VERA	T2 and JADE	
channels	16	16	
Bandwidth/channel	16MHz	4MHz	
Filter	Digital	Analog video band	
Recorder	DIR2000	K5VSSP	
Recording rate	1 Gbps	128 Mbps	
Deployed station	4 VERA	Mizusawa, Ishigakijima	

## 3 Staff

Noriyuki Kawaguchi is the director of Mizusawa VLBI Observatory. The geodesy group consists of Yoshiaki Tamura (scientist), Takaaki Jike (scientist), and Makoto Shizugami (engineer).

## 4 Activities during the Past Year

VERA observes seven days a week, except for a maintenance period in June and July. The 24-hour geodetic sessions are allocated twice or three times in a month. Among these geodetic sessions, VERA internal geodetic observations in K-band are performed once or twice in a month, and Mizusawa and Ishigakijima participate in JADE by GSI or IVS-T2 sessions in S/X-band on a once-a-month basis. The main purpose of the VERA

internal geodetic observations is to determine relative positions of the VERA antennas accurate enough for astrometric requirements. The purpose of the S/X sessions is to make the VERA coordinates refer to the IVS reference frame.

In VERA internal geodetic sessions, the regularly-used frequency changed from S/X-band to K-band in 2007. The reason for the shift of the observing frequency band from S/X-band to K-band is to avoid the strong radio interference by mobile phones in S-band, particularly at Mizusawa. The interfering signal which has line spectra is filtered out. However, this filtering considerably degrades the system noise temperature. The interference zone is increasing, so it is likely that S-band observations will become impossible in the near future. On the other hand, VERA has the highest sensitivity in K-band as shown in Table 3. Thanks to the high sensitivity in this band, the maximum number of scans in K-band is 800/station/24-hours while that in S/X-band is 500 at most. It has been confirmed that the K-band observations are far more precise. In fact, standard deviations of the individual determinations of the antenna positions in K-band are less than half of those in S/X-band.

In 2013, the long maintenance period from the beginning of June to the middle of August was allocated. Except for this period, VERA carried out regular VLBI observations. We participated in seven T2 sessions and in four JADE sessions. VERA internal geodetic observations were carried out 16 times. The final estimation of the geodetic parameters was derived by using the software developed by the VERA team.

Continuous GPS observations were carried out at each VERA station throughout the year. The superconducting gravimeter (SG) installed within the enclosure of the Mizusawa VLBI observatory, in order to accurately monitor gravity change for the purpose of monitoring height change at the VERA Mizusawa station, continued acquisition of gravity data. Four water level gauges surrounding the SG were used for monitoring the groundwater level. The preliminary results show that gravity variation due to the variation of the water table can be corrected as accurately as the 1 micro gal level. An SG was newly installed also in the VERA Ishigakijima station, and observations were started in January 2012. The observations continued also during 2013. This observing aims at solving the cause of the slow slip event which occurs frequently around the Ishigaki island.

## 5 State of the Crustal Movement after the 11-Mar-2011 Earthquake at Mizusawa

After the 2011 earthquake off the Pacific coast of Tohoku (Mw=9.0) [Epoch=11 March 2011, 14:16:18 JST], VERA-Mizusawa was displaced by co-seismic crustal movement and post-seismic creeping. Also during 2013, the creeping continued, although the speed declined. According to the newest analysis, the co-seismic steps are  $X=-2.013$  m,  $Y=-1.380$  m, and  $Z=-1.072$  m, and the displacement by creeping during 2013 is  $X=-0.110$  m,  $Y=-0.089$  m, and  $Z=-0.036$  m.

## 6 Future Plans

Currently, the examination into increasing the recording rate from 1 Gbps to 4 Gbps with direct sampling (OCTAD) is being carried out. The reconstruction accompanying this specification change is planned also at SX system. Furthermore, the examination of changing the recording system from tape recorder to HDD (OCTADISK) is also in force. With these changes, the operation of the new software correlation system (OC-TACOR2) is due to become regular.

# Noto Station Status Report

Gino Tuccari

**Abstract** The Noto VLBI station was fully operational in 2013. Important progress was achieved in the technological and instrumentation area. A great effort was made to develop and realize VGOS (formerly VLBI2010) compatible front- and back-end systems. The fast connection at 10 Gbps was installed.

## 1 Antenna and Receivers

The mechanical parts for the frequency agility installation in the antenna are ready and will be transferred to the Noto site at the beginning of 2014. The installation is planned to be after the first EVN session in 2014, when the company specialized for this type of operations will be available to visit Noto. The new VGOS broadband DBBR receiver operating in the range of 1-16 GHz is progressing. The feed and cryogenic sections were completed. The choice of possible front-end LNAs is under evaluation. This receiver was developed to operate on a typical 12-meter VGOS antenna and will be adapted to the Noto 32-m radio telescope, making use of a tertiary mirror operating in the vertex room. The receiver after appropriate amplification of the entire broadband is operating entirely in the digital domain. It indeed is part of the DBBC3 system, even though it can be operated also in an independent environment. The two receivers operating in the range of 80-100 GHz for the secondary focus and purchased from IRAM will not be installed for now in the antenna

Istituto di Radioastronomia INAF, Noto

Noto Network Station

IVS 2013 Annual Report

because of a lack of funds. Indeed a dedicated tertiary mirror for properly focusing the beam is necessary as the replacement of the existing secondary mirror. Waiting for the proper financing one such receiver will be adapted for measuring the atmospheric transparency, with the help of a small antenna and a pointing structure, providing that a dedicated local oscillator can be realized with the existing resources.

## 2 H-maser

The new maser was installed in October, while the old EFOS-5 was modified to be kept active in parallel with the new one. Additional equipment is going to be installed in order to have a continuous comparison between the two atomic clocks.

## 3 e-VLBI

The connection at 10 Gbps was activated in October 2013. Nowadays in the station e-VLBI observations at 1 Gbps are routine operations.

## 4 DBBC

The DBBC2 system is now active as the main VLBI backend even if the system is still not fully complete for VLBI2010. A full implementation is expected in the next months. Since autumn all the observations, including the EVN session, have been observed with

this terminal. The Ethernet interface FILA10G is now available, so having the 10 G connection available, 4 and 8 Gbps e-VLBI experiments are today possible with Noto.

The DBBC3 project, a collaboration of IRA (Italy) - MPI (Germany) - (OSO) Sweden, is progressing as expected in the scheduled time. The main parts that have been realized are: the sampler ADB3, operating at 4 GHz bandwidth, and the CORE3 board, able to process pieces of the same bandwidth in DDC and PFB mode. The FILA40G unit has been assembled. Its functionality is to receive multiple 10G connections coming from the output of the CORE3 boards and handling the data Ethernet packets for different functionalities. One of them is the recording capability at 32 Gbps. A first DBBC3 unit will be tested in Noto during 2014 with the DBBR receiver. Figure 1 and Figure 2 show a stack of ADB3 and CORE3, and a FILA40G, respectively.

## **5 Observations**

During 2013, 12 geodetic experiments have been observed: CRF73, EUR121, EUR122, CRF74, EUR123, EUR124, CRF75, T2091, EUR125, T2092, EUR126, and T2094.



**Fig. 1** Stack of DBBC3 boards for dual polarization.



**Fig. 2** FILA40G.

# Ny-Ålesund Geodetic Observatory 2013 Annual Report

Moritz Sieber

**Abstract** In 2013, the 20-m telescope at Ny-Ålesund, Svalbard, operated by the Norwegian Mapping Authority (NMA), took part in 209 out of 211 scheduled sessions of the IVS program.

## 1 General Information

The Geodetic Observatory of the Norwegian Mapping Authority (NMA) is situated at 78.9° N and 11.9° E in Ny-Ålesund, in Kings Bay, at the west side of the island Spitsbergen. This is the biggest island in the Svalbard archipelago. In 2013, Ny-Ålesund was scheduled for 125 24-hour VLBI sessions, including R1, R4, EURO, RD, T2, and RDV sessions, and 86 one-hour sessions within the Intensives-program.

In addition to the 20-meter VLBI antenna, the Geodetic Observatory has two GNSS antennas in the IGS system and a Super Conducting Gravimeter in the Global Geodynamics Project (GGP) installed at the site. A second gravimeter (a GWR “iGrav”) got set up in September and will replace the former system after a period of parallel measurements. The French-German AWIPEV research base in Ny-Ålesund operates a DORIS station. In October 2004, a GISTM (GPS Ionospheric Scintillation and TEC Monitor) receiver was installed at the Mapping Authority’s structure in the frame of ISACCO, an Italian research project on ionospheric scintillation observations, led by Giordiana De Franceschi of the Italian Institute

Norwegian Mapping Authority, Geodetic Institute

NYALES20 Network Station

IVS 2013 Annual Report



**Fig. 1** Telescope seen from east.

of Volcanology and Geophysics (INGV). Another Real-Time Ionospheric Scintillation (RTIS) Monitor was set up by the NMA in November 2012.

### 1.1 Component Description

The antenna with 20-m diameter is intended for geodetic use and receives in S- and X-band. Its design and construction are similar to those at Green Bank and Kokee Park. A rack with 14 video-converters, Mark IV decoder, and Mark 5 sampler streams the data to a Mark 5B+ recorder. A Mark 5A-unit is used to transfer data via network to the correlators. Timing and frequency is provided by a NASA NR maser, which is monitored by a CNS system.

## 1.2 Staff

The staff at Ny-Ålesund consists of four people employed at 75 %, which means that three full-time positions are covered (see Table 1 for an overview). Each position goes with a three-year contract that can be extended up to 12 years, but in average people stay 3–4 years. The observatory is part of the Geodetic Division of the Norwegian Mapping Authority with its main office at Hønefoss (near Oslo).

During 2013, Åsmund Skjæveland moved back to the mainland to the love he found—all the best wishes for the two of you. He is still within reach however, working at the NMA's control center for the SATREF-network. His open position was covered by Susana García-Espada, who was previously working at the station in Yebees, and she brought some sun and Spanish air to Ny-Ålesund. Welcome to the Arctic!

**Table 1** Staff related to VLBI operations at Ny-Ålesund.

Hønefoss	Section Manager Technical Manager	Reidun Kittelsrud Leif Morten Tangen
Ny-Ålesund	Station Manager Engineer Engineer Engineer Engineer	Moritz Sieber Susana García-Espada (≥ Sept.) Geir Mathiassen Kent Roskifte Åsmund Skjæveland (≤ May)

## 2 Current Status and Activities

### 2.1 Maintenance

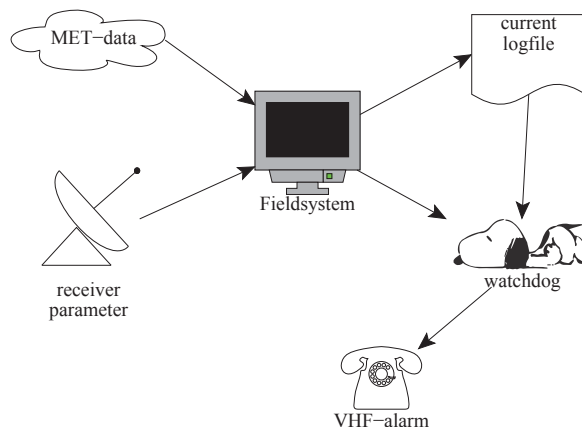
The main bearings in one of the Az-gearboxes showed wear; as well, the top radial shaft seal was broken, leading to both oil leakage and water contamination of the lubrication system. So the whole gearbox was replaced during the maintenance period in summer, which had to be extended by one week. Everything worked well, and the gearbox that was taken down will be overhauled to provide a working spare one again.

### 2.2 Monitoring

The monitoring system has been extended by the ability to send alerts by VHF radio (see Figure 2 for a flowchart). Due to the situation in Ny-Ålesund (being in a small village without mobile phone coverage and living and working at the same place) this was preferred to sending e-mails or short-messages. The watchdog runs as a cron-job on the Field System computer. It checks if the Field System is running and asks for the current logfile-name. This is the only interaction between these two processes; once the logfile is known, the data since the last run is searched for keywords and figures such as:

- receiver 20K/70K temperature levels
- Dewar pressure
- Helium supply pressure
- wind speed
- Field System error codes <CC>, -<nnn>

If one of the values exceeds a threshold or an error code matches one on a predefined list, either a warning or alarm message is broadcast via VHF. Once received on the operators' radio it triggers an alarm.



**Fig. 2** VHF alerting system.

In combination with the e-control software by A. Neidhardt et al., this is an excellent tool to react quickly even at night, thus making night shifts unnecessary and enabling operators to work together during ordinary working hours (sharing knowledge) instead of going on separate shifts.



## 2.3 GPS Campaign

During late August, the triennial GPS campaign was carried out by Knut Gjerde from the Geodetic Institute, Hønefoss. 18 bolts of the reference network around Ny-Ålesund were measured over a period of five days each.

## 2.4 Session Performance

By the end of 2012, Ny-Ålesund was scheduled for 121 24h- and 46 1h-sessions. By the end of 2013, 123 of 125 24h- and 86 1h-sessions were observed. The increase in the number of 1h-Intensives is due to replacing Wettzell in the Int1 and Int2 series during their repair between July and September. For one R1- and one R4-session Ny-Ålesund had to be taken out of the schedule due to the extension of maintenance work; as a compensation, three sessions during December and one in May were added. Four of the remaining sessions were recorded with 98% or less. A summary can be found in Table 2.

**Table 2** Sessions with trouble (that recorded 98% or less).

Session	Comments
R4576	not scheduled (announced maintenance period), but in performance matrix
RV100	interrupted observation for participation in Int1
T2091	interrupted observation for participation in Int1
RD1308	receiver warming up. stopped to cool down in time for succeeding R4
R4606	missed some scans by troubleshooting receiver monitoring issues
R1605	does not appear in schedule statistics, but observed as scheduled
R1606	not observed due to warm receiver
R4596	removed from schedule, extending maintenance period

## 2.5 New Observatory

Due to the proximity of the airfield to the current location, the new observatory has to be built further away. A road must be built first, and due to the Arctic and environmental conditions (removal and regrowth of top soil), this can only happen during the “summer”

months between June and October. More than the first half of it, including a bridge and a culvert section to cross a riverbed, was finished in 2013, and work will continue next year.

## 2.6 New Instrumentation

In September, a new GWR instrument iGrav 007 gravimeter was installed. It will replace the old superconducting gravimeter which needed a refill with liquid helium every now and then. The former system will be shipped to the mainland after some months of parallel measurements.

## 3 Future Plans

Ny-Ålesund will participate in CONT14. Related to that, the media pool has to be upgraded. The current Mark IV rack will be replaced by a digital backend system, both to replace the aged video converters and to gain experience with the new system that will be installed at the new site. The road construction will continue, and first preparations on the new observatory’s site will be performed. By end of the year the last remaining hundred miles between Ny-Ålesund and Longyearbyen will be covered by fiber cable, replacing the current radio link. The cable is supposed to be operational in early spring 2015.

# German Antarctic Receiving Station (GARS) O’Higgins

Alexander Neidhardt <sup>1</sup>, Christian Plötz <sup>2</sup>, Thomas Klügel <sup>2</sup>, Torben Schüler <sup>2</sup>

**Abstract** In 2013, the German Antarctic Receiving Station (GARS) O’Higgins contributed to the IVS observing program with four observation sessions in February. Maintenance and upgrades were made and are in progress; e.g. the complete receiver was dismounted and shipped to Wettzell. A new replacement dewar was finished in the labs of the observatory in Yebes, Spain.

## 1 General Information

The German Antarctic Receiving Station (GARS) is jointly operated by the German Aerospace Center (DLR) and the Federal Agency for Cartography and Geodesy (BKG, belonging to the duties of the Geodetic Observatory Wettzell (GOW)). The Institute for Antarctic Research Chile (INACH) coordinates the activities and logistics. The 9-m radio telescope at O’Higgins is mainly used for downloading of remote sensing data from satellites such as TanDEM-X and for the commanding and monitoring of spacecraft telemetry. During dedicated campaigns in the Antarctic summer it is also used for geodetic VLBI. In 2013, the station was again manned by DLR staff and by a team for the maintenance of the infrastructure (e.g. power and freshwater generation) the entire year. BKG staff was there from January to the beginning of March. The VLBI campaign in November—December

2013 had to be canceled again, as the VLBI receiver is currently in Wettzell for maintenance.

Over the last few years, special flights using “Hercules C-130”-aircrafts and small “Twin Otter DHC-6”-aircrafts as well as transportation by ship were organized by INACH in close collaboration with the Chilean Army, Navy and Airforce and with the Brazilian and Uruguayan Airforce in order to transport staff, technical material and food for the entire stay from Punta Arenas via Base Frei on King George Island to O’Higgins on the Antarctic Peninsula. The conditions for landing on the glacier are strongly weather dependent and involve an increasing risk; in general, transport of personnel and cargo is always a challenging task. Arrival and departure times strongly depend on the climate conditions and on the logistic circumstances.

After each Antarctic winter the VLBI equipment at the station must be initialized again. Damages resulting from the winter conditions or strong storms have to be identified and repaired. Shipment of each kind of material, such as spare parts or upgrade kits, has to be carefully prepared in advance.

Besides the 9-m VLBI antenna, which is used for the dual purposes of receiving data from and sending commands to remote sensing satellites and performing geodetic VLBI, other geodetically relevant instruments are also operated upon on location:

- an H-maser, an atomic Cs-clock, a GPS time receiver, and a Total Accurate Clock (TAC) offer time and frequency.
- two GNSS receivers both operating in the frame of the IGS network, while one receiver is additionally part of the Galileo CONGO network. The receivers worked without failure.

1. Forschungseinrichtung Satellitengeodäsie (FESG), Technische Universität München

2. Bundesamt für Kartographie und Geodäsie (BKG)



**Fig. 1** The Web cam image of the VLBI antenna and some real-time penguin cams from the O'Higgins Web page.

- a meteorological station providing pressure, temperature, and humidity and wind information, as long as the temporarily extreme conditions did not disturb the sensors.
- a radar tide gauge which was installed in 2012. The radar sensor itself is space referenced by a GPS-antenna mounted on top and Earth referenced via the local survey network. The radar gauge is operated only during the Antarctic summer.
- an underwater sea level gauge for permanent monitoring of water pressure, temperature, and salinity.

## 2 Staff

The members of staff for operation, maintenance and upgrade of the VLBI system and other geodetic devices are summarized in Table 1.

**Table 1** Staff - members of RTW.

Name	Affiliation	Function	Mainly working for
Torben Schüler	BKG	head of the GOW (since January 2013)	GOW
Christian Plötz	BKG	electronic engineer (chief engineer RTW)	O'Higgins, RTW, TTW
Christian Schade	BKG	geodesist	O'Higgins operator, SLR
Reiner Wojdziak	BKG	software engineer	O'Higgins, IVS Data Center Leipzig
Andreas Reinhold	BKG	geodesist	O'Higgins operator
Thomas Klügel	BKG	geologist	administration laser gyro/ local systems Wettzell
Rudolf Stoeger	BKG	geodesist	logistics for O'Higgins, GNSS
Alexander Neidhardt	FESG	head of the VLBI group and VLBI station chief	RTW, TTW
Gerhard Kronschnabl	BKG	electronic engineer (chief engineer TTW)	TTW, RTW, TIGO

## 3 Observations in 2013

GARS participated in the following sessions of the IVS observing program during the Antarctic summer campaign (January-March 2013):

- IVS-OHIG82 February 11 - 12, 2013
- IVS-OHIG83 February 13 - 14, 2013
- IVS-T2088 February 19 - 20, 2013
- IVS-OHIG84 February 20 - 21, 2013

The observations were recorded with Mark 5A. The related data modules were carried from O'Higgins to Punta Arenas by the staff members on their way back home. From Punta Arenas, the disk units were shipped by regular air freight back to Wettzell and then to the correlator in Bonn, Germany.

## 4 Technical Improvements and Maintenance

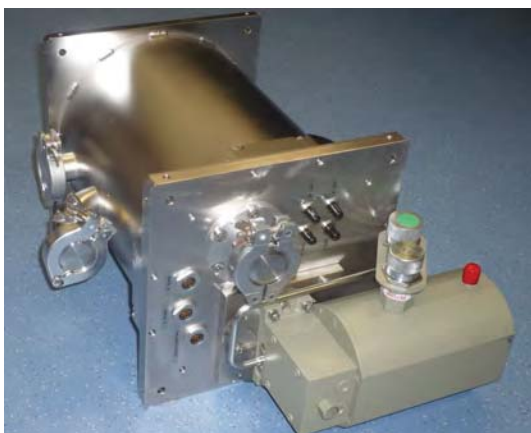
The extreme environment conditions in the Antarctic require special attention to the GARS telescope and the infrastructure. Corrosion frequently results in problems with connectors and capacitors. Defective equipment needs to be detected and replaced. The antenna, the S/X-band receiver, the cooling system, and the data acquisition system have to be activated properly. A prob-

lem is the low transfer rates (often with only 50 kbps) on the communication connection, so the Internet and phone access were reduced. Also, the Web cams are regularly maintained.

Special maintenance tasks focused on the stabilization of the timing system, where the NTP-server is now connected to the external PPS-signal of the Cesium standard. The GNSS-antennas had to be cleaned from salt debris, and the acquisition PC of the GNSS point OHI2 was replaced by a low maintenance PC box.

The meteorological data are now directly available on the Web pages with an update interval of one minute. Because of some defective connectors, the radar gauge had to be dismantled and repaired.

The construction of the new dewar is finished now in order to replace the original O'Higgins dewar. The current one must be evacuated permanently by a turbo molecular pump to maintain the required vacuum due to leakage. The new one is currently at the observatory at Wettzell to be tested.



**Fig. 2** The new dewar for the VLBI system at O'Higgins.

The dismantled receiver is currently at the observatory at Wettzell for maintenance. The idea is to fix overaged parts and to integrate a new control equipment.

The remote control of complete VLBI sessions could be extended. Using the newly developed Wettzell software the O'Higgins Field System can be controlled over a secure Internet connection from Wettzell. This is a key feature to extend the operation periods in GARS O'Higgins. Another technique, using the download and commanding gaps for geodetic

VLBI, was discussed with the DLR and is planned to be realized. But it requires a suitable communication with the scheduling and control programs of the DLR.

A complete geodetic survey was performed with equipment from Wettzell (total station TCA 2003) in addition to the VLBI observations, to determine the local ties. Additional leveling surveys were included, using the equipment DNA 03.

## 5 Future Plans

The replacement dewar must be installed again after the tests at Wettzell. The maintained receiver must also be installed again. A dedicated plan should offer a shared, interleaved observation of satellites (DLR) and VLBI sources (BKG) during the whole year. In order to optimize the operating procedure and the disposition of staff, a common control room for DLR and BKG staff is in preparation. Some antenna motors must be replaced, and a gear needs to be inspected.

# Onsala Space Observatory – IVS Network Station Activities During 2013

Rüdiger Haas, Gunnar Elgered, Johan Löfgren, Tong Ning, Hans-Georg Scherneck

**Abstract** We participated in 40 IVS sessions. As in the previous five years, we used several of the sessions that involved both Onsala and Tsukuba to perform ultra-rapid UT1-UTC observations together with our colleagues in Tsukuba. Additionally, we observed two dedicated ultra-rapid sessions. The first was together with Tsukuba, Hobart, and HartRAO and aimed at determining ultra-rapid EOP. The second was together with Tsukuba and aimed at a northern hemisphere ultra-rapid UT1-UTC determination in parallel with the AUST-13-06 session. We also performed a short session in which we observed a GLONASS satellite using the Onsala 25-m telescope and the Wettzell 20-m telescope. The progress of the Onsala Twin Telescope (OTT) project was unfortunately delayed due to issues concerning wildlife protection. Extensive OTT simulation studies were performed, trying to optimize the sky visibility from a number of possible antenna locations. An updated application for the installation was submitted to the authorities at the end of 2013.

## 1 General Information

The Onsala Space Observatory is the national facility for radio astronomy in Sweden with the mission to support high-quality research in radio astronomy and geosciences. The observatory was established in 1949 and is located at Råö on the Onsala Peninsula on the Swedish west coast, about 40 km south of Gothen-

Chalmers University of Technology, Department of Earth and Space Sciences, Onsala Space Observatory

Onsala IVS Network Station

IVS 2013 Annual Report



**Fig. 1** An aerial photo of Råö with the Onsala Space Observatory. The white spot approximately in the center of the photo is the 30-m diameter radome that encloses the 20-m radio telescope which is used for geodetic VLBI observations. (Credit: Onsala Space Observatory/Väst kustflyg, 2011)

burg. Onsala belongs to the municipality of Kungälv. Figure 1 shows an aerial photo of Råö.

The geoscience instrumentation at Onsala includes equipment for geodetic VLBI, GNSS, a superconducting gravimeter with a platform for visiting absolute gravimeters, several microwave radiometers for atmospheric measurements, both GNSS based and pressure based tide gauges, and a seismometer. The Onsala Space Observatory can thus be regarded as a fundamental geodetic station.

In the coming years, the Onsala Twin Telescope (OTT) will be installed at the observatory and will consist of a pair of two new antennas following the VLBI2010 recommendations.

The staff members associated with the IVS Network Station at Onsala are listed in Table 1.

**Table 1** Staff members associated with the IVS Network Station at Onsala. All e-mail addresses have the ending @chalmers.se, and the complete telephone numbers start with the prefix +46-31-772.

Function	Name	e-mail	telephone
Responsible P.I. for geodetic VLBI	Rüdiger Haas	rudiger.haas	5530
Observatory director	Hans Olofsson (– 2013.11.30)	hans.olofsson	5520
	John Conway (2013.12.01 –)	john.conway	5520
Head of department	Gunnar Elgered	gunnar.elgered	5565
Ph.D. students and postdocs involved in geodetic VLBI	Johan Löfgren	johan.lofgren	5566
	Niko Kareinen (2013.08.19 –)	niko.kareinen	5566
	Tong Ning	tong.ning	5578
Responsible for the VLBI Field System	Michael Lindqvist	michael.lindqvist	5508
	Rüdiger Haas	rudiger.haas	5530
Responsible for the VLBI equipment	Karl-Åke Johansson	karl-ake.johansson	5571
	Leif Helldner	leif.helldner	5576
VLBI operator	Roger Hammargren	roger.hammargren	5551
Telescope scientist	Henrik Olofsson	henrik.olofsson	5564
Software engineer	Mikael Lerner	mikael.lerner	5581
Responsible for gravimetry	Hans-Georg Scherneck	hans-georg.scherneck	5556

## 2 Geodetic VLBI Observations

We participated in all of the 40 planned IVS sessions. In order to gain experience with the modern digital backends, for about 2/3 of these sessions we used both VLBI backends at Onsala, i.e. the Mark IV and the DBBC, and recorded in parallel on the Mark 5A and the Mark 5B+ data acquisition systems, respectively. We asked the staff at the Bonn correlator to do fringe-tests for these parallelly recorded sessions, or we did zero-baseline correlation tests ourselves with the software correlator DiFX at Onsala. There were some difficulties in the handling of the DBBC in the beginning, but we gained experience and learned how to use the DBBC/Mark 5B+ system successfully. Fringes were found with the DBBC/Mark 5B+, and the Bonn correlator could not detect any systematic changes w.r.t. the Mark IV/Mark 5A observations. Several databases were produced by the Bonn correlator that include Onsala both as a Mark IV/Mark 5A and a DBBC/Mark 5B+ station. We analyzed these databases and could not find any significant effects on the geodetic results due to the type of backend and recording system. As a consequence we decided on a smooth transition to the DBBC/Mark 5B+ VLBI system for regular IVS production in the fall of 2013.

In addition to the 40 regular IVS sessions, we also observed two dedicated ultra-rapid sessions, a four-station session UR-13-01 together with Tsukuba, Ho-

bart, and HartRAO, and a one-baseline session UR-13-03 together with Tsukuba.

Furthermore, we did a test experiment together with Wettzell to observe signals from the GLONASS satellites.

## 3 Monitoring Activities

We continued with the monitoring activities as described in previous annual reports:

### Vertical height changes of the telescope tower.

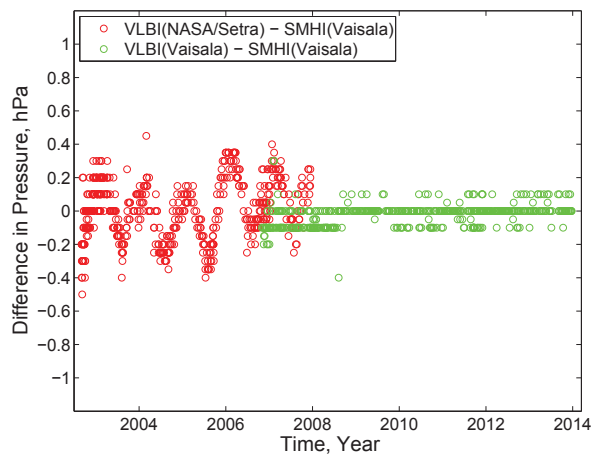
We continued to monitor the vertical height changes of the telescope tower using the invar rod system at the 20-m telescope. The measurements are available at <http://wx.oso.chalmers.se/pisa/>.

### Calibration of pressure sensor.

We continued to calibrate the Onsala pressure sensor using a Vaisala barometer borrowed from the Swedish Meteorological and Hydrological Institute (SMHI). This instrument was installed at Onsala in late 2002 and has been calibrated at the SMHI main facility in Norrköping every one to two years since then. The latest calibration was on October 11, 2011. Since the installation of a new VLBI pressure sensor in 2008 the agreement between the Onsala VLBI pressure and the pressure read by the calibrated sensor is on the level of  $\pm 0.1$  hPa.

**Table 2** Geodetic VLBI observations at Onsala during 2013. Information is given on which VLBI backend was used, whether data were e-transferred in real-time (RT) and/or off-line (OL) and to which correlator, whether modules were shipped to a correlator, and whether Ultra-rapid UT1-UTC results were produced. The last column gives some general remarks and information on the percentage of the scheduled Onsala observations that were used in the analysis (as reported in the Web pages for the IVS session analyses), compared to the station average percentage per experiment.

Exper.	Date	VLBI-backend	E-transfer	Module	Ultra-rapid	General remarks and % of scheduled observations used in the	
		Mark IV DBBC	RT OL	shipment	UT1-UTC	analysis as reported in the IVS Web pages' analysis reports.	
R1-566	01.02	yes	–	Bonn	–	Mark IV in production, Onsala: 93.2 % (station avg. 88.8 %)	
R1-567	01.07	yes	–	Bonn	–	Mark IV in production, Onsala: 96.5 % (station avg. 93.2 %)	
EUR-121	01.21	yes	–	Bonn	–	Mark IV in production, Onsala: 85.4 % (station avg. 70.3 %)	
R1-569	01.22	yes	Tsuk	Bonn	–	Mark IV in production, Onsala: 80.2 % (station avg. 65.6 %)	
G-0128	01.28	yes	–	JIVE	–	GLONASS observations together with Wettzell, 1 h, OK	
R1-570	01.28	yes	Tsuk	Bonn	–	Mark IV in production, Onsala: 91.4 % (station avg. 89.6 %)	
RD-13-01	01.29	yes	Tsuk	Hays	–	not correlated yet in Haystack	
UR-13-01	01.30	yes	–	Tsuk	–	scheduled for ultra-rapid UT1-UTC determination	
R1-572	02.12	yes	–	Bonn	–	Mark IV in production, Onsala: 90.5 % (station avg. 85.6 %)	
R1-573	02.18	yes	Tsuk	Bonn	–	Mark IV in production, Onsala: 96.5 % (station avg. 94.4 %)	
T2-088	02.19	yes	–	Tsuk	Bonn	–	Mark IV in production, Onsala: 78.8 % (station avg. 63.2 %)
R1-578	03.25	yes	–	Bonn	–	Mark IV in production, Onsala: 94.7 % (station avg. 90.0 %)	
R1-579	04.02	yes	–	Tsuk	Bonn	–	Mark IV in production, Onsala: 90.5 % (station avg. 85.6 %)
R1-580	04.08	yes	–	Tsuk	Bonn	–	Mark IV in production, Onsala: 94.4 % (station avg. 90.3 %)
RD-13-02	04.09	yes	–	Hays	–	Mark IV in production, Onsala: 95.2 % (station avg. 92.8 %)	
R1-582	04.22	yes	–	Tsuk	Bonn	–	Mark IV in production, Onsala: 96.5 % (station avg. 94.7 %)
EUR-123	05.06	yes	–	Bonn	–	Mark IV in production, Onsala: 82.8 % (station avg. 72.6 %)	
R1-585	05.13	yes	–	Bonn	–	Mark IV in production, Onsala: 94.1 % (station avg. 90.1 %)	
RD-13-03	05.14	yes	–	Hays	–	Mark IV in production, Onsala: 92.5 % (station avg. 87.3 %)	
R1-591	06.24	yes	–	Bonn	–	Mark IV in production, Onsala: 97.3 % (station avg. 94.3 %)	
T2-090	06.25	yes	Tsuk	Bonn	–	Mark IV in production, Onsala: 72.9 % (station avg. 52.4 %)	
R1-592	07.01	yes	Tsuk	Bonn	–	Mark IV in production, Onsala: 94.3 % (station avg. 93.0 %)	
EUR-124	07.04	yes	–	Bonn	–	Mark IV in production, Onsala: 83.4 % (station avg. 71.1 %)	
R1-598	08.12	yes	Tsuk	Bonn	–	Mark IV in production, Onsala: 92.7 % (station avg. 79.0 %)	
R1-599	08.19	yes	–	Bonn	–	Mark IV in production, Onsala: 71.7 % (station avg. 58.9 %)	
RD-13-06	08.21	yes	Tsuk	Hays	–	Mark IV in production, Onsala: 79.2 % (station avg. 70.7 %)	
R1-600	08.26	yes	–	Bonn	–	Mark IV in production, Onsala: 58.8 % (station avg. 48.0 %)	
EUR-125	09.02	yes	–	Bonn	–	Mark IV in production, Onsala: 64.6 % (station avg. 46.3 %)	
R1-601	09.03	yes	–	Bonn	–	Mark IV in production, Onsala: 95.5 % (station avg. 92.8 %)	
R1-602	09.09	yes	–	Bonn	–	Mark IV in production, Onsala: 86.0 % (station avg. 79.3 %)	
RDV-101	09.11	yes	–	–	Socc	–	Mark IV in production, Onsala: 86.2 % (station avg. 69.2 %)
R1-604	09.24	yes	–	Bonn	–	Mark IV in production, Onsala: 67.0 % (station avg. 52.2 %)	
T2-092	10.01	yes	–	Bonn	–	Mark IV in production, Onsala: 66.6 % (station avg. 55.8 %)	
RD-13-08	10.02	yes	–	Hays	–	Mark IV in production, Onsala: 81.1 % (station avg. 82.9 %)	
R1-606	10.07	yes	–	Bonn	–	Mark IV in production, Onsala: 69.5 % (station avg. 57.2 %)	
R1-612	11.18	yes	–	Bonn	–	Mark IV in production, Onsala: 81.8 % (station avg. 68.7 %)	
T2-093	11.19	yes	–	Bonn	–	DBBC in production, Onsala: 38.8 % (station avg. 26.9 %)	
UR-13-06	12.05	yes	–	Tsuk	–	scheduled for ultra-rapid UT1-UTC determination	
R1-615	12.09	yes	Tsuk	Bonn	–	Mark IV in production, Onsala: 92.5 % (station avg. 88.2 %)	
RDV-102	12.11	yes	–	–	Socc	–	Mark IV in production, Onsala: 85.9 % (station avg. 55.4 %)
R1-616	12.16	yes	Tsuk	Bonn	–	DBBC in production, Onsala: 92.5 % (station avg. 88.2 %)	
T2-094	12.17	yes	–	Bonn	–	not correlated yet in Bonn	
RD-13-10	12.18	yes	–	Hays	–	Mark IV in production, Onsala: 87.1 % (station avg. 77.6 %)	



**Fig. 2** Time series of pressure differences between the VLBI pressure sensors and the calibrated pressure sensor from SMHI.

### Microwave radiometry.

The water vapor radiometer Konrad was in operation continuously observing in a so-called sky-mapping mode. The second water vapor radiometer, Astrid, was operated in the winter, but its 31 GHz channel malfunctioned since the spring. Thus, during cloudy conditions (liquid water drops in the atmosphere) less useful data were acquired with Astrid after that.

### Sea-level monitoring.

The GNSS-based tide gauge was operated continuously. A tide gauge based on pressure sensors was operated next to it throughout the year. In August an additional new bubbler sensor was installed at a new tide-gauge site under development at a distance of approximately 300 m from the GNSS/pressure-sensor site.

### Superconducting gravimetry.

The superconducting gravimeter operated continuously and produced a highly precise record of gravity variations. Near real-time analysis results of the superconducting gravimeter are continuously updated at <http://holt.oso.chalmers.se/hgs/SCG/monitor-plot.html>.

### Absolute gravimetry.

We supported a visiting absolute gravity measurement campaign by Lantmäteriet, the Swedish mapping, cadastral, and land registration authority.

### Seismological observations.

The seismometer owned by Uppsala University and the Swedish National Seismic Network (SNSN) was operated throughout the year.

## 4 A New Onsala Tide Gauge Station

We signed a contract with SMHI to install an official SMHI tide gauge station at the observatory. This new tide gauge will have several sensors, e.g. one radar and two bubbler sensors for the sea-level observations. In addition these data will be complemented by several temperature and salinity sensors. Figure 3 depicts an artist's impression of this planned tide gauge site.



**Fig. 3** An artist's impression of the future SMHI tide gauge station at the Onsala Space Observatory.

## 5 Future Plans

- For 2014 we plan to observe a total of 50 IVS sessions, including the CONT14 campaign. Most likely there will, however, be an interruption in the observations after the summer. The original radome enclosing the 20-m telescope, installed in 1975, has aged and will be replaced by a new one.
- We strive to operate most of the IVS sessions as ultra-rapid UT1-UTC sessions, together with our colleagues at Tsukuba, Hobart, and HartRAO. This includes the CONT14 campaign.
- We will use the digital VLBI system, i.e. the DBBC and the Mark 5B+, for all the sessions for which this is possible. The old Mark IV VLBI system will be decommissioned in the spring of 2014.
- We will continue the usual monitoring activities at the observatory, and we plan to perform a new local tie measurement.
- As mentioned above a new tide gauge station will be installed, and the Onsala Twin Telescope project will be officially started when all necessary permissions have been received from the authorities.



# Korea Geodetic VLBI Station, Sejong

Yi Sangoh, Ahn Kiduk, Oh Hongjong, Han Sangcheol

**Abstract** This report summarizes activities of Sejong station as an IVS network station during 2013.

## 1 General Information

The station is located about 120 km south of Seoul, in the middle of Sejong city, which serves as a new administrative capital. The Sejong antenna is 22 meters in diameter, and its slew speed is 5°/sec in both azimuth and elevation. Its specification was designed with consideration for the possible additional set up of small antennas in the future. Sejong has set up a simultaneous multi frequency band (S/X, K, and Q) receiving system. The S/X system can cover regular IVS sessions, and the K,Q system can use the Korean Geodetic VLBI Network with KVN (Korean VLBI Network managed by the Korea Astronomy and Space Science Institute).

National Geographic Information Institute (NGII, <http://ngii.go.kr>) manages the observatory, and Table 1 shows the staff members of the Sejong station. A newly appointed site director, Mr. Ahn Ki Duk, joined us in November 2013.

## 2 Sejong VLBI System

The Sejong VLBI configuration is listed in Table 2. The antenna is Cassegrain shaped, and the 22-m main reflector consists of 200 rectangular aluminum panels.

National Geographic Information Institute

Sejong Network Station

IVS 2013 Annual Report



**Fig. 1** Layout of the VLBI 22-m antenna, monument pillars 1 to 4, GNS and UCP (Unified Control Point).

**Table 1** Staff members of the Sejong station.

Name	Function	e-mail
Ahn Kiduk	Site Director	akd8@korea.kr
Yi Sangoh	S/W engineer	sangoh.yi@korea.kr
Oh Hongjong	H/W engineer	stockoh11@korea.kr
Han Sangcheol	Antenna system	hsc4907@korea.kr

Each panel has four elevation adjustments at the edge of the panel, so that the antenna main reflector surface can be properly arranged.

**Table 2** Sejong antenna parameters.

Parameters	Sejong VLBI
IVS letter codes	Sejong (Kv)
CDP number	7368
DOMES number	23907S001
Location	127°18'E, 36°31'N Elevation 177 m
Diameter of main reflector	22 m
Antenna type	Shaped Cassegrain
Reflector surface accuracy	86 μm
Operation range	AZ: ±270° EL: 0 to 90°
Slew speed	5°/sec (AZ and EL)
FS Version	9.10.4
Data acquisition Rack/Recorder	K4/K5

### 3 2013 Activities

#### 3.1 Fringe Tests with Tsukuba Antenna

The Sejong antenna carried out several fringe tests with the Tsukuba antenna. We estimated the SEFDs (S: about 30000 / X:2500) of the Sejong antenna with several fringe tests. Its operation has been stopped by work to improve the S-band performance to the required level.

#### 3.2 X-band VLBI Observation with one of the KVN (Korean VLBI Network) Antennas

KASI constructed the KVN of three VLBI antennas. An X-band receiver was installed at the Ulsan station; it proceeded to make a fringe test and a pulsar observation with the Sejong station. The data were transferred to KJCC at KASI.

#### 3.3 H-maser Repair

The DAC20 and cable were replaced and repaired, because we found an error in their reference values during inspection of the H-maser.

#### 3.4 Antenna Motor Controller Repair

An operational failure was found in the four motor controllers for the az/el drive. As a countermeasure for that, one device was delivered to the manufacturer, and it was repaired by them. We have repaired one at present. The full repair is expected to be completed in 2014.

#### 3.5 Filter Exchange

The existing filter frequency was changed to minimize RFI signals in S-band (original: 2.22 Ghz to 2.37 Ghz, new: 2.2 Ghz to 2.3 Ghz).

#### 3.6 Monitoring System

A VLBI monitoring system was installed to allow continuous monitoring of the receiver and back-end device.

### 4 KASI's SLR Installation Plan

KASI developed an SLR system with a 40 cm telescope in 2012. It will be installed at a place very near to the Sejong observatory. Co-location with VLBI, GNSS, and SLR can be possible at Sejong observatory.

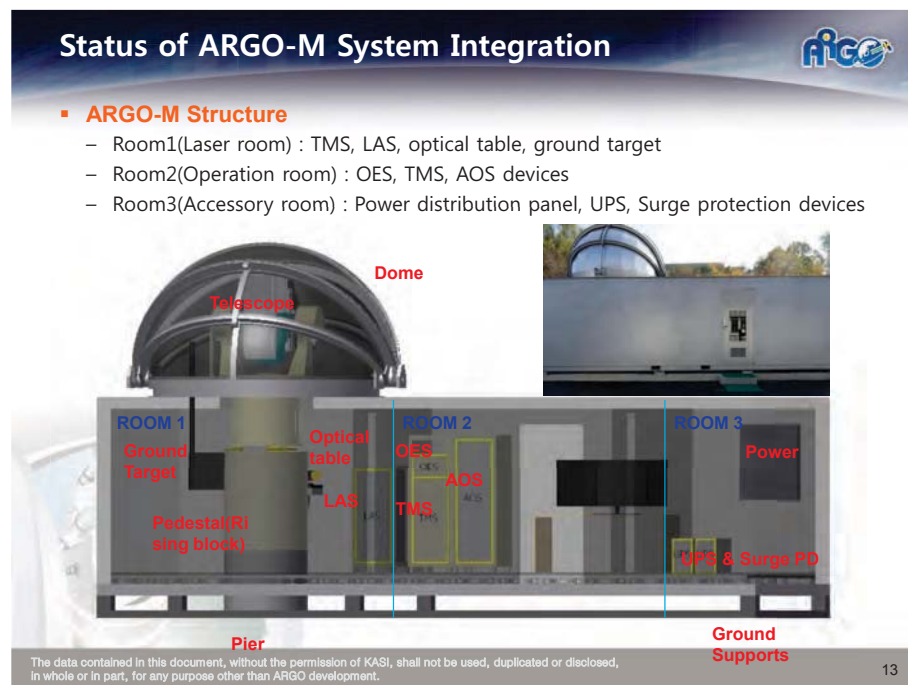


Fig. 2 ARGO-mobile system (by KASI, 2013).

# Sheshan VLBI Station Report for 2013

Zhiqiang Shen, Qingyuan Fan, Qinghui Liu, Xiaoyu Hong, Bo Xia

**Abstract** This report summarizes the observing activities at the Sheshan station (SESHAN25) in 2013. It includes the international VLBI observations for astrometry, geodesy, and astrophysics, as well as domestic observations for satellite monitoring. We also report on updates to and development of the facilities at the station.

## 1 General Information

The Sheshan VLBI station (“SESHAN25”) is located at Sheshan, 30 km west of Shanghai. It is hosted by the Shanghai Astronomical Observatory (SHAO), Chinese Academy of Sciences (CAS). A 25-meter radio telescope is in operation at 1.3, 3.6/13, 5, 6, and 18 cm wavelengths. The Sheshan VLBI station is a member of the IVS and EVN. The SESHAN25 telescope takes part in international VLBI experiments for astrometric, geodetic, and astrophysics research. Apart from its international VLBI activities, the telescope spent a large amount of time on the Chinese Lunar Project, including the testing before the launch of the Chang’e-3 satellite and the tracking campaign after the launch of Chang’e-3.

Shanghai Astronomical Observatory, CAS

Sheshan Network Station

IVS 2013 Annual Report

## 2 VLBI Observations in 2013

In 2013, SESHAN25 participated in 38 IVS sessions (including 25 INT3 Intensive sessions). SESHAN25 also participated in the EVN sessions in February, June, and October. We participated in the R1601 session instead of the R1600 session due to an antenna motor problem. In order to participate in the Chinese Chang’e-3 Lunar Project, SESHAN25 observed the Chang’e-3 satellite with a long term routine VLBI tracking model for two or three days per week. We missed the sessions of J13273 due to a receiver problem.

## 3 Development and Maintenance of the Sheshan Telescope in 2013

We have upgraded the Mark 5B+ Firmware Version to 16.31 (API 11.25, SDK 9.2).

## 4 The Staff of the Sheshan VLBI Station

Table 1 lists the group members of the Sheshan VLBI Station. The staff are involved in the VLBI program at the station with various responsibilities.

**Table 1** The staff of the Sheshan VLBI Station.

Name	Background	Position and Duty	Contact
Xiaoyu HONG	Astrophysics	Director, Astrophysics	xhong@shao.ac.cn
Zhiqiang SHEN	Astrophysics	Head of VLBI Division	zshen@shao.ac.cn
Qingyuan FAN	Ant. control	Chief Engineer, Antenna	qyfan@shao.ac.cn
Zhuhe XUE	Software	Professor, FS	zhxue@shao.ac.cn
Quanbao LING	Electronics	Professor, VLBI terminal	qling@shao.ac.cn
Tao AN	Astrophysics	Astrophysics	antao@shao.ac.cn
Bin LI	Microwave	Technical friend, receiver	bing@shao.ac.cn
Bo XIA	Electronics	VLBI friend, VLBI terminal	bxia@shao.ac.cn
Li FU	Ant. mechanics	Engineer, Antenna	fuli@shao.ac.cn
Jinqing WANG	Electronics	Engineer, Antenna	jqwang@shao.ac.cn
Lingling WANG	Software	Engineer, VLBI terminal	llwang@shao.ac.cn
Rongbing ZHAO	Software	Engineer, VLBI terminal	rbzhao@shao.ac.cn
Weiye ZHONG	Microwave	Engineer, receiver	wyzhong@shao.ac.cn
Jin YUAN	Microwave	Engineer, receiver	wyzhong@shao.ac.cn
Xiuting ZUO	Software	Engineer, Antenna	zxt@shao.ac.cn
Wei GOU	Electronics	Engineer	gouwei@shao.ac.cn
Linfeng YU	Electronics	Engineer	lfyu@shao.ac.cn
Yongbin JIANG	Electronics	Engineer	jyb@shao.ac.cn
Yunxia SUN	HVAC	Engineer, Refrigeration	sunyunxia@shao.ac.cn
Xiacong WU	Electronics	Engineer	wuxc@shao.ac.cn
Wen GUO	Electronics	Engineer	gw@shao.ac.cn

## 5 Outlook

In 2014 the Sheshan radio telescope will take part in 26 IVS sessions and three EVN sessions. The telescope will regularly monitor the Chang'e-3 satellite in its lunar orbit in 2014.

# The Simeiz Fundamental Geodynamics Area

A. E. Volvach, G. S. Kurbasova

**Abstract** This report gives an overview about the astrophysical and geodetic activities at the the fundamental geodynamics area Simeiz-Katsively. It also summarizes the wavelet analysis of the ground and satellite measurements of local insolation on the “Nikita garden” of Crimea.

## 1 General Information

The Radio Astronomy Laboratory of the Crimean Astrophysical Observatory with its 22-m radio telescope is located near Simeiz, 25 km to the west of Yalta. The Simeiz geodynamics area consists of the radio telescope RT-22, two satellite laser ranging stations, a permanent GPS receiver, and a sea level gauge. All these components are located within 3 km (Figure 1).

RT-22, the 22-meter radio telescope, which began operations in 1966, is among the five most efficient telescopes in the world.

Various observations in the centimeter and millimeter wave ranges are being performed with this telescope now and will be performed in the near future. First VLBI observations were performed in 1969 on the Simeiz (RT-22) to Green Bank (RT-43, USA) intercontinental baseline. RT-22 is equipped with radiometers at the 92 cm, 18 cm, 13 cm, 6 cm, 3.5 cm, 2.8 cm, 2.3 cm, 2.0 cm, 13.5 mm, and 8 mm wavelengths.

---

Radio Astronomy Lab of Crimean Astrophysical Observatory

Simeiz Network Station

IVS 2013 Annual Report

## 2 Activities during the Past Year and Current Status

During the past year, the Space Geodesy and Geodynamics stations regularly participated in the International Network programs — IVS, the International GPS Service (IGS), and the International Laser Ranging Service (ILRS).

During the period 2013 January 1 through 2013 December 31, the Simeiz VLBI station participated in 14 24-hour geodetic sessions. Simeiz regularly participated in the EUROPE and T2 series of geodetic sessions.

### 2.1 Multi-Frequency Molecular Line Observations

Study of the star-forming regions in molecular lines started in 1978. Two main types of observation are carried out at the radio telescope:

- 1) observations of maser sources (hydroxyl masers, water masers, and SiO masers) at the frequencies of 1.6 GHz, 4.8 GHz, 22 GHz, and 86 GHz.
- 2) observations of millimeter molecular emission at the frequency range from 85 GHz to 115 GHz.

The radio telescope is equipped with high-sensitive cryogenic receivers with the noise temperatures of: 1) 30 K at 22 GHz; 2) 39 K at 4.8 GHz; 3) 70 K at frequencies from 85 GHz to 115 GHz. At the 3 mm wavelength and with a beam width of 40 arcsecs, the effective aperture area of the antenna is  $100 m^2$ . The spectrum analyzers for line observations are 1) a 128 channel filter

bank spectrum analyzer with frequency band 12 MHz; 2) a digital spectrum analyzer for maser observations with the frequency band of 4 MHz and the frequency resolution of 8 kHz; 3) a 64 channel filter bank spectrum analyzer with a frequency band of 64 MHz.

Using the RT-22, a comet was investigated in the OH line at the wavelength of 18 cm. Comets C/2009 R1 (McNaught) and 17P/Holmes were observed. For comet C/2009 R1 (McNaught), we determined the gas productivity of OH molecules as a function of heliocentric distance. The comet-gas productivity increases rapidly approaching perihelion [1].

## **2.2 The Testing of the Ground-Based Segment of the Radioastron Mission at Wavelengths of 1.35 cm.**

In accordance with the scientific cooperation between Ukraine and Russia a series of studies for the preparation of the operation of the ground segment of the “RadioAstron” mission was held. Using the 22-m radio telescope RT-22 the scientific program of measurements, a substantial part of which is the study of the compact structures in the extragalactic sources, was prepared. For testing of the model of the ground segment of “Radioastron”, RT-22 of Crimean Astrophysical Observatory in Simeiz and RT-70 (P-2500) in Evpatoria jointly conducted groundbased VLBI test experiments at 1.35 cm [2].

## **2.3 Wavelet Analysis of Ground and Satellite Measurements of Local Insolation**

[3] presented the possibility of using wavelet analysis on the signals from long sequences of local terrestrial and NASA satellite observations of the insolation of the Center of HydroMeteorology (CHM) “Nikita Garden” (latitude 44.5, longitude 34.2 degrees). The choice of the method, the type of wavelets, and their parameters for analysis were found. Then the wavelet analysis was applied to the signals to determine and remove the noise and to establish the spectral composi-

tion of the signal data. The local terrestrial signal measurements and data from the signals of the satellite observations were presented in [3], along with the noise found from the statistical analysis of the observations.

## **3 Future Plans**

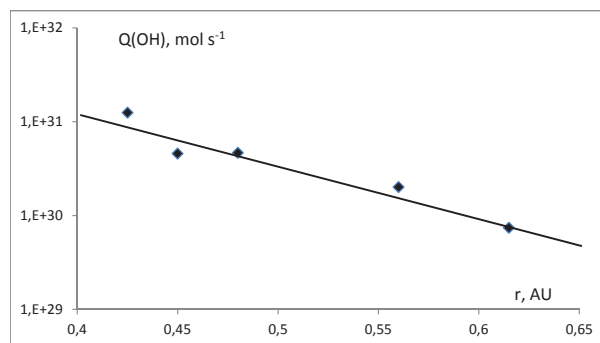
Our plans for the coming year are the following: to put into operation the VLBI Data Acquisition System DBBC, to upgrade the laser of the SLR Simeiz-1873 station, and to set up a new GPS station near the Simeiz VLBI station.

## **References**

1. Volvach L.N., Berezhnoi A.A., Volvach A.E. *Bulletin of the Crimean Astrophysical Observatory*, 109 (1), pp.71-75, 2012.
2. Volvach A.E., Kostenko V.I., Larionov M.G., Volvach L.N., et al. *Bulletin of the Crimean Astrophysical Observatory*, 108 (1), pp.158-162, 2012.
3. Kurbasova G.S., Volvach A.E. *Bulletin of the Crimean Astrophysical Observatory*, in press, 2014.

**Table 1** The antenna parameters of the Simeiz station.

Diameter D, m	22
Surface tolerance, mm (root mean square)	0.25
Wavelength limit, mm	2
Feed System	Cassegrain system or primary focus
Focal length F, m	9.525
Focal ratio F/D	0.43
Effective focal length for Cassegrain system, m	134.5
Mounting	Azimuth-Elevation
Pointing accuracy, arc sec.	10
Maximum rotation rate, degree/sec	1.5
Maximum tracking rate, arcsec/sec	150
Working range in Azimuth, degrees (0 to South)	-270 ± 270
Degrees in Elevation	0 - 85

**Fig. 1** The Simeiz geodynamics area.**Fig. 2** The relationship between the gas productivity of comet C/2009 R1 (McNaught) and the heliocentric distance.



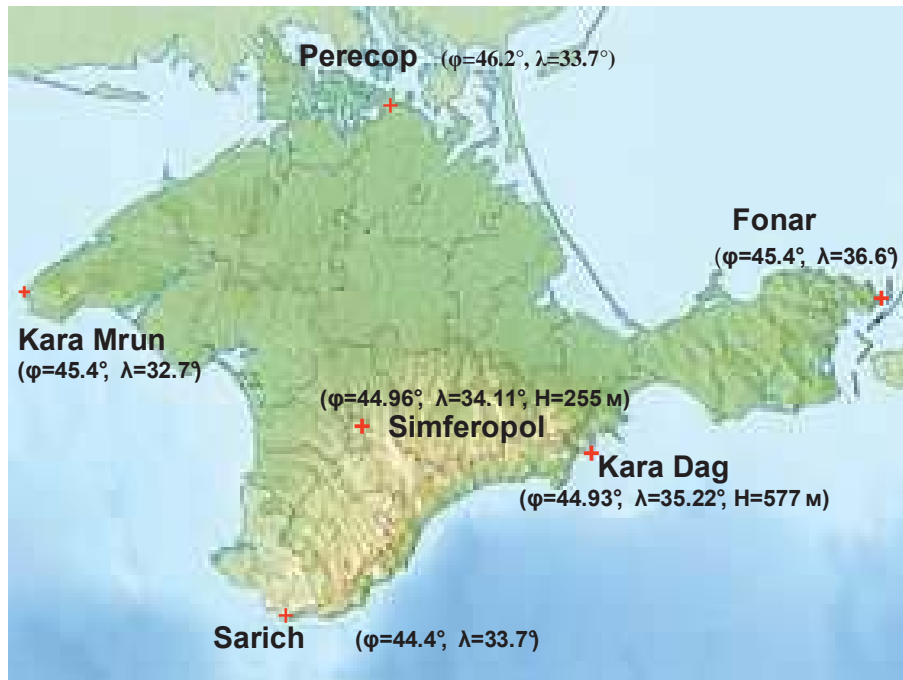


Fig. 3 Crimean area.

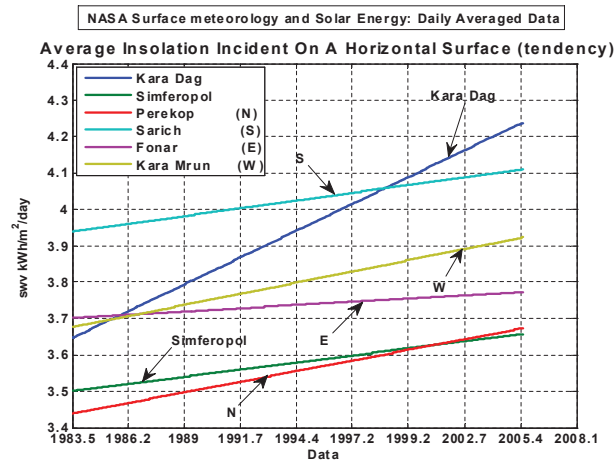


Fig. 4 The insolation for the Crimean area.

# Svetloe Radio Astronomical Observatory 2013 IVS Annual Report

Sergey Smolentsev, Ismail Rahimov

**Abstract** This report provides information about the Svetloe Radio Astronomical Observatory during 2013. The report also provides an overview of current geodetic VLBI activities and gives an outlook for the next year.

## 1 General Information

Svetloe Radio Astronomical Observatory (Figure 1) was founded by the Institute of Applied Astronomy (IAA) as the first station of the Russian VLBI network QUASAR. The sponsoring organization of the project is the Russian Academy of Sciences (RAS). The Svetloe Radio Astronomical Observatory is situated near Svetloe village in the Priozersky district of the Leningrad region (Table 1). The geographic location of the observatory is shown on the IAA RAS Web site: <http://www.ipa.nw.ru/PAGE/rusipa.htm>. The basic instruments of the observatory are a 32-m radio telescope equipped with special technical systems for VLBI observations, GPS/GLONASS/Galileo receivers, the SLR system, and a Water Vapor Radiometer (WVR).

**Table 1** Svetloe Observatory location and address.

Longitude	29°47'
Latitude	60°32'
Leningrad region, Priozerski district	
188833 Russia	
rahimov@osvtl.spb.ru	

Institute of Applied Astronomy of RAS

Network Station Svetloe

IVS 2013 Annual Report



**Fig. 1** Svetloe observatory.

## 2 Technical Staff

**Table 2** Staff related to VLBI operations at Svetloe.

Prof. Ismail Rahimov	observatory chief
Vladimir Tarasov	chief engineer
Tatiana Andreeva	engineer
Andrey Mikhailov	FS, pointing system control

### 3 Component Description

#### 3.1 Technical and Scientific Information

Characteristics of the radio telescope are presented in Table 3.

**Table 3** Technical parameters of the radio telescope.

Year of construction	2000
Mount	AZEL
Azimuth range	$\pm 270^\circ$ (from south)
Elevation range	from $-5^\circ$ to $95^\circ$
Maximum azimuth	
- velocity	$0.83^\circ/s$
- tracking velocity	$2.5'/s$
- acceleration	$12.0''/s^2$
Maximum elevation	
- velocity	$0.5^\circ/s$
- tracking velocity	$0.8'/s$
- acceleration	$12.0''/s^2$
Pointing accuracy	better than $10''$
Configuration	Cassegrain (with asymmetrical subreflector)
Main reflector diameter	32 m
Subreflector diameter	4 m
Focal length	11.4 m
Main reflector shape	quasi-paraboloid
Subreflector shape	quasi-hyperboloid
Main reflector surface accuracy	$\pm 0.5$ mm
Frequency range	1.4–22 GHz
Axis offset	$3.7 \pm 2.0$ mm



**Fig. 2** Topcon GPS/GLONASS/Galileo receiver at the Svetloe observatory.



**Fig. 3** “Sazhen-TM” SLR system at Svetloe observatory.

#### 3.2 Co-location of VLBI, GPS/GLONASS, SLR System, and WVR

The Topcon GPS/GLONASS/Galileo receiver with meteo station WXT-510 is in operation (Figure 2).

The SLR system “Sazhen-TM” (Figure 3) was mounted in October 2011 and joined the ILRS in March 2012. The SLR system at Svetloe observatory observed 353 passes of LAGEOS, GLONASS, and others and obtained 3,040 normal dots during 2013.



**Fig. 4** WVR and RT-32 at Svetloe observatory.

## 4 Current Status and Activities during 2013

Svetloe observatory participates in IVS and domestic VLBI observational programs. During 2013, Svetloe station participated in 29 diurnal IVS sessions — 24 IVS-R4 sessions, one IVS-T2 session, four EURO sessions – and in 36 IVS-Intensive sessions.

Svetloe participated in 48 diurnal sessions in the frame of the domestic Ru-E program for determination of all Earth orientation parameters and in 20 one-hour Ru-U sessions for obtaining Universal Time using e-VLBI data transfer. Since April 2013, we have used e-VLBI data transfer for Svetloe observational data for the Ru-E 24-hour sessions.

In 2013, the WVR was installed and is successfully working (Figure 5).

## 5 Future Plans

Our plans for the coming year are the following:

- To participate in IVS observations,
- To carry out domestic observational programs for obtaining Universal Time daily and for obtaining Earth orientation parameters weekly with e-VLBI data transfer,
- To carry out SLR observations of geodetic and navigation satellites,
- To participate in EVN and RADIOASTRON observational sessions,
- To continue geodetic monitoring of the RT-32 parameters, and
- To continue WVR observations.



**Fig. 5** WVR at Svetloe observatory.

# JARE Syowa Station 11-m Antenna, Antarctica

Yuichi Aoyama, Koichiro Doi, Kazuo Shibuya

**Abstract** In 2013, the 53<sup>rd</sup>, the 54<sup>th</sup>, and the 55<sup>th</sup> Japanese Antarctic Research Expeditions (hereinafter, referred to as JARE-53, JARE-54, and JARE-55, respectively) participated in six OHIG sessions — OHIG82, 83, 84, 85, 86, and 87. These data were recorded on hard disks through the K5 terminal. The hard disks for the OHIG82 session were brought back from Syowa Station to Japan in April 2013 by the icebreaker Shirase while those for the other five sessions are scheduled to arrive in April 2014. The data obtained from the OHIG79, 80, 81, and 82 sessions by JARE-53 and JARE-54 were transferred to the Bonn Correlator via the servers of National Institute of Information and Communications Technology (NICT). At Syowa Station, JARE-55 will participate in six OHIG sessions in 2014.

## 1 General Information

To investigate polar science, the National Institute of Polar Research (NIPR) is managing Japanese Antarctic Research Expeditions (JAREs). The 30 members of JARE-54 overwintered at Syowa Station, East Ongul Island, East Antarctica in 2013.

Syowa Station has become one of the key observation sites in the Southern Hemisphere's geodetic and geophysical networks (as shown in Figure 1, see [1] for details). As a part of these geodetic measurements, the JAREs have been operating the 11-m S/X-band an-

tenna at Syowa Station (69.0°S, 39.6°E) for geodetic VLBI experiments since February 1998. A cumulative total of 108 quasi-regular geodetic VLBI experiments were performed by the end of 2013.

## 2 Component Description

For VLBI, the Syowa antenna is registered as IERS Domes Number 66006S004 and as CDP Number 7342. The basic configuration of the Syowa VLBI frontend system has not changed from the description in [2]. Syowa's K4 recording terminal was fully replaced by K5 simultaneously with the termination of the SYW session at the end of 2004. Syowa has participated in the OHIG sessions in the austral summer season since

National Institute of Polar Research  
JARE Syowa Station 11-m antenna  
IVS 2013 Annual Report

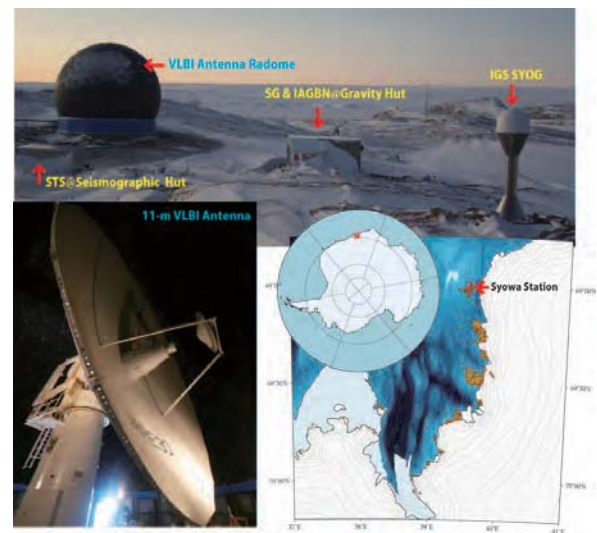


Fig. 1 Syowa VLBI antenna.

**Table 1** Staff members.

Name	Affiliation	Function	Notes
Kazuo SHIBUYA	NIPR	Project coordinator	until March 2013
Koichiro DOI	NIPR	Project coordinator	since April 2013
Yuichi AOYAMA	NIPR	Liaison officer	
Hideaki HAYAKAWA	NIPR	Chief operator of JARE-53	
Takeshi YOSHIOKA	NEC	Antenna engineer for JARE-53	
Noriaki OBARA	NIPR	Chief operator of JARE-54	
Hiroshi TANAKA	NEC	Antenna engineer for JARE-54	
Takuya MASUNAGA	NIPR	Chief operator of JARE-55	from Nov. 2013 to Jan. 2015

JARE-53: February 2012 – January 2013 JARE-54: February 2013 – January 2014

1999. Data transfer through an Intelsat satellite link from Syowa Station to NIPR has been available since 2004. However, its recent bandwidth has been about 2 MB and its effective speed of FTP transfer has been about 100kB/sec, which is too slow to practically transfer the huge VLBI data.

### 3 Staff of the JARE Syowa Station 11-m Antenna

The Syowa Station 11-m antenna is operated and maintained by JARE and NIPR. The staff members are listed in Table 1. Prof. Shibuya retired on March 31, 2013, so K. Doi took over as the project coordinator of our institute. OHIG sessions in 2013 were performed primarily by the staff of JARE-54 as shown in Figure 2. The staff of JARE-53 supported them in the OHIG82 session, in order to hand over the operation and maintenance of the 11-m antenna to them. T. Masunaga, a member of an advance team of JARE-55, came to Syowa Station on November 15 by airplane. Consequently, he could join the OHIG87 session as their successor.

## 4 Current Status and Activities

### 4.1 Notes on System Maintenance

There used to be two hydrogen masers, Anritsu RH401A HM-1001C, and HM-1002C at Syowa Station. However, HM-1002C was brought back to Japan in January 2011 for an overhaul. We attempted



**Fig. 2** Syowa VLBI staff of JARE-54, N. Obara (left) and H. Tanaka (right).

to return HM-1002C to Syowa Station immediately. But it was impossible to transport it, because the icebreaker Shirase could not approach Syowa Station in the 2011/2012 and 2012/2013 austral summer seasons due to dense and thick sea ice. Because it was expected that it would be difficult for Shirase to approach Syowa Station in the 2013/2014 austral summer season, we decided to maintain HM1002C at Anritsu Co., Ltd. without transporting it to Syowa Station.

The other hydrogen maser, HM-1001C, has operated for VLBI observations since January 2011. On March 11, 2011, trouble occurred in its ion pump and in an uninterruptible power supply (UPS) for HM-1002C because of instability in both voltage and frequency of the generator for power supplies at Syowa Station. In January 2013, the UPS was repaired by replacing sealed batteries and the failed charging circuit.

**Table 2** Status of OHIG sessions as of December 2013.

Code	Date	Station	Hour	Correlation	Solution	Notes
OHIG76	2012/Feb/15	Sy, Ft, Hh, Kk, Oh, Tc	24 h	Yes	Yes	J53
OHIG77	2012/Feb/28	Ft, Kk, Oh, Tc -Sy	24 h	–	–	†1
OHIG78	2012/Feb/29	Ft, Hh, Kk, Oh, Tc -Sy	24 h	No	No	†2
OHIG79	2012/Nov/06	Sy, Hb, Kk	24 h	Yes	Yes	
OHIG80	2012/Nov/07	Sy, Ft, Hb, Kk, Tc	24 h	Yes	Yes	
OHIG81	2012/Nov/14	Sy, Hb, Hh, Kk, Tc	24 h	Yes	Yes	
OHIG82	2013/Feb/11	Sy, Hh, Kk, Oh, Tc	24 h	Yes	Yes	J54
OHIG83	2013/Feb/13	Sy, Hh, Kk, Oh, Tc	24 h	–	–	
OHIG84	2013/Feb/20	Sy, Ft, Kk, Oh, Tc	24 h	–	–	
OHIG85	2013/Nov/11	Sy, Ft, Hb, Ke, Kk, Tc, Ww, Yg	24 h	–	–	
OHIG86	2013/Nov/13	Sy, Ft, Hb, Ke, Kk, Tc, Ww, Yg	24 h	–	–	
OHIG87	2013/Nov/20	Sy, Ft, Hb, Hh, Ke, Kk, Tc, Ww, Yg	24 h	–	–	

J53: JARE–53, op H. Hayakawa eng T. Yoshioka J54: JARE–54, op N. Obara eng H. Tanaka

†1 : Canceled because of malfunction of HM–1001C.

†2 : No fringes because of malfunction of HM–1001C.

On the other hand, the ion pump began to abnormally stop on occasion since March 11, 2011. In 2013, such abnormal stops, which caused a low vacuum inside the HM–1001C and attenuated the hydrogen maser oscillator, occurred on January 6, May 8, July 5, September 11, November 5, November 21, and November 26. The JARE–54 staff had to form high vacuum and check the hydrogen maser generation at all such times. Especially, abnormal stops occurred on November 21 during the OHIG87 session. The ion pump stopped suddenly at 00:00 UTC just before the 36<sup>th</sup> scan, and the staff could not restart the ion pump until 00:12 UTC. The IF level of the hydrogen maser was recovered and synchronized with GPS around 01:55 UTC before the 45<sup>th</sup> scan. There may be about two hours of unavailable data in the OHIG87 recorded data.

To avoid such critical situations, we purchased a new hydrogen maser, SD1T03B, last year. SD1T03B was miniaturized in order to be loaded on a helicopter. Therefore, we could transport it to Syowa Station on December 16. SD1T03B was connected to UPS for HM1002C, and its startup was accomplished on December 20.

In preparing the OHIG82 session, the power modules of units 1 and 2 of K5 were broken. The malfunctioning modules were replaced with spare parts, so that there was no apparent influence on the subsequent OHIG sessions.

A system for Delay calibration (D–Cal) recording is independent of the K5 system. D–Cal signals used

to be recorded at start/end of each Syowa scan onto floppy disk (FD) by using an N88 BASIC program on an ancient NEC PC. Although its FD drive broke down in November 2012, it was replaced by a spare in January 2013, and D–Cal signals resumed being stored on FD. The D–Cal recording program hung-up twice (45<sup>th</sup> and 85<sup>th</sup> scans) during the OHIG85 session. As a consequence, the D–Cal signal data from scans 1 to 44 was broken.

In the direction of north in the field of view of the antenna, a few interference waves in S band were detected in the output signal of the video converter with a spectrum analyzer. The obvious peaks appeared in the frequencies of 212.1 MHz and 260.0 MHz in the intermediate frequency of S band. We continue to investigate their source.

## 4.2 Session Status

Table 2 summarizes the status of processing as of December 2013 for the sessions starting in 2012. The OHIG sessions involved Fortaleza (Ft), O’Higgins (Oh), Kokee Park (Kk), TIGO Concepción (Tc), Hobart 12-m antenna (Hb), HartRAO (Hh), Warkworth (Ww), Katherine (Ke), Yarragadee (Yb), and Syowa (Sy). In 2005, Syowa joined the CRD sessions, but after 2006, Syowa participated only in OHIG sessions. Syowa took part in six OHIG sessions in 2013.

K5 HDD data brought back from Syowa Station were transferred to NICT servers and converted to the

Mark 5 format data there. The converted data were transferred from the NICT servers to the Bonn Correlator by FTP.

### 4.3 Analysis Results

As of December 2013, Syowa had contributed 97 sessions from May 1999. According to the results analyzed by the BKG IVS Analysis Center, the length of the Syowa–Hobart baseline is increasing with a rate of  $52.6 \pm 0.9$  mm/yr. The Syowa–HartRAO baseline shows a slight increase in its length with a rate of  $13.1 \pm 0.6$  mm/yr. The Syowa–O’Higgins baseline also shows a slight increase, although its rate is only  $3.0 \pm 1.1$  mm/yr. Detailed results from the data until the end of 2003 as well as comparisons with those from other space geodetic techniques were reported in [3].

## 5 Future Plans

Dismantling the current Syowa VLBI antenna is scheduled for the 2015/2016 austral summer season. We presented a budget proposal for construction of a new VGOS antenna after 2017. We will make every effort until this proposal is approved. Simultaneously, we are preparing to install a small geodetic VLBI antenna in collaboration with NICT. We would like to shorten the discontinuation period of VLBI observations as much as possible.

## References

1. Shibuya, K., Doi, K., and Aoki, S. (2003): Ten years’ progress of Syowa Station, Antarctica, as a global geodesy network site. *Polar Geoscience*, 16, 29-52.
2. Shibuya, K., Doi, K., and Aoki, S. (2002): JARE Syowa Station 11-m Antenna, Antarctica, in *International VLBI Service for Geodesy and Astrometry 2002 Annual Report*, 149-152, NASA/TP-2003-211619, ed. by N. R. Vandenberg and K. D. Baver.
3. Fukuzaki, Y., Shibuya, K., Doi, K., Ozawa, T., Nothnagel, A., Jike, T., Iwano, S., Jauncey, D.L., Nicolson, G.D., and McCulloch, P.M. (2005): Results of the VLBI experiments conducted with Syowa Station, Antarctica. *J. Geod.*, 79, 379-388.



# Status of the TIGO VLBI Station in Concepción

Hayo Hase <sup>1</sup>, Cristian Herrera <sup>2</sup>, Pedro Pino <sup>2</sup>, Cristian Beltran <sup>2</sup>

**Abstract** The main activities at the TIGO VLBI station during 2013 were observing 117 scheduled VLBI sessions and progressing with the future cooperation with Argentina for the new site near La Plata. The acronym TIGO will be replaced by AGGO, once the Tigo radio telescope is installed in Argentina.

## 1 General Information

Since 2002, TIGO has been located in the terrain of the Universidad de Concepción (longitude 73.025 degrees West, latitude 36.843 degrees South), in Concepción, Chile.

## 2 Component Description

The IVS network station TIGOCONC constitutes the VLBI part of the Geodetic Observatory TIGO, which was designed to be a fundamental station for geodesy. Hence, the VLBI radio telescope is co-located with an SLR telescope (ILRS site), a GPS/Glonass permanent receiver (IGS site), and other instruments such as a seismometer, a superconducting gravimeter, and an absolute gravity meter.

The atomic clock ensemble of TIGO consists of three hydrogen masers, three cesium clocks and four

1. Bundesamt für Kartographie und Geodäsie

2. Universidad de Concepción

TIGOCONC Network Station

IVS 2013 Annual Report



**Fig. 1** The TIGO radio telescope.

GPS time receivers realizing the Chilean contribution to the Universal Time scale (Circular T, BIPM).

The technical parameters of the TIGO radio telescope as published in [1] have not been changed.

## 3 Staff

The 2012 VLBI staff consisted of three persons, as listed in Table 1. Pedro Pino left TIGO in September and was replaced by Cristian Beltran. The team was complemented by students Pablo Figueroa and Dr. Sabina Rayo performing night shifts.

**Table 1** TIGO VLBI support staff in 2013.

Staff	Function	Email	Remark
Hayo Hase	Head	hayo.hase@tigo.cl	
Cristian Herrera	Informatic Engineer	cristian.herrera@tigo.cl	
Pedro Pino	Electronic Engineer	pedro.pino@tigo.cl	until September 2013
Cristian Beltran	Electronic Engineer	cristian.beltran@tigo.cl	until end of 2013
Sabina Rayo	student of mechanical engineering	sabina.rayo@tigo.cl	
Pablo Figueroa	student of telecommunications	pablo.figueroa@tigo.cl	
all VLBI operators		vlbistaff@tigo.cl	

## 4 Current Status and Activities

### 4.1 IVS Operation

During 2013, TIGO was scheduled to participate in 114 regular IVS experiments. Three 24-hour additional participations were carried out within the TANAMI project [2]. Table 2 gives an overview about the participation of TIGOCONC in 2013. Out of 117 requested observation days, 113 could be observed successfully, reaching an efficiency of 96.5%. The main reasons for data loss have been related to technical problems in the refrigerating system of the receiver, recording problems on bad data carriers, and unexpected delays in the customs liberation procedure of data carriers.

**Table 2** TIGO's observation statistics for 2013.

Name	R1xxx	R4xxx	OHIGxx	T2	RD	TANAMI	Total
# of Exp.	51	50	6	4	3	3	<b>117</b>
Correlated	49	48	6	4	3	3	<b>113</b>
No result	2	2	0	0	0	0	<b>4</b>

### 4.2 Search for New Site for TIGO

The TIGO project is carried out on the basis of governmental decree 489. During the past few years the Chilean government did not respond to the call to support this bilateral cooperation project. For this reason the German Federal Agency of Cartography and Geodesy (BKG) looked for a new project partner in South America, and an agreement with the Argentinean science foundation Conicet was signed in October 2013. In the year 2014, the TIGO project will be

closed in Chile and moved to the vicinity of the town of La Plata. The project will then be called **Argentinean German Geodetic Observatory (AGGO)**.

The future site was decided to be 500 m away from the existing Instituto Argentino de Radioastronomia (IAR). AGGO will be dependent on Conicet but independent from IAR. BKG and Conicet have laid out a development plan. In phase 1 AGGO will make use of TIGO as it was operated in Concepción. In phase 2 the installations within the containers will be moved to an operations building, so that containers older than 20 years can be abandoned.

## 5 Future Plans

The VLBI activities in 2014 will be focused on:

- execution of the IVS observation program for 2014,
- photogrammetric reflector survey, and
- overhaul and preparing the VLBI equipment for the move to Argentina.

## References

1. Vandenberg, N.R.: International VLBI Service for Geodesy and Astrometry 1999 Annual Report, NASA/TP-1999-209243, 1999.
2. M. Kadler, R. Ojha, S. Tingay and J. Lovell, *The TANAMI Program: Southern-Hemisphere VLBI Monitoring of Relativistic Jets in Active Galaxies*, American Astronomical Society, AAS Meeting #211, #04.13; Bulletin of the American Astronomical Society, Vol. 39, p.732.

# Tsukuba 32-m VLBI Station

Takahiro Wakasugi<sup>1</sup>, Ryoji Kawabata<sup>1</sup>, Shinobu Kurihara<sup>1</sup>, Yoshihiro Fukuzaki<sup>1</sup>, Jiro Kuroda<sup>1</sup>, Tadashi Tanabe<sup>1</sup>, Syota Mizuno<sup>1,2</sup>, Takafumi Ishida<sup>1,2</sup>

**Abstract** The Tsukuba 32-m VLBI station is operated by the Geospatial Information Authority of Japan. This report summarizes activities of the Tsukuba 32-m VLBI station in 2013. 115 sessions were observed by using Tsukuba 32-m and other GSI antennas in accordance with the IVS Master Schedule of 2013 except for the interruption period due to the repair of the antenna base of Tsukuba 32-m. We have been constructing the new observing facilities that will be fully compliant with VGOS for the first time in Japan.



Fig. 1 Tsukuba 32-m VLBI station.

1. Geospatial Information Authority of Japan
2. Advanced Engineering Service Co., Ltd.

Tsukuba Network Station  
IVS 2013 Annual Report

## 1 General Information

The Tsukuba 32-m VLBI station (Figure 1) is located at the Geospatial Information Authority of Japan (hereafter GSI) in Tsukuba science city, which is about 50 km to the northeast of Tokyo. GSI has three regional stations besides Tsukuba: Shintotsukawa, Chichijima, and Aira, which form a geodetic VLBI network in Japan covering the whole country (Figure 2).

GSI has carried out the domestic VLBI session series called “JADE (Japanese Dynamic Earth observation by VLBI)” since 1996. The main purposes of the JADE series are to maintain the reference frame of

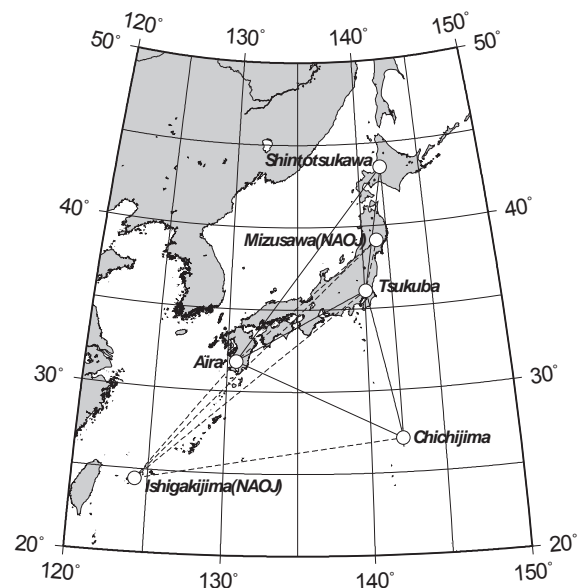


Fig. 2 Geodetic VLBI network in Japan.

Japan and to monitor plate motions for the advanced study of crustal deformation around Japan. Additionally, some JADE sessions include Mizusawa and Ishigakijima, which are part of the VERA network of the National Astronomical Observatory of Japan (NAOJ), and two antennas in Kashima (11-m and 34-m) and the Koganei 11-m station, which belong to the National Institute of Information and Communications Technology (NICT).

## 2 Component Description

The specifications of the Tsukuba 32-m antenna are summarized in Table 1.

**Table 1** Tsukuba 32-m antenna specifications.

Owner and operating agency	Geospatial Information Authority of Japan
Year of construction	1998
Radio telescope mount type	Az-El
Antenna optics	Cassegrain
Diameter of main reflector	32 m
Azimuth range	10 – 710°
Elevation range	5 – 88°
Az/El drive velocity	3°/sec
Tsys at zenith (X/S)	50 K / 65 K
SEFD (X/S)	320 Jy / 360 Jy
RF range (X1)	7780 – 8280 MHz
RF range (X2)	8180 – 8680 MHz
RF range (X3)	8580 – 8980 MHz
RF range (S with BPF)	2215 – 2369 MHz
Recording terminal	K5/VSSP32,
	ADS3000+ with DDC

## 3 Staff

Table 2 lists the regular members belonging to the GSI VLBI observation group. Takahiro Wakasugi newly joined in our group and was in charge of station operation mainly. Routine operations were primarily performed under contract with Advanced Engineering Service Co., Ltd. (AES). Syota Mizuno and Takafumi Ishida replaced Yasuko Mukai and Takashi Nishikawa as new operators since November.

**Table 2** Member list of the GSI VLBI group.

Name	Main Function
Tadashi TANABE	Supervisor
Jiro KURODA	Management, Co-location
Yoshihiro FUKUZAKI	Installation of VGOS
Shinobu KURIHARA	Correlation, Analysis, IVS Directing Board member
Ryoji KAWABATA	Operation, Co-location
Takahiro WAKASUGI	Operation
Kazuhiro TAKASHIMA	Research
Syota MIZUNO	Operation(AES, Co., Ltd)
Takafumi ISHIDA	Operation(AES, Co., Ltd)
Toshio NAKAJIMA	System engineer(I-JUSE)

## 4 Current Status

### 4.1 Geodetic VLBI Observations

The regular sessions in the IVS Master Schedule that were observed by using the GSI antennas are shown in Table 3. The Tsukuba 32 m participated in 39 domestic and international 24-hr VLBI sessions and in 56 Intensive 1-hr sessions for dUT1 measurement in 2013. The Tsukuba 32 m could not participate in the IVS sessions from the beginning of May to the end of November due to the repair of the antenna base (see Section 4.2). The other GSI antennas, Shintotsukawa, Chichijima, and Aira participated in not only domestic but also some international sessions.

**Table 3** The number of regular sessions carried out by using the GSI antennas in 2013.

Sessions	Tsukuba	Shintotsukawa	Chichijima	Aira
IVS-R1	21	–	–	10
IVS-R4	5	–	–	–
IVS-T2	3	–	7	7
APSG	1	2	2	2
VLBA	3	–	–	–
IVS-R&D	3	–	–	–
IVS-CRF	0	–	–	–
JADE	3	7	9	9
IVS-INT1	7	–	–	–
IVS-INT2	34	–	–	–
IVS-INT3	15	–	–	–
Total	95	9	18	28

## 4.2 Repair of the Tsukuba 32-m Antenna

At the end of April, we found that the damage of the antenna base was very serious from the results of a pointing check with X-band and decided to interrupt all experiments after early May. We investigated the damage of the antenna immediately and found that there were some gaps between the sole plates under the rail tracks and cementitious grout, which could cause the subsidence of the antenna (Figure 3). Then, we filled all gaps with new firm grout in order to prevent the antenna from subsiding. After confirming that the result of the pointing check was alright, we resumed IVS sessions with the Tsukuba 32 m from the end of November. Although we confirmed that the rail track level was almost the same as before the repair, we will perform field surveys in early 2014 in order to make sure the reference point does not move.

We carried out R1 sessions 10 times by using Aira from the end of September to the end of November on behalf of the Tsukuba 32 m after modifying the down converter to receive the R1 sessions' frequency band. These sessions were performed with a high-speed A/D sampler ADS3000+ and K5/VSI system, which have been developed by our collaborator NICT. We plan to continue R1 sessions by using Aira until the end of March 2014 in parallel with the Tsukuba 32 m.

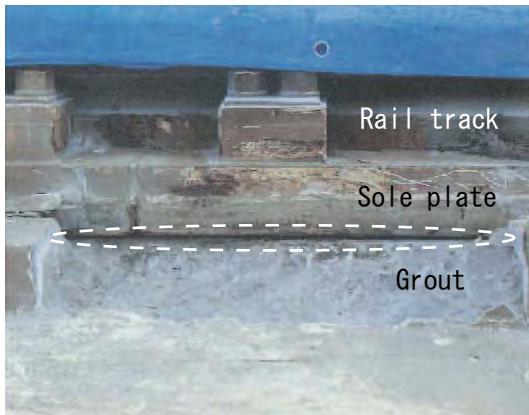


Fig. 3 A gap under a sole plate detected after excavating grout.

## 4.3 VGOS Project by GSI

In 2012, we had started construction of the new GSI VGOS observing facilities in Ishioka city located about 17 km northeast from Tsukuba (Figure 4). Some part of the antenna and observing cabin were delivered to the site by the end of 2013 and the construction of the antenna will be completed by the end of March 2014 (Figure 5). The other equipment such as a front-end feed, up-down converter, data processing and acquisition system and so on were already delivered to GSI. We decided to call the new site iGOS (Ishioka Geodetic Observing Station) that includes GNSS continuous observation system and gravity observing point in order to play an important role of the geodetic site based on GGOS (Global Geodetic Observing System) in Japan.

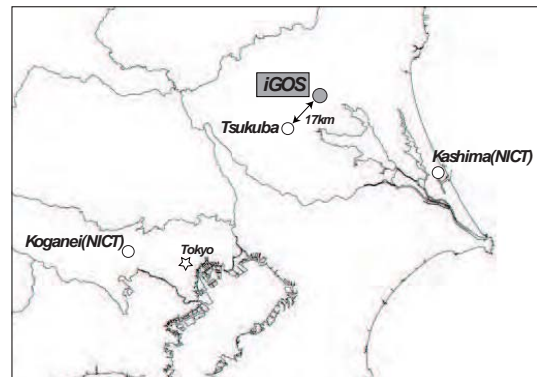


Fig. 4 Location of iGOS site.

## 5 Future Plans

As mentioned above, the new VGOS station in Ishioka will be installed by the end of March 2014. We will carry out some tests and adjustments to obtain fringes between the existing system and the new one. Subsequently, we plan to carry out parallel operation from 2015 to 2016. After these sessions, we plan to participate in VGOS sessions thoroughly from 2017.

On the other hand, we have to consider the deterioration of the regional stations. We decided to close Shintotsukawa, which was installed in 1995, from the



**Fig. 5** Construction of the antenna.

beginning of 2014 because of aging. We will also continue to consider the other GSI stations.

# Nanshan VLBI Station Report 2013

Ming Zhang, Ali Yusup

**Abstract** Urumqi Nanshan station is a key node of the Chinese VLBI Network (CVN). It participates in global VLBI observations for the IVS, EVN, and EAVN networks. This report provides an overview of geodetic and astronomical activities and technical development at XAO during 2013.

## 1 Introduction



**Fig. 1** The 25-m antenna at Nanshan station.

The Nanshan VLBI station is located 70 km south of Urumqi, the capital city of the Xinjiang Uyghur Autonomous Region of China. The station is affiliated with the Xinjiang Astronomical Observatory of the National Astronomical Observatories of CAS. In 2013, we have participated in geodetic observations for IVS

Xinjiang Astronomical Observatory, Chinese Academy of Sciences

Xinjiang Astronomical Observatory

IVS 2013 Annual Report

as well as in astronomical observations for EVN, CVN and EAVN.

## 2 Current Status

### 2.1 Antenna

- **Coordinates:** Longitude:  $87^{\circ}10'41''$  E; Latitude:  $43^{\circ}28'17''$  N; Altitude: 2080 m
- **Diameters:** Primary: 25 m; Secondary: 7 m
- **Antenna type:** Modified Cassegrain
- **Seat-rack type:** Azimuth-pitching ring
- **Main surface precision:** 0.40 mm (rms)
- **Pointing precision:**  $15''$  (rms)
- **Turning angle:** Azimuth:  $\pm 270^{\circ}$ ; Elevation:  $5^{\circ}$ - $88^{\circ}$
- **Slew speed:** Azimuth:  $0.9^{\circ}/\text{sec}$ ; Elevation:  $0.5^{\circ}/\text{sec}$

### 2.2 Receivers

The receiver parameters of the 25-m antenna are shown in Table 1.

### 2.3 Recording System

The recording systems available at the Nanshan VLBI station are Mark 5B+, Mark IV, Mark II, and K5. The Mark 5 StreamStor SDK has been upgraded from version 8.1 to 9.2. The Field System now is being upgraded from version 9.10.4 to 9.11.4. The analog BBC

**Table 1** The receiver parameters of the 25-m antenna.

Band	Wave (cm)	Freq (MHz)	BW (MHz)	LO (MHz)	Pol
L	18	1400-1720	320	1300	dual
S	13	2150-2450	300	2000	dual
C	6	4750-5150	400	4620	dual
X	3.6	8200-9100	500	8100/8600	dual
K	1.3	22100-24200	500	22000-23700	dual
Band	Type	T_rec (K)	T_sys (K)	Eff (%)	SEFD (Jy)
L	room	10	24	52	300
S	room	50	70	48	560
C	room	9	22	55	250
X	cryo	20	50	50	350
K	cryo	17	40	35	850

used here is old but still able to record at a maximum rate of 2,048 Mbps with a maximum channel width of 16 MHz and a maximum of 16 channels. The digital backend system we have here is a Chinese Data Acquisition System (CDAS), which was developed by Shanghai Astronomical Observatory.

### 3 IVS Observations

We have observed 12 scheduled IVS sessions in 2013. All of them were observed normally.

**Table 2** The observed IVS sessions.

Session	Date	Remarks
R4569	JAN 24	Normal
R4579	APR 04	Normal
APSG32	APR 17	Normal
R4582	APR 25	Normal
APSG33	MAY 20	Normal
R4595	JUL 25	Normal
R1604	SEP 24	Normal
R1612	NOV 18	Normal
T2093	NOV 19	Normal
R1613	NOV 25	Normal
R1617	DEC 23	Normal
R1618	DEC 30	Normal

### 4 Personnel

See Table 3 for Urumqi personnel.

### 5 Future Plans

A planned reconstruction of the 25-m antenna will take place in March 2014 and will be completed in October 2014. A digital backend RDBE and a DBBC are both in our purchase plan.



**Table 3** The staff supporting the 25-m antenna.

<b>Name</b>	<b>Position</b>	<b>Field</b>	<b>E-mail</b>
Na Wang	Director	Astrophysics	na.wang@xao.ac.cn
Ali Yusup	Chief Engineer	Antenna	aliyu@xao.ac.cn
Maozheng Chen	Senior Engineer	Receiver	mzchen@xao.ac.cn
Jun Ma	Senior Engineer	Receiver	majun@xao.ac.cn
Wenjun Yang	Senior Engineer	Terminal	yangwj@xao.ac.cn
Hua Zhang	Senior Engineer	Terminal	zhangh@xao.ac.cn
Shiqiang Wang	Senior Engineer	Antenna	wangshq@xao.ac.cn
Jun Nie	Senior Engineer	Computing	niejun@xao.ac.cn
Guanghai Li	Engineer	Computing	ligh@xao.ac.cn
Chenyu Chen	Engineer	Antenna	chency@xao.ac.cn
Mingshuai Li	Engineer	Time and Frequency	limingsh@xao.ac.cn
Xiang Liu	Scientist	Astrophysics	liux@xao.ac.cn
Ming Zhang	Scientist	Astronomy	zhang.ming@xao.ac.cn

# Warkworth Radio Astronomical Observatory, New Zealand

Hiroshi Takiguchi, Stuart Weston, Tim Natusch, Sergei Gulyaev

**Abstract** We describe geodetic research activities related to the Warkworth 12-m VLBI Station: WARK12M. We present a summary of baseline lengths (obtained with the participation of WARK12M) based on IVS results for the 2.5 year period, from the beginning of 2011 to August 2013, and compare them with baselines for the corresponding (co-located) GNSS stations.

## 1 Introduction

New Zealand's location on the boundary of the Pacific and Australian Plates makes it one of the most active geological areas in the world [1]. Figure 1 shows the plate boundary, epicenters of earthquakes in the last 3.5 years and location of major volcanoes in New Zealand. Two continuous GNSS networks are used in New Zealand to monitor these geological processes: PositionNZ and GeoNet [2]. The PositionNZ network of 31 GNSS stations has been used to support the New Zealand Geodetic Datum 2000 (NZGD2000) [3]. Prior to 2008, New Zealand had no VLBI capability; the NZGD2000 was therefore based solely on GNSS data and ITRF96. GeoNet is a network designed for monitoring earthquakes, volcanic activity, and crustal deformation. The New Zealand Velocity Model has been estimated by using GeoNet network data [4]. This model is referenced to the Australian Plate, so points near Auckland move little, points near Christchurch move

southwest at about 40 mm/yr. About 5 mm/yr uplift is reported in the Southern Alps of the South Island from GNSS observations [5].

The Global Geodetic Observing System (GGOS) aims to achieve a challenging 1 mm positioning and 0.1 mm/yr velocity accuracy by using and integrating advanced geodetic techniques [6], [7]. To achieve these goals, geodetic (GGOS) stations should be equipped with two or more co-located geodetic observation techniques (e.g., GNSS and VLBI).

New Zealand first obtained the space geodetic technique of VLBI in 2008 when Auckland University of Technology (AUT) established a 12-m geodetic radio telescope near Warkworth, 60 km north of Auckland (Figure 1). In 2010, WARK12M became an IVS network station. Within the scope of global geodetic VLBI observations, WARK12M plays an important role in improving the geographic distribution of VLBI stations in the Southern Hemisphere and contributing to the definition of both the International Celestial Reference Frame (ICRF) and the International Terrestrial Reference Frame (ITRF) [8]. Locally, within the New Zealand context, WARK12M provides important geodetic information which can be used (in conjunction with GNSS data) to support the NZGD2000 and contribute to establishment of the next generation, GGOS inspired, New Zealand Geodetic Datum.

In addition to participating in regular IVS sessions, WARK12M is engaged in joint geodetic research with the National Institute of Information and Communications Technology (NICT), Japan and with the AuScope project [9]. The latter operates three 12-m radio telescopes located in Hobart (HOBART12), Yarragadee (YARRA12M), and Katherine (KATH12M). Located on the Australian tectonic plate, both WARK12M and AuScope radio telescopes are ideally placed

---

Institute for Radio Astronomy and Space Research, Auckland University of Technology

Warkworth Network Station

IVS 2013 Annual Report

for measurements of intra-plate deformation. The WARK12M–AuScope baselines are long enough to contribute to Earth Orientation Parameter (EOP) observations, particularly when coupled together with New Zealand–Japan (NICT) baselines (Figure 2).

## 2 Warkworth Developments

Specifications of Warkworth 12-m and 30-m antenna are provided in Table 1 and Table 2.

During 2013, work continued on the 30-m (Cassegrain beam-waveguide NEC antenna) dish as first reported in [10]. In February 2013, the dish became fully steerable with the commissioning of a new control system and motors supplied by Control Technologies and Antenna Measurement and Consultancy Services. In October and November 2013, with the assistance of Ed Himwich, we commenced work to develop a first pointing model using the existing Satellite Communication C-Band RF system and a new Field System. An uncooled C-band receiver is currently under development; significant improvement in performance is anticipated once it is fitted to the antenna.

In 2014, the existing 1 Gbps network connection to Warkworth will be upgraded to 10 Gbps, greatly enhancing our eTransfer throughput for IVS. Currently eTransfers to the Curtin correlator (for example) are limited to a maximum sustained rate of just over 800 Mbps with the existing 1 Gbps link via KAREN and AARNET. The 15-day continuous AUST experiment of December 2013 conducted with AuScope and Har-TRAO required some two weeks to eTransfer the approximately 100TBytes of data collected with the existing service.

## 3 Analysis of VLBI and GNSS Baselines for Warkworth

Since 2012, AUT has been engaged in collaborative research with NICT, which operates three IVS network stations (KASHIM34, KASHIM11, KOGANEI). Teams at both institutions have worked towards establishing a “geodetic environment” — correlation processing, bandwidth synthesis, VLBI data analysis,

**Table 1** Specifications of the Warkworth 12-m antenna.

Antenna type	Dual-shaped Cassegrain
Manufacturer	Cobham/Patriot, USA
Main dish Diam.	12.1 m
Secondary refl. Diam.	1.8 m
Focal length	4.538 m
Surface accuracy	0.35 mm
Pointing accuracy	18"
Mount	alt-azimuth
Azimuth axis range	90° ± 270°
Elevation axis range	4.5° to 88°
Azimuth axis max speed	5°/s
Elevation axis max speed	1°/s

**Table 2** Specifications of the Warkworth 30-m antenna.

Antenna type	Cassegrain, beam waveguide
Manufacturer	NEC, Japan
Main dish Diam.	30 m
Frequency range	3.5 — 7 GHz
Mount	alt-azimuth, wheel and track
Azimuth axis range	−179.0° to 354.0°
Elevation axis range	6.0° to 90.1°
Azimuth axis max speed	15.0°/min
Elevation axis max speed	21.6°/min

and Time and Frequency Transfer by using VLBI. The baseline WARK12M–KASHIM11 is a long North-South baseline of over 8000 km (Figure 2). The first observation of the WARK12M–KASHIM11 baseline carried out in 2012 resulted in the baseline length of 8,075,003,545 ± 150 mm. More observations for monitoring this baseline are in preparation, as well as an experiment aimed to derive Earth Orientation Parameters in an Ultra-rapid mode by using existing UT1 products and high-speed data transfer networks.

Since 2011, AUT has also been engaged in collaborative research with the AuScope project. Here we analyse Warkworth–AuScope baseline lengths and their rates of change using IVS Analysis Center results. The number of sessions and session types (R1, R4, AUSTRAL) are listed separately in Table 3.

We analyzed databases of the three types (R1, R4, AUSTRAL) using Calc/Solve software. Different types of IVS sessions are optimised for different purposes. For example, R1 and R4 sessions are optimised for providing twice-weekly EOP results; the purpose of AUSTRAL sessions is to determine the station coordinates and their evolution in the WARK12M–AuScope network. It is important, therefore, to apply a uniform strategy across all session types when analyzing the VLBI databases. When analyzing AUSTRAL sessions,

we used only WARK12M and AuScope station data. For R1 and R4 sessions, we excluded TIGOCONC and Japanese stations (TSUKUM32, KASHIM34 and KASHIM11) in order to avoid the effects of potential earthquake after-slip.

Figure 3 shows the baseline length residuals vs. time for three baselines that include Warkworth. The linear trends of baselines estimated for different types of sessions are provided in each graph in brackets along with the standard errors. The rates of change determined from VLBI data and the corresponding standard errors are of the same order of magnitude, so based on this data we cannot as yet conclude that the above rates of change are statistically significant.

WARK12M and AuScope VLBI stations are co-located with the corresponding GNSS stations WARK, HOB2, KAT1, and YAR2 (Figure 2). We analyzed GNSS data of the co-located IGS (and PositionNZ) stations using GAMIT/GLOBK software. We combined the results with the SOPAC global network file.

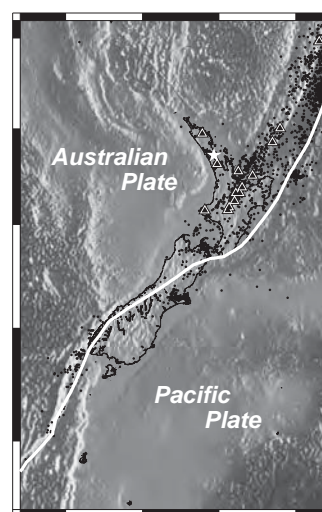
Figure 4 shows the baseline length residuals and the linear trends of three baselines between Warkworth and AuScope co-located GNSS stations. Rates of change indicated in Figure 4 were estimated by formally fitting linear functions to all sets of GNSS baseline data. All GNSS rates of change are very small (about 1-2 mm/yr), which seems realistic given that all four stations are located on the same tectonic plate. Due to the small number of observations, the errors of VLBI rates are greater than the order of magnitude of the rates themselves. There is a clear annual/seasonal periodic pattern in GNSS baseline data (Figure 4) with an amplitude of about 5-10 mm. We do not have enough data to identify an annual pattern in VLBI data that include WARK12M.

## 4 Conclusion

Auckland University of Technology operates a 12-m geodetic radio telescope in New Zealand and participates in collaborative research programs in space geodesy with IVS, NICT, and AuScope. We have analyzed the first 2.5 years of IVS observations in which WARK12M participated and compared the Warkworth–AuScope baseline lengths and their changes with the corresponding GNSS results. We do not find long term (>1 year) changes in GNSS

baselines, but do find an annual periodic pattern with an amplitude of 5-10 mm. The small number of VLBI baseline measurements and large errors do not allow robust conclusions about VLBI baseline changes with certainty at this time.

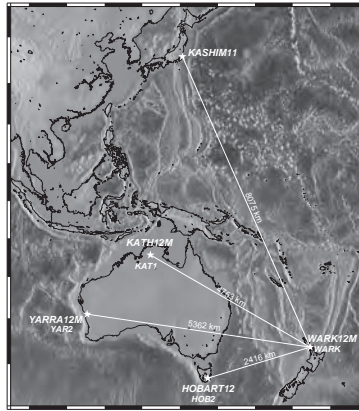
To monitor tectonic dynamics with high precision, a large number of observations is necessary. It is important to carry out observations continuously with minimal gaps. This was not the case in the first 2.5 years of WARK12M geodetic VLBI observations. We hope regular and more frequent observations will improve the accuracy of WARK12M VLBI measurements in the future.



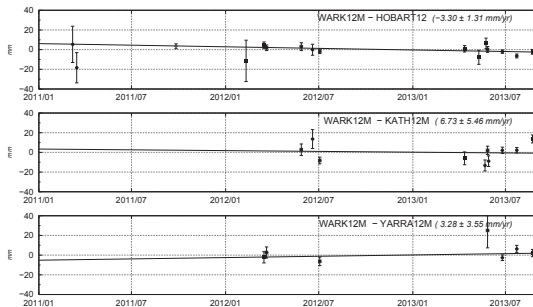
**Fig. 1** New Zealand's geological situation. Tectonic plate boundary is shown with the white curve. Dots indicate the earthquake epicenter locations ( $M \geq 1$ , from January 2010 to July 2013) according to the USGS/NEIC earthquake catalog. Triangles indicate locations of major volcanoes. The location of WARK12M is marked with a star.

**Table 3** The number of sessions used for calculations over the total number of sessions of a given type.

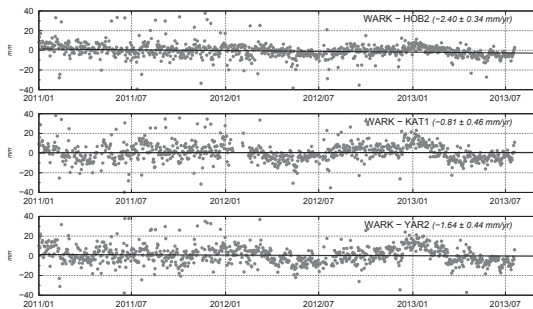
	WARK12M HOBART12	WARK12M KATH12M	WARK12M YARRA12M
ALL	15/23	10/12	7/8
R1	4/6	5/6	2/2
R4	6/7	2/2	3/3
AUSTRAL	4/4	3/3	2/3
Others	1/6	0/1	0/0



**Fig. 2** The geographical distribution of VLBI stations (WARK12M, AuScope, KASHIM11) with baseline lengths.



**Fig. 3** Time series of the baseline length residuals of WARK12M and AuScope baselines. Points and squares indicate R1 and R4 session respectively. Asterisks indicate AUSTRAL session. Rates of change (linear trends) and standard errors are shown in brackets.



**Fig. 4** Time series of the baseline length residuals calculated from GNSS data (WARK, HOB2, KAT1, YAR2). Rates of change (linear trends) and standard errors are shown in brackets.

## Acknowledgements

The authors would like to acknowledge organisations and institutions such as IVS, IGS, LINZ, GNS Science, NICT, Geoscience Australia, University of Tasmania and CSIRO. We are grateful to the makers of Calc/Solve, GAMIT/GLOBK, and Generic Mapping Tools developers for providing the software.

## References

- Rafferty, John P. (2010), Plate tectonics, volcanoes, and earthquakes, p312.
- Beavan, R. J. (2005), Noise properties of continuous GPS data from concrete pillar geodetic monuments in New Zealand, and comparison with data from US deep drilled braced monuments. *Journal of geophysical research. Solid earth*, 110(B8): B08410, doi:10.1029/2005JB003642.
- Pearse, M. (2000), Realisation of the New Zealand Geodetic Datum 2000, OSG Technical Report, 5.
- GNS Science, <http://www.gns.cri.nz/Home/Our-Science/Earth-Science/Plate-Tectonics/Deformation-of-NZ>.
- Beavan, J., et al. (2010), Distribution of present-day vertical deformation across the Southern Alps, New Zealand, from 10 years of GPS data, *Geophysical research letters*, 37: L16305, doi:10.1029/2010GL044165.
- H.-P. Plag, M. Pearlman (eds.) (2009), *Global Geodetic Observing System*, DOI 10.1007/978-3-642-02687-4.1.
- GGOS Vision, Mission and Goals. (2011). Officially adopted by the Global Geodetic Observing System Steering Committee at its 21st Meeting on July 2, 2011 at the IUGG XXV General Assembly, Melbourne, Australia. <http://www.ggos.org/>
- Takiguchi, H., S. Gulyaev, T. Natusch, S. Weston, and L. Woodburn (2011), Towards Synergy of VLBI and GNSS Geodetic Techniques in Geologically Dynamic New Zealand, *Advances in Geosciences*, Vol. 31, 33-42.
- Lovell, J.E.J., McCallum, J.N., Reid, P.B., McCulloch, P.M., Baynes, B.E., Dickey, J.M., Shabala, S.S., Watson, C.S., Titov, O., Ruddick, R., Twilley, R., Reynolds, C., Tingay, S.J., Shield, P., Adada, R., Ellingsen, S.P., Morgan, J.S. and Bignall, H.E. (2013), The AuScope geodetic VLBI array, *Journal of Geodesy*, 87, 6, 527-538, doi:10.1007/s00190-013-0626-3.
- Weston, S., H. Takiguchi, T. Natusch, L. Woodburn, S. Gulyaev (2013), Warkworth 12-m VLBI Station: WARK12M, IVS 2012 Annual Report, NASA/TP-2013-217511.

# Westford Antenna 2013 Annual Report

Mike Poirier

**Abstract** Technical information is provided about the antenna and VLBI equipment at the Westford site of the Haystack Observatory and about changes to the systems since the IVS 2012 Annual Report.

## 1 Westford Antenna at Haystack Observatory

Since 1981, the Westford antenna has been one of the primary geodetic VLBI sites in the world. Located  $\sim 70$  km northwest of Boston, Massachusetts, the antenna is part of the MIT Haystack Observatory complex.

The Westford antenna was constructed in 1961 as part of the Lincoln Laboratory Project West Ford that demonstrated the feasibility of long-distance communication by bouncing radio signals off a spacecraft-deployed belt of copper dipoles at an altitude of 3600 km. In 1981, the antenna was converted to geodetic use as one of the first two VLBI stations of the National Geodetic Survey Project POLARIS. Westford has continued to perform geodetic VLBI observations on a regular basis since 1981. Westford has also served as a test bed in the development of new equipment and techniques now employed in geodetic VLBI worldwide. Funding for geodetic VLBI at Westford is provided by the NASA Space Geodesy Program.

MIT Haystack Observatory

Westford Antenna

IVS 2013 Annual Report



**Fig. 1** The radome of the Westford antenna.

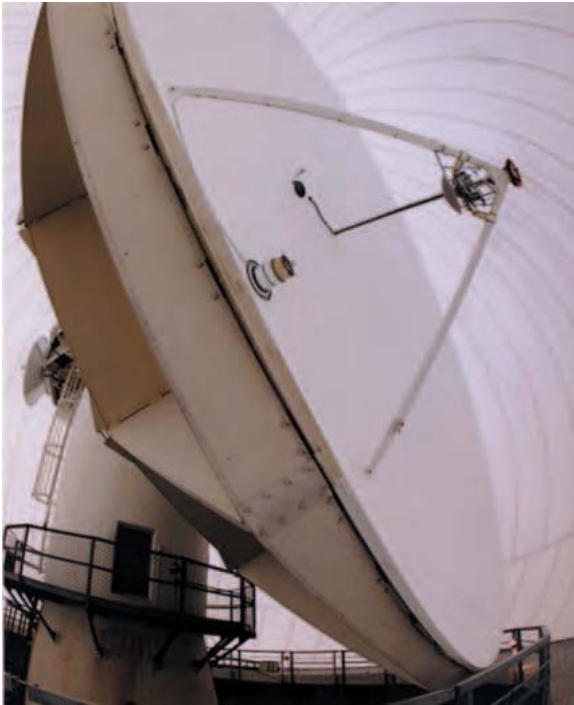
**Table 1** Location and addresses of the Westford antenna.

Longitude	71.49° W
Latitude	42.61° N
Height above m.s.l.	116 m
MIT Haystack Observatory Off Route 40 Westford, MA 01886-1299 U.S.A. <a href="http://www.haystack.mit.edu">http://www.haystack.mit.edu</a>	

## 2 Technical Parameters of the Westford Antenna and Equipment

The technical parameters of the Westford antenna, which is shown in Figure 2, are summarized in Table 2.

The antenna is enclosed in a 28-meter diameter air-inflated radome made of 1.2 mm thick Teflon-coated fiberglass—see Figure 1. When the radome is wet, system temperatures increase by 10–20 K at X-band and by a smaller amount at S-band. The major components



**Fig. 2** Wide-angle view of the Westford antenna inside the radome. The VLBI S/X receiver is located at the prime focus. The subreflector in front of the receiver is installed when observing with the TAL receiver (see Section 4), which is located at the Cassegrain focus.

**Table 2** Technical parameters of the Westford antenna for geodetic VLBI.

<i>Parameter</i>	<i>Westford</i>	
primary reflector shape	symmetric paraboloid	
primary reflector diameter	18.3 meters	
primary reflector material	aluminum honeycomb	
S/X feed location	primary focus	
focal length	5.5 meters	
antenna mount	elevation over azimuth	
antenna drives	electric (DC) motors	
azimuth range	90° – 470°	
elevation range	4° – 87°	
azimuth slew speed	3° s <sup>-1</sup>	
elevation slew speed	2° s <sup>-1</sup>	
	<i>X-band system</i>	<i>S-band system</i>
frequency range	8180-8980 MHz	2210-2450 MHz
$T_{\text{sys}}$ at zenith	50–55 K	70–75 K
aperture efficiency	0.40	0.55
SEFD at zenith	1400 Jy	1400 Jy

of the VLBI data acquisition system are a Mark IV electronics rack, a Mark 5B recording system, and a Pentium-class PC running PC Field System version 9.10.2. The primary frequency and time standard is the NR-4 hydrogen maser. A CNS Clock GPS receiver system provides a 1 pps reference clock to which the maser 1 pps is compared.

Westford also hosts the WES2 GPS site of the IGS network. A Dorne-Margolin choking antenna is located on top of a tower ~60 meters from the VLBI antenna, and a LEICA GRX1200 Reference Station receiver acquires the GPS data.

### 3 Westford Staff

The personnel associated with the geodetic VLBI program at Westford and their primary responsibilities are:

Chris Beaudoin	broadband development
Joe Carter	antenna servo support
Brian Corey	VLBI technical support
Kevin Dudevoir	pointing system software
Dave Fields	technician, observer
Alex Burns	technician, observer
Glenn Millson	observer
Arthur Niell	principal investigator
Michael Poirier	site manager
Colin Lonsdale	site director

### 4 Standard Operations

From January 1, 2013, through December 31, 2013, Westford participated in 52 standard 24-hour sessions. Westford regularly participated in IVS-R1, IVS-R&D, IVS-T2, and RD-VLBA observations.

Use of the Westford antenna is shared with the Terrestrial Air Link (TAL) Program operated by the MIT Lincoln Laboratory. In this project, Westford serves as the receiving end on a 42-km long terrestrial air link designed to study atmospheric effects on the propagation of wideband communications signals at 20 GHz.

## 5 Research and Development

In its role as a test bed for VLBI developments the Westford antenna was implemented several times during the year with the VGOS broadband feed assembly and used successfully as the second element of the interferometer with the GGAO 12-m VGOS system.

The first VGOS geodetic observations were scheduled and observed in October 2012. Two six-hour sessions were run on successive days. The initial results agree at the few millimeter level, consistent with the expected performance of the two systems. In May 2013 the first 24-hour session was observed. When broken into four six-hour sections, the session showed geodetic repeatability among the segments of better than 2 mm. An important goal of that session was to demonstrate unattended operation following setup, and the antenna functioned as expected.

The antenna was also equipped with the Mark 6 prototype data recorder for a demonstration of 16 Gbps recording capability. The equipment has been left in place for additional Mark 6 testing and development.

## 6 Outlook

Westford is expected to participate in 87 24-hour sessions in 2014. These will include the 15-day CONT14 campaign and several VGOS sessions, along with the occasional fringe test and support of the VGOS broadband development program.

Westford is planning to upgrade the PC Field System and complete the pointing system upgrade, which will facilitate compatibility with the VGOS/MCI system to be installed on the Westford antenna.

The Westford broadband system will see several upgrades in 2014, including improvements to the Dewar, implementation of noise diode calibration, and separation of the RF signal path into two bands to reduce sensitivity to S-band RFI.

## Acknowledgements

I would like to thank Arthur Niell, Christopher Beaudoin, and Chester Ruszczyk for their contributions to this report.



# Geodetic Observatory Wettzell - 20-m Radio Telescope and Twin Telescopes

Alexander Neidhardt <sup>1</sup>, Gerhard Kronschnabl <sup>2</sup>, Raimund Schatz <sup>1</sup>, Torben Schüler <sup>2</sup>

**Abstract** In 2013 the 20-m radio telescope at the Geodetic Observatory Wettzell, Germany contributed again very successfully to the IVS observing program. 2013 was the anniversary year of the antenna as it started its operations in the year 1983. Technical changes, developments, improvements, and upgrades have been made to increase the reliability of the entire VLBI observing system. Therefore, a complete shutdown was necessary in the months from July to September to replace the complete servo and gear system. In parallel the new Twin radio Telescope Wettzell (TTW) was officially inaugurated during a ceremony with international guests. Additionally, first light and correlation tests were successfully performed in August.

frequency, meteorology and super conducting gravity meters, etc., are also being operated. Currently also the first antenna of the fully VLBI2010-compliant Twin radio Telescope is in an operational test phase. It should extend the observation possibilities according to the technical suggestions of the IVS Working Group 3 (WG3) and the VLBI Global Observing System (VGOS) observations.

Within the responsibility of the GOW are the TIGO system in Concepción, Chile, operated mainly together with the Universidad de Concepción (see separate report about TIGO), and the German Antarctic Receiving Station (GARS) O'Higgins on the Antarctic peninsula, operated together with the German Space Center (DLR) and the Institute for Antarctic Research Chile (INACH) (see separate report about O'Higgins).

## 1 General Information

The 20-m Radio Telescope in Wettzell (RTW) is an essential component of the Geodetic Observatory Wettzell (GOW) and is jointly operated by Bundesamt für Kartographie und Geodäsie (BKG) and Forschungseinrichtung Satellitengeodäsie (FESG) of the Technische Universität München (Technical University Munich). In addition to the RTW an ILRS laser ranging system, several IGS GPS permanent stations, a large laser gyroscope G (ringlaser) and the corresponding local techniques, e.g. time and

## 2 Staff

The staff of the GOW consists in total of 34 members (excluding students) for operations, maintenance, and repair issues and for improvement and development of the systems. The staff operating RTW is summarized in Table 1. In 2013, two chief engineers were appointed to be responsible for the technical issues at the two radio telescope systems of the GOW. Christian Plötz took over the duty for the 20-m RTW and Gerhard Kronschnabl for the TTW.

Until March 2013, one additional engineer was on a research position which was funded by the “Novel EXploration Pushing Robust e-VLBI Services” (NEX-PreS) project in cooperation with the Max-Planck-Institute for Radioastronomy (MPIfR), Bonn. Another research position, which is partly involved in VLBI

1. Forschungseinrichtung Satellitengeodäsie (FESG), Technische Universität München

2. Bundesamt für Kartographie und Geodäsie (BKG)

**Table 1** Staff - members of RTW.

Name	Affiliation	Function	Mainly working for
Torben Schüller	BKG	head of the GOW (since January 2013)	GOW
Alexander Neidhardt	FESG	head of the VLBI group and VLBI station chief	RTW, TTW
Erhard Bauernfeind	FESG	mechanical engineer	RTW
Ewald Bielmeier	FESG	technician	RTW
Gerhard Kronschnabl	BKG	electronic engineer (chief engineer TTW)	TTW, RTW, TIGO
Christian Plötz	BKG	electronic engineer (chief engineer RTW)	O'Higgins, RTW, TTW
Raimund Schatz	FESG	software engineer	RTW
Walter Schwarz	BKG	electronic engineer	RTW, WVR)
Reinhard Zeithöfler	FESG	electronic engineer	RTW
Martin Ettl	FESG/ MPIfR	Computer scientist (until March 2013)	NEXPREs (EU FP7)
Jan Kodet	FESG	appl. phys. engineer	DFG FOR1503
Gordon Klingl	FESG/ BKG	student	Operator RTW/SLR
Yvonne Klingl	FESG/ BKG	student	Operator RTW/SLR

developments, is founded by the DFG research group FOR1503 about reference systems, local ties, and co-location on ground and space.

### 3 Observations in 2013

The 20-m RTW has been supporting the geodetic VLBI activities of the IVS and partly other partners, such as the EVN, for almost 30 years. All successfully observed sessions in the year 2013 are summarized in Table 2. After the repair of the bearings in 2010, it was also necessary to replace the gears, the motors, the servo system, and the control system with a new, state-of-the-art technique. This was realized in the months from July to September 2013. Nevertheless, the telescope is in a very good and stable state. The main priority in operations was participation in all daily one-hour INTENSIVE-sessions (INT) in order to determine UT1-UTC. According to the implementation of a Field System extension for remote control, weekend INTENSIVES were partly done in the new observation modes by remote attendance, remote control from students at the laser ranging system (WLRS), or completely unattended. Meanwhile, all data are transferred with e-VLBI techniques. RTW now routinely uses the Internet connection capacities of 1 Gbit/sec for the e-transfers

with the Tsunami protocol to the correlators in Bonn, Tsukuba, Haystack, and Washington.

**Table 2** RTW observations in 2013.

program	number of 24h-sessions	special program	number of 1h-sessions
IVS R1	40	1h-INT1	179
IVS R4	41	1h-INT2/K	56
IVS T2	6	1h-INT3/K	25
IVS R&D	7	VEX/MEX/RadioAstron	31
RDV/VLBA	3	VLBA102	24
EUROPE	5	Satellite tracking	1
<b>total (in hours)</b>	<b>103 2472</b>	<b>total (in hours)</b>	<b>316</b>

In addition to the standard sessions, RTW was active for other special observations such as the tracking of the ESA Venus Express (VEX) spacecraft, the Mars Express (MEX) spacecraft (Phobos fly-by) and the RadioAstron satellite for the EVN. More progress was possible for the tracking of Glonass and GPS satellites. Additional developments of an L-band receiver and the activation of a permanent satellite tracking mechanism, using the new antenna control unit after the modification of the RTW, enabled frequent observations. A cooperation with the technical university in Vienna also allowed to extend the scheduling module of the Vienna VLBI Software (VieVS) to produce VEX files for satellite observations.

### 4 Technical Improvements and Maintenance

Regularly, tasks and maintenance days (obtaining replacements for the hardware, 8-pack repair, gear maintenance, exchange of motors after reaching their lifetime, NASA Field System updates, cryo-system maintenance, servo replacements, and improvements for e-VLBI issues) were scheduled for the usual maintenance work. As the components of the servo system were overaged, it was possible to commission a replacement of the whole system and to upgrade it to a similar, modern technique such as the one installed in the Twin telescopes. The upgrade was performed by the company Vertex Antennentechnik GmbH, Duisburg, Germany from July to September. During this upgrade the gears for the azimuth and elevation axes were replaced. The new gears have new AC-servos and a

completely digital control system. Therefore the complete servo and control racks were replaced and the cable wrap was reconfigured. As a new Twin-like antenna control unit controls the whole system, the station computer software was re-written. The new software supports the classic tracking modes and additional satellite tracking possibilities and modes, which reduce power consumption for the slewing between sources with optimal acceleration behavior. In addition to the upgrade of the servo system, the complete surface of the reflector and sub-reflector was polished and varnished again. To improve the de-icing of the reflector, the heating system in dedicated reflector panels was replaced.



**Fig. 1** Some replacement work at the RTW: new setup of the cable wrap (left), replacement of the gears and motors (upper right), and new varnishing of the reflector surface (lower right).

Upgrades and repairs were also necessary for the Mark IV data acquisition rack. The revision of the replacement dewar systems for Wetzell and O’Higgins were completed by the labs at the astronomical observatory in Yebes, Spain.

The usage of the EVN-PC for e-transfer was continuously extended. In addition the usage of e-transfer for the 24-hour sessions to the correlators in Bonn, Haystack, Washington, and Tsukuba was routinely used with up to 600 Mbit per second. A combination of the Mark 5 software “fuseMk5” and the communication protocol “Tsunami” is used on a regular Mark 5B system.

The usage of the new Digital Baseband Converters (DBBC) was forced. Several test data were correlated at the Bonn correlator to check functionality and quality (especially in combination with the Twin operation

tests). Additionally new CoMo boards were installed to upgrade to a standard version of the equipment. The development is still under progress.

The remote control software “e-RemoteCtrl” was also extended, mainly by the TUM. In close cooperation with the developers of the NASA Field System and with other test sites at Australia (e.g. Hobart, Katherine, and Yarragadee) new features were established. The AuScope network and the Wetzell site already use the software routinely. The software development was funded in task 3 of work package 5 of the NEX-PreS project and is performed in cooperation with the MPIfR.

Another new field is the preparation for tracking of global navigation satellites. Therefore new amplifier and receiver boards were improved. These can be used after the waveguides for S-band to receive the L-band of the satellite. Additionally the software is now able to track satellites permanently, using orbits in the Two-line Elements format.

## 5 The TWIN Radio Telescope Wetzell (TTW)

The Twin Telescope Wetzell project is Wetzell’s realization of a complete VLBI2010 conformity. The mechanical system is now completely functional, and the installation work of the receiving and the data acquisition systems was continued. The new tri-band horn was put into operation. Quality checks together with the company Vertex Antennentechnik GmbH demonstrated the very good performance of the feed horn in combination with the antenna for S- and X-band. The new control room was completely set up to control both the Twin telescopes and the old 20-m antenna. Additionally connections to the TIGO telescope and to the AuScope telescopes in Australia was established.

The Twin telescopes started their operational test phase with an official inauguration with international guests on April 26th. After the ceremonial act, the Undersecretary of State of the German Ministry of the Interior Cornelia Rogall-Grothe, the Vice-President of the Technical University Munich (TUM) Prof. Hans Pongratz, and the President of the Federal Agency for Cartography and Geodesy (BKG) Prof. Hansjörg Kutterer symbolically started the operations under a clear and sunny sky by pushing a red start button.



**Fig. 2** The Twin radio Telescope Wettzell (TTW) as Wettzell's realization of a complete VLBI2010 conformity.



**Fig. 3** A “symbolic” start of the new telescopes.

The first operational test sessions were then performed in August. The north tower of the Twin telescope joined the regular INT3 session together with the 20-m antenna. To test different digital baseband converters, one session used the Japanese ADS3000 system, while another used the DBBC. The scans were correlated in Bonn and resulted in good results, which gave also some hints for improvements of the data quality. Revised versions of the S-/X-receiver in combination with Ka and dual-polarization are under development. New software components for the new receiver and data acquisition system are designed and under implementation. A new transfer technique with the Mark 5 software “Jive5ab” from the Joint Institute for

VLBI in Europe (JIVE) allows the sending of recording data from one Mark 5 to another in real-time, which should be used to record all streams in the new Data Center in the Twin operations building.



**Fig. 4** The new control room and Data Center in the Twin operations building.

The broadband feed horn (Eleven feed) for the second telescope (south tower), which is built by Omnisys in Sweden, is almost finished and is currently in quality control. Chalmers University recently measured the radiation patterns and the data of the coherence and cross-polarization. The feed is expected for 2014.

Within a pilot study, a student of the Applied University Dresden ran a permanent survey of the reference point of the south tower, using two total stations and 20 to 30 reflectors in the back structure. The analysis showed very good stability over time.

## 6 Future Plans

Dedicated plans for 2014 are:

- Update of the de-icing control system,
- Upgrade of the RTW for complete remote control from the Twin control room,
- Completion of the Twin implementations of the north tower and continuation of the operational tests, and
- Development of new receiver and system monitoring software.

# Instituto Geográfico Nacional of Spain

Jesús Gómez-González<sup>1</sup>, José Antonio López-Fernández<sup>2</sup>, Francisco Colomer<sup>1</sup>, Luis Santos<sup>3</sup>

**Abstract** The National Geographic Institute (IGN) of Spain has been involved in space geodesy activities since 1995. Since 2008, the new 40-m radio telescope at Yebes Observatory has been a network station for IVS and has participated regularly in IVS campaigns. Currently, IGN is involved in the establishment of an Atlantic Network of Geodynamical and Space Stations (project RAEGE). The first antenna, at Yebes Observatory, has been completed. The construction of its first receiver (triband, S/X/Ka) has been finished and is ready to be installed at the telescope. Moreover, the erection of a second antenna of RAEGE (in Santa Maria, Azores islands, Portugal) is almost complete. In order to comply with the VGOS specifications, a new broadband receiver is being developed at Yebes and is expected to be available for observations in 2015.

## 1 General Information

The National Geographic Institute of Spain (Instituto Geográfico Nacional, Ministerio de Fomento), has run geodetic VLBI programs at Yebes Observatory since 1995, nowadays operating a 40-m radio telescope which is a network station for IVS. Yebes Observatory is also the reference station for the Spanish GNSS network and holds permanent facilities for gravimetry. A new VLBI2010-type antenna has been built in

1. Instituto Geográfico Nacional (IGN)

2. IGN Yebes Observatory

3. Secretaria Regional da Ciência, Tecnologia e Equipamentos (Azores, Portugal)

IGN-Yebes Network Station

IVS 2013 Annual Report

Yebes as part of the RAEGE project (the acronym RAEGE stands for “Red Atlántica hispano-portuguesa de Estaciones Geodinámicas y Espaciales”).

## 2 Current Status and Activities

The 40-m radio telescope has participated in 35 sessions (17 R1, 13 R4, three T2, and two EUROPE). All the data is being routinely transferred by Internet to the correlators.

We have purchased 64 Tb of Mark 5 disks to support our participation in the IVS CONT14 campaign.

### 2.1 RAEGE

IGN, together with the Portuguese colleagues in DSCIG (Azores Islands), continues the construction of a network of four new Fundamental Geodynamical and Space Stations. The RAEGE project was described in previous IVS Annual Reports. The Spanish-Portuguese VGOS network RAEGE will be covering three continental plates with sites in Spain at Yebes (Eurasian Plate) and Tenerife (African Plate) and in Portugal on the Azorean islands of Santa Maria (Eurasian Plate) and Flores (North American Plate).

On October 21, 2013, the first VGOS radio telescope of the RAEGE Project was inaugurated in Yebes by the Spanish Minister of Development, D<sup>a</sup> Ana Pastor, and the President of the Regional Government of Castilla-La Mancha, D<sup>a</sup> María Dolores de Cospedal. Both officials unveiled a bronze dedication plaque with the name “Jorge Juan” for the new radio telescope



**Fig. 1** RAEGE first radio telescope, “Jorge Juan”, at Yebes Observatory. In the background, the 40-m radio telescope which currently participates in all IVS campaigns.

(see Figure 2). Jorge Juan was a Spanish Admiral and cosmographer who participated, together with LaCondomine, in the 18<sup>th</sup> century expedition to Peru (now Ecuador) to measure the length of a degree of latitude at the equator and check the polar flatness of the Earth. After his return, the Spanish King Carlos III entrusted him with founding the Royal Observatory in Madrid (ROM, in 1757); today the observatory is part of the Instituto Geográfico Nacional, which – through ROM – is also the host institute of the Yebes Observatory. The “Jorge Juan” radio telescope, designed by MT Mechatronics GmbH and mostly built by Spanish companies, will be fully dedicated to geodetic VLBI. The instrument is the first of four very fast RAEGE telescopes that will be fully VGOS compliant (see Figure 1).

It will be shortly followed by the antenna in Santa María (Azores, see the status of the onsite works in Figure 3 and the control building in Figure 4), whose first light is expected in early 2015.



**Fig. 2** Bronze dedication plaque for the RAEGE “Jorge Juan” radio telescope, unveiled on October 21, 2013 by the Spanish Minister of Development, D<sup>a</sup> Ana Pastor, and the President of the Autonomous Regional Government of Castilla-La Mancha, D<sup>a</sup> María Dolores de Cospedal.

The engineers of the Yebes laboratories have completely designed and built a tri-band receiver and op-



**Fig. 3** Status of construction of the RAEGE antenna in Santa Maria (Azores islands, Portugal).

**Table 1** RAEGE instrumentation parameters.

Parameter	Value	
RT Diameter	13.2 m	
Optics	Ring focus	
Surface rms	180 $\mu$ m	
Designer	MT Mechatronics GmbH	
Az/El slew speed	12 $^{\circ}$ /sec / 6 $^{\circ}$ /sec	
Receivers	triband (S, X, Ka) dual pol (RCP+LCP)	
Band	Frequency (GHz)	Trec (K)
S band	2.2-2.7	21
X band	7.5-9.0	23
Ka band	28-33 GHz	25
DBBC type	European DBBC (IRA/INAF)	
Recorder	Mark 5B+/Mark 5C	
Yebe connectivity	10 Gbit/s fiber	



**Fig. 4** Status of construction of the control and auxiliary buildings of the RAEGE station in Santa Maria.

tics for the S (2 GHz), X (8 GHz), and Ka (32 GHz) frequency bands (see Figure 5). This receiver will be installed at the Yebe RAEGE telescope, which is expected to become available for the IVS in the first half of 2014. An identical receiver was built for GSI

(Japan), and it will be installed at their new antenna in Ishioka.

Detailed information on RAEGE is available on the Web at <http://www.raege.net/>

**Table 2** Staff in the IGN VLBI group (e-mail: [vlbitech@oan.es](mailto:vlbitech@oan.es)).

Name	Background	Role	Address*
Francisco Colomer	Astronomer	VLBI Project coordinator	IGN
Jesús Gómez-González	Astronomer	Deputy Director for Astronomy, Geophysics, and Space Applications	IGN
José Antonio López-Fdez	Engineer	RAEGE Director	Yebes
Pablo de Vicente	Astronomer	VLBI technical coordinator	Yebes
José Antonio López-Pérez	Engineer	Receivers	Yebes
Félix Tercero	Engineer	Antennas	Yebes
Susana García-Espada	Engineer	geoVLBI expert	Yebes
Javier López-Ramasco	Geodesist	Geodesist	Yebes
Alvaro Santamaría	Geodesist	Geodesist	Yebes

**Fig. 5** Tri-band (S/X/Ka) receiver, designed and built at the laboratories in Yebes Observatory.

In order to comply with the VGOS specifications, a new broadband receiver is being developed at Yebes and should be available for observations in 2015.

IGN expects to participate in the IVS CONT14 campaign with the Yebes 40-m radio telescope and will also take part in the early VGOS tests starting in 2015 with the new RAEGE 13.2-m “Jorge Juan” antenna.

RAEGE is to be completed with two more stations, in Tenerife (Canary islands) and Flores (Azores islands). Site selection for the former is very advanced, near the city of Tegueste, in the northern and most geologically stable part of the island of Tenerife. Figure 4 displays the project of the station infrastructures, including the radio telescope (under construction at MT Mechatronics GmbH) and auxiliary buildings for control, time and frequency, gravimeters, etc. The construction of this station is expected in 2016 and the one in Flores in 2017.

### 3 IGN Staff Working on VLBI Projects

Table 2 lists the IGN staff who are involved in space geodesy studies and operations. The VLBI activities are also supported by other staff such as receiver engineers, computer managers, telescope operators, secretaries, and students.

### 4 Future Plans

First light of the RAEGE radio telescope at Yebes is expected in early 2014. The construction of the second antenna of RAEGE, in Santa Maria (Azores), will also be completed in 2014.



# Zelenchujskaya Radio Astronomical Observatory 2013 IVS Annual Report

Sergey Smolentsev, Andrei Dyakov

**Abstract** This report summarizes information on activities at the Zelenchujskaya Radio Astronomical Observatory in 2013. During the previous year a number of changes were carried out at the observatory to improve some technical parameters and to upgrade some units to required status. The report also provides an overview of current geodetic VLBI activities and gives an outlook for the next year.

## 1 General Information

Zelenchujskaya Radio Astronomical Observatory (Figure 1) was founded by the Institute of Applied Astronomy (IAA) as one of three stations of the Russian VLBI network QUASAR. The sponsoring organization of the project is the Russian Academy of Sciences (RAS). The Zelenchujskaya Radio Astronomical Observatory is situated in Karachaevo-Cherkesskaya Republic (the North Caucasus) about 70 km south of Cherkessk, near Zelenchujskaya village (Table 1). The geographic location of the observatory is shown on the IAA RAS Web site: <http://www.ipa.nw.ru/PAGE/rusipa.htm>. The basic instruments of the observatory are a 32-m radio telescope equipped with special technical systems for VLBI observations, GPS/GLONASS/Galileo receivers, and an SLR system.

---

Institute of Applied Astronomy of RAS

Network Station Zelenchujskaya

IVS 2013 Annual Report

**Table 1** Zelenchujskaya Observatory location and address.

Longitude	41°34'
Latitude	43°47'
<hr/>	
Karachaevo-Cherkesskaya Republic	
369140, Russia	
ipazel@mail.svkchr.ru	



**Fig. 1** Zelenchujskaya observatory.

## 2 Technical Staff

**Table 2** Staff related to VLBI operations at Zelenchujskaya.

Andrei Dyakov	observatory chief
Dmitry Dzuba	FS, pointing system control
Anatoly Mishurinsky	front end and receiver support
Andrey Mikhailov	FS, pointing system control

### 3 Component Description

#### 3.1 Technical and Scientific Information

Characteristics of the radio telescope are presented in Table 3.

**Table 3** Technical parameters of the radio telescope.

Year of construction	2005
Mount	AZEL
Azimuth range	$\pm 270^\circ$ (from south)
Elevation range	from $-5^\circ$ to $95^\circ$
Maximum azimuth	
- velocity	$0.83^\circ/\text{s}$
- tracking velocity	$2.5''/\text{s}$
- acceleration	$12.0''/\text{s}^2$
Maximum elevation	
- velocity	$0.5^\circ/\text{s}$
- tracking velocity	$0.8''/\text{s}$
- acceleration	$12.0''/\text{s}^2$
Pointing accuracy	better than $10''$
Configuration	Cassegrain (with asymmetrical subreflector)
Main reflector diameter	32 m
Subreflector diameter	4 m
Focal length	11.4 m
Main reflector shape	quasi-paraboloid
Subreflector shape	quasi-hyperboloid
Main reflector surface accuracy	$\pm 0.5$ mm
Frequency range	1.4–22 GHz
Axis offset	$3.7 \pm 2.0$ mm

#### 3.2 Co-location of VLBI, GPS/GLONASS, and SLR System

The Javad GPS/GLONASS/Galileo receiver with meteo station WXT-510 is in operation (Figure 2). The SLR system “Sazhen-TM” (Figure 3) at Zelenchuk-skaya observatory joined the ILRS in March 2012. The technical parameters of the system are presented in Table 3.



**Fig. 2** Javad GPS/GLONASS/Galileo receiver at the Zelenchuk-skaya observatory.



**Fig. 3** “Sazhen-TM” SLR system at Zelenchukskaya observatory observed 744 passes of Lageos, GLONASS et al. and obtained 1278 normal dots.

### 4 Current Status and Activities during 2013

Zelenchukskaya observatory participates in IVS and domestic VLBI observational programs. During 2013 Zelenchukskaya station participated in 31 diurnal IVS sessions — 25 IVS-R4 sessions, two IVS-T2 sessions, and four EURO sessions.

Zelenchukskaya participated in 48 diurnal sessions in the frame of the domestic Ru-E program for determination of all Earth orientation parameters and in 349 one-hour Ru-U sessions for obtaining Universal Time using e-VLBI data transfer. Since April 2013, we have

used e-VLBI data transfer for Zelenchukskaya observational data for the Ru-E 24-hour sessions.

Finally, an antenna tower for the 13.2-m dish was built.



**Fig. 4** Antenna tower for the 13.2-m dish and RT-32 at Zelenchukskaya observatory.

- To finish VLBI2010 antenna installation in 2014.

## References

1. Finkelstein A., Ipatov A., Smolentsev S. The Network “Quasar”: 2008-2011 // “Measuring the future”, Proc. of the Fifth IVS General Meeting, A. Finkelstein, D. Behrend (eds.), St. Petersburg, “Nauka”, 2008. pp. 39–46.

## 5 Future Plans

Our plans for the coming year are the following:

- To participate in IVS observations including the CONT14 IVS campaign,
- To carry out domestic observational programs for obtaining Universal Time daily and for obtaining Earth orientation parameters weekly with e-VLBI data transfer,
- To carry out SLR observations of geodetic and navigation satellites,
- To participate in EVN and RADIOASTRON observational sessions,
- To continue geodetic monitoring of the RT-32 parameters,
- To install a WVR, and



# Operation Centers





# The Bonn Geodetic VLBI Operation Center

A. Nothnagel, A. Müssens

**Abstract** The IGGB Operation Center has continued to carry out its tasks of organizing and scheduling various observing sessions of the IVS-T2, IVS-OHIG, IVS-INT3, and EUROPE series.

## 1 Center Activities

The IGGB VLBI Operation Center is part of the Institute of Geodesy und Geoinformation of the University of Bonn, Nußallee 17, D-53115 Bonn, Germany. It has been organizing and scheduling VLBI observing sessions for almost 30 years. The work of the Operation Center is closely related to the Bonn Correlator. For this reason, distribution of media (Mark 5 disk units) to the stations after correlation is still the most costly part of the operations since network capacity has remained constant at 1 Gb/s for financial reasons.

- **Measurement of Vertical Crustal Motion in Europe by VLBI (EUROPE)**

Since the late 1980s, a series of special sessions is regularly being scheduled in Europe for precise determination of station coordinates and for long term stability monitoring. This year, six network observing sessions with Ny-Ålesund (six sessions), Onsala (four sessions), Metsahovi (one session), DSS65a (one session), Svetloe (four sessions), Zelenchukskaya (four sessions), Badary (three sessions), Effelsberg (two sessions), Wettzell (five sessions), Simeiz (five sessions), Medicina

(three sessions), Matera (two sessions), Noto (six sessions), and Yebes (YEBES40M) (two sessions) were scheduled employing the frequency setup of 16 channels and 4 MHz bandwidth (identical to the setup of the IVS-T2 sessions).

- **IVS-T2 series**

This series was observed roughly every second month (seven sessions in 2013) primarily for maintenance and stabilization of the VLBI terrestrial reference frame as well as for Earth rotation monitoring as a by-product. Each station of the global geodetic VLBI network is planned to participate in the T2 sessions at least once per year. In view of the limitations in station days, priority was given to strong and robust networks with many sites over more observing sessions. Therefore, generally 15 to 24 stations have been scheduled in each session. The scheduling of these sessions has to take into account that a sufficient number of observations is planned for each baseline of these global networks. The recording frequency setup is 16 channels and 4 MHz channel bandwidth.

- **Southern Hemisphere and Antarctica Series (OHIG):**

In February 2013, three sessions of the Southern Hemisphere and Antarctica Series with the Antarctic stations Syowa (Japanese) and O'Higgins (German) plus Fortaleza, HartRAO, and Kokee have been organized (OHIG82-83-84). Furthermore, O'Higgins was also included successfully in the T2088 session. The (southern) winter O'Higgins burst (OHIG85-86-87) was scheduled, but it had to be observed without O'Higgins for

---

Institut für Geodäsie und Geoinformation der Universität Bonn

Bonn Operation Center

IVS 2013 Annual Report

various reasons. Other participating stations were Fortaleza, HartRAO, Kokee, Syowa, HOBART12, KATH12M, Kokee, WARK12M, TIGOCONC, and YARR12M. The purpose of these sessions is the maintenance of the VLBI terrestrial reference frame (TRF) and the monitoring of Earth rotation as a by-product. The recording frequency setup is 16 channels and 4 MHz channel bandwidth. Due to the fact that Syowa is not able to deliver the recorded data for nearly one year after the observations, the correlation and the generation of the databases is always delayed considerably.

- **UT1 determination with near-real-time e-VLBI (INT3):**

The so-called INT3 sessions were originally set up for the telescopes of Ny-Ålesund, Tsukuba, and Wettzell for weekly UT1 determinations aiming at very quick delivery of results. The sessions are always scheduled to start on Monday morning at 7:00 a.m. UT.

Due to maintenance activities at Tsukuba, Ny-Ålesund, and Wettzell, one or more of these stations sometimes had to be replaced by other suitable telescopes. From May to December, Seshan replaced Tsukuba in 26 sessions. Since then, Seshan has taken part in the INT3 sessions on a monthly basis. Svetloe replaced Wettzell and Ny-Ålesund during June to September, and Yebes replaced them during August. No suitable observing configuration could be established for 17 sessions, which had to be canceled entirely.

The operations part of the INT3 sessions also includes rapid data transmission and correlation. The raw VLBI observation data of four sites is transferred to the Bonn Correlator by Internet connections directly after the session is completed in order to speed up delivery of the results. The transmission rate is about 400-600 Mb/s from Tsukuba and Wettzell, 300 Mb/s from Seshan, and 100 Mb/s for Ny-Ålesund. For the latter, the data rate is limited due to the use of a radio link for the first part of the distance. All transmissions share the “last mile” which is limited to 1 Gb/s due to financial limitations.

Altogether, 33 INT3 sessions were observed and transmitted successfully in 2013. 96% of the sessions were correlated and the databases delivered

within the first four hours after the end of the observations. A further 2% were completed within ten hours. The rest took between ten and 48 hours due to difficulties with networking hardware and/or station and processor problems.

## 2 Staff

**Table 1** Personnel at IGGB Operation Center.

Arno Műskens	+49-228-525264	mueskens@mpifr.de
Axel Nothnagel	+49-228-733574	nothnagel@uni-bonn.de



# CORE Operation Center 2013 Annual Report

Cynthia C. Thomas, Daniel S. MacMillan

**Abstract** This report gives a synopsis of the activities of the CORE Operation Center from January 2013 to December 2013. The report forecasts activities planned for the year 2014.

## 1 Changes to the CORE Operation Center's Program

The Earth orientation parameter goal of the IVS program is to attain precision at least as good as  $3.5 \mu\text{s}$  for UT1 and  $100 \mu\text{as}$  for pole position.

The IVS program, which started in 2002, used the Mark IV recording mode for each session. The IVS program began using the Mark 5 recording mode in mid-2003. By the end of 2007, all stations were upgraded to Mark 5. Due to the efficient Mark 5 correlator, the program continues to be dependent on station time and media. The following are the network configurations for the sessions for which the CORE Operation Center was responsible in 2013:

- IVS-R1: 53 sessions, scheduled weekly and mainly on Mondays, five to twelve station networks
- RDV: Six sessions, scheduled evenly throughout the year, 14 to 16 station networks
- IVS-R&D: Ten sessions, scheduled monthly, six to ten station networks

---

NVI, Inc.

CORE Operation Center

IVS 2013 Annual Report

## 2 IVS Sessions from January 2013 to December 2013

This section displays the purpose of the IVS sessions for which the CORE Operation Center is responsible.

- IVS-R1: In 2013, the IVS-R1s were scheduled weekly with five to twelve station networks. During the year, 19 different stations participated in the IVS-R1 network, but there were only eight stations that participated in at least half of the scheduled sessions—Tigo (51), Ny-Ålesund (47), Wettzell (41), Fortaleza (40), Westford (39), Hobart12 (28), Kokee (28), and Katherine (26). Aira participated in the IVS-R1 sessions for the first time during 2013.

The purpose of the IVS-R1 sessions is to provide weekly EOP results on a timely basis. These sessions provide continuity with the previous CORE series. The “R” stands for rapid turnaround because the stations, correlators, and analysts have a commitment to make the time delay from the end of recording to the results as short as possible. The time delay goal is a maximum of 15 days. Eighty-one percent of the IVS-R1 sessions were completed in 15 or fewer days. The remaining 19% were completed in 16 to 24 days [16 days (four), 17 days (one), 20 days (two), 23 days (two), and 24 days (one)]. Participating stations are requested to ship disks to the correlator as rapidly as possible or to transfer the data electronically to the correlator using e-VLBI. The “1” indicates that the sessions are mainly on Mondays.

- RDV: There are six bi-monthly coordinated astrometric/geodetic experiments each year that use the

full ten-station VLBA plus up to six geodetic stations.

These sessions are being coordinated by the geodetic VLBI programs of three agencies: 1. USNO performs repeated imaging and correction for source structure; 2. NASA analyzes this data to determine a high accuracy terrestrial reference frame; and 3. NRAO uses these sessions to provide a service to users who require high quality positions for a small number of sources. NASA (the CORE Operation Center) prepares the schedules for the RDV sessions.

- R&D: The purpose of the ten R&D sessions in 2013, as decided by the IVS Observing Program Committee, was to support mixed mode observing (RD1301), vet sources for the good geodetic catalog (RD1302 and RD1304), vet sources for the good geodetic catalog and GAIA proposal sources (category 4) (RD1303), observe linked sources between GAIA and ICRF-2 (RD1305 through RD1308), and test the 512 Mbps recording mode for the CONT14 Campaign.

### 3 Current Analysis of the CORE Operation Center's IVS Sessions

Table 1 gives the average formal errors for the R1, R4, RDV, R&D, and T2 sessions from 2013. The R1 session formal uncertainties are not significantly different from the 2011-2012 errors. The R4 uncertainties for the 2012-2013 sessions are much better than for 2011. R4 stations performed better in 2012-2013 than in 2011, where 37 sessions lost one or more stations from the original scheduled network. R1 uncertainties for 2011-2013 could be reduced if we used a GPS a priori model to obtain the post-earthquake behavior at Tsukuba instead of estimating the TSUKUB32 position for each session, thereby weakening its contribution to EOP.

RDV uncertainties are about 10% larger for 2013 than for 2011 and 2012. The RDV formal errors are still better than the other experiment series. This is due to the large number of stations in the RDV sessions as well as to better global geometry. T2 uncertainties for X-pole and nutation in longitude are clearly better in 2013 than for 2011-2012. For comparison, we also included the formal uncertainties for the CONT11, which

are much better than any of the networks discussed above that observed in 2013.

Table 2 shows EOP differences with respect to the IGS series for the R1, R4, T2, RDV, and CONT11 series. The WRMS differences were computed after removing a bias, but estimating rates does not affect the residual WRMS significantly. Except for the R4 X-pole, R1 and R4 series have worse WRMS agreement in X-pole, Y-pole, and LOD for 2013 than for these series since 2000. Part of this may be explained by the treatment of TSUKUB32 in solutions as discussed above. Adopting the improved GPS a priori model strategy above improves the R1 agreement with IGS by 20%. It is not understood why the R4 Y-pole WRMS difference relative to IGS is so much greater for 2013 than for the long-term series. Both the X-pole and Y-pole biases of the R1 and R4 sessions relative to IGS differ by 70 uas, which is much greater than the uncertainty of the bias estimates. Of all the series, the RDV series has the best WRMS agreement of X-pole and Y-pole with IGS estimates in 2013 and for the full period, 2000-2013. For comparison with the 2013 sessions discussed here, we included the statistics for the 15 CONT11 sessions, which shows the best WRMS agreement with IGS. This is expected because the CONT11 network 1) has better geometry and 2) is unchanged over the period of 15 days of continuous observing.

### 4 The CORE Operations Staff

Table 3 lists the key technical personnel and their responsibilities so that everyone reading this report will know whom to contact about their particular question.

### 5 Planned Activities during 2014

The CORE Operation Center will continue to be responsible for the following IVS sessions during 2014:

- The IVS-R1 sessions will be observed weekly and recorded in Mark 5 mode.
- The IVS-R&D sessions will be observed ten times during the year.
- The RDV sessions will be observed six times during the year.

**Table 1** Average EOP Formal Uncertainties for 2013.

Session Type	Num	X-pole ( $\mu$ as)	Y-pole ( $\mu$ as)	UT1 ( $\mu$ s)	DPSI ( $\mu$ as)	DEPS ( $\mu$ as)
R1	51	67(73,67)	66(63,65)	3.1(3.4,3.0)	105(110,111)	42(44,45)
R4	51	68(70,84)	66(67,75)	2.9(2.8,3.2)	120(124,160)	49(49,65)
RDV	6	54(48,49)	54(48,46)	2.8(2.5,2.5)	82(68,75)	33(28,30)
T2	6	67(83,89)	66(66,90)	3.4(3.9,4.3)	130(146,176)	50(57,67)
CONT11	15	39	38	1.7	42	17

Values in parentheses are for 2012 and then 2011.

**Table 2** Offset and WRMS Differences (2013) Relative to the IGS Combined Series.

Session Type	Num	X-pole		Y-pole		LOD	
		Offset ( $\mu$ as)	WRMS ( $\mu$ as)	Offset ( $\mu$ as)	WRMS ( $\mu$ as)	Offset ( $\mu$ s/d)	WRMS ( $\mu$ s/d)
R1	51(620)	-103(-1)	124(104)	6(12)	122(91)	2.6(0.8)	22(17)
R4	51(618)	-33(-22)	97(113)	72(21)	134(115)	0.8(1.8)	18(18)
RDV	6(84)	41(58)	68(81)	-46(2)	70(68)	2.1(-0.2)	12(14)
T2	6(81)	0.3(3)	108(141)	47(5)	128(117)	10.8(2.2)	16(19)
CONT11	15	42	36	9	29	7.0	7

Values in parentheses are for the entire series (since 2000) for each session type.

**Table 3** Key Technical Staff of the CORE Operations Center.

Name	Responsibility	Agency
Dirk Behrend	Organizer of CORE program	NVI, Inc./GSFC
Brian Corey	Analysis	Haystack
Ricky Figueroa	Receiver maintenance	ITT Exelis
John Gipson	SKED program support and development	NVI, Inc./GSFC
Frank Gomez	Software engineer for the Web site	Raytheon/GSFC
David Gordon	Analysis	NVI, Inc./GSFC
Ed Himwich	Network Coordinator	NVI, Inc./GSFC
Dan MacMillan	Analysis	NVI, Inc./GSFC
Katie Pazamickas	Maser maintenance	ITT Exelis
David Rubincam	Procurement of materials necessary for CORE operations	GSFC/NASA
Braulio Sanchez	Procurement of materials necessary for CORE operations	GSFC/NASA
Dan Smythe	Tape recorder maintenance	Haystack
Cynthia Thomas	Coordination of master observing schedule and preparation of observing schedules	NVI, Inc./GSFC

# NEOS Operation Center

David M. Hall, Merri Sue Carter

**Abstract** This report covers the activities of the NEOS Operation Center at USNO for 2013. The Operation Center schedules IVS-R4 and the INT1 Intensive experiments.

## 1 VLBI Operations

NEOS operations in the period covered consisted, each week, of one 24-hour duration IVS-R4 observing session, on Thursday-Friday, for Earth Orientation, together with five daily one-hour duration “Intensives” for UT1 determination, Monday through Friday. In 2013, the operational IVS-R4 network included VLBI stations at Kokee Park (Hawaii), Wettzell (Germany), Ny-Ålesund (Norway), TIGO (Chile), Fortaleza (Brazil), Tsukuba (Japan), Svetloe, Badary and Zelenchukskaya (Russia), Hobart, Katherine and Yarragadee (Australia), Yebes (Spain), and Matera and Medicina (Italy). A typical R4 consisted of eight to twelve stations.

The regular stations for the weekday IVS Intensives were Kokee Park and Wettzell. Intensives including Kokee Park, Wettzell, and Svetloe were occasionally scheduled in order to characterize the Kokee Park — Svetloe baseline so that Svetloe can be used as an alternate for Wettzell should it be needed. Odd-day Intensives were scheduled with the scheduling technique used since 2000; even-day Intensives were scheduled

with an experimental scheduling technique developed in 2009.

The Operation Center updated the version of sked as updates became available.

All sessions are correlated at the Washington Correlator, which is located at USNO and is run by NEOS.

**Table 1** Experiments Scheduled during 2013.

Number of Experiments	Type
52	IVS-R4 experiments
227	Intensives

## 2 Staff

D. M. Hall and M. S. Carter are the only staff members of the NEOS Operation Center. Mr. Hall is responsible for the overall management, and Carter makes the schedules. M. S. Carter is located at the USNO Flagstaff Station (NOFS).

---

U.S. Naval Observatory

NEOS Operation Center at USNO

IVS 2013 Annual Report

# Correlators





# The Bonn Astro/Geo Correlator

Laura La Porta<sup>1</sup>, Walter Alef<sup>2</sup>, Alessandra Bertarini<sup>1,2</sup>, Simone Bernhart<sup>1,2</sup>, Gabriele Bruni<sup>2</sup>, Arno Müskens<sup>1</sup>, Helge Rottmann<sup>2</sup>, Alan Roy<sup>2</sup>, Gino Tuccari<sup>2,3</sup>

**Abstract** The Bonn Distributed FX (DiFX) correlator is a software correlator operated jointly by the Max-Planck-Institut für Radioastronomie (MPIfR), the Institut für Geodäsie und Geoinformation der Universität Bonn (IGG), and the Bundesamt für Kartographie und Geodäsie (BKG) in Frankfurt, Germany.

## 1 Introduction

The Bonn correlator is located at the MPIfR<sup>1</sup> in Bonn, Germany. It is operated jointly by the MPIfR and the BKG<sup>2</sup> in cooperation with the IGG<sup>3</sup>. It is a major correlator for geodetic observations and astronomical projects (for instance, those involving pulsar gating, millimeter wavelengths, astrometry, and RadioAstron<sup>4</sup>).

1. Institut für Geodäsie und Geoinformation der Universität Bonn

2. Max-Planck-Institut für Radioastronomie

3. Istituto di Radioastronomia - INAF

Bonn Correlator

IVS 2013 Annual Report

<sup>1</sup> <http://www.mpifr-bonn.mpg.de/>

<sup>2</sup> <http://www.bkg.bund.de/>

<sup>3</sup> <http://www.gib.uni-bonn.de/>

<sup>4</sup> <http://www.asc.rssi.ru/radioastron/>

## 2 Present Correlator Capabilities

The DiFX correlator<sup>5</sup> was developed at Swinburne University in Melbourne by Adam Deller and other collaborators. It was adapted to the VLBA operational environment by Walter Brisken and the NRAO staff, and it is constantly updated by the worldwide DiFX developers group. In Bonn, the DiFX is running on a High Performance Compute Cluster (HPC cluster), whose features are:

- 60 nodes (eight compute cores each)
- four TFlops in the Linpack benchmark test
- 20 Gbps Infiniband interconnection
- 13 RAID5s (about 480 TB storage capacity)
- one control node for correlation (*fxmanager*)
- one computer (*frontend*) for executing parallelized jobs on the cluster, e.g. post-correlation applications
- one control computer (*appliance*) for installing and monitoring the cluster
- closed loop rack cooling

The HPC cluster connected via 20 Gbps Infiniband to 14 Mark 5 units<sup>6</sup> is used for playing back the data. If more than 14 playback units are required, and in the case of e-VLBI, the data are copied to the RAID5s prior to correlation. The Mark 5 units can deal with all types of Mark 5 formats (A/B/C). The disk modules in the Mark 5 are controlled via the NRAO's *mk5daemon* program. The available functionality includes recording the directories of the modules, resetting and rebooting the units, and module conditioning. In 2013, the

<sup>5</sup> DiFX: A Software Correlator for Very Long Baseline Interferometry using Multiprocessor Computing Environments, 2007, PASP, 119, 318

<sup>6</sup> <http://www.haystack.mit.edu/tech/vlbi/mark5/>

Software Development Kit (SDK) of the Mark 5 units was upgraded to version 9.1, which enables the usage of larger disks. A summary of the capabilities of the DiFX software correlator is presented in Table 1.

### 3 Staff

The people in the Geodesy VLBI group at the Bonn correlator are:

**Arno Müskens** - group leader and scheduler of T2, OHIG, EURO, and INT3 sessions.

**Simone Bernhart** - support scientist, e-transfer supervision and operations, experiment setup and evaluation of correlated data for geodesy and RadioAstron, and media shipping.

**Alessandra Bertarini** - Friend of the correlator, experiment setup and evaluation of correlated data for both astronomy (e.g. APEX) and geodesy, and digital base-band converter (DBBC) testing.

**Laura La Porta** - support scientist, e-transfer supervision and operations, geodetic experiment setup and evaluation of correlated data, media shipping, DBBC testing, and programmer for automated preparation of correlator reports.

The people in the astronomical group at the Bonn correlator are:

**Walter Alef** - head of the VLBI technical department, computer systems, and cluster administration.

**Alan Roy** - deputy group leader, support scientist (water vapor radiometer, technical assistance, development of FPGA firmware for linear to circular polarization conversion, and project manager for equipping APEX for millimeter VLBI).

**Gabriele Bruni** - support scientist for RadioAstron, experiment setup and evaluation of correlated data, and e-transfer supervision and operations.

**Armin Felke** - FPGA programming for DBBC.

**Heinz Fuchs** - correlator operator, responsible for the correlator operator schedule, daily operations, and media shipping.

**David Graham** - consultant (technical development, DBBC development, and testing).

**Rolf Märtnens** - technician maintaining cluster hardware and Mark 5 playbacks.

**Helge Rottmann** - software engineer for correlator development and operation, cluster administration, DBBC and RDBE control software, and the Field

System.

**Hermann Sturm** - correlator operator, correlator support software, media shipping, and Web page development.

**Gino Tuccari** - guest scientist from INAF, DBBC development, and DBBC project leader.

**Jan Wagner** - PhD student, support scientist for APEX, DBBC development, and DiFX developer.

**Michael Wunderlich** - engineer, development and testing of DBBC components.

### 4 Status

**Experiments:** In 2013 the Bonn group correlated 54 R1, six EURO, seven T2, six OHIG, 35 INT3, and about 40 astronomical sessions (including data from Early-Science and the first two A0-1 projects of RadioAstron).

**e-VLBI:** The total disk space available for e-VLBI data storage at the correlator is about 130 TB. The Web page that shows current active e-transfers and helps to coordinate transfer times and rates on a first come-first served basis<sup>7</sup>, reports also the storage capacity at the three correlators (Washington, Haystack, and Bonn). On average  $\geq 80\%$  of the stations do e-transfer. The average amount of e-transferred data per week is about 8 TB, considering only the regular INT3 and R1 experiments. Most transfers are done using the UDP-based Tsunami protocol, and the achieved data rates range from 100 Mb/s to 800 Mb/s. The upgrade of the 1 Gbps Internet connection to meet the requirements of VLBI2010 Global Observing System (VGOS) has not been realized yet, due to funding issues.

**DiFX software correlator:** The DiFX software correlator has been operated in Bonn since 2009 and is continuously updated. The stable DiFX release 2.2 was installed in 2013.

Two other branch versions of the DiFX software correlator are available in Bonn: a DiFX version for RFI mitigation, developed by J. Wagner, and a DiFX version dedicated to RadioAstron (a Russian satellite that observes in conjunction with ground-based telescopes), developed by J. Anderson.

**DBBC:** The Bonn group is involved in the develop-

<sup>7</sup> <http://www3.mpifr-bonn.mpg.de/cgi-bin/showtransfers.cgi>



**Table 1** Correlator capabilities.

<b>Playback Units</b>	
Number available	14 Mark 5 (four Mark 5A, two Mark 5B, eight Mark 5C)
Playback speed	1.5 Gbps
Formats	Mark 5A, Mark 5B, VDIF
Sampling	1 bit, 2 bits
Fan-out (Mark 5A)	1:1, 1:2, 1:4
No. channels	≤ 16 USB and/or LSB
Bandwidth/channel	(2, 4, 6, 8, 32) MHz
Signal	Single-, dual-frequency; all four Stokes parameters for circular and linear polarization
<b>Correlation</b>	
Geometric model	CALC 9
Phase cal	Phase-cal extraction of all tones in a sub-band simultaneously
Pre-average time	Milliseconds to seconds
Spectral channels	Max no. of FFT tested 2 <sup>18</sup>
Export	FITS export. Interface to Mk IV data format which enables the use of geodetic analysis software and Haystack fringe fitting program.
Pulsar	Pulsar with incoherent de-dispersion

ment and testing of the DBBC for the European VLBI Network (EVN) and geodesy. The DBBC is designed as a full replacement for the existing analog BBCs. The following stations have already bought one or more DBBCs: APEX, AuScope (Australia), HartRAO (Africa), Effelsberg, Medicina, Onsala, Pico Veleta, Yebes, Wettzell, and Warkworth. Recently, the HartRAO and Onsala stations switched to DBBCs also for geodetic experiments, whereas Yebes, Medicina, and Wettzell are still in the testing process. The remaining stations routinely use the DBBCs.

A prototype of the next generation DBBC (DBBC3-L) was realized, which can handle a larger bandwidth of 4 GHz. In a second stage the DBBC3-H will be able to sample the full frequency range of 1 to 14 GHz without performing any downconversion.

**APEX:** The Bonn VLBI group has equipped the APEX telescope for VLBI observations at 1 mm. In 2013 APEX got into science operations by taking part in the Event Horizon Telescope (EHT) campaign. Observations were carried out at 4 Gbps, lasted about 50 hours and provided good detections for several sources (see Figure 1 for an example).

## 5 Outlook for 2014

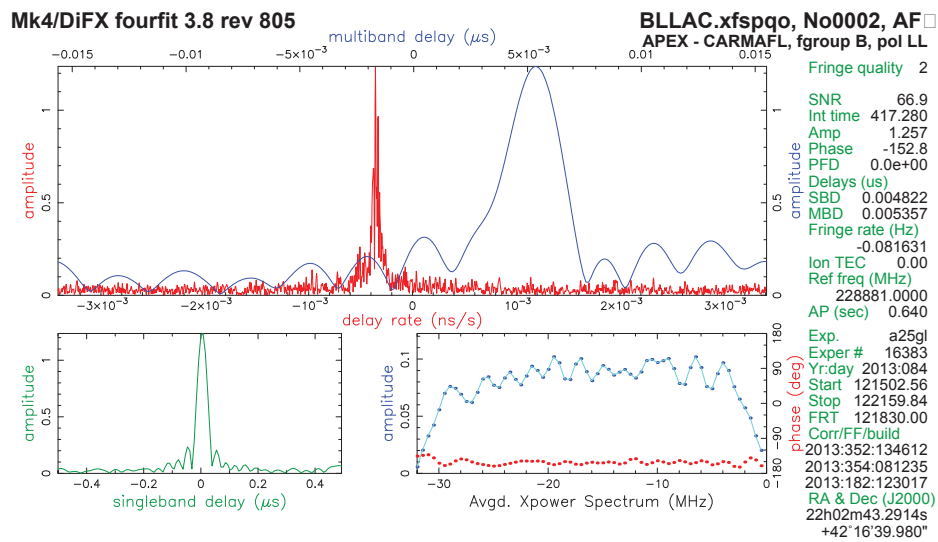
**DiFX Correlator:** A proposal to replace the now six year old cluster with a more modern system is being

prepared. Two Mark 6 units with 16 Gbps recording capability have been bought to comply with VGOS requirements. The Mark 6 units will be installed and tested. The RadioAstron DiFX branch versions will be merged with the current development version of the DiFX.

**e-VLBI:** Purchase of a new 80 TB RAID for RadioAstron.

**DBBC:** Continue testing for the stations that recently acquired DBBCs. Wide bandwidth modes are also under test. Testing of DBBC3.

**Phasing up ALMA:** The group is involved in an international project to add array phasing capability to ALMA. ALMA will record with a data rate of 64 Gbps, thus being an extremely sensitive station in 1 mm VLBI experiments, which will be correlated in Bonn.



**Fig. 1** 1 mm observations of the source BL Lacertae in March 2013, baseline APEX-Combined Array for Research in Millimeter-wave Astronomy (CARMA, California). The fringe spacing was 29 microarcseconds, the finest yet achieved.

# Haystack Observatory VLBI Correlator

Mike Titus, Roger Cappallo, Brian Corey, Kevin Dudevior, Arthur Niell, Jason SooHoo, Alan Whitney

**Abstract** This report summarizes the activities at the Haystack Correlator during 2013. Highlights include the transition from Mark IV to DiFX for full time production and the decommissioning of the Mark IV in July, enhancement of the DiFX cluster with additional disk space for increased flexibility, and processing of two 24-hour broadband delay experiments and new u-VLBI Galactic Center observations that included several new antennas. Non-real-time e-VLBI transfers and software support of other correlators continued.

## 1 Introduction

The Mark IV and DiFX VLBI correlators of the MIT Haystack Observatory, located in Westford, Massachusetts, are supported by the NASA Space Geodesy Program and the National Science Foundation. They are dedicated mainly to the pursuits of the IVS, with a smaller fraction of time allocated to processing radio astronomy observations for the Ultra High Sensitivity VLBI (u-VLBI) project. The Haystack correlators serve as development systems for testing new correlation modes, for hardware improvements such as the Mark 6 system, and in the case of the Mark IV, for diagnosing correlator problems encountered at Haystack and at the identical correlator at the U.S. Naval Observatory. This flexibility is made possible by the presence on-site of the team that designed the Mark IV correlator hardware and software. Some

---

MIT Haystack Observatory

Haystack Correlator

IVS 2013 Annual Report

software support is provided to the Max Planck Institute for Radioastronomy in Bonn, Germany and to the general IVS community, for DiFX processing of IVS experiments.

## 2 Summary of Activities

### 2.1 DiFX Transition

The switch over to full-time DiFX production occurred in early July. The first IVS experiment fully processed on DiFX was RD1304, and all correlation is now done on the DiFX cluster. Because our cluster setup differs greatly from the other large installations on which our the DiFX software suite is based, various programs had to be modified from their default behaviors in order to work in the Haystack production environment. A particularly critical one was *genmachines*, which had to be modified to re-allocate core processors efficiently for us. *startdifx* also had to be adapted, and problems with corrupt module directories and Mark 5 playback unit readpos errors had to be resolved. These issues have been largely overcome, and production processing runs smoothly most of the time, but work remains to be done to improve the flexibility of the production environment to efficiently handle the inevitable problems that arise.

### 2.2 DiFX Cluster Developments

The amount of storage space was greatly increased over the last year with the addition of two new file

servers and more disks for the compute cores. The > 142 TB of additional space has made it possible to correlate more stations from files, to supplement the Mark 5 playback units. This, along with the increased number of stations sending their data via e-VLBI, allows experiments with a large number of stations to be correlated in one pass. Another file server and a new head node are due to be added to the cluster shortly.

### **2.3 DiFX Software Support**

Support for the community continues for *difx2mark4*, *fourfit*, and HOPS. This support includes addition of features requested by users, other enhancements, and bug fixes.

### **2.4 USNO GUI Installation**

John Spitzak of USNO visited Haystack in December to install the USNO GUI for setting up and running experiments. The GUI was demonstrated to work in our environment, which is the first time it had been installed outside of USNO.

### **2.5 DiFX-Mark IV Correlator Comparison of Experiment RD1208**

RD1208 was processed in its entirety on DiFX in as nearly identical a way as possible to the Mark IV in order to use it for a comprehensive comparison. Analysis of this data is pending.

### **2.6 Broadband Delay**

Major broadband delay experiments were conducted in January and May. In January the 24-hour “mixed mode” RD1301 session was observed, with the GGAO 12-m and Westford antennas recording broadband data and seven other IVS stations recording standard S/X data at frequencies partially in common with the broadband. But further development of “zoom mode” in

DiFX is needed before the mixed wide/narrow band data can be processed. In May broadband data were recorded at GGAO and Westford over 24 hours primarily as a test of amplitude calibration. Processing of the amplitude data for the May session is complete, and work has begun to obtain geodetic results from the data.

### **2.7 DBE Testing**

Various DBE testing projects were conducted during the year. Testing RDBE-H v1.4 vs. 1.5 firmware both in the lab and between GGAO-Wf is one example. Testing of RDBE v3.0 with complex mode format has begun.

### **2.8 Mark 6**

A Mark 6 playback unit was added to the DiFX cluster late in the year. Zero-baseline data of various kinds have been obtained from the RDBEs to test Mark 6 recording, playback, and correlation. VDIF format fixes were initially needed in order to make correlation of this recording format work.

### **2.9 Galactic Center Observations**

Further u-VLBI observations of the Galactic Center and other target sources, with dual polarization at most sites, were recorded and correlated in 2013. These included three stations in addition to those participating last year: APEX in Chile, Pico Veleta in Spain, and Plateau de Bure in France. In July, fringes were found to the LMT (Large MM Telescope), a new antenna in Mexico. This antenna will be added to Event Horizon Telescope (EHT) observations in the future.

### **2.10 2013 IVS TOW**

For the IVS TOW meeting in May, the Haystack DiFX cluster was used for a “practical correlation” class. A

small computer lab was set up to give students practice in setting up an IVS experiment for correlation.

### 2.11 Support for Other Correlators

There were various projects to assist other correlators. The USNO Mark IV experienced a failure of crate two after some maintenance. This was diagnosed as a FIFO chip failure and repaired. Support was provided to Bonn for help with EHT co-processing of the March observations. Help was provided to the Seshan group so they could reproduce one of the DBE tests conducted in October 2012 at Haystack, in order for them to validate their DiFX installation. Similar support was given to the ASIAA group in Taiwan to assist them in getting started with EHT project correlation on DiFX.

### 2.12 e-VLBI

Non-real-time transfers have continued. Data from 17 sessions were transferred to Haystack this year from 20 stations (eight in Japan, four in Western Europe, four in Australia, two in South America, and two in South Africa): Kashima34, Kashima11, Koganei, Tsukuba, Chichijima, Ishigaki, Aira, Mizusawa, Onsala, Ny-Ålesund, Wetzell, Noto, Hobart, Yarragadee, Katherine, Warkworth, Fortaleza, Concepción (via Bonn), Hart15M and HartRAO. The number and speed of e-VLBI transfers increased significantly this year after an upgrade to Haystack's Internet connectivity in 2012 enabled data transfer rates up to 1.4 Gb/sec.

## 3 Experiments Correlated

In 2013, 31 geodetic VLBI sessions were processed, at least in part, consisting of 15 R&Ds, five T2s, and 11 tests of various types. The test sessions included the broadband sessions and fringe tests and an assortment of other projects, some of which were touched on in the summary above. As usual, smaller tests were not included in the above count because they were too small to warrant individual experiment numbers. Routine production (i.e., not test experiments) was per-

fomed full time on the Mark IV at the beginning of the year, then switched to the the DiFX correlator in July, as noted previously.

## 4 Current/Future Hardware and Capabilities

The Mark IV hardware correlator configuration described in last year's report has been powered down. The DiFX cluster currently consists of six PCs, each with dual hex core 2.66 GHz Intel Xeon processors. Two file storage servers, which can also act as DiFX compute nodes, provide 120 TB of file storage. These are all connected through a 40 Gb/sec infiniband network fabric using a Qlogic switch. Currently six Mark 5B playback units with DiFX fully installed are connected to the infiniband fabric. We have processed up to 19 stations in one pass with this setup through a combination of playback units and files.

In 2014 we plan to add more storage, more compute nodes, and a new head node, as currently one of the compute nodes serves in the latter role.

## 5 Staff

### 5.1 Software Development Team

- John Ball - Mark 5A/5B; e-VLBI, retired in August 2013
- Roger Cappallo - HOPS post-processing software; Mark 6 development; DiFX software development; correlation trouble-shooting
- Geoff Crew - DiFX correlator development, post-processing software; Mark 6
- Kevin Dudevair - correlation; maintenance/support; Mark 5A/5B/5C; e-VLBI; Linux conversion; correlator software and build system development; computer system support/development; DiFX correlator development
- Jason SooHoo - e-VLBI; Mark 5A/5B/5C/6; computer system support
- Chester Ruzarczyk - e-VLBI; Mark 5A/5B/5C/6
- Alan Whitney - system architecture; Mark 5A/5B/5C/6; e-VLBI

## **5.2 Operations Team**

- Peter Bolis - correlator maintenance
- Alex Burns - playback drive maintenance; Mark 5 installation and maintenance; general technical support
- Brian Corey - experiment correlation oversight; station evaluation; technique development
- Glenn Millson - correlator operator
- Arthur Niell - technique development
- Don Sousa - correlator operator; experiment setup; tape library and shipping
- Mike Titus - correlator operations oversight; experiment setup; computer services; software and hardware testing
- Ken Wilson - correlator maintenance; playback drive maintenance; general technical support

## **6 Conclusion/Outlook**

Operational correlation at Haystack has fully migrated to the DiFX software correlator. Enhancement of our modest cluster is expected to continue in 2014 with the addition of a dedicated head node and additional file servers. Efforts to improve the production environment will continue. Testing and full integration of Mark 6 recording systems and RDBE v3.0 into operations are underway. More broadband observations, including the addition of the Kokee 20-m antenna with a new broadband system, are anticipated.

# IAA Correlator Center 2013 Annual Report

Igor Surkis, Voytsekh Ken, Yana Kurdubova, Alexey Melnikov, Vladimir Mishin, Dmitry Pavlov, Nadezda Sokolova, Violet Shantyr, Vladimir Zimovsky

**Abstract** The activities of the six-station IAA RAS correlator include regular processing of national geodetic VLBI programs Ru-E, Ru-U, and Ru-F. The Ru-U sessions have been transferred in e-VLBI mode and correlated in the IAA Correlator Center since 2011. In addition, the new FX correlator is being designed.

## 1 General Information

The IAA Correlator Center is located at and staffed by the Institute of Applied Astronomy in St.-Petersburg, Russia.

The IAA Correlator Center is devoted to processing geodetic, astrometric, and astrophysical observations made with the Russian national VLBI network Quasar.

## 2 Component Description

The ARC (Astrometric Radiointerferometric Correlator) (Figure 1) was the main data processing device in the IAA Correlator Center in 2013. The ARC was designed and built in the IAA RAS from 2007 - 2009. The correlator has XF design and is based on FPGA technology.

The ARC is a six-station, 15-baseline correlator. It is able to process up to 16 frequency channels on

each baseline, for a total of 240 channels. The correlator accesses two-bit VLBI signals with 32 MHz maximal clock frequency. The maximal data range from each station is 1 Gbit per second. The correlator requires VSI-H input VLBI signals, and it is equipped with Mark 5B playback terminals.

Since 2011, the DiFX software correlator has been used for some astrophysical experiments. DiFX is installed at the IAA on a Sun Fire X4450 Server as a virtual machine under the VMware.

## 3 Staff

- Igor Surkis — leading investigator, software developer;
- Voytsekh Ken — GPU software developer;
- Alexey Melnikov — DiFX processing, scheduler of the Ru-sessions;
- Vladimir Mishin — software developer, data processing;
- Nadezda Sokolova — software developer;
- Yana Kurdubova — software developer;
- Dmitry Pavlov — software developer;
- Violet Shantyr — software developer, post processing;
- Vladimir Zimovsky — leading data processing;
- Ekaterina Medvedeva — data processing;
- Alexander Salnikov — leading e-VLBI data transfer;
- Ilya Bezrukov — e-VLBI data transfer.

---

Institute of Applied Astronomy RAS

IAA Correlator

IVS 2013 Annual Report



**Fig. 1** View of the six-station ARC correlator, showing four racks containing (left to right) signal distribution and synchronization system (SDSS) and three Mark 5B playback units, two correlator crates and KVM, three correlator crates, and one more cabinet with SDSS and three Mark 5B playback units.

## 4 Current Status and Activities

### 4.1 Ru Sessions

The ARC correlator was used for processing all of the national geodetic VLBI observations in the IAA Correlator Center in 2013. The Ru-E and Ru-U geodetic VLBI sessions were carried out in IAA RAS.

The three-station, 24-hour EOP determination Ru-E sessions were carried out once per week, as in 2012.

The two-station, one-hour UT1-UTC determination sessions in e-VLBI mode were carried out once per day. The Ru-U sessions were executed with frequency channel bandwidth 8 MHz and total bitrate 256 Mbps. The data transfer speed from stations to correlator was improved in 2012, and near to realtime correlation processing with data bitrate 256 Mbps was achieved.

### 4.2 DiFX Processing

In 2013, the DiFX software correlator continued to be the main spectral line source processing tool. Target sources are Orion KL, W49N, W3OH, and W75. It is used to correlate data streams of 16-64 Mbps bitrate. Output data resolution was up to 8,192 spectral channels which allows achievement of a frequency resolution of 0.25 kHz for W3OH in L-band. 41 Ru-P experiments were scheduled and observed in 2013, including Crab nebula observations at L-band. Several experiments to monitor RFI were conducted. One experiment with 2 Gbps bitrate and standard wideband geodetic frequency mode and one experiment with 2 Gbps and 512 MHz bandwidth in X-band were done. The latter experiment is planned to be processed in early 2014. Three experiments were done with the Effelsberg radio telescope in collaboration with the Max Planck Institute for Radioastronomy. Data were transferred from Bonn to Saint Petersburg using tsunami protocol at data rates up to 400 Mbps. Medicina and Noto also joined



one experiment and e-transferred data to Saint Petersburg directly from the stations to the Correlator Center. DiFX is installed on a GNU/Linux VMware virtual machine on a Sun Fire X4450 Server. Test installation on a new hybrid-blade cluster was done.

### 4.3 FX Correlator Design

The design of a new FX software correlator intended for the new small antenna VLBI network was started in 2012. The correlator design is supposed to process data streams of up to 16 Gb/s from each observatory. VLBI data are recorded from four frequency bands with bandwidths of up to 1024 MHz in one circular polarization or up to 512 MHz in two linear polarizations using 2-bit sampling. The input data format is VDIF. The correlator computes cross-spectra with a resolution of up to 4,096 spectral channels and extracts up to 32 phase calibration tones in each frequency band of each station.

In 2013, we elaborated the correlator's structure and developed the two-station software prototype. "T-Platforms" company developed and mounted the high-performance computing cluster at IAA (Figure 2). The software was installed and successfully tested and benchmarked.

The main conception of the correlator comes from the DiFX correlator, although it has several distinctive features. The most significant one is the usage of graphical processing units (GPUs) for the main computations such as bit repacking, Fourier transformation, doppler tracking, spectra multiplication, and phase calibration extraction.

The correlator equipment includes a data transfer system based on fiber optic cable, power supply, conditioning system, and high performance compute cluster. The correlator's hardware is based on hybrid blade server technology. Each blade server contains two Intel CPUs and two Nvidia Tesla GPUs. The present hardware of the one-baseline correlator's prototype contains five blade servers made by "T-Platforms" company, which are inserted into chassis. The cluster also includes power supply and power distribution units, two cache servers, one head server, data storage with capacity of 20 TB, an infiniband data commutator and a fiber optic commutator. The cluster's components are mounted in a cabinet.



**Fig. 2** View of the high-performance computing cluster based on the hybrid blade servers.

The correlator's topology consists of head, station, and correlation software modules. The head module controls all interblock processes and collects the results. Each station module processes data stream from one station and provides phase calibration signal extraction, data synchronization, delay tracking, and bit repacking. Each correlation module provides cross- and autocorrelation spectra computing for all the stations.

Pcal extraction is realized using the method proposed by S. Pogrebenko. According to this method, data are shifted by the offset frequency, so the phase tones are in the equidistant frequency spacing. The

shifted data are divided into frames with a size of doubled pcal tones, and then all the frames are summed. As a result, white noise from the cosmic data is averaged to zero, and only the phase tone information remains. Then the FFT should be accomplished to get the pcal data.

The cross-spectra computing algorithm is realized in the following way. The received data blocks from the station modules are copied to the GPU's DRAM, where unpacking of bits to single-precision numbers and the fringe rotation are done. Then the FFT operation is completed, and finally the obtained data are transferred to the spectra multipliers kernel, where they are multiplied together and averaged within the chosen time period. The output spectra are transferred to the head module.

For six stations with data streams of 16 Gbps, these algorithms require 76 Fermi GPUs for near real-time processing.

## 5 Future Plans

The next two years will be devoted to development of the cluster and software for the near-real time six station correlator. "T-Platforms" company will have developed and mounted a high-performance computing cluster which will contain 40 blade servers by June, 2014.

# Correlation Processing in NICT Kashima

Mamoru Sekido, Kazuhiro Takefuji, Masanori Tsutsumi

**Abstract** Correlation processing of VLBI observation data has been performed by two sorts of software correlation systems in NICT. One is the multi-channel ‘K5/VSSP software correlator’, and the other one is the fast wideband correlator called ‘GICO3’. These correlators are used for processing of VLBI observations conducted for R&D experiments. This paper reports the activities of the correlation center in NICT.

## 1 General Information

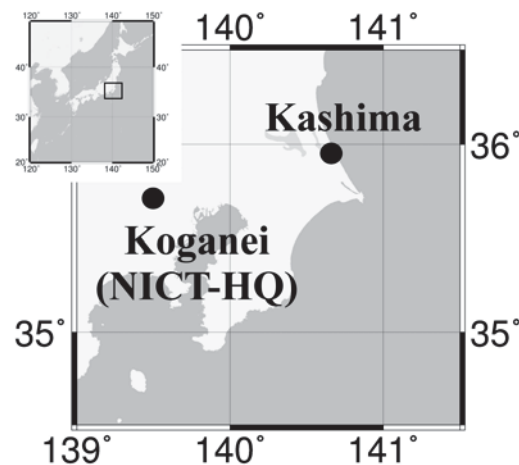
Software correlator has become popular at recent VLBI correlation centers. This trend was driven by the rapid increase of processing capabilities of computer technologies and the increase of hard disk drive capacity. VLBI group of NICT Kashima has played the leading role in the development of operational software correlator from early 2000 [1, 2]. VLBI group of Space-Time Standard Laboratory (STSL) of the National Institute of Information and Communications Technology (NICT) has been working on VLBI technology development in collaboration with domestic institutes and universities in the fields of geodesy, astronomy, and space science. The current mission of our group is precise frequency comparison between atomic standards at distant locations. In this development, VLBI experiments have been conducted for research and development (R&D) purposes, and the data have been processed by our own software correlation systems.

NICT Space-Time Standards Laboratory/Kashima Space Technology Center

NICT Correlator

IVS 2013 Annual Report

The correlation system is located in the Kashima Space Technology Center (KSTC), although correlation processing is performed by sharing data with the network file system (NFS) over the local area network (LAN) spanning between the NICT headquarters in Tokyo and KSTC.



**Fig. 1** Location of the NICT-Koganei Headquarters and Kashima.

## 2 Component Description

The correlation system is composed of high performance computer servers and a data recording system with a RAID disk system. They are not always stored in the same racks in the computer room but are located separately and connected via 1000BASE-T network.

## 2.1 K5/VSSP Correlator

Conventional 16 channel geodetic VLBI observation data is processed with the K5/VSSP software correlator, which was developed by T. Kondo [1]. A typical processing time for 256-Mbps (32-Mbps x 16-channels) observations for the correlation of one baseline takes about two times the real observation scan lengths when 16 cores of the servers A and B in Table 1 are used.

**Table 1** CPU Servers used for correlation processing.

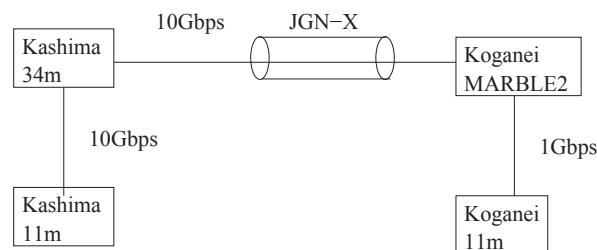
Servers	CPU type and Core	CPU clock	Memory Size
A	Intel Corei7 8 cores	3.0 GHz	16 GBytes
B	Intel Corei7 8 cores	1.6 GHz	12 GBytes
C	Xeon E5-2680 40 cores	1.2 GHz	66 GBytes
D	Intel Corei7-3960X 12 cores	1.2GHz	66 GBytes

## 2.2 GICO3 Correlator

Fast wideband correlation software written by M. Kimura [3] has been used with Giga-bit data acquisition system (ADS1000, ADS3000/ADS3000+). The data acquired at 512-MHz or 1024-MHz bandwidth (1024-Msps or 2048-Msps x 1 or 2-bit sampling = 1024-Mbps or 2048-Mbps) are processed with GICO3. Correlation processing has been performed with servers C and D in Table 1. The processing time for 2-Gbps mode (2048-Msps x 1-bit x 2-ch) for one baseline (Kashima 34-m - Koganei 11-m) takes approximately five times the real data acquisition rate at present. Its rate is thought to be limited by the 1-Gbps network speed at the Koganei 11-m station.

## 2.3 Network Connection

The Kashima 34-m antenna site and the Kashima 11-m station are connected via 10 Gbps LAN. The network speed between the Kashima site and the Koganei 11-m is currently 1 Gbps (Figure 2), but this will be upgraded to 10 Gbps soon. The 10 Gbps network connection between KSTC and the NICT Koganei headquarters is supported by research network JGN-X (Next Genera-



**Fig. 2** Network speed between the Kashima and Koganei sites.

tion Network Test bed). For correlation processing of the Kashima — Koganei baseline, the observation data are not transferred before processing but are shared via network file system (NFS) over the LAN. Therefore, data processing can be started just after the observation. That is useful for a quick fringe check and a performance test.

## 3 Staff

Tsutsumi Masanori: In charge of maintenance of data processing servers and data acquisition RAID systems.

Takefuji Kazuhiro: Uses GICO3 correlator for R&D VLBI experiments.

Sekido Mamoru: Uses K5/VSSP correlator for conventional VLBI observations and is in charge of overall activities.

## 4 Current Status and Activities

The VLBI group of NICT Kashima has been conducting R&D VLBI observations for technology development. The current mission of our group is development of a wideband VLBI observation system (named Gala-V) for precise frequency comparison between newly developed atomic standards. The Gala-V system employs similar radio frequency coverage (3-14 GHz) with VGOS but acquires data of four 1 GHz bandwidth signals. Currently, R&D observing for the Gala-V project has been performed with a single channel in 2013, and that data processing was performed with the GICO3 software correlator.



**Fig. 3** Servers used for corelation processing.

2. Hiro Osaki, Tetsuro Kondo, and Moritaka Kimura, 'Development of Versatile Scientific Sampling Processor (VSSP)-A Practical Approach', IVS CRL-TDC News, No.20, pp.7-9, 2002.
3. M. Kimura, and J. Nakajima, 'The implementation of the PC based Giga bit VLBI system', IVS CRL-TDC News No.21, pp.31-33, 2002.

## 5 Future Plans

The VLBI correlator NICT used was for R&D experiments conducted by NICT. Following the progress of the Gala-V project, the load for data processing will increase. Therefore, increasing processing capacity and more systematic configuration of the system are to be considered.

## Acknowledgements

We thank the research network JGN-X and the Information System Section of NICT for supporting the network environment for e-VLBI.

## References

1. T. Kondo, et al., 'Development of the new real-time VLBI technique using the Internet Protocol', IVS CRL-TDC News No. 17, pp.22-24, 2000.

# Shanghai VLBI Correlator 2013 Annual Report

Fengchun Shu, Weimin Zheng, Wu Jiang, Zhong Chen, Renjie Zhu

**Abstract** This report summarizes the activities of the Shanghai VLBI Correlator during 2013. We have improved the delay model accuracy and real time processing capability. We also managed to develop an offline software function to convert the correlator output into FITS-IDI format. Furthermore, we obtained some experience in operating an ad hoc DiFX correlator and HOPS software.

## 1 Introduction

The Shanghai VLBI Correlator is hosted and operated by the Shanghai Astronomical Observatory, Chinese Academy of Sciences. It is dedicated to the data processing of the Chinese domestic VLBI observing programs, inclusive of the CMONOC project for monitoring the Chinese regional crustal movement, and the Chinese deep space exploration project for spacecraft tracking.

As shown in Figure 1, the VLBI stations near Shanghai, Kunming, and Urumqi participate in some domestic geodetic sessions on an annual basis, while the Beijing station is mainly used for spacecraft data downlink and VLBI tracking. In 2013, we began to process the VLBI data from the Shanghai 65-m antenna, namely the Tianma Radio Telescope. A few fringe tests with Chinese deep space stations Kashi and Jiamus were also performed.

Shanghai Astronomical Observatory

Shanghai Correlator

IVS 2013 Annual Report



Fig. 1 Distribution of the VLBI stations in China.

## 2 Component Description

Based on the FX type VLBA correlator, we have been designing two correlators since 2003. One is the hardware correlator using the FPGA technology. The other one is the software correlator. The first version of our software correlator has been operational since 2006 and was installed on AMD Opteron 2200 CPU computers and later on Intel X5400 CPU computers. Because the software correlator was much easier to modify, we adopted the second version of the software correlator for geodetic applications. By using Message Passing Interface (MPI) and the POSIX threads APIs, the software correlator was migrated to a computer cluster based on blade servers to get better performance since 2010. It was formally accepted as an IVS correlator in March 2012.

In 2013, the Shanghai VLBI data processing center was moved to the Sheshan area, just a few kilometers from Tianma65 and Seshan25. A new hardware plat-

form was installed at the new VLBI center. Features of the software correlator cluster are listed below.

- DELL M1000e Blade Server with 32 computing nodes
- Computing node configuration: a two-socket Intel E5-2640 CPU (2.5 GHz, six cores) with 24 GB of memory
- Five I/O nodes with 264 TB raw storage capacity
- Two redundant administration nodes with BCM cluster management software
- 40 G Infiniband for blade internal computing network connection
- 10 G Ethernet for blade internal and external data network connection

A summary of the capabilities of the software correlator is presented in Table 1.

### 3 Staff

The people involved in the development and operation of the Shanghai Correlator are listed below.

- Weimin Zheng: group head, software correlator development
- Xiuzhong Zhang: CDAS and other technique development
- Fengchun Shu: scheduler, experiment oversight, CDAS evaluation
- Zhong Chen: e-VLBI, cluster administration
- Weihua Wang: lead correlator operator, automatic correlation process development
- Juan Zhang: correlator software development and maintenance
- Yun Yu: operator, experiment support
- Wu Jiang: operator, experiment support
- Wenbin Wang: media library, computer services
- Renjie Zhu: CDAS development
- Zhijun Xu: FPGA programming, hardware correlator development
- Yajun Wu: FPGA programming
- Li Tong: postdoctor, correlator software development and maintenance

## 4 Summary of Activities

### 4.1 Correlator Software

In order to improve the accuracy of differential VLBI observations to the level of better than 0.1 ns, we have incorporated more corrections such as tidal station motion and gravitational delay in the correlator model. We compared the time series of geometric delays with those calculated by VieVS and DiFX-Calc. Our software results agree with DiFX-Calc at the level of 50 ps and agree with VieVS better than 15 ps.

Great effort was made to shorten the data latency for the navigation of spacecraft. For the navigation of the Chang'E-3 lunar mission, we have improved the realtime ability, and the total data turnaround time can be shorter than one minute.

We also managed to develop an offline software function to convert the correlator output into FITS-IDI format. Thus we can make a comparison of correlation results between our own correlator and DiFX in AIPS. The average fringe phase difference for a two-minute scan is about 0.1 degree.

### 4.2 Development of Hardware Correlator

We have built a new hardware correlator which has performed well for the Chang'E-3 lunar mission. The hardware correlator can perform real time correlation at 128 Mbps per station. It includes five FPGA boards. Each board has the same hardware, one Xilinx Virtex-4 FX60 and four LX160 FPGAs. A new hardware correlator based on Uniboard was also under design. It can perform real time correlation at 2 Gbps per station for a maximum of eight stations.

### 4.3 Performance of CDAS

The Chinese VLBI Data Acquisition System (CDAS) is a type of digital backend designed to replace the traditional analog BBCs. The new digital system has better bandpass and wider bandwidth. In order to demonstrate the capability of CDAS, we used 1 Gbps (16 x 32 MHz, 1bit sampling, S/X) recording mode and de-

**Table 1** Correlator capabilities.

Number available	5 Mark 5B
Playback speed	1.8 Gbps
Input data formats	Mark 5B
Sampling	1 bit, 2 bits
IF channels	≤ 16
Bandwidth/channel	(2, 4, 6, 8, 32) MHz
Spectral points/channel	≤ 65536
Geometric model	supports plane wave front and curved wave front
online averaging time	0.1s~4s
Phase Cal extraction	yes
Output	CVN matrix format, FITS-IDI format, or NGS card file

tected 18 weak sources at the level of 0.1 Jy with the VLBI method for the first time.

In addition to the DDC version currently being used, we are also developing a PFB version of CDAS with much more compact design. It contains two Xilinx K7 FPGAs for data processing. The input signals are from two IFs with 512 MHz bandwidth each or one IF with 1024 MHz bandwidth. Comparing with the previous platform which consists of four Xilinx V4 FPGAs, the new one not only updated the key chips for DSP but also added two TenGiga Ethernet SFP+ ports for data transmission. For the application, the PFB version can be configured with 32 MHz bandwidth x 16 channels and 64 MHz bandwidth x 16 channels.

#### 4.4 e-VLBI

The data link between the Shanghai VLBI center, Seshan25, and Tianma65 was upgraded to 10 Gbps. The data link to other stations is 155 Mbps for domestic e-VLBI observations. In the Chang'E-3 lunar mission, the data transfer performed well at 64 Mbps for each station.

#### 4.5 DiFX Operation

We installed the DiFX 2.1 in an ad hoc 36 Intel X5650 (2.67 GHz) core cluster. With the help of the Bonn correlator and the GSFC group, we have obtained some experience in using DiFX, HOPS, and DBedit to generate FITS-IDI data and Mark IV database files.

#### 4.6 Experiments Correlated

In 2013, four domestic geodetic VLBI experiments were carried out using 16 channels allocated at S/X band, three experiments recorded at a data rate of 256 Mbps, and one at 1024 Mbps with a 32 MHz bandwidth in each channel. After the Mark 5 modules were shipped to the Shanghai VLBI center, the data correlations were done by both the domestic correlator and the DiFX correlator. The output of the DiFX correlator was further processed with HOPS. Meanwhile, two milli-second pulsar astrometric observations with the Chinese VLBI network were successfully correlated with the DiFX correlator.

The differential VLBI observations continued to support the navigation of the Chang'E-3 spacecraft from the trans-lunar orbit to soft landing on the moon. The DOR (Differential One-way Range) signals transmitted from the spacecraft were received and processed. Data processing was performed largely in e-VLBI mode. The post-fit RMS delay residuals of orbit determination were as good as 0.5 ns.

#### 5 Future Plans

We will continue to support the data correlation of Chinese domestic VLBI observations and make comparisons of correlation results between our own correlator and DiFX at different levels of data products. A hardware platform dedicated to DiFX correlation will be installed to meet the requirements of more astronomical VLBI experiments and VGOS technique development in China. We will also make some efforts to provide service for international VLBI experiments.



# Tsukuba VLBI Correlator

Shinobu Kurihara <sup>1</sup>, Tetsuya Hara <sup>1,2</sup>

**Abstract** This report summarizes the activities of the Tsukuba VLBI Correlator during 2013. The weekend IVS Intensive (INT2) and the Japanese domestic VLBI observations (JADE) were regularly processed using the K5/VSSP correlation software.

## 1 Introduction

The Tsukuba VLBI Correlator, located in Tsukuba, Japan, is hosted and operated by the Geospatial Information Authority of Japan (GSI). It is fully devoted to processing geodetic VLBI observations of the International VLBI Service for Geodesy and Astrometry. All of the weekend IVS Intensive (INT2) for UT1-UTC (= dUT1) determination and the Japanese domestic VLBI observations for geodesy called JADE organized by GSI were processed at the Tsukuba VLBI Correlator. The K5/VSSP correlation software developed by the National Institute of Information and Communications Technology (NICT) is used for all processing.

---

1. Geospatial Information Authority of Japan

2. Advanced Engineering Service Co., Ltd.

Tsukuba VLBI Correlator

IVS 2013 Annual Report

## 2 Component Description

### 2.1 e-VLBI

The Tsukuba VLBI Correlator has been connected to a broadband network, and most of observed VLBI data is delivered via the network. The Tsukuba VLBI Correlator has a 10 Gbps dedicated link to the SINET4 operated by the National Institute of Informatics (NII), which is connected to some research networks in the world such as Internet2 in the U.S., GÉANT2 in Europe, and TEIN4 at Singapore. It enabled us to transfer massive amounts of data between the Tsukuba VLBI Correlator and the overseas IVS Components. The ultra-rapid EOP experiment (see Section 4.3) is also performed by this network.

### 2.2 K5/VSSP Correlation Software

The K5/VSSP correlation software consists of several programs for the calculation of a priori values of delay and delay rate (*apri\_calc*), for the correlation processing for all observations (*fx\_cor* or *cor*), and for monitoring the results of the correlation processing by performing a so-called “coarse search” (*sdelay*), following several utilities [1]. *Komb* is a bandwidth synthesis software that was developed on an HP-1000 series minicomputer by using the FORTRAN program language when the K-3 VLBI system was being developed. It has been ported to a Linux operating system by using the C language. All these programs were developed and have been maintained by NICT. The K5/VSSP correlation software can be used not only for



**Fig. 1** Processing servers and Lustr File System at the Tsukuba VLBI Correlator.

K5 data processing but also for the Mark 5 data processing by using the data format conversion program (*m5tok5*).

The following are processes of the K5 correlation and programs used in each process.

1. Transferring data from network stations to the correlator (*tsunami* and *tsunamid*).
2. Data format conversion from Mark 5 to K5 (*m5tok5* or *m5btok5*).
3. Preparation of a priori parameter files (*apri\_calc*).
4. Fringe search to find a clock offset at each pair of stations (*fx\_cor* or *cor*).
5. Running correlation processing for all observations (*fx\_cor* or *cor*).
6. Coarse search for estimating residual delay and delay rate, and plotting them on a 3-D diagram (*sdelay*).
7. Bandwidth synthesis to derive a multi-band delay (*komb*), and making Mark III databases by *MK3TOOLS* to be submitted to the IVS Data Center.

We developed several management programs to run the above processes consecutively and ultra-rapidly.

The program for the management of data transfer *rapid\_transfer* accesses the hosts in observing stations, executes *tsunamid* there, and then at the correlator side, executes *tsunami* to transfer data automatically when an observation starts. The data is converted from Mark 5 to K5 format by a program *rapid\_conv* as necessary. *Rapid\_cor* is a program to search for fringes of each baseline according to the clock information of each station written in the FS log. Once the fringe is detected, the main correlation processing is run sequentially with the clock offset and rate found in the fringe search until the last observation. *Rapid\_komb* executes *komb* one after another for bandwidth synthesis process. The fully automated VLBI analysis software *c5++* developed by NICT can read the *komb* output files directly and derives a VLBI solution [2].

### 2.3 Correlator Hardware Capabilities

The hardware supporting the activities of the Tsukuba VLBI Correlator is summarized in Table 1. All these pieces of equipment are general purpose and commer-



**Fig. 2** New high performance servers and storage at the Tsukuba VLBI Correlator.

cially available products (Figure 1). It means that no dedicated hardware is required in the K5 correlation processing. In the correlator, mass data storage is required. Moreover, since some executed correlation processes access a data file simultaneously, the processing capability of correlator depends on the Read I/O of the data storage. The Lustre File System enables us to use numerous HDDs mounted on a lot of servers like one partition as if it were a large virtual disk. Thus, the I/O performance is dramatically improved compared with NFS.

Additionally, a set of high performance servers and huge storage was newly installed (Figure 2). The new system was originally purchased for the new VGOS station Ishioka, but it can be used for operational correlation processing too. The specification of the new system is also shown in Table 1. The new system can shorten the time of correlation processing.

### 3 Staff

The technical staff at the Tsukuba VLBI Correlator are

- **Shinobu Kurihara** — correlator/analysis chief, management.
- **Tetsuya Hara (AES)** — correlator/analysis operator, software development.

## 4 Correlator Operations

### 4.1 *IVS Intensive for UT1-UTC*

In 2013, 72 Intensive sessions in total were processed at the Tsukuba Correlator. The details are described in Table 2. In April, because the Kokee Park station antenna was repaired, the Intensives on weekdays were done as INT2 sessions with the Tsukuba—Wettzell baseline and processed at the Tsukuba Correlator. Just after that, we found that there was a fatal flaw in the pedestal of the track of the Tsukuba antenna. Since then all Intensive sessions that included the Tsukuba station were canceled, and Kokee was substituted for Tsukuba in the Intensives on Sunday. Wettzell, Ny-

**Table 1** Correlator Hardware Capabilities.

	Current system	New System
Number of servers	43 - 16 for correlation processing - 1 for controlling correlation processing - 26 for data storage	18 - 16 for correlation processing - 2 for controlling correlation processing
Operating System	CentOS version 5.3, 5.4 or 5.5	Red Hat Enterprise Linux 6.3
CPU	Intel Xeon X3360 @2.83 GHz quad CPU Intel Xeon 5160 @3.00 GHz dual CPU x 2 Intel Xeon X3480 @3.07 GHz quad CPU Intel Xeon @3.80 GHz CPU x 2	Intel Xeon X5687 @3.60GHz quad CPU x 2
Total storage capacity	Lustre File System: 24.9 Tbytes	Data Direct Networks storage: 513 Tbytes
Network	10 Gbps dedicated line connected to SINET4 by NII	

Ålesund, and Svetloe made a baseline with Kokee alternatively.

The observed data at Wettzell is transferred to the Tsukuba Correlator in real-time with the VDIF/SUDP protocol and is recorded on a data storage device in the K5 format directly. The observed data at the Tsukuba station is also transferred to the correlator immediately. Since the whole process from data transfer through analysis is implemented by the *rapid\_* programs (see Section 2.2), a dUT1 solution of the Tsukuba—Wettzell baseline can be derived within a few minutes after the end of the last scan of the session. In the case of the Kokee baselines, because the observed data at Kokee was transferred via the U.S. Naval Observatory (USNO), it took a few hours to derive a solution.

**Table 2** Intensive sessions processed at Tsukuba Correlator.

	Baseline	Period	# of sessions
Intensive 1	TsWz	Apr 22 – Apr 30	7
Intensive 2	TsWz	Jan 05 – Apr 28	34
	KkWz	May 12 – Jul 07 Oct 06 – Dec 29	19
	KkNy	Jul 14 – Jul 28 Aug 25 – Sep 29	9
	KkSv	Aug 04 – Aug 18	3
Total			72

## 4.2 JADE

JADE is the domestic geodetic VLBI series involving four GSI stations (Tsukuba, Aira, Chichijima, and

Shintotsukawa), three NICT stations (Kashima 34-m, Kashima 11-m, and Koganei 11-m), and two VERA stations of the National Astronomical Observatory of Japan (NAOJ) located in Mizusawa and Ishigakijima. Nine JADE sessions were correlated in 2013.

## 4.3 Ultra-Rapid EOP Experiment

This experiment is the joint project with Sweden, Australia, and South Africa having been continued since 2007. Several ultra-rapid EOP experiments were implemented and processed at Tsukuba Correlator. For details refer to the report “Tsukuba VLBI Analysis Center” in this volume.

## 5 Outlook

We will continue to process the IVS Intensive and JADE correlation. For more stable operation, we will make further improvements to the *rapid\_* programs and start to use the new high performance servers and storage for our routine processing.

## References

1. Kondo, T., et al.: Development of the K5/VSSP System, *Journal of the Geodetic Society of Japan*, **54**(4), 233-248, 2008.
2. Hobiger, T., et al.: Fully automated VLBI analysis with c5++ for ultra-rapid determination of UT1, *Earth Planets Space*, **62**, 933-937, 2010.

# Washington Correlator

David M Hall, Daniel Veillette

**Abstract** This report summarizes the activities of the Washington Correlator for 2013. The Washington Correlator provides up to 80 hours of attended processing per week plus up to 40 hours of unattended operation, primarily supporting Earth Orientation and astrometric observations. In 2013, the major programs supported included the IVS-R4, IVS-INT01, APSG, and CRF observing sessions.

## 1 General Information

The Washington Correlator (WACO) is located at and staffed by the U.S. Naval Observatory (USNO) in Washington, DC, USA. The correlator is sponsored and funded by the National Earth Orientation Service (NEOS), which is a joint effort of the USNO and NASA. Dedicated to processing geodetic and astrometric VLBI observations, the facility spent 100 percent of its time on these sessions. All of the weekly IVS-R4 sessions, all of the IVS-INT01 Intensives, and the APSG and CRF sessions were processed at WACO. The facility houses a Mark IV Correlator and the WACO DiFX correlator.

---

U. S. Naval Observatory

WACO Correlator

IVS 2013 Annual Report

## 2 Activities during the Past Year

The Washington Correlator continues to operate 80 hours per week with an operator on duty. The correlator has continued to function well unattended, allowing another 40 hours per week, on average, of extra processing.

The correlator staff continues the testing and repair of Mark 5 modules.

Intensive observations from Kokee Park and Wettzell were routinely transferred via e-VLBI during 2013. 24-hour sessions from both Hobart antennas, Katherine, Yarragadee, Warkworth, Ny-Ålesund, Fortaleza, Yebes, Noto, HartRAO, Wettzell, Tsukuba, Aira, Kashima, Chichijima, and Sintotu were also transferred by high-speed networks.

The USNO's high speed Internet capability was upgraded to a full 1 GB/s in 2013.

Table 1 lists the experiments processed during 2013.

**Table 1** Experiments processed during 2013.

Number of Sessions	Type
49	IVS-R4 sessions
12	CRF (Celestial Reference Frame)
4	APSG
2	AUST
228	Intensives

### 3 Staff

The Washington Correlator is under the management and scientific direction of the Earth Orientation Department of the U.S. Naval Observatory.

**Table 2** Staff.

<b>Staff</b>	<b>Duties</b>
David Hall	Chief VLBI Operations Division and Correlator Project Scientist
Daniel Veillette	VLBI Correlator Project Manager
Bruce Thornton	Lead Physical Science Technician
Roxanne Inniss	Media Librarian
Maria Davis	Physical Science Technician

### 4 Future Plans

Transition to the DiFX Software correlator began near the end of 2013 and should be completed by mid-2014.

# Data Centers







# BKG Data Center

Volkmar Thorandt, Reiner Wojdziak

**Abstract** This report summarizes the activities and background information of the IVS Data Center for the year 2013. Included are information about functions, structure, technical equipment, and staff members of the BKG Data Center.

## 1 BKG Data Center Functions

The BKG (Federal Agency for Cartography and Geodesy) Data Center is one of the three IVS Primary Data Centers. It archives all VLBI related data of IVS components and provides public access for the community. The BKG Data Center is connected to the OPAR and GSFC CDDIS Data Centers by mirroring the OPAR and the CDDIS file stocks several times per day. The sketch in Figure 1 shows the principle of mirroring:

IVS components can choose one of these Data Centers to put their data into the IVS network by using its incoming area, which each Data Center has at its disposal. The BKG incoming area is protected, and users need to obtain a username and password to get access.

An incoming script watches the incoming area and checks the syntax of the files sent by IVS components. If it is okay, the script moves the files into the Data Center directories. Otherwise the files will be sent to a badfile area. Furthermore, the incoming script informs the responsible staff at the Data Center by sending e-mails about its activities. The incoming script is part

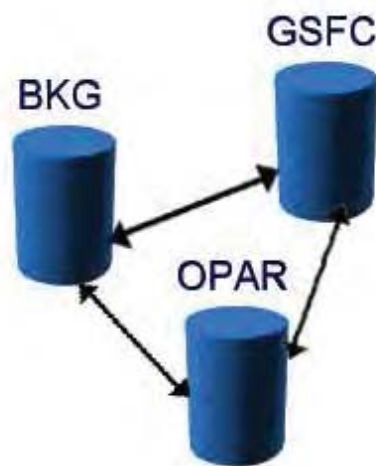


Fig. 1 Principle of mirroring.

of the technological unit which is responsible for managing the IVS and the Operational Data Center, and for carrying out the first analysis steps in an automatic manner. All activities are monitored to guarantee data consistency and to control all analysis steps from data arrival to delivery of analysis products to IVS.

Public access to the BKG Data Center is available through FTP and HTTP:

`ftp://ivs.bkg.bund.de/pub/vlbi/`

`http://ivs.bkg.bund.de/vlbi/`

BKG

BKG Data Center

IVS 2013 Annual Report

Structure of BKG IVS Data Center:

```
vlbi/           : root directory
ivs-special/    : special CRF investigations
ivscontrol/     : controlfiles for the data center
ivsdata/        : VLBI observation files
ivsdocuments/   : IVS documents
ivs-iers/       : old IERS solutions
ivsproducts/    : analysis products
  crf/          : celestial frames
  trf/          : terrestrial frames
  eops/         : earth orientation (24h sessions)
  eopi/         : earth orientation (Intensive sessions)
  daily_sinex/  : daily sinex files (24h sessions)
  int_sinex/    : daily sinex files (Intensive sessions)
  trop/         : troposphere
```

## 2 Technical Equipment

The BKG IVS Data Center is based on a DELL Server (SUSE Linux operating system), disk space of 500 GBytes (Raid system), and a backup system operated by an automatic tape library.

## 3 Staff Members

Volkmar Thorandt (coordination, data analysis, data center, volkmar.thorandt@bkg.bund.de)

Reiner Wojdziak (data center, Web design, reiner.wojdzia@bkg.bund.de)

Dieter Ullrich (data analysis, data center, dieter.ullrich@bkg.bund.de)

Gerald Engelhardt (data analysis, gerald.engelhardt@bkg.bund.de)

# CDDIS Data Center Summary for the IVS 2013 Annual Report

Carey Noll

**Abstract** This report summarizes activities during the year 2013 and future plans of the Crustal Dynamics Data Information System (CDDIS) with respect to the International VLBI Service for Geodesy and Astrometry (IVS). Included in this report are background information about the CDDIS, the computer architecture, staff supporting the system, archive contents, and future plans for the CDDIS within the IVS.

## 1 General Information

The Crustal Dynamics Data Information System (CDDIS) has supported the archiving and distribution of Very Long Baseline Interferometry (VLBI) data since its inception in 1982. The CDDIS is a central facility providing users access to data and derived products to facilitate scientific investigation. The CDDIS archive of GNSS (GPS, GLONASS, etc.), laser ranging, VLBI, and DORIS data are stored on-line for remote access. Information about the system is available via the Web at the URL <http://cddis.gsfc.nasa.gov>. In addition to the IVS, the CDDIS actively supports other IAG services including the International GNSS Service (IGS), the International Laser Ranging Service (ILRS), the International DORIS Service (IDS), the International Earth Rotation and Reference Frame Service (IERS), and the Global Geodetic Observing System (GGOS). The current and future plans for the system's support of the IVS are discussed below.

NASA Goddard Space Flight Center

CDDIS Data Center

IVS 2013 Annual Report

## 2 System Description

The CDDIS archive of VLBI data and products is accessible to the public through anonymous ftp.

### 2.1 Computer Architecture

The CDDIS is operational on a dedicated server, [cddis.gsfc.nasa.gov](http://cddis.gsfc.nasa.gov). The system has over 32 Tbytes of on-line disk storage; at this time, over 180 Gbytes are devoted to VLBI activities. The CDDIS is located at NASA GSFC and is accessible to users 24 hours per day, seven days per week.

## 3 Archive Content

The CDDIS has supported GSFC VLBI and IVS archiving requirements since 1979.

The IVS Data Center content and structure is shown in Table 1 (a figure illustrating the flow of information, data, and products between the various IVS components was presented in the CDDIS submission to the IVS 2000 Annual Report). In brief, dedicated ftp-only accounts have been established on the CDDIS incoming computer, [cddisin.gsfc.nasa.gov](http://cddisin.gsfc.nasa.gov). Using specified filenames, Operation and Analysis Centers deposit data files and analyzed results to appropriate directories within their ftp-only accounts. Automated archiving routines, developed by GSFC VLBI staff, peruse the directories and move any new data to the appropriate public disk area. These routines migrate the data based on the filename to the appropriate directory

as described in Table 1. Index files in the main sub-directories under `ftp://cddis.gsfc.nasa.gov/pub/vlbi` are updated to reflect data archived in the filesystem. Furthermore, mirroring software was installed on the CDDIS host computer, as well as all other IVS Data Centers, to facilitate equalization of data and product holdings among these Data Centers. At this time, mirroring is performed between the IVS Data Centers located at the CDDIS, the Bundesamt für Kartographie und Geodäsie in Leipzig, and the Observatoire de Paris.

The public file system in Table 1 on the CDDIS computer, accessible via anonymous ftp, consists of a data area, which includes auxiliary files (e.g., experiment schedule information, session logs, etc.) and VLBI data (in both database and NGS card image formats). A products disk area was also established to house analysis products from the individual IVS Analysis Centers as well as the official combined IVS products. A documents disk area contains format, software, and other descriptive files.

#### **4 Data Access**

During 2013, nearly 1,200 distinct hosts accessed the CDDIS on a regular basis to retrieve VLBI related files. These users, which include other IVS Data Centers, successfully downloaded over 158 Gbytes of data and products (1.2 M files) from the CDDIS VLBI archive last year.

#### **5 Future Plans**

The CDDIS staff will continue to work closely with the IVS Coordinating Center staff to ensure that our system is an active and successful participant in the IVS archiving effort.

The CDDIS staff is currently assessing the system hardware architecture and near-term requirements. Plans are to procure new server hardware in mid-2014 to expand on-line storage and ensure system reliability for the next few years.

**Table 1** IVS Data and Product Directory Structure

Directory	Description
Data Directories	
vlbi/ivsdata/db/yyyy	VLBI database files for year yyyy
vlbi/ivsdata/ngs/yyyy	VLBI data files in NGS card image format for year yyyy
vlbi/ivsdata/aux/yyyy/sssss	Auxiliary files for year yyyy and session sssss; these files include: log files, wx files, cable files, schedule files, correlator notes
Product Directories	
vlbi/ivsproducts/crf	CRF solutions
vlbi/ivsproducts/eopi	EOP-I solutions
vlbi/ivsproducts/eops	EOP-S solutions
vlbi/ivsproducts/daily_sinex	Daily SINEX solutions
vlbi/ivsproducts/int_sinex	Intensive SINEX solutions
vlbi/ivsproducts/trf	TRF solutions
vlbi/ivsproducts/trop	Troposphere solutions
Project Directories	
vlbi/ivs-iers	IVS contributions to the IERS
vlbi/ivs-pilotbl	IVS Analysis Center pilot project (baseline)
Other Directories	
vlbi/ivscontrol	IVS control files (master schedule, etc.)
vlbi/ivsdocuments	IVS document files (solution descriptions, etc.)
vlbi/raw	Raw VLBI data
vlbi/dserver	dserver software and incoming files

# Italy INAF Data Center Report

Monia Negusini, Pierguido Sarti

**Abstract** This report summarizes the activities of the Italian INAF VLBI Data Center. Our Data Center is located in Bologna, Italy and belongs to the Institute of Radioastronomy, which is part of the National Institute of Astrophysics.

## 1 Introduction

The main analysis activity and storage is concentrated in Bologna, where we store and analyze single databases, using CALC/SOLVE software.

The IRA started to store geodetic VLBI databases in 1989, but the databases archived in Bologna mostly contain data including European antennas from 1987 onward. In particular most of the databases available here have VLBI data with at least three European stations. However we also store all the databases with the Ny-Ålesund antenna observations. In 2002 we decided to store the complete set of databases available on the IVS Data Centers, although we limited the time span to the observations performed from 1999 onwards. All the databases were processed and saved with the best selection of parameters for the final arc solutions. In order to perform global solutions, we have computed and stored the superfiles for all the databases.

In some cases we have introduced GPS-derived wet delays into the European databases (1998 and 1999 EUROPE experiments, for the time being), as if they were produced by a WVR. These databases are avail-

able and stored with a different code from the original databases. In order to produce these databases, we have modified DBCAL, and this new version is available to external users.

## 2 Computer Availability and Routing Access

To date, the main computer is a Linux workstation, on which Mark 5 Calc/Solve version 10 was installed and to which all VLBI data analysis was migrated. The Internet address of this computer is sarip.ira.inaf.it. Since 2011, a new server with a storage capacity of 5 TB has been available, and, therefore, all experiments performed in the previous years were downloaded and archived, thus completing the catalog. The older experiments will be analyzed in order to perform global long term analysis. At present, the databases are stored in the following directories:

- 1 = /data2/dbase2
- 2 = /geo1/dbase1
- 3 = /geo1/dbase
- 4 = /geo1/dbase3

The superfiles are stored in:

/data1/super1

The list of superfiles is stored in the file /data2/mk5/save\_files/SUPCAT. The username for accessing the databases is geo. The password may be requested by sending an e-mail to negusini@ira.inaf.it.

Istituto di Radioastronomia INAF, Bologna

INAF Data Center

IVS 2013 Annual Report

# Data Center at NICT

Ryuichi Ichikawa<sup>1</sup>, Mamoru Sekido<sup>2</sup>

**Abstract** The Data Center at the National Institute of Information and Communications Technology (NICT) archives and releases the databases and analysis results processed at the Correlation Center and the Analysis Center at NICT. Regular VLBI sessions of the Key Stone Project VLBI Network were the primary objective of the Data Center. These regular sessions continued until the end of November 2001. In addition to the Key Stone Project VLBI sessions, NICT has been conducting geodetic VLBI sessions for various purposes, and these data are also archived and released by the Data Center.

## 1 General Information

The IVS Data Center at National Institute of Information and Communications Technology (NICT) archives and releases the databases and analysis results processed by the Correlation Center and the Analysis Center at NICT. Major parts of the data are from the Key Stone Project (KSP) VLBI sessions [1], but other regional and international VLBI sessions conducted by NICT are also archived and released. Since routine observations of the KSP network terminated at the end of November 2001, there have been no additional data from the KSP regular sessions since 2002.

On March 11th, 2011, the devastating megaquake ( $M_w$  9.0) hit our antennas. The azimuth track and one

azimuth wheel of the Kashima 34 m were damaged as a consequence of the megaquake. The antenna repair was finished in March 2013. On the other hand, the 11-m antennas at Kashima and Koganei were not damaged by the earthquake. We have carried out 20 VLBI experiments using the 11-m antennas including time and frequency transfer experiments, international and domestic geodetic experiments, and astrophysical experiments.

The analysis results in SINEX (Solution INdependent EXchange) format as well as in other formats are available on the WWW server. Database files of non-KSP sessions, i.e. other domestic and international geodetic VLBI sessions, are also available on the WWW server. Table 1 lists the WWW server locations maintained by the NICT Data Center. In the past, an FTP server was used to provide data files, but it was decided to terminate the FTP service because of the security risks of maintaining an anonymous FTP server. Instead, the [www3.nict.go.jp](http://www3.nict.go.jp) WWW server was prepared to provide large size data files.

The responsibility for the maintenance of these server machines was moved from the VLBI research group in 2001 to a common division which handles all institutional network service of the laboratory in order to improve the network security of these systems.

## 2 Activities during the Past Year

### 2.1 KSP VLBI Sessions

The KSP VLBI sessions were performed with four KSP IVS Network Stations at Kashima, Koganei, Miura, and Tateyama on a daily or bi-daily basis

1. National Institute of Information and Communications Technology (NICT)

2. Kashima Space Research Center, NICT

**Table 1** URL of the WWW server systems.

Service	URL
KSP WWW pages	<a href="http://ksp.nict.go.jp/">http://ksp.nict.go.jp/</a>
IVS WWW mirror pages	<a href="http://ivs.nict.go.jp/mirror/">http://ivs.nict.go.jp/mirror/</a>
Database files	<a href="http://www3.nict.go.jp/aeri/sts/stmg/database/">http://www3.nict.go.jp/aeri/sts/stmg/database/</a>
e-VLBI Sessions	<a href="http://www2.nict.go.jp/aeri/sts/stmg/research/e-VLBI/UT1/">http://www2.nict.go.jp/aeri/sts/stmg/research/e-VLBI/UT1/</a>

until May 1999. The high-speed ATM (Asynchronous Transfer Mode) network line to the Miura station became unavailable in May 1999, and real-time VLBI observations with the Miura station became impossible. Thereafter, the real-time VLBI sessions were performed with the three other stations. Once every six days (every third session), the observed data were recorded to the K4 data recorders at three stations, and the Miura station participated in the sessions with the tape-based VLBI technique. In this case, the observed data at the three stations other than the Miura station were processed in real-time, and the analysis results were released promptly after the observations completed. A day later, the observed tapes were transported from the Kashima, Miura, and Tateyama stations to the Koganei station for tape-based correlation processing with all six baselines. After the tape-based correlation processing was completed, the data set produced with the real-time VLBI data processing was replaced by the new data set.

In July 2000, unusual site motion of the Tateyama station was detected from the KSP VLBI data series, and the frequency of the sessions was increased from bi-daily to daily on July 22, 2000. The daily sessions were continued until November 11, 2000, and the site motions of the Tateyama and Miura stations were monitored in detail. During the period, it was found that Tateyama station moved about 5 cm to the northeast direction. The Miura station also moved about 3 cm to the north. The unusual site motions of these two stations gradually settled, and the current site velocities seem to be almost the same as the site velocities before June 2000. The investigation into the time series of the site positions shows that the unusual site motion started sometime between the end of June 2000 and the beginning of July 2000. At the same time, volcanic and seismic activities near the Miyakejima and Kozushima Islands began. These activities are believed to have caused the regional crustal deformation in the area, explaining the unusual site motions at Tateyama and Miura.

## 2.2 Other VLBI Sessions

In recent years, we have carried out time and frequency transfer experiments using VLBI. In addition, domestic and international geodetic and astronomical VLBI sessions were conducted by NICT in cooperation with the Geospatial Information Authority of Japan (GSI), the National Astronomical Observatory (NAO), and other organizations. These sessions are listed in Table 2. The recent observed data of these sessions were mainly processed by the K5 software correlator at NICT either at Koganei or at Kashima or by using a real-time hardware correlator developed by NAO.

## 3 Current Status

The repair of the Kashima 34-m antenna was finished in March 2013, and the antenna participated in various experiments until now.

## 4 Future Plans

The IVS Data Center at NICT will continue its service and will archive and release the analysis results accumulated by the Correlation Center and the Analysis Center at NICT. In addition, a number of VLBI sessions will be conducted for the purposes of various technology developments.

## References

1. Special issue for the Key Stone Project, J. Commun. Res. Lab., Vol. 46, No. 1, March 1999.



**Table 2** VLBI sessions conducted by NICT (since 2005). In 2012, all experiments were carried out using the 11-m antennas at Kashima and Koganei since the 34-m antenna was under repair to recover from the earthquake damage. At the end of March 2013, the repair of the 34-m antenna was finished.

Year	exp. names	sessions
2005	Geodetic	c0505 (CONT05, partial participation), GEX13
	Hayabusa	14 sessions
2006	Geodetic	GEX14, viepr2, CARAVAN (three sessions)
	Spacecraft	Geotail: one session
	Pulsar	one session
2007	Ultra Rapid e-VLBI	15 times, 29 sessions
	Time Transfer	four sessions, 12 days in total
	Cs-Gas-Cell	one session
	Spacecraft	Hayabusa: one session
2008	Ultra Rapid e-VLBI	eight times, 33 sessions
	Time Transfer	26 sessions
	Variable Star e-VLBI	31 sessions
2009	e-VLBI	15 sessions, 90.5 hours in total
	IVS	12 sessions, 332 hours in total
	Time Transfer	nine sessions, 72 hours in total
	VERA	16 sessions, 149 hours in total
	Survey	26 sessions, 276 hours in total
2010	IVS	38 sessions, 442 hours in total
	Radio astronomy	34 sessions, 324 hours in total
	Spacecraft (IKAROS, UNITEC-1, QZSS)	33 sessions, 259 hours in total
	Domestic geodetic	13 sessions, 94 hours in total
	Time Transfer	nine sessions, 86 hours in total
	e-VLBI	nine sessions, 27 hours in total
2011	IVS	two sessions, 48 hours in total
	Radio astronomy	100 hours in total
	earthquake damage investigation	216 hours in total
2012	IVS	nine sessions, 216 hours in total
	Radio astronomy (Sgr-A*)	13 sessions, 28 hours in total
	Domestic geodetic	three sessions, 72 hours in total
	International fringe test (New Zealand and Korea)	two sessions, 16 hours in total
	International geodetic (New Zealand)	one session, 24 hours in total
	Time transfer	11 sessions, 264 hours in total
2013	IVS	five sessions, 120 hours in total
	Radio astronomy (including Sgr-A* obs.)	71 sessions, 266 hours in total
	Domestic geodetic	14 sessions, 213 hours in total
	Time transfer	two sessions, 46 hours in total
	International fringe test (New Zealand and Korea)	two sessions, 16 hours in total
	Pulsar	39 session, 274 hours in total

# Paris Observatory (OPAR) Data Center

Christophe Barache, Sebastien Lambert

**Abstract** This report summarizes the OPAR Data Center activities in 2013. Included is information about functions, architecture, status, future plans, and staff members of OPAR data center.

## 1 General Information

The Paris Observatory (OPAR) has provided a Data Center for the International VLBI Service for Geodesy and Astrometry (IVS) since 1999. The OPAR as well as CDDIS and BKG is one of the three IVS primary Data Centers. Their activities are done in close collaboration for collecting files (data and analysis files), and making them available to the community as soon as they are submitted. The three Data Centers have a common protocol and each of them:

- has the same directory structure (with the same control file),
- has the same script,
- is able to receive all IVS files (auxiliary, database, products, and documents),
- mirrors the other ones every three hours, and
- gives free FTP access to the files.

This protocol gives the IVS community a transparent access to a Data Center through the same directory, and a permanent access to files in case of a Data Center breakdown.

---

Observatoire de Paris/SYRTE – CNRS – UMPC – GRGS

OPAR Data Center

IVS 2013 Annual Report

## 2 Architecture

To be able to put a file in a data center, operational and analysis centers have to be registered by the IVS Coordinating Center. The file names have to conform to the name conventions. A script checks the file and puts it in the right directory. The script undergoes permanent improvement and takes into account the IVS components' requests. The structure of the IVS Data Centers is detailed in Table 1.

## 3 Current Status

The OPAR Data Center is operated on a PC server (PowerEdge 2800 - Xeron 3.0 GHz) located at the Paris Observatory and running the Fedora Linux operating system. To make all IVS products available on-line, the disk storage capacity was significantly increased, and the server is equipped now with a RAID 3 TB disk extensible up to 4.7 TB.

The OPAR server is accessible 24 hours a day, seven days per week through Internet connection with 2 Mbit/s rate. Users can get the IVS products by using the FTP protocol. Access to this server is free for users.

---

FTP access: ftp ivsopar.obspm.fr  
username : anonymous  
password : your e-mail  
cd vlbi (IVS directory)

---

This year, the OPAR successfully used the new mirroring method based on lftp. The OPAR Web statis-

**Table 1** Directories of the IVS Data Center.

---

RECENT		used for the new mirroring method
ivscontrol		control files needed by the Data Center (session code, station code, solution code...)
ivsdocuments		documents about IVS products
ivsdata		files related to the observations
	aux	auxiliary files (schedule, log...)
	db	observation files in database CALC format
	ngs	observation files in NGS format
	sinex	observation files in SINEX format
ivsproducts		results from analysis centers
	eopi	Earth orientation parameters, Intensive sessions
	eops	Earth orientation parameters, 24-h sessions
	crf	celestial reference frames
	trf	terrestrial reference frames
	daily_sinex	24-hour time series solutions of Earth orientation and site positions in SINEX FORMAT
	int_sinex	daily Intensive solution in SINEX format, mainly designed for combination
	trop	tropospheric time series (starting July 2003)

---

tics increased in 2013 — about 4,000 different visitors reached the server in 2013. They viewed 33,500 pages and downloaded three Go. The OPAR staff will continue to work with the IVS community and in close collaboration with the two other primary Data Centers in order to provide public access to all VLBI related data. To obtain information about the OPAR Data Center please e-mail [ivs.opa@obspm.fr](mailto:ivs.opa@obspm.fr).



# Analysis Centers





# Analysis Center of Saint Petersburg University

Dmitriy Trofimov, Veniamin Vityazev

**Abstract** This report briefly summarizes the activities of the Analysis Center of Saint Petersburg University during 2013. The current status, as well as our future plans, are described.

## 1 General Information

The Analysis Center of Saint Petersburg University (SPU AC) was established in the Sobolev Astronomical Institute of the SPb University in 1998. The main activity of the SPU AC for the International VLBI Service before 2007 consisted of routine processing of 24-hour and one-hour observational sessions for obtaining Earth Orientation Parameters (EOP) and rapid UT1-UTC values, respectively. In 2008 we began submitting the results of 24-hour session processing.

## 2 Activities during the Past Year

- In 2013, the routine estimation of the five Earth Orientation Parameters was performed. The OCCAM software package (version 6.2) was used for current processing of VLBI data [1]. The time series is named spu00004.eops. It includes data obtained by the IRIS-A, NEOS-A, R1, R4, RDV, and R&D observing programs, and it covers 25 years of observations (from January 2, 1989 until the end of 2013). The total number of experiments processed

at the SPU AC is about 1960, of which about 100 VLBI sessions were processed in 2013. Our experience and the equipment of the Analysis Center was used for giving lectures and practical work on the basics of radio interferometry to university students. We use our original manual on the training in modern astrometry and in particular VLBI [2].

In 2013, the work of the SPU AC was performed within the projects “Acquisition and analysis of time-series in astronomy and study of astronomical catalogs” and “GLONASS, GPS and VLBI observations as the basis of astronomical, gravimetric, and geodynamic studies” (SPU grants for fundamental research 6.0.161.2010 and 6.37.110.2011).

- All parameters were adjusted using the Kalman filter technique. For all stations (except the reference station), the wet delay, clock offsets, clock rates, and troposphere gradients were estimated. Troposphere wet delay and clock offsets were modeled as a stochastic process such as a random walk. The clock rates and the troposphere gradients were considered to be the constant parameters.
- The main details of the preparation of the EOP time series spu00004.eops are summarized below:
  - Data span: 1989.01–2013.12
  - CRF: fixed to ICRF-Ext.2
  - TRF: VTRF2005 was used as an a priori TRF
  - Estimated parameters:
    1. EOP:  $x, y, UT1 - UTC, d\psi, d\epsilon$ ;
    2. Troposphere: troposphere gradients were estimated as constant parameters, and wet troposphere delays were modeled as a random walk process;
    3. Station clocks were treated as follows: offset as a random walk process, rate as a constant.

---

Sobolev Astronomical Institute of Saint Petersburg University

AI SPbU Analysis Center

IVS 2013 Annual Report

- nutation model: IAU 1980
- mapping function: VMF1
- technique: Kalman filter
- software: OCCAM v.6.2

### 3 Current Status

The assistant professor of Saint Petersburg University, Dmitriy Trofimov, was in charge of the routine processing of the VLBI observations. General coordination and support for the activities of the SPU AC at the Astronomical Institute was performed by Professor Veniamin Vityazev.

### 4 Future Plans

In 2014, we are going to continue our regular processing of the VLBI sessions as well as giving lectures and practical training for students in a special course on radio astrometry. This course is a part of the systematic curriculum of astronomical education at SPb University.

### References

1. O. Titov, V. Tesmer, J. Boehm. OCCAM v. 6. 0 Software for VLBI Data Analysis, In International VLBI Service for Geodesy and Astrometry 2004 General Meeting Proceedings, N. R. Vandenberg and K. D. Baver (eds.), NASA/CP-2004-212255, pp. 267-271, 2004.
2. V. Vityazev, I. Guseva, V. Kiyayev, M. Mishchenko, O. Titov, A. Tsvetkov. Celestial and Terrestrial Coordinates (In Russian), Manual on Astrometry, p. 301, SPb University, 2011.



# Geoscience Australia Analysis Center 2013 Annual Report

Oleg Titov

**Abstract** This report gives an overview of the activities of the Geoscience Australia IVS Analysis Center during 2013.

## 1 General Information

The Geoscience Australia (GA) IVS Analysis Center is located in Canberra within the National Geospatial Reference System Section, Mineral and Natural Hazard Division (MNHD).

## 2 Activities during the Past Year

Several celestial reference frame (CRF) solutions have been prepared using the OCCAM 6.2 software. The latest solution was uploaded in September 2013. VLBI data consisting of 4,353 daily sessions from 25-Nov-1979 to 03-September-2013 have been used to compute several global solutions with different sets of reference radio sources. This includes 5,927,370 observational delays from 2,950 radio sources having three or more observations.

Station coordinates were also estimated using No-Net-Rotation (NNR) and No-Net-Translation (NNT) constraints. The long-term time series of the station coordinates have been used to estimate the corresponding velocities for each station. The tectonic motion for the Gilcreek VLBI site after the Denali

earthquake was modeled using an exponential function typical of post-seismic deformation. The tectonic motion of the Tigoconc (2010) and Tsukub32 (2011) VLBI sites after recent strong earthquakes is currently under study.

The adjustment was made by least squares collocation, which considers the clock offsets, wet troposphere delays, and tropospheric gradients as stochastic parameters with a priori covariance functions. The gradient covariance functions were estimated from GPS hourly values.

Our first CRF solution, aus2013a.crf, was not imposed by the NNR constraints. The second CRF solution, aus2013b.crf, was imposed by NNR constraints. This second solution is consistent with the CRF solutions submitted by other Analysis Centers.

In 2013, all three new AuScope 12-meter radio telescopes were actively working in different IVS geodetic and astrometric programs. Two other Australian radio telescopes – Hobart26, operated by the University of Tasmania (UTAS), and Parkes, operated by the Australia Telescope National Facility (ATNF) — participated in the geodetic VLBI programs occasionally.

A program for optical identification and spectroscopy of the reference radio sources continued in collaboration with the Australian Telescope National Facility, University of Sydney and Nordic Optical Telescope. A paper that includes redshifts of 126 reference radio sources has been published.

New observing runs at Gemini North, Gemini South (service mode) and New Telescope Technology (ESO) (visitor mode) were ongoing in 2013.

---

Geoscience Australia

GA Analysis Center

IVS 2013 Annual Report

### **3 Staff Changes**

Dr. Laura Stanford was actively involved in all the programs during the year and left this job in October 2013.

### **Acknowledgements**

This report was published with the permission of the CEO, Geoscience Australia.

# Report for 2013 from the Bordeaux IVS Analysis Center

Patrick Charlot, Antoine Bellanger, Romuald Bouffet, Géraldine Bourda, Arnaud Collioud, Alain Baudry

**Abstract** This report summarizes the activities of the Bordeaux IVS Analysis Center during the year 2013. The work focused on (i) regular analysis of the IVS-R1 and IVS-R4 sessions with the GINS software package, also extending our present solution back to 2002; (ii) systematic VLBI imaging of the RDV sessions and calculation of the corresponding source structure index and compactness values; (iii) investigation of the correlation between astrometric position instabilities and source structure variations; (iv) continuation of our VLBI observational program to identify optically-bright radio sources suitable as transfer sources to align the International Celestial Reference Frame (ICRF) and the future Gaia frame; and (v) assessment of the current IVS observing scheme for those Gaia transfer sources comprised in ICRF2. Also to be mentioned is the organization of a joint workshop with the Korean Space Science Institute and participation in meetings of the Working Group on the next ICRF realization.

## 1 General Information

The *Laboratoire d'Astrophysique de Bordeaux (LAB)*, formerly Bordeaux Observatory, is located in Floirac, near Bordeaux, in the southwest of France. It is funded by the University of Bordeaux and the *Centre National de la Recherche Scientifique (CNRS)*. VLBI activities are primarily developed within the *Métrologie de l'espace, Astrodynamique, Astrophysique (M2A)* team.

---

Laboratoire d'Astrophysique de Bordeaux

Bordeaux Analysis Center

IVS 2013 Annual Report

The contribution of the Bordeaux group to the IVS has been mostly concerned with the maintenance, extension, and improvement of the International Celestial Reference Frame (ICRF). This includes regular imaging of the ICRF sources and evaluation of their astrometric suitability, as well as developing specific VLBI observing programs for enhancing the celestial frame.

In addition, the group is in charge of the VLBI component in the multi-technique GINS software package [1] as part of a collaborative effort within the French *Groupe de Recherches de Géodésie Spatiale (GRGS)* to combine VLBI and space geodetic data (SLR, GPS, and DORIS) at the observation level. This effort also involves institutes in Toulouse, Nice, and Paris.

## 2 Description of Analysis Center

The Bordeaux IVS group routinely analyzes the weekly IVS-R1 and IVS-R4 sessions with the GINS software package. During the past year, weekly normal equations for all such sessions in 2013 (with six-hour EOP resolution) have been produced and integrated in the multi-technique solutions derived by the GRGS. We also worked at extending our solution to the past, analyzing all IVS-R1 and IVS-R4 sessions back to 2002. This extension was motivated by the goal of producing test solutions combining all space geodetic data at the observation level for the upcoming ITRF2013.

The group is also focused on imaging the ICRF sources on a regular basis by systematic analysis of the data from the RDV sessions which are conducted six times a year. This analysis is carried out with the AIPS

and DIFMAP software packages. The aim of such regular imaging is to characterize the astrometric suitability of the sources based on the so-called “structure index” and to compare source structural evolution and positional instabilities. Such studies are essential for identifying sources of high astrometric quality, which is required, i.e., for the future Gaia link.

### 3 Scientific Staff

During the past year, there were no changes in the IVS staff. In all, six individuals contributed to one or more of our IVS analysis and research activities during 2013. A description of what each person worked on, along with the time spent on it, is given below.

- Patrick Charlot (20%): person with overall responsibility for Analysis Center work and data processing. His research interests include the ICRF densification, extension, and link to the Gaia frame, studies of radio source structure effects in astrometric VLBI data, and astrophysical interpretation.
- Antoine Bellanger (100%): engineer with a background in statistics and computer science. He is tasked to process VLBI data with GINS and to develop procedures and analysis tools to automate such processing. He is also the M2A Web master.
- Romuald Bouffet (30%): Ph. D. student from University of Bordeaux whose thesis is focused on the study of the relationship between radio source structure and position instabilities. He is using astrometric data and VLBI images from IVS sessions.
- Géraldine Bourda (50%): astronomer in charge of developing the VLBI part of GINS and responsible for the analysis results derived from GINS. She is also leading a VLBI observational program for linking the ICRF and the future Gaia optical frame.
- Arnaud Collioud (100%): engineer with a background in astronomy and interferometry. His tasks are to image the sources in the RDV sessions using AIPS and DIFMAP, to develop the Bordeaux VLBI Image Database and *IVS Live* tool, and to conduct simulations for the next generation VLBI system.
- Alain Baudry (10%): radioastronomy expert with specific interest in radio source imaging and astrometric VLBI. He is a Professor Emeritus and has a part-time ESO contract to work on the ALMA

phasing for ultra-high resolution millimeter VLBI science.

### 4 Analysis and Research Activities in 2013

As noted above, a major part of our activity consists of imaging the sources observed during the RDV sessions on a systematic basis. During 2013, two such sessions were processed (RDV90 and RDV92), resulting in 347 VLBI images at either X- or S-band for 161 different sources. The imaging work load has been shared with USNO since 2007 (starting with RDV61); the USNO group processes the odd-numbered RDV sessions while the Bordeaux group processes the even-numbered ones. The VLBI images are used in a second stage to derive structure correction maps, and visibility maps along with values for structure indices and source compactness (see [2, 3] for a definition of these quantities) in order to assess astrometric source quality. All such information is made available through the Bordeaux VLBI Image Database (BVID)<sup>1</sup>. At present, the BVID comprises a total of 3,691 VLBI images for 1,126 different sources (with links to an additional 7,851 VLBI images from the Radio Reference Frame Image Database of USNO) along with 11,542 structure correction maps and as many visibility maps.

In addition to such regular imaging, studies aimed at characterizing correlations between astrometric position instabilities and source structural variations were pursued further. Moving from qualitative comparisons, we calculated correlation coefficients between time series of source positions and brightness centroid motions (as derived from the available VLBI images) for our previously selected set of 68 sources. Based on this calculation, an overall positive correlation coefficient was found, indicating that on average source position instabilities and structural variations are linked [4]. However, the comparison also revealed that a fraction of the sources show a negative correlation. Possible explanations for such discrepancies include misidentification of the core components over the epochs in the successive VLBI maps and effects of the S-band data which have not been considered in this work. Further investigations are continuing through a careful exami-

<sup>1</sup> The Bordeaux VLBI Image Database may be accessed at <http://www.obs.u-bordeaux1.fr/BVID>.

nation of every individual source and assessment of the significance of the calculated correlation coefficients.

Another major project carried within the group is the identification and characterization of appropriate radio sources to align the ICRF and the future Gaia optical frame. To this end, two complementary directions are followed: (i) the identification of such sources within ICRF2, and (ii) the search for additional sources (outside of ICRF2) to increase the pool of transfer sources. As noted in our 2012 IVS report, the examination of ICRF2 led to the identification of 195 transfer sources. These were further characterized as 89 sources which are sufficiently observed in current IVS programs (i.e., at least once a month), 62 sources which are not observed well enough in these programs (i.e., less than once a month), 20 sources which have a proper position accuracy but were only occasionally observed, and 24 sources which have a poor position accuracy, requiring further observations and improvement in accuracy to qualify as transfer sources. Following this analysis and previously proposed observations, the IVS has now begun to insert some of these sources into the regular IVS observing programs. The second direction (i.e. searching for new sources) has led to the identification of an additional 119 sources [5], all of which were observed during a dedicated 72-hour astrometric VLBI session conducted with the combined Very Long Baseline Array and European VLBI Network in May 2012. These data are now correlated and are awaiting analysis. Also to be mentioned in this framework is the extension of our work to the southern hemisphere with the submission of a proposal to the Australian Long Baseline Array (supplemented with additional VLBI stations) to characterize potential transfer sources in the south.

Most of this work (source imaging, assessment of structural effects, identification of Gaia transfer sources, etc.) naturally fits within the tasks of the newly formed IAU Working Group on the next ICRF realization which was set up at the 2012 IAU General Assembly. As such, we contributed to the first two meetings of this Working Group, held on 7 March 2013 in Espoo (Finland) and 18 September 2013 in Paris.

## 5 Dissemination and Outreach

A joint VLBI astrometry workshop was organized by the Bordeaux and KASI (Korean Astronomy and Space Science) VLBI groups as part of bilateral agreements between France and Korea. The workshop was held in Bordeaux on 24-25 October 2013. Sessions were devoted to radio interferometry techniques, high-resolution astrometry, radio sources and reference frames, as well as to time and frequency standards. Dissemination activities also included a talk given by P. Charlot at the *Bureau des Longitudes* in Paris on 6 November 2013, highlighting recent VLBI developments and the next generation VLBI system.

The *IVS Live* Web site [6], dedicated to monitoring IVS sessions and viewing VLBI images of the observed sources, was updated on a regular basis during 2013. It now includes 5,825 IVS sessions (with 68 stations participating) and 1,736 sources. Monitoring of the connections indicates that there were 866 visits from around the world (40 countries, 286 locations) during 2013, with 70% originating from different individuals. On the other hand, the Bordeaux VLBI Image Database was accessed from 85 different locations in 33 countries. In all, there were 547 connections, with one-third originating from different individuals.

## 6 Outlook

Our plans for the coming year are focused on moving towards operational analysis of the IVS-R1 and IVS-R4 sessions with the GINS software package. Imaging of the RDV sessions and evaluation of the astrometric suitability of the sources will continue along the same lines. On the observational side, the immediate plan will be to analyze the astrometric data that we acquired on the 119 Gaia transfer sources identified from our program (see Section 4). We also expect the IVS to continue and expand observations of the 195 ICRF2 transfer sources now that Gaia has been launched and is soon to begin operations. In this respect, it would be desirable to schedule VLBI observations that are simultaneous with Gaia so that time series of radio and optical positions can be compared on a detailed basis. Depending on the outcome of our southern hemisphere proposal, observations in the south should also begin to develop. Finally, we expect to contribute to the work

towards the next realization of the ICRF in line with the plans that were set up during the initial meetings of the IAU Working Group in charge of this task.

## Acknowledgements

We would like to thank the *Observatoire Aquitain des Sciences de l'Univers (OASU)* for supporting IVS activities in Bordeaux.

## References

1. Bourda, G., Charlot, P., Biancale, R.: 2007, GINS: A New Tool for VLBI Geodesy and Astrometry, 18th EVGA Working Meeting, Eds. J. Böhm, A. Pany, and H. Schuh, IGG Vienna, p. 59–63.
2. Fey, A. L., Charlot, P.: 1997, VLBA Observations of Radio Reference Frame Sources. II. Astrometric Suitability Based on Observed Structure, *ApJS*, 111, pp.95–142.
3. Charlot, P.: 2008, Astrophysical Stability of Radio Sources and Implication for the Realization of the Next ICRF, 5th IVS General Meeting, St Petersburg, Eds. A. Finkelstein and D. Behrend, p. 345–354.
4. Bouffet, R., Charlot, P., Lambert, S.: 2013, Correlation between source structure evolution and VLBI position instabilities, Proceedings of the 21st Meeting of the European VLBI Group for Geodesy and Astrometry, Eds. N. Zubko and M. Poutanen, Report of the Finnish Geodetic Institute, p. 185–188.
5. Bourda, G., Collioud, A., Charlot, P., Porcas, R., Garrington, S.: 2012, Towards an Accurate Alignment of the VLBI Frame and the Future Gaia Optical Frame: Global VLBI Imaging Observations of a Sample of Candidate Sources for this Alignment, IVS 2012 General Meeting Proceedings, Eds. Dirk Behrend and Karen D. Baver, NASA/CP-2012-217504, p. 334–338.
6. Collioud, A.: 2011, IVS Live: All IVS on your desktop, Proceedings of the 20<sup>th</sup> Meeting of the European VLBI Group for Geodesy and Astronomy, Eds. W. Alef, S. Bernhart, and A. Nothnagel, Universität Bonn, Institut für Geodäsie und Geoinformation, Schriftenreihe 22, p. 14–18.

# BKG/DGFI Combination Center Annual Report 2013

Sabine Bachmann<sup>1</sup>, Michael Lösler<sup>1</sup>, Linda Messerschmitt<sup>1</sup>, Ralf Schmid<sup>2</sup>, Mathis Bloßfeld<sup>2</sup>, Daniela Thaller<sup>1</sup>

**Abstract** This report summarizes the activities of the BKG/DGFI Combination Center in 2013 and outlines the planned activities for 2014. The main focus in 2013 was on the inclusion of source positions in the combination process and the preparation for the IVS contribution to ITRF2013.

## 1 General Information

The BKG/DGFI Combination Center was established in October 2008 as a joint effort of the Federal Agency for Cartography and Geodesy (Bundesamt für Kartographie und Geodäsie, or BKG) and the German Geodetic Research Institute (Deutsches Geodätisches Forschungsinstitut, or DGFI). The participating institutions, as well as the tasks and the structure of the IVS Combination Center, are described in [1]. The tasks comprise quality control and a timely combination of the session-based intermediate results of the IVS Analysis Centers into a final combination product (e.g., Earth orientation parameters, EOP). In coordination with the IVS Analysis Coordinator, the combination results are released as official IVS products. The Combination Center is also expected to contribute to the generation of the official IVS input to any ITRF activities.

---

1. Federal Agency for Cartography and Geodesy (BKG), Frankfurt/Main, Germany

2. German Geodetic Research Institute (DGFI), Munich, Germany

BKG/DGFI Combination Center

IVS 2013 Annual Report

The BKG/DGFI Combination Center performs a combination of session-based results of the IVS Analysis Centers on an operational basis. The strategy for the combination is based on the combination of normal equations and was adopted from the combination process as developed and performed by the IVS Analysis Coordinator (cf. [2], [3]). At BKG, the following tasks are performed:

- Quality control of the Analysis Center results: checking the format of the results and their suitability for combination, identification, and reduction of outliers, comparison of the Analysis Centers' results with each other, and comparison of the results with external time series provided by IERS or IGS.
- Feedback to the Analysis Centers: quality control results are available at the BKG IVS Combination Center Web page [5].
- Generation of high-quality combination products and timely archiving and distribution: combination products are created by using the combination part DOGS-CS of DGFI's software package DOGS (DGFI orbit and geodetic parameter estimation software) [4].
- Submission of official IVS combination products to the IERS: the products are submitted to the responsible IERS components to be used for IERS product generation (e.g., EOP rapid products and the EOP series IERS C04).
- Generation of the official IVS input to the ITRF: the combined session products (from 1984 to present) are submitted for ITRF computation in the form of normal equations in SINEX format. This work is also supported by the staff of the IERS Central Bureau, hosted by BKG.

- Final results are archived in the BKG Data Center and mirrored to the IVS Data Centers at Observatoire de Paris (OPAR) and Goddard Space Flight Center (GSFC). This work is assisted by the staff of the BKG Data Center in Leipzig.

The inclusion of new Analysis Centers has continued, a newly designed Web page was brought online, and the Web-based analysis tools have been enhanced.

DGFI is in charge of the following Combination Center functions:

- DGFI is developing state-of-the-art combination procedures. This work, as well as the following item, is also related to the ITRS Combination Center at DGFI and DGFI's efforts within the IERS WG on Combination at the Observation Level (COL).
- The software DOGS-CS is updated by implementing and documenting the developed state-of-the-art combination procedures.
- Adhering to IERS Conventions: the DGFI DOGS software package is continuously updated to be in accordance with the IERS Conventions.

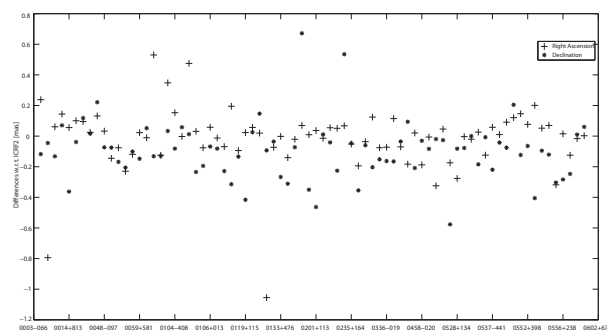
## 2 Activities During the Past Year

At BKG, the following activities were performed during 2013:

- Generation of a combined solution of IVS 24h rapid sessions twice a week.
- Generation of a combined long-term (quarterly) solution of IVS 24h sessions every three months.
- Further development of the IVS Combination Center's Web sites [5].
- Refinements of the combination procedure and implementation of source parameter combination.
- Development of an alternative combination procedure using the Bernese GNSS Software; implementation of the basic VLBI combination functions and preprocessing routines in cooperation with the University of Bonn.
- Participation in a pilot project on digital object identifiers (DOI) for data in cooperation with R. Heinkelmann (Deutsches GeoForschungsZentrum, Germany); feasibility investigation for providing data and meta data.

- A guideline for potential Analysis Centers that intend to contribute to the combined solution has been drafted in cooperation with R. Heinkelmann (GFZ). This guideline is available at <http://ccivs.bkg.bund.de/bid>.

Figure 1 shows an example plot of the differences in declination and right ascension for selected sources between combined source positions and their ICRF2 position. The differences are in the range of  $\pm 0.4$  mas.



**Fig. 1** Difference in right ascension (+) and declination (\*) between combined and ICRF2 source positions.

At DGFI the following activities were performed during 2013:

- Application of tidal corrections to UT1 according to IERS Conventions (2010) by DOGS-CS.
- Development of an EOP routine to switch between piecewise linear (offsets at 0h) and offset+drift representation.
- Improved realization of observation epochs in DOGS-CS with 8-byte precision.
- Handling of radio source position parameters with DOGS-CS.

### 2.1 Staff

The list of the staff members of the BKG/DGFI Combination Center in 2013 is given in Table 1.

Figure 2 shows the VLBI and IERS group at BKG in Frankfurt. From left to right: Ole Roggenbuck (DFG project on reference frames; combination at the observation level), Dr. Wolfgang Dick (IERS Central Bureau), Michael Lösler (IVS combination; replaced by



**Table 1** Staff members of the BKG/DGFI Combination Center.

Name	Affiliation	Function	E-Mail
Michael Gerstl	DGFI	Software maintenance	gerstl@dgfi.badw.de
Ralf Schmid	DGFI	Combination strategies	schmid@dgfi.badw.de
Mathis Bloßfeld	DGFI	Combination strategies	blossfeld@dgfi.badw.de
Sabine Bachmann	BKG	Combination procedure development	sabine.bachmann@bkg.bund.de
Linda Messerschmitt <sup>1</sup>	BKG	Operational Combination /Web site maintenance	linda.messerschmitt@bkg.bund.de
Michael Lösler <sup>2</sup>	BKG	Operational Combination /Web site maintenance	michael.loesler@bkg.bund.de

Linda Messerschmitt), Sabine Bachmann (IVS combination) and Dr. Daniela Thaller (head of section).

**Fig. 2** IVS combination and IERS group at BKG in Frankfurt.

More details on the IVS Combination Center at BKG can be found in an interview for the IVS Newsletter [6].

### 3 Current Status

In 2013, six IVS Analysis Centers (BKG, DGFI, GSFC, IAA, OPA, and USNO) contributed to the IVS combined product (see [5]). The rapid solutions contain only R1 and R4 sessions, and new data points are added twice a week as soon as the SINEX files of at least four IVS Analysis Centers are available.

<sup>1</sup> Linda Messerschmitt joined the BKG Combination Center in October 2013.

<sup>2</sup> Michael Lösler left the BKG Combination Center in July 2013.

Long-term series are generated quarterly and include every 24h session since 1984. The quarterly series include long-term EOP, station positions, and velocities. Furthermore, a VLBI TRF is generated and published. The preprocessing to read and write source positions was implemented, and the software was extended to process source parameters. The results of the combination process are archived by the BKG Data Center in Leipzig. The combined rapid EOP series, as well as the results of the quality control of the Analysis Center results, are also available directly at the BKG/DGFI Combination Center Web page [5] or via the IVS Analysis Coordinator Web site.

### 4 Future Plans

In 2014, the work of the BKG/DGFI Combination Center will focus on the following aspects:

- Generation of the IVS contribution to ITRF2013: input data investigation, combination strategy and evaluation of the combined EOP and station coordinate time series as well as the comparison of the individual contributions of the Analysis Centers.
- Investigation into combination of source coordinates for time series of source coordinates and generation of a combined celestial reference frame based on VLBI intra-technique combination.
- Establish the digital object identifier (DOI) for combined VLBI products in cooperation with GFZ.

### References

1. Schwegmann, W., Gerstl, M., Heinkelmann, R., BKG/DGFI Combination Center Annual Report 2008, in: *International VLBI Service for Geodesy and Astrometry Annual Report*

- 2008, NASA/TP-2009-214183, D. Behrend and K. D. Baver (eds.), 250–252, 2009.
2. Nothnagel, A., Böckmann, S., Artz, T., *Analysis Coordinator Report*, in: *International VLBI Service for Geodesy and Astrometry 2007 Annual Report*, NASA/TP-2008-214162, D. Behrend and K. D. Baver (eds.), 16-17, 2008.
  3. Nothnagel, A., Böckmann, S., Artz, T., *Analysis Coordinator Report*, in: *International VLBI Service for Geodesy and Astrometry Annual Report 2009*, NASA/TP-2010-215860, D. Behrend and K. D. Baver (eds.), 45–47, 2010.
  4. [http://ilrs.dgfi.badw.de/fileadmin/dogs/cs\\_manual.ps](http://ilrs.dgfi.badw.de/fileadmin/dogs/cs_manual.ps)  
DOGS-CS software manual (German version only).
  5. <http://ccivs.bkg.bund.de/> BKG Combination Center Web page.
  6. Hase, H., BKG/DGFI Combination Center at Frankfurt, IVS Newsletter 36, 2-3, 2013. <http://ivscc.gsfc.nasa.gov/publications/newsletter/issue36.pdf>.

# Matera CGS VLBI Analysis Center

Roberto Lanotte

**Abstract** This paper reports the VLBI data analysis activities at the Space Geodesy Center (CGS) Matera, from January 2013 through December 2013, and the contributions that the CGS intends to provide for the future as an IVS Analysis Center.

## 1 General Information

The Matera VLBI station became operational at the Space Geodesy Center (CGS) of the Italian Space Agency (ASI) in May 1990. Since then, it has been active in the framework of the most important international programs. The CGS, operated by e-geos (a Telespazio/ASI company) on behalf of ASI, provides full scientific and operational support using the main space geodetic techniques: VLBI, SLR, and GPS.

## 2 Activities during the Past Year

During 2013, the following activities were performed at CGS:

- Global VLBI Solution cgs2013a  
The main VLBI data analysis activities at the CGS in the year 2013 were directed towards the realization of a global VLBI solution, named cgs2013a, using the CALC/SOLVE software (developed at

NASA/GSFC). The main and final characteristics of this solution are:

- Data span:  
1984.01.04 - 2012.12.27 (4356 sessions)
- Estimated Parameters:
  - Celestial Frame: Right ascension and declination as global parameters for 845 sources,
  - Terrestrial Frame: Coordinates and velocities for 81 stations as global parameters, and
  - Earth Orientation: Unconstrained X pole, Y pole, UT1, Xp rate, Yp rate, UT1 rate, dpsi, and deps.

- IVS Tropospheric Products  
Regular submission of tropospheric parameters (wet and total zenith path delays, and east and north horizontal gradients) for all VLBI stations observing in the IVS R1 and R4 sessions continued during 2013. Currently, 1,205 sessions have been analyzed and submitted, covering the period from 2002 to 2013. The results are available at the IVS products ftp site.
- CGS Contribution to IERS EOP Operational Series  
Since 2008, CGS has been delivering IERS R1 and R4 session EOP estimates as a regular contribution to the IERS EOP operational series. The whole cgs2007a solution, available when the contribution started, has been delivered to IERS as a reference series updated by periodic EOP solution submissions.

---

Centro di Geodesia Spaziale (CGS) - e-geos SpA

CGS Analysis Center

IVS 2013 Annual Report

### **2.1 Staff at CGS Contributing to the IVS Analysis Center**

- Dr. Giuseppe Bianco, responsible for CGS/ASI (primary scientific/technical contact).
- Dr. Rosa Pacione, responsible for scientific activities, e-geos.
- Dr. Roberto Lanotte, geodynamics data analyst, e-geos.

### **3 Future Plans**

- Continue and improve the realization of our global VLBI solution, providing its regular update on time.
- Continue to participate in the IVS analysis projects.
- Start to contribute to the “Daily Solution Files (DSNX)” project of the IVS, providing the datum-free normal equations.

# DGFI Analysis Center Annual Report 2013

Ralf Schmid, Michael Gerstl, Manuela Seitz, Detlef Angermann

**Abstract** This report presents the activities of the DGFI Analysis Center during 2013. Besides the regular IVS submissions, DGFI started to reprocess 24-hour sessions including the estimation of source positions. DOGS-RI, the new VLBI analysis software to be used at DGFI, is near completion.

DGFI has been acting as an IVS AC since the establishment of the IVS in 1999. Since November 2008, DGFI has been an operational AC regularly submitting constraint-free normal equations for 24-hour sessions in the SINEX format. Since 2008, DGFI has also been involved in the BKG/DGFI Combination Center.

## 1 General Information and Component Description

The DGFI Analysis Center (AC) is located at the German Geodetic Research Institute (Deutsches Geodätisches Forschungsinstitut, or DGFI) in the city center of Munich in Germany. DGFI is an autonomous and independent research institution affiliated with the Bavarian Academy of Sciences and Humanities (BAW) and funded by the Free State of Bavaria.

Research performed at DGFI covers many different fields of geodesy (geometric techniques, gravity field, Earth system modeling, etc.) and includes the contribution to national and international scientific services and research projects as well as various functions in scientific organizations (see <http://www.dgfi.badw.de>). DGFI closely cooperates with BAW and the Technische Universität München (TUM, including personnel at the Geodetic Observatory Wettzell) within the framework of the Center of Geodetic Earth System Research (CGE).

Deutsches Geodätisches Forschungsinstitut (DGFI)

DGFI Analysis Center

IVS 2013 Annual Report

## 2 Staff

In 2013, the DGFI AC had to cope with a rather low number of personnel. After Robert Heinkelmann left DGFI in autumn 2012 to become the head of the VLBI group at the German Research Centre for Geosciences (GFZ) in Potsdam, Julian Andres Mora-Diaz joined his group in early 2013. And since spring 2013, Manuela Seitz has been on maternity leave.

**Table 1** Staff members and their main areas of activity.

Dr. Detlef Angermann	Group leader
Dr. Michael Gerstl	Development of the analysis software DOGS-RI
Mr. Julian Andres Mora-Diaz (now at GFZ)	Routine data analysis
Dr. Ralf Schmid	Routine data analysis, combination of different space geodetic techniques
Dr. Manuela Seitz (currently on maternity leave)	CRF/TRF combination, ICRF3, combination of different space geodetic techniques

As all these vacancies could not be filled in the meantime, the activities of the DGFI AC were more or less limited to the routine analysis of 24-hour sessions which has been performed by Ralf Schmid since

the end of May 2013. In addition, Michael Gerstl is engaged in the development of a new VLBI analysis software called DOGS-RI (DGFI Orbit and Geodetic Parameter Estimation Software - Radio Interferometry).

Table 1 lists the staff members and their main areas of activity.

### 3 Current Status and Activities

#### Analysis Activities

The DGFI AC tries to analyze all 24-hour sessions for which a database file of at least version 4 is available using the VLBI analysis software OCCAM. Since the end of 2012, source positions are among the estimated parameters contained in the normal equations that are submitted to the IVS Combination Center. Before, source positions were fixed to their a priori values.

In June 2013, the handling of the cable calibration data changed. Since then, the cable calibration of certain stations is turned off in case it degrades the solution. Before, the database settings were applied. Therefore, in the case of an extreme degradation, stations sometimes had to be excluded from the solution.

At the same time, the DGFI AC started to reanalyze sessions in the case in which recorrelated data considering additional stations become available. As recorrelated sessions are usually stored at the IVS Data Centers with the same name as the original database file, updated sessions are not automatically detected. If a recorrelation is announced via IVSmail, the download is started manually.

In order to have consistent SINEX files, a reprocessing was started in autumn 2013 including the estimation of source positions, the proper handling of cable calibration data, and the consideration of recorrelated observation files. At the end of December 2013, consistent DGFI normal equations were available from July 2011 to December 2013.

If operational and reprocessed solutions are summed up, in 2013 DGFI analyzed 325 sessions altogether from four different years (2008 and 2011-13) and submitted the corresponding daily SINEX files to IVS. Among them were 124 IVS-R1, 123 IVS-R4, 19 IVS-R&D, 15 CONT11, 11 EUROPE, ten VLBA, eight IVS-T2, six IVS-OHIG, five CONT08, and four APSG sessions (see Table 2).

**Table 2** Sessions analyzed in 2013.

Session type	2008	2011	2012	2013	Total
APSG	–	1	2	1	4
CONT08	5	–	–	–	5
CONT11	–	15	–	–	15
EUROPE	–	2	4	5	11
IVS-OHIG	–	1	4	1	6
IVS-R1	–	24	52	48	124
IVS-R4	–	23	52	48	123
IVS-R&D	–	3	9	7	19
IVS-T2	–	1	4	3	8
VLBA	–	3	3	4	10
Total	5	73	130	117	325

#### Software Development

In order to follow IERS 2010 Conventions, OCCAM is refined to become part of DOGS. The theoretical models for the group delay need time derivatives and, in case of the delay rate, also the second time derivatives of the input parameters. The former approach to approximate these derivatives by divided differences with a fixed time step of two seconds was superseded.

Parameter and observation models were expanded to provide analytically calculated first and second time derivatives. This conversion is complete except for some routines calculating the equinox-based transformation matrix from the nutation parameters  $\Delta\psi$  and  $\Delta\epsilon$ . Thus, only the branch based on  $X_{CIP}$ ,  $Y_{CIP}$ , and the celestial intermediate origin is operative. The correlations between  $(X_{CIP}, Y_{CIP})$  and  $(x_{pol}, y_{pol})$  are not yet theoretically modeled; condition equations to prevent subdiurnal retrograde motions are missing.

### 4 Future Plans

In 2014, we would like to keep on reprocessing 24-hour sessions backward from July 2011 besides our operational contributions to IVS. Apart from that, detailed comparisons between DOGS-RI and OCCAM will be necessary, before we can switch to the new software.

#### Acknowledgements

We would like to thank Robert Heinkelmann for his continued support of the DGFI AC activities.

# GFZ Analysis Center 2013 Annual Report

Robert Heinkelmann<sup>1</sup>, Maria Karbon<sup>1</sup>, Li Liu<sup>1,2</sup>, Cuixian Lu<sup>1</sup>, Julian A. Mora-Diaz<sup>1</sup>, Tobias J. Nilsson<sup>1</sup>, Virginia Raposo-Pulido<sup>1,3</sup>, Benedikt Soja<sup>1</sup>, Minghui Xu<sup>1,2</sup>, Harald Schuh<sup>1</sup>

**Abstract** This report briefly provides general information and a component description of the recently established IVS Analysis Center at GFZ and outlines the planned activities.

*an environmentally friendly way, to guard against natural catastrophes, to assess changes in the climate and the environment and man's impact on these, and to research and utilise our world below ground, all based on a comprehensive understanding of systems and processes.*

## 1 General Information

Helmholtz Center Potsdam, GFZ German Research Center for Geosciences is the national research center for Earth sciences in Germany. The main tasks of GFZ according to its website ([www.gfz-potsdam.de](http://www.gfz-potsdam.de)) are:

*System Earth—Research Focus of the GFZ German Research Center for Geosciences*

*The Earth is a dynamic planet. Under the influence of external and internal forces, it is continuously changing. The solid Earth, the atmosphere, the hydrosphere and the things living within them are always interacting. In short, the Earth is a complex system, with forces and interactions between many different partners. To understand the world in which we live, from our regional environment to the entire planet, it is necessary to understand how the System Earth works in all details. In the analysis, we have to include the activities of mankind and their influence on the natural processes in this complex, nonlinear system, which in turn affects the environment we live in.*

*The overarching research aim of the GFZ is one of developing strategies and demonstrating practical options, e.g. to preserve natural resources and to exploit them in*

1. Helmholtz Center Potsdam, GFZ German Research Center for Geosciences
2. Shanghai Astronomical Observatory, Chinese Academy of Sciences
3. Instituto Geográfico Nacional, Centro Nacional de Información Geográfica

GFZ Analysis Center

IVS 2013 Annual Report

At this research facility within Department 1 'Geodesy and Remote Sensing' and its Section 1.1 'GPS/GALILEO Earth Observation,' a VLBI group was established in November 2012.

## 2 Component Description

Since December 2012, GFZ has been an associate Analysis Center (AC) of IVS. We are installing and automating our VLBI analysis process in preparation for becoming an operational AC. We will analyze all incoming geodetic/astrometric types of sessions and provide interim results in the SINEX format within 24 hours after the provision of database files of version 4 or higher at IVS Data Centers. At the end of 2013 we started a complete re-processing of all available IVS databases to get prepared for a contribution to ITRF2013. We are also performing as an IVS Combination Center for tropospheric products. In 2013 the IVS rapid combination product was determined at GFZ, while results and written output were still provided via the Deutsches Geodätisches Forschungsinstitut (DGFI) webpage. In 2014, we will finish the migration of the IVS troposphere Combination Center from DGFI to GFZ.

### 3 Staff

At the GFZ IVS AC, the operational work is done by Robert Heinkelmann, Tobias Nilsson, and Julian Mora-Diaz. In addition, Maria Karbon and Benedikt Soja work within project VLBI-ART about the application of Kalman filtering to VLBI analysis, and Virginia Raposo-Pulido works on the ICRF and related systematic effects. Liu Li and Minghui Xu are guest PhD students from Shanghai, China, and Cuixian Lu is a guest PhD student from Wuhan, China. Harald Schuh is managing our group and, as long as his schedule allows, he is still very active for the IVS. A photo of us is shown in Figure 1.

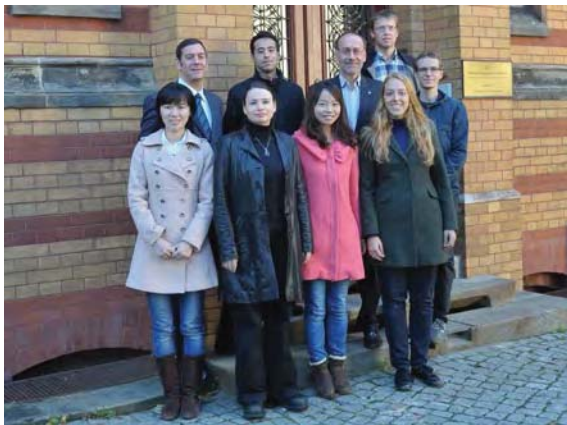


Fig. 1 The GFZ VLBI group in October 2013.

### 4 Current Status and Activities

- IVS Associate Analysis Center at GFZ  
At GFZ we use VieVS for VLBI data analysis starting at DB version 4 or higher. Together with the IVS Analysis Center at the Department of Geodesy and Geoinformation, Vienna University of Technology, we develop VieVS.
- Space applications  
Our scientific work focuses on VLBI applications in space, on GNSS observations using VLBI antennas, and on co-location in space of the various space geodetic techniques (VLBI, GNSS, SLR, and DORIS). One of the next steps will be the devel-

opment of the differential VLBI (D-VLBI) method and its application for geodetic purposes.

- VLBI data analysis using Kalman filtering  
Within the project VLBI-ART (VLBI Analysis in Real-Time, [1]) we plan to implement a Kalman filter solution in the Vienna VLBI Software (VieVS) [2], as an alternative to the classical least squares solution (LSQ). The aim of the Kalman filter solution is that it should be able to analyze VLBI data in near real-time. Thus, the software will be ready for a possible future scenario where the VLBI observations are available with a much shorter latency than today.

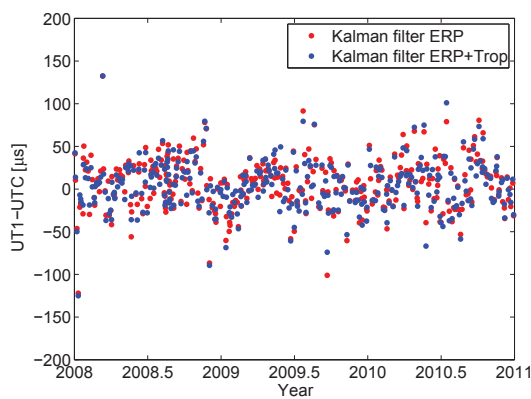
An advantage of a Kalman filter is that the parameters can be modeled as stochastic processes instead of with the piece-wise linear parametrization normally used in the LSQ solution. This allows better modeling of the random variations in e.g. the tropospheric delays. Furthermore, a Kalman filter requires less computer memory compared to the LSQ method, what will be an advantage for VLBI2010 where the amount of data will increase by several magnitudes. We will also investigate the possibility of including data from other sensors in the Kalman filter. These could for example be data on geophysical excitations of Earth rotations (e.g. from numerical weather prediction models), tropospheric delays from water vapor radiometers or GNSS, or Earth rotation parameters from GNSS and ring laser gyroscopes.

As a first step we have performed various investigations in which we applied Kalman filtering for combining VLBI results (produced with the LSQ solution in VieVS) with results from other techniques. For example we made several tests combining VLBI data with atmospheric excitations from numerical weather prediction models. Furthermore, we combined hourly EOP estimated from VLBI and GNSS [3].

An interesting possibility is to use a Kalman filter to combine UT1-UTC parameters estimated from the VLBI Intensive sessions with Length of Day (LOD) data obtained from GNSS [4]. The LOD from GNSS provides precise information about the short term (one week or less) UT1-UTC variations, while the VLBI Intensives have the long-term stability. In addition, other parameters common to both VLBI and GNSS can be combined in the Kalman filter, i.e. polar motion, station coordinates,



and tropospheric delays. Because correlations between the VLBI UT1-UTC estimates and errors of other parameters exist, this will additionally help to improve the UT1-UTC results. As an example, Figure 2 shows UT1-UTC from 2008-2010 estimated when also combining the tropospheric delays in the Kalman filter, compared to when not doing this. We found that the WRMS differences relative to the UT1-UTC values estimated from normal IVS-R1/R4 sessions slightly decreased from 27.1  $\mu\text{s}$  to 26.1  $\mu\text{s}$ .



**Fig. 2** UT1-UTC estimated from a Kalman filter combination of the results of the VLBI Intensive sessions and the GNSS LOD estimates, relative to estimates from the IVS-R1/R4 sessions. Shown are the results obtained when combining the UT1-UTC/LOD and polar motion, as well as the case when also combining the tropospheric delay estimates.

- Long-term troposphere combined product  
It is planned to generate a new updated version of the long-term tropospheric combination product including the most recent observational data.

## 5 Future Plans

- IVS Operational Analysis Center at GFZ  
At GFZ we would like to become an operational Analysis Center of IVS. Therefore we are installing and automating the standard VLBI data processing using VieVS in least squares estimation mode. Once we have finished a complete re-processing of all available IVS databases of version 4 or higher,

we will submit our solution to IVS, applying to become operational.

## Acknowledgements

The VLBI-ART project is funded by the Austrian Science Fund (FWF), project number P24187-N21.

## References

1. M. Karbon, T. Nilsson, C. Tierno Ros, R. Heinkelmann, and H. Schuh. VLBI-Art: VLBI analysis in real-time. In N. Zubko and M. Poutanen, editors, *Proceedings 21th Meeting of the European VLBI Group for Geodesy and Astrometry*, pages 95–97, Espoo, Finland, 2013.
2. J. Böhm, S. Böhm, T. Nilsson, A. Pany, L. Plank, H. Spicakova, K. Teke, and H. Schuh. The new Vienna VLBI software. In S. Kenyon, M. C. Pacino, and U. Marti, editors, *IAG Scientific Assembly 2009*, number 136 in International Association of Geodesy Symposia, pages 1007–1011, Buenos Aires, Argentina, 2012. Springer.
3. T. Nilsson, M. Karbon, and H. Schuh. A Kalman filter for combining high frequency Earth rotation parameters from VLBI and GNSS. In N. Zubko and M. Poutanen, editors, *Proceedings 21th Meeting of the European VLBI Group for Geodesy and Astrometry*, pages 117–120, Espoo, Finland, 2013.
4. T. Nilsson, M. Karbon, B. Soja, V. Raposo-Pulido, R. Heinkelmann, J. Mora-Diaz, C. Lu, L. Liu, and H. Schuh. Rapid UT1 estimation by combining VLBI Intensives with GNSS. In *Proceedings of the IAG Scientific Assembly*, Potsdam, Germany, 2013. submitted.

# The BKG/IGGB VLBI Analysis Center

Volkmar Thorandt<sup>1</sup>, Axel Nothnagel<sup>2</sup>, Gerald Engelhardt<sup>1</sup>, Dieter Ullrich<sup>1</sup>, Thomas Artz<sup>2</sup>, Sebastian Halsig<sup>2</sup>, Andreas Iddink<sup>2</sup>, Judith Leek<sup>2</sup>

**Abstract** In 2013, the activities of the BKG/IGGB VLBI Analysis Center, as in previous years, consisted of routine computations of Earth orientation parameter (EOP) time series and of a number of research topics in geodetic VLBI. The VLBI group at BKG continued its regular submissions of time series of tropospheric parameters and the generation of daily SINEX (Solution INdependent EXchange format) files. Quarterly updated solutions were computed to produce terrestrial reference frame (TRF) and celestial reference frame (CRF) realizations. The analysis of all Intensive sessions for UT1–UTC estimation was continued. Additionally, the a priori pole coordinates were recorded in the Intensive time series. The VLBI group at BKG developed a procedure to get meteorological data from a numerical weather model for stations with missing meteorological data in the station log file. At IGGB, the emphasis has been placed on individual research topics.

## 1 General Information

The BKG/IGGB VLBI Analysis Center was established jointly by the analysis groups of the Federal Agency for Cartography and Geodesy (BKG), Leipzig, and the Institute of Geodesy and Geoinformation of the University of Bonn (IGGB). Both institutions cooperate intensely in the field of geodetic VLBI. The responsibilities include both data analysis for generating

1. BKG
2. IGGB

BKG/IGGB Analysis Center

IVS 2013 Annual Report

IVS products and special investigations with the goal of increasing accuracy and reliability. BKG is responsible for the computation of time series of EOP and tropospheric parameters, for the generation of SINEX files for 24-hour VLBI sessions and one-hour Intensive sessions, and for the generation of quarterly updated global solutions for TRF and CRF realizations. Besides data analysis, the BKG group is also responsible for writing schedules for the Int2 UT1-UTC observing sessions. Details of the research topics of IGGB are listed in Section 3.

## 2 Data Analysis at BKG

At BKG, the Mark 5 VLBI data analysis software system Calc/Solve, release 2010.05.21 [1], has been used for VLBI data processing. It is running on a Linux operating system. As in the previous releases, the Vienna Mapping Function (VMF1) has been implemented in a separate Solve version. This modified version was used for all data analysis. The VMF1 data were downloaded daily from the server of the Vienna University of Technology. Additionally, the technological software environment for Calc/Solve was refined to link the Data Center management with the pre- and post-interactive parts of the EOP series production and to monitor all Analysis and Data Center activities.

### • Processing of correlator output

The BKG group continued the generation of calibrated databases for the sessions correlated at the MPIfR/BKG Astro/Geo Correlator at Bonn (e.g., EURO, OHIG, and T2) and submitted them to the IVS Data Centers.

- **Scheduling**

BKG continued scheduling the Int2 Intensive sessions, which are observed on the TSUKUBA-WETTZELL baseline. Altogether, 41 schedule files for this baseline were created in 2013. Due to maintenance combined with the shutdown of the TSUKUBA antenna from the middle of 2013, 22 schedule files for baseline KOKEE-WETTZELL, nine schedule files for baseline KOKEE-NYÅLESUND, and three schedule files for baseline KOKEE-SVETLOE were also made available.

- **BKG EOP time series**

The BKG EOP time series bkg00013 was continued. The main features of this solution were not changed. But the station coordinates of three VLBI sites in Australia (HOBART12, KATH12M, and YARRA12M) and one site in New Zealand (WARK12M) were estimated as global parameters because of an observation period of up to three years for each station. Furthermore the fact of unavailable meteorological data in station log files could be compensated by the use of meteorological data from European Centre for Medium-Range Weather Forecasts (ECMWF) contained in VMF1 data files. This procedure was integrated into the technological process of EOP series generation.

Each time after the preprocessing of any new VLBI session (correlator output database version 1), a new global solution with 24-hour sessions since 1984 was computed, and the EOP time series bkg00013 was extracted. Altogether, 4,540 sessions were processed. The main parameter types in this solution are globally estimated station coordinates and velocities together with radio source positions. The datum definition was realized by applying no-net-rotation and no-net-translation conditions for 25 selected station positions and velocities with respect to VTRF2008a and a no-net-rotation condition for 295 defining sources with respect to ICRF2. The station coordinates of the telescopes AIRA (Japan), CHICHI10 (Japan), CTVASTJ (Canada), DSS13 (USA), HART15M (South Africa), KASHIM34 (Japan), KOGANEI (Japan), PT\_REYES (USA), SEST (Chile), SINTOTU3 (Japan), TIGOCONC (Chile), TSUKUB32 (Japan), UCHINOUR (Japan), WIDE85\_3 (USA), VERAISGK (Japan), VERAMZSW (Japan), and

YEBES40M (Spain) were estimated as local parameters in each session.

- **BKG UT1 Intensive time series**

Regular analysis of the UT1-UTC Intensive time series bkgint09 was continued. Moreover, reporting was extended to also list the a priori pole coordinates in each session. The series bkgint09 was generated with fixed TRF (VTRF2008a) and fixed ICRF2. The a priori EOP were taken from final USNO series [2]. The estimated parameter types were only UT1-TAI, station clock, and zenith troposphere.

The algorithms of the semi-automatic process for handling the Intensive sessions Int2/3 with station TSUKUBA after the Japan earthquake [3] was further used; i.e. before the regular analysis can be started, the most probable station positions of TSUKUBA for the epochs of the Int2/3 sessions have to be estimated.

A total of 4,584 UT1 Intensive sessions were analyzed for the period from 1999.01.01 to 2013.12.31.

- **Quarterly updated solutions for submission to IVS**

In 2013 one quarterly updated solution was computed for the IVS products TRF and CRF. There are no differences in the solution strategy compared to the continuously computed EOP time series bkg00013. The results of the radio source positions were submitted to IVS in IERS format. The TRF solution is available in SINEX format, version 2.1, and includes station coordinates, station velocities, and radio source coordinates together with the covariance matrix, information about constraints, and the decomposed normal matrix and vector.

- **Tropospheric parameters**

The VLBI group of BKG continued regular submissions of long time series of tropospheric parameters to the IVS (wet and total zenith delays and horizontal gradients) for all VLBI sessions since 1984. The tropospheric parameters were extracted from the standard global solution bkg00013 and transformed into SINEX format.

- **Daily SINEX files**

The VLBI group of BKG also continued regular submissions of daily SINEX files for all available 24-hour sessions for the IVS combined products and for the IVS time series of baseline lengths. In addition to the global solutions, independent session solutions were computed for the station coordinates

dinates, radio source coordinates, and EOP parameters including the X,Y-nutation parameters. The a priori datum for TRF is defined by the VTRF2008a, and ICRF2 is used for the a priori CRF information.

- **SINEX files for Intensive sessions**

The parameter types are station coordinates, pole coordinates and their rates, and UT1-TAI and its rate. But only the normal equations stored in the SINEX files are important for further intra-technique combination or combination with other space geodetic techniques.

### 3 Research Topics at IGGB

- **Delay correction model for gravitational deformations of the Effelsberg radio telescope**

After having carried out and analyzed terrestrial laser scanner observations of the main reflector of the Effelsberg 100-m radio telescope, we have embarked on the construction of a full delay correction model for the gravitation deformations. The main effect is a bending of the support beam which holds the vertex of the paraboloid. The second largest effect is a variation of the position of the sub-reflector along the line of sight. With only a small impact, the variations in the focal length enter the path length variations. At the same time, the illumination function has to be taken into account and serves as a weighting function for the path lengths depending on the distance of the rays from the optical axis. The total effect would range from zero to -100 mm if observations at zero and 90 degrees elevation are compared. The complete delay model for Effelsberg was prepared for publication in Journal of Geodesy.

- **Development of an automatic scheduling procedure**

The automatic scheduling method developed at IGGB has been extended by useful steering parameters to create flexible observing plans. The simulation tool for assessment and evaluation was further developed and improved. Various observing scenarios of Intensives including twin radio telescopes were examined and compared with one other. Furthermore, the software has been extended to schedule typical 24-hour multi-baseline sessions. An additional option to use artificial

satellites as possible sources was implemented. Finally, the question of whether a cluster analysis of observed source positions can be used to classify and compare different VLBI observing plans has been investigated [4].

- **Studies on VLBI observations of satellites**

The observation of artificial Earth orbiting satellites with VLBI telescopes is one of the major challenges in the near future. In initial studies, this was addressed at IGGB. Starting with considerations about the signals' characteristics and necessary adaptations of the correlator model, scheduling of VLBI sessions including satellite observations have been performed. The scheduling was performed with the NASA/GSFC scheduling package SKED [5] as well as the IGGB scheduling approach mentioned above. For the scheduled observations, clock noise, and atmospheric noise as well as baseline dependent noise terms were added to generate realistic observations [6]. Finally, geodetic parameters as well as simplistic orbit parameters were estimated by using the VLBI Time Delay library [7].

- **Application of inequality constraints**

Refractivity variations in the neutral atmosphere contribute considerably to the error budget of VLBI. Generally, the tropospheric delay parameters are divided into two components; the hydrostatic a priori information is taken into account by applying an adequate model whereas the wet delay is estimated within the VLBI analysis. Sometimes, the standard VLBI analysis leads to negative tropospheric parameters, which do not reflect actual meteorological and physical conditions. For this purpose, an Inequality Constrained Least Squares adjustment from the field of convex optimization has been used to constrain these parameters to non-negative values. This methodology has been applied to VLBI data analysis to improve the parameter estimation. However, as the hydrostatic a priori information is not always perfect, the approach is currently not applicable on a routine basis.

- **Modification of the stochastic model**

Besides long periodic variations, micro-scale phenomena also affect geodetic observations and therefore the tropospheric parameters. Such turbulent processes can be best described stochastically using the widely accepted Kolmogorov turbulence

theory. However, the correlations between observations are generally not considered in the standard VLBI analysis, leading to deficiencies in modeling the stochastic properties of the observations. In order to receive a more reliable stochastic model, the additional stochastic properties are now incorporated into the VLBI analysis. That means that the standard variance-covariance matrix is enhanced by the additional stochastic information derived from different turbulence models.

- **Determination of a combination approach to derive the next generation of the ICRF**

The currently existing realizations of the International Celestial Reference System (ICRS), the International Celestial Reference Frame 1 (ICRF1) and ICRF2, are based on solutions estimated by a single VLBI group. In contrast, the International Terrestrial Reference Frame (ITRF) is based on a multi-technique combination with contributions from different geodetic space techniques. Furthermore, these individual technique-specific solutions are generated in an intra-technique combination. To overcome the shortcomings of the past ICRF determination, one of the main goals for the upcoming realizations of the ICRS and ITRS is an entirely consistent and simultaneous computation of both frames. This includes inter- as well as intra-technique combinations. Focusing on consistency between different VLBI solutions is the first necessary step before passing on to multiple space techniques. For this purpose, a concept for the generation of a VLBI intra-combined CRF was developed. This includes the identification of the requirements, difficulties, and individual steps of the intra-technique combination procedure. Based on the knowledge that has been gained, the combination software BonnSolutionCombination (BoSC) has been gradually developed. This software supports the combination on the level of normal equation systems and contains several special analysis and settings features. These features will become indispensable for any upcoming CRF investigations dealing with combinations. Preliminary results confirm the proper functioning of the combination procedure and the corresponding software developed at the IGG.

## 4 Personnel

**Table 1** Personnel at BKG/IGGB Analysis Center

Thomas Artz	IGGB	+49-228-733563	artz@igg.uni-bonn.de
Gerald Engelhardt	BKG	+49-341-5634438	gerald.engelhardt@bkg.bund.de
Sebastian Halsig	IGGB	+49-228-732623	halsig@igg.uni-bonn.de
Andreas Iddink	IGGB	+49-228-732623	iddink@igg.uni-bonn.de
Judith Leek	IGGB	+49-228-733565	judith.leek@igg.uni-bonn.de
Axel Nothnagel	IGGB	+49-228-733574	nothnagel@uni-bonn.de
Volkmar Thorandt	BKG	+49-341-5634285	volkmar.thorandt@bkg.bund.de
Dieter Ullrich	BKG	+49-341-5634328	dieter.ullrich@bkg.bund.de
Reiner Wojdziak	BKG	+49-341-5634286	reiner.wojdziaak@bkg.bund.de

## References

1. GSFC, NASA (2010): Release of Mark 5 VLBI Analysis Software Calc/Solve from May 21, 2010 (Web reference: <http://gemini.gsfc.nasa.gov/solve>).
2. USNO (2013): Earth orientation parameters series from finals USNO series 2013, (Web reference: [http://gemini.gsfc.nasa.gov/500/oper/solve\\_apriori\\_files/usno\\_finals.erp](http://gemini.gsfc.nasa.gov/500/oper/solve_apriori_files/usno_finals.erp)).
3. Engelhardt G., Thorandt V., Ullrich D. (2013): Rapid UT1 Estimation Derived from Tsukuba VLBI Measurements after 2011 Earthquake. In: Proceedings of the 21st Meeting of the European VLBI Group for Geodesy and Astronomy 2013, edited by N. Zubko and M. Poutanen, pages 85-87, Kirkkonummi 2013, Finland.
4. Leek J., Artz T., Nothnagel A.. (2013): Assessment of VLBI Intensive Schedules by Means of Cluster Analysis. In: Proceedings of the 21st Meeting of the European VLBI Group for Geodesy and Astronomy 2013, edited by N. Zubko and M. Poutanen, pages 211-215, Kirkkonummi 2013, Finland.
5. J. Gipson (2012): GSFC VLBI SKED Software Package, (Web reference: [http://lupus.gsfc.nasa.gov/software\\_sked.htm](http://lupus.gsfc.nasa.gov/software_sked.htm)), 2012.
6. Artz T., Nothnagel A., La Porta, L. (2013): VLBI Observations of Geostationary Satellites. In: Proceedings of the 21st Meeting of the European VLBI Group for Geodesy and Astronomy 2013, edited by N. Zubko and M. Poutanen, pages 217-221, Kirkkonummi 2013, Finland.
7. Petrov L. (2013): Library VTD for computation of VLBI time delay from October 10, 2013 (Web reference: <http://astrogeo.org/vtd>).

# GSFC VLBI Analysis Center Report

David Gordon<sup>2</sup>, Chopo Ma<sup>1</sup>, Dan MacMillan<sup>2</sup>, John Gipson<sup>2</sup>, Sergei Bolotin<sup>2</sup>, Karine Le Bail<sup>2</sup>, Karen Baver<sup>2</sup>

**Abstract** This report presents the activities of the GSFC VLBI Analysis Center during 2013. The GSFC VLBI Analysis Center analyzes all IVS sessions, makes regular IVS submissions of data and analysis products, and performs research and software development aimed at improving the VLBI technique.

## 1 Introduction

The GSFC VLBI Analysis Center is located at NASA's Goddard Space Flight Center in Greenbelt, Maryland. It is part of a larger VLBI group which also includes the IVS Coordinating Center, the CORE Operation Center, a Technology Development Center, and a Network Station. The Analysis Center participates in all phases of geodetic and astrometric VLBI analysis, software development and research. We maintain a Web site at <http://lupus.gsfc.nasa.gov>. We provide a pressure loading service to the geodetic community at <http://gemini.gsfc.nasa.gov/results/aplo> and a new ray tracing service. We provide additional services for hydrology loading, nontidal ocean loading, and meteorological data. These services can be found by following the links on the GSFC VLBI group Web site: [http://lupus.gsfc.nasa.gov/dataresults\\_main.htm](http://lupus.gsfc.nasa.gov/dataresults_main.htm).

1. NASA Goddard Space Flight Center

2. NVI, Inc./NASA Goddard Space Flight Center

GSFC Analysis Center

IVS 2013 Annual Report

## 2 Analysis Activities

The GSFC VLBI Analysis Center analyzes all IVS sessions using the *Calc/Solve* and *vSolve* systems, and performs the *fourfit* fringing and *Calc/Solve* analysis of the VLBA-correlated RDV sessions. The group submits the analyzed databases to IVS for all R1, RDV, R&D, APSG, AUST, INT01 and INT03 sessions. During 2013, GSFC analyzed 163 24-hour sessions (52 R1, 50 R4, six RDV, ten R&D, five AUST, three APSG, seven EURO, five T2, five OHIG, eight CRF, five CRDS, and seven JADE) and 333 one-hour UT1 sessions (243 INT01, 53 INT02, and 37 INT03), and we submitted updated EOP and daily Sinex files to IVS immediately following analysis.

## 3 Research Activities

- Intensive (IVS-INT01) Scheduling: We continued to study the Uniform Sky Strategy (USS), an alternative INT01 scheduling strategy proposed and tested in 2009/2010 and used for the INT01s on alternating days since mid-2010. We focused on refining the USS to address ways in which it underperforms the original scheduling strategy. We investigated the effects of schedule characteristics (e.g., temporal distribution of the observations) on schedule metrics (e.g., protection against random noise). We also investigated changing the schedule characteristics, and in turn the metric values, by passing new parameter values to program *sked*.
- Source Monitoring: Together with USNO we continued monitoring all ICRF2 defining sources and all good geodetic sources, and this year we

added the Gaia transfer sources. The goal is to observe all geodetic and Gaia transfer sources 12 times/year and the remaining ICRF2 defining sources five times/year. The R1, R4, and RDV sessions participate in the source monitoring program.

- **Good Geodetic Source Catalog:** Good geodetic sources are scarce. In 2011, many were removed because of time variability of their positions (special handling sources). In 2013, there were 266 geodetic sources in the good geodetic catalog. To search for additional sources, we used an approach similar to that described by Jing Sun (Shanghai Astronomical Observatory) in her PhD thesis. Our criteria was as follows: a structure index (SI) less than or equal to 2.5 (701 sources in IERS Technical Note No 35, Table 1) and an X-band flux greater than 0.25 Jy (658 sources in flux.cat). Of the 152 sources meeting both criteria, 105 were already in the good list and 47 were not. We wrote a proposal to observe these 47 sources in R&D sessions to verify if they could be detected and to measure their fluxes. They were observed in RD1302, RD1303, and RD1304. After analysis, 35 were found to be suitable and were added to the good geodetic source catalog.
- **Gaia Transfer Sources:** In preparation for linking the future ICRF3 and Gaia optical reference frames, four lists of transfer sources (quasars that should be visible by both systems) were compiled by Observatory of Bordeaux personnel. Class 4, with 24 sources, had the weakest and least observed sources. We scheduled these 24 sources in R&D and RDV sessions. Some were detected in the R&Ds, and all were detected in the RDVs. Their fluxes were added to the *sked* flux catalog. These will be re-observed occasionally in future R&D and/or RDV sessions.
- **Thermal Deformation Modeling:** Thermal expansion can affect a VLBI antenna's height by as much as 20 mm. In Le Bail et al. (2013), we investigated the impact of thermal expansion, as well as the optimal time lags for steel telescope structures and concrete foundations, using the Nothnagel model (J. Geodesy, **83**, pages 787–792, 2009). We compared different solutions of the R1 and R4 sessions from January 2002 to March 2011 with and without the thermal expansion model and with different time lags. Thermal deformation modeling significantly improved the VLBI solutions, improving the baseline length repeatability on more than 75% of the baselines by more than 1 mm on average, and reducing the WRMS per station. The time lag for the steel structures was optimal when set to zero, one, or two hours. However, for concrete foundations, no sensitivity to time lag was found. We believe this is because the concrete foundations are much smaller than the steel structures. Also, preliminary results show significant correlations between 1) the maximum WRMS improvement and the height of the foundation, 2) the maximum WRMS improvement and the distance from the movable axis to the antenna vertex, and 3) the optimal time lag for the antenna and the antenna diameter.
- **Nutation Analysis:** We rehabilitated nutkal2012.f, a Fortran routine that uses the Kalman filter to regularize the nutation time series. The model is defined by a linear trend and specified harmonics, and the program includes an indicator of the quality of the estimate (goodness of fit).
- **Analysis of LOD Time Series with the SSA:** Variations in the temporal length-of-day (LOD) contain information on phenomena related to the continuous evolution of Earth processes: tidal energy dissipation and core-mantle coupling (decadal and secular) and meteorological and solar-lunar tide effects (annual and semiannual). We studied an LOD time series obtained from VLBI and extracted its principal components using Singular Spectrum Analysis (SSA) (Le Bail et al., 2014). After removing the long-term trend which explains 73.8% of the signal, three remaining components explain a further 22.0% of the signal: an annual and a semi-annual signal as well as a second trend. Using the complex demodulation method, we obtained the variations in the amplitudes of the annual and semi-annual components. We compared the Multivariate ENSO index (MEI) with these series and with the second trend obtained by the SSA. The correlations are significant: 0.58 for the annual component, -0.48 for the semi-annual component and 0.46 for the second trend.
- **Troposphere Raytracing:** We wrote a paper on the calculation of troposphere raytrace delays and the application of raytraced delay corrections. It will be submitted to the Journal of Geophysical Research. These delays were calculated by raytracing 3D refractivity fields computed from the NASA/GSFC

GEOS 5.9.1 numerical weather model. Repeatabilities were reduced for 70% of CONT11 baseline lengths and for 84% of CONT11 vertical site coordinates. We set up a raytracing service that provides raytrace delays for all VLBI sessions since 2000 at <http://lacerta.gsfc.nasa.gov/tropodelays>.

- **Hydrology Loading:** We wrote a paper on hydrology loading entitled, “Continental hydrology loading observed by VLBI measurements”, which was submitted to *Journal of Geodesy*. It discusses the VLBI analysis results due to applying a hydrology loading series calculated from either 1) the GSFC GLDAS hydrology model or 2) GRACE (Gravity Recovery and Climate Experiment) mascons. We obtained a reduction in 1) baseline length repeatabilities for 80% of baselines, 2) site vertical repeatabilities for 80% of the sites, and 3) annual site vertical amplitudes for 90% of the sites.
- **Space Geodesy Project Simulations:** We are working with Erricos Pavlis (UMBC) to optimize the choice of a global network of co-located technique sites and specifically to decide where NASA should establish new sites. We have provided the VLBI observations and solution setup input for *Geodyn* SLR+VLBI+GPS combination solutions. Simulated observed VLBI delays consist of troposphere turbulence, clock, and observation noise contributions. We have done simulations of current observing networks of legacy antennas and are working on the simulations for future networks of broadband antennas, which are expected to grow to 15-20 antennas by around 2018.
- **Second Epoch VCS Observations:** A proposal to reobserve up to 2400 VCS (VLBA Calibrator Survey) sources was submitted to the VLBA and approved. The investigators are D. Gordon (PI), C. Ma, six other IVS members and two NRAO astronomers. This project was granted eight 24-hour sessions and will use the RDBE system at X- and S-bands with 16 32-MHz channels. The observations will run in 2014.

## 4 Software Development

The GSFC VLBI Analysis Center develops and maintains the *Calc/Solve* analysis system, a package of ~120 programs and 1.2 million lines of code.

During 2013, modifications were made to enable *Calc/Solve* to be compiled, loaded, and run on 64-bit machines. Additional modifications to allow it to be compiled with gfortran, instead of the Intel compiler, are underway.

Program *calc* was updated to version 11 for compliance with the IERS 2010 Conventions. *Calc11* uses the IAU2006/2000 Precession/Nutation model, a new ocean loading model (Hardisp) with 342 constituent tides, an ocean pole tide loading model, and improved high frequency EOP corrections. We also began work on a specialized version, *dcalc*, for use with the *difx* software correlator. *Dcalc* also contains a near-field delay model, based on the model of Sekido and Fukushima (*J. Geodesy*, **80**, pages 137–149, 2006), to allow better correlation of Earth satellites and planetary probes.

We continued development of the *vSolve* analysis program. The *vgosDB* part of the I/O module was improved and redesigned. Also, essential parts of the software were optimized to improve performance. Numerous comparisons of interactive *Solve* and *vSolve* have shown the two to be comparable. *vSolve* is now the standard tool for processing the IVS-R4 and IVS-INT sessions at GSFC.

We continued to develop and refine the *vgosDB* data format to store VLBI data. This year we concentrated on programs to reproduce all stages of the processing of Mark III databases. *vgosDBmake* takes correlator output and knits the files together into the new format. *vgosDBcalc* is analogous to *calc* in that it adds theoretical and partials to the *vgosDB* session. *vgosDBcal* reads the log files and adds cable cal and met data. Since *vSolve* can read the *vgosDB* format, we are now able to perform all stages of analysis starting with correlator output. We also developed the utilities *vgosDBview* to view and modify data in this format, and *vgosDBcompare* which will compare files in the new format and find the differences.

It is well known that the scatter of baseline length is larger than it should be, based on the formal errors of the *Solve* solutions. One possible explanation for this is the presence of unmodeled station dependent noise. We developed software to determine this noise. The software takes as input baseline length measurements from some set of sessions, for example CONT11. It then adds station-dependent-noise to the formal errors until the chi-square of the baseline scatter is approximately equal to 1.



**Table 1** Staff members and their main areas of activity.

Ms. Karen Bayer	Intensive analysis, monitoring, and improvement; software development; Web site development; quarterly nuvel updates.
Dr. Sergei Bolotin	Database analysis, <i>vSolve</i> development, ICRF3.
Dr. John Gipson	Source monitoring, high frequency EOP, parameter estimation, new data structure, station dependent noise.
Dr. David Gordon	Database analysis, RDV analysis, ICRF3, astronomical source catalogs, <i>calc/dcalc</i> development, quarterly ITRF updates.
Dr. Karine Le Bail	Time series statistical analysis (EOP, nutation, source positions), database meteorological data analysis.
Dr. Chopo Ma	ICRF3, CRF/TRF/EOP, VGOS development.
Dr. Daniel MacMillan	CRF/TRF/EOP, mass loading, antenna deformation, VGOS and SGP simulations, VLBI/SLR/GPS combinations.
Mr. David Eriksson	Mass loading, troposphere raytracing (intern).
Mr. Tobias Forsberg	Station stabilities, vgosDB development (intern).
Ms. Julia Ringsby	vgosDB development (intern).
Mr. Ronny Videkull	vgosDB development (intern).
Ms. Emma Woxlin	Station stabilities, vgosDB development (intern).

## 5 Staff

During 2013, the Analysis Center staff consisted of one GSFC civil servant, Dr. Chopo Ma, six NVI, Inc. employees who work under contract to GSFC, and five temporary student interns from Chalmers University of Technology (Sweden). Dr. Ma oversees the GSFC VLBI project for GSFC and is also the IVS co-representative to the IERS. Dr. John Gipson is the GSFC VLBI Project Manager as well as the IVS Analysis Coordinator. Table 1 lists the staff members and their main areas of activity.

## 6 Future Plans

Plans for the next year include ICRF2 maintenance, second epoch VCS observations, preparations for ICRF3, participation in VGOS development, continued development of *vSolve* and the new vgosDB data format, upgrade of program *dcalc*, and further research aimed at improving the VLBI technique.

## References

1. K. Bayer and J. Gipson, "Refining the Uniform Sky Strategy for IVS-INT01 Scheduling", Proceedings of the 21<sup>st</sup> Meeting of the EVGA, N. Zubko and M. Poutanen (Editors), pages 205–209, 2013.
2. S. Bolotin, K. Bayer, J. Gipson, D. Gordon, D. MacMillan, "Status of nuSolve", Proceedings of the 21<sup>st</sup> Meeting of the EVGA, N. Zubko and M. Poutanen (Editors), pages 77-80, 2013.
3. K. Le Bail, J. M. Gipson, J. Juhl, D. S. MacMillan, "Optimal time lags to use in modeling the thermal deformation of VLBI Antennas", Proceedings of the 21<sup>st</sup> Meeting of the EVGA, N. Zubko and M. Poutanen (Editors), pages 165–168, 2013.
4. K. Le Bail, J. M. Gipson, D. S. MacMillan, "Quantifying the correlation between the MEI and LOD variations by decomposing LOD with Singular Spectrum Analysis", Proceedings of the IAG General Assembly, Melbourne, Australia, June 28–July 2, 2011; IAG Symposia, Vol. 139; Rizos, Chris; Willis, Pascal (Editors), pages 473-480, 2014.
5. David Gordon, Chopo Ma, Dan MacMillan, Sergei Bolotin, Karine Le Bail, and John Gipson, "Effects of ICRF2 on the TRF, CRF, and EOP", Reference Frames for Applications in Geosciences, IAG Symposia, Vol. 138; Z. Altimimi and X. Collilieux (Editors), pages 175-180, 2013.
6. C. Ma, D. MacMillan, S. Bolotin, K. Le Bail, D. Gordon, and J. Gipson, "Comparison of Realizations of the Terrestrial Reference Frame", Reference Frames for Applications in Geosciences, IAG Symposia, Vol. 138; Z. Altimimi and X. Collilieux (Editors), pages 51-56, 2013.

# Haystack Observatory Analysis Center

Arthur Niell, Roger Cappallo, Brian Corey, Jason SooHoo, Mike Titus

**Abstract** Analysis activities at Haystack Observatory are directed towards improving the accuracy of geodetic measurements, whether these are from VLBI, GNSS, SLR, or any other technique. Those analysis activities that are related to technology development are reported elsewhere in this volume. In this report we present some preliminary results of an analysis of a 24-hour broadband VGOS session from May 22, 2013. The data were calibrated to obtain correlated flux densities at X-band for a subset of the sources, and a geodetic solution was obtained. Both analyses led to improvements in the DiFX correlator and the post-correlation software.

## 1 Introduction

The broadband instrumentation for the next generation geodetic VLBI system, previously called VLBI2010 but now referred to as VGOS (for VLBI2010 Global Observing System), was implemented on a new 12-m antenna at the Goddard Space Flight Center near Washington, D.C., USA, and on the Westford 18-m antenna at Haystack Observatory near Boston, Massachusetts, USA. In October 2012 the first geodetic observing sessions were conducted using the broadband system. Results from these sessions were described in last year's Analysis Center Annual Report. In this report we highlight the procedures for obtaining correlated flux den-

sities and baseline results for a 24-hour session on May 22, 2013.

The features of the VGOS system are repeated here for reference:

- four bands of 512 MHz each, rather than the two (S and X) for standard IVS sessions
- dual linear polarization in all bands
- multitone phase cal delay for every channel in both polarizations
- simultaneous estimation of the total electron content difference (dTEC) between sites along with the ionosphere-free group delay using the phases across all four bands spanning 3.2 GHz to approximately 8.8 GHz for this session.

The features indicated in the last three bullets have required changes to the analysis of the geodetic delays, and these have been implemented in the post-correlation software *difx2mark4* and *fourfit*.

## 2 The Observations

The main objective of the 24-hour session on May 22, 2013 was to validate the quality of the calibration of correlated flux densities on the GGAO12M-Westford baseline. Since the largest number of potential comparison values is from the S/X observations of the geodetic VLBI program, the highest frequency band was chosen to lie within the range of the geodetic X-band, covering approximately 8.3 – 8.8 GHz. The frequencies of the other three bands were the same as used in October 2012, covering 512 MHz beginning at 3.2, 5.2, and 6.3 GHz. S-band was not observed because the presence

---

MIT Haystack Observatory

Haystack Analysis Center

IVS 2013 Annual Report

of RFI was likely to severely limit the validity of any calibration.

The schedule was generated using *sked*. Because *sked* does not yet have the capability to account for the broadband parameters, the SEFDs at both S-band and X-band for the two antennas were adjusted to allow use of the R1 session parameters. The 100 strongest sources were selected from the catalog of good geodetic sources. A minimum scan length of 30 seconds was set, and the minimum SNR was 15 for both bands. The minimum elevation was set to  $5^\circ$ , and a cone about the SLR site to the southwest of the GGAO antenna was masked out to avoid potential damage to the LNAs by the SLR aircraft avoidance radar. The average scan length observed was 31 seconds, and the average number of scans per hour was 48.

The signal chain consisted of a QRFH feed, low noise amplifiers, and phase calibration injection in the payload near the focus for both antennas, and four Up-Down Converters, RDBE-Hs, and Mark 5C recorders in the control room. These are described more completely in Niell et al (2012).

### 3 Correlated Flux Density Measurements

The correlated flux density  $S_c$  for each observation was obtained from the correlation coefficient  $\rho$  as:

$$S_c = b * \rho * \sqrt{(SEFD1 * SEFD2)} \quad (1)$$

where

- $b = 1.13$  for DiFX correlator (Cappallo, private communication)
- $SEFD_{1,2}$  = System Equivalent Flux Density for GGAO and Westford at the time of the observations.

The SEFDs in the 8 GHz band (X-band) were obtained for each scan by scaling the on-source power level at the time of each observation to the on-source minus off-source power difference for CasA. The measurements for CasA were made before, after, and near the middle of the session. However, the elevations of the source at the beginning and end were too low for useful measurements, so only the mid-session value was used for calibrating the correlated flux densities. The CasA power was corrected for partial resolution of

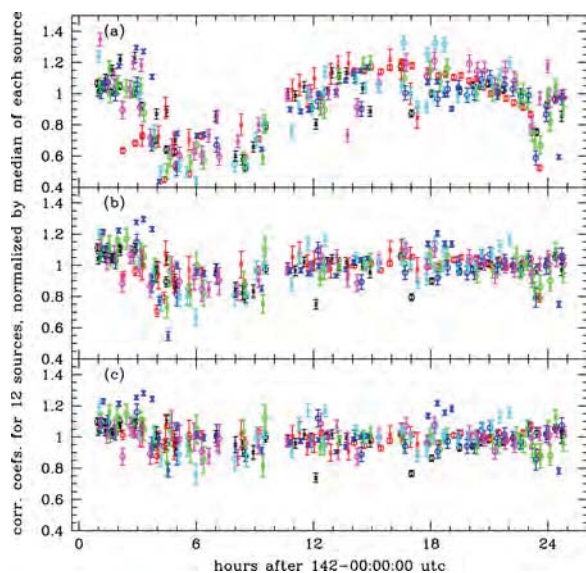
CasA because the angular size is not negligible compared to the half-power beamwidths of the two antennas. This method of estimating the SEFD is valid provided the system gain does not vary between the observation epoch and the CasA measurement epoch, so that system power tracks system temperature. Analysis of the phase cal amplitudes at the two stations showed that the gain variations were small.

The weather was stormy at Westford, and the system power varied by more than a factor of two during the first ten hours. Water on the Westford radome was largely responsible for the higher power levels. Besides affecting system temperature, variations in the thickness of the radome water layer or in atmospheric attenuation at either site can also cause variations in signal transmission loss from quasar to antenna feed. Corrections to the correlation coefficients were made for this latter effect.

Instead of displaying the correlated flux densities, we show, for twelve of the strongest sources and for the vertical polarization (V-pol), the ratios between the correlation coefficient for each scan of each source and the median value for that source using all of the data for the 24 hours (Figure 1). The three frames are for a) the observed correlation coefficients directly from the correlator; b) the same but multiplied by the square root of the product of the (equivalent of the) system temperature; c) and further corrected for absorption by the atmosphere and by a radome water layer using a simple model. The larger scatter for the first ten hours exhibited in 1c) is thought to be due to incomplete correction for variations in system temperature and absorption by the radome. For the last 14 hours, except possibly for the source 3C418 (blue crosses), the ratios are consistent with the sources being unresolved (no change in correlated flux density with baseline orientation). Because this is expected for good geodetic sources on this short baseline, the result is supportive of the calibration procedure.

### 4 Geodetic Analysis

The four bands were correlated independently and were first analyzed separately with the delay-estimation program *fourfit* to verify that the correlation was correct before being combined into one data set. Phase cal was applied using the ‘multitone’ option in



**Fig. 1** The correlation coefficient ratios to the median values at X-band for twelve sources: a) correlation coefficients from the correlator; b) correlation coefficients corrected for on-source power; c) further correction for atmospheric and radome loss.

*fourfit* which calculates the delay for each 32 MHz channel from the six or seven tones spaced 5 MHz apart. The four bands, each having two polarizations, were then combined into one file using *fourmer*; then *fourfit* was used to coherently estimate the group delay for all four bands and to obtain the coefficient of the inverse frequency dependence of the phase which is attributed to the differenced Total Electron Content (dTEC) between the two stations. With the application of multitone phase cal delay, there were no cycle ambiguities.

In order to process the observed delays through *calc* to obtain the observed-minus-model residuals, it was necessary to modify the program *dbedit* (D. Gordon, private communication) to accept delays obtained from 64 channels and from which the dispersive term had already been removed. The data were then analyzed using the program *nuSolve* which is in development by Sergei Bolotin to serve initially as a preprocessor for batch-mode *solve* processing but ultimately as a replacement for *solve*.

For the *nuSolve* analysis, because this is only a single 24-hour session, the model parameterization was relatively simple. Only the clock behavior at GGAO, the position of GGAO for the day, and the atmosphere

zenith delays and gradients at both stations were estimated. The clock and atmospheres were modeled as stochastic processes using the default process values from *nuSolve*. Tests were made for comparison using piecewise linear functions with intervals of ten minutes and longer, but the fits were not as good after re-weighting.

Short of having a series of observations on different days with which to assess the repeatability of observations with the two antennas, a similar comparison can be made with independent segments within a session. Therefore the 24-hour session was separated into independent six-hour segments. With the high observed scan rate, there were still over 250 useful observations in each segment. This is comparable to the number of scans per station for a full 24 hours in an IVS session.

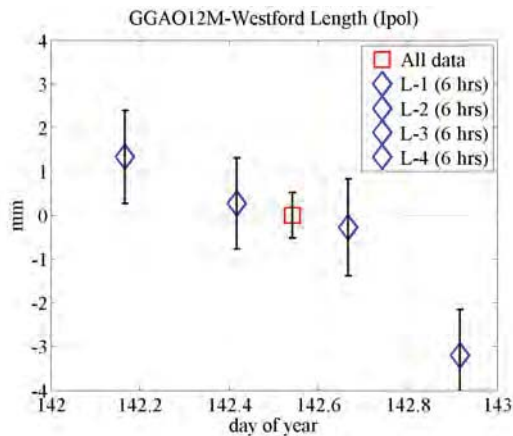
The length estimates for the full 24 hours and for each of the six hour segments are shown in Figure 2.

Independent measurements of this baseline were made in two six-hour sessions in October 2012 (Niell et al.). The agreement for successive days for the independent polarizations was at the millimeter level. While it would be tempting to compare the baseline length of this May 2013 session, there is reason to refrain: measurements of the phase cal delay obtained from the multitone phase cal processing for both sessions showed a strong dependence of delay on azimuth for the Westford antenna, although the range of variation was different by a factor of about two. For the May 2013 data, the range of delay was about 50 psec, while for October 2012 it was about 25 psec.

Since an uncorrected variation of azimuthal instrumental delay would be interpreted in the estimation process as an apparent error in the horizontal position of the antenna, it is not useful to compare the baseline lengths for the 2012 and 2013 sessions. In the future a cable delay measurement system will be deployed at the sites to reduce these errors to a negligible value (see the Technology Development Center Report for Haystack Observatory, Beaudoin et al, this volume).

## 5 Outlook

Observations using the 12 m and Westford are expected to become more frequent beginning in mid-2014. The correlation and data analysis chain (correlator/*fourfit*/*solve*) for the stand-alone broadband VGOS



**Fig. 2** Baseline length between Westford and GGAO12M on 2013 May 22. Red square: solution for all 24 hours of data; blue diamonds: independent six hour segment analyzed with the same parameterization as the full 24-hour solution.

observations and for the mixed broadband-Mark IV observations needs to be developed and made operational.

As a first step in facilitating these developments *nuSolve* has been installed at Haystack and was used for most of the geodetic analysis described in this report. A next step will be to begin to use the *vgosDB* format, followed by installation of the full *calc/solve/nuSolve* suite of programs.

## Acknowledgements

We thank the Broadband Development group for their efforts in constructing, implementing, and operating the systems at GGAO and at Westford and for assisting in the testing and observations; John Gipson for guidance in getting *sked* to work; David Gordon for getting the broadband output into databases; and Sergei Bolotin for developing *nuSolve*, getting it to work with the new broadband observable, and providing some of the solutions.

## References

1. Niell et al., "First Broadband Results with a VLBI2010 System", IVS 2012 General Meeting Proceedings, edited by D. Behrend and K. Baver, NASA-CP-2012-217504, pages 13-17.

# IAA VLBI Analysis Center Report 2013

Elena Skurikhina, Sergey Kurdubov, Vadim Gubanov, Daniil Shigaev

**Abstract** This report presents an overview of the IAA VLBI Analysis Center activities during 2013 and the plans for the coming year.

## 1 General Information

The IAA IVS Analysis Center (IAA AC) is located at the Institute of Applied Astronomy of the Russian Academy of Sciences in St. Petersburg, Russia. The IAA AC contributes to IVS products, such as daily SINEX files, TRF, CRF, rapid and long-term series of EOP, baseline lengths, and tropospheric parameters. EOP, UT1, and station positions were estimated from domestic observation programs Ru-E and Ru-U. The IAA AC generates NGS files.

## 2 Activities during the Past Year

### 2.1 Software Development for VLBI Processing

The QUASAR software is capable of calculating all types of IVS products. The possibility of outputting source positions to DSNX files was realized.

---

Institute of Applied Astronomy of RAS

IAA Analysis Center

IVS 2013 Annual Report

### 2.2 Routine Analysis

During 2013 the IAA AC continued to submit daily SINEX files for the IVS-R1 and IVS-R4 sessions as rapid solution (iaa2010a.snx) and SINEX files based on all 24-hour experiments for the quarterly solution.

The routine data processing was performed with the OCCAM/GROSS software using a Kalman Filter. The IAA AC operationally processed the “24h” and Intensive VLBI sessions and submitted the results to the IERS and IVS on a regular basis. Processing of the Intensive sessions is fully automated. The EOP series iaa2007a.eops and iaa2005a.eopi and troposphere parameters iaa2007a.trf were continued. Long-term series of station coordinates, baseline lengths, and tropospheric parameters (ZTD and gradients) were computed with the station position catalog ITRF2005.

### 2.3 Global Solution

iaa2012crf and iaa2012trf were submitted to IVS. A new global solution was calculated using all available data from 1980 until 2012 (through the end of September 2012 we had 5,654 sessions). A total of 6,912,198 delays were processed. The CRF was fixed by NNR constraints to 212 radio sources. The TRF was fixed by NNR and NNT constraints to the station positions and velocities of 15 stations: MATERA, KOKEE, WETTZELL, FORTALEZA, WESTFORD, ALGOPARK, NYALES20, ONSALA60, HARTRAO, BR-VLBA, FD-VLBA, HN-VLBA, KP-VLBA, LA-VLBA, and NL-VLBA. Stochastic signals were estimated by means of the least-squares collocation technique. The radio source coordinates, station coordi-

nates, and corresponding velocities were estimated as global parameters. EOP, WZD, troposphere gradients and station clocks were estimated as arc parameters for each session. 6,690 global parameters were estimated: 3,635 source positions, and the positions of the velocities of 156 VLBI stations.

## 2.4 EOP Parameter Calculation from Domestic “Quasar” Network Observations

VLBI observations using the “Quasar” network for EOP monitoring are carried out in the framework of two domestic programs: Ru-E and Ru-U.

The purpose of the Ru-E program is to provide EOP results on a regular basis from 24-hour sessions using three-station network: “Svetloe” – “Zelenchukskaya” – “Badary”.

The purpose of the Ru-U program is to provide UT1-UTC results on a regular basis from Intensive sessions using one baseline “Badary” – “Zelenchukskaya” (“Badary” – “Svetloe”).

Correlation analysis is performed using the IAA ARC correlator.

Observational data from 1-hour Ru-U sessions are transmitted to the correlator using e-VLBI data transfer. Calculation of UT1 time series is performed automatically. The result is a UT1-UTC time series available at <ftp://quasar.ipa.nw.ru/pub/EOS/IAA/eopi-ru.dat>.

Since April 2013 we have used e-VLBI data transfer for the data of 24-hour observations from “Badary” and “Zelenchukskaya”. Data of 24-hour sessions are shipped to the IAA correlator on disk modules only from “Svetloe” observatory. The EOP time series is available at <ftp://quasar.ipa.nw.ru/pub/EOS/IAA/eops-ru.dat>.

During 2013, 48 Ru-E and 356 Ru-U sessions were observed. AC IAA performed analysis of these observations. The accuracy obtained in 2013 for EOPs in comparison to the IAA EOP 08 C04 series is presented in Table 1.

**Table 1** RMS differences with EOP IERS 08 C04.

EOP	$N_{sess}$	Bias	RMS
$X_p, mas$	48	0.45	0.97
$Y_p, mas$	48	-0.67	1.23
UT1-UTC, $\mu s$	48	-15	35
$X_c, mas$	48	-0.13	0.34
$Y_c, mas$	48	-0.19	0.33
UT1-UTC Int., $\mu s$	356	25	67

## 2.5 CONT11 Data Analysis

Secondary treatment of the CONT11 program’s observations was carried out using software package OCCAM/GROSS. In the calculation of diurnal EOP, 15 daily sessions were combined into one 15-day session (consisting of 16,430 scans and 145,214 delays), which was processed using package OCCAM/GROSS using the forward run of the Kalman filter to estimate the stochastic parameters. As stochastic parameters are considered EOP (pole coordinates and universal time), the date, time, wet component of the tropospheric delay at the zenith (WZD).

Diurnal variations of  $X_{pol}$ ,  $Y_{pol}$ , and  $dUT1$  were compared with the model of diurnal variations from the EOP IERS Conventions (2003) model of subdaily EOP variations (designated here as “model”). The results are presented in Figure 1. RMS differences between EOP and the model are presented in Table 2.

**Table 2** CONT11: RMS differences between EOP and “model”.

EOP	$N_{point}$	RMS
$X_p, \mu as$	16123	167
$Y_p, \mu as$	16123	164
dUT1, $\mu s$	16123	18

The values of Tropospheric Total Zenith Delay (TZD) obtained during CONT11 from VLBI are in good agreement with data obtained from GPS observations. The results are presented in Figure 2.

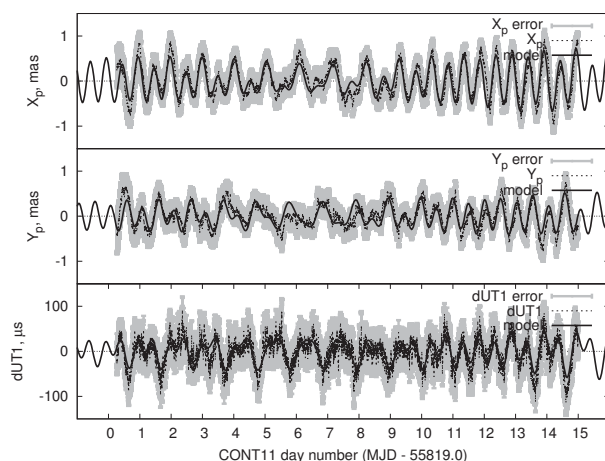


Fig. 1 EOP intra-day variations from CONT11.

## 2.6 Study of Systematic Errors of Reference Frames

First, directly from the data processing of VLBI observations from about 30 years and using systematic errors obtained from the QUASAR software, coordinates for ICRF2 radio sources were calculated as two-dimensional maps of distributions of radio source position errors on the celestial sphere and orthonormal expansion in spherical harmonics up to the ninth order. At some areas, the value of the errors is about 1 mas. Radio source and station position variations were then analyzed to study reference frame stability.

## 3 Current Status

The IAA AC performs data processing of all kinds of VLBI observation sessions. For VLBI data analysis, we use the QUASAR and the OCCAM/GROSS software packages. All reductions are performed in agreement with IERS Conventions (2010). Both packages use NGS files as input data.

The IAA AC submits to the IVS Data Center all kinds of products: daily SINEX files for EOP and EOP-rates and station position estimates, TRF, CRF, baseline length, and tropospheric parameters.

The QUASAR and the OCCAM/GROSS software packages are supported and being developed.

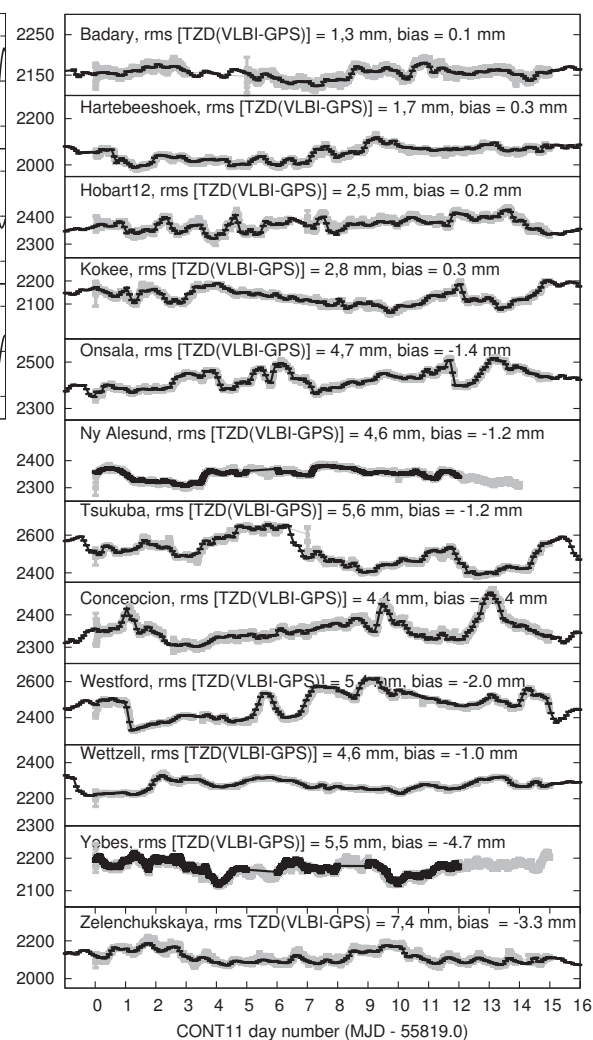


Fig. 2 TZD intra-day (VLBI compared with GPS) variations from CONT11.

## 4 Future Plans

We plan to:

- Continue to submit all types of IVS product contributions.
- Continue investigations into VLBI estimation of EOP, station coordinates, and tropospheric parameters, and comparison with satellite techniques.
- Further improve algorithms and software for processing VLBI observations.
- Contribute to ICRF3 Working Group study.



# Italy INAF Analysis Center

Monia Negusini, Pierguido Sarti

**Abstract** This report summarizes the activity of the Italian INAF VLBI Analysis Center. Our Analysis Center is located in Bologna, Italy and belongs to the Institute of Radio Astronomy (IRA), which is part of the National Institute of Astrophysics (INAF). IRA runs the observatories of Medicina and Noto, where two 32-m twin VLBI AZ-EL telescopes are located. This report contains the AC's VLBI data analysis activities and illustrates the local surveys carried out in 2013 at IRA observatories.

## 1 Current Status and Activity

The ITRF2013 Call for Participation (CfP) was issued at the end of March 2013. According to the call, *“the owners of co-location sites are solicited and highly encouraged to consider conducting new local tie surveys using the most up to date survey methods. The results of least squares adjustments of the survey observations should be provided to the ITRS Center in the form of SINEX format, with full variance-covariance information.”* The submission of the new tie vectors linking the co-located space geodetic instruments was due as early as possible and no later than the end of February 2014.

The CfP and its deadline induced us to plan new local tie surveys at both Medicina and Noto by the summer of 2013. In particular, the tie vector at the Medicina site was surveyed during June 2013 (from June 11<sup>th</sup> until June 14<sup>th</sup>) and the tie vector at Noto

was surveyed during three full days from July 10<sup>th</sup> until July 12<sup>th</sup>, 2013. The method that was adopted to conduct the surveys is based on the well-established protocol described in several papers [1, 2]. As usual, the surveys were carried out in close cooperation with the Department of Civil, Chemical, Environmental, and Material Engineering (DICAM) of the University of Bologna. Three high quality total stations from Leica (TDA5005, TS30, and TCA2003, <http://www.leica-geosystems.com>) were contemporarily used to minimize the observation time and increase the total number of measurements available to estimate the conventional reference point of the VLBI telescopes. Following the ITRF2013 CfP requirements, the GPS antennas were not removed to avoid undesirable possible discontinuity in the position time series when the antenna is restored back to its original marker. This was easily achieved following the GPS choke ring antenna survey approach described in detail in [1].

The surveys and the computation of the tie vectors at both sites were performed as part of a ten-week internship project agreed upon between the IRA and the IGN School in Geomatic Sciences, Ecole Nationale des Sciences Géographiques (ENSG) in Marne la Vallée, France. The internship involved Mr. Clément Iphar, a student of the school interested in geodesy and in the applications of terrestrial geodetic techniques for the computation of the ITRF.

The alignment of the tie vectors into the ITRF from the local topocentric frame was achieved using a set of points surveyed with both terrestrial techniques and GPS. The tie vectors were submitted in September 2013 to the ITRS Center in Paris and are now available for the computation of the new ITRF2013.

It is worth mentioning that the 2013 survey in Medicina confirms the general trends reported in

Istituto di Radioastronomia INAF, Bologna

INAF Analysis Center

IVS 2013 Annual Report

[3], with a striking stability of the tie vector Up component. The details and the results of the surveys will be summarized and discussed in two reports that will be submitted to the ITRS Center.

## 2 Data Analysis and Results

The IRA started to analyze VLBI geodetic databases in 1989, using a CALC/SOLVE package on the HP1000 at the Medicina station. In subsequent years, the same software was installed first on an HP360 workstation and later on an HP715/50 workstation. In more recent years, two HP785/B2600 workstations and an HP282 workstation were used. In 2007, a new Linux workstation was set up for the migration of all the VLBI data analysis, and Mark 5 Calc/Solve was installed. During 2013, our Analysis Center continued its participation in the IVS TROP Project on Tropospheric Parameters. Tropospheric parameters (wet and total zenith delay and horizontal gradients) of all IVS-R1 and IVS-R4 24-hour VLBI sessions were regularly submitted.

## 3 Outlook

We will continue with the regular submission of INAF tropospheric parameters to the IVS Data Center. We are also going to monitor the GPS-VLBI tie vectors at our sites on a regular basis, possibly every second year, to continue the investigations into the local movements and into the local site stability.

## References

1. Sarti, P., Sillard, P., Vittuari, L. (2004) Surveying co-located space geodetic instruments for ITRF computation. *J Geodesy* 78(3):210–222, doi: 10.1007/s00190-004-0387-0.
2. Sarti, P., Abbondanza, C., Vittuari, L. (2009) Gravity dependent signal path variation in a large VLBI telescope modelled with a combination of surveying methods. *J Geodesy* 83(11):1115–1126, doi: 10.1007/s00190-009-0331-4.
3. Sarti, P., C. Abbondanza, J. Legrand, C. Bruyninx, L. Vittuari, J. Ray. (2013) Intrasite motions and monument instabilities at Medicina ITRF co-location site. *Geophys J Int* 192:1042–1051, doi: 10.1093/gji/ggs092.

# JPL VLBI Analysis Center Report for 2013

Christopher S. Jacobs

**Abstract** This report describes the activities of the JPL VLBI Analysis Center for the year 2013. Highlights for the year include the start of operations for the combined NASA-ESA Ka-band network, installation of our Digital Back Ends enabling 1024–2048 Mbps operations, and our first installation of a Ka-band phase calibrator. We continue to support VLBI-based navigation using our combined spacecraft, celestial reference frame, terrestrial reference frame, earth orientation, and planetary ephemeris VLBI systems.

## 1 General Information

The Jet Propulsion Laboratory (JPL) Analysis Center is in Pasadena, California. Like the rest of JPL, the center is operated by the California Institute of Technology under contract to NASA. JPL has done VLBI analysis since about 1970. We focus on spacecraft navigation, including:

1. Celestial Reference Frame (CRF) and Terrestrial Reference Frame (TRF), which are efforts that provide infrastructure to support spacecraft navigation and Earth orientation measurements.
2. Time and Earth Motion Precision Observations (TEMPO), which measures Earth orientation parameters based on single baseline semi-monthly measurements. These VLBI measurements are then combined with daily GPS measurements as well as other sources of Earth orientation information. The

---

Jet Propulsion Laboratory, California Institute of Technology

JPL Analysis Center

IVS 2013 Annual Report

combined product provides Earth orientation for spacecraft navigation.

3. Delta differenced one-way range ( $\Delta$ DOR), which is a differential VLBI technique that measures the angle between a spacecraft and an angularly nearby extragalactic radio source. This technique thus complements the radial information from spacecraft doppler and range measurements by providing plane-of-sky information for the spacecraft trajectory.

## 2 Technical Capabilities

The JPL Analysis Center acquires its own data and supplements it with data from other centers. The data we acquire are taken using NASA's Deep Space Network (DSN).

1. Antennas: Most of our work uses 34-m antennas located near Goldstone (California, USA), Madrid (Spain), and Tidbinbilla (Australia). These include the following Deep Space Stations (DSS): the "High Efficiency" subnet comprised of DSS 15, DSS 45, and DSS 65 which has been the most often used set of JPL antennas for VLBI. More recently, we have been using the DSN's beam waveguide (BWG) antennas: DSS 13, DSS 24, DSS 25, DSS 26, DSS 34, DSS 54, and DSS 55. Less frequent use is made of the DSN's 70-m network (DSS 14, DSS 43, and DSS 63). Typical X-band system temperatures are 35K on the HEF antennas. The 70-m and BWGs are about 20K. Antenna efficiencies are typically well above 50% at X-band.

2. Data acquisition: We use ROACH-based Digital Back Ends with Mark 5C VLBI recorders. These units are now in the field and are expected to become fully operational in 2014. In addition, we have JPL-unique systems called the VLBI Science Recorder (VSR) and the Wideband VSRs (WVSR) which have digital baseband converters and record directly to hard disk. The data are later transferred via network to JPL for processing with our software correlator.
  3. Correlators: The JPL VLBI Correlator has been exclusively based on the SOFTC software which handles the  $\Delta$ DOR, TEMPO, and CRF correlations as well as tests of antenna arraying.
  4. Solution types: We run several different types of solutions. For  $\Delta$ DOR spacecraft tracking we make narrow field ( $\approx 10^\circ$ ) differential solutions. The TEMPO solutions typically have a highly constrained terrestrial (TRF) and celestial frame (CRF) as a foundation for estimating Earth orientation parameters. These reference frames are produced from global solutions which then provide the framework needed for use by TEMPO and  $\Delta$ DOR.
- Walid Majid: pulsars,  $\Delta$ DOR, and VLBA phase referencing.
  - Chuck Naudet: NASA-ESA southern declination collaboration and source stability studies.
  - Andres Romero-Wolf:  $\Delta$ DOR, CRF and TRF. MODEST scripts. Source stability studies.
  - Lawrence Snedeker: Goldstone data acquisition. NASA-ESA southern declination collaboration.
  - Ojars Sovers: S/X, and X/Ka CRFs and TRF. Maintains MODEST analysis code.
  - Alan Steppe: TEMPO and TRF.

### 3 Staff

Our staff are listed below along with areas of concentration. Note that not all of the staff listed work on VLBI exclusively as our group is involved in a number of projects in addition to VLBI.

- Durgadas Bagri: TEMPO and Ka-band phase calibrators.
- James Border:  $\Delta$ DOR spacecraft tracking.
- Cristina García-Miró: Madrid data acquisition, NASA-ESA southern declination collaboration, and educational outreach.
- Shinji Horiuchi: Canberra data acquisition and NASA-ESA southern declination collaboration.
- Chris Jacobs: NASA-ESA southern declination collaboration, X/Ka CRF, TRF, and S/X CRF.
- Christina King: source stability studies.
- Peter Kroger:  $\Delta$ DOR spacecraft tracking.
- Gabor Lanyi: MODEST, Fringe fitting and correlation support,  $\Delta$ DOR, and TRF.
- Steve Lowe: Software correlator, fringe fitting software, and  $\Delta$ DOR.

### 4 Current Status and Activities

The TEMPO task's EOP measurements continue. Our S/X CRF work is being downsized in favor of X/Ka-band (8.4/32 GHz) CRF which continues to make major strides forward. In particular, in 2013, ESA's Malargüe, Argentina antenna became a regular part of our Ka-band network adding much needed southern coverage, and DSN operations moved to 1024 to 2048 Mbps.

VLBI spacecraft tracking continues to provide measurements of angular position in support of mission navigation and planetary ephemeris development. The New Horizons trajectory toward Pluto was verified with a series of Delta-DOR measurements in June-August 2013. Delta-DOR data were used to assure the Earth-flyby targeting for Juno in October 2013. Dawn is being supported with Delta-DOR during its low thrust cruise from Vesta to Ceres. Monthly Delta-DOR measurements of MRO and Mars Odyssey continue to improve the ephemeris of Mars. Delta-DOR measurements have begun on both the NASA mission Maven and the ISRO mission MOM to support navigation during their cruise to Mars.

### 5 Future Plans

In 2014, we hope to improve our VLBI system by making our Digital Back End, the DVP, compatible with the JIVE and DiFX correlators, thereby enabling broader calibrations. We hope to deploy operational Ka-band phase calibrators at our overseas sites. We expect the combined NASA-ESA deep space network to reach

sub-nanoradian (200  $\mu$ as) Ka-band CRF results over the south polar cap ( $-90^\circ < \delta < -45^\circ$ ). On the spacecraft front, we plan to continue supporting a number of operational missions while further improving techniques for using VLBI for spacecraft tracking.

## Acknowledgements

Research described herein done in part at the Jet Propulsion Laboratory, California Institute of Technology under contract with the National Aeronautics and Space Administration. Government sponsorship acknowledged. Copyright ©2014. All Rights Reserved.

## References

1. A. Bertarini, A de Witt, C.S. Jacobs, J. McCallum, T. Jung, J. Quick, S. Horiuchi, J. Lovell, B. Won Sohn, R. Ojha, 'Extending the K-band Celestial Frame with Emphasis on the Southern Hemisphere,' Journées Systèmes de Référence Spatio-Temporels, Paris, 16 Sept. 2013.  
[syrtel.obspm.fr/journees2013/powerpoint/bertarini\\_jsr13.pdf](http://syrtel.obspm.fr/journees2013/powerpoint/bertarini_jsr13.pdf)
2. David W. Curkendall and James S. Border, 'Delta-DOR: The One-Nanoradian Navigation Measurement System of the Deep Space Network: History, Architecture, and Componentry,' Interplanetary Network Progress Report, vol. 42-193, Jet Propulsion Laboratory, Pasadena, CA, pp. 1-46, May 15, 2013.  
[http://ipnpr.jpl.nasa.gov/progress\\_report/42-193/193D.pdf](http://ipnpr.jpl.nasa.gov/progress_report/42-193/193D.pdf)
3. A. de Witt, A. Bertarini, C.S. Jacobs, J. McCallum, T. Jung, J. Quick, S. Horiuchi, J. Lovell, B. Won Sohn, R. Ojha, 'Experimental plan for improving the K-band Celestial Frame,' Journées Systèmes de Référence Spatio-Temporels, Paris, 16 Sept. 2013.  
[syrtel.obspm.fr/journees2013/powerpoint/dewitt\\_poster\\_jsr13.pdf](http://syrtel.obspm.fr/journees2013/powerpoint/dewitt_poster_jsr13.pdf)
4. R. Gaume, C.S. Jacobs, and ICRF-3 working group, ICRS Product Center and IAU ICRF-3 WG Update, IERS directing board meeting #57, San Francisco, 8 Dec 2013.
5. R. Heinkelmann, C.S. Jacobs and ICRF-3 working group 'The ICRF-3: A Proposed Roadmap to the next generation International Celestial Reference Frame,' IAG, Potsdam, Germany, 1-6 Sept 2013.  
[http://www.iag2013.org/IAG\\_2013/Potsdam.html](http://www.iag2013.org/IAG_2013/Potsdam.html)
6. S. Horiuchi, J.E. Clark, C. García-Miró, C.S. Jacobs, R. Maddè, M. Mercolino, L.G. Snedeker, I. Sotuela, L.A. White 'X/Ka Celestial Frame,' Asia-Pacific Radio Science Conference, Tapei, Taiwan, 3-7 Sept. 2013.  
<http://aprasc13.ntu.edu.tw/Program2/AdvanceProgram.asp#J1b>
7. C.S. Jacobs, 'Celestial Reference Frames,' overview lecture for the 1st EVGA School, Aalto University, Otaniemi, Espoo, Finland, 5 March 2013.  
[http://www.evga.org/teaching/VLBI\\_school\\_2013/VLBI\\_school-2013\\_16\\_Jacobs.pdf](http://www.evga.org/teaching/VLBI_school_2013/VLBI_school-2013_16_Jacobs.pdf)
8. C.S. Jacobs, J.E. Clark, J. de Vicente, M. Dugast, C. García-Miró, C.E. Goodhart, S. Horiuchi, S.T. Lowe, R. Maddè, M. Mercolino, C.J. Naudet, L. G. Snedeker, I. Sotuela, L.A. White, 'Extending the X/Ka Celestial Reference Frame to the South Polar Cap: Results from Combined NASA-ESA Baselines to Malargüe, Argentina,' 21st EVGA Symposium, Espoo, Finland, 7 March 2013.  
[http://evga.fgi.fi/sites/default/files/u3/Jacobs\\_XKa\\_EVGA-2013.pdf](http://evga.fgi.fi/sites/default/files/u3/Jacobs_XKa_EVGA-2013.pdf)  
<http://adsabs.harvard.edu/abs/2013evga.confE...1J>
9. C.S. Jacobs, J. Böhm, P. Charlot, and the joint IAU ICRF-3 working group and IAG sub-commission 1.4 'ICRF-3: An Assessment of Needs and Plans for the Future,' ICRF-3 joint IAU/IAG splinter meeting to 21st EVGA Symposium, Espoo, Finland, 7 March, 2013.  
<http://evga.fgi.fi/node/9>
10. C.S. Jacobs, R. Gaume, C. Ma, and ICRF-3 working group, 'ICRF-3 Overview,' IERS Directing Board Retreat, Paris, France, 23 May 2013
11. C.S. Jacobs and the ICRF-3 working group, 'The ICRF-3: Proposed Roadmap to the Next Generation International Celestial Reference Frame,' Journées Systèmes de Référence Spatio-Temporels, Paris, 16 Sept. 2013.  
[http://syrtel.obspm.fr/journees2013/powerpoint/jacobs\\_jsr13.pdf](http://syrtel.obspm.fr/journees2013/powerpoint/jacobs_jsr13.pdf)
12. C.S. Jacobs, 'Celestial Reference Frames,' Journées 2013, Tutorial session, Paris, 15 Sept 2013.  
[syrtel.obspm.fr/jsr/journees2013/powerpoint/Tutorial\\_CRF\\_Jacobs\\_jsr13.pdf](http://syrtel.obspm.fr/jsr/journees2013/powerpoint/Tutorial_CRF_Jacobs_jsr13.pdf)
13. M. Soriano, C. Jacobs, R. Navarro, C. Naudet, S. Rogstad, L. White, S. Finley, C. Goodhart, E. Sigman, J. Trinh, J. Lobo Garcia, C. García-Miró, M. Mercolino, R. Maddè, 'Improved Spacecraft Tracking and Navigation Using a Portable Radio Science Receiver,' IEEE, Big Sky Montana, 2-9 March 2013.  
doi: 10.1109/AERO.2013.6496851  
<http://adsabs.harvard.edu/abs/2013aero.confE...1S>  
<http://ieeexplore.ieee.org/stamp/stamp.jsp?tp=&arnumber=649685>

# KASI Combination Center 2013 Annual Report

Younghee Kwak, Jungho Cho

**Abstract** This report presents the activities of the Korea Astronomy and Space Science Institute (KASI) Combination Center during 2013 and outlines the planned tasks for 2014. In 2013, we focused on coordinate time series and a VLBI terrestrial reference frame using seven-year IVS products. During the combination using Bernese GNSS Software Version 5.0, we found restrictions on combining products. We report those and desirable features.

## 1 General Information

KASI is a government-funded research institute for Astronomy and Space Science. Thus, it has a wide range of research areas observing the Earth, the Sun, stars, and galaxies based on various instruments. For Earth observation, space geodesy is one of the important research fields of KASI. KASI operates GNSS, VLBI, and SLR stations and analyzes their observation data.

## 2 Component Description

KASI is in charge of operating an IVS Combination Center. KASI has rich experience in GNSS data processing and analysis using Bernese GNSS Software (hereafter Bernese). Bernese, especially the subprogram ADDNEQ2, supports stacking of normal equations and estimation of parameters [1]. We adopted

Bernese to combine the sessionwise VLBI products of the IVS Analysis Centers (ACs) at the normal equation level. We modified the software, which was developed for GNSS data processing and analysis, to handle IVS products properly. The inputs to Bernese are the normal equation matrices and vectors from the daily SINEX files of the individual ACs (Table 1). The outputs are daily SINEX files including combined station coordinates and Earth orientation parameters (EOPs). The missions of the KASI Combination Center are creation of high quality combination products, mutual verification with the BKG/DGFI Combination Center, quality control of the ACs' results, provision of feedback to the Analysis Centers, and adherence to the IERS Conventions.

**Table 1** IVS ACs which KASI combined.

AC	Time span	Software	Number of sessions
BKG	2003.0-2010.0	CALC/SOLVE	938
DGFI	2003.0-2010.0	OCCAM	891
GSFC	2003.0-2010.0	CALC/SOLVE	939
OPA	2003.0-2010.0	CALC/SOLVE	928
USNO	2003.0-2010.0	CALC/SOLVE	802

## 3 Staff

The staff members of the KASI Combination Center are listed below.

Korea Astronomy and Space Science Institute

KASI Combination Center

IVS 2013 Annual Report

**Table 2** Personnel of the KASI Combination Center.

Jungho Cho	+82-42-865-3234	jojh@kasi.re.kr
* Younghee Kwak	+82-42-865-2031	bgirl02@kasi.re.kr

\* until March 21, 2014

## 4 Current Status and Activities

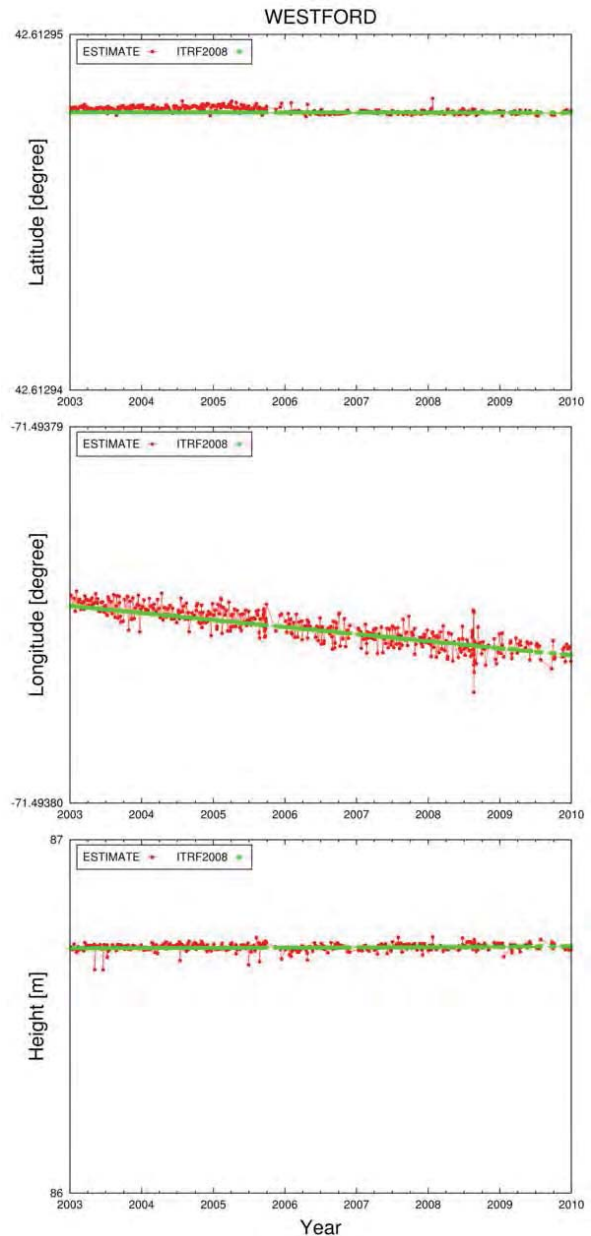
### (1) Coordinate Time Series

The station position coordinates for each session were combined and estimated using the normal equations of each IVS AC summarized in Table 1 in order to verify the VLBI combination capability of Bernese. In total, 43 station coordinates were estimated. Figures 1, 2 and 3 show the examples of the time series for the latitude, longitude, and height of three of the 43 stations (Westford, Wettzell, and Kokee). In the figures, the red (darker) line represents the estimated values, and the green (lighter) line shows the a priori values based on ITRF2008. In each plot, a single tick mark of the vertical axis corresponds to about 1 m. It is obvious that the errors of the longitude components are relatively larger than those of the latitude and height components. For 43 stations, the root mean square (RMS) errors of the latitude and longitude components are 15.6 mm and 37.7 mm, respectively, and the error of the height component is 30.9 mm, with respect to ITRF2008 (a priori value).

Most VLBI results provide UT1-TAI values, while Bernese, which is the software for GNSS, can process only UT1-UTC values at the moment. For the normal equations of some ACs (BKG, GSFC, OPA, and USNO), which were entered in the software, the difference (leap seconds) between the UT1-TAI and UT1-UTC values was included. UT1 is a parameter that represents the rotation of the Earth, and it is correlated with longitude that has the same direction. Consequently, the UT1 errors of some ACs were included in the results of the longitude, and thus the longitude component showed a larger RMS error than the latitude and height components. In the future, the software needs to be improved regarding UT1 correction.

### (2) VLBI TRF

We estimated TRF by combining the normal equations of five ACs (Table 1) during seven years (2003-



**Fig. 1** Coordinate time series of Westford during 2003-2009.

2009) as one normal equation. Figure 4 shows the velocity vectors of the combined TRF (red arrows) by KASI and the ITRF2008 (blue arrows). ITRF2008 is the result that combined the data from the four space geodetic techniques (GNSS, VLBI, SLR, and DORIS) which had been accumulated for 25 years (1984-2008). Thus, the stations, which had performed observations up to 2003, exist only on ITRF2008. The YEBES sta-

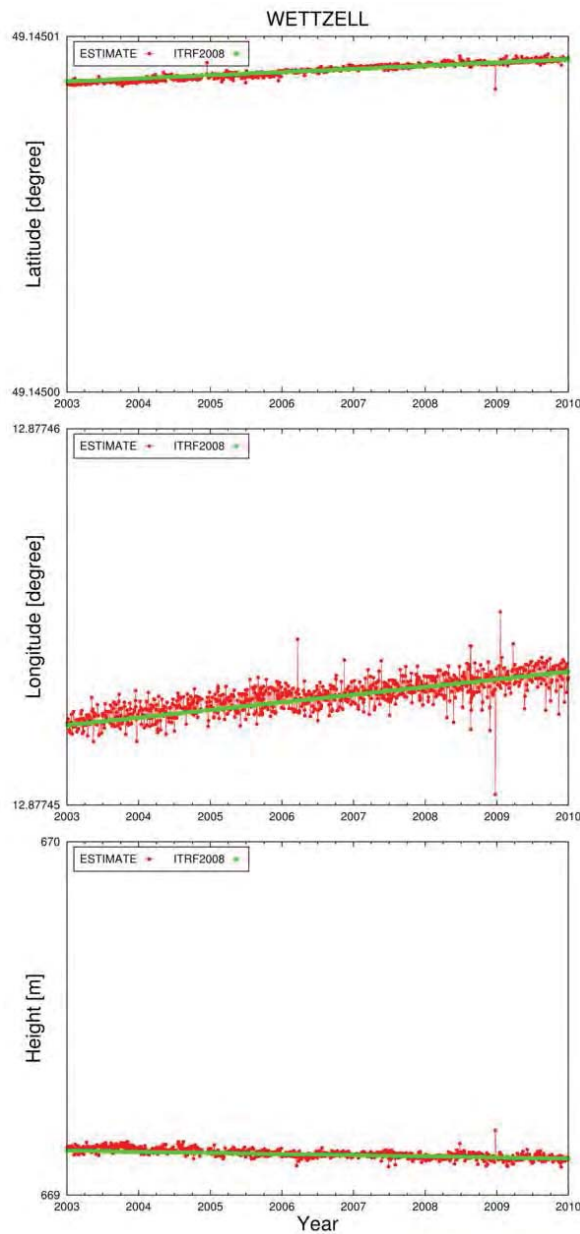


Fig. 2 Coordinate time series of Wetzell during 2003-2009.

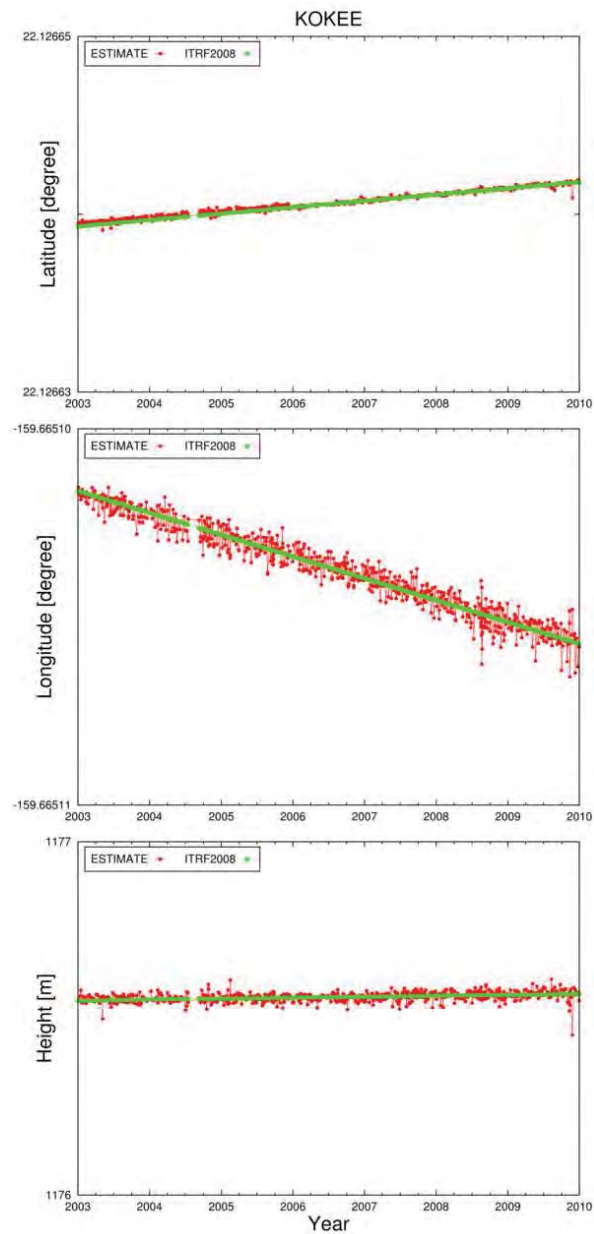
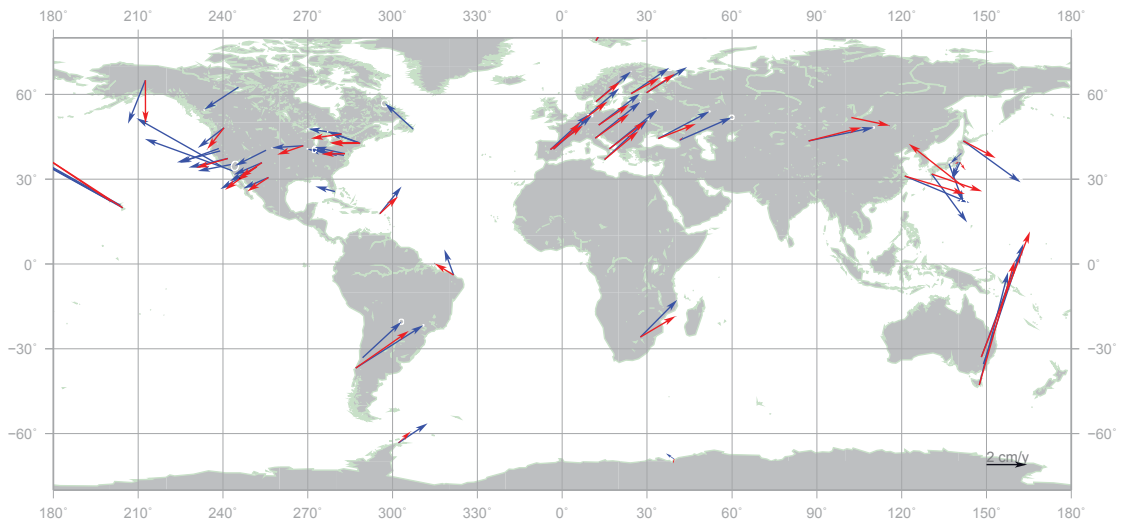


Fig. 3 Coordinate time series of Kokee during 2003-2009.

tion in Spain dismantled the 14-m antenna that had been used from 1995 to 2003. Accordingly, as for the data from the YEBES station used for the combined TRF, the observation period was very short (less than one year), and thus the estimation of a proper velocity vector was not available. Therefore, it had a completely different magnitude and direction, compared to the velocity vector from ITRF2008, and it was excluded from

Figure 4. The velocity vector of the remaining 42 stations excluding the YEBES station showed a magnitude difference of 7.3 mm/yr (30.2%) and a direction difference of  $13.8^\circ$  (3.8%), with respect to ITRF2008. Those errors are thought to be due to the longitude component error mentioned above. As there is a large error in the longitude component, the Helmert transformation, which represents the relation between TRFs, is





**Fig. 4** Velocity map of ITRF2008 (blue/slightly darker) and combined TRF (red) by KASI.

not meaningful at the moment. Thus, it was not considered in this report.

## 5 Future Plans

In 2014 and beyond, we will focus on the following tasks:

- Proper UT1 correction in Bernese
- Combining whole period IVS products (1984-present)
- Outlier rejection
- Weighting the individual solutions
- Comparing with BKG/DGFI Combination Center [2], IERS 08C04 [3], and IGS solutions [4]
- Providing IVS EOP format solutions [2] (Rapid and Quarterly)
- Providing VLBI TRF

## References

1. Dach, R., Hugentobler, U., Fridez, P., and Meindl, M. (eds.), *Bernese GPS Software Version 5.0 User manual*, Astronomical Institute, University of Bern, 2007
2. <http://ccivs.bkg.bund.de>  
BKG/DGFI Combination Center Web page
3. <http://hpiers.obspm.fr/eop-pc>  
IERS Earth Orientation Center Web page
4. <http://igsceb.jpl.nasa.gov/components/prods.html>  
IGS Products Table

# KTU-GEOD IVS Analysis Center Annual Report 2013

Emine Tanır Kayıkçı<sup>1</sup>, Kamil Teke<sup>1,2</sup>

**Abstract** This report summarizes the activities of the KTU-GEOD IVS Analysis Center (AC) in 2013 and outlines the planned activities for the year 2014. Determination of optimal weights of constraints on VLBI auxiliary parameters as well as estimation interval lengths have been our specific interests in 2013.

**Table 1** Staff.

Name	Working Location
Emine Tanır Kayıkçı	Karadeniz Technical University, Dept. of Geomatics Engineering, Trabzon, Turkey.
Kamil Teke	Hacettepe University, Dept. of Geomatics Engineering, Ankara, Turkey.

## 1 General Information

KTU-GEOD IVS Analysis Center (AC) is located at the Department of Geomatics Engineering, Karadeniz Technical University, Trabzon, Turkey.

## 2 Staff at KTU-GEOD Contributing to the IVS Analysis Center

The staff who are contributing to the research at the KTU-GEOD IVS Analysis Center (AC) in 2013 are listed in Table 1 with their working location.

## 3 Current Status and Activities

During 2013, we focused on determining estimation intervals and the optimal weights of constraints on

1. Karadeniz Technical University, Department of Geomatics Engineering

2. Hacettepe University, Department of Geomatics Engineering

KTU-GEOD Analysis Center

IVS 2013 Annual Report

the estimated VLBI auxiliary parameters. The main part of this study was conducted during the research stay of AC member Dr. Tanır Kayıkçı at Helmholtz-Zentrum Potsdam Deutsches GeoForschungsZentrum GFZ from July to September 2013. The first results of this study were presented at the International Association of Geodesy (IAG) Scientific Assembly held at Potsdam from 1st to 6th of September 2013 [4]. The proceedings paper of this report was submitted to the International Association of Geodesy Symposia Series (still under review process).

The variety of the parameterizations in VLBI analysis causes significant differences in the estimates even if the same observations (sessions) are involved (c.f. [2]). The space geodetic technique specific parameters in a least-squares adjustment are not standardized — e.g., several reduction models are recommended by the IERS Conventions 2010 ([3]). The current version of Vienna VLBI Software (VieVS, [1]) in the least-squares adjustment mode uses a standard parameterization for the auxiliary parameters, i.e., a piece-wise linear offset representation with a default temporal resolution of e.g. 60 minutes for clocks and zenith wet delays (ZWD) and six hours for troposphere horizontal north and east gradients (NGR and EGR). From the physical point of view, the interval length should be

as short as possible to optimally represent the behaviors of the underlying processes: from the mathematical point of view, however, the interval length should be long enough to achieve an appropriate redundancy of observations required to obtain a stable (regular) normal equation system. In this study, three different approaches are investigated for achieving optimized parameterizations of the auxiliary parameters per station for each session. The performance of the three approaches is investigated by analyzing VLBI data with the least-squares adjustment model of VieVS.

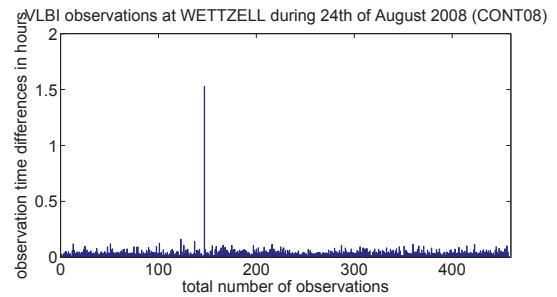
### 3.1 Approach1: Solution Intervals Considering the Time Dependent Behaviours of the Parameters

In the standard VLBI least-squares solution, the estimation intervals of the auxiliary parameters are usually set to be constant for the sake of simplicity, because there is no a priori information about the variability of the modelled phenomena, e.g. troposphere. Consequently, our first optimization (*approach1*) realizes the idea of a flexible parameter estimation interval depending on the behavior of the parameters determined with a prior estimation featuring an equally spaced standard parameterization. Thus, if the variation is relatively large, the parameter estimation interval will be decreased to allow for a larger degree of freedom for this specific parameter over an appropriate duration. With this approach it is possible to flexibly handle the parameter estimation interval according to a first standard solution while keeping the overall number of parameters constant. It would also be possible to repeat the application of *approach1* in an iterative way whenever the session is reanalyzed. This iterative optimization will be considered in future, but it is not treated in this report.

### 3.2 Approach2: Solution Intervals Considering Data Gaps

There is a usual time difference of several minutes or more between successive VLBI observations. A significant number of VLBI sessions show gaps between successive observations at certain stations. For exam-

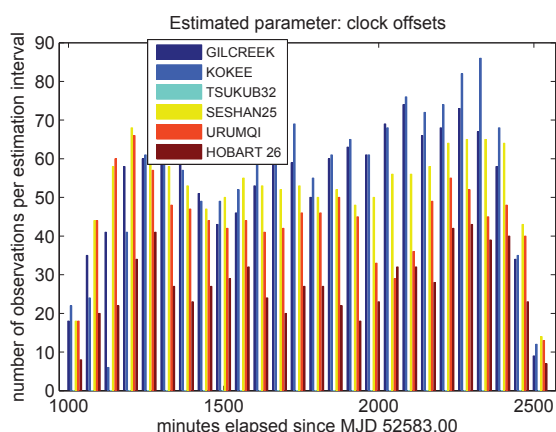
ple, during the CONT08 session WETTZELL stopped and performed an Intensive VLBI session of about one hour duration together with another network station (see Figure 1). In our investigation, we consider a time difference of at least 45 minutes between successive observations at a station as a data gap. With our second approach (*approach2*), in the case of a data gap between observations, our method considers the observation data in two subsets, the one before and the one after the data gap while leaving the data gap empty.



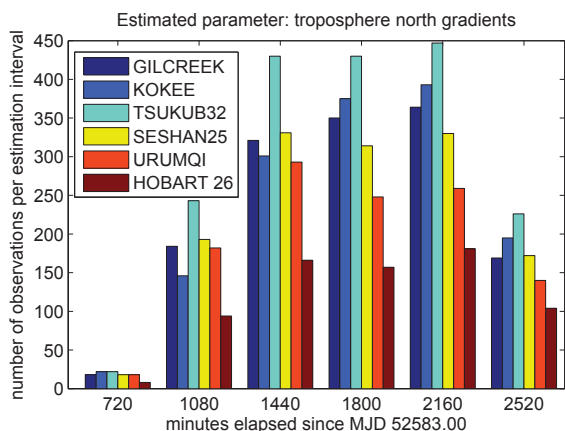
**Fig. 1** Time differences in hours between successive observations at station WETTZELL during a daily CONT08 session, 08AUG24.

### 3.3 Approach3: Solution Intervals Considering the Total Number of Observations

We determine the estimation intervals depending on the number of observations in our third approach (*approach3*). This approach ensures an equal redundancy for each auxiliary parameter. Figures 2 and 3 show how much the total number of observations supporting an auxiliary parameter can vary, in the case of having equally spaced time intervals for auxiliary parameter estimation by the standard parameterization. The number and geometry of observations in equally spaced estimation intervals of a VLBI station, specific parameter should be optimized when, for example, scheduling a session or the estimation intervals for a specific parameter at each antenna should be optimized considering the number and geometry of observations when analyzing a session.



**Fig. 2** Total number of observations per clock offset estimation interval: 60 minutes (as a standard parameterization) during session 02NOV05.



**Fig. 3** Total number of observations per troposphere gradient offset estimation interval: 360 minutes (as a standard parameterization) during session 02NOV05.

## 4 Future Plans

Our preliminary results show that *approach1* and *approach3* provide better results for VLBI single session analysis than the standard parameterization. The next step will be to practically assess the *approach2*. Thereafter we will develop an optimized parameterization for auxiliary parameters in VLBI single session least-squares analysis probably based on all three approaches.

## Acknowledgements

We are thankful to all the Directing Board of IVS. We are grateful to Karadeniz Technical University for their financial support of KTU-GEOD IVS AC research activities. One of the co-authors, Emine TANIR KAYIKÇI, acknowledges Council of Higher Education of Turkey (YOK) for the financial support of her research stay at GFZ.

## References

1. J. Böhm, S. Böhm, T. Nilsson, A. Pany, L. Plank, H. Spicakova, K. Teke, H. Schuh, The new Vienna VLBI Software VieVS. Geodesy for Planet Earth, Proceedings of the 2009 IAG Symposium, Buenos Aires, Argentina, 31 August – 4 September 2009, *International Association of Geodesy Symposia Series*, 136, 1007–1011, edited by Steve Kenyon, Maria Christina Pacino, Urs Marti.
2. R. Heinkelmann, J. Böhm, S. Bolotin, G. Engelhardt, R. Haas, R. Lanotte, D. S. MacMillan, M. Negusini, E. Skurikhina, O. Titov, H. Schuh, VLBI-derived troposphere parameters during CONT08, *Journal of Geodesy*, 85, 7, 377–393.
3. G. Petit, B. Luzum, IERS Conventions 2010, IERS Technical Note 36, Frankfurt am Main: Verlag des Bundesamts für Kartographie und Geodäsie, 179, ISBN 3-89888-989-6.
4. E. Tanır Kayıkçı, R. Heinkelmann, M. Karbon, T. Nilsson, V. Raposo-Pulido, B. Soja, H. Schuh, Optimal size of constraints and interval lengths for VLBI auxiliary parameters, *IAG Scientific Assembly 2013*, September 1-6, 2013, Potsdam.

# Analysis Center at National Institute of Information and Communications Technology

Thomas Hobiger, Mamoru Sekido

**Abstract** This report summarizes the activities of the Analysis Center at National Institute of Information and Communications Technology (NICT) for 2013.

- KONDO Tetsuro (Bangkok, Thailand and Kashima): software correlator development
- SEKIDO Mamoru (Kashima): development of VLBI systems, coordination of activities

## 1 General Information

The NICT Analysis Center is operated by the space-time standards group of NICT and is located in Kashima, Ibaraki; its headquarters are in Koganei, Tokyo. The Analysis Center focuses on the processing of VLBI experiments which are related to NICT's research goals. Effort is spent on developing new VLBI technology for time and frequency transfer, the development of a modern multi-technique analysis software package, prototyping of a compact VLBI system, real-time EOP determination, and atmospheric path delay studies.

## 2 Staff

Members who are contributing to the Analysis Center at the NICT are listed below (in alphabetical order, with working locations in parentheses):

- HOBIGER Thomas (Koganei, Tokyo): analysis software development and atmospheric modeling
- ICHIKAWA Ryuichi (Koganei, Tokyo): coordination of activities

---

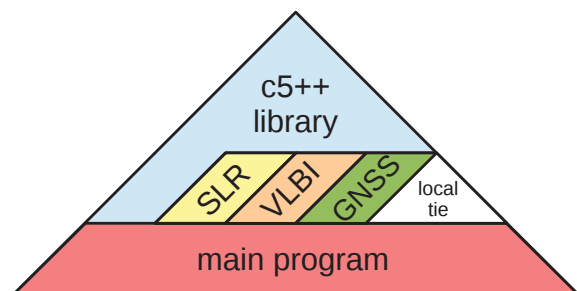
NICT, Japan

NICT Analysis Center

IVS 2013 Annual Report

## 3 Activities during the Past Year

### 3.1 Development of a Multi-technique Space-geodetic Analysis Software Package



**Fig. 1** The basic concept of c5++ allows processing of single- and multi-technique space geodetic observations by taking advantage of the usage of identical geophysical models (from [4]).

Driven by the need to update existing space geodetic analysis software and motivated by the demanding goals of GGOS, a new analysis package named “c5++” was developed. In contrast to the prior version, which was written in Java, the new software was coded in C++, which led to its naming. In doing so, the software was designed to support combination of space geodetic data from Satellite Laser Ranging (SLR), VLBI,

and Global Navigation Satellite System (GNSS) on the observation level, but it also enables processing of single-technique solutions. VLBI, GNSS, and SLR modules (see Figure 1) share the same library, which contains all geophysical models according to the latest IERS Conventions. In addition, local tie information can be included as virtual observations which relate between technique-specific reference points. The library also provides interfaces to various space geodetic data formats, enables reading/writing of SINEX files, and supports all necessary mathematical functions for the parameter adjustment process. *c5++* does not have a graphical user interface (GUI) but is called directly from the command line and controlled via a configuration file. In the current version of *c5++*, a Gauss-Markov model is used for the least-squares adjustment; however, a Kalman filter is expected to be implemented in the future as well.

*c5++* was compared against other software packages [6] and is currently being used by the Geospatial Information Authority of Japan (GSI) for ultra-rapid determination of UT1 (see section 3.3 and [1]) on a routine basis.

In contrast to combination of space geodetic results where parameters are derived individually from each technique, combination of all available space geodetic observations on the observation level is expected to obtain more robust parameters. Outliers are less likely to bias the solution as data from other techniques helps to identify such data artifacts. Moreover, weaknesses of one technique can be compensated by adding a second technique, improving geometrical coverage and stabilizing the estimation of parameters which otherwise would depend on observations from that single technique. In order to demonstrate the capability of the software to combine data at the observation level, SLR and VLBI observations were processed together, with the goal of studying site motions at TIGO and revealing the benefits of this approach [3]. In doing so, it could be demonstrated that the coordinate time series before the Chile 2011 earthquake derived from the combined solution has less scatter than either of the two single-technique solutions (see Figure 2).

In addition to local tie information, site-wise common parameters, i.e. troposphere and clocks, can be estimated when microwave based techniques are combined on the observation level. [4] discusses how common parameters between GNSS and VLBI have to be estimated and where biases/offsets need to be taken

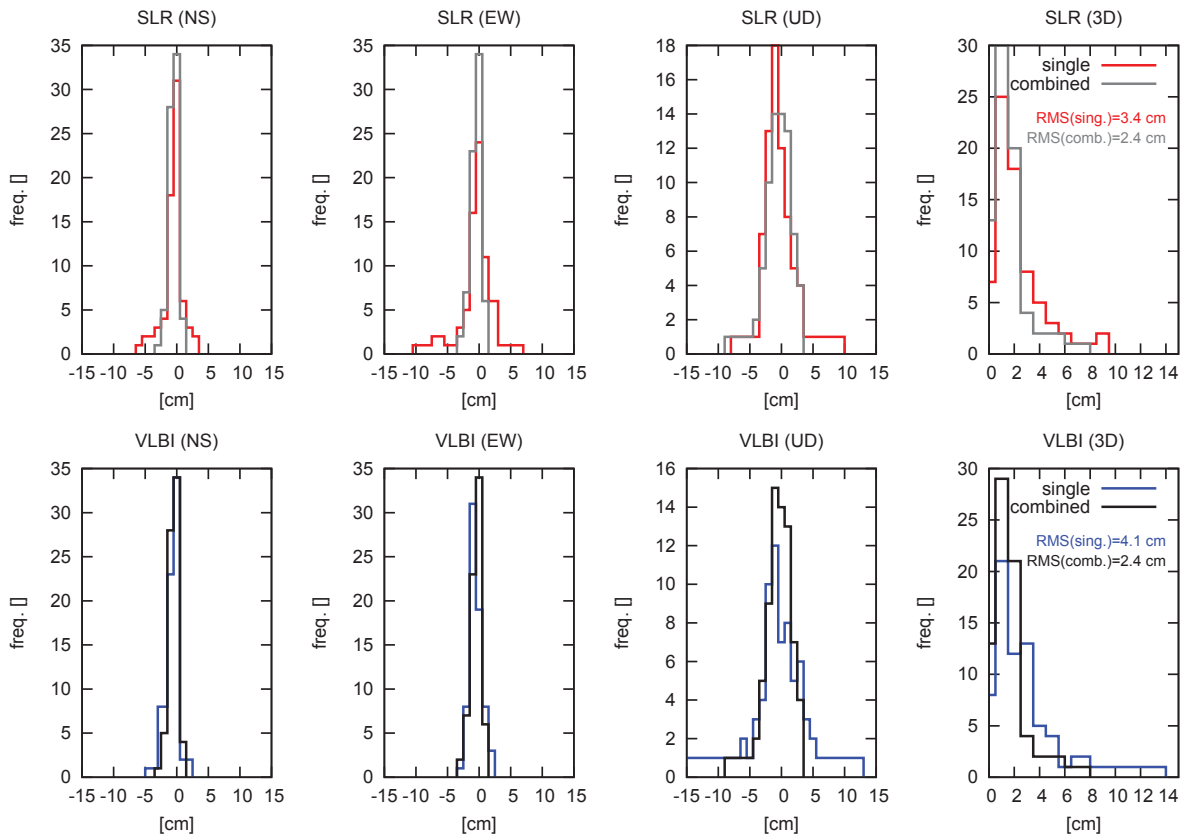
into account. In order to test this concept, GPS and VLBI data from the CONT11 campaign were utilized. Obtained results show that the combination of space geodetic data on the observation level leads to a consistent improvement of station position repeatability and Earth orientation parameters as well as nuisance parameters like troposphere estimates. Furthermore, estimation of common parameters (troposphere or clocks) at co-located sites helps to improve the solution further and derive an utmost physically consistent model of the concerned parameters (see details in [4]).

### **3.2 Frequency Transfer by Means of VLBI**

Space geodetic techniques like GNSS have been proven to be a useful tool for time and frequency transfer purposes. Besides SLR, which is currently tested under the name T2L2, VLBI could be another space geodetic technique that can be utilized for frequency transfer. In contrast to GNSS, VLBI does not require any orbital information as it directly refers to an inertial reference frame defined by the location of the quasi stellar objects. As summarized by [7], current VLBI systems can provide a frequency link stability of about  $2 \times 10^{-15}$  @ 1d (ADEV). NICT's Space-Time Standards Laboratory is working on the realization of a frequency transfer system based on the principles of VLBI, whereas developments from the upcoming geodetic VLBI2010 system are expected to help to reach these goals. Our new analysis software (see prior section) is ready to combine VLBI and GNSS data on the observation level and thus support the efforts of this project.

### **3.3 Ultra-rapid EOP Experiments**

Geospatial Information Authority of Japan (GSI), Onsala Space Observatory, University of Tasmania, and the Hartebeesthoek Radio Astronomy Observatory carried out several ultra-rapid EOP experiments which were automatically analyzed with *c5++*. The analysis process was adopted to handle automated ambiguity resolution of a multi-baseline session and allow for a robust estimation of the three EOP components. First results demonstrated that all three EOPs can be esti-



**Fig. 2** Histograms of the detrended coordinate time series of the single technique and combined solutions between January 1, 2008 and March 10, 2008 (i.e. the occurrence of the Chile 2010 earthquake) as discussed in [3].

mated from such a dedicated ultra-rapid observation network. However, given the weak geometry of the network and the rather low number of observations, it is not clear whether the current observation strategy is sufficient for an accurate and reliable determination of all three EOP components. In addition to these dedicated ultra-rapid experiments, GSI regularly submits UT1 results automatically processed by `c5++` from INT2 sessions on an operational basis (see [1] for details on the processing strategy).

### 3.4 Ray-traced Troposphere Slant Delay Correction for Space Geodesy

Kashima Ray-tracing Tools (KARAT) is a software package that is capable of transforming numerical weather model data sets to geodetic reference frames,

computing fast and accurate ray-traced slant delays, and correcting geodetic data on the observation level. A recent comparison [8] of troposphere delays from space geodetic techniques, water vapor radiometers, and numerical weather models confirmed the ray-tracing concept but made clear that one requires accurate numerical weather models in order to compute a realistic refractivity field around space geodetic instruments.

In addition, KARAT was extended to support frequency dependency of the refractivity in the microwave domain following the Liebe model [5]. By the use of this model, it is possible to compute the complex refractivity based on atmosphere quantities like pressure, temperature and relative humidity. Using these new features, it was studied whether modern space-geodetic microwave techniques (including VLBI2010 and higher dual-frequency VLBI configurations) should be corrected for dispersive

troposphere delays. Although the frequency dependent delay contribution appears to be of small order, one has to consider that signals are propagating through a range of a few kilometers of troposphere at high elevations to hundredths of kilometers at low elevations. Thus, it has been investigated whether such an effect has a magnitude above the noise floor of modern space-geodetic instruments or whether it can be safely neglected. The frequency dependent KARAT module was also utilized for the development of a semi-empirical correction model for the microwave link of the Atomic Clock Ensemble in Space (ACES) [2].

In addition, a model for optical (laser) techniques is currently being implemented in order to support all space geodetic techniques, including SLR.

#### 4 Future Plans

For 2014, the plans of the Analysis Center at NICT include:

- Combination of multi-technique space-geodetic data on the observation level with c5++
- Implementation of an interface for c5++, which allows reading and creation of OpenDB data
- Time and frequency transfer experiments by VLBI and combination with other techniques like GNSS or Two-Way Satellite Time and Frequency Transfer (TWSTFT)
- Usage of multi-processors and multi-core processing platforms for the acceleration of space geodetic applications

#### Acknowledgements

Parts of this work were supported by a Grant-in-Aid for Young Scientists B (No.25740011). Design and implementation of c5++ was a huge effort, requiring the participation and support of many individuals.

#### References

1. T. Hobiger, T. Otsubo, M. Sekido, T. Gotoh, T. Kubooka, and H. Takiguchi, Fully automated VLBI analysis with c5++ for ultra-rapid determination of UT1, *Earth, Planets, Space*, 45, 2, 75–79, 2010.
2. T. Hobiger, D. Piester, and P. Baron, A correction model of dispersive troposphere delays for the ACES microwave link, *Radio Science*, 48(2), 131–142, 2013.
3. T. Hobiger, T. Otsubo, and M. Sekido, Combination of space geodetic observations from SLR and VLBI on the observation level with c5++, *Adv. in Space Research*, 53(1), 119–129, doi:10.1016/j.asr.2013.10.004, 2014.
4. T. Hobiger and T. Otsubo, Combination of GPS and VLBI on the observation level during CONT11 - common parameters, ties and inter-technique biases, *under review*, 2014.
5. H.J. Liebe, MPM-An atmospheric millimeter-wave propagation model, *Int. J. Infrared and Millimeter Waves*, 10, 631–650, 1989.
6. L. Plank, J. Boehm, and H. Schuh (2011), DeDeCC - Comparison of VLBI data analysis software - results; *12th IVS Analysis Workshop, March 31, 2011, Bonn, Germany*, 2011.
7. C. Rieck, R. Haas, R.T.K. Jaldehag, and J.M. Johansson, VLBI time-transfer using CONT08 data, *Proceedings of the 6th IVS General Meeting*, 365-369, 2010.
8. K. Teke, T. Nilsson, J. Boehm, T. Hobiger, P. Steigenberger, S. Garcia-Espada, R. Haas, and P. Willis, Troposphere delays from space geodetic techniques, water vapor radiometers, and numerical weather models over a series of continuous VLBI campaigns, *Journal of Geodesy*, 87(10-12), 981–1001, 2013.



# NMA Analysis Center 2013 Annual Report

Halfdan Pascal Kierulf, Ann-Silje Kirkvik, Per Helge Andersen

**Abstract** During the last few years, the Norwegian Mapping Authority (NMA) has had a close cooperation with the Norwegian Defence Research Establishment (FFI) in the analysis of space geodetic data using the GEOSAT software. NMA has taken over the full responsibility for the GEOSAT software. NMA has been an Associate Analysis Center of IVS since 28 October 2010. NMA's contributions to the IVS as an Analysis Center focuses primarily on routine production of session-by-session unconstrained and consistent normal equations by GEOSAT as input to the IVS combined solution. Several test solutions were uploaded to an IVS Combination Center during 2013. After the last improvements, the VLBI results produced with GEOSAT are in good agreement with results from the other VLBI Analysis Centers.

## 1 General Information

A number of co-located geodetic stations with more than one observation technique were established. In principle, all instruments at a given co-located station move with the same velocity, and it should be possible to determine one set of coordinates and velocities for each co-located site. In addition, a constant eccentricity vector from the reference point of the co-located station to each of the individual phase centers of the co-located antennas is estimated using constraints in accordance with a priori information given by the ground

surveys. One set of Earth orientation parameters (EOP) can be estimated from all involved data types, while, for instance, geocenter coordinates only can be estimated from satellite techniques and source positions only can be estimated from VLBI. Combining the individual techniques at the observation level gives the possibility of taking the benefit of the strengths of the individual techniques and suppressing their weaknesses. As one example, the present dominating error source of VLBI is the water content of the atmosphere, which must be estimated. The introduction of GPS data with a common VLBI and GPS parameterization of the zenith wet delay and atmospheric gradients will strengthen the solution for the atmospheric parameters. The inclusion of SLR data, which is nearly independent of water vapor, gives new information which will help in the de-correlation of atmospheric and other solve-for parameters and will lead to more accurate parameter estimates.

These, and many more advantages with the combination of independent and complementary space geodetic data at the observation level, are fully provided by the GEOSAT software developed by FFI [1, 2]. GEOSAT is also useful for single technique analysis. The VLBI module of GEOSAT is now further developed by the NMA [4]. The goals are both to act as an IVS Analysis Center delivering session-by-session unconstrained and consistent normal equations to the IVS Combination Centers and to provide quality control for the different modules used in GEOSAT.

---

Norwegian Mapping Authority (NMA)

NMA Analysis Center

IVS 2013 Annual Report

## 2 Activities during the Past Year

During 2013, the NMA continued the work of making the VLBI module of the GEOSAT software compatible with other VLBI analysis software delivering results to IVS. In addition, there is a lot of activity going on at NMA to further develop the multi-technique software GEOSAT (see the FFI TDC 2011 annual report). The VLBI module has been upgraded to be compliant with IERS Conventions 2010 [3], and some errors have been eliminated — for instance errors in the SINEX files due to misinterpretation of the format specification. NMA submitted several smaller solutions to an IVS Combination Center, and adjustments were made in GEOSAT based on the feedback from the IVS Combination Center. Finally, all R1 and R4 sessions from 2006 were submitted to the IVS Combination Center, and the solutions were found to be comparable to that of the other Analysis Centers (S. Bachmann, private communication). With this stabilized version of the software, 11 years (2003-2013) of R1 and R4 sessions were processed and are awaiting evaluation.

## 3 Future Plans

As soon as the 11-year test is compared with the individual solutions from the other ACs and the combined solutions from IVS and the outcome of the comparisons are found to be satisfactory, NMA will implement the GEOSAT VLBI processing in an automated processing chain. We will integrate the VLBI processing into the NMA control center which already monitors several geodetic applications. The NMA control center is always manned during working hours.

In addition, a lot of effort is being put into passing on the knowledge of Per Helge Andersen to the team that will maintain GEOSAT in the future. This work will continue in 2014 and has a very high priority. The new GEOSAT team will consist of five to seven members, where a few members are only partially involved.

NMA will start to deliver unconstrained normal equations in the SINEX format to the IVS Combination Center on a routine basis. As soon as this work is satisfactory, NMA will apply for the status of a full IVS Analysis Center.

Unlike most of the other VLBI analysis software GEOSAT is based on a UD Kalman filter. This al-

lows changing the stochastic behavior of the system. NMA will test different stochastic parameters especially for the troposphere. Station and epoch dependent stochastic parameters based on input from numerical weather models and IGS tropospheric products will be tested and evaluated. Tests of different models are also planned — for instance, a comparison of results using VMF1 and 3D ray tracing.

To produce VLBI solutions for IVS is the first part of a larger strategic plan from NMA. The next step is to include other geometric geodetic techniques (GNSS, SLR, and DORIS) in a common solution where the different techniques are combined at the observation level. The long-term goal of this large effort is to also include data from the gravity satellites GRACE and GOCE and from altimeter satellites.

## 4 Staff

Ann-Silje Kirkvik - Master of Science (NMA),  
Dr. Halfdan Pascal Kierulf - Research geodesist of Norwegian Mapping Authority (NMA and UiO),  
Dr. Per Helge Andersen - Research geodesist (NMA),  
Dr. Ingrid Fausk - Research geodesist (NMA),  
Dr. Oddgeir Kristiansen - Section Manager (NMA),  
Laila Løvhøiden - Project leader (NMA).

## References

1. Andersen, P. H., 1995. High-precision station positioning and satellite orbit determination. PhD Thesis, *NDRE/Publication 95/01094*
2. Andersen, P. H., 2000. Multi-level arc combination with stochastic parameters. *Journal of Geodesy* 74: **531-551** (doi: 10.1007/s001900000115)
3. Petit, G and Luzum B. (Eds.), 2010. IERS Conventions (2010). (*IERS Technical Note ; 36*) Frankfurt am Main: Verlag des Bundesamts für Kartographie und Geodäsie, 179 pp., ISBN 3-89888-989-6
4. Kierulf, H.P., Andersen, P.-H., Boeckmann, S., and Kristiansen, O. 2010, VLBI Analysis with the Multi-technique Software GEOSAT. *IVS 2010 General Meeting Proceedings* pp. 207-211, edited by Dirk Behrend and Karen D. Baver (NASA/CP-2010-215864)

# Paris Observatory (OPAR) Analysis Center

Sébastien Lambert, Christophe Barache, César Gattano

**Abstract** We report on operational and research activities at the Paris Observatory VLBI Analysis Center (OPAR) for calendar year 2013. Our achievements include the reanalysis of opa2013a and two research topics concerning the time stability of the ICRF2 axes and the more accurate determination of the Solar system acceleration.

## 1 Analysis Service

### 1.1 Operational Solutions

A reanalysis of the complete diurnal session database was done (identified as opa2013a), and the resulting EOP series and radio source catalogs were sent to the IVS. This solution estimated EOP and rates as session parameters, most of the station coordinates and the velocities as global parameters, and most of the sources' coordinates as global parameters. Stations undergoing strong nonlinear displacements were estimated as session parameters (e.g., TIGOCONC, TSUKUB32) instead of with the spline parameterization used in the previous OPAR solutions. Troposphere and clock parameters were estimated every 20 minutes and 60 minutes, respectively, and gradients were estimated every six hours (at all sites). Axis offsets were estimated as global parameters for a list of 80 stations. We used up-to-date geophysical and astronomical modeling to compute the theoretical delay and partials, including

the IAU 2006 nutation and precession, the Vienna mapping functions 1, the FES 2004 ocean loading model, and the antenna thermal deformations as provided by A. Nothnagel (2009, *J. Geod.*, 83, 787). Constraints were applied to the 295 ICRF2 defining sources (no-net rotation), and to 24 stations (no-net rotation and no-net translation of positions and velocities). We used the latest version of the Calc/Solve geodetic VLBI analysis software package.

Diurnal sessions were analyzed routinely within 24 hours after version 4 of the observation file was submitted to the IVS. The operational solution is aligned to the opa2013a global solution. Unconstrained normal equations relevant to EOP, rates, and station and source coordinates were sent to the IVS in SINEX format for combination in the framework of the IVS Analysis Coordinator's task.

An operational solution analyzing Intensive sessions after 2006, started in 2011, was also continued (opa2011i) together with corresponding SINEX files. The solution opa2011i processed Intensive sessions in order to produce UT1 consistent with VTRF 2008A, ICRF2, and the IERS EOP 08 C 04 Earth orientation data.

All the above products, except SINEX files, were published on the OPAR Web site at

<http://ivsopar.obspm.fr>

together with exhaustive explanations and plots. SINEX files were only sent to the data centers.

---

Observatoire de Paris/SYRTE – CNRS – UMPC – GRGS

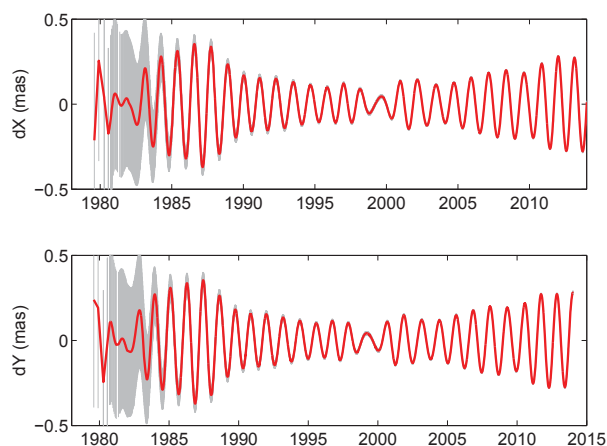
OPAR Analysis Center

IVS 2013 Annual Report

## 1.2 Other Products

Station and radio source coordinate time series were updated. For each source, a page displays the time series and provides links to source information at various external databases (e.g., the French Virtual Observatory software package Aladin that permits a user to get the optical counterpart of the VLBI quasars, or the Bordeaux VLBI Image Database that gives the VLBI structure).

The free core nutation (FCN) is a free oscillation of the Earth's figure axis in space due to the presence of a liquid core rotation inside the viscoelastic mantle. Its period is close to 430 days and is retrograde. Understanding the excitation of the FCN and its amplitude and phase variations is still an open question, although the community generally believes that the key resides in improved atmospheric and oceanic circulation modeling at diurnal and subdiurnal frequencies. At OPAR, we maintain an FCN model directly fitted to routinely estimated nutation offsets (Figure 1). In addition to the FCN, amplitudes and phases of a set of 42 prograde and retrograde tidal waves are also fitted to the data. These tidal terms are interpreted as small deficiencies of the IAU 2000A nutation model and can be used together with the FCN model to build up a better a priori nutation. Research is ongoing to identify some other terms showing up in the residuals at the level of ten microseconds of arc.



**Fig. 1** The amplitude of the free core nutation.

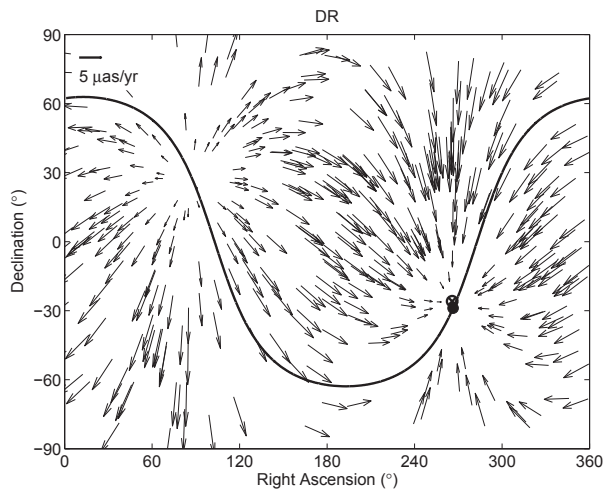
## 2 Research

### 2.1 Time Stability of the ICRF2 Axes

In Lambert (2013, A&A 553, 122), one assessed the stability of the ICRF2 295 defining sources and of the ICRF2 axes. This was achieved by deriving coordinate time series of hundreds of quasars monitored by the regular geodetic VLBI program of the IVS. The axis stability was studied by constructing annual reference frames based on the ICRF2 defining sources. The time variable frame stability was obtained by computing the deformation parameters that lead from one frame to the next. The study showed that, although the astrometric stability of some of the ICRF2 defining sources has slightly degraded since 2009.2, the ensemble still constitutes a very stable frame of reference. The estimation of the axis stability over 1979.6–2013.1 remains at the same level as the one estimated in the ICRF work, i.e., on the order of  $20 \mu\text{as}$  for each axis.

### 2.2 Improved VLBI Measurement of the Solar System Acceleration

In a study by Titov & Lambert (2013, A&A 559, 95), the authors proposed new estimates of the secular aberration drift, which is mainly caused by the rotation of the solar system about the Galactic center, based on up-to-date VLBI observations and improved method of outlier elimination. We fitted degree-2 vector spherical harmonics to the extragalactic radio source proper motion field derived from geodetic VLBI observations during 1979–2013. We paid particular attention to the outlier elimination procedure that removes outliers from (i) radio source coordinate time series and (ii) the proper motion sample. We obtain more accurate values of the Solar system acceleration than in our previous paper (Titov et al. 2011, A&A 529, 91). The acceleration vector is oriented towards the Galactic center within  $\sim 7^\circ$ . The component perpendicular to the Galactic plane is statistically insignificant. We show that an insufficient cleaning of the data set can lead to strong variations in the dipole amplitude and orientation and hence to statistically biased results (see Figure 2).



**Fig. 2** The dipole pattern in the radio source apparent proper motion field.

# Onsala Space Observatory – IVS Analysis Center Activities during 2013

Rüdiger Haas, Hans-Georg Scherneck, Johan Löfgren, Tong Ning, Niko Kareinen

**Abstract** This report briefly summarizes the activities of the IVS Analysis Center at the Onsala Space Observatory during 2013 and gives examples of results of ongoing work.

## 1 General Information

We concentrate on research topics that are relevant for space geodesy and geosciences. These research topics are related to data observed with geodetic VLBI and complementing techniques.

## 2 Activities during the Past Year

We worked primarily with the following topics:

- Automated reference point determination
- Simulations for the Onsala Twin Telescope project
- Analog vs. digital VLBI observations
- Coastal sea level observations with GNSS
- Ocean Tide Loading
- Gravimetry observations.

Chalmers University of Technology, Department of Earth and Space Sciences, Onsala Space Observatory

Onsala Analysis Center

IVS 2013 Annual Report

## 3 Automated Reference Point Determination

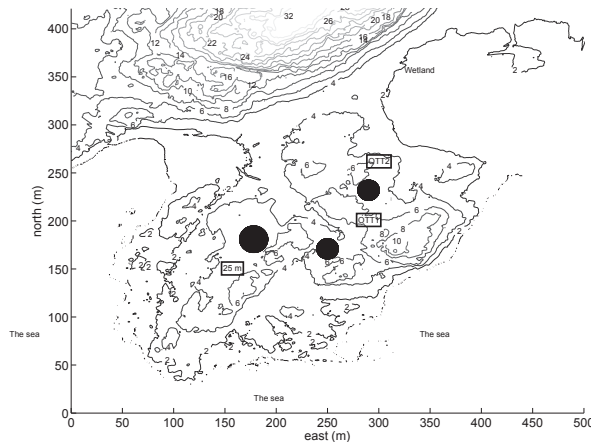
We developed a strategy to obtain an automated and continual reference point determination of radio telescopes with sub-mm accuracy. This approach can be used both in dedicated survey campaigns (stop-and-go mode) as well as during ongoing VLBI sessions (continuous motion). The method was tested successfully already in 2012, and the corresponding results were published in [3].

## 4 Simulations for the Onsala Twin Telescope Project

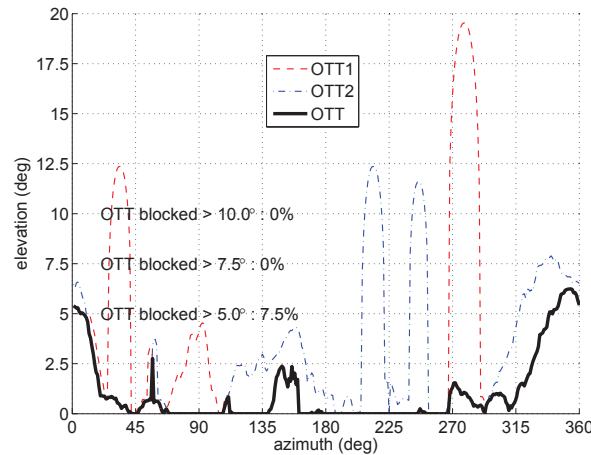
We performed simulations for the Onsala Twin Telescope (OTT) project, concerning both the actual location of the antennas and their local horizon masks as well as future scheduling and use of the antennas.

Figure 1 depicts a digital elevation model of the OTT plan that was submitted to the local authorities in December 2013. Compared to a previously submitted plan in 2012 [1] the antenna OTT1 has been moved towards the southwest. The local horizons for two antennas and for the combined OTT are shown in Figure 2. Table 1 gives information on the horizon blockage at different elevation limits.

The future use of the OTT was also studied by simulating possible observing schedules [4]. Several different scheduling strategies were tested with the VieVs software. These simulations showed that the so-called continuous mode approach with four radio sources at a time gives the best results in terms of station po-



**Fig. 1** Digital elevation model of a selected area of the Onsala Space Observatory, showing the location of the 25-m telescope, and the planned Onsala Twin Telescope antennas, OTT1, and OTT2 (plan of December 2013). These three telescopes are on a small peninsula that is surrounded by the sea from southwest to southeast and wetland in the east. In the north, there is a rocky hill of more than 32-m height.



**Fig. 2** Horizon masks for the individual twin telescopes, OTT1 (dashed line, red) and OTT2 (dashed-dotted line, blue), and combined for both OTT antennas together (solid line, black), as seen from the lower edge of the prime reflectors. The OTT telescopes see each other (at about 30° and 240° azimuth), and they see the 25-m telescope at about 210° and 290° azimuth. However, the common horizon is completely free above 7.5° and only blocked by 7.5 % at elevation 5°.

sitions and EOP. However, the continuous mode approach with two radio sources at a time strategy appeared to be superior in terms of accuracy of tropospheric parameters. Further investigations are necessary.

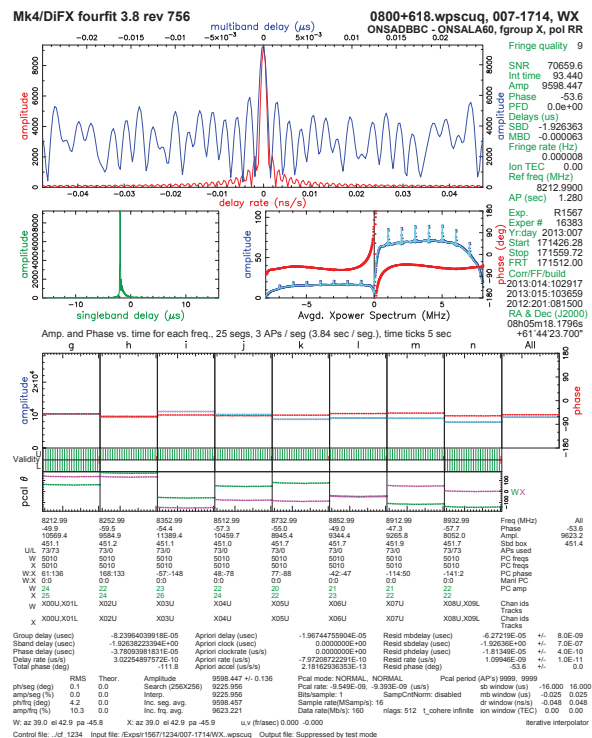
**Table 1** Horizon blockage at different elevation limits.

antenna	blocking		
	> 5°	> 10°	> 15°
OTT1	18.1 %	9.4 %	5.0 %
OTT2	22.5 %	5.8 %	0 %
OTT	7.5 %	0 %	0 %
25 m	14.7 %	4.7 %	0 %

## 5 Analog vs. Digital VLBI Observations

About 2/3 of the geodetic VLBI sessions performed in 2013 at Onsala were observed both with the old analog Mark IV rack and the new digital DBBC. Zero-baseline tests were performed using the DiFX software correlator at Onsala and at the Bonn correlator. Figure 3 depicts as an example the zero-baseline correlation for one scan of the experiment R1567.

The Bonn correlator also prepared for several of these parallel recorded experiment databases that in-



**Fig. 3** Fringe plot for a zero-baseline test for an X-band observation during session R1567.

clude Onsala both as an analogue station (On) and as a digital station (Od). We analyzed several of these databases, and our preliminary results are that there are no significant effects on the geodetic results, in particular on the earth orientation parameters, if either the analog or digital data are used for the data analysis. Further investigations with a larger set of databases are necessary.

## 6 Coastal Sea Level Observations with GNSS

We used the GNSS-based tide gauge installation at the observatory to derive the local sea level and its variation using reflected GNSS signals.

Besides using phase-delay analysis of the data recorded with the special dual-antenna GNSS tide gauge installation at Onsala, we also used signal-to-noise-ratio (SNR) analysis of the data observed only by the upward-looking GNSS antenna [2]. The study proved that this SNR analysis method can be applied to coastal single-antenna installations.

A comparison of relative sea levels derived from the GNSS tide gauge, a co-located pressure-based tide gauge, and a recently installed co-located tide gauge based on a pneumatic sensor is shown for the month of September in Figure 4. The tide gauge based on the

pneumatic sensor (the “bubbler”) has according to the manufacturer a measurement uncertainty of  $\pm 3$  mm. The two other techniques (pressure sensor and GNSS tide gauge) result in an agreement with the bubbler on the order of 13 mm and 46 mm (standard deviation after bias removal), respectively.

## 7 Ocean Tide Loading

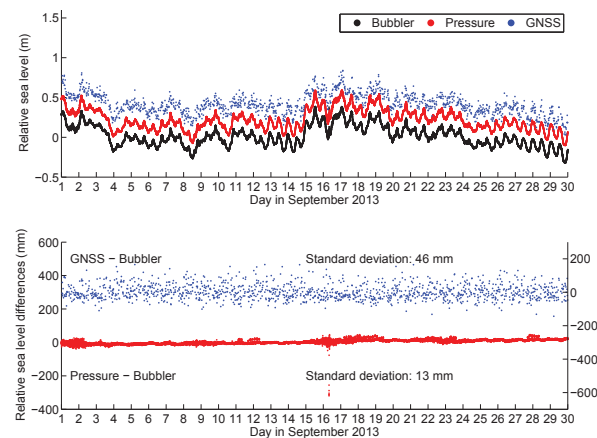
The Automatic Ocean Tide Loading service was operated throughout the year. It is heavily used by the international scientific community.

## 8 Gravimetry Observations

Since January 2013 the superconducting gravimeter in the gravity laboratory at the Onsala Space Observatory communicates one-second data to the world. The instantaneous measurements are presented on the webpage <http://holt.oso.chalmers.se/hgs/SCG/monitor-plot.html>. The presented values are reduced for air pressure and astronomical tides and shown in the largest diagram. A summary of the last 30 days and a spectrogram of the short-period noise are also shown. A link makes numeric data available for download with a latency of less than two minutes; other links allow the identification of seismic events and the causes of microseismic noises (mostly remote action due to high waves in specific areas of the North Atlantic region).

## 9 Future Plans

The IVS Analysis Center at the Onsala Space Observatory will continue its efforts to work on specific topics relevant to space geodesy and geosciences. For the future we plan to intensify our activities, in particular concerning horizontal gradients in the atmosphere using VLBI, GNSS, and radiometers. A special focus for the coming years will be work related to the Onsala Twin Telescope project.



**Fig. 4** Top: Relative sea levels derived from the pneumatic sensor (“bubbler”), a pressure sensor, and the GNSS tide gauge, for September 2013. The data are offset from each other to improve readability. Bottom: Relative sea level differences with respect to the bubbler.



## References

1. Haas R. The Onsala Twin Telescope Project. *Reports of the Finnish Geodetic Institute, Proceedings of the 21st Meeting of the European VLBI Group for Geodesy and Astronomy*, Ed. by N. Zubko and M. Poutanen, 2013:1 (1), 61–65, 2013.
2. Larson K., Löfgren J., Haas R. Coastal Sea Level Measurements Using a Single Geodetic GPS Receiver. *Advances in Space Research*, 51(8), 1301–1310, 2013.
3. Lösler M., Haas R., Eschelbach C. Automated and continual determination of radio telescope reference points with sub-mm accuracy: results from a campaign at the Onsala Space Observatory. *Journal of Geodesy*, 87(8), 791–804, 2013.
4. Schönberger C. Simulations of VLBI observations with the Onsala Twin Telescope. Master of Science Thesis, Chalmers University of Technology, <http://publications.lib.chalmers.se/records/fulltext/185857/185857.pdf>, 2013.

# PMD Analysis Center 2013 Annual Report

Vincenza Tornatore

**Abstract** This report summarizes the activities of the *Politecnico di Milano* (PMD) IVS Analysis Center during the year 2013 and outlines the planned aspects of work for 2014. The main focuses in 2013 were in the framework of the IAG WG 1.4.2 on *Co-location on Earth and in Space for the determination of the Celestial Reference Frame*. Studies carried out concern e.g. simulations for some European VLBI antennas performed to investigate if the VLBI phase referencing technique can be used for precise determination of GNSS state vectors. Furthermore, investigations into possible deformations introduced by the change to ICRF2 [1] were also made for the processing of 24-hour observational sessions.

## 1 General Information

Throughout 2013, Milan University of Technology (*Politecnico di Milano*) celebrated the 150<sup>th</sup> anniversary of its establishment with several events, see Figure 1 and Figure 2; some of these events are listed in [2].

The department, supporting activities of the PMD IVS Analysis Center, changed since January 2013. The new one is called Department of Civil and Environmental Engineering (DICA) [3]. Therefore the name of the Analysis center PMD stands for *Politecnico di Milano Dica* now. This new department belongs, like the previous one (called Diar), to Milan University of

*Politecnico di Milano*, Department of Civil and Environmental Engineering (DICA), Geodesy and Geomatic area

PMD Analysis Center

IVS 2013 Annual Report



Fig. 1 2013 marked the 150<sup>th</sup> year of the establishment of the *Politecnico di Milano*.



Fig. 2 People celebrating the 150<sup>th</sup> anniversary of the *Politecnico di Milano*.

Technology. It deals with plentiful research areas in civil and environmental engineering, enhancing an integrated approach among them.

The research area called Geodesy and Geomatic hosts and operates the PMD IVS AC and IGeS (International Geoid Service), an official Service of the International Association of Geodesy (IAG), see [4]. PMD started officially its activity in October 2010 [5]. DICA supplies hardware equipment, software licenses and assistance, and the personnel necessary to manage it.

## 2 Staff

During 2013, the following persons contributed to the PMD activity:

1. Vincenza Tornatore — team coordinator, project developer, data analysis;
2. Cinzia Vajani — software maintenance;
3. Daniele Passoni — data processing.

## 3 Current Status and Activities

During 2013, the main activities developed by the PMD IVS Analysis Center were addressed to studying if the observing technique called *phase referencing* (largely used for high precision VLBI astrometry, see e.g. [6] and [7]) could be applied to observing GNSS satellites with the aim of improving the precision of the determination of the satellite state vector and of obtaining satellite positions directly in ICRF. It is well known that the strong power emitted by the satellites compared to the very low emission of natural radio sources (calibrators) could represent a limiting factor, because the satellite signal can be easily detected through near sidelobes when observing, at the same satellite frequency, the natural calibrator in the main beam.

To get an indication of this problem, some preliminary investigations were carried out. We ran some simulations, in collaboration with the University of Milan (Physics Department), using GRASP (General Reflector antenna Analysis Software Package) v.10, to assess the relative power contribution of satellites in the near sidelobes when observing in L-band a natural calibrator in the main beam. For each examined station, we evaluated the minimum angular distance between the

satellite and the calibrator to avoid near-sidelobe stray-light contamination from the satellite emission when the calibrator is tracked.

Three European VLBI antennas, Medicina, Noto and Onsala85, were considered. All three antennas have a Cassegrain configuration with a parabolic primary dish and a hyperbolic secondary dish. The L-band receiver is mounted at the primary focus only at Medicina, while for Noto and Onsala85 it is at the secondary focus. Figure 3 shows the GRASP 3D model of the optics of the three antennas, while the corresponding beam patterns are shown in Figure 4.

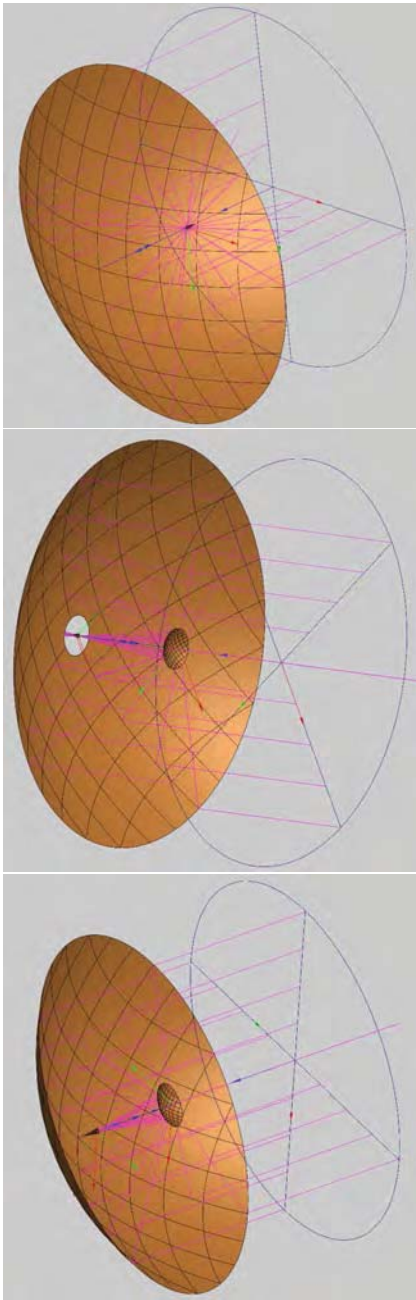
Detailed results and discussions on this work have been published in [8]. To briefly summarize, we can write that the key role in avoiding calibrator signal contamination due to a strong satellite signal seems to be played by the telescope optical configuration, with better results obtained for Medicina (with the L-band receiver at the primary focus), than for Noto and Onsala85 (with the L-band receiver at the secondary focus).

During 2013, another subject tackled by PMD AC concerned investigations into possible deformations introduced by the change to ICRF2. In tight collaboration with the VIE IVS Analysis Center and the PUL IVS AC, 27 years of suitable VLBI experiments, measured in 24-hour sessions, were analyzed. The starting year was 1984. IERS (International Earth Rotation and Reference Systems Service) [9] and IVS conventions on VLBI data [10] were followed in the data processing. Session-wise solutions were computed with the Vienna VLBI Software VieVS [11]. Results are going to be published, after an in-depth analysis and complementary studies are completed.

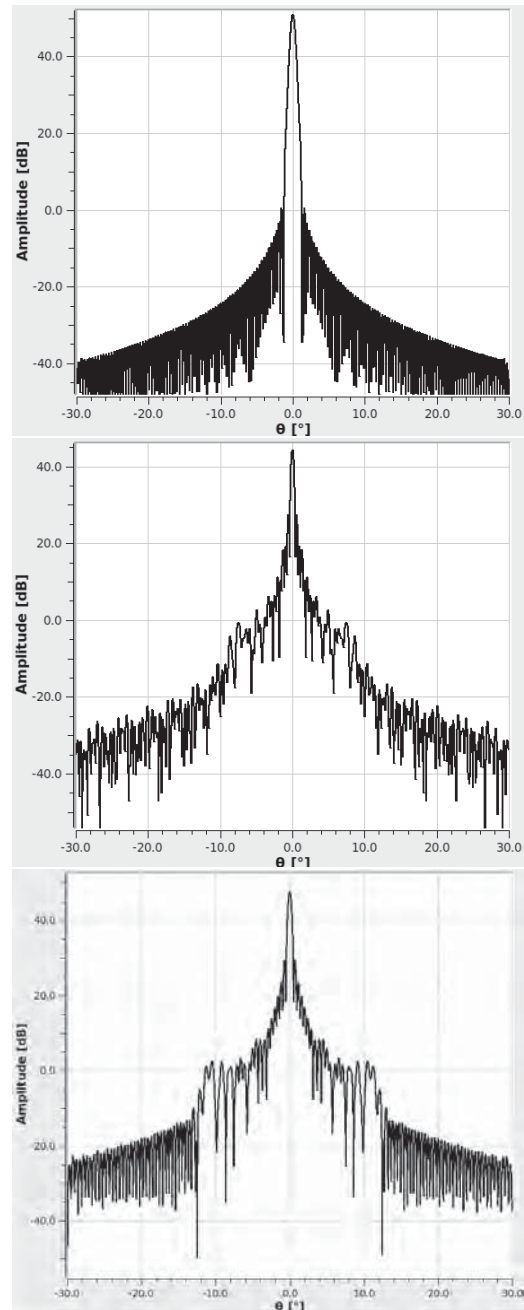
## 4 Future Plans

In 2014, the work of the PMD Analysis Center will focus on the following aspects:

- Co-location on Earth and in Space for the determination of the Celestial Reference Frame.
- Investigation into dedicated algorithms for tropospheric parameter estimation, particularly addressed to a territory not very broad, such as the Italian region.
- Continuation of investigations into ICRF2.



**Fig. 3** VLBI radio telescope optics simulated with GRASP, in the order from top to bottom: Medicina, Noto, and Onsala85.



**Fig. 4** VLBI radio telescope optics simulated with GRASP, in the order from top to bottom: Medicina, Noto, and Onsala85.

## Acknowledgements

The author wishes to thank IRA/INAF, Istituto di Radioastronomia, Italy (S. Mariotti, G. Nicotra, and F. Schillirò), and Onsala85 radio telescope, operated by

the Swedish National Facility for Radio Astronomy, Sweden (M. Lundqvist and M. Pantaleev), for having provided the values about antenna dish geometry and feed characteristics used to make simulations with GRASP.

## References

1. IERS technical note 35, *The second realization of the international celestial reference frame by very long baseline interferometry*, Fey A.L., Gordon D., Jacobs C.S. (eds) Verlag des Bundesamts für Kartographie und Geodäsie, Frankfurt am Main, 2009 (<http://www.iers.org/TN35>).
2. <http://www.150.polimi.it>.
3. <http://www.dica.polimi.it/en/>.
4. <http://www.iges.polimi.it/>.
5. Tornatore V., *New Associate Analysis Center Established at PMD*, in *International VLBI Service for Geodesy and Astrometry 2010 Annual Report*, NASA/TP-2011-215880, Behrend D. and Baver K.D. (eds), 244-246, 2011.
6. Lane B. F. and Muterspaugh M.W., *Phase referencing and narrow-angle astrometry in current and future interferometers* in *Proceedings of SPIE, V. 5491, N.1* Traub W.A. ed, SPIE Bellingham, WA, 47-55, 2004.
7. Asaki Y., Sudou H., Kono Y., Doi A., Dotson R., Pradel N., Murata Y., Mochizuki N., Edwards P.G., Sasao T., Fomalont E.B. *Verification of the Effectiveness of VSOP-2 Phase Referencing with a Newly Developed Simulation Tool*, *ARIS*, Publ. Astron. Soc. Japan, 59, 397, 2007.
8. Tornatore V., Mennella A. *On the possibility of using VLBI phase referencing to observe GNSS satellites*, in: *21th European VLBI for Geodesy and Astrometry (EVGA) Working Meeting Proceedings*, Zubko N., Poutanen M., (eds), 227-231, 2013.
9. Petit G., Luzum B. (eds.), *IERS Conventions (2010)*, *IERS Technical Note 36*, Frankfurt am Main: Verlag des Bundesamts für Kartographie und Geodäsie, 2010.
10. Nothnagel A. *Conventions on thermal expansion modeling of radio telescopes for geodetic and astrometric VLBI*, in *Journal of Geodesy*, 83, 787—792, 2008.
11. Böhm J., Böhm S., Nilsson T., Pany A., Plank L., Spicakova H., Teke K., Schuh H. *The new Vienna VLBI Software VieVS in IAG Symposium 139*, Kenyon S., Pacino M.C., Marti U. (eds), 1007-1012, 2012.

# Pulkovo IVS Analysis Center (PUL) 2013 Annual Report

Zinovy Malkin, Yulia Sokolova

**Abstract** This report briefly presents the PUL IVS Analysis Center activities during 2013 and plans for the coming year. The main topics of the investigations of the PUL staff in that period were ICRF related studies, computation and analysis of EOP series, celestial pole offset (CPO) and free core nutation (FCN) modeling, and VLBI2010 related issues.

## 1 General Information

The PUL IVS Analysis Center was organized in September 2006. It is located at and sponsored by the Pulkovo Observatory of the Russian Academy of Sciences. It is a part of the Pulkovo EOP and Reference Systems Analysis Center (PERSAC) [1]. The main topics of our IVS related activity are:

- Improvement of the International Celestial Reference Frame (ICRF).
- Computation and analysis of the Earth orientation parameters (EOP) from Intensives and 24-hour IVS sessions.
- Analysis of EOP and position time series.
- Modeling of the celestial pole offset (CPO) and free core nutation (FCN).
- Comparison of VLBI products, primarily EOP, with results of other space geodesy techniques.
- Computation and analysis of observation statistics.

The PUL Analysis Center Web page [2] is supported. It contains the following sections:

Pulkovo Observatory

Pulkovo Analysis Center (PUL)

IVS 2013 Annual Report

- *General Information on the PUL Analysis Center.* Includes brief history, activity overview, and a scientific staff list.
- *VLBI data analysis.* Includes results of VLBI data analysis, such as UT1 Intensive series, CPO/FCN series, and mean Pole coordinates. These data are updated daily.
- *OCARS catalog.* Includes the latest version of the catalog of optical characteristics of astrometric radio sources (OCARS) [3]. The catalog is continually updated as new information becomes available.
- *Approaches and occultations.* Includes tables for forthcoming mutual events of planets and astrometric radio sources, such as close angular approaches and occultations for the period until 2050 [4].
- *PUL members' publications and presentations.*
- *VLBI technology overview.*
- *Links to the VLBI World.* Includes links to (primarily geodetic and astrometric) VLBI coordinating bodies, stations, analysis centers, software, etc.
- *Contact information.*

## 2 Staff

In 2013 the following persons contributed to the PUL activity:

1. Zinovy Malkin (70%) — team coordinator, EOP and CRF analyst;
2. Natalia Miller (5%) — EOP analyst; and
3. Yulia Sokolova (100%) — CRF analyst.

### 3 Activities and Results

The main activities and results of the PUL IVS Analysis Center during 2013 included:

- *ICRF related research.* The main directions of this activity were comparison and combination of radio source catalogs and investigation of their stochastic and systematic errors. In 2013, the following results were obtained:
  - A new Pulkovo combined catalog was computed [5]. Using CRF realizations from eight IVS Analysis Centers (aus, bkg, cgs, gsf, igg, opa, sha, and usn), we computed two combined catalogs: PUL (2013) C01 and PUL (2013) C02. The method used generally follows our previous work [6]. Besides using more data, several developments were realized as compared with the previous version of the Pulkovo combined catalog of 2007 [6]. The PUL (2013) C01 catalog is constructed in the ICRF2 [7] system and is aimed at improving ICRF2 random errors, while the final, PUL (2013) C02 catalog is constructed in an independent system and thus provides both stochastic and systematic improvement of the ICRF2. Comparison of the Pulkovo combined catalog with ICRF2 gives evidence of ICRF2 systematic errors at a level of 15–20  $\mu$ as.
  - Impact of the correlation information on the results of determination of the angles of mutual orientation between catalogs was investigated [8]. This work continues the work of Jacobs et al. [9]. Test computations were performed with nine catalogs computed in eight centers of analysis of the VLBI observations. The mutual orientation between these CRF realizations was computed with three methods of accounting for the correlation information: using the position errors only, using only the RA/DE correlations reported in radio source position catalogs in the IERS format, and using the full correlation matrix. Only two of these catalogs, igg and gsf, were provided together with full covariance matrices (thanks to the authors of these catalogs who made them available for our work); seven other catalogs were published with RA/DE correlations only. Our analysis has shown that using the RA/DE correlations only slightly influences the computed rotational angles, whereas using the full correlation matrices leads to substantial change in the orientation parameters between the compared catalogs.
  - A new approach to estimation of the stochastic errors of radio source position catalogs was proposed [10]. It is based on the three-cornered-hat technique, extended to the N-cornered-hat technique. A key point of the method is a new approach to computation of the correlations between the compared catalogs. As an additional refinement, the concept of weighted correlation coefficient was introduced. This technique was applied to nine recently published radio source position catalogs. We also found large systematic differences between catalogs that significantly impact determination of their stochastic errors.
  - A study was performed aimed at a search for an optimal strategy for using limited observational resources in the southern hemisphere to improve ICRF in the band  $\delta < -40^\circ$  [11]. We investigated the possibility of increasing the number of observations of existing and prospective southern ICRF radio sources by inclusion of more such sources in the regular IVS sessions like R1 and R4. With Monte Carlo simulations, we tested the influence of adding supplementary southern sources to the IVS R1541 (12JUL09XA) session on EOP and baseline length repeatability. We found that adding more observations of southern sources to the standard schedule causes a slight degradation of some geodetic products and a slight improvement of others, depending on the number of added southern sources. Similar results were obtained for the IVS R1591 (13JUN24XA) session. Generally, it was shown that it is possible to increase the number of observations of southern sources without loss of the overall accuracy of geodetic products.
  - The OCARS catalog [3] has been supported since 2008. The catalog provides redshift information, as well as visual and NIR magnitudes. The improvements made in 2013 include addition of new sources and new measurements of redshift and magnitude. The current basic statistics of the catalog are given in Table 1.

**Table 1** Current basic statistics of the OCARS catalog.

	All sources	ICRF2 sources	ICRF2 defining
Sources	8246	3414	295
Sources with known redshift	4353 (52.8%)	2249 (65.9%)	261 (88.5%)
Sources with known magnitude	5395 (65.4%)	2618 (76.7%)	285 (96.6%)

- *CPO and FCN related research.* The main activities and results in 2013 were the following:
  - Two CPO and two FCN series were updated daily and are available at the PERSAC Web page [1].
  - FCN amplitude and phase variations derived from VLBI observations were investigated. Comparison of the epochs of the changes in the FCN amplitude and phase with the epochs of the geomagnetic jerks (GMJs) indicated that the observed extremes in the FCN amplitude and phase variations were closely related to the GMJ epochs. In particular, the FCN amplitude begins to grow one to three years after the GMJs. Thus, processes that cause GMJs are assumed to be sources of FCN excitation [13].
  - Several VLBI-derived CPO time series were analyzed with the goal of detecting the Free Inner Core Nutation (FICN) [14]. The series were investigated by means of spectral and wavelet analysis. It was shown that there are several periodic signals with close amplitude around the expected FICN period without a prevailing one, which can be associated with the FICN. So, it seems to be necessary to improve the theoretical estimates of the FICN period to make searching for it in the observational series more promising.
  - A study was made to investigate optimal CPO modelling for operational determination of UT1 from hourly sessions with the Quasar VLBI network (Institute of Applied Astronomy). It was found that the systematic differences between the UT1 estimates computed with different models (trend and seasonal terms) are at a level of 1-3  $\mu$ s. On the other hand, the formal error of the UT1 estimates practically does not depend on the CPO model used [12].
- *Studies in the framework of the IAG SC 1.4 activity* on investigation of the mutual impact of celestial and terrestrial reference frames and impact of astronomical and geophysical modelling on ICRF.

A study was performed to investigate the impact of seasonal station movement on the UT1 Intensive results [15]. It was found that a significant annual term is present in the time series for most stations, and its amplitude can reach 8 mm in the height component and 2 mm in the horizontal components. However, the annual signals found in the displacements of the co-located VLBI and GPS stations at some sites differ substantially in amplitude and phase. The semiannual harmonics are relatively small and unstable, and for most stations no prevailing signal was found in the corresponding frequency band. Then two UT1 Intensive series were computed with and without including the seasonal term found in the previous step in the station movement model. Comparison of these series has shown that neglecting the seasonal station position variations can cause a systematic error in UT1 estimates, which can exceed 1  $\mu$ s, depending on the observing program.

- Operational data processing of IVS Intensive sessions in automated mode and submission of results to IVS was continued. The UT1 time series is available at IVS Data Centers and at the PERSAC Web page [1].
- The PUL archive of VLBI data and products obtained in the framework of IVS activity is supported. At present, all available databases and corresponding NGS cards for 1979-2013 are stored (about 9.4 million observations) along with the main IVS and IERS products. These archives are continually updated as new databases become available.
- Development of algorithms and software for data processing and analysis continued. The results of two studies were published in 2013. The first paper deals with improvement of the application of the Allan variance technique to astronomical and geodetic time series with unevenly weighted measurements [16]. Modifications of the standard AVAR definition for unevenly spaced and multi-dimensional series were proven to be an effective



tool for data processing. In the second study, the problem of computation of the uncertainty of a weighted mean of several measurements was considered [17]. It was found that two classical approaches have serious shortcomings when applied to real data. Therefore, a combined estimate for the uncertainty of the weighted mean was proposed and successfully tested.

- PUL staff members participated in activities of several IERS, IAG, and IVS projects, committees, and working groups.

#### 4 Future Plans

Plans for the coming year include:

- Continuing VLBI related studies.
- Continuing UT1 Intensive data processing.
- Continuing OCARS catalog support.
- Continuing with development of algorithms and software for data processing.
- Continuing support of the PUL archives of data and products.

#### References

1. <http://www.gao.spb.ru/english/as/persac/index.htm>
2. [http://www.gao.spb.ru/english/as/ac\\_vlbi/](http://www.gao.spb.ru/english/as/ac_vlbi/)
3. [http://www.gao.spb.ru/english/as/ac\\_vlbi/ocars.txt](http://www.gao.spb.ru/english/as/ac_vlbi/ocars.txt)
4. [http://www.gao.spb.ru/english/as/ac\\_vlbi/occultations\\_approaches.pdf](http://www.gao.spb.ru/english/as/ac_vlbi/occultations_approaches.pdf)
5. Sokolova Yu, Malkin Z. Pulkovo combined catalog of radio source coordinates PUL 2013. *Astronomy Letters*, 2013, accepted.
6. Sokolova Ju., Malkin Z. On comparison and combination of catalogs of radio source positions. *Astron. Astrophys.*, 2007, 474, 665–670.
7. Ma C., E. F. Arias, G. Bianco, D. A. Boboltz, S. L. Bolotin, P. Charlot, G. Engelhardt, A. L. Fey, R. A. Gaume, A. M. Gontier, R. Heinkelmann, C. S. Jacobs, S. Kurdubov, S. B. Lambert, Z. M. Malkin, A. Nothnagel, L. Petrov, E. Skurikhina, J. R. Sokolova, J. Souchay, O. J. Sovers, V. Tesmer, O. A. Titov, G. Wang, V. E. Zharov, C. Barache, S. Boeckmann, A. Collioud, J. M. Gipson, D. Gordon, S. O. Lytvyn, D. S. MacMillan, R. Ojha. The Second Realization of the International Celestial Reference Frame by Very Long Baseline Interferometry. IERS Technical Note No. 35, A. L. Fey, D. Gordon, C. S. Jacobs (Eds.), Verlag des Bundesamts fuer Kartographie und Geodaesie, Frankfurt am Main, 2009.
8. Sokolova Ju. R., Malkin Z. M. On impact of the correlation information on the orientation parameters between celestial reference frames. *Vestnik of the St. Petersburg State University, Ser. 1, No. 4*, 146–151, 2013. (in Russian)
9. Jacobs C. S., Heflin M. B., Lanyi G. E., Sovers O. J., Steppe J. A. Rotational Alignment Altered by Source Position Correlations. In: *IVS 2010 General Meeting Proc*, Eds. D. Behrend, K.D. Baver, NASA/CP-2010-215864, 305–309, 2010.
10. Malkin Z. A new approach to the assessment of stochastic errors of radio source position catalogues. *Astron. Astrophys.*, v. 558, A29, 2013.
11. Malkin Z., Sun J., Boehm J., Boehm S., Krasna H. Searching for an Optimal Strategy to Intensify Observations of the Southern ICRF sources in the framework of the regular IVS observing programs. In: *Proc. 21st Meeting of the EVGA*, Eds. N. Zubko, M. Poutanen, Rep. Finn. Geod. Inst., Vol. 2013:1, 199–203. ISBN: 978-951-711-296-3, 2013.
12. Malkin Z. M., Skurikhina E. A. Dependence of the rapid UT1 results obtained from the VLBI network “Quasar” on nutation model. *Proc. of the All-Russian Astrometry Conference Pulkovo-2013*, *Izvestiya GAO*, No. 220, St. Petersburg: Pulkovo Observatory, 119–124, 2013. (in Russian)
13. Malkin Z. Free core nutation and geomagnetic jerks. *J. of Geodynamics*, v. 72, 53–58, 2013.
14. Malkin Z. M. On the observability of the free inner core nutation. *Proc. of the All-Russian Astrometry Conference Pulkovo-2013*, *Izvestiya GAO*, No. 220, St. Petersburg: Pulkovo Observatory, 115–118, 2013. (in Russian)
15. Malkin Z. Impact of seasonal station motions on VLBI UT1 Intensives results. *J. of Geodesy*, v. 87, 505–514, 2013. DOI: 10.1007/s00190-013-0624-5
16. Malkin Z. Using modified Allan variance for time series analysis. In: *Reference Frames for Applications in Geosciences*, Z. Altamimi, X. Collilieux (eds.), IAG Symposia, v. 138, 271–276, 2013. DOI: 10.1007/978-3-642-32998-2\_39
17. Malkin Z. M. On the Calculation of Mean-Weighted Value in Astronomy. *Astronomy Reports*, v. 57, 882–887, 2013. DOI: 10.1134/S1063772913110048

# SAI VLBI Analysis Center 2013 Annual Report

Vladimir Zharov

**Abstract** This report presents an overview of the SAI VLBI Analysis Center activities during 2013 and the plans for 2014. The AC SAI analyzes all IVS sessions for computations of the Earth orientation parameters (EOP) and time series of the ICRF source positions and performs research and software development aimed at improving the VLBI technique.

The package uses files in the NGS format as input data.

Package ARIADNA (v. 4) is the basis of software named ORBITA installed on the correlator of the AstroSpace Center of Lebedev Physical Institute. It is used for correlation of the ground-space interferometer data during the Radioastron mission.

## 1 General Information

The SAI VLBI Analysis Center is located at Sternberg State Astronomical Institute of Lomonosov Moscow State University in Moscow, Russia. The Analysis Center participates in geodetic and astrometric VLBI analysis, software development, and research aimed at improving the VLBI technique, especially for support of the Radioastron mission.

## 2 Component Description

AC SAI performs data processing of all kinds of VLBI observation sessions. For VLBI data analysis we use the ARIADNA software package developed at SAI. Version 4 was finished and tested in 2012. All reductions are performed in agreement with the IERS Conventions (2010).

---

Sternberg State Astronomical Institute (SAI) of Lomonosov Moscow State University

SAI Analysis Center

IVS 2013 Annual Report

## 3 Staff

- Vladimir Zharov, Prof.: development of the ARIADNA software, development of the methods of parameter estimation;
- Leila Kuznetsova, post-graduate student: VLBI data processing, nutation modeling;
- Nikolay Voronkov, scientific researcher: global solution;
- Svetlana Nosova, engineer: VLBI data processing;
- Natalya Shmeleva, engineer: VLBI data processing.

## 4 Current Status and Activities

- **Software development for VLBI processing**  
The ARIADNA software is being developed to provide contributions to IVS products. The software is used for calculating all types of IVS products. Version 4 was developed in 2012. The main features of this version are performing all reductions in agreement with the IERS Conventions (2010), generation of the SINEX files, and combination of some of the SINEX files to stabilize solution.

This version of the software was corrected in 2013: now it is possible to use the CIO based transformation matrix. A new series of the EOP was obtained from observations that were made in 2013.

The method that uses calculation of the equinox-based transformation matrix for precession-nutation was kept to compare new series with old ones. The equinox-based matrix  $Q(t)$  that transforms from the true equinox and equator of date system to the GCRS is composed of the classical nutation matrix, the precession matrix including four rotations, and a separate rotation matrix for the frame biases. A new series of the nutation angles will be used for the preparation of our suggestion for improving the nutation theory.

Some corrections of the model of delay for the ground-space interferometer were made and realized in software ORBITA, which is used for the correlation and routine analysis of the Radioastron observations.

- **Routine analysis**

During 2013 the routine data processing was performed with the ARIADNA software using the least-squares method with rigid constraints, and non-rigid constraints were used for generation of SINEX files.

AC SAI operationally processed the 24-hour and Intensive VLBI sessions. The formation of the databases of the VLBI sessions and processing of all sessions is fully automated. The EOP series sai2013a.eops and sai2013a.eopi were calculated. These series were computed with the VTRF2008 catalog of station positions and velocities. Experimental series sai2013c.eops was calculated with the CIO based transformation matrix. New EOP series will be used for the development of new nutation theory.

# SHAO Analysis Center 2013 Annual Report

Guangli Wang, Jinling Li, Minghui Xu, Li Guo, Li Liu, Fengchun Shu, Zhihan Qian, Liang Li

**Abstract** This report presents the routine work and the pertinent research of the SHAO VLBI Analysis Center (AC) during 2013. The SHAO AC continued routine VLBI data analysis of 24-hour geodetic/astrometric observations to make products. The activities of SHAO AC in 2013 also included reduction of data from the Chinese VLBI Network (CVN), providing navigation for Chang'E-3 using the VLBI technique, and basic research in Astrometry, specifically theoretical discussions on the Celestial Reference Frame and the effect of aberration.

## 1 General Information

In 2013, one of the important activities at SHAO AC was real-time navigation by using VLBI for the Chang'E 3 satellite that launched on December 02, 2013. This work involved scheduling, observing, processing, and analyzing VLBI experiments, which lasted until early 2014. Our routine data analysis contained two parts: the IVS 24-hour sessions and the CVN experiments that aim to monitor the crustal movement of the Chinese mainland. In addition, research topics focused on the CRF and the astrometric effects that are outlined in Section 3. The members involved in these activities were Guangli Wang, Jinling Li, Minghui Xu, Li Guo, Liang Li, Fengchun Shu, and Zhihan Qian.

---

SHAO, Chinese Academy of Sciences

SHAO Analysis Center

IVS 2013 Annual Report

## 2 Activities and Data Analysis at SHAO

SHAO is in charge of the CVN and is an Analysis Center of the IVS. Routine VLBI activities at SHAO included:

### **-The geodetic experiments and observations of MSP by the CVN**

As usual, in 2013, the CVN conducted six 24-hour geodetic sessions which aimed at monitoring the CVN network and at determining the accurate position for the new 65-meter antenna in Shanghai, the TIANMA65. The experiment of MSP J1939+2134, with three CVN antennas — SH 25 m, UR 25 m, and KM 40 m — was on September 30, 2013. The calibrator of MSP J1939+2134 in our observation was J1935+2031, which has 1.5 degrees of separation from the pulsar and has a position precision of  $\sim 0.1$  mas. The CVN observation mode was fast-switching between the pulsar and calibrator with a cycle time of 180 s on the pulsar and 80 s on the calibrator, and the total recording rate reached 1024 Mbps.

### **-Post processing of the VLBI observations for the navigation of Chang'E 3 satellite.**

We conducted the post processing of the VLBI observations for the navigation of the Chang'E 3 satellite, and obtained the differential group delay between the rover and the satellite with accuracy to a level better than 0.5 ns. The accuracy of the relative position of the rover and the satellite finally is at the meter level, based on the research of differential observations.

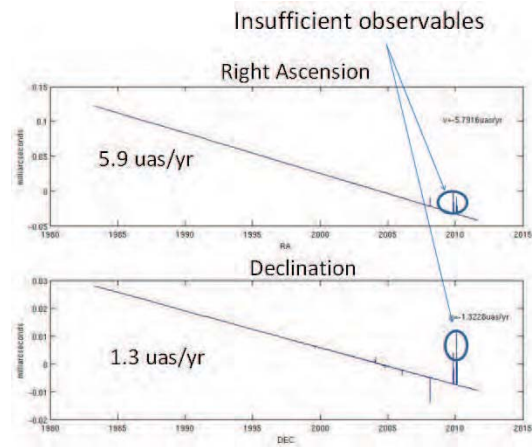
### -Data processing and analysis of the CVN geodetic experiments

The relative work consists of the calculation of the delay and delay rate of CVN observations at every band, the resolution of group delay ambiguities, and the computation of ionosphere calibrations. In addition, SHAO is responsible for the generation of the VLBI group delay in NGS format and for the analysis of all CVN sessions by the software *shops*, which has been developed based on the software *OCCAM6.1E(Linux)* with modifications mainly in VLBI data process models.

### -Regular data analysis of the IVS 24h sessions and product submission

We continued to routinely analyze all IVS 24-hour sessions using the *CALC/SOLVE* software, and we regularly submitted our analysis products (EOP, TRF, and CRF) to the IVS Data Centers. In order to contribute to the forthcoming ITRF2013 activity, we updated the geophysical and astronomical models, including the IAU 2006 nutation/precession, the ocean loading model, atmospheric pressure loading, the Vienna Mapping Function, and the antenna thermal deformation model.

These two solutions treated the position of this source as a local parameter to obtain the time series of its position. Figure 1 shows the difference of these two time series, which demonstrates that the accordance between the predicted model and the time series obtained from VLBI data is quite well. The time series of the position of a single source clearly show the effect of the Solar acceleration, which demonstrates that the software and data are sensitive to the microarcsecond level.



**Fig. 1** The time series of 2136+141, obtained from two solutions.

## 3 Research Topics at SHAO

### 3.1 Validation of Solar Acceleration

In 2011 and 2012, we obtained the acceleration vector in the three components in the Galactic coordinate system ( $7.47 \pm 0.46$ ,  $0.17 \pm 0.57$ ,  $3.95 \pm 0.47$ )  $mm \cdot s^{-1} \cdot yr^{-1}$  [1]. Traditionally, it was generally believed that the acceleration component in the direction normal to the Galactic plane was too small to be detected and that the acceleration vector should nearly point to the Galactic center, but our results showed that the vertical acceleration is notable. This year, we tried variant methods to validate this result. For example, we made two solutions with the same parameterizations and the same strategy except for a defining source, 2136+141. One solution took into account the effect of the acceleration on all sources, while another one took into account the effect of the acceleration on all except 2136+141.

### 3.2 The Aberration Effect

There was a groundbreaking step in the history of astronomy in 1728 when the effect of aberration was discovered by James Bradley (1693-1762). Recently, due to the variations in the aberrational effect of extragalactic sources caused by the Solar acceleration, the latter has been determined from VLBI observations with the uncertainty of about 0.5 mm/s/yr level. As a basic concept in astrometry with a nearly 300-year history, the definition of aberration is still equivocal and discordant in much of the literature. It has been under a continuing debate whether it depends on the relative motion between the observer and the observed source or only on the motion of the observer with respect to the frame of reference. We think that the aberration is essentially caused by the transformation between coordinate sys-

tems and is consequently quantified by the velocity of the observer with respect to the selected reference frame, independent of the motion of the source [2]. Obviously, this nature is totally different from that of the definition given by the IAU WG NFA in 2006, which is stated as “The apparent angular displacement of the observed position of a celestial object from its geometric position, caused by the finite velocity of light in combination with the motions of the observer and of the observed object” [3, 4]. The IAU’s definition has already led to some confusion and misunderstandings in the recent studies.

#### 4 Plans for 2014

We will make a contribution to the ITRF2013 campaign and study the potentially systematic variances in the direction displacements of radio sources with the aim to improve the accuracy of their positions.

#### References

1. M. H. Xu, G. L. Wang, and M. Zhao, A New concept of the International Celestial Reference Frame: the Epoch ICRF. *MNRAS*, 2013.
2. G. L. Wang, M. H. Xu, and M. Zhao, On the Definition of Aberration. (In preparation)
3. N. Capitaine, A. H. Andrei, M. R. Calabretta et al., Proposed Terminology in Fundamental Astronomy Based on IAU 2000 Resolutions. *Highlights of Astronomy*, 2007, 14, 474C475
4. 4 IAU 2006 NFA GLOSSARY, 2006, URL <http://synte.obspm.fr/iauWGnfa/>

# Tsukuba VLBI Analysis Center

Shinobu Kurihara <sup>1</sup>, Tetsuya Hara <sup>1,2</sup>

**Abstract** This report summarizes the activities of the Tsukuba VLBI Analysis Center during 2013. The weekend IVS Intensive (INT2) sessions were regularly analyzed using *c5++* analysis software. Several ultra-rapid EOP experiments were implemented in association with Onsala, Hobart, and HartRAO.

## 1 Introduction

The Tsukuba VLBI Analysis Center located in Tsukuba, Japan, is operated by the Geospatial Information Authority of Japan (GSI). A major role of us is to regularly analyze the weekend IVS Intensive (INT2) sessions using the fully automated VLBI analysis software *c5++* developed by the National Institute of Information and Communications Technology (NICT) [1]. It should be noted that the UT1-UTC (= dUT1) solution becomes available within a few minutes after the end of the last scan of the session. A 10 Gbps dedicated link to the SINET4 operated by the National Institute of Informatics (NII) and several process management programs make it possible to derive a solution rapidly. Other than that, the ultra-rapid EOP experiments behind 14 regular IVS 24-hour sessions and three dedicated ultra-rapid experiments were implemented in 2013.

---

1. Geospatial Information Authority of Japan

2. Advanced Engineering Service Co.,Ltd.

Tsukuba VLBI Analysis Center

IVS 2013 Annual Report

## 2 Component Description

### 2.1 Fully Automated VLBI Analysis Software *c5++*

*c5++*, which is an analysis software for space geodesy including SLR, GNSS, and VLBI, has been undergoing several modifications and updates by NICT and was installed on a host at the Tsukuba Analysis Center in the summer of 2012. In April 2013, we officially started to use *c5++* and to provide a dUT1 solution in the regular INT2 session. *C5++* supports flexible parameterization (X-pole, Y-pole, dUT1, nutation, station clocks, and troposphere) and SINEX input/output with covariance matrix. Therefore it is also used in the ultra-rapid EOP experiments (see Section 4.2).

### 2.2 *Calc/Solve*

*Calc/Solve* has been in use throughout from the early days of VLBI work in GSI. It is used for the analysis of JADE, which is the Japanese domestic observation for geodesy, in its interactive mode and for global analysis in the batch mode, which is for the purpose of our internal use, not for the IVS products as an Analysis Center.

### 2.3 Potential to Use *VieVS*

*VieVS*, developed by the Institute of Geodesy and Geophysics (IGG) of the Vienna University of Technol-

**Table 1** Analysis Center Hardware Capabilities.

Number of servers	4 for VLBI analysis ( <i>c5++</i> , <i>Calc/Solve</i> , and <i>VieVS</i> )
Operating System	CentOS version 5.4, 5.5, or Red Hat Enterprise Linux 6.3
CPU	Intel Xeon @3.80GHz CPU x 2, Intel Xeon 5160 @3.00GHz dual CPU x 2, Intel Xeon X3360 @2.83GHz quad CPU, Intel Xeon X5687 @3.60GHz quad CPU x 2
Total storage capacity	individual RAID5: 2.79 Tbytes in total

ogy, has already been installed in the Tsukuba Analysis Center [2]. But it has not been operational yet. *VieVS* is quite interesting VLBI analysis software, having some unique features that are not seen in other software. We would like to start to use it soon and to utilize the features for our analysis work.

## 2.4 Analysis Center Hardware Capabilities

Both *c5++* and *Calc/Solve* are installed on several general-purpose and commercially-produced Linux computers (Table 1). MATLAB as a platform for *VieVS* is also available on a host. Individual RAID5s are mounted on each host for storing a lot of VLBI data files such as Mark III databases.

## 3 Staff

The technical staff in the Tsukuba Analysis Center are

- **Shinobu Kurihara**: correlator/analysis chief, management.
- **Tetsuya Hara** (AES): correlator/analysis operator, software development.

## 4 Analysis Operations

### 4.1 IVS Intensive for UT1-UTC

72 IVS Intensive sessions were analyzed at the Tsukuba Analysis Center, and dUT1 results were submitted as *gsiint2b.eopi* to the IVS Data Center (Table 2). Only the dUT1 parameter was estimated with station positions fixed to a-priori. For the Tsukuba station after the 2011 Tohoku Earthquake, the position

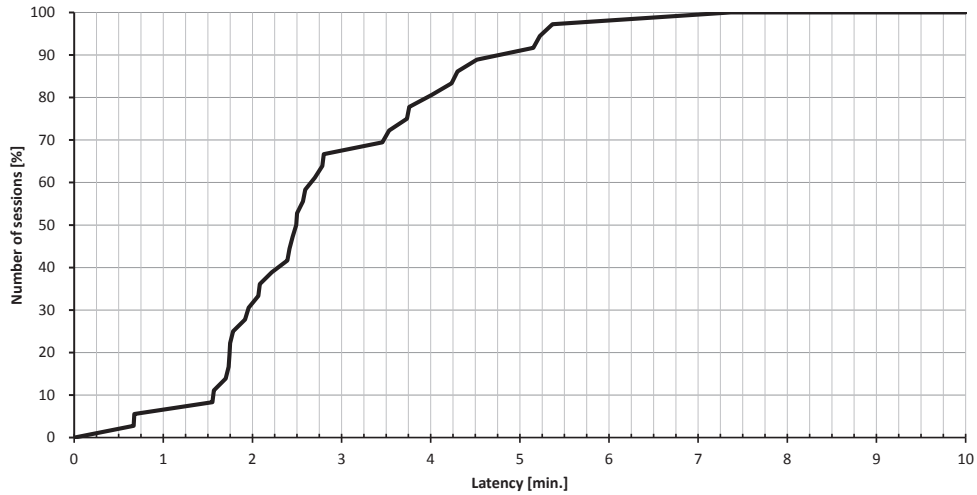
correcting its non-linear post-seismic motion provided by NASA/GSFC was used.

In 2013, the Tsukuba—Wettzell baseline and several other baselines were analyzed. The observed data at Wettzell is transferred to the Tsukuba Correlator in real-time with the VDIF/SUDP protocol. The correlated data is rapidly analyzed by *c5++* as soon as all the correlator outputs come in, and then a dUT1 solution is derived. Figure 1 shows that 90% of the total sessions complete analysis within five minutes after the end of the last scan. The end time of IVS-INT2 session is 8:30 UT on every Saturday and Sunday. Thus, the dUT1 solution is available at latest by 8:40. This is really an advantage of the Tsukuba Analysis Center. The *eopi* file, a product of Intensive analysis from the Analysis Center, is submitted immediately after the analysis and becomes accessible to users as an IVS product. The whole process of work from data transfer through submission of products is automated. Our products are utilized for more accurate dUT1 prediction by the U.S. Naval Observatory (USNO) as the IERS Rapid Service/Prediction Centre, which is responsible for providing earth orientation parameters on a rapid turnaround basis, primarily for real-time users and others needing the highest quality EOP information sooner than that available in the final EOP series. In the case of Kokee baselines, because the observed data at Kokee was transferred via USNO, it took a few hours to derive a solution.

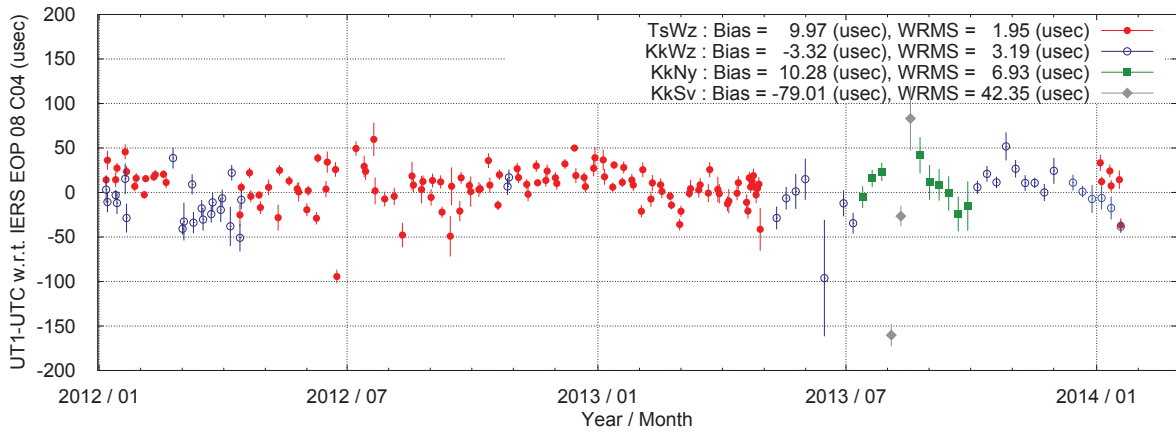
**Table 2** Intensive sessions analyzed at the Tsukuba Analysis Center.

	Baseline	# of sessions	Average of dUT1 sigma
Intensive 1	TsWz	7	9.7 $\mu$ sec
Intensive 2	TsWz	34	8.1 $\mu$ sec
	KkWz	19	14.6 $\mu$ sec
	KkNy	9	17.3 $\mu$ sec
	KkSv	3	19.9 $\mu$ sec
Total		72	11.6 $\mu$ sec





**Fig. 1** Latency–number of sessions as % of 36 Tsukuba-Wetzell sessions. Five sessions with some sort of trouble during the session are excluded.



**Fig. 2** The time series of UT1-UTC derived from IVS Intensive w.r.t. IERS EOP 08 C04. Error bars are  $1\sigma$  formal uncertainties.

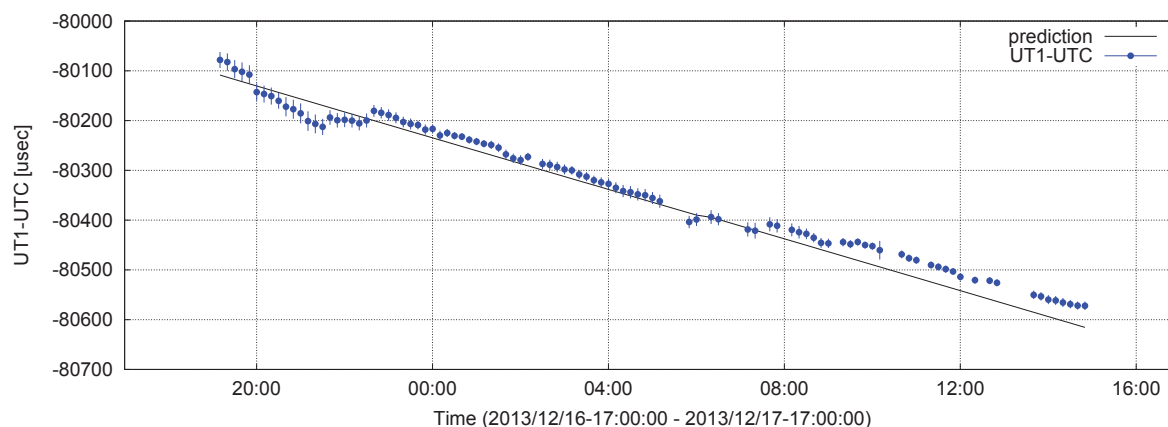
Figure 2 shows the differences between the dUT1 solutions of each Intensive baseline and IERS EOP 08 C04 from January 2012 through January 2014.

#### 4.2 Ultra-Rapid EOP Experiment

This session started in 2007 as a joint project of Japan (Tsukuba and Kashima) and Fennoscandia (Onsala and Metsähovi). It aims to derive a consecutive time series of EOP as soon as possible. The observed data is sent in real-time via the international optical fiber backbone

to Tsukuba where the data is correlated and analyzed. C5++ is used in the whole analysis.

Nowadays four countries — Japan, Sweden, Australia, and South Africa — are involved in association with Onsala, Hobart, and HartRAO. In 2013, three ultra-rapid EOP experiments with dedicated schedules were conducted (Table 3). The first session UR1301 with four stations — Hobart, HartRAO, Onsala, and Tsukuba — in January lasted for 61 hours without any major failures, and polar motion and dUT1 were determined ultra-rapidly during the ongoing experiment. The second experiment UR1302 in February was also



**Fig. 3** The time series of UT1-UTC derived from the Onsala–Tsukuba baseline from IVS-R1616 ultra-rapid processing with the prediction (Rapid Service/Prediction of Earth Orientation, finals2000A.daily).

successful with three stations — Hobart, HartRAO, and Tsukuba.

In addition, 14 regular IVS 24-hour sessions that involved at least two stations out of Hobart, HartRAO, Onsala, and Tsukuba were also operated with the ultra-rapid processing. The sessions are listed in Table 3. Six of them were originally scheduled with three of the stations. But a fourth station was added to them via the tag-along function of SKED, and these six sessions observed a four-station/six-baseline network. Two experiments in December with one baseline, Onsala–Tsukuba, were completed without even any minor failures, and a dUT1 time series was produced in near real-time. Figure 3 shows the time series of dUT1 from IVS-R1616 ultra-rapid processing.

## 5 Outlook

We will continue to analyze the data of the IVS-INT2 sessions and submit dUT1 products with a low latency. CONT14 planned for May 2014 is a good opportunity to conduct the 15-day continuous ultra-rapid processing. And we might start to use *VieVS* in part of our analysis work.

**Table 3** The ultra-rapid experiments in 2013. “\*” means the station is not included in the original schedule but added by SKED tag-along.

Exper.	Date	Time	Dur.	Stations	#obs.	
					(skd)	(cor)
<b>with dedicated schedule</b>						
UR1301	Jan 30	18:00	61	HbHtOnTs	1467	1326
UR1302	Feb 05	17:30	48.5	HbHtTs	943	815
UR1303	Dec 05	18:30	24	OnTs	611	606
<b>behind IVS 24-hr schedule</b>						
R1569	Jan 22	17:00	24	HbHhOnTs	541	539
R1570	Jan 28	17:00	24	HhOnTs	309	297
RD1301	Jan 29	17:30	24	HhOnTsHb*	394	392
R1573	Feb 18	17:00	24	HbOnTsHt*	565	513
T2088	Feb 19	17:30	24	HhOnTsHb*	275	247
R1579	Apr 02	17:00	24	HhOnTs	293	276
R1580	Apr 08	17:00	24	HtOnTsHb*	432	229
RD1302	Apr 09	17:30	24	HhOnTsHb*	482	-
R1582	Apr 22	17:00	24	HhOnTsHb*	348	332
R1592	Jul 01	17:00	24	HbHhOn	122	114
R1598	Aug 12	17:00	24	HbHhHtOn	323	262
RD1306	Aug 21	18:00	24	HoHhOn	140	110
R1615	Dec 09	17:00	24	OnTs	171	171
R1616	Dec 16	17:00	24	OnTs	196	195

## References

- Hobiger, T., et al.: Fully automated VLBI analysis with c5++ for ultra-rapid determination of UT1, *Earth Planets Space*, **62**, 933-937, 2010.
- Böhm, J., et al.: The New Vienna VLBI Software *VieVS*, In Proceedings of IAG Scientific Assembly 2009, *International Association of Geodesy Symposia Series*, **136**, edited by S. Kenyon, M. C. Pacino, and U. Marti, doi: 10.1007/978-3-642-20338-1\_126, 1007-1011, 2012.

# U.S. Naval Observatory VLBI Analysis Center

Alan Fey, Nicole Geiger, Chris Dieck

**Abstract** This report summarizes the activities of the VLBI Analysis Center at the United States Naval Observatory for calendar year 2013. Over the course of the year, Analysis Center personnel continued analysis and timely submission of IVS-R4 databases for distribution to the IVS. During the 2013 calendar year, the USNO VLBI Analysis Center continued to use the VLBI global solution designated usn2012b. Earth orientation parameters (EOP) based on this solution and updated by the latest diurnal (IVS-R1 and IVS-R4) experiments, were routinely submitted to the IVS. Sinex files based upon the bi-weekly 24-hr experiments were also submitted to the IVS. During the 2013 calendar year, Analysis Center personnel continued a program to use the Very Long Baseline Array (VLBA) operated by the NRAO for the purpose of measuring UT1–UTC. Routine daily 1.5-hour duration Intensive observations continued using the VLBA antennas at Pie Town, NM and Mauna Kea, HI. High-speed network connections to these two antennas are now routinely used for electronic transfer of VLBI data over the Internet to a USNO point of presence. A total of 345 VLBA Intensive experiments were observed, electronically transferred to, and processed at USNO in 2013.

---

U.S. Naval Observatory

USNO Analysis Center

IVS 2013 Annual Report

## 1 Introduction

The USNO VLBI Analysis Center is supported and operated by the United States Naval Observatory (USNO) in Washington, DC. The primary services provided by the Analysis Center are the analysis of diurnal experiments, the production of periodic VLBI global solutions for estimation of the Terrestrial Reference Frame (TRF), the Celestial Reference Frame (CRF), and Earth Orientation Parameters (EOP). The Analysis Center continued the submission to the IVS of Intensive (EOP-I) and session-based (EOP-S) Earth orientation parameters based on USNO VLBI global solutions. Analysis Center personnel maintain the necessary software required to continue these services to the IVS including periodic updates of the GSFC CALC/SOLVE software package. In addition to operational VLBI analysis, Analysis Center personnel are actively engaged in research related to future reference frames, the electronic transfer of VLBI data, and software correlation.

## 2 Current Analysis Center Activities

### 2.1 IVS Experiment Analysis and Database Submission

During the 2013 calendar year, personnel at the USNO VLBI Analysis Center continued to be responsible for the timely analysis of the IVS-R4 experiments, with the resulting databases submitted within 24 hours of correlation for dissemination by the IVS. Analysis Center personnel continue to be responsible for the analysis and database submission for the periodic

IVS-CRF experiments. In 2013, USNO scheduled and analyzed 12 CRF related experiments including IVS-CRF73 through IVS-CRF79 and IVS-CRDS63 through IVS-CRDS68. The analyzed databases were submitted to the IVS. Analysis Center personnel also continued analyzing IVS Intensive experiments for use in the USN-EOP1 time series and continued a new series of Intensive sessions using the VLBA antennas at Pie Town, NM and Mauna Kea, HI.

## 2.2 Global VLBI Solutions, EOP and Sinex Submission

USNO VLBI Analysis Center personnel continued to use the periodic global TRF/CRF/EOP solution usn2012b over the course of the 2013 calendar year. Analysis Center personnel continued to submit the USN-EOPS series, which is based upon the current global solution, and updated with new IVS-R1/R4 experiments. The updated EOPS series is submitted to the IVS twice weekly within 24 hours of experiment correlation and is included in the IERS Bulletin A. Analysis Center personnel also continued routine submission of Sinex format files based upon the 24-hr VLBI sessions. In addition to EOPS and Sinex series, USNO VLBI Analysis Center personnel continued to produce and submit an EOP1 series based upon the IVS Intensive experiments.

## 2.3 Software Correlator

Over the course of the 2013 calendar year, Analysis Center personnel continued the implementation, testing and evaluation of the DiFX software correlator. Phase I of the software correlator has two management nodes, 33 compute nodes (with each node having a 2.9 GHz dual-core processor with eight cores per processor for a total of 528 processing cores) and has been operating since September 2012. Phase II of the software correlator is expected to be delivered in the second quarter of 2014 and will double the processing power of the Phase I correlator. Post-correlation calibration and analysis of software correlated data is now routinely performed using the standard geodetic data reduction path including the use of the Haystack

Observatory Post-processing System (HOPS) for data calibration and the GSFC CALC/SOLVE package for data analysis.

## 2.4 VLBA Intensive Experiments

During the 2013 calendar year, Analysis Center personnel continued a program to use the Very Long Baseline Array (VLBA) operated by the NRAO for the purpose of measuring UT1–UTC. Routine daily 1.5-hour duration Intensive observations continued using the VLBA antennas at Pie Town, NM and Mauna Kea, HI. High-speed network connections to these two antennas are now routinely used for electronic transfer of VLBI data over the Internet to a USNO point of presence.

A total of 345 VLBA Intensive experiments were observed, electronically transferred to and processed at USNO in 2013. Once fully operational, these VLBA Intensive sessions will be scheduled as IVS-INT4 and data will be released to the IVS for community-wide distribution.

## 3 Staff

The staff of the VLBI Analysis Center is drawn from individuals in both the Astrometry and Earth Orientation departments at the U.S. Naval Observatory. The staff and their responsibilities are as follows:

Name	Responsibilities
Alan Fey	Periodic global CRF/TRF/EOP solutions and comparisons; CRF densification research; software correlator implementation; VLBI data analysis.
Nicole Geiger	software correlator implementation; VLBI data analysis; EOP, database and Sinex submission.
Chris Dieck	software correlator implementation; VLBI data analysis; EOP, database and Sinex submission.

## 4 Future Activities

The following activities for 2014 are planned:

- Continue analysis and submission of IVS-R4 experiments for dissemination by the IVS.
- Continue the production of periodic global TRF/CRF/EOP solutions and the submission of EOP-S estimates to the IVS updated by the IVS-R1/R4 experiments.
- Continue submission of Sinex format files based on the 24-hr experiments, and begin production of a Sinex series based upon the Intensive experiments.
- Continue the analysis of IVS Intensive experiments and submission of EOP-I estimates to the IVS.
- Continue the scheduling, analysis and database submission for IVS-CRF, IVS-CRMS and IVS-CRDS experiments.
- Continue testing and evaluation of the USNO implementation of the DiFX software correlator. Streamline pre- and post-correlation processing.
- Continue routine electronic transfer, correlation, post-processing and analysis of VLBI Intensive data from the MK and PT VLBA stations.
- Continue graphical user interface (GUI) development for the USNO implementation of the DiFX software correlator.

# USNO Analysis Center for Source Structure Report

Alan Fey, Ralph Gaume

**Abstract** This report summarizes the activities of the United States Naval Observatory Analysis Center for Source Structure for calendar year 2013 and the activities planned for the year 2014.

## 1 Analysis Center Operation

The Analysis Center for Source Structure is supported and operated by the United States Naval Observatory (USNO). The charter of the Analysis Center is to provide products directly related to the IVS determination of the “definition and maintenance of the celestial reference frame.” These include, primarily, radio frequency images of International Celestial Reference Frame (ICRF) sources, intrinsic structure models derived from the radio images, and an assessment of the astrometric quality of the ICRF sources based on their intrinsic structure.

The Web server for the Analysis Center is hosted by the USNO and can be accessed by pointing your browser to

<http://rorf.usno.navy.mil/ivs.saac/>

The primary service of the Analysis Center is the Radio Reference Frame Image Database (RRFID), a Web accessible database of radio frequency images of ICRF sources. The RRFID contains 7,279 Very Long Baseline Array (VLBA) images of 782 sources at radio frequencies of 2.3 GHz and 8.4 GHz. Additionally, the RRFID contains 1,867 images of 285 sources at

frequencies of 24 GHz and 43 GHz. The RRFID can be accessed from the Analysis Center Web page or directly at

<http://rorf.usno.navy.mil/rrfid.shtml>

The RRFID also contains 74 images of 69 Southern Hemisphere ICRF sources using the Australian Long Baseline Array (LBA) at a radio frequency of 8.4 GHz.

Images of ICRF sources can also be obtained from the Bordeaux VLBI Image Database (BVID) at

<http://www.obs.u-bordeaux1.fr/m2a/BVID>

## 2 Current Activities

Maintaining the Radio Reference Frame Image Database as a Web accessible database of radio frequency images of ICRF sources.

## 3 Staff

The staff of the Analysis Center is drawn from individuals who work at the USNO. The staff are: Alan L. Fey and Ralph A. Gaume.

---

U.S. Naval Observatory

USNO Analysis Center for Source Structure

IVS 2013 Annual Report

## 4 Future Activities

The Analysis Center currently has a program of active research investigating the effects of intrinsic source structure on astrometric position determination. Results of this program are published in the scientific literature.

The following activities for 2014 are planned:

- Continue with the imaging and analysis of VLBA 2.3/8.4/24/43 GHz experiments.
- Maintain the Radio Reference Frame Image Database (RRFID) as a Web accessible database of radio frequency images of ICRF sources.

## 5 Relevant Publications

Publications of relevance to Analysis Center activities:

- “Relativistic Jets in the Radio Reference Frame Image Database. II. Blazar Jet Accelerations from the First 10 Years of Data (1994-2003),” Piner, B. G., Pushkarev, A. B., Kovalev, Y. Y., Marvin, C. J., Arenson, J. G., Charlot, P., Fey, A. L., Collioud, A., & Voitsik, P. A. 2012, *ApJ*, 758, 84
- “Characterization of long baseline calibrators at 2.3 GHz,” Hungwe, F., Ojha, R., Booth, R. S., Bietenholz, M. F., Collioud, A., Charlot, P., Boboltz, D., & Fey, A. L. 2011, *MNRAS*, 418, 2113.
- “The Position/Structure Stability of Four ICRF2 Sources,” Ed Fomalont, Kenneth Johnston, Alan Fey, Dave Boboltz, Tamoaki Oyama, and Mareki Honma, 2011, *AJ*, 141, 91.

# Vienna Special Analysis Center Annual Report 2013

Johannes Böhm<sup>1</sup>, Sigrid Böhm<sup>1</sup>, Andreas Hellerschmied<sup>1</sup>, Armin Hofmeister<sup>1</sup>, Hana Krásná<sup>1</sup>, Matthias Madzak<sup>1</sup>, David Mayer<sup>1</sup>, Lucia Plank<sup>1</sup>, Benedikt Soja<sup>2,1</sup>, Jing Sun<sup>3,1</sup>, Claudia Tierno Ros<sup>1</sup>

**Abstract** The main activities in 2013 of the VLBI group at the Department of Geodesy and Geoinformation of the Vienna University of Technology were related to scheduling and simulations of VLBI observations, global solutions with the determination of celestial and terrestrial reference frames, and satellite observations with VLBI radio telescopes. A highlight was certainly the fourth VieVS User Workshop in September 2013 in Vienna with the release of VieVS Version 2.1.

## 1 General Information

The Department of Geodesy and Geoinformation (GEO) in the Faculty of Mathematics and Geoinformation of the Vienna University of Technology is divided into seven research groups. One of those, the research group Higher Geodesy (*Höhere Geodäsie*) with about 15 members, is focusing on satellite geodesy, system Earth, and geodetic VLBI.

## 2 Staff

Personnel at GEO associated with the IVS Special Analysis Center in Vienna (VIE) and their main research fields and activities are summarized in Table 1.

1. Vienna University of Technology
2. GeoForschungsZentrum Potsdam
3. Shanghai Astronomical Observatory

VIE Analysis Center

IVS 2013 Annual Report

The staff members are partly paid by the university and partly by project money.



**Fig. 1** Members of the Vienna VLBI group in front of the VLBI radio telescope in Metsähovi during the EVGA Working Meeting 2013 (from left): Caroline Schönberger (Master student), Matthias Madzak, Johannes Böhm, Hana Krásná, Lucia Plank, Benedikt Soja, Kamil Teke (Hacettepe University).

## 3 Activities during the Past Year

### 3.1 Global Solutions with VieVS

Our latest realizations of global reference frames are the VieTRF13b terrestrial reference frame, the VieCRF13b celestial reference frame, and the corresponding Earth orientation parameters (EOP) VieEOP13b, all of them being provided at <http://vievs.geo.tuwien.ac.at/results/> and made available as an input option in VieVS. In addition to the “operational” generation of reference frames and EOP, the global solution in VieVS was extended by



**Table 1** Staff members ordered alphabetically.

Johannes Böhm	VGOS, atmospheric effects
Sigrid Böhm	VieVS Chair (until 06/2013), Earth orientation
Andreas Hellerschmied (since 11/2013)	Satellite observations with radio telescopes
Armin Hofmeister (since 05/2013)	Ray-traced delays in VLBI analysis
Hana Krásná	VieVS Chair (since 06/2013), global solution, celestial and terrestrial reference frames
Matthias Madzak	GUIs and special files in VieVS, Earth rotation
David Mayer (since 11/2013)	Scheduling and simulation
Lucia Plank	Satellite tracking with VLBI
Benedikt Soja (until 04/2013)	Sun corona studies with VLBI
Jing Sun (until 01/2013)	Development of scheduling options
Claudia Tierno Ros (until 04/2013)	European VLBI sessions, simulations

the ability to estimate amplitudes of seasonal station motions at annual and semi-annual periods. We not only compared those variations against hydrological models, but we used that tool to investigate the propagation of neglected seasonal station movements to radio source positions (Krásná et al. 2014, [4]) and we assessed the impact on EOP by the analysis of real and artificial VLBI observations (Krásná and Böhm 2013, [2]). Several other parameters, such as antenna axis offsets or atmosphere pressure loading regression coefficients were also added to the normal equation system in VieVS.

Furthermore, the global solution in VieVS was used to analyze the European VLBI sessions. Krásná et al. (2013, [3]) published the velocities of geodetic VLBI sites as derived from all European VLBI sessions, including a comparison with two global tectonic plate models, NUVEL-1A and MORVEL, with an earlier study of European crustal motion from VLBI data presented by Haas et al. (2003, [1]), and with velocities derived from Global Navigation Satellite Systems (GNSS) observations.

### 3.2 Ray-traced Delays in the Atmosphere for Geodetic VLBI

Within the project RADIATE VLBI, funded by the Austrian Science Fund (FWF), we developed new ray-tracing software, which is capable of determining slant path delays for the complete history of VLBI observations. With the use of real meteorological weather data delivered by numerical weather models, e.g. from the European Centre for Medium-range Weather Forecasts (ECMWF), it is possible to determine the actual ray

path and calculate the slant path delay for each observation. In 2013, we successfully set up the routines for global grids of meteorological data ( $0.125^\circ$ ) and validated the delays against those from an international comparison campaign of ray-tracing software (Nafisi et al., 2012, [5]).

### 3.3 VLBI Observations to Satellites

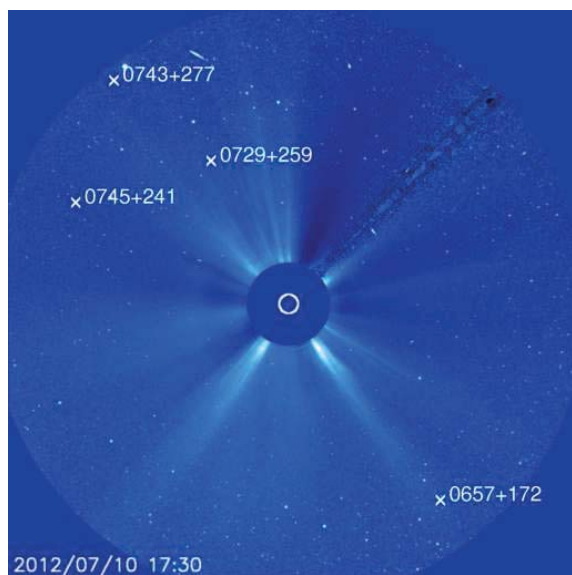
At GEO Vienna, research on VLBI observations to satellites is ongoing. Within the research project *D – VLBI*, which is part of the DFG Research Unit *Space-Time Reference Systems for Monitoring Global Change and for Precise Navigation in Space*, a number of simulation studies using VLBI observations to Earth satellites were performed. The goal of these investigations was to determine station position repeatabilities from either weekly or session-wise VLBI satellite observations. After certain amendments of VieVS, such observations can now also be integrated into routine VLBI sessions, and a combined analysis, e.g. estimating common clocks and the troposphere, is possible. As documented in several publications on this topic, we identified observation strategies to determine station position repeatabilities at the sub-centimeter level, respectively frame ties in terms of Helmert parameters between the GNSS frame and the VLBI frame of better than 1 millimeter (Plank, 2013, [6]; Plank et al., 2013, [7]).

Although some satellite observation experiments have been conducted in the recent years, it has not become a routine operation. To overcome that limitation, Andreas Hellerschmied in his Master thesis has expanded the current Vienna VLBI Software by adding a module capable of generating satellite observation

schedules, where the observation plan is set up in an interactive process. The schedule files (VEX format) can then be used to perform real experiments. During this project a close cooperation with the Geodetic Observatory Wettzell (<http://www.bkg.bund.de/Wettzell>) evolved. This collaboration made it possible to perform tests on site and to prove the viability of the developed software utilizing the instruments at this station.

### 3.4 Assessing the Sun Corona with VLBI

By using the observational data of twelve dedicated VLBI experiments in 2011 and 2012, the electron density of the solar corona was determined. It was the first time that VLBI data was used for this purpose. The results agree well with those obtained by different techniques such as spacecraft tracking (Soja et al., 2013, [8]). The effect of the coronal plasma had to be separated from other dispersive effects caused by the ionosphere and hardware delays. As a byproduct of our investigations, a procedure to estimate the ionospheric total electron content of each radio telescope was implemented into VieVS.



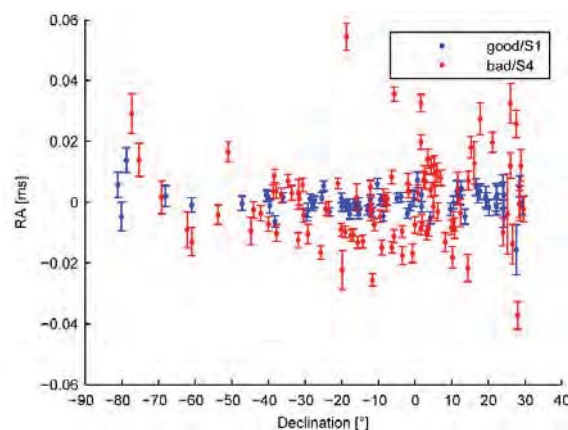
**Fig. 2** Constellation of Sun corona and close radio sources on 10 July 2012 at 17:30 UT.

### 3.5 Scheduling and Simulations

Scheduling and simulations with VieVS have played a very important role for the Vienna VLBI group in 2013. This is certainly based on the close cooperation with Jing Sun who returned to Shanghai Astronomical Observatory in February 2013. She has made further amendments to the scheduling tool of VieVS, e.g. by providing the tag-along mode capability and other refinements. The scheduling tool in VieVS (Vie\_SCHED, Sun et al., 2014, [9]) is now used operationally to schedule the AUSTRAL VLBI sessions.

Additionally, Vie\_SCHED has been used to schedule the continuous VLBI campaign in November/December 2013 with stations in Australia, New Zealand, and South Africa. This campaign has been carried out to demonstrate the capabilities of the southern stations and to investigate the influence of sources with high structure index on geodetic results. Figure 3 shows simulation results of source coordinate estimates in right ascension for “good sources” (structure index 1) and “bad sources” (structure index 4).

Furthermore, there have been studies with the schedul-



**Fig. 3** Simulation results of estimates of source positions in right ascension as derived from simulations for the 15 day continuous VLBI campaign with stations in Australia, New Zealand, and South Africa.

ing and simulation tools in VieVS to demonstrate the importance of specific VLBI sites. For example, we evaluated the importance of the Hartebeesthoek Radio Astronomy Observatory (HartRAO) for the current and future VLBI network. The results suggest that HartRAO is of high importance for the estimation of

EOP. In particular polar motion and nutation estimates benefit from HartRAO's remote location. Based on scheduling and simulation analysis of the VLBI2010 network, an upgrade from the current antenna to a fast slewing VLBI2010 antenna was recommended.

#### 4 Future Plans

In 2014, we will continue the development of VieVS, with special focus on satellite tracking, scheduling, and the estimation of terrestrial and celestial reference frames. In particular, we will contribute to the ITRF2013, and we will organize the 5th VieVS User Workshop in September 2014.

#### Acknowledgements

We are very grateful to the Austrian Science Fund (FWF) for supporting our work through projects P23143 (Integrated VLBI), P25320 (RADIATE VLBI) and P24813 (SPOT). We also acknowledge the German Research foundation (DFG) for funding project D-VLBI (SCHU 1103/4-1).

#### References

1. R. Haas, A. Nothnagel, J. Campbell, E. Gueguen. Recent crustal movements observed with the European VLBI network: geodetic analysis and results. *J Geodyn*, 35, pp. 391–414, 2003.
2. H. Krásná, J. Böhm. Impact of seasonal station motion on global reference frames and Earth rotation. *AGU Fall Meeting*, Poster G13B-0936, San Francisco, USA, 2013.
3. H. Krásná, C. Tierno Ros, P. Pavetich, J. Böhm, T. Nilsson, H. Schuh. Investigation of crustal motion in Europe by analysing the European VLBI sessions. *Acta Geodaetica et Geophysica*, 48/4, pp. 389–404, 2013.
4. H. Krásná, Z. Malkin, J. Böhm. Impact of seasonal station displacement models on radio source positions. *Proceedings of the Journées 2013*, Paris, September 2013, submitted 2014.
5. V. Nafisi, L. Urquhart, M. Santos, F. Nievinski, J. Böhm, D. Wijaya, H. Schuh, A. Ardalán, T. Hobiger, R. Ichikawa, F. Zus, J. Wickert, P. Gegout. Comparison of Ray-Tracing Packages for Troposphere Delays. *IEEE Transactions on Geoscience and Remote Sensing*, Vol. 50, No. 2, pp. 469–481, 2012.
6. L. Plank. VLBI satellite tracking for the realization of frame ties. *Dissertation at the Vienna University of Technology*, <http://www.ub.tuwien.ac.at/diss/AC11121594.pdf>, 2013.
7. L. Plank, J. Böhm, H. Krásná, H. Schuh. VLBI satellite tracking for precise coordinate determination - a simulation study. *Proceedings of the 21st Meeting of the European VLBI Group for Geodesy and Astrometry*, N. Zubko, M. Poutanen (ed.), ISBN: 978-951-711-296-3, pp. 105–109, 2013.
8. B. Soja, J. Sun, R. Heinkelmann, H. Schuh, J. Böhm. Sun Corona Electron Densities Derived from VLBI Sessions in 2011/2012. *Proceedings of the 21st Meeting of the European VLBI Group for Geodesy and Astrometry*, N. Zubko, M. Poutanen (ed.), ISBN: 978-951-711-296-3, pp. 159–163.
9. J. Sun, J. Böhm, T. Nilsson, H. Krásná, S. Böhm, H. Schuh. New VLBI2010 scheduling strategies and implications on the terrestrial reference frames. *Journal of Geodesy*, in press 2014.



# Technology Development Centers





# Canadian VLBI Technology Development Center Report

Bill Petrachenko

**Abstract** The Canadian VLBI Technology Development Center (TDC) is involved in activities related to the realization of the VLBI Global Observing System (VGOS).

- Compilation of a memo on mixed mode observing issues.
- Analysis of RFI survey responses.
- Development of FPGA code for VGOS digital back ends.

In addition, NRC is involved in a number of Square Kilometer Array (SKA) related activities that have potential applications to the IVS.

## 1 General Information

The Canadian TDC is a collaborative effort of the National partners interested in the advancement of VLBI technology, namely the Canadian Geodetic Survey (CGS) of Natural Resources Canada (NRCan) and the Dominion Radio Astrophysical Observatory (DRAO) of the National Research Council of Canada (NRC).

- Digital signal processing including development of correlators, beam formers, and systems for pulsar processing.
- Fabrication of a light, stiff, and cost effective 15-m off-axis Gregorian top-fed composite antenna.
- Development of focal plane arrays.

## 2 Activities during the Past Year

The Canadian TDC is primarily focused on encouraging the realization of VGOS. This is done by Bill Petrachenko of NRCan who is the IVS Technology Development Coordinator, the chairman of the VGOS Technical Committee (VTC), and a member of the VGOS Project Executive Group (VPEG). In collaboration with others, this year's activities focused on the following areas:

- Development of the VGOS Observing Plan.
- Compilation of a comparison of VGOS recorders.

## 3 Future Plans

The Canadian TDC plans to continue to actively encourage the realization of VGOS.

---

Canadian Geodetic Survey, Natural Resources Canada

Canadian VLBI Technology Development Center

IVS 2013 Annual Report

# GSFC Technology Development Center Report

Ed Himwich, John Gipson

**Abstract** This report summarizes the activities of the GSFC Technology Development Center (TDC) for 2013 and describes plans for 2014. The GSFC TDC develops station software including the Field System (FS), scheduling software (SKED), hardware including tools for station timing and meteorology, scheduling algorithms, and operational procedures. It provides a pool of individuals to assist with station implementation, check-out, upgrades, and training.

## 1 Technology Center Activities

The GSFC IVS Technology Development Center (TDC) develops hardware, software, algorithms, and operational procedures. It provides manpower for station visits for training and upgrades. Other technology development areas at GSFC are covered by other IVS components such as the GSFC Analysis Center. The current staff of the GSFC TDC consists of John Gipson, Ed Himwich, and Rich Strand, all employed by NVI, Inc. The remainder of this report covers the status of the main areas supported by the TDC.

## 2 Field System

The GSFC TDC is responsible for development, maintenance, and documentation of the Field System (FS) software package. The FS provides equipment con-

trol at VLBI stations. It interprets the .snp schedule and .prc procedure files (both as prepared by DRUDG from the .skd schedule). The FS controls the antenna, data acquisition hardware, and related ancillary equipment needed for making VLBI measurements. All major VLBI data acquisition backends are supported. The FS is customizable to allow it to control station specific equipment. It is used at almost all the IVS Network Stations (more than 35) and also at many stations that do VLBI only for astronomical observations. The only major VLBI facilities not using it are the VLBA and VERA.

There was one minor release of the FS (9.11.0) during this year. Full details can be found in the FS release notes, but some of the major changes are listed here:

- Support for the DBBC DDC personality was added, both for continuous and on-off noise diodes.
- A work around for the “Day 49” kernel issue was included.
- A new version of the *gnplt* program, written in Python, was included.
- A new command, *satellite*, was added to allow simple pointing at satellites.
- A new command, *holog*, was added to facilitate collecting data from holographic antenna measurements.
- The pointing data analysis programs were modified to plot first antenna coordinate offsets in “cross” coordinate units, e.g., to use “Cross-El” instead of Azimuth and to use “cross” coordinate reweighting constants when fitting the first coordinate offsets.
- The metserver/metclient programs were improved to better support multiple clients.
- The handling of Mark 5 communications was improved to prevent partial responses from terminat-

---

NASA Goddard Space Flight Center

GSFC Technology Development Center

IVS 2013 Annual Report



ing input prematurely. There were general improvements to error messages for Mark 5 communications.

In addition several development projects were underway. These include:

- Patriot 12 m Interface. Development of the interface for Patriot Antenna Control Unit (ACU) continued. Several improvements were made including the handling and the reporting of status word represented errors and improvements in cable-wrap handling to make it independent of the limits for any particular antenna.
- Mark 5C/RDBE. Preliminary support for Mark 5C recorders and RDBE DASs was developed to facilitate VGOS test activities. This support will be fed into the distributed FS next year.
- Miscellaneous. Many small improvements and bug fixes were made for the new releases expected in 2014. These included a new “time-out” feature for the *onsource* command to facilitate local antenna measurements, making all DBBC IF power measurement displays all consistent support for the DBBC astro2 mode, and preventing the changing of schedules while recording.
- VEX2. Considerable effort has gone into defining the second version of VEX, which will provide schedule file format support for new “sampling-before-channelization” systems such as the RDBE.

## 2.1 Plans for 2014

Several other improvements are expected in future releases, including:

- Support for RDBE racks.
- Support for DBBC PFB personality.
- Support for Mark 5C and Mark 6 recorders.
- Use of *idl2rpc* for remote operation.
- A complete update to the documentation and conversion to a more modern format that will be easier to use and maintain.
- Conversion of the FORTRAN source to use the *gfortran* compiler, which will enable use of the source level debugger, *gdb*, for development and field debugging.
- *Chekr* support for Mark 5A and Mark 5B systems.

- FS Linux 9 (based on Debian *wheezy*, skipping *squeeze*) distribution.
- Support for periodic firing of the noise diode during observations.
- Support for NMEA standard wind sensors.
- Completion of the VEX2 standard and implementation of it.

## 3 SKED and DRUDG

The GSFC TDC is responsible for the development, maintenance, and documentation of SKED and DRUDG. These two programs are very closely related, and they operate as a pair for the preparation of the detailed observing schedule for a VLBI session and its proper execution in the field. In the normal data flow for geodetic schedules, first SKED is run at the Operation Centers to generate the .skd file that contains the full network observing schedule. Then stations use the .skd file as input to DRUDG for making the control files and procedures for their station. Catalogs are used to define the equipment, stations, sources, and observing modes which are selected when writing a schedule with SKED.

Changes to SKED and DRUDG are driven by changes in equipment and by feedback from the users. The following summarizes some of the important changes to these programs in 2012.

### 3.1 SKED Changes

- Better calculation of SNR. The calculation now includes the effects of 1- and 2-bit sampling and the correlator efficiency factor.
- Addition of the descriptive parameters “SCHEDULING\_SOFTWARE”, “SOFTWARE\_VERSION”, and “SCHEDULE\_CREATE\_DATE”. This was done because *vie-sched* is now being used to write some schedules, and we wanted to be able to tell which software wrote a schedule.
- Addition of the \$BROADBAND section to the schedule file, which provides limited support for broadband. This section lists the stations that are observing in broadband and gives the bandwidth of the observing.

- Correction of a problem with adding a station to a schedule that already has observations. This problem occurred because each station has a preferred one-character station code. It is possible to have two stations with the same preferred code in the same schedule. In this case, one of the stations will use another code. Previously, if you added a station to a schedule and the one-letter code of the station was already in use, sked would sometimes change the code for a station in the schedule.

### **3.2 DRUDG Changes**

Many changes were made to support new equipment in the field, particularly DBBCs. A fuller description can be found in the FS release notes.

### **3.3 Plans for 2014**

Plans for 2014 include the following:

- In 2012, we began work on making VEX the native format for SKED. We plan to finish this project in 2014.
- We also plan to expand support for RDBEs and DBBCs. This will involve changes to SKED, DRUDG, and the catalogs.
- If time permits, we will convert SKED to compile using a freely available compiler such as *gfortran*.

# Haystack Observatory Technology Development Center

Christopher Beaudoin, Arthur Niell, Roger Cappallo

**Abstract** Technology development at MIT Haystack Observatory focused on three areas in 2013:

- Mark 6
- RDBE 3.0
- KPGO 20-m VGOS Receiver Upgrade

## 1 Mark 6 High Speed Data Recorder

In 2013, the development and the implementation of the Mark 6 recording system continued. The software can now record up to four 2 Gb/s Mark 5B streams, which are converted on the fly to vdif datastreams differentiated by thread ID. A single 8 disk module in good health is able to record that 8 Gb/s datarate, or slightly less. Given that the Mark 6 has a  $\sim 60$  GB ram buffer, the fifo allows scans of several minute duration to be captured in this mode, so long as there is some time between scans for draining the fifo. Using the nominal 2-module/16-disk configuration, the full datastream can be recorded continuously. Similarly, a 16 Gb/s input data rate can be captured for short periods in two modules (= 16 disks), although for continuous recording four modules should be used.

Manufacture of the Mark 6 was transferred to Conduant Corp., and they began filling orders mid-year. The software is open source, and it is available on the Haystack website. In addition to the Mark 6 control software, there are various utilities there to allow for data quality assessment, as well as interim conver-

sion software for use at correlators. A python program called RM6\_CC allows for control of the hardware via an XML schedule. Multiple test observation sessions were held, employing Mark 6s at the Westford and GGAO antenna sites.

## 2 RDBE Version 3.0

Development of a new RDBE firmware version 3.0 was initiated in 2013. The RDBE v3.0 is an operations-oriented personality that represents an enhancement to the RDBE v1.4 personality. The version 3.0 personality incorporates a number of operations and diagnostic capabilities that include the following:

- Integrated 1PPS Delay Measurement
- Pulse Calibration Extraction
- 1PPS-triggered raw ADC capture
- Arbitrary test vector injection

In addition to these features, the v3.0 firmware represents a complete re-engineering of the v1.4 PFB firmware code. This new development simplified the firmware signal processing and has been verified against the theoretical PFB algorithm implemented in a MATLAB model. The verification process ensures that the RDBE v3.0 signal processing that is implemented on the Xilinx FPGA IC is performing the correct operations, and it is anticipated that a test vector procedure will be incorporated to verify field installations of the RDBE running this personality. This verification process is conducted by introducing a known digital test vector at the frontend (input) port of the FPGA, recording the resultant output 2-bit samples generated by the FPGA operations, and

---

MIT Haystack Observatory

Haystack Technology Development Center

IVS 2013 Annual Report

directly comparing (differencing) the RDBE output samples to the theoretical sample values computed by the MATLAB model.

As part of the v3.0 firmware development, the RDBE server software, which interprets commands from an external RDBE user, was rewritten to incorporate the additional firmware features that are available in the v3.0 firmware. As part of the re-write, the complexity was reduced from approximately 50,000 lines of code to approximately 4,000 lines.

The server software also captures VLBI-critical diagnostic data on each 1PPS pulse, packages the data into a multicast network packet, and transmits the data over the 1 GigE network interface for reception by any client listening on the designated network port. This diagnostic data includes the current UT time as maintained by the RDBE firmware as well as the delay offsets of this clock relative to the RDBE operating system clock (i.e., server clock), the GPS 1PPS signal, and the MASER 1PPS signal. Also contained in this multicast packet are the samples of the pulse calibration signal as reconstructed by the pulse calibration extraction feature and the first 4,000 samples of the 8-bit frontend ADC samples as triggered by the RDBE 1PPS.

The server also provides an information-rich numerical and graphical output data display that is intended to provide feedback to the RDBE user. This graphical display updates on each 1PPS pulse and plots the ADC raw capture samples with the associated histogram and spectrum. This display also plots the reconstructed pulse calibration signal and the noise diode on and off accumulator counts for each PFB frequency channel. Figure 1 displays an example of the RDBE server's graphical output display.

### 3 KPGO 20-m VGOS Receiver Upgrade

In 2013, Haystack Observatory developed and fabricated a VGOS receiver frontend upgrade for the KPGO 20-m radio telescope. Diagrams of the new receiver frontend are shown in Figure 2. The receiver enclosure, which is identical in design to the existing S/X KPGO 20-m receiver enclosure, was provided by NASA/Excelsis and was recovered from a decommissioned/damaged NASA radio telescope. Haystack refurbished the receiver enclosure and developed a full 3D mechanical design in the CAD software suite

SolidWorks. This mechanical model also serves as electronic documentation for the KPGO site personnel and can be viewed by downloading a free SolidWorks viewer available at the software vendor's website.

Similar to previous Haystack broadband receiver frontend designs, the KPGO frontend incorporates a customized QRFH feed. This feed was optimized for the 0.43 focal-length-to-diameter ratio characteristic of the KPGO 20-m optics. Receive pattern measurements of the cryogenic frontend demonstrate that the expected broadband aperture efficiency of the KPGO 20-m VGOS system should be approximately 50% over the 2 to 14 GHz frequency range as shown in Figure 3. The measured noise temperature of the new 20-m VGOS receiver frontend is shown in Figure 4. Based on these noise temperature and aperture efficiency estimates, the SEFD of the KPGO 20-m telescope following the VGOS upgrade is expected to be approximately 900 Jy which is equivalent to that of the X-band section in the existing system. The VGOS receiver frontend upgrade for the KPGO 20-m antenna was delivered to Kokee Park in September 2013.

Presently, a failure in the KPGO 20-m frontend receiver "box" rail system is inhibiting removal of the S/X band receiver frontend section from the antenna. Installation of the VGOS frontend is awaiting mechanical refurbishment of this rail mechanism.

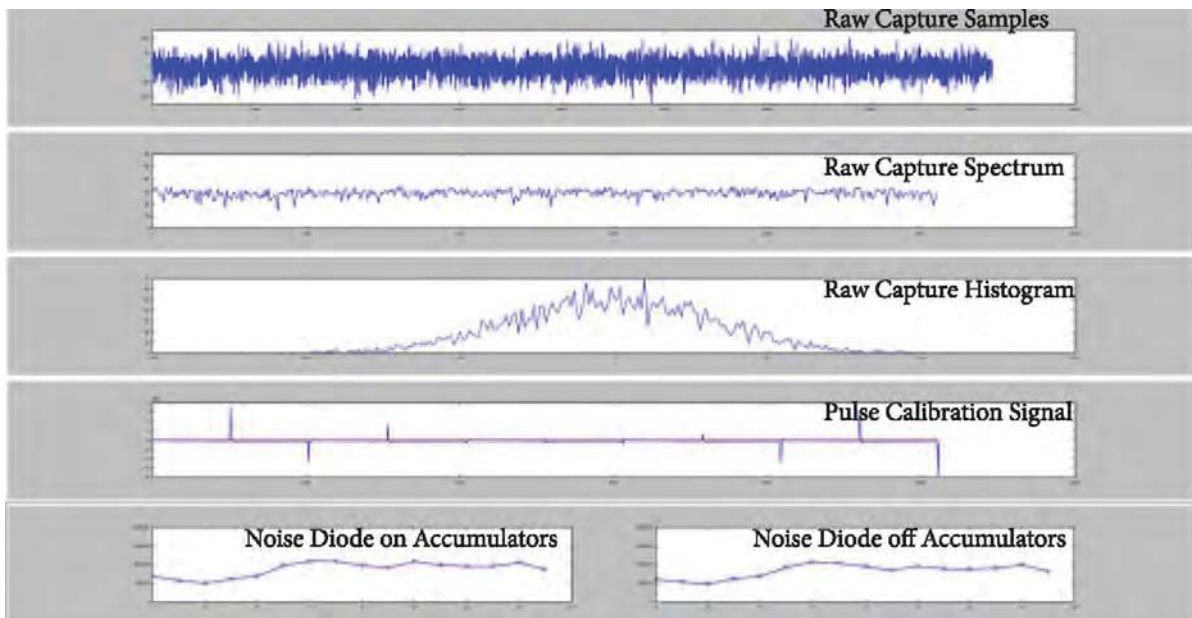


Fig. 1 Graphical output display generated by the RDBE v3.0.

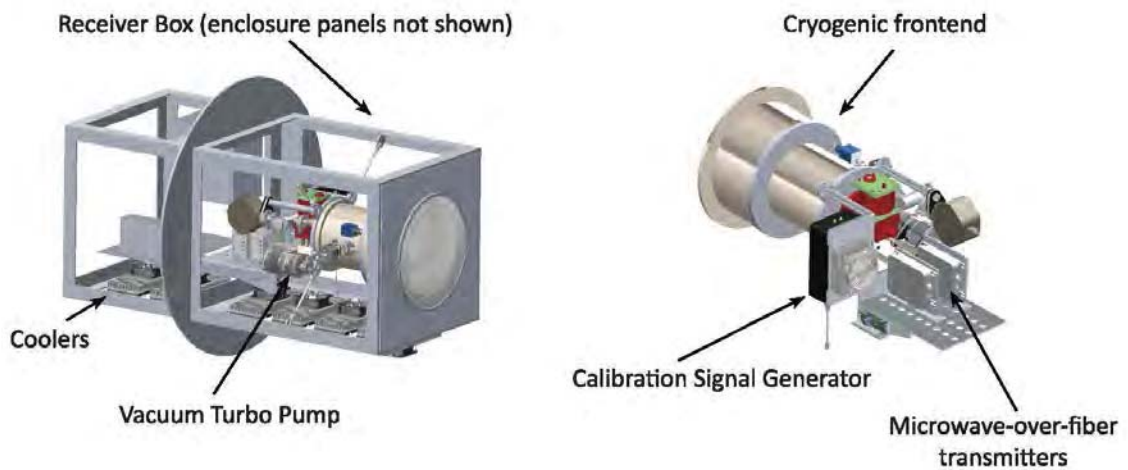


Fig. 2 KPGO 20-m VGOS receiver frontend upgrade.

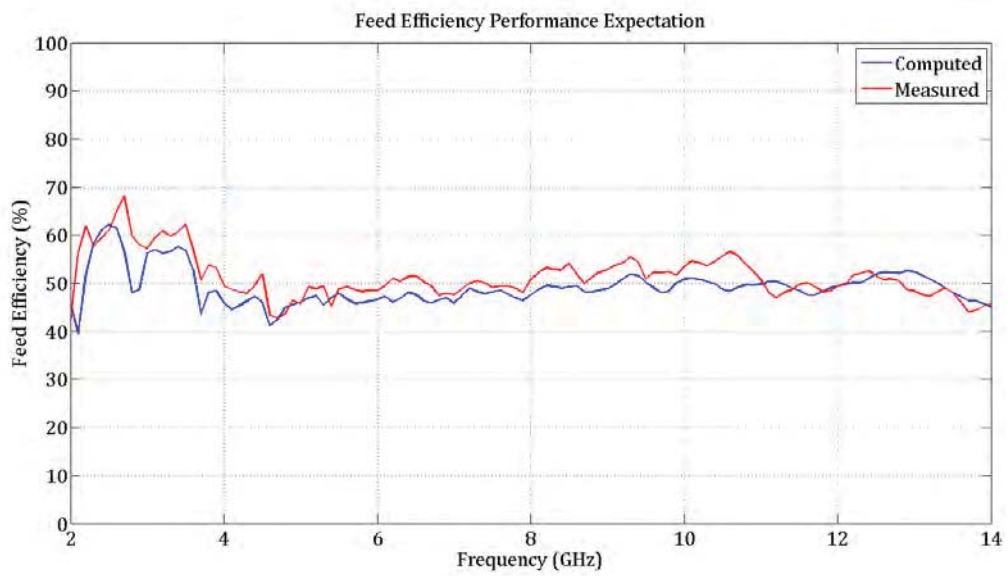


Fig. 3 Expected aperture efficiency of the KPGO 20-m following the VGOS receiver frontend upgrade.

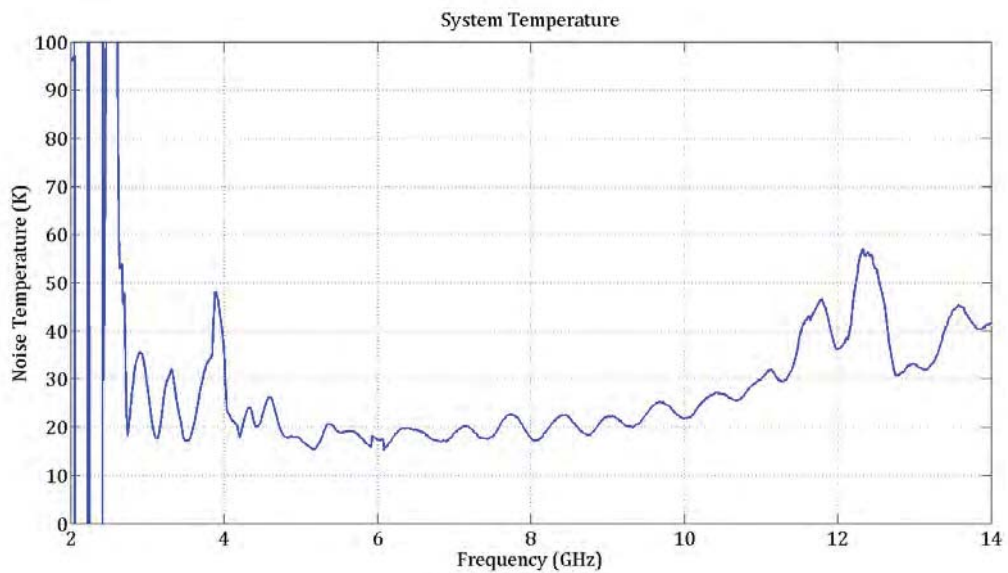


Fig. 4 Noise temperature of the KPGO 20-m VGOS receiver frontend upgrade.

# NICT Technology Development Center 2013 Annual Report

Kazuhiro Takefuji, Hideki Ujihara

**Abstract** The National Institute of Information and Communications Technology (NICT) is developing and testing VLBI technologies and conducts observations with this new equipment. This report gives an overview of the Technology Development Center (TDC) at NICT and summarizes recent activities.

**Table 1** Staff Members of NICT TDC as of January 2013 (alphabetical).

HASEGAWA, Shingo	HOBIGER, Thomas
ICHIKAWA, Ryuichi	KAWAI, Eiji
KONDO, Tetsuro	KOYAMA, Yasuhiro
MIYAUCHI, Yuka	SEKIDO, Mamoru
TAKEFUJI, Kazuhiro	TSUTSUMI, Masanori
UJIHARA, Hideki	

## 1 NICT as IVS-TDC and Staff Members

The National Institute of Information and Communications Technology (NICT) publishes the newsletter “IVS NICT-TDC News (formerly IVS CRL-TDC News)” at least once a year in order to inform about the development of VLBI related technology as an IVS Technology Development Center. The newsletter is available at a following URL <http://www2.nict.go.jp/aeri/sts/stmg/ivstdc/news-index.html>. Table 1 lists the staff members at NICT who are contributing to the Technology Development Center.

## 2 General Information

We have been developing a new VLBI system called Gala-V, which has the VGOS (VLBI2010 Global Observing System) requirements. Distinguishing features of Gala-V are a direct sampler called Galas and a

Kashima Space Technology Center, National Institute of Information and Communications Technology

NICT Technology Development Center

IVS 2013 Annual Report

broadband feed horn called Iguana. Here we will report the current activities. First, we evaluated a jitter and frequency response of Galas. Secondly, a prototype of Iguana feed was deployed to the Kashima 34-meter antenna at the end of December 2013. We could detect simultaneously methanol maser lines of 6.7 GHz and 12.2 GHz from the star forming region W3OH.

## 3 Evaluation of Direct Sampler Galas

The broadband signal from 1 GHz to 18 GHz transfers without frequency conversion via a high sensitivity optical transmitter and receiver from the antenna to the sampler Galas. For this reason, Gala-V has a quite simple system. Actually, our system has no analog frequency conversion, but we realized the down-conversion with high order sampling and digital baseband conversion by digital signal technique inside Galas. Figure 1 shows the design of Galas. It has four analog inputs and four 10 GbE outputs. Galas will sample an input signal at 16 GHz speed and 3-bit quantization and will perform digital frequency conversion. At first, we evaluated jitter performance

and a frequency response. We input the sinusoidal signal from a signal synthesizer to Galas at each frequency, then calculated the phase noise as a jitter from the digitized signal. The jitter is shown in Figure 2, where we obtain a result of 0.191 picoseconds. We expect good sampler performance even at the frequency of 20 GHz based on the obtained jitter values. Figure 3 shows the frequency response of Galas from comparing the amplitude from quantized bit distribution between reference signal and target signal.

In 2013, we conducted VLBI experiments between the direct sampler Galas and the existing wideband sampler ADS3000+ of 1 GHz bandwidth. And we had successfully obtained a consistent geodetical result. We have more plans for broadband VLBI after Iguana feed installation.

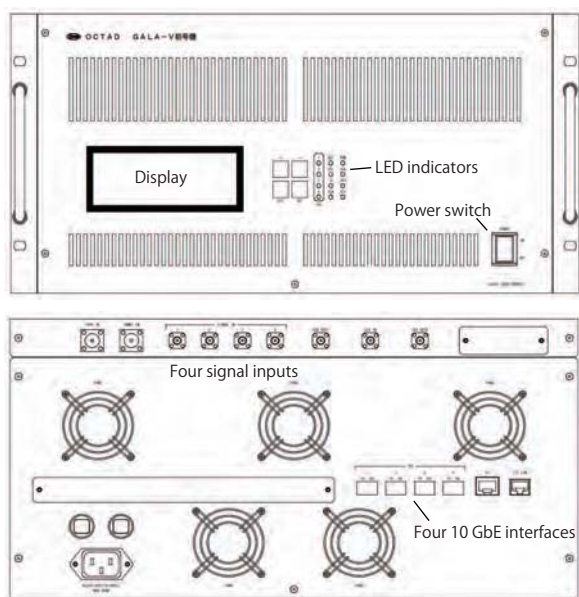


Fig. 1 The design of the direct sampler Galas.

#### 4 Developing the Broad Band Feed Iguana

The prototype Iguana feeds were multimode horns, which were designed for 6.4-15 GHz. Their beam patterns were measured at Microwave Energy Transmission Laboratory (METLAB) in Kyoto University. The first prototype of 133 mm aperture diameter was set on

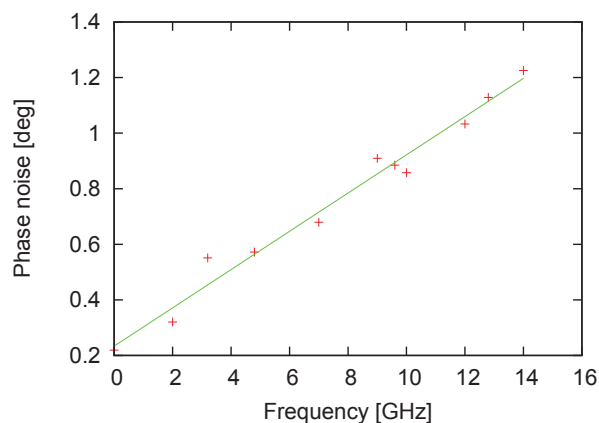


Fig. 2 The jitter performance of the direct sampler Galas.

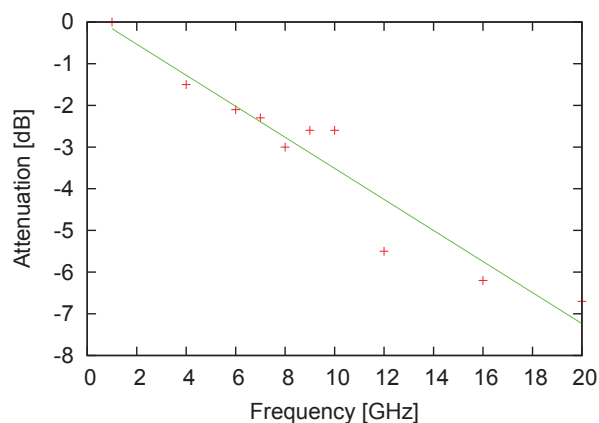


Fig. 3 The frequency response of the direct sampler Galas.

the Kashima 34 meter for testing our wideband front-end system. The aperture size of the second feed is 120 mm.

They can be replaced to select the most efficient frequency for various observations. Also, waveguide high-pass filters are ready for  $f_{cut}=6.4$  GHz, 8.0 GHz, and 9.6 GHz cut-off frequencies to suppress RFI, following WRD580 waveguide and SMA adapter output.

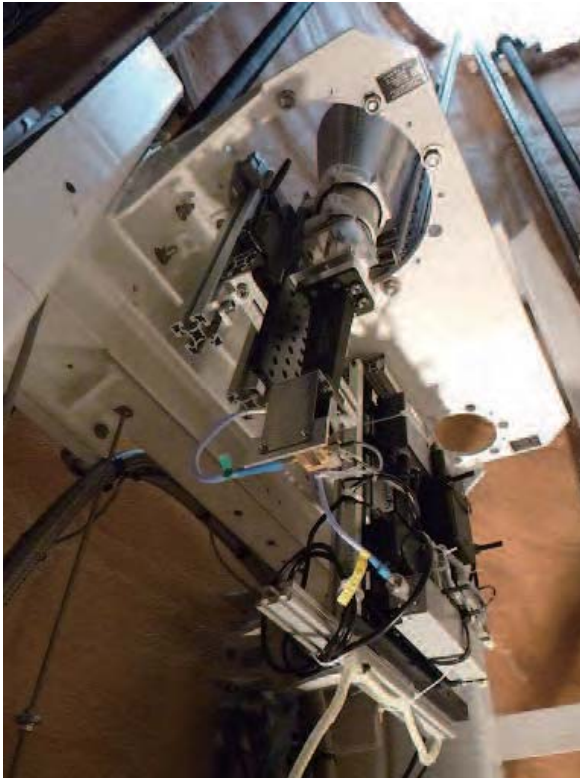
Our configuration is for one linear polarization now.

#### 5 First Light of Gala-V, Deployed to the Kashima 34-Meter Antenna

We have deployed the prototype feed to the Kashima 34-meter antenna. The feed after deployment is shown



in Figure 4. The Kashima 34-meter antenna has four pedestals for the feed and receiver. We can choose one pedestal from four pedestals moving exclusively. Figure 5 shows two methanol lines at 6.7 GHz and 12.2 GHz from the star forming region W3OH detected by the Gala-V system. It was a memorable first light. The system temperature of the prototype system is shown in Figure 6. We are currently using ambient temperature LNA; thus the system temperatures are plausible. The aperture efficiency of the prototype feed is also shown in Figure 7. Until 12 GHz, the efficiency is about 40%. Then the efficiency begins to decrease, to 20% at 15 GHz with the first prototype feed.

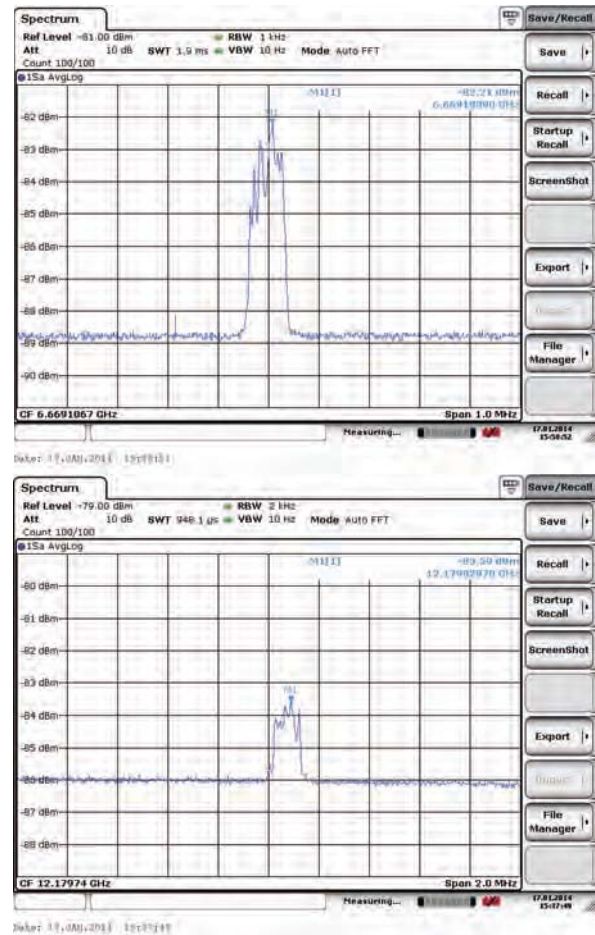


**Fig. 4** The prototype Iguana feed was deployed to the Kashima 34-meter antenna

## 6 Future Plans

The upgrade to the Kashima 34-m antenna for wider bandwidths such as 2.2-18 GHz is on-going. The Iguana and broadband receiver will be fully in-

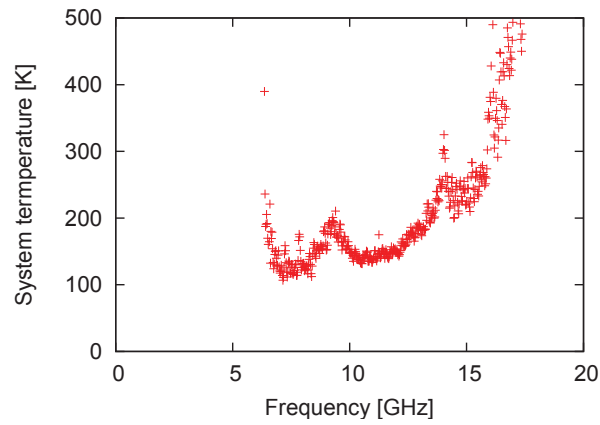
stalled by this spring, and we will install a new dual polarization feed by next winter.



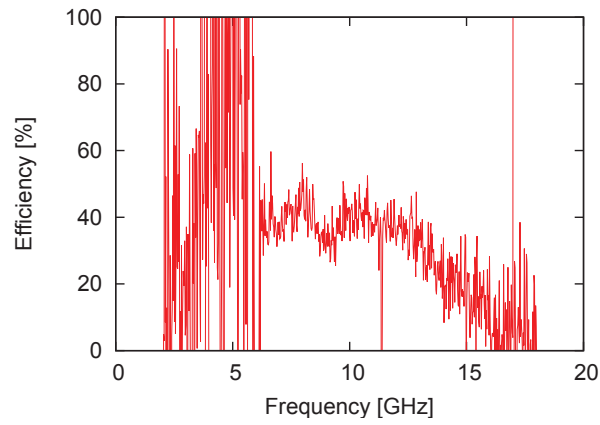
**Fig. 5** The first light of methanol maser of W3OH. The methanol lines of 6.7 GHz and 12.2 GHz were simultaneously obtained.

## Acknowledgements

The development of Gala-V is supported by a joint development of National Astronomical Observatory Japan (NAOJ). It is titled “Development of ultra broadband system for Kashima 34 meter antenna”.



**Fig. 6** Gala-V system temperature with the prototype Iguana feed.



**Fig. 7** Gala-V aperture efficiency with the prototype Iguana feed.

# Onsala Space Observatory – IVS Technology Development Center Activities during 2013

Miroslav Pantaleev<sup>1</sup>, Rüdiger Haas<sup>1</sup>, Bhushan Billade<sup>1</sup>, Leif Hellndner<sup>1</sup>, Karl-Åke Johansson<sup>1</sup>, Lars Petterson<sup>1</sup>, Marianna Ivashina<sup>2</sup>, Jian Yang<sup>2</sup>, Carlo Bencivenni<sup>2</sup>, Oleg Iupikov<sup>2</sup>

**Abstract** We give a brief overview on the technical development related to geodetic VLBI done during 2013 at Onsala Space Observatory.

## 1 Activities during 2013

Our activities in technical development for VLBI concentrated on the following topics:

- The Onsala Twin Telescope project
- Broadband feeds for VLBI2010 operations
- A dual-polarized S-band system
- A new IF distribution
- A GNSS installation for local-tie measurements.

## 2 The Onsala Twin Telescope Project

We worked on the preparation of the procurement documents for the Onsala Twin Telescope (OTT). We decided to separate the procurement into two parts. One part exclusively covers the antennas while the other part covers the signal chain and electronics. The request for a building permit for the OTT and the request for an exemption from the law for shoreline protection (i.e., a permit for construction within 300 m from the shoreline) had been submitted to the Kungsbacka municipality already in late 2012. The local au-

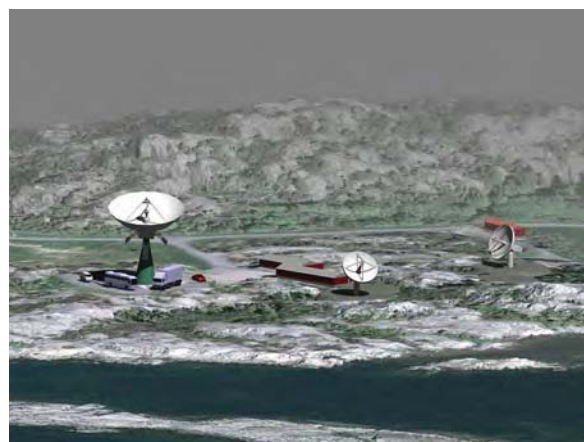
thorities in Kungsbacka community granted both necessary permits in early April 2013. The environmental department of the next level of authority, the county of Halland, inspected the planned area for the OTT in May 2013. The inspector concluded that one of the two planned telescopes, at the eastern location, could be a potential disturbance for the local birdlife and in particular disturb the breeding of waders in the area. At the time of the inspection several birds of the Northern Lapwing (*vanellus vanellus*) family were seen in the wetlands. Additionally, the county has plans to include these wetlands into a natural reserve. As a consequence, the county decided in June 2013 to withdraw the exemption from the law for shoreline protection. This meant a temporary stop for the whole project, because now a new location for the second telescope had to be found. Besides nature protection and local

1. Chalmers University of Technology, Department of Earth and Space Sciences, Onsala Space Observatory

2. Chalmers University of Technology, Department of Signals and Systems, Antenna Systems

OSO Technology Development Center

IVS 2013 Annual Report

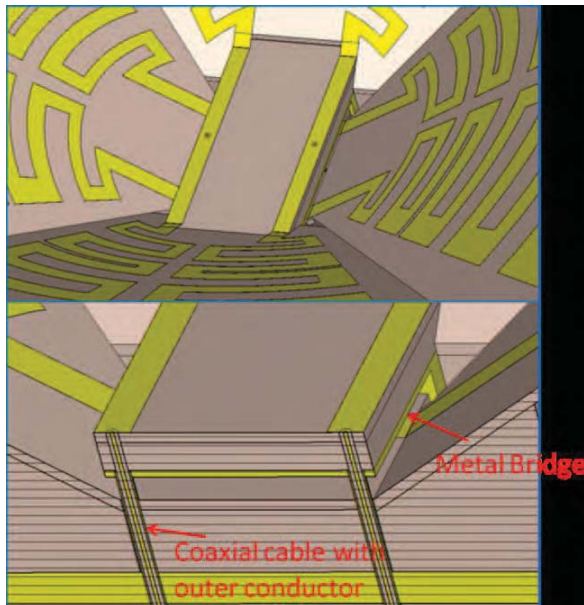


**Fig. 1** An artist's impression of the planned Onsala Twin Telescope (the two smaller antennas on the right side) together with the existing 25-m antenna (left). This is the new updated proposal of December 2013.

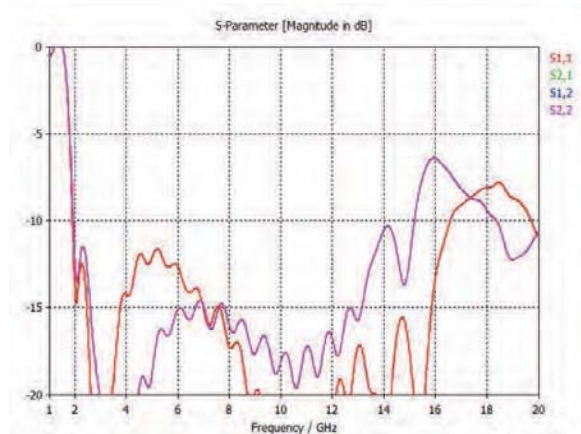
birdlife, another difficulty is a number of archeological findings from the Iron Age that need to be protected. After several discussions with the Kungsbacka authorities, an environmental consultant, and the county's archeologist, a suitable location for the second telescope was found. A corresponding request for a building permit and request for an exemption from the law for shoreline protection was submitted to the Kungsbacka municipality in December 2013. An artist's impression of the new planned OTT location is presented in Figure 1.

### 3 Broadband Feeds for VLBI2010

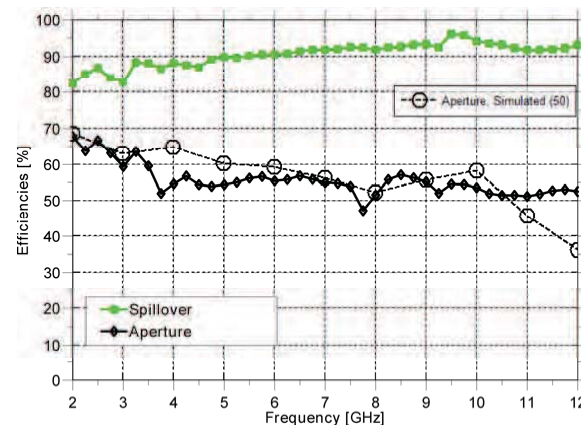
We continued our collaboration with the Gothenburg-based company Omnisys Instruments. We provided support for the cryogenic and mechanical design of a cryostat for the integration of the Eleven Feed and for further issues related to system integration and tests. We worked on three parallel tracks of the Eleven feed development. The first one is the implementation of a center-bridge connection between the opposite ports of the Eleven Feed (see Figure 2). This concept was successfully implemented in a feed for the 0.4–2 GHz



**Fig. 2** Geometry of the center-bridge connection for the Eleven feed. Upper plot: center connection. Lower plot: cross section.



**Fig. 3** Reflection coefficients for both polarization ports of the designed Quad Ridged Feed Horn (QRFH).



**Fig. 4** Aperture efficiency (black dashed line) of a prime-focus reflector antenna system with a subtended semi-angle of 50 degrees fed with the simulated far-field patterns of the designed Quad Ridged Feed Horn (QRFH). Also shown are (black solid line) corresponding results published by [1] which are based on measured patterns.

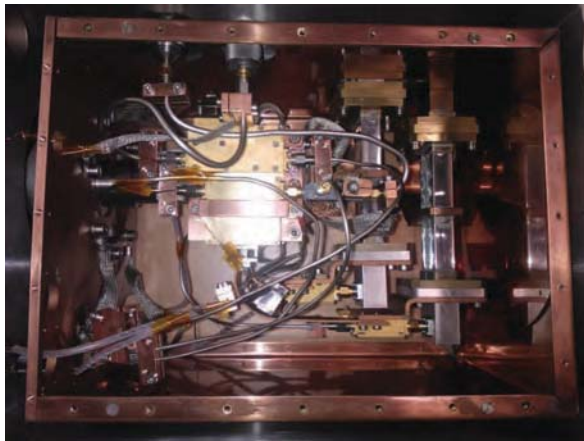
range. Currently we are investigating different fabrication approaches and technologies to implement this solution for the VLBI2010 frequency range. The second development track was the implementation of a novel balun design. This will allow, together with the previously mentioned bridge, reduction of the number of ports from eight to four. The third track is a novel idea of designing the dipole array pattern that will give the ability to control the beam shape and make the feed tunable for a given F/D.

We also worked on the design of a Quad Ridged Feed Horn (QRFH). The CST model was used to study how shaping of the tapers of the ridges, feeding point,

back-short and other parameters of the design affect the S11 and beam shape. The study was extended to optimize the performance for the 2–12 GHz band. Figure 3 depicts the reflection coefficient of the final design and Figure 4 the feed efficiency in a prime focus reflector. The same figure shows for comparison the efficiency of the QRFH design described in [1]. As seen, the achieved performance is quite close to that reported in the article. So far there is no decision about fabrication of a prototype to measure beam patterns.

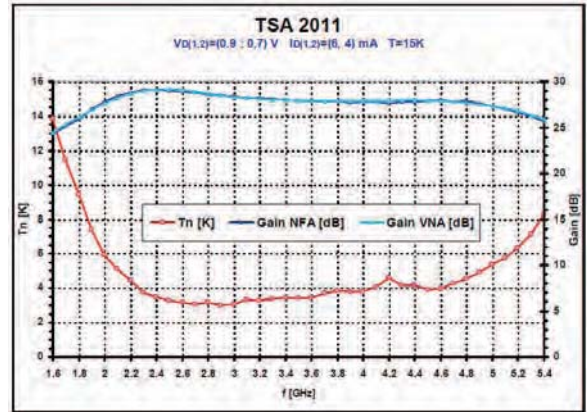
#### 4 A Dual-polarization S-band System

The currently used S-band receiver has one single circular polarization channel while the X-band receiver has both circular polarizations. To prepare for future mixed-mode observations with dual-polarized VGOS systems, we decided to upgrade the S-band receiver to dual circular polarization, too. One Low Noise Amplifier (LNA) was purchased from the Spanish company TTI. The cryogenic box accommodating the LNAs for X- and S-band was modified to integrate the new polarization channel and the new S-band LNA (see Figure 5). Gain and noise of the LNA are presented in Figure 6.

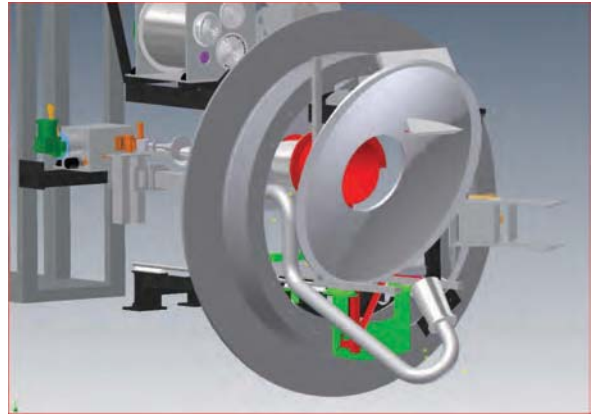


**Fig. 5** Interior of the cryogenic box for two polarizations (S- and X-band).

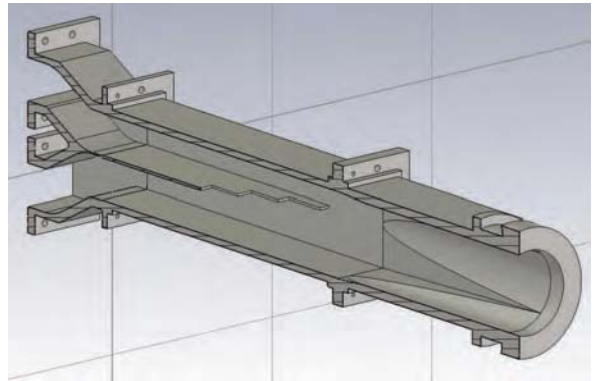
The performance of the receiver (excluding the warm part) was verified in the lab, and the receiver was installed back on the telescope in November 2013. A septum polarizer was designed for S-band and is



**Fig. 6** Gain and noise of the new LNA for S-band.



**Fig. 7** CAD drawing presenting the view towards the focal plane of the 20-m antenna with the tertiary mirror for S-band, the new design of the horn, and the waveguide for S-band.



**Fig. 8** Cross-section of the polarizer for S-band.

currently being manufactured. The waveguide for S-band was re-designed to accommodate a polarizer and room temperature waveguide couplers for noise

and phase calibration signals. Figure 7 depicts a drawing of the focal plane of the 20-m telescope with the tertiary reflector for S-band and the new design of the horn and waveguides for S-band. A cross-section of the polarizer for S-band is shown in Figure 8. The plan is to install the new waveguides and polarizer for S-band in March 2014 and to perform on-sky testing prior to CONT14.

## 5 Development of a New IF Distribution

After several months of parallel recordings with the analog Mark IV backend and the digital DBBC, and after extensive evaluation, we decided in mid 2013 to finally phase-out the Mark IV rack and to replace it with a second DBBC. A corresponding second DBBC unit was ordered in September 2013 and is expected to be delivered in April 2014. To be able to include it quickly into the VLBI system, a new IF distribution unit was developed. This new IF distribution is flexible and computer-controlled. It allows full flexibility to connect the receivers used for geodetic VLBI on the 20-m telescope, or the receivers used for astronomical VLBI on the 20-m or 25-m telescope, to either of the two DBBC units in various configurations. Extensive preparations were performed to minimize the down-time that will be caused by decommissioning the Mark IV-rack and installing the second DBBC.

## 6 A New GNSS Installation on the 20-m Telescope for Local-tie Measurements

Two GNSS antennas were mounted on each side of the prime reflector of the 20-m telescope at the height of the telescope elevation axis. Special gimbal mounts with counterweights were constructed to keep the GNSS antennas in the horizontal plane at all times, independently of the elevation angle of the 20-m telescope. The GNSS antennas are connected with coaxial cables to a pair of GNSS receivers inside the Cassegrain cabin of the 20-m telescope. The recorded data are downloaded automatically from the receivers via TCP/IP.

## 7 Future Plans

We have started a design study for the installation of a 4–12.25 GHz receiver front-end on our 20-m antenna. The system will extend the bandwidth of the current S/X system used for IVS observations. An additional advantage of this 4–12.25 GHz front-end is that it can be used not only for IVS sessions but also for C- and X-band observations for EVN. The horn will be designed by BAE Systems Australia Ltd. Preliminary results for the expected aperture efficiency of this horn are shown in Figure 9. The cryogenic front-end will use an Ortho-Mode transducer from CSIRO, Australia and LNAs of the Gothenburg-based company LNF. As part of the study we will investigate the possibility of using the horn with the current S-band tertiary, thus maintaining compatibility with the S/X band legacy systems. The plan is to complete the design study by the middle of 2014 and to decide on manufacturing and telescope installation shortly afterwards, so that the system would be available on the telescope by the end of 2014.

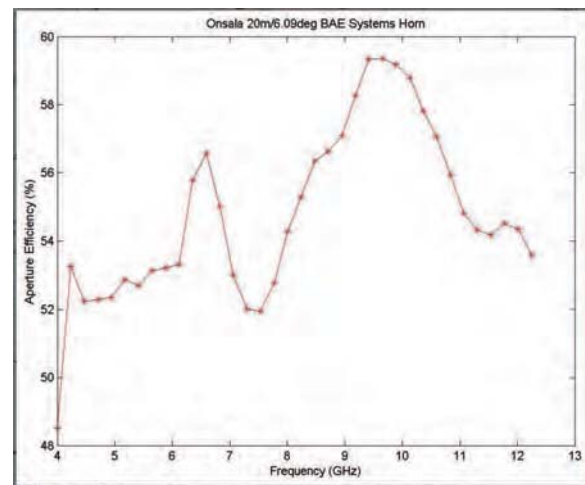


Fig. 9 Preliminary results for the aperture efficiency of the 4–12.25 GHz horn for the Onsala 20-m telescope.

## References

1. A. Akgiray, S. Weinreb, W. Imbriale, and C. Beaudoin. Circular Quadruple-Ridged Flared Horn Achieving Near-Constant Beamwidth Over Multioctave Bandwidth: Design and Measurements. *IEEE Transactions on Antennas and Propagation*, 61(3), 1099–1108, 2013.

# Bibliography







# Bibliography

## 1 Introduction

The following bibliography compiles papers that were published in the field of geodetic and astrometric VLBI during the year 2013. There is no distinction between peer-reviewed, reviewed, or proceedings publications. This list is by no means exhaustive.

## 2 Geodetic and Astrometric VLBI Publications of 2013

- W. ALEF, A. NOTHNAGEL, S. BERNHART, A. BERTARINI, L. LA PORTA, A. MÜSKENS, H. ROTTMANN: “Status and future plans for the Bonn Software Correlator”. In: Proceedings of the 21st Meeting of the European VLBI Group for Geodesy and Astrometry, edited by N. Zubko and M. Poutanen, ISBN: 978-951-711-296-3, 21–24, 2013.
- R. AMBROSINI, A. BOLLI, P. BOFFA: “The Sardinia Radio Telescope: Overview and Status”. In: International Conference on Electromagnetics in Advanced Applications (ICEAA), ISBN 978-1-4673-5705-0, 82–85, 2013.
- Y. AOYAMA, K. DOI, K. SHIBUYA: “JARE Syowa Station 11-m Antenna, Antarctica”. In: International VLBI Service for Geodesy and Astrometry 2012 Annual Report, edited by K. D. Baver, D. Behrend and K. L. Armstrong, NASA/TP-2013-217511, 150–153, 2013.
- T. ARTZ, A. NOTHNAGEL, L. LA PORTA: “VLBI Observations of Geostationary Satellites”. In: Proceedings of the 21st Meeting of the European VLBI Group for Geodesy and Astrometry, edited by N. Zubko and M. Poutanen, ISBN: 978-951-711-296-3, 217–222, 2013.
- S. BACHMANN AND M. LÖSLER: “Activities and Products at IVS combination center at BKG”. In: Proceedings of the 21st Meeting of the European VLBI Group for Geodesy and Astrometry, edited by N. Zubko and M. Poutanen, ISBN: 978-951-711-296-3, 169–174, 2013.
- S. BACHMANN, M. LÖSLER, R. HEINKELMANN, M. GERSTL: “BKG/DGFI Combination Center Annual Report 2012”. In: International VLBI Service for Geodesy and Astrometry 2012 Annual Report, edited by K. D. Baver, D. Behrend and K. L. Armstrong, NASA/TP-2013-217511, 245–248, 2013.
- D. BAEK, S. YI, H. OH, S. HAN: “Korea Geodetic VLBI Station, Sejong”. In: International VLBI Service for Geodesy and Astrometry 2012 Annual Report, edited by K. D. Baver, D. Behrend and K. L. Armstrong, NASA/TP-2013-217511, 135–138, 2013.
- C. BARACHE AND S. LAMBERT: “Paris Observatory (OPAR) Data Center”. In: International VLBI Service for Geodesy and Astrometry 2012 Annual Report, edited by K. D. Baver, D. Behrend and K. L. Armstrong, NASA/TP-2013-217511, 231–233, 2013.
- K. BAVER AND J. GIPSON: “Refining the Uniform Sky Strategy for IVS-INT01 Scheduling”. In: Proceedings of the 21st Meeting of the European VLBI Group for Geodesy and Astrometry, edited by N.

- Zubko and M. Poutanen, ISBN: 978-951-711-296-3, 205–209, 2013.
- C. BEAUDOIN, B. COREY, A. NIELL, R. CAPPALLO, A. WHITNEY: “Haystack Observatory Technology Development Center”. In: International VLBI Service for Geodesy and Astrometry 2012 Annual Report, edited by K. D. Baver, D. Behrend and K. L. Armstrong, NASA/TP-2013-217511, 335–338, 2013.
- C. BEAUDOIN, P. BOLIS, J. BYFORD, S. CAPPALLO, T. CLARK, B. COREY, I. DIEGEL, M. DEROME, C. ECKERT, C. MA, A. NIELL, B. PETRACHENKO, A. WHITNEY: “Receiver Upgrade for the GGAO 12m VLBI system”. In: Proceedings of the 21st Meeting of the European VLBI Group for Geodesy and Astrometry, edited by N. Zubko and M. Poutanen, ISBN: 978-951-711-296-3, 13–16, 2013.
- D. BEHREND: “Coordinating Center Report”. In: International VLBI Service for Geodesy and Astrometry 2012 Annual Report, edited by K. D. Baver, D. Behrend and K. L. Armstrong, NASA/TP-2013-217511, 55–57, 2013.
- S. BERNHART, W. ALEF, A. BERTARINI, L. LA PORTA, A. MÜSKENS, H. ROTTMANN, A. ROY: “The Bonn Astro/Geo Correlator”. In: International VLBI Service for Geodesy and Astrometry 2012 Annual Report, edited by K. D. Baver, D. Behrend and K. L. Armstrong, NASA/TP-2013-217511, 193–196, 2013.
- G. BIANCO, G. COLUCCI, F. SCHIAVONE: “Matera CGS VLBI Station”. In: International VLBI Service for Geodesy and Astrometry 2012 Annual Report, edited by K. D. Baver, D. Behrend and K. L. Armstrong, NASA/TP-2013-217511, 106–109, 2013.
- D. A. BOBOLTZ, A. L. FEY, N. GEIGER, C. DIECK, D. HALL: “U. S. Naval Observatory VLBI Analysis Center”. In: International VLBI Service for Geodesy and Astrometry 2012 Annual Report, edited by K. D. Baver, D. Behrend and K. L. Armstrong, NASA/TP-2013-217511, 319–322, 2013.
- J. BÖHM, S. BÖHM, H. KRÁSNÁ, M. MADZAK, T. NILSSON, L. PLANK, V. RAPOSO, H. SCHUH, B. SOJA, J. SUN, K. TEKE, C. TIERNO ROS: “Vienna Special Analysis Center Annual Report 2012”. In: International VLBI Service for Geodesy and Astrometry 2012 Annual Report, edited by K. D. Baver, D. Behrend and K. L. Armstrong, NASA/TP-2013-217511, 325–328, 2013.
- J. BÖHM, C. TIERNO ROS, J. SUN, S. BÖHM, H. KRÁSNÁ, T. NILSSON: “New VLBI2010 scheduling options and implications on terrestrial and celestial reference frames”. In: Proceedings of the 21st Meeting of the European VLBI Group for Geodesy and Astrometry, edited by N. Zubko and M. Poutanen, ISBN: 978-951-711-296-3, 39–44, 2013.
- S. BOLOTIN, K. BAVER, J. GIPSON, D. GORDON, D. MACMILLAN: “Current status of vSolve”. In: Proceedings of the 21st Meeting of the European VLBI Group for Geodesy and Astrometry, edited by N. Zubko and M. Poutanen, ISBN: 978-951-711-296-3, 77–80, 2013.
- R. BOUFFET, P. CHARLOT, S. LAMBERT: “Correlation between source structure evolution and VLBI position instabilities”. In: Proceedings of the 21st Meeting of the European VLBI Group for Geodesy and Astrometry, edited by N. Zubko and M. Poutanen, ISBN: 978-951-711-296-3, 185–188, 2013.
- R. CAPPALLO, C. RUSZCZYK, A. WHITNEY: “Mark 6: Design and Status”. In: Proceedings of the 21st Meeting of the European VLBI Group for Geodesy and Astrometry, edited by N. Zubko and M. Poutanen, ISBN: 978-951-711-296-3, 9–12, 2013.
- P. CHARLOT, A. BELLANGER, R. BOUFFET, G. BOURDA, A. COLLIOUD, A. BAUDRY: “Report for 2012 from the Bordeaux IVS Analysis Center”. In: International VLBI Service for Geodesy and Astrometry 2012 Annual Report, edited by K. D. Baver, D. Behrend and K. L. Armstrong, NASA/TP-2013-217511, 241–244, 2013.
- A. COLLIOUD, A. NEIDHARDT: “When ‘IVS Live’ meets ‘e-RemoteCtrl’ real-time data”. In: Proceedings of the 21st Meeting of the European VLBI Group for Geodesy and Astrometry, edited by N. Zubko and M. Poutanen, ISBN: 978-951-711-296-3, 17–20, 2013.
- F. COLOMER, S. GARCÍA-ESPADA, J. GÓMEZ-GONZÁLEZ, J. LÓPEZ-FERNÁNDEZ, A. SANTAMARÍA-GÓMEZ, P. DE VICENTE: “Instituto Geográfico Nacional of Spain”. In: International VLBI Service for Geodesy and Astrometry 2012 Annual Report, edited by K. D. Baver, D. Behrend

- and K. L. Armstrong, NASA/TP-2013-217511, 173–176, 2013.
- R. CURTIS: “Kokee Park Geophysical Observatory”. In: International VLBI Service for Geodesy and Astrometry 2012 Annual Report, edited by K. D. Baver, D. Behrend and K. L. Armstrong, NASA/TP-2013-217511, 102–105, 2013.
- A. DE WITT, M. GAYLARD, J. QUICK, L. COMBRINCK: “An Overview of Geodetic and Astrometric VLBI at the Hartebeesthoek Radio Astronomy Observatory”. In: Proceedings of the 21st Meeting of the European VLBI Group for Geodesy and Astrometry, edited by N. Zubko and M. Poutanen, ISBN: 978-951-711-296-3, 45–48, 2013.
- G. ENGELHARDT, V. THORANDT, D. ULLRICH: “Rapid UT1 Estimation Derived from Tsukuba VLBI Measurements after 2011 Earthquake”. In: Proceedings of the 21st Meeting of the European VLBI Group for Geodesy and Astrometry, edited by N. Zubko and M. Poutanen, ISBN: 978-951-711-296-3, 85–88, 2013.
- C. ESCHELBACH, R. HAAS, M. LÖSLER: “Automated IVS Reference Point Monitoring – First Experience from the Onsala Space Observatory”. In: Proceedings of the 21st Meeting of the European VLBI Group for Geodesy and Astrometry, edited by N. Zubko and M. Poutanen, ISBN: 978-951-711-296-3, 249–254, 2013.
- A. L. FEY, D. A. BOBOLTZ, R. A. GAUME: “USNO Analysis Center for Source Structure Report”. In: International VLBI Service for Geodesy and Astrometry 2012 Annual Report, edited by K. D. Baver, D. Behrend and K. L. Armstrong, NASA/TP-2013-217511, 323–324, 2013.
- R. FIGUEROA: “Goddard Geophysical and Astronomical Observatory”. In: International VLBI Service for Geodesy and Astrometry 2012 Annual Report, edited by K. D. Baver, D. Behrend and K. L. Armstrong, NASA/TP-2013-217511, 82–85, 2013.
- A. GIRDIUK AND O. TITOV: “Plan for VLBI Observations of Close Approaches of Jupiter to Compact Extragalactic Radio Sources in 2014–2016”. In: Proceedings of Journées-2013, 2013. (arXiv:1311.0092)
- D. GORDON, C. MA, D. MACMILLAN, J. GIPSON, S. BOLOTIN, K. LE BAIL, K. BAVER: “GSFC VLBI Analysis Center”. In: International VLBI Service for Geodesy and Astrometry 2012 Annual Report, edited by K. D. Baver, D. Behrend and K. L. Armstrong, NASA/TP-2013-217511, 261–264, 2013.
- R. HAAS: “The Onsala Twin Telescope Project”. In: Proceedings of the 21st Meeting of the European VLBI Group for Geodesy and Astrometry, edited by N. Zubko and M. Poutanen, ISBN: 978-951-711-296-3, 61–68, 2013.
- R. HAAS, G. ELGERED, J. LÖFGREN, T. NING, H. SCHERNECK: “Onsala Space Observatory - IVS Network Station”. In: International VLBI Service for Geodesy and Astrometry 2012 Annual Report, edited by K. D. Baver, D. Behrend and K. L. Armstrong, NASA/TP-2013-217511, 130–133, 2013.
- R. HAAS, H. SCHERNECK, G. ELGERED, T. NING, J. LÖFGREN: “Onsala Space Observatory - IVS Analysis Center”. In: International VLBI Service for Geodesy and Astrometry 2012 Annual Report, edited by K. D. Baver, D. Behrend and K. L. Armstrong, NASA/TP-2013-217511, 298–301, 2013.
- D. HALL AND D. BOBOLTZ: “Washington Correlator”. In: International VLBI Service for Geodesy and Astrometry 2012 Annual Report, edited by K. D. Baver, D. Behrend and K. L. Armstrong, NASA/TP-2013-217511, 216–218, 2013.
- D. HALL AND M. S. CARTER: “NEOS Operation Center”. In: International VLBI Service for Geodesy and Astrometry 2012 Annual Report, edited by K. D. Baver, D. Behrend and K. L. Armstrong, NASA/TP-2013-217511, 189, 2013.
- H. HASE, G. GANCIO, D. PERILLI, J. J. LARRARTE, L. GUARRERA, L. GARCÍA, G. KRONSNABL, C. PLÖTZ: “Radio Frequency Interference Observations at IAR La Plata”. In: Proceedings of the 21st Meeting of the European VLBI Group for Geodesy and Astrometry, edited by N. Zubko and M. Poutanen, ISBN: 978-951-711-296-3, 49–54, 2013.
- H. HASE, C. HERRERA, F. PEDREROS, O. ZAPATA, P. PINO: “Status of the TIGO VLBI Station in Concepción”. In: International VLBI Service for Geodesy and Astrometry 2012 Annual Report, edited by K. D. Baver, D. Behrend and K. L. Armstrong, NASA/TP-2013-217511, 154–156, 2013.

- R. HEINKELMANN, M. KARBON, T. NILSSON, V. RAPOSO, H. SCHUH: “GFZ Analysis Center”. In: International VLBI Service for Geodesy and Astrometry 2012 Annual Report, edited by K. D. Baver, D. Behrend and K. L. Armstrong, NASA/TP-2013-217511, 255–256, 2013.
- R. HEINKELMANN, M. SEITZ, J. MORA-DIAZ, M. BLOSSFELD, M. GERSTL, R. SCHMID: “DGFI Analysis Center Annual Report 2012”. In: International VLBI Service for Geodesy and Astrometry 2012 Annual Report, edited by K. D. Baver, D. Behrend and K. L. Armstrong, NASA/TP-2013-217511, 251–254, 2013.
- R. HEINKELMANN AND V. TESMER: “Systematic Inconsistencies Between VLBI, CRF and TRF Solutions Caused by Different Analysis Options”. In: Reference Frames for Applications in Geosciences, edited by Z. Altamimi and X. Collilieux, DOI:10.1007/978-3-642-32998-2\_27, 181–189, 2013.
- E. HIMWICH AND J. GIPSON: “GSFC Technology Development Center Report”. In: International VLBI Service for Geodesy and Astrometry 2012 Annual Report, edited by K. D. Baver, D. Behrend and K. L. Armstrong, NASA/TP-2013-217511, 332–334, 2013.
- E. HIMWICH AND R. STRAND: “Network Coordinator Report”. In: International VLBI Service for Geodesy and Astrometry 2012 Annual Report, edited by K. D. Baver, D. Behrend and K. L. Armstrong, NASA/TP-2013-217511, 60–67, 2013.
- T. HOBIGER, M. SEKIDO, R. ICHIKAWA: “Analysis Center at National Institute of Information and Communications Technology”. In: International VLBI Service for Geodesy and Astrometry 2012 Annual Report, edited by K. D. Baver, D. Behrend and K. L. Armstrong, NASA/TP-2013-217511, 287–290, 2013.
- R. ICHIKAWA AND M. SEKIDO: “Data Center at NICT”. In: International VLBI Service for Geodesy and Astrometry 2012 Annual Report, edited by K. D. Baver, D. Behrend and K. L. Armstrong, NASA/TP-2013-217511, 227–230, 2013.
- A. IPATOV, S. SMOLENTSEV, A. SALNIKOV, I. SURKIS, I. GAYAZOV, S. KURDUBOV, I. RAHIMOV, A. DIAKOV, V. SHPILEVSKY, A. MELNIKOV, V. ZIMOVSKY, L. FEDOTOV, E. SKURIKHINA: “The state-of-the-art of Russian VLBI network”. In: Proceedings of the 21st Meeting of the European VLBI Group for Geodesy and Astrometry, edited by N. Zubko and M. Poutanen, ISBN: 978-951-711-296-3, 155–158, 2013.
- C. JACOBS: “JPL VLBI Analysis Center Report for 2012”. In: International VLBI Service for Geodesy and Astrometry 2012 Annual Report, edited by K. D. Baver, D. Behrend and K. L. Armstrong, NASA/TP-2013-217511, 273–276, 2013.
- T. JIKE, Y. TAMURA, M. SHIZUGAMI, VERA GROUP: “VERA Geodetic Activities”. In: International VLBI Service for Geodesy and Astrometry 2012 Annual Report, edited by K. D. Baver, D. Behrend and K. L. Armstrong, NASA/TP-2013-217511, 116–119, 2013.
- U. KALLIO AND N. ZUBKO: “The effect of the systematic error in the axis offset value on the coordinates estimated on VLBI data analysis”. In: Proceedings of the 21st Meeting of the European VLBI Group for Geodesy and Astrometry, edited by N. Zubko and M. Poutanen, ISBN: 978-951-711-296-3, 237–242, 2013.
- N. KAREINEN, M. UUNILA: “Automated analysis of dUT1 with VieVS using new post-earthquake coordinates for Tsukuba”. In: Proceedings of the 21st Meeting of the European VLBI Group for Geodesy and Astrometry, edited by N. Zubko and M. Poutanen, ISBN: 978-951-711-296-3, 99–104, 2013.
- P. KAUFMANN, A. MACÍLIO PEREIRA DE LUCENA, A. SOMBRA DA SILVA: “Fortaleza Station Report for 2012”. In: International VLBI Service for Geodesy and Astrometry 2012 Annual Report, edited by K. D. Baver, D. Behrend and K. L. Armstrong, NASA/TP-2013-217511, 79–81, 2013.
- R. KAWABATA, S. KURIHARA, Y. FUKUZAKI, J. KURODA, T. TANABE, Y. MUKAI, T. NISHIKAWA: “Tsukuba 32-m VLBI Station”. In: International VLBI Service for Geodesy and Astrometry 2012 Annual Report, edited by K. D. Baver, D. Behrend and K. L. Armstrong, NASA/TP-2013-217511, 157–160, 2013.
- H. P. KIERULF AND P. H. ANDERSEN: “NMA Analysis Center”. In: International VLBI Service for Geodesy and Astrometry 2012 Annual Report, edited by K. D. Baver, D. Behrend and K. L.

- Armstrong, NASA/TP-2013-217511, 291–293, 2013.
- J. KODET, CHR. PLÖTZ, K. U. SCHREIBER, A. NEIDHARDT, S. POGREBENKO, R. HAAS, G. MOLERA, I. PROCHAZKA: “Co-location of space geodetics techniques in Space and on the ground”. In: Proceedings of the 21st Meeting of the European VLBI Group for Geodesy and Astrometry, edited by N. Zubko and M. Poutanen, ISBN: 978-951-711-296-3, 223–226, 2013.
- H. KRÁSNÁ, J. BÖHM, R. HAAS, H. SCHUH: “Zonal Love and Shida numbers estimated by VLBI”. In: Proceedings of the 21st Meeting of the European VLBI Group for Geodesy and Astrometry, edited by N. Zubko and M. Poutanen, ISBN: 978-951-711-296-3, 121–126, 2013.
- S. L. KURDUBOV : “Comparison of Russian and IVS intensive series”. In: Proceedings of the 21st Meeting of the European VLBI Group for Geodesy and Astrometry, edited by N. Zubko and M. Poutanen, ISBN: 978-951-711-296-3, 147–150, 2013.
- S. KURIHARA AND K. NOZAWA: “Tsukuba VLBI Analysis Center”. In: International VLBI Service for Geodesy and Astrometry 2012 Annual Report, edited by K. D. Baver, D. Behrend and K. L. Armstrong, NASA/TP-2013-217511, 315–318, 2013.
- S. KURIHARA AND K. NOZAWA: “Tsukuba VLBI Correlator”. In: International VLBI Service for Geodesy and Astrometry 2012 Annual Report, edited by K. D. Baver, D. Behrend and K. L. Armstrong, NASA/TP-2013-217511, 212–215, 2013.
- S. KURIHARA, K. NOZAWA, R. HAAS, J. LOVELL, J. MCCALLUM, J. QUICK, T. HOBIGER: “4-station ultra-rapid EOP experiment with e-VLBI technique and automated correlation/analysis”. In: Proceedings of the 21st Meeting of the European VLBI Group for Geodesy and Astrometry, edited by N. Zubko and M. Poutanen, ISBN: 978-951-711-296-3, 233–236, 2013.
- Y. KWAK AND J. CHO: “VLBI TRF Combination Using GNSS Software”. *Journal of Astronomy and Space Sciences*, 30(4), 315–320, 2013.
- Y. KWAK AND J. CHO: “KASI Combination Center Report”. In: International VLBI Service for Geodesy and Astrometry 2012 Annual Report, edited by K. D. Baver, D. Behrend and K. L. Armstrong, NASA/TP-2013-217511, 277–280, 2013.
- S. LAMBERT AND C. BARACHE: “Paris Observatory Analysis Center (OPAR): Report on Activities, January - December, 2012”. In: International VLBI Service for Geodesy and Astrometry 2012 Annual Report, edited by K. D. Baver, D. Behrend and K. L. Armstrong, NASA/TP-2013-217511, 294–297, 2013.
- R. LANOTTE: “Matera CGS VLBI Analysis Center”. In: International VLBI Service for Geodesy and Astrometry 2012 Annual Report, edited by K. D. Baver, D. Behrend and K. L. Armstrong, NASA/TP-2013-217511, 249–250, 2013.
- K. LE BAIL, J. M. GIPSON, J. JUHL, D. S. MACMILLAN: “Optimal time lags to use in modeling the thermal deformation of VLBI Antennas”. In: Proceedings of the 21st Meeting of the European VLBI Group for Geodesy and Astrometry, edited by N. Zubko and M. Poutanen, ISBN: 978-951-711-296-3, 165–168, 2013.
- J. LEEK, T. ARTZ, A. NOTHNAGEL: “Assessment of VLBI Intensive Schedules by means of Cluster Analysis”. In: Proceedings of the 21st Meeting of the European VLBI Group for Geodesy and Astrometry, edited by N. Zubko and M. Poutanen, ISBN: 978-951-711-296-3, 211–216, 2013.
- M. LÖSLER, A. NEIDHARDT, S. MÄHLER: “Impact of Different Observation Strategies on Reference Point Determination - Evaluations from a Campaign at the Geodetic Observatory Wettzell”. In: Proceedings of the 21st Meeting of the European VLBI Group for Geodesy and Astrometry, edited by N. Zubko and M. Poutanen, ISBN: 978-951-711-296-3, 255–260, 2013.
- J. LOVELL, J. DICKEY, B. REID, J. MCCALLUM, S. SHABALA, C. WATSON, S. ELLINGSEN, A. MEMIN: “AuScope VLBI Project and Hobart 26-m Antenna”. In: International VLBI Service for Geodesy and Astrometry 2012 Annual Report, edited by K. D. Baver, D. Behrend and K. L. Armstrong, NASA/TP-2013-217511, 90–93, 2013.
- J. LOVELL, J. MCCALLUM, P. REID, P. MCCULLOCH, B. BAYNES, J. DICKEY, S. SHABALA, C. WATSON, O. TITOV, R. RUDDICK, R. TWILLEY, C. REYNOLDS, S. TINGAY, P. SHIELD, R. ADADA, S. ELLINGSEN, J. MORGAN, H.

- BIGNALL: “The AuScope Geodetic VLBI Array”. *Journal of Geodesy*, 87(6), 527–538, 2013.
- D. S. MACMILLAN AND D. ERIKSSON: “Nontidal Ocean Loading Observed by VLBI Measurement”. In: *Proceedings of the 21st Meeting of the European VLBI Group for Geodesy and Astrometry*, edited by N. Zubko and M. Poutanen, ISBN: 978-951-711-296-3, 135–140, 2013.
- M. MADZAK, J. BÖHM, S. BÖHM, H. KRÁSNÁ, T. NILSSON, L. PLANK, C. TIERNO ROS, H. SCHUH, B. SOJA, J. SUN, K. TEKE: “Vienna VLBI Software – Current release and plans for the future”. In: *Proceedings of the 21st Meeting of the European VLBI Group for Geodesy and Astrometry*, edited by N. Zubko and M. Poutanen, ISBN: 978-951-711-296-3, 73–76, 2013.
- Z. MALKIN: “On Assessment of the stochastic errors of source position catalogs”. In: *Proceedings of the All-Russian Astrometry Conference Pulkovo 2013*, No. 220, 59–64, 2013. (in Russian)
- Z. MALKIN: “Catalog of optical characteristics of astrometric radio sources OCARS”. In: *Proceedings of the All-Russian Astrometry Conference Pulkovo-2013*, No. 220, 507–510, 2013. (in Russian)
- Z. MALKIN: “On Application of the 3-Cornered Hat Technique to Radio Source Position Catalogs”. In: *Proceedings of the 21st Meeting of the European VLBI Group for Geodesy and Astrometry*, edited by N. Zubko and M. Poutanen, ISBN: 978-951-711-296-3, 175–178, 2013.
- Z. MALKIN: “On the Impact of the Seasonal Station Motions on the Intensive UT1 Results”. In: *Proceedings of the 21st Meeting of the European VLBI Group for Geodesy and Astrometry*, edited by N. Zubko and M. Poutanen, ISBN: 978-951-711-296-3, 89–94, 2013.
- Z. MALKIN AND E. SKURIKHINA: “Dependence of the rapid UT1 results obtained from the VLBI network ‘Quasar’ on nutation model”. In: *Proceedings of the All-Russian Astrometry Conference Pulkovo-2013*, No. 220, 119–124, 2013. (in Russian)
- Z. MALKIN AND J. SOKOLOVA: “Pulkovo IVS Analysis Center (PUL) 2012 Annual Report”. In: *International VLBI Service for Geodesy and Astrometry 2012 Annual Report*, edited by K. D. Baver, D. Behrend and K. L. Armstrong, NASA/TP-2013-217511, 305–308, 2013.
- Z. MALKIN, J. SUN, J. BÖHM, S. BÖHM, H. KRÁSNÁ: “Searching for an Optimal Strategy to Intensify Observations of the Southern ICRF sources in the framework of the regular IVS observing programs”. In: *Proceedings of the 21st Meeting of the European VLBI Group for Geodesy and Astrometry*, edited by N. Zubko and M. Poutanen, ISBN: 978-951-711-296-3, 199–204, 2013.
- D. MARSHALOV, E. NOSOV, L. FEDOTOV: “IAA Technology Development Center”. In: *International VLBI Service for Geodesy and Astrometry 2012 Annual Report*, edited by K. D. Baver, D. Behrend and K. L. Armstrong, NASA/TP-2013-217511, 339–341, 2013.
- M. NEGUSINI AND P. SARTI: “Italy INAF Data Center Report”. In: *International VLBI Service for Geodesy and Astrometry 2012 Annual Report*, edited by K. D. Baver, D. Behrend and K. L. Armstrong, NASA/TP-2013-217511, 226, 2013.
- M. NEGUSINI AND P. SARTI: “Italy INAF Analysis Center Report”. In: *International VLBI Service for Geodesy and Astrometry 2012 Annual Report*, edited by K. D. Baver, D. Behrend and K. L. Armstrong, NASA/TP-2013-217511, 271–272, 2013.
- A. NEIDHARDT, M. Ettl, W. BRISKEN, R. DASSING: “Continuous integration and quality control for scientific software”. In: *Proceedings of the 21st Meeting of the European VLBI Group for Geodesy and Astrometry*, edited by N. Zubko and M. Poutanen, ISBN: 978-951-711-296-3, 81–84, 2013.
- A. NEIDHARDT, M. Ettl, M. MÜHLBAUER, G. KRONSCHNABL, W. ALEF, E. HIMWICH, C. BEAUDOIN, C. PLÖTZ, J. LOVELL: “Safe and secure remote control for the Twin Radio Telescope Wettzell”. In: *Proceedings of the 21st Meeting of the European VLBI Group for Geodesy and Astrometry*, edited by N. Zubko and M. Poutanen, ISBN: 978-951-711-296-3, 25–28, 2013.
- A. NEIDHARDT, G. KRONSCHNABL, R. SCHATZ: “Geodetic Observatory Wettzell - 20-m Radio Telescope and Twin Telescope”. In: *International VLBI Service for Geodesy and Astrometry 2012 Annual Report*, edited by K. D. Baver, D. Behrend and K. L. Armstrong, NASA/TP-2013-217511, 169–172, 2013.
- A. NEIDHARDT, C. PLÖTZ, T. KLÜGEL: “VLBI2010 Receiver Back End Comparison”. In: *International*

- VLBI Service for Geodesy and Astrometry 2012 Annual Report, edited by K. D. Baver, D. Behrend and K. L. Armstrong, NASA/TP-2013-217511, 126–129, 2013.
- M. NICKOLA, M. GAYLARD, J. QUICK, L. COMBRINCK: “Hartebeesthoek Radio Astronomy Observatory (HartRAO)”. In: International VLBI Service for Geodesy and Astrometry 2012 Annual Report, edited by K. D. Baver, D. Behrend and K. L. Armstrong, NASA/TP-2013-217511, 86–89, 2013.
- A. NIELL, C. BEAUDOIN, R. CAPPALLO, B. COREY, M. TITUS: “First results with the GGAO12M VGOS System”. In: Proceedings of the 21st Meeting of the European VLBI Group for Geodesy and Astrometry, edited by N. Zubko and M. Poutanen, ISBN: 978-951-711-296-3, 29–32, 2013.
- A. NIELL, R. CAPPALLO, B. COREY, M. TITUS: “Haystack Analysis Center”. In: International VLBI Service for Geodesy and Astrometry 2012 Annual Report, edited by K. D. Baver, D. Behrend and K. L. Armstrong, NASA/TP-2013-217511, 265–268, 2013.
- T. NILSSON, M. KARBON, H. SCHUH: “A Kalman filter for combining high frequency Earth rotation parameters from VLBI and GNSS”. In: Proceedings of the 21st Meeting of the European VLBI Group for Geodesy and Astrometry, edited by N. Zubko and M. Poutanen, ISBN: 978-951-711-296-3, 117–120, 2013.
- C. NOLL: “CDDIS Data Center Summary for the IVS 2012 Annual Report”. In: International VLBI Service for Geodesy and Astrometry 2012 Annual Report, edited by K. D. Baver, D. Behrend and K. L. Armstrong, NASA/TP-2013-217511, 223–225, 2013.
- A. NOTHNAGEL: “Analysis Coordinator Report”. In: International VLBI Service for Geodesy and Astrometry 2012 Annual Report, edited by K. D. Baver, D. Behrend and K. L. Armstrong, NASA/TP-2013-217511, 58–59, 2013.
- A. NOTHNAGEL, P. CHARLOT, V. DEHANT, A. FIENGA, H. HASE, L. PLANK, H. SCHUH: “Short Report of IVS Working Group 5 (WG5) on Space Science Applications”. In: International VLBI Service for Geodesy and Astrometry 2012 Annual Report, edited by K. D. Baver, D. Behrend and K. L. Armstrong, NASA/TP-2013-217511, 13–20, 2013.
- A. NOTHNAGEL, M. EICHBORN, C. HOLST: “Improved focal length results of the Effelsberg 100 m radio telescope”. In: Proceedings of the 21st Meeting of the European VLBI Group for Geodesy and Astrometry, edited by N. Zubko and M. Poutanen, ISBN: 978-951-711-296-3, 55–60, 2013.
- A. NOTHNAGEL AND A. MÜSKENS: “The Bonn Geodetic VLBI Operation Center”. In: International VLBI Service for Geodesy and Astrometry 2012 Annual Report, edited by K. D. Baver, D. Behrend and K. L. Armstrong, NASA/TP-2013-217511, 183–184, 2013.
- A. ORFEI, A. ORLATI, G. MACCAFERRI: “The Medicina Station Status Report”. In: International VLBI Service for Geodesy and Astrometry 2012 Annual Report, edited by K. D. Baver, D. Behrend and K. L. Armstrong, NASA/TP-2013-217511, 110–111, 2013.
- M. PANTALEEV, U. KYLENFALL, L. HELLDNER, K. JOHANSSON, R. HAAS, M. IVASHINA, O. IUPIKOV: “Onsala Space Observatory - IVS Technology Development Center”. In: International VLBI Service for Geodesy and Astrometry 2012 Annual Report, edited by K. D. Baver, D. Behrend and K. L. Armstrong, NASA/TP-2013-217511, 346–349, 2013.
- B. PETRACHENKO: “Canadian VLBI Technology Development Center”. In: International VLBI Service for Geodesy and Astrometry 2012 Annual Report, edited by K. D. Baver, D. Behrend and K. L. Armstrong, NASA/TP-2013-217511, 331, 2013.
- B. PETRACHENKO: “VLBI2010 Feed Comparison”. In: International VLBI Service for Geodesy and Astrometry 2012 Annual Report, edited by K. D. Baver, D. Behrend and K. L. Armstrong, NASA/TP-2013-217511, 48–51, 2013.
- B. PETRACHENKO: “VLBI2010 Receiver Back End Comparison”. In: International VLBI Service for Geodesy and Astrometry 2012 Annual Report, edited by K. D. Baver, D. Behrend and K. L. Armstrong, NASA/TP-2013-217511, 39–47, 2013.
- B. PETRACHENKO, B. COREY, C. BEAUDOIN: “VGOS RFI Survey”. In: Proceedings of the 21st Meeting of the European VLBI Group for Geodesy

- and Astrometry, edited by N. Zubko and M. Poutanen, ISBN: 978-951-711-296-3, 33–38, 2013.
- L. PLANK, J. BÖHM, H. KRÁSNÁ, H. SCHUH: “VLBI satellite tracking for precise coordinate determination - a simulation study”. In: Proceedings of the 21st Meeting of the European VLBI Group for Geodesy and Astrometry, edited by N. Zubko and M. Poutanen, ISBN: 978-951-711-296-3, 105–110, 2013.
- M. POIRIER: “Westford Antenna”. In: International VLBI Service for Geodesy and Astrometry 2012 Annual Report, edited by K. D. Baver, D. Behrend and K. L. Armstrong, NASA/TP-2013-217511, 165–168, 2013.
- M. POUTANEN, U. KALLIO, H. KOIVULA, J. NÄRÄNEN, A. RAJA-HALLI, N. ZUBKO: “Renewal of Metsähovi Observatory”. In: Proceedings of the 21st Meeting of the European VLBI Group for Geodesy and Astrometry, edited by N. Zubko and M. Poutanen, ISBN: 978-951-711-296-3, 67–72, 2013.
- V. RAPOSO-PULIDO, H. KRÁSNÁ, T. NILSSON, R. HEINKELMANN, H. SCHUH: “Time Series Analysis and Stability of ICRF2 sources”. In: Proceedings of the 21st Meeting of the European VLBI Group for Geodesy and Astrometry, edited by N. Zubko and M. Poutanen, ISBN: 978-951-711-296-3, 179–184, 2013.
- J. REYNOLDS: “Parkes 2012 IVS Report”. In: International VLBI Service for Geodesy and Astrometry 2012 Annual Report, edited by K. D. Baver, D. Behrend and K. L. Armstrong, NASA/TP-2013-217511, 134, 2013.
- P. SARTI, C. ABBONDANZA, J. LEGRAND, C. BRUYNINX, L. VITTUARI, J. RAY: “Intrasite Motions and Monument Instabilities at Medicina ITRF Co-location Site”. *Geophysical Journal International*, Volume 192, Issue 3, 1042–1051, 2013.
- R. SCHAAP, S. SHABALA, S. ELLINGSEN, O. TITOV, J. LOVELL: “Scintillation is an indicator of astrometric stability”. *Monthly Notices of the Royal Astronomical Society (MNRAS)*, 434(1), 585–594, 2013.
- M. SEKIDO AND E. KAWAI: “Kashima 34-m Radio Telescope”. In: International VLBI Service for Geodesy and Astrometry 2012 Annual Report, edited by K. D. Baver, D. Behrend and K. L. Armstrong, NASA/TP-2013-217511, 94–97, 2013.
- M. SEKIDO AND E. KAWAI: “Kashima and Koganei 11-m VLBI Stations”. In: International VLBI Service for Geodesy and Astrometry 2012 Annual Report, edited by K. D. Baver, D. Behrend and K. L. Armstrong, NASA/TP-2013-217511, 98–101, 2013.
- M. SEKIDO AND K. TAKEFUJI: “VLBI Correlators in Kashima”. In: International VLBI Service for Geodesy and Astrometry 2012 Annual Report, edited by K. D. Baver, D. Behrend and K. L. Armstrong, NASA/TP-2013-217511, 204–207, 2013.
- F. SHU, W. ZHENG, Z. CHEN: “Shanghai VLBI Correlator”. In: International VLBI Service for Geodesy and Astrometry 2012 Annual Report, edited by K. D. Baver, D. Behrend and K. L. Armstrong, NASA/TP-2013-217511, 208–211, 2013.
- M. SIEBER: “Ny-Ålesund Geodetic Observatory”. In: International VLBI Service for Geodesy and Astrometry 2012 Annual Report, edited by K. D. Baver, D. Behrend and K. L. Armstrong, NASA/TP-2013-217511, 123–125, 2013.
- E. SKURIKHINA, S. KURDUBOV, V. GUBANOV: “IAA VLBI Analysis Center Report 2012”. In: International VLBI Service for Geodesy and Astrometry 2012 Annual Report, edited by K. D. Baver, D. Behrend and K. L. Armstrong, NASA/TP-2013-217511, 269–270, 2013.
- S. SMOLENTSEV AND A. DYAKOV: “Zelenchukskaya Radio Astronomical Observatory”. In: International VLBI Service for Geodesy and Astrometry 2012 Annual Report, edited by K. D. Baver, D. Behrend and K. L. Armstrong, NASA/TP-2013-217511, 177–180, 2013.
- S. SMOLENSTEV AND V. OLIFIROV: “Badary Radio Astronomical Observatory”. In: International VLBI Service for Geodesy and Astrometry 2012 Annual Report, edited by K. D. Baver, D. Behrend and K. L. Armstrong, NASA/TP-2013-217511, 75–78, 2013.
- S. SMOLENTSEV AND I. RAHIMOV: “Svetloe Radio Astronomical Observatory”. In: International VLBI Service for Geodesy and Astrometry 2012 Annual Report, edited by K. D. Baver, D. Behrend and K.



- L. ARMSTRONG, NASA/TP-2013-217511, 146–149, 2013.
- B. SOJA, J. SUN, R. HEINKELMANN, H. SCHUH, J. BÖHM: “Sun Corona Electron Densities Derived from VLBI Sessions in 2011/2012”. In: Proceedings of the 21st Meeting of the European VLBI Group for Geodesy and Astrometry, edited by N. Zubko and M. Poutanen, ISBN: 978-951-711-296-3, 159–164, 2013.
- R. SOKOLOVA AND Z. MALKIN: “On the Impact of the Correlation Information on the Orientation Parameters Between Celestial Reference Frames”. In: Vestnik of the St. Petersburg State University, Ser. 1, No. 4, 146–151, 2013. (in Russian)
- I. SURKIS, V. KEN, A. MELNIKOV, V. MISHIN, N. SOKOLOVA, V. SHANTYR, V. ZIMOVSKY: “IAA Correlator Center”. In: International VLBI Service for Geodesy and Astrometry 2012 Annual Report, edited by K. D. Baver, D. Behrend and K. L. Armstrong, NASA/TP-2013-217511, 201–203, 2013.
- K. TAKEFUJI AND H. UJIHARA: “Technology Development Center at NICT”. In: International VLBI Service for Geodesy and Astrometry 2012 Annual Report, edited by K. D. Baver, D. Behrend and K. L. Armstrong, NASA/TP-2013-217511, 342–345, 2013.
- E. TANIR KAYIKÇI AND K. TEKE: “KTU-GEOD IVS Analysis Center Annual Report 2012”. In: International VLBI Service for Geodesy and Astrometry 2012 Annual Report, edited by K. D. Baver, D. Behrend and K. L. Armstrong, NASA/TP-2013-217511, 281–284, 2013.
- K. TEKE, J. BÖHM, T. NILSSON, H. KRÁSNÁ: “Sub-daily Antenna Position Estimates from the CONT11 Campaign”. In: Proceedings of the 21st Meeting of the European VLBI Group for Geodesy and Astrometry, edited by N. Zubko and M. Poutanen, ISBN: 978-951-711-296-3, 131–134, 2013.
- C. THOMAS AND D. MACMILLAN: “CORE Operation Center Report”. In: International VLBI Service for Geodesy and Astrometry 2012 Annual Report, edited by K. D. Baver, D. Behrend and K. L. Armstrong, NASA/TP-2013-217511, 185–188, 2013.
- V. THORANDT, A. NOTHNAGEL, G. ENGELHARDT, D. ULLRICH, T. ARTZ, J. LEEK: “The BKG/IGGB VLBI Analysis Center”. In: International VLBI Service for Geodesy and Astrometry 2012 Annual Report, edited by K. D. Baver, D. Behrend and K. L. Armstrong, NASA/TP-2013-217511, 257–260, 2013.
- V. THORANDT AND R. WOJZDZIAK: “BKG Data Center”. In: International VLBI Service for Geodesy and Astrometry 2012 Annual Report, edited by K. D. Baver, D. Behrend and K. L. Armstrong, NASA/TP-2013-217511, 221–222, 2013.
- O. TITOV AND S. LAMBERT: “Improved VLBI Measurement of the Solar System Acceleration”. *Astronomy & Astrophysics*, 559, A95, 5pp, 2013.
- O. TITOV AND L. STANFORD: “Comparison of wet troposphere variations estimated from VLBI and WVR”. In: Proceedings of the 21st Meeting of the European VLBI Group for Geodesy and Astrometry, edited by N. Zubko and M. Poutanen, ISBN: 978-951-711-296-3, 151–154, 2013.
- O. TITOV AND L. STANFORD: “Geoscience Australia Analysis Center”. In: International VLBI Service for Geodesy and Astrometry 2012 Annual Report, edited by K. D. Baver, D. Behrend and K. L. Armstrong, NASA/TP-2013-217511, 239–240, 2013.
- O. TITOV, L. STANFORD, H. JOHNSON, T. PURSIMO, R. HUNSTEAD, D. JAUNCEY, K. MASLENNIKOV, A. BOLDYCHEVA: “Optical Spectra of Candidate International Celestial Reference Frame (ICRF) Flat-Spectrum Radio Sources”. *The Astronomical Journal*, 146(1), 10pp, 2013.
- M. TITUS, R. CAPPALLO, B. COREY, K. DUDEVOIR, A. NIELL, A. WHITNEY: “Haystack Observatory VLBI Correlator”. In: International VLBI Service for Geodesy and Astrometry 2012 Annual Report, edited by K. D. Baver, D. Behrend and K. L. Armstrong, NASA/TP-2013-217511, 197–200, 2013.
- V. TORNATORE: “PMD IVS Analysis Center”. In: International VLBI Service for Geodesy and Astrometry 2012 Annual Report, edited by K. D. Baver, D. Behrend and K. L. Armstrong, NASA/TP-2013-217511, 302–304, 2013.
- V. TORNATORE AND A. MENNELLA: “On the possibility of using VLBI phase referencing to observe GNSS satellites”. In: Proceedings of the 21st Meeting of the European VLBI Group for Geodesy and Astrometry, edited by N. Zubko and M. Poutanen, ISBN: 978-951-711-296-3, 227–232, 2013.
- D. TROFIMOV AND V. VITYAZEV: “Analysis Center of Saint Petersburg University”. In: International

- VLBI Service for Geodesy and Astrometry 2012 Annual Report, edited by K. D. Baver, D. Behrend and K. L. Armstrong, NASA/TP-2013-217511, 237–238, 2013.
- G. TUCCARI, W. ALEF, M. WUNDERLICH, S. BUTTACCIO, D. GRAHAM, G. COMORETTO, A. BERTARINI, S. CASEY, A. ROY, J. WAGNER, M. LINDQVIST: “DBBC3 - Full digital EVN and VLBI2010 Backend, Project Progress”. In: Proceedings of the 21st Meeting of the European VLBI Group for Geodesy and Astrometry, edited by N. Zubko and M. Poutanen, ISBN: 978-951-711-296-3, 3–8, 2013.
- G. TUCCARI, S. BUTTACCIO, P. CASSARO, C. CONTAVALLE, G. NICOTRA, C. NOCITA, L. PAPALEO, M. PATERNÓ, P. R. PLATANIA, F. SCHILLIRÓ: “Noto Station Status Report”. In: International VLBI Service for Geodesy and Astrometry 2012 Annual Report, edited by K. D. Baver, D. Behrend and K. L. Armstrong, NASA/TP-2013-217511, 120–122, 2013.
- M. UUNILA, A. NOTHNAGEL, J. LEEK, N. KAREINEN: “Influence of source distribution on UT1 derived from IVS INT1 sessions”. In: Proceedings of the 21st Meeting of the European VLBI Group for Geodesy and Astrometry, edited by N. Zubko and M. Poutanen, ISBN: 978-951-711-296-3, 111–116, 2013.
- M. UUNILA, N. ZUBKO, M. POUTANEN, J. KALLUNKI, U. KALLIO: “Metsähovi Radio Observatory - IVS Network Station”. In: International VLBI Service for Geodesy and Astrometry 2012 Annual Report, edited by K. D. Baver, D. Behrend and K. L. Armstrong, NASA/TP-2013-217511, 112–115, 2013.
- A. E. VOLVACH: “Simeiz VLBI Station - Geodetic and Astrophysical Study”. In: International VLBI Service for Geodesy and Astrometry 2012 Annual Report, edited by K. D. Baver, D. Behrend and K. L. Armstrong, NASA/TP-2013-217511, 142–145, 2013.
- G. WANG, J. LI, M. XU, L. GUO, L. LIU, F. SHU, Z. QIAN, L. LI: “SHAO Analysis Center 2012 Annual Report”. In: International VLBI Service for Geodesy and Astrometry 2012 Annual Report, edited by K. D. Baver, D. Behrend and K. L. Armstrong, NASA/TP-2013-217511, 311–314, 2013.
- S. WESTON, H. TAKIGUCHI, T. NATUSCH, L. WOODBURN, S. GULYAEV: “Warkworth 12-m VLBI Station: WARK12M”. In: International VLBI Service for Geodesy and Astrometry 2012 Annual Report, edited by K. D. Baver, D. Behrend and K. L. Armstrong, NASA/TP-2013-217511, 161–164, 2013.
- A. WHITNEY: “IVS Technology Coordinator Report”. In: International VLBI Service for Geodesy and Astrometry 2012 Annual Report, edited by K. D. Baver, D. Behrend and K. L. Armstrong, NASA/TP-2013-217511, 68–72, 2013.
- A. WHITNEY: “Report on 2012 Digital Backend Intercomparison Testing”. In: Proceedings of the 21st Meeting of the European VLBI Group for Geodesy and Astrometry, edited by N. Zubko and M. Poutanen, ISBN: 978-951-711-296-3, 1–2, 2013.
- A. WHITNEY, C. BEAUDOIN, R. CAPPALLO, A. NIELL, B. PETRACHENKO, C. A. RUSZCZYK, M. TITUS: “VLBI Digital-Backend Intercomparison Test Report”. In: International VLBI Service for Geodesy and Astrometry 2012 Annual Report, edited by K. D. Baver, D. Behrend and K. L. Armstrong, NASA/TP-2013-217511, 21–38, 2013.
- B. XIA, Z. SHEN, X. HONG, Q. FAN: “Sheshan VLBI Station Report for 2012”. In: International VLBI Service for Geodesy and Astrometry 2012 Annual Report, edited by K. D. Baver, D. Behrend and K. L. Armstrong, NASA/TP-2013-217511, 139–141, 2013.
- M. H. XU AND G. L. WANG: “The comparison between the UT1 results determined by the IVS Intensive observations”. In: Proceedings of the 21st Meeting of the European VLBI Group for Geodesy and Astrometry, edited by N. Zubko and M. Poutanen, ISBN: 978-951-711-296-3, 141–146, 2013.
- Y. YATSKIV: “IVS Analysis Center at Main Astronomical Observatory of National Academy of Sciences of Ukraine”. In: International VLBI Service for Geodesy and Astrometry 2012 Annual Report, edited by K. D. Baver, D. Behrend and K. L. Armstrong, NASA/TP-2013-217511, 285–286, 2013.
- J. ZHANG AND J. LI: “On the monitoring model of reference point of VLBI antenna”. In: Proceedings of the 21st Meeting of the European VLBI Group

- for Geodesy and Astrometry, edited by N. Zubko and M. Poutanen, ISBN: 978-951-711-296-3, 243–248, 2013.
- V. ZHAROV: “New time series of the EOP and the source coordinates”. In: Proceedings of the 21st Meeting of the European VLBI Group for Geodesy and Astrometry, edited by N. Zubko and M. Poutanen, ISBN: 978-951-711-296-3, 127–130, 2013.
- V. ZHAROV: “SAI VLBI Analysis Center Report 2012”. In: International VLBI Service for Geodesy and Astrometry 2012 Annual Report, edited by K. D. Baver, D. Behrend and K. L. Armstrong, NASA/TP-2013-217511, 309–310, 2013.
- N. ZUBKO AND E. RASTORGUEVA-FOI: “A case study of source structure influence on geodetic parameter estimation”. In: Proceedings of the 21st Meeting of the European VLBI Group for Geodesy and Astrometry, edited by N. Zubko and M. Poutanen, ISBN: 978-951-711-296-3, 193–198, 2013.



# IVS Information





# IVS Terms of Reference

## 1 Summary

### 1.1 Charter

The International VLBI Service for Geodesy and Astrometry (IVS) is an international collaboration of organizations which operate or support Very Long Baseline Interferometry (VLBI) components. IVS provides a service which supports geodetic and astrometric work on reference systems, Earth science research, and operational activities. IVS is a Service of the International Association of Geodesy (IAG) and of the International Astronomical Union (IAU).

### 1.2 Objectives

IVS fulfills its charter through the following objectives:

1. foster and carry out VLBI programs. This is accomplished through close coordination of the participating organizations to provide high-quality VLBI data and products.
2. promote research and development activities in all aspects of the geodetic and astrometric VLBI technique.
3. advance the education and training of VLBI participants through workshops, reports, and other means.
4. support the integration of new components into IVS.
5. interact with the community of users of VLBI products. IVS represents VLBI in the Global Geodetic

Observing System (GGOS) of the IAG and interacts closely with the International Earth Rotation and Reference Systems Service (IERS).

In support of these objectives, IVS coordinates VLBI observing programs, sets performance standards for VLBI stations, establishes conventions for VLBI data formats and data products, issues recommendations for VLBI data analysis software, sets standards for VLBI analysis documentation, and institutes appropriate VLBI product delivery methods to ensure suitable product quality and timeliness. IVS coordinates its activities with the astronomical community because of the dual use of many VLBI facilities and technologies for both astronomy and astrometry/geodesy.

### 1.3 Data Products

VLBI data products contribute uniquely to these important activities:

- defining and maintaining the celestial reference frame,
- monitoring universal time (UT1), and
- monitoring the coordinates of the celestial pole (nutation and precession).

These results are the foundation of many scientific and practical applications requiring the use of an accurate quasi-inertial reference frame, such as high-precision positioning, navigation, and timing. In addition IVS provides a variety of VLBI products with differing applications, timeliness, detail, and temporal resolution, such as:

- all components of Earth orientation parameters,
- terrestrial reference frame,
- baseline lengths, and
- tropospheric parameters.

All VLBI data and products are publicly available in appropriate formats from IVS Data Centers.

## 1.4 Research

The IVS data and products are used for research in many areas of geodesy, geophysics, and astronomy, such as:

- UT1 and polar motion excitation over periods of hours to decades,
- solid Earth interior research (e.g., mantle rheology, anelasticity, libration, and core modes),
- characterization of celestial reference frame sources and improvements to the frame,
- tidal variations (solid Earth, oceanic, and atmospheric),
- improvements in the terrestrial reference frame, especially in the scale,
- climate studies (e.g., sea level change, deglaciation, and water vapor),
- regional and global geodynamics, and
- general relativity.

To support these activities, there are ongoing research efforts to improve and extend the VLBI technique in areas such as:

- instrumentation, data acquisition, and correlation,
- data analysis techniques,
- spacecraft tracking and navigation (Earth-orbiting and interplanetary), and
- combination of VLBI data and results with other techniques.

## 2 Permanent Components

IVS acquires, correlates, and analyzes VLBI data to produce geodetic, astrometric, and other results that are archived and publicized. IVS accomplishes its objectives through the following permanent components:

- Network Stations,
- Operation Centers,
- Correlators,
- Analysis Centers,
- Data Centers,
- Technology Development Centers, and
- Coordinating Center.

### 2.1 Network Stations

The IVS observing network consists of high performance VLBI stations.

- Stations may either be dedicated to geodesy or have multiple uses (including astronomical observations or satellite tracking applications).
- Stations comply with performance standards for data quality and operational reliability specified by the Directing Board.
- Stations provide local tie information, timing and meteorological data to the IVS Data Centers.
- VLBI data acquisition sessions are conducted by groups of Network Stations that may be distributed either globally or over a geographical region.

### 2.2 Operation Centers

The IVS Operation Centers coordinate the routine operations of specific networks. Operation Center activities include:

- planning network observing programs,
- supporting the network stations in improving their performance,
- generating the detailed observing schedules for use in data acquisition sessions by IVS Network Stations, and
- posting the observing schedule to an IVS Data Center for distribution and archiving.

IVS Operation Centers follow guidelines from the Coordinating Center for timeliness and schedule file formats.



### 2.3 Correlators

The IVS Correlators process raw VLBI data. Their other tasks are to:

- provide timely feedback to the Network Stations about data quality,
- jointly maintain the geodetic/astrometric community's media pool and transport,
- manage electronic data transfer,
- make processed data available to the Data Centers, and
- regularly compare processing techniques, models, and outputs to ensure that data from different Correlators are identical.

### 2.4 Analysis Centers

The IVS coordinates VLBI data analysis to provide high-quality products for its users. The analyses are performed by:

- Operational Analysis Center,
- Associate Analysis Centers,
- Special Analysis Centers for Specific Observing Sessions, and
- Combination Centers.

All Analysis Centers maintain and/or develop appropriate VLBI analysis software.

Operational Analysis Centers are committed to producing results to the specifications of the IVS Analysis Coordinator and always on schedule to meet IVS requirements. In addition, Operational Analysis Centers may produce Earth orientation parameters, station coordinates, and source positions in regular intervals.

Operational Analysis Centers place their final results in IVS Data Centers for dissemination to researchers and other users. They adhere to IVS recommendations for the creation of high-quality products and their timely archiving and distribution. Any deviations that an Operational Analysis Center makes from IVS recommendations are properly documented. Operational Analysis Centers provide timely feedback about station performance. In addition to these regular services, Operational Analysis Centers may also perform any task of an Associate Analysis Center.

Associate Analysis Centers are committed to regularly submit specialized products using complete series or subsets of VLBI observing sessions. The analysis is performed for specific purposes as recognized by the Directing Board, such as exploitation of VLBI data for new types of results, investigations of regional phenomena, reference frame maintenance, or special determinations of Earth orientation parameters. The Associate Analysis Centers place their final results in IVS Data Centers for dissemination to researchers and other users. They adhere to IVS recommendations for the creation of high-quality products and their timely archiving and distribution. Any deviations that an Associate Analysis Center makes from IVS recommendations are properly documented.

Special Analysis Centers for Specific Observing Sessions have responsibility for ongoing series-related investigations of one or more existing session types. They perform detailed and comparative analyses of each session of a series within a reasonable time after correlation. In addition, they report deficits and technical complications to the observing sites, the correlators, and to the schedulers as well as to the IVS Network and Analysis Coordinators.

Combination Centers are committed to produce combination results from the individual submissions of the Operational Analysis Centers as official IVS products. For this purpose they monitor the quality of the submissions. The official IVS products include, but are not limited to, EOP time series derived from session-based results for 24-hour network sessions and one-hour Intensive sessions. Combination Centers also contribute to the generation of the official IVS input to International Terrestrial Reference Frame (ITRF) computations. The combination work is done in a timely fashion and in close cooperation with the IVS Analysis Coordinator.

### 2.5 Data Centers

The IVS Data Centers are repositories for VLBI observing schedules, station log files, data and products. Data Centers may mirror other Data Centers to make the distribution and maintenance of data more efficient and reliable.

- Data Centers are the primary means of distributing VLBI products to users.

- Data Centers work closely with the Coordinating Center and with the Analysis Centers to ensure that all the information and data required by IVS components are quickly and reliably available.

Data Centers provide the following functions:

- receive and archive schedule files from Operation Centers,
- receive and archive log files and ancillary data files from the Network Stations,
- receive and archive data products from the Analysis Centers, and
- provide access and public availability to IVS data products for all users.

## **2.6 Technology Development Centers**

The IVS Technology Development Centers contribute to the development of new VLBI technology for improvement of the VLBI technique. They:

- investigate new equipment and approaches,
- develop, test, and document new hardware, firmware, and software for operations,
- assist with deployment, installation, and training for any new approved technology, and
- maintain and support operational equipment.

## **2.7 Coordinating Center**

The IVS Coordinating Center is responsible for coordination of both the day-to-day and the long-term activities of IVS, consistent with the directives and policies established by the Directing Board. Specifically, the Coordinating Center monitors, coordinates, and supports the activities of the Network Stations, Operation Centers, Correlators, Data Centers, Analysis Centers, and Technology Development Centers. The Coordinating Center works closely with the Technology Coordinator, the Network Coordinator, and the Analysis Coordinator to coordinate IVS activities.

The primary functions of the Coordinating Center are to:

- coordinate observing programs approved by the Directing Board,

- create and maintain the master schedule of observing sessions in coordination with IVS Network Stations and astronomical observing programs,
- foster communications among all components of the IVS,
- coordinate the best use of community resources,
- develop standard procedures for IVS components,
- organize training in VLBI techniques,
- organize workshops and meetings, including IVS technical meetings,
- produce and publish reports of activities of IVS components,
- maintain the IVS information system and archive all documents, standards, specifications, manuals, reports, and publications,
- coordinate IVS outreach and educational activities,
- provide liaison with the IAU, IAG, GGOS, IERS, and other organizations, and
- provide the Secretariat of the Directing Board.

## **2.8 Becoming a Permanent Component**

IVS will accept proposals at any time to become a permanent component. Such proposals will be reviewed for approval by the Directing Board.

## **3 Coordinators**

Specific IVS activities regarding network data quality, products, and technology are accomplished through the functions performed by three coordinators: a Network Coordinator, an Analysis Coordinator, and a Technology Coordinator.

### **3.1 Network Coordinator**

The IVS Network Coordinator is selected by the Directing Board from responses to an open solicitation to all IVS components. The Network Coordinator represents the IVS Network Stations on the Directing Board and works closely with the Coordinating Center. The Network Coordinator is responsible for stimulating the maintenance of a high quality level in the station oper-

ation and data delivery. The Network Coordinator performs the following functions:

- monitors adherence to standards in the network operation,
- participates in the quality control of the data acquisition performance of the network stations,
- tracks data quality and data flow problems and suggests actions to improve the level of performance, and
- coordinates software development for station control and monitoring.

The Network Coordinator works closely with the geodetic and astronomical communities who are using the same network stations for observations. The Network Coordinator takes a leading role in ensuring the visibility and representation of the network stations.

### **3.2 Analysis Coordinator**

The IVS Analysis Coordinator is selected by the Directing Board from responses to an open solicitation to the IVS Analysis Centers. The Analysis Coordinator is responsible for coordinating the analysis activities of IVS and for stimulating VLBI product development and delivery. The Analysis Coordinator performs the following functions:

- fosters comparisons of results from different VLBI analysis software packages and different analysis strategies,
- encourages documentation of analysis and combination software,
- participates in comparisons of results from different space geodetic techniques,
- monitors Analysis Centers' products for high quality results and for adherence to IVS standards and IERS Conventions,
- ensures that IVS analysis and combination products from all Analysis Centers are archived and are available to the scientific community, and
- supervises the formation of the official IVS products specified by the IVS Directing Board.

The Analysis Coordinator plays a leadership role in the development of methods for generation and distribution of VLBI products so that the products reach the

users in a timely manner. The Analysis Coordinator interacts with GGOS and the IERS and promotes the use of VLBI products by the broader scientific community. The Analysis Coordinator works closely with the astronomical communities who are using some of the same analysis methods and software.

### **3.3 Technology Coordinator**

The IVS Technology Coordinator is selected by the Directing Board from responses to an open solicitation to the IVS Technology Development Centers. The Technology Coordinator performs the following functions:

- stimulates advancement of the VLBI technique,
- maintains awareness of all current VLBI technologies and ongoing development,
- coordinates development of new technology among all IVS Technology Development Centers,
- encourages technical compatibility with the astronomical community,
- encourages and oversees development of VLBI-related technical standards,
- coordinates the distribution of and access to technical documents and standards, and
- helps promulgate new technologies to the IVS community.

The Technology Coordinator works closely with the astronomical community, both to maintain technical compatibility between the geodetic and astronomical communities and to take advantage of technology development activities in the astronomical community.

## **4 Directing Board**

### **4.1 Roles and Responsibilities**

The Directing Board sets objectives, determines policies, adopts standards, and sets the scientific and operational goals for IVS. The Directing Board exercises general oversight of the activities of IVS including modifications to the organization that are deemed appropriate and necessary to maintain efficiency and reliability. The Directing Board may determine appropriate actions to ensure the quality of the IVS products.

The Directing Board will receive and review proposals for non-IVS research programs that request IVS resources.

## 4.2 Membership

The Directing Board consists of representatives of the IVS components, members at-large, appointed members, and ex officio members. The members are:

Representatives of IVS Components (see below):

- Correlators and Operation Centers representative (1)
- Analysis and Data Centers representatives (2)
- Networks representatives (2)
- Technology Development Centers representative (1)

Elected by the Directing Board upon recommendation from the Coordinating Center (see below):

- Members at large (3)

Selected by Directing Board upon review of proposals from IVS Member Organizations:

- Coordinating Center Director
- Network Coordinator
- Analysis Coordinator
- Technology Coordinator

Appointed members:

- IAU representative
- IAG representative
- IERS representative

Through a reciprocity agreement between IVS and IERS, the IVS serves as the VLBI Technique Center for IERS, and as such its designated representative(s) serve on the IERS Directing Board. In turn, the IERS Directing Board designates a representative to the IVS Directing Board. This arrangement is to assure full cooperation between the two services.

Total number: 16

The members appointed by IAU, IAG, and IERS are not subject to institutional restrictions.

The six members who are the representatives of the IVS components are elected by the IVS Associate Members. All elected members serve staggered four-year terms once renewable.

At-large members are intended to ensure representation on the Directing Board of each of the components of IVS and to balance representation from as many countries and institutions and IVS interests as possible. At-large members serve two-year terms once renewable.

A Directing Board member who departs before the end of his/her term is replaced by a person selected by the Directing Board. The new member will serve until the next official elections. The position will then be filled for a full term.

An individual can only serve two consecutive full terms on the Board in any of the representative and at-large positions. Partial terms are not counted to this limit. After serving two consecutive full terms, an individual becomes eligible again for a position on the Board following a two-year absence.

The three Coordinators are selected by the Directing Board on the basis of proposals from IVS Member Organizations. On a two-thirds vote the Directing Board may call for new proposals for any Coordinator when it determines that a new Coordinator is required. Coordinators are encouraged to give at least six months notice before resigning.

## 4.3 Elections

Election of Board members from the IVS components shall be conducted by a committee of three Directing Board members, the chair of which is appointed by the chair of the Directing Board. The committee solicits nominations for each representative from the relevant IVS components. For each position, the candidate who receives the largest number of votes from the Associate Members will be elected. In case of a tie the Directing Board will make the decision.

## 4.4 Chair

The chair is one of the Directing Board members and is elected by the Board for a term of four years with the

possibility of reelection for one additional term. The chair is the official representative of IVS to external organizations.

#### **4.5 Decisions**

Most decisions by the Directing Board are made by consensus or by simple majority vote of the members present. In case of a tie, the chair decides how to proceed. If a two-thirds quorum is not present, the vote shall be held later by electronic mail. A two-thirds vote of all Board members is required to modify the Terms of Reference, to change the chair, or to replace any of the members before their normal term expires.

#### **4.6 Meetings**

The Directing Board meets at least annually, or more frequently if meetings are called by the chair or at the request of at least three Board members. The Board will conduct periodic reviews of the IVS organization and its mandate, functions, and components.

### **5 Definitions**

#### **5.1 Member Organizations**

Organizations that support one or more IVS components are IVS Member Organizations. Individuals associated with IVS Member Organizations may become IVS Associate Members.

#### **5.2 Affiliated Organizations**

Organizations that cooperate with IVS on issues of common interest, but do not support an IVS component, are IVS Affiliated Organizations. Affiliated Organizations express an interest in establishing and maintaining a strong working association with IVS to mutual benefit. Individuals affiliated with IVS Affiliated

Organizations may become IVS Corresponding Members.

#### **5.3 Associate Members**

Individuals associated with organizations that support an IVS component may become IVS Associate Members. Associate Members take part in the election of the incoming members of the Directing Board representing the IVS components.

#### **5.4 Corresponding Members**

IVS Corresponding Members are individuals who express interest in receiving IVS publications, wish to participate in workshops or scientific meetings organized by IVS, or generally are interested in IVS activities. Ex officio Corresponding Members are the following:

- IAG Secretary General
- Chair of GGOS
- President of IAG Commission 1 – Reference Frames
- President of IAG Commission 3 - Earth Rotation and Geodynamics
- President of IAU Division I – Fundamental Astronomy
- President of IAU Commission 8 – Astrometry
- President of IAU Commission 19 – Rotation of the Earth
- President of IAU Commission 31 – Time
- President of IAU Commission 40 – Radio Astronomy
- President of URSI Commission 52 – Relativity in Fundamental Astronomy
- President of URSI Commission J – Radio Astronomy

Individuals are accepted as IVS Corresponding Members upon request to the Coordinating Center.

*Last modified: 23 September 2011*

## Links to Additional IVS Information

This page provides links to information about the individuals and groups that support IVS. Member organizations are organizations that support one or more permanent components. Permanent components are groups that formally commit to provide support in one of six categories: coordination of network operations (Operation Centers), collection of VLBI data (Network Stations), processing of raw data (Correlators), archival and distribution of data and products (Data Centers), analysis of data and generation of products (Analysis Centers), and development of new technology (Technology Development Centers).

Associate Members are individuals that are associated with a member organization and have been granted Associate Member status. Associate Members generally support IVS by participating in the activities of one or more components.

Affiliated organizations cooperate with IVS on matters of common interest but do not support a component.

Information Category	Link
Associate Members	
(listed alphabetically by last name)	<a href="http://ivscc.gsfc.nasa.gov/about/org/members/assoc_name.pdf">ivscc.gsfc.nasa.gov/about/org/members/assoc_name.pdf</a>
(listed alphabetically by their organization's country)	<a href="http://ivscc.gsfc.nasa.gov/about/org/members/assoc_org.pdf">ivscc.gsfc.nasa.gov/about/org/members/assoc_org.pdf</a>
Permanent Components	
Network Stations	<a href="http://ivscc.gsfc.nasa.gov/about/org/components/ns-list.html">http://ivscc.gsfc.nasa.gov/about/org/components/ns-list.html</a>
Operation Centers	<a href="http://ivscc.gsfc.nasa.gov/about/org/components/oc-list.html">http://ivscc.gsfc.nasa.gov/about/org/components/oc-list.html</a>
Correlators	<a href="http://ivscc.gsfc.nasa.gov/about/org/components/co-list.html">http://ivscc.gsfc.nasa.gov/about/org/components/co-list.html</a>
Data Centers	<a href="http://ivscc.gsfc.nasa.gov/about/org/components/dc-list.html">http://ivscc.gsfc.nasa.gov/about/org/components/dc-list.html</a>
Analysis Centers	<a href="http://ivscc.gsfc.nasa.gov/about/org/components/ac-list.html">http://ivscc.gsfc.nasa.gov/about/org/components/ac-list.html</a>
Technology Development Centers	<a href="http://ivscc.gsfc.nasa.gov/about/org/components/td-list.html">http://ivscc.gsfc.nasa.gov/about/org/components/td-list.html</a>
Member Organizations	<a href="http://ivscc.gsfc.nasa.gov/about/org/members/memberorgs.html">http://ivscc.gsfc.nasa.gov/about/org/members/memberorgs.html</a>
Affiliated Organizations	<a href="http://ivscc.gsfc.nasa.gov/about/org/members/affilmemberorgs.html">http://ivscc.gsfc.nasa.gov/about/org/members/affilmemberorgs.html</a>