



# Building and Testing a Portable VLF Receiver

Robert McLaughlin<sup>1</sup>(rmlaughlin@uclan.ac.uk), L. Krause<sup>2</sup>

<sup>1</sup>University of Central Lancashire, Preston, Lancashire, United Kingdom  
<sup>2</sup>National Space Science Technology Center, Huntsville, AL, United States



## Abstract

Unwanted emissions or signal noise is a major problem for VLF radio receivers. These can occur from man made sources such as power line hum, which can be prevalent for many harmonics after the fundamental 50 or 60 Hz AC source or from VLF radio transmissions such as LORAN, used for navigation and communications.

Natural emissions can also be detrimental to the quality of recordings as some of the more interesting natural emissions such as whistlers or auroral chorus may be drowned out by the more common sferic emissions.

VLF receivers must selectively filter out unwanted emissions and amplify the filtered signal to a record-able level without degrading the quality.

## Background

Very Low Frequency refers to a specific band of radio waves between 3 and 30 kHz. Natural emissions of radio waves occur in this band from lightning strikes and other means and are transmitted through the ionosphere, which acts as a wave guide. As such, VLF emissions can be analysed to give an insight into the nature of the ionosphere and how it changes between day and night.

VLF emissions are also known as natural radio emissions and as a result of them occurring on the same frequencies as the human hearing range, they can then be converted directly to sound and listened to or recorded, without the need for demodulation.

Receivers can be employed in a variety of functions including the geo-location of lightning activity using a network of multiple receivers.

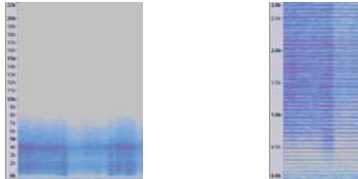

Recording made with an RS-4 VLF receiver indoors without an antenna showing prevalence of AC hum. Each line denotes an AC harmonic

## Simulation

The schematic was simulated using a software package, providing a basis for comparison of expected measurements versus actual measurements.

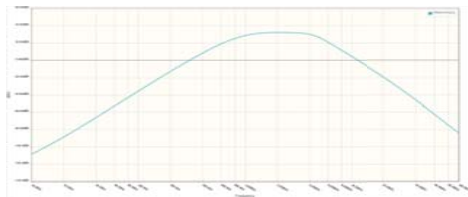

Bode plot of simulated circuit. Signals at frequencies below the line are attenuated. Pass band gain of 30 dB between 900 Hz and 5 kHz

## Receiver Circuit

The receiver circuit consists of an antenna linked to a variety of different electrical components and semiconductors that both filter and amplify the signal from the antenna. The goal of the circuit is to provide a signal gain of around 30 dB whilst still maintaining a suitable frequency range throughout the pass band of the circuit.

The receiver connects to a simple antenna to receive the radio emissions, a long loop of wire or a simple vertical 'whip' antenna is sufficient to pick up the waves.

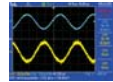
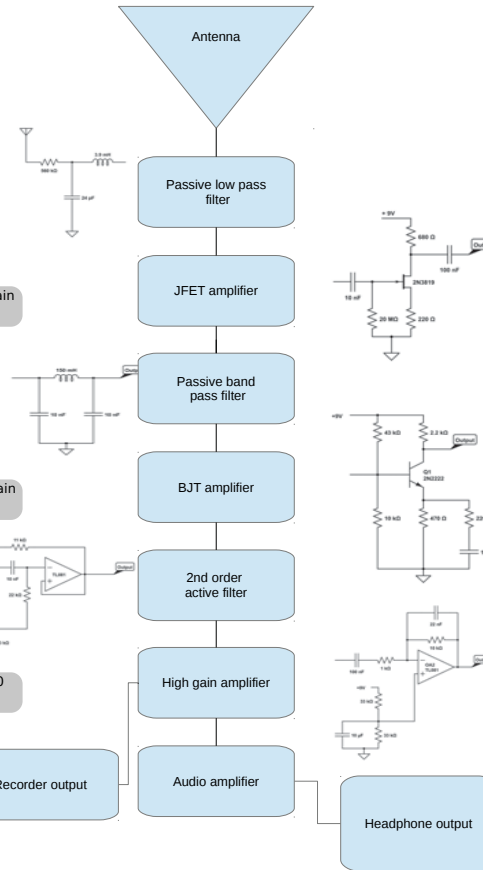

JFET amplification showing 3 dB gain and signal inversion

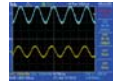

BJT amplification showing 13 dB gain and phase change

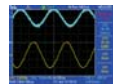

High gain amplification showing 40 dB gain and further phase change

## Amplification

The signal from the antenna is of the order of microvolts. To be picked up by a microphone socket or to be audible on headphones it must be amplified by at least 30 dB, around 33 times the source. This is done gradually through the stages.

The FET amplifier stage provides a gain of 3 dB, the output is 1.5 x the input

The BJT amplifier stage provides an additional gain of 10 dB, the output is 5 x the input

The high gain amplifier stage has a pass band gain of 40 dB, the output is 200 x the input

## Testing

The circuit was broken down into stages and tested individually before being merged into the final design. The testing took place using prototyping board, allowing for modifications to be made on the fly.

An oscilloscope was used to measure the output of the circuitry at various points and a function generator was used to create low voltage test signals at various frequencies to measure the frequency response of the constructed circuit in controlled circumstances

## Frequency response

The signal is filtered to reduce unwanted noise from distorting the signal or, in the case of emissions from nearby power lines, drowning it out.

Filtering is achieved through passive and active circuits.

The oscilloscope snapshots are taken to show the frequency response of the circuit. The 1, 3 and 5 kHz snapshots all feature roughly the same level of signal gain, indicating that they are representative of the pass band gain of the circuit.

The 300 Hz snapshot and the 10, 15 and 30 kHz snapshots are less amplified, indicating that they lie on either side of the pass band and are being filtered to varying degrees

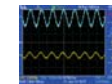

300 Hz

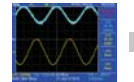

1 kHz

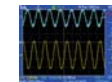

3 kHz

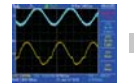

5 kHz

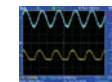

10 kHz



15 kHz

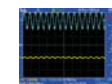

30 kHz

## Signal distortion

It can be seen that in the 5 and 10 kHz snapshots, the signals are somewhat distorted from the original. The distortion is no longer seen from the 15 kHz snapshot onwards, indicating that the distortion may be phase related.

## References

Watt, A. VLF Radio Engineering, 1967  
Hayward, W. Radio Frequency Design, 3<sup>rd</sup> ed, 2000

## Acknowledgments

This work is supported by a grant by the National Science Foundation under Grant No. AGS-1157027 with additional financial support from the University of Alabama in Huntsville