

NASA/TP-2015-218570

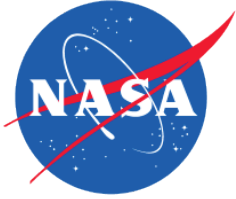

# **Life Support Baseline Values and Assumptions Document**

*Molly S. Anderson  
Michael K. Ewert  
John F. Keener  
Sandra A. Wagner*

Responsible National Aeronautics and Space Administration Official:

*Molly S. Anderson  
CTSD, Lyndon B. Johnson Space Center  
National Aeronautics and Space Administration  
Mail Code EC2  
2101 NASA Road One  
Houston, Texas 77058*

---

March 2015

## THE NASA STI PROGRAM OFFICE . . . IN PROFILE

Since its founding, NASA has been dedicated to the advancement of aeronautics and space science. The NASA Scientific and Technical Information (STI) Program Office plays a key part in helping NASA maintain this important role.

The NASA STI Program Office is operated by Langley Research Center, the lead center for NASA's scientific and technical information. The NASA STI Program Office provides access to the NASA STI Database, the largest collection of aeronautical and space science STI in the world. The Program Office is also NASA's institutional mechanism for disseminating the results of its research and development activities. These results are published by NASA in the NASA STI Report Series, which includes the following report types:

- **TECHNICAL PUBLICATION.** Reports of completed research or a major significant phase of research that present the results of NASA programs and include extensive data or theoretical analysis. Includes compilations of significant scientific and technical data and information deemed to be of continuing reference value. NASA's counterpart of peer-reviewed formal professional papers but has less stringent limitations on manuscript length and extent of graphic presentations.
- **TECHNICAL MEMORANDUM.** Scientific and technical findings that are preliminary or of specialized interest, e.g., quick release reports, working papers, and bibliographies that contain minimal annotation. Does not contain extensive analysis.
- **CONTRACTOR REPORT.** Scientific and technical findings by NASA-sponsored contractors and grantees.
- **CONFERENCE PUBLICATION.** Collected papers from scientific and technical conferences, symposia, seminars, or other meetings sponsored or cosponsored by NASA.
- **SPECIAL PUBLICATION.** Scientific, technical, or historical information from NASA programs, projects, and mission, often concerned with subjects having substantial public interest.
- **TECHNICAL TRANSLATION.** English-language translations of foreign scientific and technical material pertinent to NASA's mission.

Specialized services that complement the STI Program Office's diverse offerings include creating custom thesauri, building customized databases, organizing and publishing research results . . . even providing videos.

For more information about the NASA STI Program Office, see the following:

- Access the NASA STI Program Home Page at <http://www.sti.nasa.gov>
- E-mail your question via the internet to [help@sti.nasa.gov](mailto:help@sti.nasa.gov)
- Fax your question to the NASA Access Help Desk at (301) 621-0134
- Telephone the NASA Access Help Desk at (301) 621-0390
- Write to:  
NASA Access Help Desk  
NASA Center for AeroSpace Information  
7115 Standard  
Hanover, MD 21076-1320

NASA/TP-2015-218570

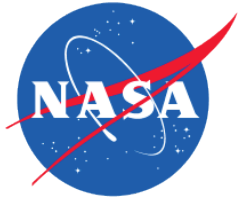

# **Life Support Baseline Values and Assumptions Document**

*Molly S. Anderson  
Michael K. Ewert  
John F. Keener  
Sandra A. Wagner*

Responsible National Aeronautics and Space Administration Official:

*Molly S. Anderson  
CTSD, Lyndon B. Johnson Space Center  
National Aeronautics and Space Administration  
Mail Code EC2  
2101 NASA Road One  
Houston, Texas 77058*

---

March 2015

Available from:

NASA Center for Aerospace Information  
7115 Standard Drive  
Hanover, MD 21076-1320

National Technical Information Service  
5301 Shawnee Road  
Alexandria, VA 22312

Available in electronic form at <http://ston.jsc.nasa.gov/collections/TRS/>

Update Prepared by:

Sandra A. Wagner 12/19/2014  
Date  
Sandra A. Wagner, Life Support Analyst (JSC\EC2)  
Design and Analysis Branch, Crew and Thermal Systems Division

John F. Keener 1/15/15  
Date  
John F. Keener, Life Support Analysis Lead  
JSC Engineering, Technology and Science contract

Molly S. Anderson 1/14/15  
Date  
Molly S. Anderson, Life Support Analyst (JSC\EC2)  
Design and Analysis Branch, Crew and Thermal Systems Division

Michael K. Ewert 1/14/15  
Date  
Michael K. Ewert, Life Support Analyst (JSC\EC2)  
Design and Analysis Branch, Crew and Thermal Systems Division

Approved by:

Victoriano Z. Untalan 1/20/15  
Date  
Victoriano Z. Untalan  
Chief, Design and Analysis Branch, Crew and Thermal Systems Division

Jordan L. Metcalf 1/15/15  
Date  
Jordan L. Metcalf  
Chief, Life Support Systems Branch, Crew and Thermal Systems Division

Christopher P. Hansen 1-21-15  
Date  
Christopher P. Hansen  
Chief, Crew and Thermal Systems Division

## Change Log

Effective Date	Version		Description	Authors
June 1999			JSC 39317	A. Drysdale, A. Hanford
May 2002			JSC 47804	A. Hanford
August 2004			NASA CR-2004-208941	A. Hanford
April 2006			NASA CR-2006-213693	A. Hanford
October 2008	Rev. A		Update Reflecting Constellation Program Requirements Refinement	B. Duffield
February 2010	Rev. B		Update Reflecting Constellation Program & LAT2 High Mobility Scenario	B. Duffield
2015	NASA TP		Removed restricted Constellation information to create a publicly releasable version	Anderson, Ewert, Wagner, Keener

# Contents

1	Introduction .....	1
1.1	Purpose and Process .....	1
1.2	Advantages .....	2
1.3	Acknowledgements .....	2
2	Approach .....	3
2.1	Development .....	3
2.2	Context .....	3
2.3	Life Support Subsystems .....	3
2.4	Definitions .....	7
2.4.1	Modeling .....	7
2.4.2	Infrastructure .....	7
2.4.3	Equivalent system mass .....	8
2.4.3.1	Equivalent system mass example .....	8
2.4.3.2	Equivalent System Mass Description .....	8
2.4.4	Units and Values .....	8
2.5	Mission Duration .....	9
2.6	Applicable Documents .....	18
3	Overall Assumptions .....	18
3.1	Missions .....	18
3.1.1	Typical Values for Exploration Missions .....	19
3.1.2	Asteroid Missions .....	22
3.2	Infrastructure Costs and Equivalencies .....	22
3.2.1	Infrastructure Costs based upon the Exploration Systems Architecture Study .....	23
3.2.2	Pressurized Volume or Primary Structure Costs .....	24
3.2.3	Radiation Shielding for TransHab .....	27
3.2.4	Secondary Structure Costs .....	28
3.2.4.1	Lunar Architecture team High Mobility Scenario .....	29
3.2.5	Power Costs .....	32
3.2.6	Thermal Control Costs .....	38
3.2.7	Crewtime Costs .....	40
3.2.8	Location Factors .....	40
3.3	Crew Characteristics .....	42
3.3.1	Crew Metabolic Rate .....	42
3.3.1.1	General Metabolic Rates .....	42
3.3.2	Exploration Metabolic Loads .....	44
3.3.3	Crewtime Estimates .....	46
3.3.4	Nominal Human Interfaces .....	49
4	Life Support Subsystem Assumptions and Values .....	51
4.1	Air Subsystem .....	51
4.1.1	Design Values for Atmospheric Systems .....	51
4.1.2	Gas Storage .....	55
4.1.3	Planetary Dust .....	55
4.1.3.1	Regolith .....	56
4.1.3.2	Planetary Dust System Impacts .....	57
4.1.3.3	Regolith Contamination Management - Layered Engineering Defense Strategy .....	61
4.2	Water Subsystem .....	62
4.2.1	Design Values for Water Subsystems .....	62
4.2.2	Wastewater Component Contaminant Loading .....	65
4.2.3	Wastewater and Intermediate Water System Solution Formulations for Testing .....	71
4.3	Waste Subsystem .....	71
4.3.1	Historical Data on Skylab .....	72
4.3.2	Historical Waste Loads from Space Transportation System Missions .....	72
4.3.3	Solid Waste Management for Future Long-Duration Missions .....	82

4.3.3.1	Feces .....	84
4.3.3.2	Urine .....	84
4.3.3.3	Menstruation .....	85
4.3.3.4	Toilet Paper .....	85
4.3.3.5	Miscellaneous Body Wastes.....	86
4.3.3.6	Disposable Hygiene Products.....	86
4.3.3.7	Food Packaging, Inedible Biomass, and Wasted Food .....	87
4.3.3.8	Paper, Tape, Miscellaneous Hygiene Products, and Clothing.....	88
4.3.3.9	Greywater and Brine .....	89
4.3.4	Elemental Composition of Waste.....	89
4.3.4.1	Modeling Waste Systems.....	90
4.3.4.2	Other Waste Streams.....	90
4.3.5	Wastewater Recovery Model for a Lunar Surface Mission.....	91
4.3.5.1	Model Development and Characteristics.....	91
4.3.5.2	Lunar Outpost Waste Model Results.....	92
4.3.5.3	Future Waste Model Efforts.....	93
4.4	Habitation Interface.....	99
4.4.1	Clothing Systems.....	99
4.4.2	Stowage Systems.....	102
4.4.3	Wardroom Systems .....	104
4.4.4	Crew Hygiene Systems .....	104
4.4.5	Crew Accommodation Systems .....	104
4.4.6	Galley Systems.....	104
4.4.7	Habitat Light Output and Distribution .....	104
4.5	Food Interface .....	105
4.5.1	Physical Parameters for Historical Food Flight Systems .....	105
4.5.2	Physical Parameters of Refrigeration Equipment.....	107
4.5.3	Crewtime for the Food Subsystem .....	108
4.5.4	Food Subsystem Waste Generation.....	109
4.5.5	Overall Food Subsystem Parameters.....	109
4.5.6	Food Subsystem Based on Bulk Packaging .....	110
4.5.6.1	Commodities .....	110
4.5.6.2	Equipment .....	115
4.5.6.3	Crewtime.....	117
4.5.6.4	Nutrition.....	118
4.5.7	Food Subsystems Based on Biomass Production Systems.....	119
4.5.8	Food Processing .....	127
4.6	Extravehicular Activity Support Interface .....	128
4.6.1	Operations During Transit to Mars.....	129
4.6.2	Martian Surface Operations.....	130
4.6.3	Lunar Surface Operations.....	132
4.6.4	Recommended Prebreathe intervals for EVA .....	132
4.6.4.1	Decompression Sickness Prevention.....	132
4.6.4.2	Final R Value .....	133
4.6.4.3	Maximum Prebreathe Time.....	133
4.6.4.4	Prebreathe Bound .....	133
4.6.4.5	ISS Prebreathe Protocols.....	136
4.6.4.6	Contingency EVA .....	137
4.7	Power Interface .....	137
4.8	Radiation Protection Interface.....	137
4.9	Thermal Control Interface.....	138
4.9.1	Heat Transfer Mechanisms.....	138
4.9.1.1	Conduction .....	138
4.9.1.2	Convection .....	138
4.9.1.3	Radiation .....	138
4.9.1.4	Heat Transfer with Phase Change .....	139



4.9.2	Thermal Control Organization .....	139
4.9.2.1	Passive and Active Thermal Control.....	139
4.9.2.2	Passive Thermal Control .....	139
4.9.2.3	Active Thermal Control .....	140
4.9.2.4	General Thermal Control Architecture.....	140
4.9.2.5	Internal Thermal Control System.....	141
4.9.2.6	Cabin Atmospheric Thermal Loads .....	141
4.9.2.7	External Thermal Control System.....	141
4.9.3	Thermal Control Technology .....	143
4.9.3.1	Historical Thermal Control Approaches .....	143
4.9.4	Radiant Energy Balance .....	146
4.9.5	Thermal Control Values .....	147
4.10	Crew Healthcare.....	150
4.11	Environmental Monitoring.....	154
4.12	In-Situ Resource Utilization Interface.....	157
4.13	Integrated Control Interface .....	159
4.14	Biomass Production .....	160
4.14.1	Plant Growth Chambers .....	160
4.14.1.1	Lighting Assumptions .....	160
4.14.1.2	Lighting Equipment Data .....	162
4.14.1.3	Plant Growth Chamber Cost Factors.....	163
4.14.1.4	Plant Values .....	163
4.14.1.5	Modified Energy Cascade Models for Crop Growth.....	171
4.14.1.6	Modified Energy Cascade Models for Crop Biomass Production.....	171
4.14.1.7	Modified Energy Cascade Models for Crop Transpiration .....	177
4.15	Planetary Protection .....	184
4.15.1	What Designs Decrease the Probability of Contaminating Mars and Earth? .....	184
4.15.2	Backward Contamination .....	186
4.15.2.1	Safeguard Earth.....	186
4.15.2.2	Human Surface Systems Will Not Be Completely Closed.....	186
4.15.2.3	Provide a Quarantine Capability .....	186
4.15.2.4	Use Conservative Approaches Initially.....	186
4.15.3	Forward Contamination.....	186
4.15.3.1	Control and Understand Human-Associated Contamination .....	186
4.15.3.2	Human Surface Systems Will Not Be Completely Closed.....	187
4.15.3.3	Do Not Affect “Special Regions” .....	187
5	References .....	188
6	Appendices .....	201
6.1	Appendix A - Acronyms and Abbreviations.....	201
6.2	Appendix B - Abbreviations for Units .....	203

# Tables

Table 2.1	Life Support Subsystem Descriptions and Interfaces .....	4
Table 2.2	Life Support Interfaces Descriptions .....	5
Table 2.3	Overall Description of Mission Duration and Life Support System Functionality.....	10
Table 2.4	Functionality and Possible Options for the Air Subsystem .....	12
Table 2.5	Functionality and Possible Options for the Habitation Interface .....	14
Table 2.6	Functionality and Possible Options for the Waste Subsystem.....	15
Table 2.7	Functionality and Possible Options for the Water Subsystem .....	16
Table 3.1	Mission Assumptions .....	20
Table 3.2	Typical System Power Requirements based on ISS .....	21
Table 3.3	Long-Duration Lunar Mission Infrastructure “Costs” .....	23
Table 3.4	Mars Mission Infrastructure “Costs” .....	23
Table 3.5	Lunar Outpost Mission Infrastructure “Costs” .....	24
Table 3.6	Cost of Pressurized Volume .....	25
Table 3.7	Masses of Inflatable Shell Components.....	26
Table 3.8	Estimated Masses and Volume-Mass Penalties for Inflatable Module Configurations .....	27
Table 3.9	Estimated Masses for Inflatable Modules.....	28
Table 3.10	Secondary Structure Masses .....	29
Table 3.11	Primary Makeup of Pressure Vessels for High Mobility Scenario .....	30
Table 3.12	Calculated Equivalencies for High Mobility Scenario .....	31
Table 3.13	Power Module Characteristics for Nuclear Reactor Proposals .....	33
Table 3.14	Power Option Summary .....	35
Table 3.15	Characteristics of Advanced Rechargeable Batteries .....	38
Table 3.16	Advanced Fuel Cell Systems .....	38
Table 3.17	Advanced Mission Thermal Control Costs and Equivalencies.....	39
Table 3.18	Location Factors for Near-Term Missions.....	41
Table 3.19	Equivalencies Based on Hardware Delineated During the Second Lunar Architecture Study of the Constellation Program.....	42
Table 3.20	Crewmember Mass Limits.....	43
Table 3.21	Human Metabolic Rates .....	43
Table 3.22	Crew Induced Metabolic Loads.....	45
Table 3.23	Time Allocation for a Nominal Crew Schedule in a Weightless Environment .....	46
Table 3.24	Crewtime per Crewmember per Week .....	47
Table 3.25	Crewtime-Mass Penalty Values Based Upon the Fiscal Year 2006 Advanced Life Support Research and Technology Development Metric.....	48
Table 3.26	Summary of Nominal Human Metabolic Interface Values .....	50
Table 4.1	Typical Steady-State Values for Vehicle Atmospheres.....	53
Table 4.2	Spacecraft Maximum Allowable Concentrations for CO <sub>2</sub> .....	53
Table 4.3	Symptoms of Carbon Dioxide Toxicity.....	54
Table 4.4	Model for Trace Contaminant Generation .....	55
Table 4.5	Gas Storage.....	55
Table 4.6	Elemental Data for Martian Dust, Panda Subclass Soil, and MoessBerry Subclass Soil ....	57
Table 4.7	Air Revitalization System Effects of Dust Exposure.....	57
Table 4.8	Water Recovery System Effects of Dust Exposure .....	58
Table 4.9	Solid Waste Effects of Dust Exposure.....	58
Table 4.10	Thermal Effects of Dust Exposure.....	58
Table 4.11	Other Life Support Systems Effects of Dust Exposure.....	59
Table 4.12	Airlock Effects of Dust Exposure.....	59
Table 4.13	Space Suit Assembly Effects of Dust Exposure .....	59
Table 4.14	Portable Life Support System (PLSS) Power and Communications Effects of Dust Exposure .....	60
Table 4.15	PLSS Cooling Effects of Dust Exposure .....	60
Table 4.16	PLSS O <sub>2</sub> Effects of Dust Exposure .....	60

Table 4.17	PLSS Vent Effects of Dust Exposure .....	60
Table 4.18	Ancillary Equipment Effects of Dust Exposure.....	61
Table 4.19	Advance Food Systems Effects of Dust Exposure .....	61
Table 4.20	Steady-State Values for Vehicle Water Usage for Short Duration Missions.....	63
Table 4.21	Typical Steady-State Water Usage Rates for Various Missions .....	64
Table 4.22	Typical Steady-State Wastewater Generation Rates for Various Missions .....	65
Table 4.23	Wastewater Contaminants in Extravehicular Mobility Unit Stream.....	66
Table 4.24	Wastewater Contaminants in Crew Latent Condensate.....	67
Table 4.25	Wastewater Contaminants in Crew Shower Stream .....	68
Table 4.26	Wastewater Contaminants in Crew Hygiene Stream.....	69
Table 4.27	Wastewater Contaminants in Crew Urine Stream .....	70
Table 4.28	Wastewater Contaminants in Animal Latent Condensate.....	71
Table 4.29	Waste Analysis for STS-51D Trash.....	73
Table 4.30	Space Transportation System Crew Provision Wastes from Past Missions.....	74
Table 4.31	International Space Station Reference Mission Vehicle Wastes .....	76
Table 4.32	International Space Station Reference Mission Vehicle Wastes (continued).....	77
Table 4.33	International Space Station Reference Mission Vehicle Wastes (concluded) .....	78
Table 4.34	Advanced Mars Exploration Reference Mission Vehicle Wastes .....	79
Table 4.35	Advanced Mars Exploration Reference Mission Vehicle Wastes (continued).....	80
Table 4.36	Advanced Mars Exploration Reference Mission Vehicle Wastes (concluded) .....	81
Table 4.37	Summary Information on Wastes for Developing Waste Models for Future Long-Duration Missions .....	83
Table 4.38	Feces.....	84
Table 4.39	Urine.....	85
Table 4.40	Menstruation Byproducts .....	85
Table 4.41	Toilet Paper .....	86
Table 4.42	Miscellaneous Body Wastes .....	86
Table 4.43	Disposable Hygiene Products.....	87
Table 4.44	Selected References on Food Packaging, Inedible Biomass, and Wasted Food.....	88
Table 4.45	Composition of Paper, Tape, Miscellaneous Hygiene Products, and Clothing .....	89
Table 4.46	Other Waste Streams .....	91
Table 4.47	Lunar Outpost Mission Waste Sources Design Values and Water Content .....	95
Table 4.48	Estimated Stoichiometric Model of Useful Waste Products.....	98
Table 4.49	Clothing and Laundry Options .....	100
Table 4.50	Early ISS Laundry Equipment Specifications .....	100
Table 4.51	Recent Laundry Break-Even Studies and Their Major Parameters .....	101
Table 4.52	Advanced Washer/Dryer Specifications.....	101
Table 4.53	Estimates of Mass and Volume for Stowed EVA Suits and Emergency Suits .....	103
Table 4.54	Historical and Near-Term Food Subsystem Masses .....	106
Table 4.55	A 10-Day Menu for Short-Term Missions .....	106
Table 4.56	International Space Station Refrigerator / Freezer Properties.....	107
Table 4.57	Frozen Food Storage on a Property per Frozen-Food-Mass Basis .....	108
Table 4.58	Food Quantity and Packaging.....	109
Table 4.59	Ingredients, Commodity Sources, and Yield Values on a Per-Crewmember Per-Day Basis for 10-Day, Bulk-Commodity Menu .....	111
Table 4.60	Mechanical Processor Characteristics for 10-Day Bulk Commodity Menu.....	115
Table 4.61	Food Preparation Equipment for 10-Day Bulk Commodity Menu.....	116
Table 4.62	Crewtime Requirements for 10-Day Bulk Commodity Menu.....	117
Table 4.63	Ingredient Processing Equipment Crewtime Values for Each 10-Day Menu Cycle .....	118
Table 4.64	Nutrient Values for 10-Day Bulk-Packaged Food Menu.....	119
Table 4.65	Menu Masses for Diets Using Advanced Life Support Crops and Resupplied Foods [Note that this table is based on 11.82MJ/CM-d, whereas subsequent tables have been updated to a higher energy requirement] .....	120
Table 4.66	Nutritional Content of Diets Using Advanced Life Support Crops and Resupplied Foods [Note that this table is based on original 11.82MJ/CM-d since its purpose is nutritional integrity, whereas subsequent tables have been updated to a higher energy requirement.]	121

Table 4.67	Properties of Early Mars Diets for Intravehicular Activities Using Resupplied Foods ....	123
Table 4.68	Nutritional Content of Early Mars Diets for Intravehicular Activities Using Resupplied Foods .....	124
Table 4.69	Menu Masses for Diets Using Advanced Life Support Crops and Resupplied Foods.....	125
Table 4.70	Nutritional Content of Diets Using Advanced Life Support Crops and Resupplied Foods	126
Table 4.71	Updated Salad Crop Only Dietary Contributions .....	127
Table 4.72	Overall Crops Masses for Updated Salad Crop Only Diet .....	127
Table 4.73	Local Accelerations Due to Gravity .....	128
Table 4.74	Historical Extravehicular Activity Masses .....	129
Table 4.75	Weights of Historical Spacesuits under Gravitational Loadings .....	129
Table 4.76	Summary of Extravehicular Activity Values for Lunar Surface Operations .....	131
Table 4.77	Extravehicular Activity Metabolic Loads.....	132
Table 4.78	Surface Optical Properties for Common Exterior Space Material.....	148
Table 4.79	Crew Cabin Thermal Ranges.....	148
Table 4.80	Properties for Common Thermal Control Loop Working Fluids.....	149
Table 4.81	Thermodynamic Properties of Common Thermal Control Phase-Change Materials for Liquid-Vapor Transitions .....	150
Table 4.82	Thermodynamic Properties of Common Thermal Control Phase-Change Materials for Solid-Liquid Transitions.....	150
Table 4.83	Classification of Illnesses and Injuries in Healthcare (Houtchens, 1993).....	151
Table 4.84	Medical Hardware and Stowage - Lunar Outpost.....	153
Table 4.85	Medical Hardware and Stowage - Lunar Outpost Exercise Countermeasures or Dust Management .....	154
Table 4.86	Medical Hardware and Stowage- Lunar Sortie.....	154
Table 4.87:	Volatile Organic Compounds .....	156
Table 4.88	Microbial Specifications of USOS air and surfaces for ISS .....	157
Table 4.89	Microbial Specifications of ISS water in USOS.....	157
Table 4.90	Acoustic Noise Limits in the USOS of ISS. ....	157
Table 4.91	Nitrogen Gas Losses Associated with International Space Station Technology.....	158
Table 4.92	Nitrogen Gas Losses for the Mars Design Reference Mission (One Cycle) Using ISS Technologies .....	158
Table 4.93	Estimation of Cost Leverages from In-Situ Resource Utilization .....	159
Table 4.94	Lighting Data.....	160
Table 4.95	High Pressure Sodium Lighting Data .....	162
Table 4.96	Plant Growth Chamber Equivalent System Mass per Growing Area .....	163
Table 4.97	Exploration Life Support Cultivars, Intended Usage, and Environmental Growth Conditions .....	165
Table 4.98	Overall Physical Properties at Maturity for Nominal Crops .....	166
Table 4.99	Nominal and Highest Biomass Production, Composition, and Metabolic Products .....	167
Table 4.100	Inedible Biomass Generation for Exploration Life Support Diets Based on Fresh Weight	168
Table 4.101	Plant Growth and Support Requirements per Dry Biomass .....	169
Table 4.102	Composition of Initial Nutrient Solution .....	170
Table 4.103	Composition of Replenishment Nutrient Solution.....	170
Table 4.104	Values for the Exponent n in MEC Models.....	171
Table 4.105	Summary of Modified Energy Cascade Model Variables for Biomass Production.....	173
Table 4.106	Biomass Production Model Constants .....	174
Table 4.107	Format for Tables of Coefficients for Equations Employing Multivariable Polynomial Regression Fits.....	175
Table 4.108	Maximum Canopy Quantum Yield, CQY <sub>MAX</sub> , Coefficients for Dry Bean.....	175
Table 4.109	Maximum Canopy Quantum Yield, CQY <sub>MAX</sub> , Coefficients for Lettuce.....	175
Table 4.110	Maximum Canopy Quantum Yield, CQY <sub>MAX</sub> , Coefficients for Peanut.....	175
Table 4.111	Maximum Canopy Quantum Yield, CQY <sub>MAX</sub> , Coefficients for Rice .....	176
Table 4.112	Maximum Canopy Quantum Yield, CQY <sub>MAX</sub> , Coefficients for Soybean.....	176
Table 4.113	Maximum Canopy Quantum Yield, CQY <sub>MAX</sub> , Coefficients for Sweet Potato.....	176
Table 4.114	Maximum Canopy Quantum Yield, CQY <sub>MAX</sub> , Coefficients for Tomato .....	176
Table 4.115	Maximum Canopy Quantum Yield, CQY <sub>MAX</sub> , Coefficients for Wheat .....	176

Table 4.116	Maximum Canopy Quantum Yield, $CQY_{MAX}$ , Coefficients for White Potato.....	177
Table 4.117	Summary of Modified Energy Cascade Model Variables for Canopy Transpiration .....	178
Table 4.118	Nominal Temperature Regimes, Planting Densities, and Photoperiods for the Plant Growth and Transpiration Models .....	180
Table 4.119	Biomass Production Model Time Constants for Nominal Temperature Regime and Photoperiod.....	180
Table 4.120	Biomass Carbon and Oxygen Production Fractions for Nominal Temperature Regime and Photoperiod.....	181
Table 4.121	Canopy Closure Time, $t_A$ , Coefficients for Dry Bean with Nominal Conditions .....	181
Table 4.122	Canopy Closure Time, $t_A$ , Coefficients for Lettuce with Nominal Conditions.....	182
Table 4.123	Canopy Closure Time, $t_A$ , Coefficients for Peanut with Nominal Conditions.....	182
Table 4.124	Canopy Closure Time, $t_A$ , Coefficients for Rice with Nominal Conditions .....	182
Table 4.125	Canopy Closure Time, $t_A$ , Coefficients for Soybean with Nominal Conditions.....	182
Table 4.126	Canopy Closure Time, $t_A$ , Coefficients for Sweet Potato with Nominal Conditions.....	182
Table 4.127	Canopy Closure Time, $t_A$ , Coefficients for Tomato with Nominal Conditions .....	183
Table 4.128	Canopy Closure Time, $t_A$ , Coefficients for Wheat with Nominal Conditions .....	183
Table 4.129	Canopy Closure Time, $t_A$ , Coefficients for White Potato with Nominal Conditions.....	183
Table 4.130	MEC Model Parameters for Low-Light Conditions, Nominal Temperature Regimes .....	184

# Figures

Figure: 2.1	Life Support System interfaces.....	7
Figure: 3.1	Power generation and storage options considered.....	32
Figure: 4.1	Curves of constant EVA prebreathe time for a 29.6 kPa space suit with a final R-value of 1.3. Assumed upper bound on prebreathe time is 60 minutes.....	134
Figure: 4.2	Curves of constant EVA prebreathe time for a 29.6 kPa space suit with a final R-value of 1.4. Assumed upper bound on prebreathe time is 60 minutes.....	135
Figure: 4.3	Curves of constant EVA prebreathe time for a 41.4 kPa space suit with a final R-value of 1.3. Assumed upper bound on prebreathe time is 60 minutes.....	135
Figure: 4.4	Curves of constant EVA prebreathe time for a 41.4 kPa space suit with a final R-value of 1.4. Assumed upper bound on prebreathe time is 60 minutes.....	136
Figure: 4.5	Active Thermal Control System component definitions.....	142
Figure: 4.6	Active Thermal Control System hardware for the shuttle orbiter.....	144
Figure: 4.7	External Active Thermal Control System hardware for International Space Station at assembly complete.....	145
Figure: 4.8	Environmental Health.....	155

# 1 INTRODUCTION

The Baseline Values and Assumptions Document (BVAD) provides analysts, modelers, and other life support researchers with a common set of values and assumptions that can be used as a baseline in their studies. This baseline, in turn, provides a common point of origin from which many studies in the community may depart, making research results easier to compare and providing researchers with reasonable values to assume for areas outside their experience. With the ability to accurately compare different technologies' performance for the same function, managers will be able to make better decisions regarding technology development.

## 1.1 PURPOSE AND PROCESS

The BVAD identifies specific physical quantities that define life support systems from an analysis and modeling perspective. For each physical quantity so identified, the BVAD provides a nominal or baseline value and often provides a range of possible or observed values. Finally, the BVAD documents each entry with a description of the quantity's use, value selection rationale, and appropriate references. The baseline values listed in the BVAD are designed to provide defaults for those quantities within each study that are not of particular interest for that study and may be adequately described by default values.

Some life support assumptions are well bounded. For example, the direct solar irradiation for vehicles orbiting around Earth's Moon varies between 1,323 Watts per square meter ( $W/m^2$ ) and 1,414  $W/m^2$  with a mean value of 1,367  $W/m^2$  (K&K, 1998). Accordingly, the solar constant at the Moon naturally varies by 91  $W/m^2$  (6.7%). Williams (1997) lists a mean value of 1,380  $W/m^2$  for the solar constant at the Moon. While any value from 1,323  $W/m^2$  to 1,414  $W/m^2$  may be selected for the solar constant in a study sited in lunar orbit, a mean value of 1,370  $W/m^2$  may be defined in the BVAD as the baseline solar flux at the Moon. Consequently, all life support studies would use a consistent value of 1,370  $W/m^2$  unless they were specifically exploring the effect of varying the solar constant. Many life support assumptions are similarly well bounded. Others, such as the growth rate for plants, are not well bounded. For these types of values, reasonable upper and lower values are given, although other values showing a greater range could be used. Without an agreement, each researcher will generally select his/her baseline values using whatever sources are available and/or deemed most accurate. While values from one researcher to the next may be similar, variations in input values lead to further variations in results when one compares studies from multiple sources. As such, it is more difficult to assess the significance of variations in results between studies from different sources without conducting additional analyses to bring the multiple studies to a similar baseline.

Values for this document are taken from a variety of sources. Many researchers from the modeling and analysis community, in addition to the authors, helped to prepare the manuscript as it evolved over many years. As part of the process of assigning values to each of the life support quantities, the writers evaluated and debated entries to produce a set of mutually agreeable values with corresponding limits. **Comments from all readers are welcomed and encouraged. To allow the BVAD to maintain its utility as a store of modeling and analysis information, the BVAD must be a living document that is updated as necessary to reflect new technology and/or scientific discoveries.**

The BVAD has been developed under the auspices of several NASA life support technology development programs in its history, and is currently maintained by the Design and Analysis Branch of the Crew and Thermal Systems Division at the NASA Johnson Space Center in support of the NASA Environmental Control and Life Support System (ECLSS) community. Please send comments to:

Molly S. Anderson  
CTSD National Aeronautics and Space Administration  
Lyndon B. Johnson Space Center  
2101 NASA Road One  
Mail Code EC2  
Houston, Texas 77058  
E-mail: [molly.s.anderson@nasa.gov](mailto:molly.s.anderson@nasa.gov)

## 1.2 ADVANTAGES

Aside from the advantages listed above, the BVAD provides several additional benefits:

- 1) The BVAD allows the life support analysis community to carefully review and evaluate input study assumptions. Such review will lead to greater confidence in and understanding of the studies' results.
- 2) Each study can now benefit from the “best” available input values and assumptions by drawing upon information collected by a group of researchers instead of a single researcher. Further, such values reflect the combined expertise of the group as a whole rather than one individual.
- 3) The BVAD process identifies those quantities that are not well-defined by current information. Such quantities are primary candidates for parametric studies to determine their importance on modeling and analysis results. Further, this approach identifies values that may require additional experimental input to adequately quantify.
- 4) The BVAD allows researchers from multiple sites to efficiently and quickly compare results from multiple studies. Because each study uses the same baseline, the variations between studies arise from differences in models or the parameters varied rather than a complex combined effect that includes variations in the assumed baseline.
- 5) The BVAD will allow any researcher to conduct a follow-on study or replicate previous work because assumptions from each study will be clearly available and carefully recorded. Further, researchers can reference the BVAD for their baseline parameter values except those that are unique to their specific study.

## 1.3 ACKNOWLEDGEMENTS

Many researchers have contributed information or insights to this document over the years. Thus, the BVAD authors would like to specifically acknowledge the following individuals for their contributions: James E. Alleman, PhD, Susan D. Baggerman, Daniel J. Barta, PhD, Scott Bell, David Bergeron, Charles Bourland, PhD, Cheryl B. Brown, Juan M. Castillo, Robert L. Cataldo, James Cavazzoni, PhD, Joe P. Chambliss, Bruce Conger, Nicholas Coppa, PhD, Katherine R. Daves, Grace Douglas, PhD, Alan E. Drysdale, PhD, Bruce E. Duffield, John W. Fisher, Guy Fogleman, PhD, Steve J. French, PhD, James R. Geffre, Anthony J. Hanford, PhD, Donald L. Henninger, PhD, John A. Hogan, PhD, Jean B. Hunter, PhD, Frank F. Jeng, Harry Jones, PhD, Jitendra Joshi, PhD, John M. Keller, Kevin E. Lange, PhD, Wen-Ching Lee, Julie A. Levri, Sabrina Maxwell, Dean Muirhead, PhD, Seza Orcun, PhD, Michele Perchonok, PhD, Alan T. Perka, Jay L. Perry, Karen D. Pickering, PhD, Luis F. Rodriguez, PhD, Michael Rouen, Kathy Ruminsky, James Russell, PhD, John Sager, PhD, Laura A. Shaw, David A. Vaccari, PhD, Jennifer Villarreal, Yael Vodovotz, PhD, Kanapathipi Wignarajah, PhD, Chantel Whatley, Raymond Wheeler, PhD, Kristina R. Wines, Jannivine Yeh.



## 2 APPROACH

The assumptions here arise from various sources and they are organized into sets of similar data. These assumptions relate to the scenarios, the mission infrastructure, and the various life support subsystems. References are documented where possible to provide traceability.

### 2.1 DEVELOPMENT

The baseline values and assumptions are based on experience in developing models of life support systems. The various contributors to the BVAD have focused on quantitative aspects of their areas of expertise, thus allowing comparison with other life support system models or other scenarios. Upper and lower limits are given as recommended values. In some cases, the upper and lower limits are definite values set by scientific principles, whereas in other cases they are representative values that will not often be exceeded in a real system.

### 2.2 CONTEXT

This document does not assume and is not particular to a specific mission, but does focus on near-term and far-term exploration missions of importance to NASA. In some cases, the data may be applicable to only certain missions. Life support focused reference mission documents (the most recent published by Exploration Life Support in 2008) may be referred to for more details of potential mission scenarios.

### 2.3 LIFE SUPPORT SUBSYSTEMS

A vehicle's life support system is made of several different subsystems performing different functions. Hanford (2000) provides a generic description of life support subsystems as well as subsystem and interface relationships for a life support system. This approach originally mirrored the organization for the Advanced Life Support (ALS) Program (Berry, et al. 1994). This classification initially arose from a Systems Modeling and Analysis Project<sup>1</sup> workshop in the fall of 1999. The Exploration Life Support (ELS) project followed ALS; more recently, life support technology development has been conducted under Next Generation Life Support and Advanced Exploration Systems within NASA. System classification can vary depending on a specific project's work breakdown structure, so a representative grouping commonly used in the NASA life support community has been adopted for this BVAD. Basic descriptions of the subsystems and their interfaces are given in Table 2.1 and in Table 2.2. Information within the BVAD will be organized according to this structure.

As noted above, many formats to describe life support systems exist. Here Air, Waste, and Water are classified as systems or subsystems, while Habitation, Crew,<sup>2</sup> Environmental Monitoring and Control (EMC), Extravehicular Activity (EVA) Support, Food, In-Situ Resource Utilization (ISRU), Power, Propulsion, Radiation Protection, Thermal and Medical Systems are external life support interfaces. The interfaces listed in the last column for each subsystem or interface are generally inclusive, attempting to account for all possible interactions, even if some of those interactions are highly unlikely. Figure: 2.1 provides a graphical depiction of the information in Table 2.2.

Please note that, within this document, subsystem names such as "Air Subsystem" and "Water Subsystem" are proper names. However, the generic terms "system" and "subsystem" are often used interchangeably in the text within this document to refer to similar suites of equipment, depending on the scope of the project or analysis, as systems can be defined at many levels. This relaxed approach with respect to nomenclature reflects the constantly changing perspective that both researchers and analysts use while considering many different technologies or groups of technologies. In reality, most life support equipment is constructed from several lower-level components and also fits within a higher-level assembly. Thus, the terms "system" and "subsystem" vary according to the current discussion and often differ for other studies.

---

<sup>1</sup> Systems Modeling and Analysis Project is the previous name for the Systems Integration, Modeling, and Analysis element.

<sup>2</sup> Though the presence of the crew alone justifies the inclusion of the life support subsystems, the crewmembers are external to the life support equipment and thus are listed as an interface here.

**Table 2.1 Life Support Subsystem Descriptions and Interfaces**

Subsystem	Description	Life Support System Interfaces
Air	The Air Subsystem maintains the vehicle cabin atmospheric pressure and quality. Functional areas include atmospheric gas storage, supply, and air circulation including positive and negative pressure control; carbon dioxide partial pressure control; moisture removal (often in cooperation with a Thermal Interface condensing heat exchanger); trace chemical contaminant control; particulate matter control; resource recovery, storage, and recycling; and supporting infrastructure. The air system often includes many components for emergency scenarios. These emergency systems need to provide similar functions as the nominal systems, but very different technologies may be used for the specific contingency scenarios.	Habitation, Waste, Water, EMC, Crew, EVA Support, ISRU, Power, Thermal, Propulsion
Waste	The Waste Subsystem collects waste products from packaging materials, human wastes, or process wastes. Depending on mission needs, the wastes can be minimally processed to reduce storage size and control odor, can be rendered biologically inactive, or can be recycled into commodities useful for accomplishing mission goals.	Air, Habitation, Water, EMC, Crew, EVA Support, Food, Power, Radiation Protection, Thermal, Propulsion
Water	The Water Subsystem collects wastewater from all possible sources, recovers and transports potable water, and stores and provides that water at the appropriate purity and at the appropriate level of biological activity, for crew and external users, for consumption, hygiene, for use as a process reactant or for meal cleanup and housekeeping.	Air, Habitation, Waste, EMC, Crew, EVA Support, Food, ISRU, Power, Radiation Protection, Thermal, Propulsion

**Table 2.2 Life Support Interfaces Descriptions**

Life Support Interfaces	Description	Life Support System Interfaces
Crew	The Crew Interface interacts with all life support subsystems and interfaces. It accounts for all metabolic inputs and outputs from crewmembers. Historically, and likely in the near-term (until other animals or plants are included in the mission in large scales), crewmembers are the foremost consumers of life support commodities and the primary producers of waste products.	All
Environmental Monitoring and Control	The Environmental Monitoring and Control (EMC) Interface provides information on the chemical and biological status of the crew habitat. This includes trace and major constituent composition of air and water, smoke detection, and microbial content of air, water, and surfaces. The information is used to control proper functioning of the life support system, as well as indicate off-nominal events.	All
Extravehicular Activity Support	The Extravehicular Activity (EVA) Support Interface provides life support consumables including oxygen, water, and food for all suited activities, as well as carbon dioxide and waste removal. Suits may be employed for launch, entry, and abort (in case of cabin depressurization); nominal or contingency EVA in a weightless environment; emergency return from a human mission beyond low-Earth orbit; and surface EVA operations on the Moon and Mars.	Air, Habitation, Waste, Water, EMC, Crew, Food, Power, Thermal
Food	The Food Interface provides the crew with prepackaged food products or commodities requiring some level of preparation or processing, and includes the stowage systems necessary for these items. If an advanced life support system were to include a Biomass Subsystem, the Food System would also receive harvested agricultural products and process them into an edible form.	Air, Habitation, Waste, Water, EMC, Crew, EVA Support, Power
Habitation	The Habitation Interface is responsible for crew accommodations and human engineering. The packaging and preparation and storage of crew supplies includes the galley layout and food supplies, clothing management systems, fire suppressant, gas masks, hygiene stations and supplies, housekeeping and related supplies, and other functions related to configurable crew living. This technology area is responsible for implementing the hardware resulting from human factors requirements.	Air, Waste, Water, EMC, Crew, EVA Support, Food, Power, Radiation Protection, Thermal
In-Situ Resource Utilization	The In-Situ Resource Utilization Interface provides life support commodities such as gases, water and regolith from local planetary materials for use throughout the life support system.	Air, Water, EMC, Crew, Power, Radiation Protection
Medical Systems	Under nominal conditions medical systems would generally have an inconsequential impact on the life support systems, but if an event should occur that causes illness or injury, the impacts on the Life Support System could be drastic. This includes medical and metabolic monitoring of the crew during EVAs. Gases may be required for hyperbaric treatment, respiratory therapy, or to provide oxygen for certain medical procedures while controlling flammability risks in the cabin. Additional water may be required and waste could be generated that might not be allowed to be stored, processed, or recycled like waste from nominal activities.	Air, Water, Waste

Power	The Power Interface provides the necessary energy to support all equipment and functions within the life support system. It may also provide resources like fuel cell product water to the life support system.	All
Propulsion	The Propulsion Interface may provide resources such as oxygen and cooling evaporant to the life support system and thermal control system	Air, Water, EMC, Waste, EVA Support, Thermal
Radiation Protection	The Radiation Protection Interface includes systems design to provide the crew protection from environmental radiation. The life support system could provide some useful contribution to radiation protection, especially in the form of water or waste products. The Radiation Protection Interface also provides sensors and other predictive measures for solar particle events, so the crew might seek shelter from such an event.	Habitation, Waste, Water, Crew, Food, ISRU, Power
Thermal	The Thermal Interface is responsible for maintaining cabin temperature and humidity (unless controlled jointly with other atmosphere revitalization processes) within appropriate bounds and for collection and removal of the collected waste heat from crew, equipment, and the pressurized volume to the external environment. Note: Equipment to remove thermal loads from the cabin atmosphere normally provides sufficient air circulation. Thermal Interface work is conducted under the Thermal Control System Development for Exploration Project.	Air, Habitation, Waste, Water, EMC, Crew, EVA Support, Food, Power

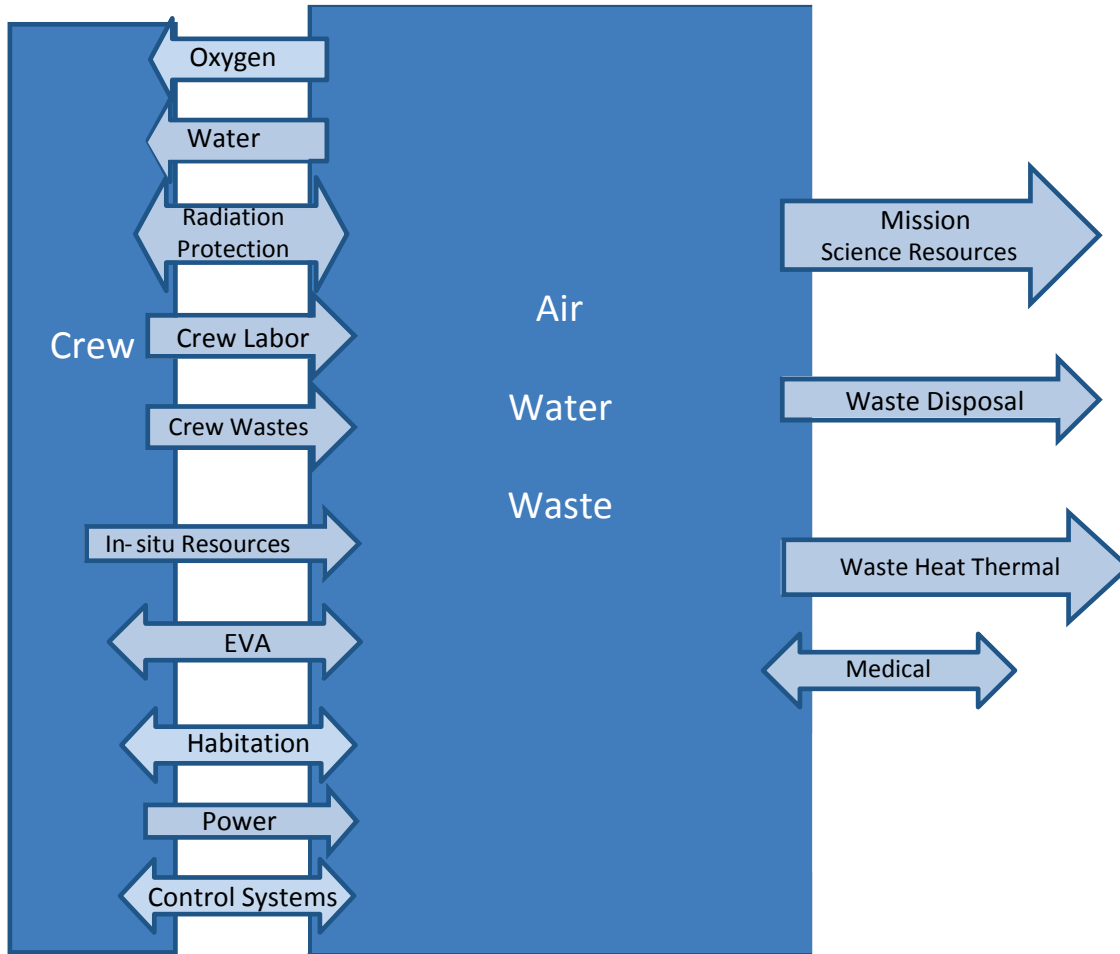

**Figure: 2.1 Life Support System interfaces.**

## 2.4 DEFINITIONS

### 2.4.1 MODELING

Modeling is analogous to a system that mimics the behavior of some real system. Within ELS, mathematical models are used to predict or simulate, control, design, optimize, or facilitate an understanding of a life support system, a component, or a subsystem. Models might be quite simple, a calculation of overall masses, for example, or quite complex, involving gas exchange at molecular levels. This document includes and supports both types of models.

### 2.4.2 INFRASTRUCTURE

Infrastructure is everything necessary to operate the life support equipment that is not otherwise specifically defined elsewhere as a component of the life support system. For an overall life support system analysis, the system includes the life support equipment. Necessary infrastructure, then, may include all necessary supplies and equipment for electrical power generation or a pressurized cabin in which the equipment operates. Some infrastructure, though vital to overall system success, may have a small or negligible impact on a study's

primary focus. For example, data and communications infrastructure generally have little impact on the equivalent system mass of a life support system and can thus be safely neglected in this case.<sup>3</sup> Table 2.1 and Table 2.2 identify the most common and significant interactions between life support subsystems and other spacecraft systems outside of the life support system. Section 3.2 discusses and lists infrastructure cost factors for overall life support system analyses, while Table 2.2 provides additional information about commodity demands to and from the life support interfaces.

### 2.4.3 EQUIVALENT SYSTEM MASS

Although there are many possible ways to assess progress toward goals for the life support system, one of the key parameters used is a metric based on Equivalent System Mass (ESM).

#### 2.4.3.1 EQUIVALENT SYSTEM MASS EXAMPLE

Equivalent system mass (ESM) is a technique by which several physical quantities describing a system or subsystem may be reduced to a single physical parameter.<sup>4</sup> For example, say a power generator solely supplies a water purification system, then the mass required for the water purification system is the mass of the system itself plus the mass increase to the power system. In reality, for a space vehicle, the power system supplies power for several different functions, not just water purification. A power equivalency factor is defined to indicate how much of the total power being generated can be attributed to water purification and how much it supports other needs. This power equivalency factor allows the fraction of the power dedicated to water purification to be separated and grouped with the water purifier.

#### 2.4.3.2 EQUIVALENT SYSTEM MASS DESCRIPTION

Conversion of quantities such as power, volume, thermal load, and crewtime to equivalent masses is accomplished by determining appropriate mass penalties or conversion factors to convert the non-mass physical inputs to an equivalent mass. For systems that require power, the Power Interface can yield an appropriate power-mass penalty by dividing the average power plant output by the total mass of the generating power plant. Thus, for a nuclear power plant on an independent lander that delivers an average of 100 kW<sub>e</sub> of electrical power and has an overall mass of 8,708 kg (Mason, *et al.*, 1992)<sup>5</sup> the power-mass penalty is 87.1 kg/kW-electric W<sub>e</sub>. This power-mass penalty effectively assigns a fraction of the Power Interface mass to a power-using subsystem in place of that subsystem's power requirement. This would include the impact to thermal loads for cooling the power generation and power used to heat the cabin habitability volume. In like manner, mass penalties to account for heat rejection and volume within a pressurized shell are defined. A crewtime mass penalty is also defined below. The definition of equivalent mass for a system is the sum of the equipment and consumable commodity mass plus the power, volume, thermal control, and crewtime requirements converted to mass by using equivalency factors. Please see ESM GD (2003) for additional information on ESM.

### 2.4.4 UNITS AND VALUES

All numerical assumptions are given using the Système Internationale d'Unités (SI). This approach is consistent with NASA Policy Directive 8010.2 D (NPD 8010.2 D, 2004). A list of SI units for physical quantities of interest is provided in the Appendices. Some values are also presented in comparable English units.

Generally, lower, nominal, and upper values are provided. Unless stated otherwise, the numbers are intended to represent average values under nominal conditions for different design cases. Short-term fluctuations are not considered, nor are emergency or contingency situations except as explicitly noted. Values not listed per capita assume a crew of four, unless otherwise stated.

---

<sup>3</sup> While the life support system requires displays, the mass of these items are small relative to the overall system mass.

<sup>4</sup> An ESM evaluation is similar in form to computing a project's net present value in that if future value, interest rate, and/or annuitized value can be converted into present value, then two projects can be compared by like units since all the numbers used have been converted to present value. Thus, ESM is a method for ranking a system or subsystem concept relative to other concepts.

<sup>5</sup> The actual mass quoted here has been adjusted slightly to account for some differences between the work listed in the reference and the desired system.

## 2.5 MISSION DURATION

Duration of space exploration missions with a crew may vary from a few hours up to decades when considering historical experience, and planned and possible mission concepts to explore the Moon, Mars, and beyond. To provide guidance on common mission duration characteristics, Table 2.3 through Table 2.7 provide a series of classifications for mission durations with a corresponding listing, in qualitative terms, of likely approaches for life support functions. Two or more approaches for life support functions may exist because the design ultimately is influenced by numerous architectural decisions and mission constraints. Table 2.3 provides an overall summary, while Table 2.4 through Table 2.7 provides details of life support functions as well as qualitative examples for each function. For an actual flight program, each life support function, as well as the subsystems comprising the vehicle environmental control and life support subsystem, will have detailed functional specifications assigned. Specific requirements, constraints, and trade-offs for the vehicle may result in selecting a life support system for a future mission that is different from these generalized groupings of functions.

Tables such as Table 2.3 through Table 2.7 may be used in many ways. Of primary importance here are the following two uses.

The first use involves the mission designators listed in Table 2.3. The subsystem and interface descriptions associated with each designator bounds, in a qualitative manner, some approaches to process technologies and architecture that NASA might consider to accomplish a mission of the specific duration. While deviations may exist, the descriptors for each designator provide either common shorthand or at least a common starting point to discuss a mission. For example, a researcher may examine a “short” mission using the first option when more than one option is available.

The second use involves using Table 2.4 through Table 2.7 to categorize life support system architecture regardless of the mission duration. In general, “Option 1” is an open-loop approach, relying strongly on single-use systems and supplies from Earth. Option 2 and 3 will begin to add some reusable components and technologies that can regenerate wastes into useful resources. The later options evolve more and more into complex closed-loop systems intended to be sustainable without resupply from Earth, but at the expense of sending a large and complex life support system.

For an overall example starting with the categories in Table 2.3, Project Mercury used “stored commodities (oxygen in tanks) with consumable waste removal hardware (lithium hydroxide cartridges)” for the air subsystem, “launch-entry suit” for the habitation interface, “waste storage only” for the waste subsystem, “stored (water)” for the water subsystem, “stored food only” for the food interface, “rejection with consumables” for the thermal interface, etc. Using Table 2.4, the categorization for Project Mercury might continue by specifying “consumables” for carbon dioxide removal, “stored commodities” for oxygen supply, “none” for carbon dioxide reduction, etc. It should be noted that for another mission concept, individual options might be “physicochemical hardware and regenerable consumables” for carbon dioxide removal, “stored commodities” for oxygen supply, and “none” for carbon dioxide reduction.

**Table 2.3 Overall Description of Mission Duration and Life Support System Functionality**

Designator	Duration	Air Subsystem	Habitation Interface	Waste Subsystem	Water Subsystem	Food External Interface	Thermal External Interface
Opt 1: Very Short	~30 hours	Stored Commodities w/ Consumable Waste Removal Hardware	Launch-Entry Suit w/ Wipes Only	Waste Storage Only; Minimal Restrictions on Inputs	Stored / Consumables	Stored Food Only	Rejection w/ Consumables
Opt 2: Short	~20 days	Stored Commodities w/ Consumable Waste Removal Hardware	Launch-Entry Suit +/- Other Clothing w/ Wipes & Bags for Toilet	Waste Storage Only; Minimal Restrictions on Inputs	Stored / Consumables	Stored Food Only	Non-Consumable Rejection Supplemented by Consumables
		Regenerable Physicochemical Hardware w/ Consumables & Make Up, If Necessary	Pre-Packaged Clothing; Limited Water for Oral Hygiene; Wipes for Body Hygiene; Dedicated Toilet, Semi-private/temporary sleep areas; Smoke Detection and Fire Suppression	Waste Stabilization w/o Water Recovery; Minimal Restrictions on Inputs; Source Separation			
Opt 3: Medium	~20 weeks	Regenerable Physicochemical Hardware w/ Consumables & Make Up, If Necessary	Pre-Packaged Clothing; Limited Water for Oral Hygiene; Wipes for Body Hygiene; Dedicated Toilet, Private Sleep Areas, Temporary Radiation Storm Shelter; Smoke Detection and Fire Suppression	Waste Stabilization w/o Water Recovery; Minimal Restrictions on Inputs; Source Separation. 25% logistics carrier waste reuse	Stored / Consumables	Stored Food Only	Non-Consumable Rejection Supplemented by Consumables
					Recovery / Reuse of Some Waste Water w/ Other Waste Water Stored; Make Up from Stores; Consumables Supplied		Non-Consumable Rejection
Opt 4: Long	~10-20 months	Physicochemical Hardware & Regenerable Consumables w/ Negligible Bioregeneration & In-Situ Oxygen, If Necessary & Available	Limited Clothing Laundry; Water for Oral & Body Hygiene; Dedicated Toilet, Private Sleep Areas, Dedicated Radiation Storm Shelter	Waste Stabilization w/ Water Recovery; Wet Wastes Accepted w/ Others Stored 50% logistics carrier waste reuse. 50% Waste processing residuals used for shielding or converted to methane propulsion for station keeping	Recovery / Reuse of Some or All Waste Water w/ Any Other Waste Water Stored w/o Brine Recovery, If Produced; Consumables Supplied	Stored Food w/ Fresh Vegetable Production Unit	Non-Consumable Rejection Supplemented by Consumables
		Physicochemical Hardware & Regenerable Consumables w/ Minor Bioregeneration & In-Situ Oxygen, f Necessary & Available			Recovery / Reuse of All Waste Water w/ Brine Recovery, If Produced; Consumables Supplied; ISRU Make Up Possible	15 % Bioregeneration w/ Stored Food	Non-Consumable Rejection



**Table 2.3 Overall Description of Mission Duration and Life Support System Functionality (concluded)**

Designator	Duration	Air Subsystem	Habitation Interface	Waste Subsystem	Water Subsystem	Food External Interface	Thermal External Interface
Opt 5: Very Long	~10 years	Physicochemical Hardware & Regenerable Consumables w/ Minor Bioregeneration & In-Situ Oxygen, If Necessary & Available	Clothing Laundry; Free Water for Oral & Body Hygiene; Dedicated Toilet Private Sleep Areas, Dedicated Radiation Storm Shelter	Waste Stabilization w/ Water Recovery; Wet Wastes Accepted w/ Others Stored >75% logistics carrier waste reuse. >75% Waste processing residuals used for shielding. Production of methane (combined with ISRU) or oxygen/water	Recovery / Reuse of All Waste Water w/ Brine Recovery, If Produced; Consumables Supplied; ISRU Make Up Possible	Stored Food w/ Fresh Vegetable Production Unit	Non-Consumable Rejection
		Significant Bioregeneration w/ Physicochemical Hardware & In-Situ or Regenerable Consumables; Wastes Vented or Stored		Reclamation of Life Support Commodities w/ Consumables, Mineralization, & Storage		Recovery / Reuse of All Waste Water w/ Brine Recovery, If Produced; ISRU Make Up & Consumable Manufacture	
Opt 6: Multi-Generational	~2-10 decades	Integrated Bioregeneration w/ In-Situ Commodities for Minimal Losses & Some Hardware Manufacturing	Clothing Laundry; Unlimited Water for Oral & Body Hygiene; Dedicated Toilet	Reclamation of Life Support Commodities w/ Consumables, Mineralization, & Storage	Recovery / Reuse of All Waste Water w/ Brine Recovery, If Produced; ISRU Make Up & Consumable Manufacture	50 % Bioregeneration w/ Stored Food	Non-Consumable Rejection
				Reclamation of Life Support Commodities w/ Mineralization, & Storage w/o Consumables		75 % Bioregeneration w/ Stored Food	
		Integrated Bioregeneration w/ In-Situ Commodities for Minimal Losses & All Hardware Manufacturing	Clothing Laundry; Unlimited Water for Oral & Body Hygiene; Dedicated Toilet; Clothing Manufactured Locally	Reclamation of All Commodities w/ Mineralization w/o Consumables w/o Permanent Storage (No Waste)	Recovery / Reuse of All Waste Water w/ Brine Recovery, If Produced; ISRU Make Up & All Hardware Manufacture	Essentially Complete Bioregeneration w/ Protein from Plant Products	
						Complete Bioregeneration w/ Protein from Animal Products	
Opt 7: "Permanent"	~1 × 10 <sup>9</sup> years	Integrated Bioregeneration w/ In-Situ Commodities for Minimal Losses & All Hardware Manufacturing	Clothing Laundry; Unlimited Water for Oral & Body Hygiene; Dedicated Toilet; Clothing Manufactured Locally	Reclamation of All Commodities w/ Mineralization w/o Consumables w/o Permanent Storage (No Waste)	Recovery / Reuse of All Waste Water w/ Brine Recovery, If Produced; ISRU Make Up & All Hardware Manufacture	Complete Bioregeneration w/ Protein from Animal Products	Non-Consumable Rejection

**Table 2.4      Functionality and Possible Options for the Air Subsystem**

	<b>Air Subsystem</b>	<b>Air Subsystem: Carbon Dioxide Removal</b>	<b>Air Subsystem: Oxygen Supply</b>	<b>Air Subsystem: Carbon Dioxide Reduction</b>	<b>Air Subsystem: Trace Contaminant Control</b>	<b>Air Subsystem: Pressure Control</b>	<b>Air Subsystem: In-Situ Resource Utilization</b>	<b>Air Subsystem: Sparing</b>
<b>Opt 1</b>	Stored Commodities w/ Consumable Waste Removal Hardware	Consumables	Stored Commodities / Consumables	None	None	Stored	None	None
<b>Opt 2</b>	Regenerable Physicochemical Hardware w/ Consumables & Make Up, If Necessary	Physicochemical Hardware & Regenerable Consumables	Physicochemical Hardware & Regenerable Consumables	Physicochemical Hardware & Regenerable Consumables; Waste Gases Vented	Consumables & Venting Wastes, If Necessary	Consumable Chemical Generation or Stored Gases	Provide Oxygen	Logistics Supply
<b>Opt 3</b>	Physicochemical Hardware & Regenerable Consumables w/ Negligible Bioregeneration & In-Situ Oxygen, If Necessary & Available	Physicochemical Hardware & Regenerable Consumables w/ Minor Bioregeneration	Physicochemical Hardware & Regenerable Consumables w/ Minor Bioregeneration	Physicochemical Hardware & Regenerable Consumables; Wastes Vented or Stored	Regenerable Hardware, Venting Wastes, If Necessary, w/o Consumables	Completely Regenerable Generation	Provide Diluent Gas	Logistics Supply w/ Limited Remanufacturing
<b>Opt 4</b>	Physicochemical Hardware & Regenerable Consumables w/ Minor Bioregeneration & In-Situ Oxygen, If Necessary & Available	Significant Bioregeneration w/ Physicochemical Hardware & Regenerable Consumables	Significant Bioregeneration w/ Physicochemical Hardware & Regenerable Consumables	Physicochemical Hardware & Regenerable Consumables; Wastes Vented or Stored; Minor Bioregeneration	Regenerable Hardware w/o Losses or Consumables	Use Local Materials	Provide Oxygen & Diluent Gas	Local Manufacturing; In-Situ Resource Feedstock

**Table 2.4 Functionality and Possible Options for the Air Subsystem (concluded)**

	<b>Air Subsystem</b>	<b>Air Subsystem: Carbon Dioxide Removal</b>	<b>Air Subsystem: Oxygen Supply</b>	<b>Air Subsystem: Carbon Dioxide Reduction</b>	<b>Air Subsystem: Trace Contaminant Control</b>	<b>Air Subsystem: Pressure Control</b>	<b>Air Subsystem: In-Situ Resource Utilization</b>	<b>Air Subsystem: Sparing</b>
<b>Opt 5</b>	Significant Bioregeneration w/ Physicochemical Hardware & In-Situ or Regenerable Consumables; Wastes Vented or Stored	Integrated Regeneration; Bioregenerative w/ > 50 % Food Closure; Consumables Produced In-Situ	Integrated Regeneration; Bioregenerative w/ > 50 % Food Closure; Consumables Produced In-Situ	Significant Bioregeneration w/ Physicochemical Hardware & Regenerable Consumables; Wastes Vented or Stored	Regenerable Hardware w/o Losses; Local Spares Manufacturing		Provide Oxygen, Diluent Gas, & Other Consumables	Local Manufacturing of All Equipment; In-Situ Resource Feedstock
<b>Opt 6</b>	Integrated Bioregeneration w/ In-Situ Commodities for Minimal Losses & Some Hardware Manufacturing	Integrated Regeneration; Bioregenerative w/ > 75 % Food Closure; Any Spares & Consumables Produced In-Situ	Integrated Regeneration; Bioregenerative w/ > 75 % Food Closure; Any Spares & Consumables Produced In-Situ	Integrated Regeneration; Bioregenerative w/ > 50 % Food Closure; Consumables Produced In-Situ			Provide All Required Consumables	None; No Spares Needed (Fully Reliable w/o Spares)
<b>Opt 7</b>	Integrated Bioregeneration w/ In-Situ Commodities for Minimal Losses & All Hardware Manufacturing			Integrated Regeneration; Bioregenerative w/ > 75 % Food Closure; Any Spares & Consumables Produced In-Situ			Provide All Required Consumables & Spares	

**Table 2.5      Functionality and Possible Options for the Habitation Interface**

	<b>Habitation Interface</b>	<b>Habitation Interface: Metabolic Waste Collection</b>	<b>Habitation Interface: Oral &amp; Body Hygiene</b>	<b>Habitation Interface: Clothing</b>	<b>Habitation Interface: Sparing</b>
<b>Opt 1</b>	Launch-Entry Suit w/ Wipes Only	MAGs or UCDS	None or Wipes	Launch-Entry Suit Only	None
<b>Opt 2</b>	Launch-Entry Suit +/- Other Clothing w/ Wipes & Bags for Toilet	MAGs or UCDS, Apollo Bags / No Dedicated Hardware	Wipes w/ Limited Water for Oral Hygiene; Toothpaste Restrictions	Launch-Entry Suit w/ Pre-Packaged Clothing	Logistics Supply
<b>Opt 3</b>	Pre-Packaged Clothing; Limited Water for Oral Hygiene; Wipes for Body Hygiene; Dedicated Toilet	Dedicated Toilet w/ Consumables	Limited Water for Oral & Body Hygiene; Cleanser Restrictions	Launch-Entry Suit w/ Pre-Packaged Clothing	Logistics Supply w/ Limited Remanufacturing
<b>Opt 4</b>	Pre-Packaged Clothing; Limited Water for Oral & Body Hygiene; Dedicated Toilet	Dedicated Toilet w/o Consumables or Regenerable Consumables	Free Water for Oral & Body Hygiene; Cleanser Restrictions	Aqueous Laundry w/ Consumable Cleaning Agent; Launch-Entry Suit w/ Pre-Packaged Clothing	Local Manufacturing; In-Situ Resource Feedstock
<b>Opt 5</b>	Clothing Laundry; Unlimited Water for Oral & Body Hygiene; Dedicated Toilet	Toilet & Associated Supplies Manufactured Locally	Free Water for Oral & Body Hygiene; No Cleanser Restrictions	Aqueous Laundry w/ Regenerable Cleaning Agent; Launch-Entry Suit	Local Manufacturing of All Equipment; In-Situ Resource Feedstock
<b>Opt 6</b>	Clothing Laundry; Unlimited Water for Oral & Body Hygiene; Dedicated Toilet; Clothing Manufactured Locally			Clothing Manufactured Locally	None; No Spares Needed (Fully Reliable w/o Spares)

**Table 2.6 Functionality and Possible Options for the Waste Subsystem**

	Waste Subsystem	Waste Subsystem: Input Trash Model	Waste Subsystem: Volume Reduction	Waste Subsystem: Stabilization / Making Safe	Waste Subsystem: Containment	Waste Subsystem: Resource Recovery	Waste Subsystem: Sparing
Opt 1	Waste Storage Only; Minimal Restrictions on Inputs	Trash, including Expended Clothing & Crew Metabolic Wastes w/o Source Separation	None / Manual / "Footballs"	None	Storage in Vehicle	None	None
Opt 2	Waste Stabilization w/o Water Recovery; Minimal Restrictions on Inputs; Source Separation	Trash, including Expended Clothing & Crew Metabolic Wastes w/ Source Separation	Physical Compaction	Chemical Stabilization (Consumables)	Storage w/ Odor Control; Limited Duration in Vehicle	Water Only	Logistics Supply
Opt 3	Waste Stabilization w/ Water Recovery; Wet Wastes Accepted w/ Others Stored	Trash, Clothing, Crew Metabolic Wastes & Inedible Biomass w/ Source Separation	Melt Compaction	Moisture Removal (Dewatering / Freeze-Drying) w/o Encapsulation	Storage w/ Odor Control; Unlimited Duration in Vehicle	Water & Minerals; < 50 % Food Closure w/ Biomass Production	Logistics Supply w/ Limited Remanufacturing
Opt 4	Reclamation of Life Support Commodities w/ Consumables, Mineralization, & Storage	Trash, Clothing, Crew Metabolic Wastes & Inedible Biomass w/o Source Separation	Partial Mineralization w/ Melt Compaction	Moisture Removal (Dewatering / Freeze-Drying) w/ Encapsulation	Storage w/ Odor Control & Stabilization; Unlimited Duration Outside Vehicle	Water, Minerals, & Some Carbon Dioxide; ≥ 50 % Food Closure w/ Biomass Production	Local Manufacturing; In-Situ Resource Feedstock
Opt 5	Reclamation of Life Support Commodities w/ Mineralization, & Storage w/o Consumables	Trash, Clothing, Crew Metabolic Wastes & Inedible Biomass w/o Source Separation; Expended Hardware w/ Source Separation	Complete Mineralization or Other Complete Volume Reduction	Partial or Complete Mineralization	None; Essentially Complete Reutilization	Water, Minerals, & Full Carbon Dioxide	Local Manufacturing of All Equipment; In-Situ Resource Feedstock
Opt 6	Reclamation of All Commodities w/ Mineralization w/o Consumables w/o Permanent Storage (No Waste)					Water, Minerals, Carbon Dioxide, Paper, Plastics, Organic Feedstocks for Food & Other Materials	None; No Spares Needed (Fully Reliable w/o Spares)

**Table 2.7      Functionality and Possible Options for the Water Subsystem**

	<b>Water Subsystem</b>	<b>Water Subsystem: Removal of Organic Compounds</b>	<b>Water Subsystem: Removal of Inorganic Compounds</b>	<b>Water Subsystem: Removal of Particulates</b>	<b>Water Subsystem: Removal of Microbial Organisms</b>	<b>Water Subsystem: Polishing</b>
<b>Opt 1</b>	Stored / Consumables	None / n/a	None / n/a	None / n/a	None / Removable / Consumable Biocide at Launch	None / n/a
<b>Opt 2</b>	Recovery / Reuse of Some Waste Water w/ Other Waste Water Stored; Make Up from Stores; Consumables Supplied	Regenerative Technology w/ Consumables w/o Brine Recovery; If Produced	Regenerative Technology w/ Consumables w/o Brine Recovery; If Produced	Filtration; Consumable Technology	Locally-Produced / Regenerable, Low-Toxicity Biocide	Polishing w/ Consumables
<b>Opt 3</b>	Recovery / Reuse of Some or All Waste Water w/ Any Other Waste Water Stored w/o Brine Recovery, If Produced; Consumables Supplied	Regenerative Technology w/ Consumables & Brine Recovery; If Produced	Regenerative Technology w/ Consumables & Brine Recovery; If Produced	Regenerable Filtration or Other Regenerable Technology	Filtration; Consumable Technology	Polishing w/ Regenerable Technology
<b>Opt 4</b>	Recovery / Reuse of All Waste Water w/ Brine Recovery, If Produced; Consumables Supplied; ISRU Make Up Possible	Regenerative Technology w/ Brine Recovery; If Produced; w/o Consumables or Consumables Produced In-Situ	Regenerative Technology w/ Brine Recovery; If Produced; w/o Consumables or Consumables Produced In-Situ		Regenerable Filtration or Other Regenerable Technology	
<b>Opt 5</b>	Recovery / Reuse of All Waste Water w/ Brine Recovery, If Produced; ISRU Make Up & Consumable Manufacture					
<b>Opt 6</b>	Recovery / Reuse of All Waste Water w/ Brine Recovery, If Produced; ISRU Make Up & All Hardware Manufacture					

**Table 2.7      Functionality and Possible Options for the Water Subsystem (concluded)**

	<b>Water Subsystem: Water Supply</b>	<b>Water Subsystem: Wastewater</b>	<b>Water Subsystem: Condensate</b>	<b>Water Subsystem: In-Situ Resource Utilization</b>	<b>Water Subsystem: Sparing</b>
<b>Opt 1</b>	Stored	Stored or Vented / No Recovery	Stored or Vented / No Recovery	None	None
<b>Opt 2</b>	Water from Other Vehicle Processes or In-Situ Sources	Used w/ Minimal Purification	Used w/ Minimal Purification	Provide Water OR Provide Other Consumable Agents	Logistics Supply
<b>Opt 3</b>		Purified to Potable Standards	Purified to Potable Standards	Provide Water & Other Agents (H2SO4, etc.)	Logistics Supply w/ Limited Remanufacturing
<b>Opt 4</b>					Local Manufacturing; In-Situ Resource Feedstock
<b>Opt 5</b>					Local Manufacturing of All Equipment; In-Situ Resource Feedstock
<b>Opt 6</b>					None; No Spares Needed (Fully Reliable w/o Spares)

## 2.6 APPLICABLE DOCUMENTS

The BVAD is intended to provide values for analysis and modeling tasks to study human space flight, and not to design a specific mission, vehicle or technology. Analysis and modeling is charged with examining both off-nominal and diverse technology options. As a result, many studies may consider situations that differ from the accepted bounds listed in the various documents containing requirements. However, when applicable, the BVAD is intended to capture the individual extremes for inputs that are appropriate for human space flight. Further, while the nominal values throughout this document should be consistent with one another, off-nominal values may not be consistent with other values within this document. Thus, the user should independently verify the validity of using off-nominal values.

As noted, the BVAD attempts to provide inputs for all quantities of importance for studies associated with life support systems. However, as research constantly changes, many studies will require inputs for quantities not listed here. In such situations, analysts should use whatever values are appropriate and available and so note and reference those values in their reports or documentation. Further, analysts are asked to report such omissions to the document editors and provide whatever information could be used to determine values for such omitted quantities.

The life support community has used other documents in parallel with the BVAD to document requirements or assumptions for specific missions, tailored specifically for life support system relevant content. The two most recent versions of the documents are listed below. For the reference missions document especially, previous editions of the document are not necessarily wrong, but rather describe different kinds of missions that NASA has considered at one time.

ELS RD (2008) “Exploration Life Support Requirements Document”, National Aeronautics and Space Administration, Lyndon B. Johnson Space Center, Houston, Texas.

RMD (2008) “Advanced Life Support Systems Integration, Modeling, and Analysis Reference Missions Document,” JSC-64109, Revision A, Duffield, BE Editor, National Aeronautics and Space Administration, Lyndon B. Johnson Space Center, Houston, Texas, November.

Parameters that are non-negotiable, for whatever reason, were documented within the ELS RD (2008). Some of the assumptions documented here may in time become requirements while others will be uncertain until the National Aeronautics and Space Administration (NASA) embarks on a specific mission. Some possible future missions are documented in the RMD (2008). These documents can be used as companions to the BVAD to develop consistent mission scenarios for life support system concepts.

## 3 OVERALL ASSUMPTIONS

### 3.1 MISSIONS

The mission affects analyses and models by changing the weighting of the various pieces of the system in terms of time dependent items, equipment design, and infrastructure cost. It can also require different contingency planning for a mission with a short-term abort option (e.g., low-Earth orbit or lunar missions) versus one without such an option (e.g., Martian missions).



### **3.1.1 TYPICAL VALUES FOR EXPLORATION MISSIONS**

Many of the missions supported here are outlined in the Exploration Life Support Reference Missions Document (RMD, 2008). Assumptions are given in Table 3.1 for mission parameters associated with missions described within the RMD (2008).

The given volume assumptions in Table 3.1 describe unobstructed or free volume per crewmember<sup>6</sup> and are specified in terms of “tolerable,” “performance,” and “optimal” for the listed mission segment. For purposes here, performance should be viewed as nominal. The underlying lunar mission is taken from RMD (2008), which is based on the long-duration Lunar Outpost mission outlined in the Exploration Systems Architecture Study (ESAS) (2005), Rudisill (2008), and Lunar Architecture Team Phase 2 (LAT2) (2007) study. For either Moon or Mars missions, the duration values represent the complete time the crew occupies the indicated vehicle. Thus, for a transit vehicle, this is the sum for both the outbound and return trips. As a final note, each mission’s architectural configuration may send more than one crewmember in sequence to use a specific surface habitat. The values in Table 3.1 represent durations for just a single crewmember’s visit to a surface habitat.

Power levels in a spacecraft or habitat depend, of course, on its size and functions. Some minimum or “keep alive” level of power will be required in any human mission to assure crew survival and higher levels will be required for comfort and mission objectives. Table 3.2 contains representative power requirements by system for the International Space Station (ISS) (Pritchett, 2014). The data are nominal stage operations with no robotic or EVA operation being performed. No Visiting Vehicles are attached and values are the average power for each system over a 1-day period at the output of the direct current (DC) to DC Conversion Units. The data are for 0 degree solar beta angle, and the power for some systems will vary with solar beta angle.

---

<sup>6</sup> These values are also called net habitable volume, which is the remaining pressurized cabin volume after accounting for losses due to equipment, stowage, trash, and other items that decrease volume (personal communication with S. Ramsey, 2002).

**Table 3.1 Mission Assumptions**

		Assumptions		
Parameter	Units	lower	nominal	upper
Crew Size	CM	4 <sup>(1)</sup>	4 <sup>(1)</sup>	6 <sup>(1, 2)</sup>
<b>Destination: Moon</b>				
<i>Volume:</i> <sup>7</sup>		<i>Tolerable</i>	<i>Performance</i>	<i>Optimal</i>
Transit Vehicle <sup>8</sup>	m <sup>3</sup> /CM	2.76	3.54 <sup>(3)</sup>	4.25 <sup>(3)</sup>
Crew Lander <sup>9</sup>	m <sup>3</sup> /CM	1.27 <sup>(3)</sup>	3.54 <sup>(3)</sup>	4.39 <sup>(3)</sup>
Surface Habitat <sup>10</sup>	m <sup>3</sup> /CM	4.8 <sup>11(5)</sup>	37 <sup>12(5)</sup>	39-50 <sup>13(5)</sup>
<i>Duration:</i> <sup>14</sup>		<i>Minimum</i>	<i>Nominal</i>	<i>Maximum</i>
Transit Vehicle <sup>8</sup>	d	12 <sup>(4)</sup>	18	21.1
Crew Lander <sup>9</sup>	d	5 <sup>(4)</sup>	7	8 <sup>(4)</sup>
Surface Habitat <sup>10</sup>	d	8 <sup>(4)</sup>	210	210 <sup>(4)</sup>
<b>Destination: Mars</b>				
<i>Volume:</i> <sup>7</sup>		<i>Tolerable</i>	<i>Performance</i>	<i>Optimal</i>
Transit Vehicle <sup>15</sup>	m <sup>3</sup> /CM	5.10 <sup>(3)</sup>	9.91 <sup>(3)</sup>	18.41 <sup>(3)</sup>
Crew Lander <sup>16</sup> , 7 days	m <sup>3</sup> /CM	1.13 <sup>(3)</sup>	3.54 <sup>(3)</sup>	4.25 <sup>(3)</sup>
Crew Lander <sup>16</sup> , 30 days	m <sup>3</sup> /CM	2.27 <sup>(3)</sup>	4.25 <sup>(3)</sup>	10.62 <sup>(3)</sup>
Surface Habitat <sup>17</sup>	m <sup>3</sup> /CM	5.10 <sup>(3)</sup>	9.91 <sup>(3)</sup>	18.41 <sup>(3)</sup>
<i>Duration:</i> <sup>14</sup>		<i>Minimum</i>	<i>Nominal</i>	<i>Maximum</i>
Transit Vehicle <sup>15</sup>	d	220 <sup>(2)</sup>	360 <sup>(2)</sup>	360 <sup>(2)</sup>
Crew Lander <sup>16</sup>	d	7 <sup>(2)</sup>	7 <sup>(2)</sup>	30 <sup>(2)</sup>
Surface Habitat <sup>17</sup>	d	540 <sup>(2)</sup>	600 <sup>(2)</sup>	619 <sup>(2)</sup>

**For additional information refer to:**

- (1) ESAS (2005)
- (2) Hoffman & Kaplan (1997)
- (3) Personal communication with S. Ramsey in 2002
- (4) ESAS (2005)
- (5) LAT2 (2007)

<sup>7</sup> The volume here specifically is unobstructed or free volume within the crew cabin.  
<sup>8</sup> In ESAS (2005) and/or RMD (2008), this vehicle is the “Crew Exploration Vehicle.”  
<sup>9</sup> In ESAS (2005) and/or RMD (2008), this vehicle is the “Lunar Surface Access Module.”  
<sup>10</sup> In ESAS (2005) and/or RMD (2008), this vehicle is the “Lunar Outpost.”  
<sup>11</sup> LAT2 mobile-hab design  
<sup>12</sup> LAT2 mini-hab design  
<sup>13</sup> LAT2 monolithic-hab design  
<sup>14</sup> This mission would have an immediate abort-to-orbit option, although not necessarily an immediate return option. Values represent total time the vehicle is occupied by the crew throughout the mission.  
<sup>15</sup> In Hoffman and Kaplan (1997) and/or RMD (2001), this vehicle is the “Mars Transit Vehicle.”  
<sup>16</sup> In Hoffman and Kaplan (1997) and/or RMD (2001), this vehicle is the “Mars Descent / Ascent Lander.”  
<sup>17</sup> In Hoffman and Kaplan (1997) and/or RMD (2001), this vehicle is the “Surface Habitat Lander.”

**Table 3.2 Typical System Power Requirements based on ISS**

System	Avg. Power (kW)
C&DH	4.08
CHECS	0.11
CTS	2.90
ECLSS	5.31
EPS	2.02
ESA	2.04
EVA	0.00
FCES	1.07
FGB	1.80
GN&C	0.62
JEM	5.35
MECH	0.19
MLM	0.00
MPLM	0.56
MSS	1.20
PAYLOAD	up to 30
SM	3.64
STRUC	0.00
TCS	8.72

### **3.1.2 ASTEROID MISSIONS**

One of NASA's tentative plans for human exploration is to robotically capture and then redirect a small asteroid into a stable lunar orbit, where astronauts can safely visit and study it. This mission is expected to be accomplished with the Orion exploration vehicle with portable life support system (PLSS)-based EVAs conducted from Orion. Other supporting elements could be added to enhance mission capabilities later (Gates 2014, NASA website 2014). The vehicle assumptions for human exploration are not unique for this mission, but use the expected capabilities of the Orion vehicle.

## **3.2 INFRASTRUCTURE COSTS AND EQUIVALENCIES**

Infrastructure "costs" (e.g., mass, volume, power, thermal control, and crewtime), are key factors in overall system analysis. They effectively apportion a fraction of the infrastructure mass to each component of the life support system (see section 2.2). Appropriate infrastructure "costs" and equivalencies for two possible near-term exploration objectives, the Moon and Mars, are provided in Table 3.3 and Table 3.4. The listed penalties for volume account for primary structure only, including micrometeoroid and orbital debris protection and radiation protection for the crew, if necessary. Table 3.10 provides information on secondary structure, including the racks and conditioned volumes such as refrigerated spaces. The nominal values listed in Table 3.3 and Table 3.4 correspond to current technologies with few improvements or synergistic advantages. Less conservative values, with comments on applicability, are presented in Table 3.6, Table 3.14, and Table 3.17.

Infrastructure "costs" vary according to the external mission environment, the technologies used, the mission duration, and sometimes other factors. For example, a power system using solar photovoltaic generation to provide electrical power for a transit vehicle has different energy storage requirements than a comparable system with the same architecture for an equatorial lunar base. Likewise, the thermal environment of interplanetary space differs from the thermal environment of the lunar or Martian surface. The tables here include values for surface locales indicative of equatorial sites. Studies at polar sites should use very different values, especially for thermal control (see RMD [2008] for polar site values).

Table 3.3 and Table 3.4 provide two volume cost factors. The first entry, for shielded volume, reflects pressurized primary structure with sufficient radiation protection to provide a safe environment for the crew. The second entry, for unshielded volume, models pressurized primary structure without any radiation protection other than what the pressure shell may provide. The crew will spend limited time within pressurized volume without radiation protection. Thus, the former value applies to technologies and equipment that are susceptible to environmental radiation or require significant crew interaction whereas the latter may be used for technologies and equipment that are insensitive to interplanetary radiation and require little crew interaction. The fourth entry is for thermal control. These values are combined here for convenience.

**Table 3.3 Long-Duration Lunar Mission Infrastructure “Costs”**

Parameter	Units	Assumptions		
		lower	nominal	upper
<b>Transit</b>				
Shielded Volume	kg/m <sup>3</sup>		80.8 <sup>(1)</sup>	
Unshielded Volume	kg/m <sup>3</sup>		45.2 <sup>(1)</sup>	
Power	kg/kW		136 <sup>(2)</sup>	
Thermal Control	kg/kW	55 <sup>(3)</sup>	65 <sup>(3)</sup>	65 <sup>(3)</sup>
Crewtime <sup>18</sup>	kg/CM-h	6.09 <sup>(4)</sup>	6.09 <sup>(4)</sup>	7.42 <sup>(4)</sup>
<b>Surface</b>				
Shielded Volume	kg/m <sup>3</sup>	102.0 <sup>(1)</sup>	133.1 <sup>(1)</sup>	137.3 <sup>(1)</sup>
Unshielded Volume	kg/m <sup>3</sup>		9.16 <sup>(1)</sup>	13.40 <sup>(1)</sup>
Power	kg/kW	29 <sup>(2)</sup>	76 <sup>(2)</sup>	749 <sup>(2)</sup>
Thermal Control	kg/kW	97 <sup>(3)</sup>	102 <sup>(3)</sup>	246 <sup>(3)</sup>
Crewtime <sup>18</sup>	kg/CM-h	1.50 <sup>(4)</sup>	1.50 <sup>(4)</sup>	2.14 <sup>(4)</sup>

**For more information:**

- <sup>(1)</sup> See Table 3.6
- <sup>(2)</sup> See Table 3.14
- <sup>(3)</sup> See Table 3.17
- <sup>(4)</sup> See Table 3.25

**Table 3.4 Mars Mission Infrastructure “Costs”**

Parameter	Units	Assumptions		
		lower	nominal	upper
<b>Transit</b>				
Shielded Volume	kg/m <sup>3</sup>		215.5 <sup>(1)</sup>	219.7 <sup>(1)</sup>
Unshielded Volume	kg/m <sup>3</sup>		9.16 <sup>(1)</sup>	13.40 <sup>(1)</sup>
Power	kg/kW	10 <sup>(2)</sup>	23 <sup>(2)</sup>	n/a
Thermal Control	kg/kW		60 <sup>(3)</sup>	70 <sup>(3)</sup>
Crewtime <sup>18</sup>	kg/CM-h	0.565 <sup>(4)</sup>	0.565 <sup>(4)</sup>	0.728 <sup>(4)</sup>
<b>Surface</b>				
Shielded Volume	kg/m <sup>3</sup>		215.5 <sup>(1)</sup>	219.7 <sup>(1)</sup>
Unshielded Volume	kg/m <sup>3</sup>		9.16 <sup>(1)</sup>	13.40 <sup>(1)</sup>
Power	kg/kW	54 <sup>(2)</sup>	87 <sup>(2)</sup>	338 <sup>(2)</sup>
Thermal Control	kg/kW		146 <sup>(3)</sup>	170 <sup>(3)</sup>
Crewtime <sup>18</sup>	kg/CM-h	0.465 <sup>(4)</sup>	0.465 <sup>(4)</sup>	0.957 <sup>(4)</sup>

**References**

- <sup>(1)</sup> See Table 3.6
- <sup>(2)</sup> See Table 3.14
- <sup>(3)</sup> See Table 3.17
- <sup>(4)</sup> See Table 3.25

**3.2.1 INFRASTRUCTURE COSTS BASED UPON THE EXPLORATION SYSTEMS ARCHITECTURE STUDY**

ESAS (2005) and subsequent Constellation Program (CxP) documentation presented fairly detailed descriptions of concepts for a return to the Moon, discussing both a shorter-duration Lunar Sortie and a longer-duration Lunar Outpost. Even though the CxP was discontinued, these studies may be useful for planning future space exploration missions. While the Lunar Sortie approach is nearer-term, the Lunar Outpost is more likely to use regenerative life support technologies. RMD (2008) outlines a possible implementation for a Lunar Outpost based upon the documents listed in 3.2.1. The values in Table 3.19 at the end of section 3.2, taken from the RMD (2008),

<sup>18</sup> These crewtime values originate from calculations supporting Metric (2006), which assumes different values than those listed for other elements of the infrastructure. However, the values here are of the same order of magnitude so that the crewtime values are of the correct order of magnitude. To be rigorous, crewtime infrastructure values should be computed based upon both the other infrastructure values assumed and the actual life support system configuration. However, when such information is not available, the values here may be used as approximations.

reflect a Lunar Outpost mission.<sup>19</sup> Please note that without reference to the RMD (2008), Table 3.19 is incomplete and the reader is encouraged to consult the original source for a broader understanding. However, for those familiar with the RMD (2008), a brief explanation may suffice. According to ESAS (2005), the Crew Exploration Vehicle (CEV) primarily uses solar photovoltaic cells for power generation; however, after separation of the Command Module (capsule) from the Service Module, all power is provided by batteries. Further, according to ESAS (2005), the Lunar Surface Access Module uses hydrogen-oxygen fuel cells located on the Descent Stage for primary power generation, so the appropriate power-mass penalty has a fixed contribution from the fuel-cell hardware, 166.2 kg/kW<sub>e</sub>, and a time-dependent contribution from the reactants consumed, 0.528 kg/kW<sub>e</sub>h. Following separation of the Ascent Stage from the Descent Stage, all power aboard the Lunar Surface Access Module is provided by batteries. The thermal control infrastructure penalties are similar in that the time-independent values of those recommended for life support correspond to radiant rejection before module or stage separation, while the time-dependent components correspond to rejection using consumables after module or stage separation.<sup>20</sup> Because many life support systems function during all mission phases, both the time-independent and time-dependent thermal control penalties apply.<sup>21</sup> Finally, because this mission, as outlined in RMD (2008), must have precise definition for “crewtime” to be calculated, no corresponding values are given for “crewtime”.<sup>22</sup>

**Table 3.5 Lunar Outpost Mission Infrastructure “Costs”**

Parameter	Units	Crew Exploration Vehicle	Lunar Surface Access Module	Lunar Outpost
<b>Power</b>				
Power-Mass Penalty	kg/kW <sub>e</sub>	125.9	166.2	274.1 <sup>23</sup>
Energy-Mass Penalty, Batteries	kg/kW <sub>e</sub> h	13.0	12.3	undefined
Energy-Mass Penalty, Reactants	kg/kW <sub>e</sub> h	n/a	0.528	undefined
<b>Thermal Control</b>				
Acquired by Cabin Heat Exchangers & Coldplates	kg/kW <sub>th</sub>	60.11	59.1	--
Thermal Transport	kg/kW <sub>th</sub>	25.9	15.8	--
Rejection by Radiators	kg/kW <sub>th</sub>	12.2	8.5	--
Rejection by Consumables	kg/kW <sub>th</sub> h	10.7	6.7	--
Recommended Values for Life Support Analyses <sup>24</sup>	kg/kW <sub>th</sub>	50.0	33.1	31.6 <sup>25</sup>
	kg/kW <sub>th</sub> h	10.7	6.7	--
<b>Vehicle Structure</b>				
Volume	kg/m <sup>3</sup>	133.8	61.7	100.0

### 3.2.2 PRESSURIZED VOLUME OR PRIMARY STRUCTURE COSTS

Pressurized volume houses the crew and crew-accessible systems. Characteristic volume “costs” are presented in Table 3.6. The ISS common module currently provides pressurized volume in low-Earth orbit. An inflatable module could be used as an alternative. In both cases, the lower value corresponds to primary structure with protection from micrometeoroids and orbital debris. The upper value, if known, also includes some dedicated radiation protection.

<sup>19</sup> Some values in Table 3.5 may also apply to a Lunar Sortie mission.

<sup>20</sup> Both the Crew Exploration Vehicle and the Lunar Surface Access Module may use consumables to supplement rejection before separation during particularly hot mission segments, so this direction is an approximation.

<sup>21</sup> Alternately, only the time-independent thermal control penalty applies for life support hardware that is not used following vehicle separation.

<sup>22</sup> Values from Table 3.25 for the Moon are good approximations in the absence of customized values.

<sup>23</sup> Solar power generation with regenerable fuel cells and cryogenic reactants for energy storage (ESAS, 2005). This value assumes a South-Pole site on the North Rim of Shackleton Crater.

<sup>24</sup> See RMD (2008) for underlying assumptions and details.

<sup>25</sup> For a South Polar site on the North Rim of Shackleton Crater with horizontal radiators with a power-mass penalty of 274.1 kg/kW<sub>e</sub>.

The aerodynamic crew capsule in Table 3.6 is based on an ellipse sled and designed to aero-capture in the upper atmosphere upon returning to Earth (NASA, 2001a). The second entry reflects the crew cabin structure without radiation shielding whereas the first entry reflects the crew cabin with sufficient radiation shielding for a lunar transit mission. Nominally, according to concepts within NASA (2001a), crew vehicles for near-term lunar missions will aero-capture upon returning to Earth, so the nominal values here include thermal protection for aerodynamic heating.

**Table 3.6 Cost of Pressurized Volume**

Technology/Approach	Assumptions [kg/m <sup>3</sup> ]		
	lower	nominal	upper
<b>Low-Earth Orbit</b>			
ISS Module (shell only)	42.9 <sup>(5)</sup>	66.7 <sup>(1)</sup>	
Inflatable Module	19.61 <sup>(2)</sup>	28.1 <sup>(2)</sup>	32.4 <sup>(2)</sup>
<b>Lunar Mission – Transit</b>			
Shielded Aerodynamic Crew Capsule (Ellipse Sled)		80.8 <sup>(3)</sup>	
Unshielded Aerodynamic Crew Capsule (Ellipse Sled)		45.2 <sup>(3)</sup>	
<b>Lunar Mission – Surface</b>			
Shielded Inflatable Module	102.0 <sup>(4) 26</sup>	133.1 <sup>(4) 26</sup>	137.3 <sup>(4) 27</sup>
Unshielded Inflatable Module		9.16 <sup>(2) 28</sup>	13.40 <sup>(2) 28</sup>
<b>Martian Mission – Surface <sup>29</sup></b>			
Shielded Inflatable Module <sup>30</sup>		215.5 <sup>(4) 26</sup>	219.7 <sup>(4) 27</sup>
Unshielded Inflatable Module		9.16 <sup>(2) 28</sup>	13.40 <sup>(2) 28</sup>

**For more information, refer to:**

- <sup>(1)</sup> Hanford (1997)
- <sup>(2)</sup> See Table 3.8
- <sup>(3)</sup> NASA (2001a)
- <sup>(4)</sup> See Table 3.9.
- <sup>(5)</sup> From James Russell, Lockheed

The cost factors listed for inflatable modules, for both the lunar and Martian missions, assume surface sites. The unshielded value reflects just the primary structure without any radiation protection, presuming that some “to be determined” in-situ resources, such as regolith, a natural cavern, or local atmosphere, will provide the necessary radiation protection. The nominal shielded value assumes sufficient radiation protection for the location assuming the surface locale provides no beneficial protection against radiation, whereas the upper value for shielded volume also includes avionics and power management and distribution masses. Often, however, this last cost is associated with the Power Interface and, therefore, should not also be assessed against the structure mass.

In recent studies, transit vehicles for Martian missions are generally larger than corresponding vehicles for lunar missions, so the volume-mass penalties for surface applications are suitable for transit applications. In fact, the radiation protection values for the Martian missions are sized assuming a crew is present during transfer to Mars. Because Mars itself will provide some shielding, the transfer segment is the most severe environment and provides the criteria for sizing radiation protection.

The appropriate volume cost factor generally depends on the sensitivity of specific equipment to the external environment or whether the crew must regularly interact with the equipment. As noted above, in radiation

<sup>26</sup> Estimate based on primary structure plus shielding mass.  
<sup>27</sup> Estimate based on all listed module masses, including avionics and power management and distribution.  
<sup>28</sup> Estimate based on primary structure mass only. Habitats sited on a planetary surface might use in-situ resources for radiation shielding and micrometeoroid protection. Additional equipment may be required to construct such shielding, but the associated mass should be considerably less than the corresponding masses from Earth.  
<sup>29</sup> Transit vehicles for Martian missions are generally larger, based on current concepts, so volume-mass penalties for surface applications would also be suitable for transit applications.  
<sup>30</sup> These values are derived from hazards associated with interplanetary space transit. Vehicles on the surface of Mars would receive some beneficial shielding from the local Martian environment.

intensive environments anywhere beyond the Van Allen Belts, cost factors for shielded volume should be used whenever equipment is sensitive to radiation or must be frequently accessed by the crew. This value reflects the cost of placing equipment within the primary crew cabin. The cost for unshielded volume applies whenever the technology is not sensitive to radiation but must remain within a pressurized environment. The crew might service such equipment infrequently. Finally, some technologies are located outside the pressurized cabin, such as pressurized control system tanks, water tanks or thermal control heat exchangers. The associated volume cost factor would be much less than the lower value, such as 6-11 kg/m<sup>3</sup> for a minimal structure with micrometeoroid and orbital debris barrier.

Leakage is technology dependent. Life support systems are designed to carry consumables to meet the maximum allowable leakage rate in the design specifications for the spacecraft. In most cases, the actual leakage rate is significantly lower than the specification.

Currently, the United States uses the ISS common module to provide pressurized volume. Alternately, inflatable modules have been suggested since the Apollo Program. TransHab (Kilbourn, 1998, and NASA, 1999) presented in Table 3.7, is a robust inflatable module proposed for low-Earth orbit trials while attached to ISS. TransHab encloses 329.4 m<sup>3</sup> within a primary shell with an inner surface area of 250.9 m<sup>2</sup>. A connecting tunnel provides access to ISS with an additional 12.6 m<sup>3</sup>. The values in Table 3.7 include micrometeoroid protection and a storm shelter for radiation protection in low-Earth orbit against solar particle events. Finally, the ISS common module and TransHab are designed using different design philosophies, so a rigorous comparison between the two approaches is not intended. Rather, the values here document both approaches.

**Table 3.7 Masses of Inflatable Shell Components**

Item	Mass [kg]	References
Inflatable Shell Assembly, including Liner, Bladder, and Restraint	1,265	Based on TransHab Technology. See Kilbourn (1998), NASA (1999), and Atwell and Badhwar (2000)
Multi-Layer Insulation	235	
Micrometeoroid and Orbital Debris Protection	3,208	
Other (Windows, Deployment and Attachment Systems)	204	
Central Core Structure, including End Cones	1,405	
Water Containment <sup>31</sup> (Enclosing 18.8 m <sup>3</sup> and covering 40.1 m <sup>2</sup> )	142	
Radiation Protection Media (A 0.0574 m thick water shield; areal density 5.7 g/cm <sup>2</sup> )	2,304	
Initial Inflation System	502	
Avionics and Power Management and Distribution	1,398	
<b>Total Mass</b>	<b>10,663</b>	

Based on Table 3.7, several cost factors for various configurations of the components presented are possible (See Table 3.8). While each configuration is not independently viable, they provide background for other estimates. The applicable volume is 329.4 m<sup>3</sup>.

---

<sup>31</sup>The water tank surrounding the crew quarters is actually integrated with the central core structure.



**Table 3.8 Estimated Masses and Volume-Mass Penalties for Inflatable Module Configurations**

<b>Configuration</b>	<b>Mass [kg]</b>	<b>Volume-Mass Penalty [kg/m<sup>3</sup>]</b>	<b>Volume-Mass Penalty [m<sup>3</sup>/kg]</b>
All listed Inflatable Module components listed in Table 3.7	10,663	32.37	0.0309
Previous Option without Avionics and Power Management and Distribution	9,265	28.13	0.0355
Primary Shell and Central Core Only	3,016	9.16	0.1092
Previous Option plus Multi-Layer Insulation and Micrometeoroid and Orbital Debris Protection	6,459	19.61	0.0510
Previous Option plus Initial Inflation System	6,961	21.13	0.0473
Previous Option plus Avionics and Power Management and Distribution	8,359	25.38	0.0394
Avionics and Power Management and Distribution alone	1,398	4.24	0.2358

### 3.2.3 RADIATION SHIELDING FOR TRANSHAB

Table 3.9 contains data relating various proposed shielding materials via an inflatable TransHab structure. The volume is assumed to be 329.4 m<sup>3</sup>. The areal density of shielding to protect the crew from environmental radiation for a lunar surface mission should be about 15 g/cm<sup>2</sup>. For a longer stay such as a Mars mission, the assumption is made that the areal density would be 20 grams per cubic centimeter. However, there is a complication to this simplistic approach: because secondary particles can be released from the nucleus when struck by heavy and/or high-speed radiation particles, the effectiveness of shield materials varies on a molecular level. Thus, more massive shield materials are more likely to produce more secondary radiation. In general, atoms with lower atomic mass have less nuclear material and thus produce fewer secondary particles than the heavier nuclei. The simple hydrogen nuclei contain only one proton and no neutrons; therefore, they are able to absorb some of the energy of the incoming radiation while producing fewer additional particles.<sup>32</sup> Radiation scientists often use areal density when comparing the shielding needed for various environments:

$$\chi(\text{areal density}) = \rho(\text{density}) \times th(\text{thickness}) \quad \text{Equation 3.1}$$

<sup>32</sup> Hydrogen nuclei contain only one proton and thus the nucleus when struck by high speed particles cannot produce multiple secondary radiation from each hydrogen source.

**Table 3.9 Estimated Masses for Inflatable Modules**

ITEM (BASED ON TRANSHAB ARCHITECTURE)	Mass for Lunar Mission <sup>33</sup> [kg]	Mass for Lunar Mission <sup>34</sup> [kg]	Mass for Lunar Mission <sup>35</sup> [kg]	Mass for Martian Mission <sup>36</sup> [kg]	References
Primary Structure Mass (Core, Shell) <sup>(1) 37</sup>	6,961	6,961	6,961	6,961	<sup>(1)</sup> Kilbourn (1998) and NASA (1999) <sup>(2)</sup> Duffield (2010) Note: the surface area is estimated assuming a spherical configuration to relate volume and surface area.
Shielding Mass is 0.163 m of polyethylene around each of 4 CMs covering 2.0 m <sup>2</sup> surface area per CM. <sup>(2)</sup>	1,200				
Shielding Mass is 0.163 m of polyethylene around the entire shell volume of 329.4 m <sup>3</sup> <sup>(2)</sup>		34,599			
Shielding Mass is 0.079 m of regolith around the entire shell volume of 329.4 m <sup>3</sup> <sup>38</sup>			34,599		
Shielding Mass is 0.217 m of polyethylene around the entire shell volume of 329.4 m <sup>3</sup> <sup>(2)</sup>				46,131	
Total Mass	8,161	41,560	41,560	53,092	
Volume-Mass Penalty [kg/m <sup>3</sup> ]	24.8	126.2	126.2	170.3	
Volume-Mass Penalty [m <sup>3</sup> /kg]	0.0403	0.00792	0.00792	0.00587	

Including the avionics and power management and distribution masses, as listed in Table 3.8, adds an additional 4.24 kg/m<sup>3</sup> to the volume-mass penalties listed above. However, these masses are often accounted for in other factors, such as the power-mass penalty. Without radiation shielding or micrometeoroid protection, the primary shell and structure of the inflatable module has a volume-mass penalty of 9.157 kg/m<sup>3</sup> or 0.1092 m<sup>3</sup>/kg. This would be an appropriate estimate for a habitat shielded by local resources, whether regolith or in a natural feature such as a lava tube or cavern. The Human Integration Design Handbook (HIDH) (NASA HIDH, 2014) has a more complete description of the radiation environment.

**3.2.4 SECONDARY STRUCTURE COSTS**

The values in the previous tables quantify the vehicle’s primary structural mass, including the pressure vessel and radiation shielding. However, many systems also require additional secondary structure, such as a payload rack, drawers, or refrigeration. Based on data from the ISS Program (Green, *et al.*, 2000), Table 3.10 provides estimates for secondary structure masses. Though somewhat simplistic, the volume, power, and thermal control for equipment housed within or mounted to a secondary structure is assumed to be identical to the values for the uninstalled piece of equipment. Assuming a piece of equipment is not mounted directly to the vehicle primary structure, most are mounted to an International Standard Payload Rack. Small items are placed within trays and drawers of a stowage rack, whereas some foodstuffs and experiments require the chilled climate provided by a

<sup>33</sup> areal density= 15 g/cm<sup>2</sup>

<sup>34</sup> areal density= 15 g/cm<sup>2</sup>

<sup>35</sup> areal density= 15 g/cm<sup>2</sup>

<sup>36</sup> areal density= 20 g/cm<sup>2</sup>

<sup>37</sup> See the fifth configuration in Table 3.8.

<sup>38</sup> Note that the first three lunar shield evaluations have the same areal density of 15 g/cm<sup>2</sup> and the same mass per surface area, but not the same volume.

refrigerator or freezer. For example, 100 kg of food stored within a refrigerator would incur a secondary mass penalty of 136 kg in addition to any power, thermal control, or volume penalties, whereas a 100 kg pump mounted to the vehicle floor would have no associated secondary mass, though power, thermal control, and volume to account for primary structure might still apply.

**Table 3.10 Secondary Structure Masses**

<b>Mounting Configuration</b>	<b>Secondary Structure Mass per Mass of Equipment</b> [kg Secondary Structure /kg Equipment]	<b>Internal Cargo Volume</b> [m <sup>3</sup> ]	<b>References</b> Information from Green, <i>et al.</i> (2000) except as noted. ( <sup>1</sup> ) Toups, <i>et al.</i> (2001)
Directly to Primary Structure (No Secondary Structure)	0.00	n/a	
Directly to International Standard Payload Rack	0.21	1.57	
Within Trays of a Stowage Rack	0.80	0.9	
Within Refrigerator/Freezer Rack	1.36	0.614 ( <sup>1</sup> )	

The external volume for an International Standard Payload Rack is 2.00 m<sup>3</sup> (Rodriguez and England, 1998). The Stowage Rack and the Refrigerator/Freezer Rack are derived from the International Standard Payload Rack and have the same external dimensions.

#### 3.2.4.1 LUNAR ARCHITECTURE TEAM HIGH MOBILITY SCENARIO

The Lunar Architecture Team proposal consisted of a series of 32 lunar missions, starting with a build-up mission that included four 7-day Sorties (Toups & Kennedy, 2008). It represents NASA’s most recent study of a human lunar mission. The missions generally increase in length and complexity as the number of missions in the study increase. The initial Sorties will carry all logistics, but as the Outpost portion of the proposal is developed, expendables are either sent with the crew, sent via a supply vehicle, used from stores, saved from a previous mission or missions, or recovered from the waste stream. High Mobility Scenario is much more specific in the missions, the mission deliverables, modular development of habitat, EVAs and rovers, and other exploratory vehicles, than earlier LAT 2 proposals. Major emphasis for High Mobility Scenario is on mobility for exploration. Surface mobility was identified as a key element to the CxP and its endeavors to set up an Outpost (Bagdigian, 2009). Assuming this lunar exploration architecture, life support resources, such as oxygen, nitrogen, and water, are deployed to various loci on the Lunar or Martian surface. Planning must include delivery of logistical elements from Earth and then distribution of those elements to points of use on the lunar surface. Things such as water and oxygen will need to be transported back to a central location for regeneration or cleanup, and then be redistributed to points on the surface where they are needed.

The High Mobility Scenario Outpost consists of a Pressurized Core Module (PCM), a Pressurized Excursion Module, and Pressurized Logistics Module (PLM). There are four pressurized Lunar Electric Rovers (LERs). The pressurized volumes are listed in Table 3.11, as well as the major functions associated with each module. The PCM is assumed to house most of the regenerative environmental control and life support system (ECLSS) equipment. Each LER has the critical mass to support two crewmembers by using a portable utility palette (PUP).

Equivalencies are given in Table 3.12 to calculate equivalent system mass for High Mobility Scenario. A more complete accounting of the equivalencies can be obtained in (Lange, 2009).

**Table 3.11 Primary Makeup of Pressure Vessels for High Mobility Scenario**

High Mobility Scenario Pressurized Volume Functions						
PCM	Primary Habitation	Primary ECLSS	Primary Thermal ATCS	Primary Command & Control	Primary Waste & Hygiene	Primary Communications
PLM	Logistics Store	Primary Structure	Spares Store	Yes	Yes	Yes
LER or PCC	Rover Exploratory	Sleep	Toilet			
FSPS	Nuclear Reactor	May or may not be present				
PSU	Power store & supply					
PUP	Portable Utilities					

**Table 3.12 Calculated Equivalencies for High Mobility Scenario <sup>39</sup>**

Parameter	Value	Units
<b>Outpost Pressurized Core Module (PCM) Pressurized Volume Equivalency</b>		
PCM Pressurized Volume Equivalency, $(E_V)_{PCM}$	49	$\frac{kg}{m^3}$
<b>Outpost Pressurized Logistics Module (PLM) Pressurized Volume Equivalency</b>		
PLM Pressurized Logistics Module (PLM) $(E_V)_{PLM}$	36	$\frac{kg}{m^3}$
<b>LER Pressurized Crew Cab (PCC) Pressurized Volume Equivalency</b>		
PCC Pressurized Volume Equivalency, $(E_V)_{PCC}$	100	$\frac{kg}{m^3}$
<b>Outpost Power Supply Unit (PSU) Power Equivalency</b>		
PSU Illuminated-Only Power Equivalency, $(E_P)_{PSU-I}$	43	$\frac{kg}{kW}$
PSU Continuous-Only Power Equivalency, $(E_P)_{PSU-C}$	362	$\frac{kg}{kW}$
<b>Outpost Fission Surface Power System (FSPS-1) Power Equivalency</b>		
FSPS Continuous Power Equivalency, $(E_P)_{FSPS}$	221	$\frac{kg}{kW}$
<b>LER Battery Power Efficiency (without PUP)</b>		
LER Power Equivalency (LER Batteries Only), $(E_P)_{LER}$	1076 <sup>40</sup>	$\frac{kg}{kW}$
<b>LER/PUP Solar.Battery Power Equivalency</b>		
LER/PUP Power Equivalency without Extra Battery Set, $(E_P)_{LER-P}$	748 <sup>6</sup>	$\frac{kg}{kW}$
LER/PUP Power Equivalency with Extra Battery Set, $(E_P)_{LER-PB}$	1179 <sup>6</sup>	$\frac{kg}{kW}$
<b>Outpost Thermal Equivalency without LERs</b>		
PCM Thermal Equivalency, $(E_T)_{PCM}$	49	$\frac{kg}{kW}$
Outpost Average Thermal Equivalency without LERs	69	$\frac{kg}{kW}$
<b>LER Thermal Equivalency (Ice Block Only; 3 day life)</b>		
LER Thermal Equivalency Based on the Ice Block only	777	$\frac{kg}{kW}$
<b>LER Mobility Equivalency</b>		
LER Mobility Equivalency without PUP, $(E_M)_{LER}$	1.33	$\frac{kg}{kg}$
LER Mobility Equivalency with PUP, $(E_M)_{LER-P}$	1.35	$\frac{kg}{kg}$
LER Mobility Equivalency with PUP and extra batteries, $(E_M)_{LER-PB}$	1.45	$\frac{kg}{kg}$

<sup>39</sup> The following equivalencies were calculated by (Lange, 2009)

<sup>40</sup> Modified from the original Lange calculation according to estimates by Patrick George recorded via e-mail December 2009.

### 3.2.5 POWER COSTS <sup>41</sup>

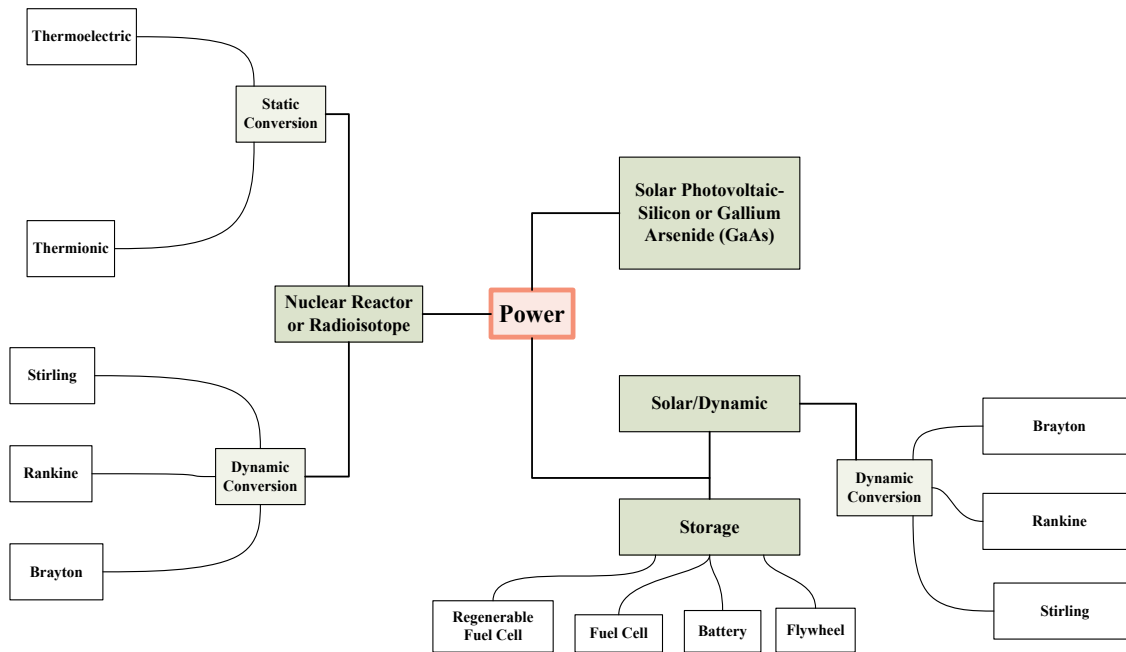

**Figure: 3.1 Power generation and storage options considered.**

Options for power generation, recovery, and storage considered here, and their general inter-relationship, are presented graphically in Figure: 3.1. Table 3.14 outlines the power options with data available from the literature. Consideration was given to all the processes listed in Figure: 3.1, but the table presents only those technologies with available data. The generalized cycles and processes are briefly discussed in the following paragraphs.

Figure: 3.1 lists the solar and nuclear power options considered for near-term human exploration missions. The three cycles presented here are dynamic conversion cycles: the Rankine, Brayton, and Stirling. These cycles are applicable for conversion of heat to current flow whether the heat is generated by an environmental source such as the Sun or possibly heat produced by nuclear fission or radioisotopic decay. Dynamic cycles may emit vibrational loads, but they can be integrated with or into balanced machines. Static cycles, though lacking vibrational emissions, are typically less efficient than their dynamic counterparts. Each cycle has attractive features that tend to manifest at different locations and operating conditions.

The Rankine cycle operates via a working fluid phase change. The working fluid is typically a liquid metal or an organic fluid. At constant pressure, which is typical for this approach, the process offers isothermal heat rejection. Because the heat-rejection-phase of power generation is isothermal, power can be obtained at relatively low operating temperatures and, theoretically, at higher efficiencies than the Brayton cycle. The Rankine cycle uses a liquid, typically a liquid metal, which passes through a heat exchanger to vaporize a working fluid, which then passes through turbo machinery, releasing work, and re-condenses.

Characteristic of the Brayton cycle is a single-phase working fluid that typically requires smaller radiators. The cycle is often used in a turbine to convert heat to current flow by pressurizing the air in a piston, adding fuel, and then igniting the mixture to trigger an expansion cylinder. The expanding gas drives a turbine releasing work.

The Stirling cycle is also single-phase with efficiencies theoretically close to those of the ideal Carnot cycle. The Stirling cycle uses a fixed mass of gas sealed inside the engine. Stirling engines are quiet since there are no explosions or high-pressure gas releases. The process is controlled by external heating and cooling of the sealed gas. The major drawback of this cycle is the relatively slow response time of the sealed gas to external heating and cooling. Thus, this cycle tends to favor smaller engines at lower power levels, so if larger amounts of power are

<sup>41</sup> The editor wishes to thank Robert L. Cataldo of the NASA's Glenn Research Center for his inputs and poignant comments on the makeup and structure of this power section.

needed several smaller reactors operate in parallel, which increases overall system mass. A comparison of the Brayton, Rankine and Stirling Power Module Characteristics (Frisbee and Hoffman, 1993), based on the SP-100 Nuclear Reactor Proposal for Mars Cargo Missions, is given in Table 3.13.

**Table 3.13 Power Module Characteristics for Nuclear Reactor Proposals** <sup>42</sup>

Item	Units	Cycle		
		Rankine	Stirling	Brayton
Reactor Full Power Projected Operating Life	y	7.4	9.6	7.6
Operating Temperature	K	1,355	1,355	1,355
Average Radiator Temperature	K	788	567	469
Radiator Platform Area	m <sup>2</sup>	90	183	531
Radiator Physical Area	m <sup>2</sup>	128	282	821
Auxiliary Radiator Area	m <sup>2</sup>	25	25	25
Stowed Dimensions				
Length	m	12.2	16.9	28.3
Diameter	m	5.5	5.5	5.5
Number of modules /launch	--	3	2	1
Power Module Masses				
Reactor and Controls	kg	841	841	841
Shield	kg	1,396	1,396	1,396
Primary Heat Transport	kg	895	807	1,104
Power Conversion System	kg	933	6,293	3,302
Heat Rejection & Transport	kg	1,066	420	1,157
Heat Rejection Radiator	kg	1,733	3,078	7,063
Parasitic Load Radiator	kg	140	140	140
Total Module Mass	kg	7,004	12,975	15,003
Module Power and Efficiency				
Thermal Power	kW <sub>th</sub>	2,356	1,850	2,309
Electric Power, gross	kW <sub>e</sub>	578	596	582
System Power	kW <sub>e</sub>	6	20	10
Net Power	kW <sub>e</sub>	572	576	572
System Efficiency	%	24	31	25
System Power-Mass Penalty <sup>43</sup>	kg/kW <sub>e</sub>	12	23	26

Several static conversion approaches exist. Two approaches that are of interest to NASA are thermionic and thermoelectric energy conversion. Several approaches also exist to make use of local insolation. The most prevalent are solar photovoltaic cells and solar dynamic systems, while thermionic Photon Chips™ are a recent development.

Thermionic energy conversion is the direct production of electric power from heat by thermionic electron emission. From a thermodynamic viewpoint, it is the use of electron vapor as the working fluid in a power-producing cycle. A thermionic converter consists of a hot emitter electrode from which electrons are vaporized by thermionic emission and a colder collector electrode into which they are condensed after conduction through the inter-electrode plasma. The resulting current, typically several amperes per square centimeter of emitter surface, delivers electrical power to a load at a typical potential difference of 0.5-1 volt and thermal efficiency of 5% to 20%, depending on the emitter temperature (1,500 K – 2,000 K) and specific mode of operation.

<sup>42</sup> Brayton, Rankine, and Stirling power module characteristics according to Frisbee and Hoffman (1993). The assessments are sized based on the SP-100 nuclear reactor proposal for Mars cargo missions with approximately 600 kW<sub>e</sub> of total power capacity. Note that most near-term to mid-term mission scenarios do not require that much power on the surface of Mars.

<sup>43</sup> This quantity is also known in the literature as the “system specific mass.”

Thermoelectric systems rely on the Seebeck effect where two dissimilar materials create a voltage at the material interface when exposed to a temperature gradient. Systems relying on thermoelectric conversion tend to have low efficiencies.

Solar photovoltaic (PV) cells have powered NASA probes in the inner Solar System for decades and, more recently, the ISS. According to ESAS (2005), solar PV cells are likely to power the CEV. Finally, solar PV cells are being considered for human vehicles on the surface of Mars where temperatures vary from 130 K to 300 K. Cell performance increases with decreasing temperature, with peak efficiencies occurring at 150 K to 200 K according to Landis and Appelbaum (1991). Some materials, such as silicon, increase in performance rapidly in PV cells at the relatively low temperatures found on Mars.

Solar dynamic systems for surface applications concentrate incident solar radiation using a spectral parabolic mirror and achieving high temperatures at a focal point to drive a generator. Local dust is an obstacle to this approach as the dust blocks some of the incident photons preventing them from reaching the collector.

Choices among conversion cycles are quite complex and choices among theoretical advantages sometimes suffer from engineering challenges and do not realize their full potential. Some cycles do offer greater maturity, but none of the cycles have demonstrated long-term reliability in space applications yet. Table 3.14 lists many power system options, and is divided into options by usage locale, power generation source, and vehicle type, with systems for similar vehicles being grouped together. Lee and Duffield (2006) provide additional details for many of the systems presented, and this work should be consulted by readers who desire more than what are given below. Power mass penalties are provided in terms of  $\text{kg/kW}_e$  for power generation systems that do not use consumables, whereas energy storage devices with consumables or power generation via consumables are characterized by energy-mass penalties in terms of  $\text{kg/kW}_e\text{h}$ . Several systems below are rated separately for non-consumable power generation technologies and consumable energy storage technologies, and both factors should be assessed for impacts on equivalent system mass if both are used in a projected mission. A brief discussion and further information on batteries (Table 3.15) and fuel cells (Table 3.16) follow Table 3.14.

Generally, solar power systems grow linearly with power required, whereas nuclear power systems have a high initial mass, especially for shielding. With a nuclear power system, adding small amounts of generating capacity with respect to total power-generating capacity adds little to the overall system mass. For example: starting with a 25  $\text{kW}_e$  nuclear plant with a mass of 6000 kg, doubling the power output to 50  $\text{kW}_e$  increases the overall mass to approximately 8000 kg. Doubling the power output again to 100  $\text{kW}_e$  increases the mass to around 11,000 kg (Cataldo, 2006).



**Table 3.14 Power Option Summary**

System	Kg/kW <sub>e</sub>	Kg/kW <sub>e</sub> h	Comments
<b>Static Power Options in Low Earth Orbit<sup>44</sup>:</b>			
Solar Photovoltaic Cells in Space w/o Storage <sup>(1)</sup>	6.7		Advanced flexible solar array for modest mission requirements.
Solar Photovoltaic Cells w/ Hydrogen Oxygen Fuel Cell Storage <sup>(4, 5, 6)</sup>	41	1.1	11% efficient producing 100 kW <sub>e</sub> ; Shuttle technology with a six day mission or lunar base solar power plant study.
Solar Photovoltaic Cells w/o Structure w/o Energy Storage Structure <sup>(Calculated from 5, 7, 8, 9, 10)</sup>	101		10 to 15% efficient producing 28 kW <sub>e</sub> ; Subtracted the mass of the structure batteries and related items.
Solar Photovoltaic Cells w/ Battery Storage <sup>(5, 7, 8, 10)</sup>	133	20.8	10 to 15% efficient producing 28 kW <sub>e</sub> ; Does not include the main supporting truss (P6); ISS
Solar Photovoltaic Cells w/ Battery Storage <sup>(5, 11)</sup>	166 <sup>45</sup>	20.8	20% efficient is the goal for thin film solar arrays; 35-40% efficient is the goal for advanced concepts producing 100 kW <sub>e</sub> ; <sup>46</sup> Best specific power to 1991 for earth orbit solar intensity.
Solar Photovoltaic Cells w/o Storage; Includes Support Structure <sup>(4, 11)</sup>	239		Up to 14% efficient; In sun power only with deployable PV cells
Solar Photovoltaic Cells w/ battery storage <sup>(4)</sup>	476	29	10 to 15% efficient producing 28 kW <sub>e</sub> ; Continuous power with deployable cells.
<b>Dynamic Conversion Power Options in Low Earth Orbit:</b>			
Solar w/ Stirling Dynamic Power Production <sup>(6)</sup>	405		26% efficient producing 100 kW <sub>e</sub>

**References**

- (1) Tom Kerslake/GRC personal communication (2015)
- (2) Piñero, *et al.* (2002)
- (3) Littman (1994)
- (4) Hanford and Ewert (1996)
- (5) Lee and Duffield (2006)
- (6) Eagle Engineering (1988)
- (7) Landis, *et al.* (1999)
- (8) Eagle-Picher (2003)
- (9) ISS (1999)
- (10) Patel (2005)
- (11) Landis and Appelbaum (1991)

<sup>44</sup> Specific Power is usually given for low-Earth orbit conditions. Values at the surface of Mars can be estimated by multiplying by the ratio of Mars solar intensity to low-Earth orbit solar intensity according to Landis, *et al.* (1999).

<sup>45</sup> Projected value based on components.

<sup>46</sup> Flight tested system is 15 kg/kW<sub>e</sub> (Landis and Appelbaum, 1991). Current system is 7.7 kg/kW<sub>e</sub>. Combining existing technology with gallium-arsenide, GaAs, at 3.3 kg/kW<sub>e</sub>, adds to the existing technology specific mass.

**Table 3.14 Power Option Summary**

System	kg/kW <sub>e</sub>	kg/kW <sub>e</sub> h	Comments	References
<b>Solar Conversion Power Options for the Surface of the Moon</b>				
Solar PV Power generation at Lunar Equator w/o Storage <sup>(22, 23)</sup>	54		Tracking PV arrays	<sup>(6)</sup> Eagle Engineering (1988) <sup>(22)</sup> Hughes (1995) <sup>(23)</sup> Ewert, <i>et al.</i> (1996) <sup>(24)</sup> Harty and Durand (1993) <sup>(25)</sup> Juhasz and Bloomfield (1994) <sup>(26)</sup> Mason (2006) <sup>(27)</sup> Kerslake (2005)
Solar w/ Stirling Dynamic Power Production <sup>(6)</sup>	405		26% efficient producing 100 kW <sub>e</sub>	
Solar PV Power Generation at Lunar Equator w/ Fuel Cell Storage <sup>(22, 23)</sup>	749	4	Tracking PV arrays	
<b>Nuclear Conversion Power Options on the Surface of the Moon</b>				
Nuclear w/ Brayton Dynamic Power Production <sup>(24)</sup>	29		producing 550 kW <sub>e</sub>	
Nuclear w/ Brayton Dynamic Power Production <sup>(25)</sup>	76		producing 20 kW <sub>e</sub>	
Nuclear refractory reactor w/ Brayton Dynamic Power Production; Moon or Mars <sup>(26)</sup>	77 <sup>47</sup>		23.5% efficient producing 55 kW <sub>e</sub> ; direct high-temperature Brayton	
Nuclear refractory reactor w/ Stirling Dynamic Power Production; Moon or Mars <sup>(26)</sup>	149		23.5% efficient producing 31 kW <sub>e</sub> ; Lithium liquid metal	
Nuclear refractory reactor w/ Thermoelectric Power Production; Moon or Mars <sup>(26)</sup>	349		4.1% efficient producing 16 kW <sub>e</sub> ; Lithium and SiGe	
Nuclear Fission w/ Brayton dynamic conversion <sup>(27)</sup>	125		producing 50 kW <sub>e</sub>	
Nuclear Fission w/ Stirling dynamic conversion <sup>(27)</sup>	120		50 kW <sub>e</sub>	
Nuclear Fission w/ thermoelectric static conversion <sup>(27)</sup>	136		50 kW <sub>e</sub>	

<sup>47</sup> A comparison with a stainless steel reactor resulted in superior performance for the refractory reactor for Brayton, Stirling, and Thermoelectric options (Mason, 2006).

<b>Table 3.14 Power Option Summary</b>				
<b>System</b>	<b>kg/kW</b>	<b>kg/kW<sub>e</sub>h</b>	<b>Comments</b>	<b>References</b>
<b>Solar Conversion Power Options on the Surface of Mars</b>				
Solar Photovoltaics w/o Storage <sup>(28)</sup>	149		28% efficient; Static solar power at an equatorial site on Mars	(3) Littman (1994) (28) NASA (1989) (29) Cataldo (1998) (30) Hoang, <i>et al.</i> (1988)
Solar Photovoltaic Cells w/ Fuel Cell Storage <sup>(29)</sup>	178	10	30% efficient; PV cell; Power generated at an equatorial site on Mars	
Solar Photovoltaic Cells w/ Fuel Cell Storage <sup>(29)</sup>	228	10	20% efficient; Power generated at an equatorial site on Mars	
Solar Photovoltaic Cells w/ Fuel Cell Storage <sup>(28)</sup>	338	n/a	Static solar power at an equatorial site on Mars	
<b>Nuclear Conversion Power Options on the Surface of Mars</b>				
Nuclear w/ Static Thermoelectric Power Production <sup>(29)</sup>	54		n/a efficient; Emplaced in excavated hole; Excavation equipment is included	
Nuclear w/ Static Thermionic Power Production <sup>(3)</sup>	55		n/a efficient producing 75 kW <sub>e</sub> ; Conceptual design	
Nuclear w/ Static Thermoelectric Power Production <sup>(29)</sup>	75		22% efficient producing 160 kW <sub>e</sub> ; On a self-deployed cart two kilometers from base.	
Nuclear w/ Static Thermoelectric Power Production <sup>(3)</sup>	87		n/a efficient producing 100 kW <sub>e</sub> ; On independent lander	
Small Radioisotope Power Systems <sup>(30)</sup>	88		n/a efficient producing 2 kW <sub>e</sub>	
Nuclear w/ Stirling Dynamic Power Production <sup>(29)</sup>	88		n/a efficient producing 100 kW <sub>e</sub> ; Shielding included; Conceptual design; Stirling Engine	
Nuclear w/ Static Thermionic Power Production <sup>(3)</sup>	107		n/a efficient producing 25 kW <sub>e</sub> ; Conceptual design	
Nuclear w/ Static Thermoelectric Power Production <sup>(29)</sup>	226		n/a efficient producing 100 kW <sub>e</sub> ; On mobile cart; Shielding included	

Energy storage devices for spacecraft with human crews come in two common forms: batteries, per Table 3.15; and fuel cells, per Table 3.16. The differences between batteries and fuel cell capabilities are not easy to discern. The rate and quantity of a battery discharge cycle is not equivalent to the availability of energy from a fuel cell. After installing a fuel cell's components, a fuel cell will output its full rated power continuously if supplied sufficient reactants. A battery, however, degrades with each discharge cycle and must be replaced more frequently than the components of a comparable fuel cell.

**Table 3.15 Characteristics of Advanced Rechargeable Batteries**<sup>48</sup>

Battery Technology	Cell Energy Density [W•h/L]	Cell Specific Energy [W•h/kg]	Operating Temperature [°C]	Number of Discharge Cycles in Cell Life [Cycles]	Depth of Discharge per Cycle [%]	Technology Readiness Level
“State of the Art” Nickel-Hydrogen (Ni-H <sub>2</sub> )	40 to 50	30 to 40	-5 to 30	60,000	30	9
Lithium-ion with Liquid Electrolyte	200 to 300	100 to 150	-40 to 65	1,500	60	5 to 9
Lithium-Solid Polymer Electrolyte	300 to 450	> 200	0 to 80	1,500	60	3
Lithium-Solid Inorganic Electrolyte	> 300	> 200	0 to 80	> 10,000	60	1 to 2

**Table 3.16 Advanced Fuel Cell Systems**<sup>49</sup>

Technology	Energy-Mass Penalty [kg/kW <sub>e</sub> h]	Lifetime	Technology Readiness Level
“State of the Art” Alkaline Fuel Cell	8 <sup>50</sup>	n/a	9
Polymer Electrolyte Membrane	4	n/a	4 to 5
Direct Methanol	4.5 <sup>51</sup>	n/a	2 to 4
Solid Oxide	n/a	n/a	2 to 3 <sup>52</sup>
Regenerative Systems based on Polymer Electrolyte Membrane or Solid Oxide	n/a	n/a	3

### 3.2.6 THERMAL CONTROL COSTS

Table 3.17 presents options for thermal control “costs” assuming an internal and an external thermal control system. Internal thermal control system masses primarily depend on the overall thermal load. External thermal control “costs” vary according to the magnitude of the thermal load and the ease of rejecting thermal loads from the vehicle and, therefore, depend heavily on both site and vehicle configuration. The values in Table 3.17 are representative of typical external thermal control system “costs” for the conditions listed. Lighter, more cost-effective thermal control options exist, but the values here provide representative or typical values for most design studies. They assume a traditional thermal control system architecture employing both an internal and an external thermal control system.

- *Note: The cost of a complete thermal control system is the sum of the internal thermal control system cost plus the appropriate external thermal control system cost.*
- *Note: The inverse thermal-control-mass penalties, given in kW/kg, may not be summed directly. Rather, only the reciprocal values, given in terms of kg/kW, may be summed directly.*

<sup>48</sup> See Davis, *et al.* (2005).

<sup>49</sup> Information from Davis, *et al.* (2005) except as noted.

<sup>50</sup> See NASA (2002).

<sup>51</sup> See Larminie and Dicks (2003) for details.

<sup>52</sup> This technology is available commercially, but there has been little testing for aerospace applications.

**Table 3.17 Advanced Mission Thermal Control Costs and Equivalencies**

<b>Internal Thermal Control System Cost</b>			
<b>Vehicle/Site Independent</b>	<b>kg/kW</b>	<b>kW/kg</b>	<b>Comments</b>
Flow Loop with Heat Acquisition Devices	~25 <sup>(1)</sup>	~0.040	Half of the Heat Load is acquired by Coldplates.
<b>External Thermal Control System Cost Options</b>			
<b>Transit or Low-Earth Orbit</b>	<b>kg/kW</b>	<b>kW/kg</b>	<b>Comments</b>
<i>Current Technology, Vehicles:</i> Flow-Through Radiators Only	30.4 <sup>(2)</sup>	0.0329	Shuttle Technology: Aluminum, Body-Mounted Radiators with Silver Teflon Surface Coating.
Lightweight, Flow-Through Radiators Only	~20 <sup>(4)</sup>	~0.05	As above with Composite, Flow-Through Radiators.
Flow-Through Radiators with a Supplemental Expendable Cooling Subsystem	40.0 <sup>(2)</sup>	0.0250	“Current Technology, Vehicles,” with an additional Flash Evaporator Subsystem.
Lightweight, Flow-Through Radiators with a Supplemental Expendable Cooling Subsystem	~30 <sup>(4)</sup>	~0.033	As above with Composite, Flow-Through Radiators
<i>Current Technology, Space Stations:</i> International Space Station <sup>53</sup>	323.9 <sup>(2)</sup>	0.00309	ISS Technology: Aluminum, Anti-Sun Tracking Radiators with Z-93 Surface Coating.
<b>Surface – Moon</b>	<b>kg/kW</b>	<b>kW/kg</b>	<b>Comments</b>
For an Equatorial Site using Horizontal Radiators with Silver Teflon Coating			
<i>Current Technology:</i> Flow-Through Radiators Only	221 <sup>(1)</sup>	0.0045	Aluminum, Surface-Mounted Radiators
Lightweight, Flow-Through Radiators Only	~190 <sup>(4)</sup>	~0.0053	As above with Composite Radiators.
Flow-Through Radiators + Solar Vapor Compression Heat Pump (SVCHp)	77 <sup>(1)</sup>	0.013	Aluminum, Surface-Mounted Radiators with SVCHp
Lightweight, Flow-Through Radiators with Solar Vapor Compression Heat Pump	~72 <sup>(4)</sup>	~0.014	As above with Composite Radiators.

- References**
- <sup>(1)</sup> Estimated from Hanford and Ewert (1996) and Ewert, *et al.* (1999)
  - <sup>(2)</sup> Hanford and Ewert (1996)
  - <sup>(3)</sup> Estimated from Hanford and Ewert (1996) and Hanford (1998)
  - <sup>(4)</sup> Estimated.

- Notes**
- The cost of a complete thermal control system is the sum of the internal thermal control system cost plus the appropriate external thermal control system cost.
  - Inverse values, given here in kW/kg, may not be summed directly.

<sup>53</sup> The value includes significant structures to attach or rotate the thermal radiator clusters.

Surface – Mars	kg/kW	kW/kg	Comments
For an Equatorial Site using Vertical Radiators with Silver Teflon Coating			
<i>Current Technology:</i> Flow-Through Radiators Only	~145 <sup>(3)</sup>	~0.0069	Aluminum, Surface-Mounted Radiators
Lightweight, Flow-Through Radiators Only	~121 <sup>(3)</sup>	~0.0083	As above with Composite Radiators.

The values in Table 3.17 come from a variety of sources. The internal thermal control system values are derived from studies of a lunar base, but they are considered typical of other enclosed cabins. The transit vehicle external thermal control system estimates are based on Shuttle technology. The primary heat rejection technology is radiators whereas an evaporative device, a flash evaporator, provides supplemental cooling. Transit vehicle external thermal control system estimates are provided both with and without supplemental evaporative cooling devices. Because a vehicle cannot reject heat using radiant transfer while aero-capturing or entering a planetary atmosphere, some other technology, such as evaporative cooling, supplements the radiators. Vehicles that do not experience aerodynamic heating may employ an external thermal control system without any evaporative cooling. The external thermal control system value for the ISS includes significant penalties for thermal-control-system-specific structure that is not necessary for transit vehicles with their lesser heat loads. See Hanford and Ewert (1996) for a detailed disposition of ISS external thermal control system masses.

Options for cooling habitats at a lunar surface site rely on horizontal radiators. Some options also employ a vapor compression heat pump powered by a dedicated solar PV array. Although the heat pump is only available while the Sun is above the local horizon, the radiators alone for this option are sized to reject the design load in the absence of sunlight. All options assume an equatorial site, which is the most severe for the lunar surface.

Finally, the external thermal control system options for the Martian surface employ only radiators sized for the worst environmental conditions expected at an equatorial site, which is a moderate dust storm, and assume that the environment does not impact the radiator surface properties. Sites in the Martian southern hemisphere can be more severe thermally than equatorial sites.

For each external thermal control system option above, less massive approaches are available with additional mission restrictions. In particular, the options listed with lightweight radiators are conservative approximations and research will reduce equipment masses further than these estimates imply. See Weaver and Westheimer (2002). Thus, the technologies here are generally available but are far from optimal for specific applications.

### 3.2.7 CREWTIME COSTS

Life support equipment requires crewtime for operations and maintenance. This time can be small for some systems and large for others. Notably for functions related to food – food production, food product preparation, meal preparation, and waste disposal – the crewtime may be very large. The cost of crewtime is derived from the life support system equivalent system mass (ESM) and the crewtime available. Typical equivalencies vary from about 0.1 to 10 crewmember-hours (CM-h) per kg of ESM. Section 3.3.3 provides additional details.

### 3.2.8 LOCATION FACTORS

Location factors<sup>54</sup> describe the additional resources necessary to move a mass of payload from low-Earth orbit to some location elsewhere in space. The additional resources here refer to propulsion assets such as engines, fuel, tankage, and associated propulsion-related structure.<sup>55</sup> Specifically, a location factor represents the additional mass necessary in low-Earth orbit to push a mass of payload to a particular destination. Location factors allow comparisons between cases where all payloads do not share the same transportation history. In other words, one payload option may stay entirely aboard one vehicle during the entire mission, whereas another payload option may

<sup>54</sup> Some researchers use the term “gear ratio” for “location factor.” However, these terms refer to the same concept.

<sup>55</sup> Recall that cabin structure, power, thermal control, and crewtime costs or penalties are already assessed with other factors.

jettison mass midway through the mission and thus reduce its associated propulsion costs for the remainder of the mission. ESM GD (2003) details the use of location factors within equivalent system mass assessments.

Location factors for two destinations, Moon and Mars, are presented in Table 3.18. Estimates for Mars assume the Mars Dual Lander architecture, whereas estimates for the Moon are based on the L<sub>1</sub> Gateway architecture. Values for the Moon based on ESAS (2005) are presented in RMD (2008). Both sets of estimates in Table 3.18 assume chemical propulsion and aero-braking when possible.<sup>56</sup>

Transfer Vehicles travel from low-Earth orbit to lunar or Mars orbit, and return to low-Earth orbit. The first estimate is for a round trip to one of the aforementioned bodies, whereas the second estimate is for payloads that only travel to the celestial body and then remain behind when the Transfer Vehicle returns.

Landers travel from low-Earth orbit to either the lunar or Martian surface and, in some cases, back to orbit. For example, within the Mars Dual Lander architecture there are two landers. The first, the Mars Descent/Ascent Lander, travels to Martian orbit robotically. In orbit, the Mars Transit Vehicle rendezvous with the Mars Descent/Ascent Lander and the crew transfers to the latter vehicle for the trip to the Martian surface. At the end of the surface stay, the Mars Descent/Ascent Lander returns the crew to Martian orbit and the Mars Transit Vehicle for the trip back to Earth. The second lander, the Surface Habitat Lander, travels and lands robotically on Mars. The crew transfers to the Surface Habitat Lander once they are on the surface.<sup>57</sup>

**Table 3.18 Location Factors for Near-Term Missions**

Mission Element (Segment)	Location Factor [kg/kg]		
	lower	nominal	upper
<b>Moon</b>			
Lunar Transfer Vehicle (Full Trip)		9.1:1 <sup>(1)</sup>	
Lunar Transfer Vehicle (Earth Orbit to Lunar Orbit then destroyed with the Service Module)		7.3:1 <sup>(1)</sup>	
Lunar Lander (Earth Orbit to Lunar Surface and back to Lunar Orbit)		13.8:1 <sup>(1)</sup>	
Lunar Lander (Earth Orbit to Lunar Surface Only)		7.2:1 <sup>(1)</sup>	
<b>Mars</b> <sup>58</sup>			
Mars Transfer Vehicle (Full Trip)	5.77 <sup>(2)</sup>	5.77 <sup>(2)</sup>	10.14 <sup>(2)</sup>
Mars Transfer Vehicle (To Mars Orbit Only)	2.16 <sup>(3)</sup>	2.16 <sup>(3)</sup>	3.37 <sup>(3)</sup>
Mars Lander (Earth Orbit to Martian Surface and back to Martian Orbit)	9.50 <sup>(2)</sup>	9.50 <sup>(2)</sup>	14.83 <sup>(2)</sup>
Mars Lander (Earth Orbit to Martian Surface Only)	2.77 <sup>(2)</sup>	2.77 <sup>(2)</sup>	4.33 <sup>(2)</sup>

**Reference**

- (1) ESAS (2005)
- (2) Personal Communication with J. Geffre in 2003
- (3) Personal Communication with J. Geffre in 2004

Per ESM GD (2003), location factors multiply the equivalent system masses to which they apply. The location factors given in Table 3.18 have units of “kilograms of total vehicle in low-Earth orbit divided by kilograms of life support hardware [payload] in low-Earth orbit.” Thus, an equivalent system mass corrected for location is the

<sup>56</sup> Advanced propulsion concepts may yield much lower location factors in the future, but development of advanced propulsion systems for human space flight currently has high programmatic risks.

<sup>57</sup> “Mars Transit Vehicle,” “Mars Descent/Ascent Lander,” and “Surface Habitat Lander” are specific names for vehicles from the Mars Dual Lander architecture. “Transfer Vehicle” and “Lander” are more generic names used here to differentiate between two types of vehicles that commonly appear in NASA advanced studies.

<sup>58</sup> Mars Dual Lander architecture.

product of the equivalent system mass contributions due to the physical attributes of the hardware and the location factor.

Example: A piece of equipment with an equivalent system mass of 2.0 kg as payload on a Mars Transfer Vehicle using nominal technology would have an equivalent system mass corrected for location of 11.54 kg if it remains on board during the entire mission from Earth, to Mars, and back again to Earth. Or, equivalently, this value may be expressed as an equivalent system mass is 2.0 kg for the payload hardware and other payload equivalencies and an additional 9.54 kg in equivalent system mass for propulsion and other vehicle infrastructure in low-Earth orbit to move the payload to Mars and back.

Alternatively, location factors in Table 3.18 may be expressed as ratios. Thus, the location factor for a full trip to and from Mars aboard a Mars Transfer Vehicle may be expressed as 5.77 kg of additional mass in low-Earth orbit for every 1 kg of payload that travels to Mars and back, or, in shorthand notation, 5.77:1. Using this approach yields the same result as the second form in the example above.

**Table 3.19 Equivalencies Based on Hardware Delineated During the Second Lunar Architecture Study of the Constellation Program**

			CEV <sup>59</sup>	Lunar Lander	Lunar Outpost
Power Transport		kg/kW <sub>e</sub>	91.9	27.6	72.1 (day)/ 605.1 (night)
Power Generation		kg/kW <sub>e</sub>	14.5	11.3	
Power Storage		kg/kW <sub>e</sub>	13.0	0.504	
Total Power Penalty		kg/kW <sub>e</sub>	125.9	67.2	
Structures		kg/m <sup>3</sup>	101.3 <sup>3</sup>	86.4	
Total Thermal		kg/kW <sub>th</sub>			
Thermal Components	Coldplates & related articles	kg/kW <sub>th</sub>	50.9	105.3	
	Radiator Rejection	kg/kW <sub>th</sub>	59.7	40.8	
	Evaporative Cooling	kg/kW <sub>th</sub>	110.6	28.42	
	Ascent & Reentry	kg/kW <sub>th</sub>	14.6	11.6	

### 3.3 CREW CHARACTERISTICS

As the life support system’s primary purpose is to maintain the crew, the crew characteristics will drive equipment requirements. From an analysis perspective, the human metabolic rate and available time are necessary input values.

In section 3.3.1 the crew metabolic rate is described according to equations developed during update of the NASA HIDH (2014) reference in the past. In much the same timeframe, the CxP developed a Table 3.22, giving metabolic rates for sleep and exercise as well as nominal activities.

#### 3.3.1 CREW METABOLIC RATE

##### 3.3.1.1 GENERAL METABOLIC RATES

Metabolic activity as a result of conversion of food to energy by the crew affects air revitalization and heat production directly but will also affect water use, waste production, and power consumption. The NASA HIDH (2014) lists empirical equations for calculating metabolic energy requirements as shown in Table 3.21. Here, crewtime is expressed in CM-h or crewmember-days (CM-d) where the prefix “crewmember” (CM) identifies a single individual conducting a task for the appended duration. Actual metabolic rate varies with lean body mass,

<sup>59</sup> Crew Exploration Vehicle (CEV)



environment, and level of physical activity. However, because lean body mass data is difficult to collect, a combination of total body mass and gender are often substituted for this parameter. Embedded in this substitution is the generalization that males have a greater percentage of lean tissue than females for the same total body mass. Thus, NASA HIDH (2014) defines the crewmember mass range from a 95<sup>th</sup> percentile American male, with a total body mass of 99 kg, to a 5<sup>th</sup> percentile Japanese female, with a total mass of 53 kg (See Table 3.20). Metabolism increases due to physical exertion and a heavy workload can generate more than 800 W/CM of thermal loading. Few people can continue this level of exertion for long, though the total energy expenditure for an exceptionally active 82 kg male could be as high as 18 Mega Joule per CM-d (MJ/CM-d) (208.3 W/CM) of thermal loading on the crew cabin or extravehicular mobility unit (EMU) (Muller and Tobin, 1980). Thus, EVA, as noted in Section 4.5, and exercise protocols can elevate metabolic rate. These data do not account for any metabolic effects due to low gravity. Data given in following sections are scaled for low and high levels of activity and for small and large people. The values derived using Equation 3.2 and Equation 3.3 account for a moderate level of crew activity.

**Table 3.20 Crewmember Mass Limits**

	Units	Limits			Reference
		lower	median male	upper	
Crewmember Mass	kg	53	82.00	110	From NASA HIDH (2014).

**Table 3.21 Human Metabolic Rates**

Gender	Age [y]	Metabolic Rate <sup>60</sup> [MJ/CM-d]	Reference
Male age 40, 1.829 m (6 ft), 82 kg		12.996	NASA HIDH (2014) modified
Female age 40, 1.829 m (6 ft), 82 kg		11.292	

*Human Metabolic Rate Equation males > 19 years of age:*

$$\left( \frac{622 - 9.53 \times \text{age}(\text{years}) + 1.25(15.9 \times \text{mass}(\text{kg}) + 539.6 \times \text{ht}(\text{m}))}{0.238853 \times 10^3} \right) = \text{Energy} \frac{\text{MJ}}{\text{CM} - \text{d}} \quad \text{Equation 3.2}$$

<sup>60</sup> The metabolic rate is the product of a basal rate and an activity factor. The basal rate, in parentheses, depends on crewmember mass [kg], *m*, and a second, mass-independent coefficient. The activity factor here is correlated as a function of gender whereas the other coefficients are correlated as functions of both gender and age.

Human Metabolic Rate Equation females > 19 years of age:

$$\left( \frac{354 - 6.91 \times \text{age}(\text{years}) + 1.25(9.36 \times \text{mass}(\text{kg}) + 726 \times \text{ht}(\text{m}))}{0.238853 \times 10^3} \right) \quad \text{Equation 3.3}$$

$$= \text{Energy} \frac{\text{MJ}}{\text{CM} - \text{d}}$$

### 3.3.2 EXPLORATION METABOLIC LOADS

Table 3.22 provides a listing, in SI units, of the design metabolic outputs per crewmember for exploration missions. Values given in Table 3.22 represent projected crew-induced metabolic loads or thermal loads from a single crewmember. So in addition to hardware induced thermal loads, a human vehicle must accommodate crew-induced loads. For this assessment during vehicle design, assume only one crewmember will exercise at a time and other crewmembers will remain at the nominal awake activity level. Total thermal loading from a single heat load component includes direct radiant thermal emission and heat convection from a crewmember. A crewmember metabolic load is the sum of the sensible (dry heat load) plus the total latent (wet, heat load). The total latent heat load includes moisture carried by exhaled gases, evaporated sweat from the skin or worn clothing, and sweat runoff. For purposes of vehicle design modeling, oxygen consumption and carbon dioxide production are assumed to be maximal during exercise, and they are assumed to return to nominal values as soon as the crewmember ceases exercising.

Using the 41-Node Metabolic Man algorithm and the judgment of a team of experts assembled to evaluate metabolic rates for the NASA HIDH (2014), the metabolic outputs and requirements are listed in Table 3.22 and were computed assuming the following inputs: the cabin air temperature is 294.3 K, the cabin dew point is 283.2 K, the air velocity is 0.152 m/s, the overall cabin pressure is 70.3 kPa, the crewmember's gender is male with a mass of 82 kg, the assumed maximal rate of oxygen uptake by the whole-body during exercise ( $\text{VO}_{2 \text{ max}}$ ) is 45 mL/kg-min., the efficiency for the exercise device is 5%, and the respiratory quotient is 0.92. Each crewmember's exercise routine is assumed to be 30 minutes long followed by 60 minutes to revert to the nominal awake metabolic level in a weightless environment. The crewmember's assumed clothing is a T-shirt and shorts. See Tucker (2006) for details.

Table 3.22 includes oxygen consumption and carbon dioxide production values for each of the listed metabolic output values. From the exercise physiology computations, these values are given in terms of volumetric flowrates at standard conditions defined as a pressure of 101.3 kPa, a temperature of 273.2 K, and no moisture in the air. The oxygen consumption and carbon dioxide production values in Table 3.22 are converted from volumetric flowrates at standard temperature and pressure to mass flowrates using the ideal gas law. The comparison between the metabolic rate in Table 3.21 and the rate in Table 3.22 is not a perfect comparison. One is taken from an empirical equation and one is based on an evaluation of a team of experts. Assuming the experts have the correct value the empirical value differs by 8.3%.

**Table 3.22 Crew Induced Metabolic Loads<sup>61</sup>**

1	2	3	4	5	6	7	8	9
Crew Member Activity Description	Duration of Activity (hr)	Sensible (dry) Heat Output kJ/hr (btu/hr)	Wet Heat Output (includes latent and sweat run-off) kJ/hr (btu/hr)	Total Heat Output Rate kJ/hr (btu/hr) <sup>(2)</sup>	Water Vapor Output kg/min* 10-4 (lbm/min* 10-4)	Sweat Runoff Rate kg/min* 10-4 (lbm/min* 10-4)	O <sub>2</sub> Consumption <sup>(4)</sup> kg/min* 10-4 (lbm/min* 10-4)	CO <sub>2</sub> Output <sup>(4)</sup> kg/min* 10-4 (lbm/min* 10-4)
Sleep	8	224 (213)	92 (87)	317 (300)	6.30 (13.90)	0.00 (0.00) <sup>(1)</sup>	3.60 (7.94)	4.55 (10.03)
Nominal	14.5	329 (312)	171 (162)	500 (474)	11.77 (25.95)	0.00 (0.00) <sup>(1)</sup>	5.68 (12.55)	7.20 (15.87)
Exercise 0 - 15 min at 75% VO <sub>2</sub> max	0.25	514 (487)	692 (656)	1206 (1143)	46.16 (101.76)	1.56 (3.43)	39.40 (86.86)	49.85 (109.90)
Exercise 15 - 30 min at 75% VO <sub>2</sub> max	0.25	624 (591)	2351 (2228)	2974 (2819)	128.42 (283.13)	33.52 (73.90)	39.40 (86.86)	49.85 (109.90)
Recovery 0 - 15 min post 75% VO <sub>2</sub> max	0.25	568 (538)	1437 (1362)	2005 (1900)	83.83 (184.82)	15.16 (33.43)	5.68 (12.55)	7.2 (15.86)
Recovery 15 - 30 min post 75% VO <sub>2</sub> max	0.25	488 (463)	589 (559)	1078 (1022)	40.29 (88.82)	0.36 (0.79)	5.68 (12.55)	7.2 (15.86)
Recovery 30 - 45 min post 75% VO <sub>2</sub> max	0.25	466 (442)	399 (378)	865 (820)	27.44 (60.50)	0.00 (0.00) <sup>(1)</sup>	5.68 (12.55)	7.2 (15.86)
Recovery 45 - 60 min post 75% VO <sub>2</sub> max	0.25	455 (431)	296 (281)	751 (712)	20.40 (44.98)	0.00 (0.00) <sup>(1)</sup>	5.68 (12.55)	7.2 (15.86)
<b>Total Per Day<sup>(3)</sup></b>	<b>24</b>	<b>7351 (6967)</b>	<b>4649 (4410)</b>	<b>12000 (11377)</b>	<b>1.85 (4.07)</b>	<b>0.08 (0.17)</b>	<b>0.82 (1.80)</b>	<b>1.04 (2.29)</b>

<sup>61</sup> NASA HDIH (2014)

### 3.3.3 CREWTIME ESTIMATES

Crewtime is an important commodity on any human mission. In fact, wise usage of the crew’s time is at the core of all exploration in which human beings take part. Historically, crewtime for life support functions has been limited to monitoring equipment and replacing expendables or making repairs. Support for the biomass production within a food subsystem, however, could easily consume a substantial fraction of the crew’s time.

The information here is meant to outline the time available to a crewmember during a standard workweek. Langston (2012) outlines a generic schedule for crewtime on ISS. This is assumed with slight modifications here as shown below in Table 3.23.

**Table 3.23 Time Allocation for a Nominal Crew Schedule in a Weightless Environment** <sup>62</sup>

Activity	Weekday [CM-h /CM-d]	Weekend Day [CM-h/CM-d]	
Daily Planning Conferences	0.5	0.0	Variably-Scheduled Time
Daily Plan Review / Report Preparation	1.0	0.0	
Work Preparation	0.5	0.0	
Scheduled Assembly, Systems, and Utilization Operations <sup>63</sup>	6.5	0.3	
Meals <sup>64</sup>	3.0	3.0	
Housekeeping, and Laundry	0.0	2.0	
Post Sleep	0.5	0.5	Invariantly-Scheduled Time
Exercise, Hygiene, Setup / Stow	2.5	2.5	
Recreation	0.0	6.0	
Pre-Sleep	1.0	1.0	
Sleep	8.5	8.5	
<b>Total</b>	<b>24.00</b>	<b>24.00</b>	

Several of the categories in Table 3.23 deserve some additional explanation. The category “scheduled assembly, systems, and utilization operations” includes, among other things, system and vehicle maintenance. Thus, life support system maintenance deducts crewtime from other mission objectives. The category “meals” includes pre-meal preparation and post-meal cleanup in addition to actual meal consumption. It is assumed here that the time for meals would not diminish on a vacation day. “Housekeeping, including laundry” is assumed here to include laundry operations, if applicable, in addition to general vehicle cleaning operations. For ISS, this is scheduled as 4 hours per crewmember per week during the weekend; i.e., 2 hours per crewmember per weekend-day. “Exercise, hygiene, setup/stow” is assumed to include pre- and post-exercise operations, such as post-exercise hygiene operations. In short, exercise includes some overhead in addition to the actual time spent exercising. “Sleep” denotes time for rest.

The ISS schedule devotes up to 80 minutes total of “daily payload operations” per non-weekday to support experiments that demand tending daily (Langston, 2005). This is included above in “scheduled

<sup>62</sup> From Langston (2005) for International Space Station crews. Note: Time estimates are given for a nominal week inside of ISS excluding variations for critical mission functions such as docking/undocking operations and/or extravehicular activities.

<sup>63</sup> This category includes payload operations. Langston (2005) allots up to 80 minutes per day to support experiments that may require daily tending, although such usage of crewtime is discouraged. Here, in round terms, this is represented as 0.3 hours per day per crewmember assuming the total time for daily payload operations will not increase and rounding to the nearest 0.1 hour.

<sup>64</sup> Langston (2005) allots a uniform 1.0 hour per meal for preparation, consumption, and cleanup.

assembly, systems, and utilization operations” during both weekdays and weekend days.<sup>65</sup> Assuming the overall magnitude of these daily payload operations will not increase, these operations for a crew of four (rounding to the nearest 0.1 hour) would equate to 0.3 h/CM-d.

Here, the last five categories in Table 3.23 – post sleep, exercise, hygiene, setup stow, recreation, pre-sleep, and sleep – are not available for life support operations under nominal scheduling scenarios. For purposes here, they are classified as Invariantly-Scheduled Time (IST).

Time other than IST, theoretically, might be available for either maintaining the life support system or for other activities if the life support system uses less time. This time block is designated here as Variably-Scheduled Time (VST). VST includes not only time for mission objectives, but also time scheduled for life support operations, such as equipment maintenance, meal preparation, consumption, and cleanup, as well as laundry operations. Realistically, using the entire block of VST for life support functions is unacceptable, though the total VST places an upper limit on available time. Further, any time not used for life support operations may be employed to accomplish mission objectives while not impacting the IST.

As outlined in Langston (2005), ISS will operate on a standard week of seven 24-hour days. The standard workweek, for planning purposes, is 5 weekdays followed by a 2-day weekend. Vacation is allotted as 8 days per crewmember per year regardless of nationality.

Assuming a workweek schedule as outlined in Table 3.23 and an ISS vacation schedule, a crewmember will have, on average, 67.2 CM-h/wk of VST and 100.8 CM-h/wk of IST in a weightless environment.<sup>66</sup> Assuming the exercise time is 0.5 CM-h/d shorter due to working against gravity, a crewmember will have 69.7 CM-h/wk of VST and 98.3 CM-h/wk of IST on a planetary surface. Minimally, a crewmember might be expected to work at least 50 CM-h/wk, recalling that this VST includes maintaining the life support equipment and meal operations. The maximum available VST might be 10% greater than the average values but, based on Skylab experience, this rate can only be maintained for periods of 28 days or less.

**Table 3.24 Crewtime per Crewmember per Week**

Mission Phase	Assumptions [CM-h/wk]			References
	lower	nominal	upper <sup>67</sup>	
Transit/Weightlessness	50 <sup>(1)</sup>	67.2 <sup>(2)</sup>	73.9 <sup>(1)</sup>	(1) Estimated (see above) (2) Based on Langston (2005)
Surface/Hypogravity	50 <sup>(1)</sup>	69.7 <sup>(1)</sup>	76.7 <sup>(1)</sup>	

To assess the cost associated with adding an operation that requires crew intervention, a crewtime mass penalty is computed by dividing the total per capita life support system mass by the VST crewtime. This penalty may be applied to determine the ESM associated with crew operations. Typical values might vary between 0.1 kg/CM-h and 10 kg/CM-h.

Two philosophies are commonly employed by researchers to determine a crewtime-mass-penalty (CTMP). The first assumes that each hour of crewtime required by the life support systems is equally valuable.

<sup>65</sup> During the weekday, the daily payload operations are included within the allotment of 6.5 h/CM-d. They only appear as a “separate item” on weekend days.

<sup>66</sup> The term "microgravity" is often used to designate the condition experienced in Earth orbit. However, until one is relatively far away from the Earth, gravity is still present, and an older term, "weightlessness," is more accurate. In low-Earth orbit, the force of gravity is still about 95% of what it is on the surface of the Earth, but objects falling freely – whether in orbit or falling toward the atmosphere or in any other trajectory not involving non-gravitational external forces, such as propulsion or atmospheric drag – do not feel any force. "Weight" is the term used for the force felt when a human’s feet press against the Earth, and thus holds the individual back against the force of gravity. In free fall, there is no such force, hence the term "weightless" is more accurate. To get true microgravity – a millionth of that on the surface of the Earth – the Sun's gravity must be considered also. At the distance of the Moon, this is about twice that of the Earth. To encounter true microgravity, one would have to travel out to near the edge of the Solar System, about as far as the orbit of Uranus. In many situations, the difference between microgravity and weightlessness does not matter. However, it may affect the behavior of fluids, rotational movement, and large structures, and the use of tethers.

<sup>67</sup> The listed upper limit for crewtime per week is 10% above the average values discussed in the text. Firm upper limits are not currently known, but they are likely to be no greater than these values, especially for operations lasting more than a week or two.

The second, as forwarded by Levri, *et al.* (2000), assumes that each additional hour of time required by the life support system is more valuable than the previous hour. The first approach is consistent with the philosophy adopted to compute the other mass-equivalencies (See Section 3.2), whereas the second tends to more severely penalize a life support system architecture that makes large demands on crewtime. The first approach is recommended for general use.

The first approach used to determine CTMP assumes each hour of crewtime is equally valuable. Once a value for crewtime is established, changes in crewtime have a linear effect on the overall equivalent mass of a life support system. Table 3.25 provides CTMP values for several mission scenarios computed using Equation 3.6. Inputs for these values come from or are based on the Advanced Life Support Research and Technology Development Metric for Fiscal Year 2006 (Metric, 2006). The lower and nominal values in Table 3.25 are derived from life support systems using advanced technologies, whereas the upper values reflect current technologies from historical programs such as the Space Transportation System (STS), or Shuttle, or the ISS.<sup>68</sup>

**Table 3.25 Crewtime-Mass Penalty Values Based Upon the Fiscal Year 2006 Advanced Life Support Research and Technology Development Metric**

Mission Destination	Assumptions [kg/CM-h]			Reference
	lower	nominal	upper	
<b>Low-Earth Orbit</b>				
	0.333	0.333	0.724	( <sup>1</sup> ) Baseline Technologies from Metric (2006)
<b>Moon</b>				( <sup>2</sup> ) Exploration Technologies from Metric (2006)
Crew Exploration Vehicle	3.640 ( <sup>2</sup> )	5.050 ( <sup>1</sup> )		
Lunar Surface Access Module	13.98 ( <sup>2</sup> )	15.66 ( <sup>1</sup> )		
Lunar Outpost <sup>69</sup>	1.480 ( <sup>2</sup> )	2.100 ( <sup>1</sup> )		
<b>Mars</b>				
Mars Transit Vehicle	0.526 ( <sup>2</sup> )	0.802 ( <sup>1</sup> )		
Mars Descent/Ascent Lander	1.810 ( <sup>2</sup> )	2.850 ( <sup>1</sup> )		
Surface Habitat Lander	0.506 ( <sup>2</sup> )	0.940 ( <sup>1</sup> )		

The second approach to determine CTMP values assumes that each hour of crewtime required by the life support system is more valuable than the previous hour. Thus, the CTMP is computed by dividing the life support system mass, excluding crewtime, by the total available crewtime that is not devoted to personal activities or to maintaining the life support system. Equivalently, this latter denominator is VST minus time devoted to the life support system. This value is effectively fixed once the total crewtime, crewtime devoted to the life support system, and the life support system mass are determined. However, this value is a function of the crewtime required to service and maintain the life support system, so it will vary if its component values change.

Assuming each hour of crewtime is more valuable than the previous hours of crewtime, Levri, *et al.* (2000) present a formulation for the second crewtime-value formulation. They define the following terms:

<sup>68</sup> Please note that the Advanced Life Support Research and Technology Development Metric for Fiscal Year 2006 may not be identical to the infrastructure values presented above in Section 3.2; the infrastructure values should, however, be comparable, so the values here may be used as approximate values.

<sup>69</sup> Metric (2006) calls the “Lunar Outpost” the “Destination Surface System.”

Symbol	Units	Physical Meaning
$ESM_{w/o\ ch}$	[kg]	Equivalent system mass (ESM) for the life support system without accounting for crewtime spent for life support. Or, the “non-crewtime” portion of ESM.
$ESM_{LSS}$	[kg]	Component of life support ESM to support crewtime involved in life support. Or, the “crewtime” portion of ESM.
$ESM_{Total}$	[kg]	Total life support system ESM; $ESM_{w/o\ ch} + ESM_{LSS}$ .
$t_{LSS}$	[CM-h/wk]	Crewtime spent on the life support system. This is identical to the portion of VST spent of life support.
$t_{MP}$	[CM-h/wk]	The total crewtime per week available for life support system maintenance or mission-related objectives. This is equivalent to VST.
$t_{MP-LSS}$	[CM-h/wk]	Crewtime per week not devoted to the life support system or to personal activities; $t_{MP} - t_{LSS}$ . This is crewtime available for mission-related objectives such as science or exploration.

Levri, *et al.* (2000) then assume that the overall ESM of the life support system, including the crewtime, is proportional to the total mission production time as the ESM of the life support system without crewtime is proportional to mission production time less the time for life support, or:

$$\frac{ESM_{Total}}{t_{MP}} = \frac{ESM_{w/o\ ch}}{t_{MP-LSS}} \quad \text{Equation 3.4}$$

Alternatively, the overall ESM of the life support system is:

$$ESM_{Total} = ESM_{w/o\ ch} \left( \frac{t_{MP}}{t_{MP-LSS}} \right) \quad \text{Equation 3.5}$$

Using this approach, as crewtime for life support increases, the crewtime per week not devoted to life support or to personal activities,  $t_{MP-LSS}$ , decreases, and the overall ESM for the life support system increases in a non-linear manner. In fact, as  $t_{MP-LSS}$  approaches zero, the overall ESM for the life support system approaches infinity.

Thus, here CTMP is derived by dividing the life support equivalent system mass excluding crewtime by the total available crewtime not devoted to personal activities or life support maintenance.

$$CTMP = \frac{ESM_{w/o\ ch}}{t_{MP}} \quad \text{Equation 3.6}$$

### 3.3.4 NOMINAL HUMAN INTERFACES

Nominal balances of major life support commodities are summarized in Table 3.26, for a standard 82 kg crewmember with a respiratory quotient <sup>70</sup> of 0.92 during intravehicular activities. The water loads include 0.345 kg/CM-d of metabolically generated water. Actual values depend on many factors, including physical workload, diet, and individual metabolism.

<sup>70</sup> Respiratory quotient is defined as moles of carbon dioxide produced divided by moles of oxygen consumed.

**Table 3.26 Summary of Nominal Human Metabolic Interface Values**

Balance <sup>71</sup>	Interface	Units	Nominal Value
	<b>Basis</b>		
	Overall Body Mass	kg	82
	Respiratory Quotient		0.92 <sup>72</sup>
	<b>Air</b>		
- m	Carbon Dioxide Load	kg/CM-d	1.04 <sup>(1)</sup>
+ m	Oxygen Consumed	kg/CM-d	0.816 <sup>(1)</sup>
	<b>Food</b>		
+ m	Food Consumed; Mass	kg/CM-d	1.51 <sup>(1) 73</sup>
+ E	Food Consumed; Energy Content	MJ/CM-d	12.59 <sup>(2)</sup>
+ m	Potable Water Consumed <sup>74</sup>	kg/CM-d	2.5 <sup>(1)</sup>
	Metabolic Water <sup>75</sup>	kg/CM-d	0.4
	<b>Thermal</b>		
- E	Total Metabolic Heat Load <sup>76</sup>	MJ/CM-d	12.00 <sup>(1)</sup>
	Sensible Metabolic Heat Load	MJ/CM-d	7.35 <sup>(1)</sup>
	Latent Metabolic Heat Load <sup>77</sup>	MJ/CM-d	4.65 <sup>(1)</sup>
	<b>Waste</b>		
- m	Fecal Solid Waste (dry basis)	kg/CM-d	0.032
- m	Perspiration Solid Waste (dry basis)	kg/CM-d	0.018
- m	Urine Solid Waste (dry basis)	kg/CM-d	0.059
	<b>Water<sup>78</sup></b>		
- m	Fecal Water	kg/CM-d	0.1
- m	Respiration and Perspiration Water <sup>79</sup>	kg/CM-d	1.9
- m	Urine Water	kg/CM-d	1.6

**References**

- <sup>(1)</sup> Calculated from the NASA HIDH (2014), Metabolic rate is with exercise.
- <sup>(2)</sup> Perchonok (2008), 10-day menu.

In addition to the gross metabolic balance, human beings also emit other compounds in trace concentrations, products of metabolic processes, as noted below in the appropriate sections. Additionally, human beings also generate solid and water loads associated with personal hygiene. These hygiene loads are more variable than metabolic loads and, thus, tend to be mission dependent. Nominal hygiene loads are also summarized below. Please refer to the tables listing design water and waste loads in section 4.2.

<sup>71</sup> Masses consumed by the crewmember are denoted by “+ m,” whereas masses rejected by the crewmember are denoted by “- m.” Likewise, energy entering the crewmember is denoted by “+ E,” whereas energy rejected by the crewmember is denoted by “- E.”

<sup>72</sup> This respiratory quotient is in reality dependent on diet.

<sup>73</sup> As shipped, before water addition. Contains approximately 0.7 kg/CM-d water

<sup>74</sup> This value includes drinking water and water used to hydrate food and drinks, Food is not generally dehydrated on the ISS.

<sup>75</sup> Metabolic water is generated as the body oxidizes food.

<sup>76</sup> The total metabolic heat load is the summation of the sensible and latent metabolic heat loads.

<sup>77</sup> Assuming a latent heat for water of 2,420 kJ/kg.

<sup>78</sup> The difference between the water load sum of fecal water, respiration and perspiration water, and urine water, and the potable water consumed, as given above, is metabolic water. Here, metabolic water is 0.345 kg/CM-d. Also, the water values below are consistent with the dry basis waste values above.

<sup>79</sup> The respiration and perspiration water corresponds to the latent metabolic heat load above.



## 4 LIFE SUPPORT SUBSYSTEM ASSUMPTIONS AND VALUES

The function of life support consists of three subsystems: Air, Water, and Waste, as described in section 2.3. A considerable number of other systems interact with these subsystems, including: Food, EVA, Habitation, Power, Radiation Protection, Thermal Control, Medical Care, In situ Resource Utilization, Control Systems, and Biomass Production. Organization of these topics in this document is based on the perception of criticality to life support from a time point of view, and if time criticality is judged equivalent, then overall impact to the life support system is considered. For example, biomass production will be extremely important in years to come and there has been considerable work done in this area, but its use is not on the near horizon. It was therefore put at the end of the section so the reader would not have to look through that large body of material each time the document is referenced. The Food System has references to the Biomass Production System, which comes later in the document, but it is also extremely important near term so it is placed relatively high on the list of interfaces with life support subsystems.

### 4.1 AIR SUBSYSTEM

#### 4.1.1 DESIGN VALUES FOR ATMOSPHERIC SYSTEMS

Air supply is the most time-critical of the life support functions. Typical steady-state values are given in Table 4.1. Total pressure could vary from 20.7 kPa (3 psia) to greater than 117.2 kPa (17 psia) with oxygen content from 2.48 psia partial pressure to 34% by volume (NASA HIDH [2014]). The Apollo Program used 34.5 kPa (5 psia) 100% oxygen and the Skylab Program used 5 psia and 70% oxygen. However, in the interest of fire safety, experts at NASA feel that very high oxygen concentration is too risky for safe operation due to the threat of fire, and also pure oxygen is believed to cause some damage to the lungs if used for extended periods of time without interruption.

One of NASA's major goals is suited operations on the lunar and Martian surfaces (see further discussion in section 4.6). ISS EVA operations originate from 21% oxygen and 101.3 kPa (14.7 psia) of pressure, with a prebreathe period at 70.3 kPa (10.2 psia). Under this protocol, exploration EVA would be possible, but it would be inefficient and challenging since frequent EVA is expected. An extended prebreathe protocol would be necessary to gradually move the nitrogen from tissues, into the blood, and finally out of the crewmember's lungs prior to embarking on EVA. Without this protocol, the crewmember would likely be subject to decompression sickness where nitrogen bubbles form in the tissue spaces, thereby causing pain and, in extreme cases, neurological damage or even death. By stabilizing the crew in an atmosphere where pressure is closer to the eventual EVA suit pressure, the prebreathe protocol can be shortened and therefore is less risky and more efficient, allowing EVA goals to be reached. At lower total pressure, the crewmember's lungs still must see a similar oxygen partial pressure as seen at Earth sea-level conditions. The percentage by volume of oxygen in the cabin atmosphere must therefore be higher than an Earth sea-level atmosphere. This represents a compromise where there is somewhat more risk of fire in order to accomplish EVA exploration goals. The fire risk is then mitigated further by limiting cabin construction materials for the specified percentage of oxygen.

The most recent recommendation for atmospheres that will enable high-frequency EVA phases of a mission is 57 kPa (8.2 psia) total pressure and 34% oxygen content (Norcross, 2013). This is most likely to be required for pressurized rovers and surface habitats. Vehicles without expected EVA (such as launch and transport vehicles) are still expected to operate with Earthlike atmospheres as the ISS does, and be pressurized at 101 kPa (14.7 psia) with 21% oxygen. A habitat that operates at 57 kPa (8.2 psia) during high-frequency EVA operations would also be required to operate at 101.3 kPa during other phases because the majority of flight data experience is at these higher pressures. Landers and other vehicles with intermediate requirements and any vehicle that supports a contingency EVA capability would operate at 70.3 kPa (10.2 psia) and 26.5% oxygen (Norcross, 2013). These design recommendations will result in a particular vehicle having different set points for operation during different phases of the mission. A vehicle may also be driven to add a setpoint by an interface requirement with element operating at a different specific pressure. Typically, the highest total pressure and highest oxygen concentration drive requirements for structural design and the materials used for components inside. As a result, ECLSS hardware should be developed to operate at all three conditions to enable operations of a vehicle with multiple set points, and enable technology commonality across multiple vehicle elements.

Humans are susceptible to hypercapnia in varying degrees based on elevated carbon dioxide levels in the atmosphere. Table 4.2 provides historical spacecraft maximum allowable concentrations (SMAC) for CO<sub>2</sub>; however, as noted in the footnote of Table 4.1, ISS has recently adopted a lower maximum value for CO<sub>2</sub> of

≤0.53 kPa (4 mm Hg) as per CHIT (a short official note from Mission Control). Investigation of symptoms associated with elevated CO<sub>2</sub> levels is ongoing (Law, 2014).

A variety of symptoms occur from exposure to elevated CO<sub>2</sub> (Table 4.3). The first to appear are those of the respiratory system and continue as the dosage increases. Dyspnea on exertion and awareness of increased respiration begins near 2% CO<sub>2</sub> concentration. Inhalation of 4% to 5% for 30 minutes causes dyspnea, sweating, dizziness, and headaches. Increasing the concentration to 6% increases the occurrence of dyspnea to 100% as well as speech difficulty (Seter, 1993). The actual onset of symptoms to CO<sub>2</sub> concentration is highly variable and depend on the individual characteristics. Longer-duration exposure to even 0.5% CO<sub>2</sub> in microgravity is unknown but thought to be adverse (Law 2014).

The ISS has developed flight rules pertaining to CO<sub>2</sub> concentration partly derived from SMAC's, NIOSH guidelines and OSHA standards. These flight rules are listed below (Law, 2010).

- If ppCO<sub>2</sub> levels average higher than 5.3 mm Hg over 5 days or 6.0 mm Hg over 1 day, the flight surgeon must be consulted when planning crew activities.

- If ppCO<sub>2</sub> levels reach or exceed 7.6 mm Hg, measures must be taken to lower the ppCO<sub>2</sub> to permissible levels per Flight Rule B17-5 (“CO<sub>2</sub> Partial Pressure Limits and Actions”), which details specific actions to troubleshoot and scrub CO<sub>2</sub>. The same corrective actions are required if ppCO<sub>2</sub> is 4.5 mm Hg or greater and CO<sub>2</sub>-related symptoms not attributed to another cause are present.

- Off-nominal situation: Immediate action to minimize adverse CO<sub>2</sub> effects on the crew must be taken at CO<sub>2</sub> levels of 10 to 15 mm Hg. The gas environment is scrubbed down to allowable CO<sub>2</sub> levels. If signs of illness develop, the crew must use individual breathing devices (IBDs). If the ppCO<sub>2</sub> remains above 7.6 mm Hg or if the IBDs get expended, the crew must evacuate the affected area. Exposure to CO<sub>2</sub> levels of 10 to 15 mm Hg are limited to 8 hours or less.

- Emergency situation: Immediate action with the highest priority to prevent crew exposure must be taken at CO<sub>2</sub> levels of 15 to 20 mm Hg. The crew is to use IBDs when performing repair operations, scrub down the gas environment, and evacuate the affected area if ppCO<sub>2</sub> remains higher than 15 mm Hg or if IBDs become expended.

**Table 4.1 Typical Steady-State Values for Vehicle Atmospheres**

Parameter	Units	Assumptions <sup>80</sup>			References
		lower	nominal	upper	
Carbon Dioxide Generated	kg/CM-d	0.622 <sup>81 (1)</sup>	1.037 <sup>82 (1)</sup>	7.178 <sup>83 (1)</sup>	<sup>(1)</sup> calculated based upon lower and upper metabolic rates in NASA HIDH (2014). RQ, respiratory quotient is assumed to be 0.92. <sup>(3)</sup> Lin (1997) <sup>(4)</sup> Earth normal <sup>(5)</sup> accepted optimum for plant growth <sup>(6)</sup> ALS RD (2003) <sup>(7)</sup> Boeing (2002) <sup>(8)</sup> computed from NASA (1998) and Boeing (1994) <sup>(9)</sup> Eckart (1996) <sup>(10)</sup> NASA HIDH (2014) <sup>(12)</sup> Paul (2006) <sup>(13)</sup> Typical ISS
Oxygen Consumed	kg/CM-d	0.518 <sup>(1)</sup>	0.818 <sup>(1)</sup>	5.67 <sup>(1)</sup>	
p[O <sub>2</sub> ] for Crew; nominal no impairment <sup>10</sup>	kPa	18.62 <sup>(10)</sup>	18.62 <sup>(10)</sup>	23.44 <sup>(10)</sup>	
p[O <sub>2</sub> ] for Crew; measurable impairment until acclimatized <sup>10</sup>	kPa	17.24 <sup>(10)</sup>	18.62 <sup>(10)</sup>	18.62 <sup>(10)</sup>	
p[O <sub>2</sub> ] for Crew; allowable for 1 hour <sup>10</sup>	kPa	15.17 <sup>(10)</sup>		17.24 <sup>(10)</sup>	
p[CO <sub>2</sub> ] for Plants	kPa	0.04 <sup>(4)</sup>	0.13 <sup>(5)</sup>	3.4 <sup>(12)</sup>	
p[CO <sub>2</sub> ] for Crew	kPa	0.263 <sup>84</sup>	0.53 <sup>85</sup>	See Table 4.2	
Total Cabin Pressure	kPa	48.0 <sup>(6) 86</sup>	70.3 <sup>(3)</sup>	102.7 <sup>(6)</sup>	
Temperature	K	291. <sup>(6)</sup>	296 <sup>(6)</sup>	300 <sup>(6)</sup>	
Relative Humidity	%	25 <sup>(6)</sup>	40 <sup>(13)</sup>	70 <sup>(6)</sup>	
Perspired Water Vapor	kg/CM-d	0.036 <sup>(7)</sup>	0.699 <sup>(7)</sup>	1.973 <sup>(7)</sup>	
Respired Water Vapor	kg/CM-d	0.803 <sup>(7)</sup>	0.885 <sup>(7)</sup>	0.975 <sup>(7)</sup>	
Maximum Design Leakage Rate (space flight)	%/d	0	0.05 <sup>(8)</sup>	0.14 <sup>(8)</sup>	

**Table 4.2 Spacecraft Maximum Allowable Concentrations for CO<sub>2</sub>**

Time	Limit [kPa]	Limit [psia]	References and notes
1 h	2.027 <sup>(1)</sup>	0.29	<sup>(1)</sup> NASA HIDH (2014)
24 h	0.53	0.08	See footnote 85
7 to 180 d	TBR 0.706 <sup>(1)</sup>	0.10	Currently under review by NASA
1000 d	TBR 0.506 <sup>(1)</sup>	0.07	Currently under review by NASA

<sup>80</sup> The values here are averages for nominal operation of the life support system. Degraded or emergency life support system values may differ.

<sup>81</sup> During sleep

<sup>82</sup> Nominal respiration

<sup>83</sup> Seventy-five percent VO<sub>2</sub> max

<sup>84</sup> Shuttle avg, 7 d flight; There is no lower bound on CO<sub>2</sub> (Marshburn, 1996)

<sup>85</sup> This value is based on ISS, which has been operating under a provisional SMAC of 4mm Hg or 0.53 kPa.

<sup>86</sup> An almost pure oxygen atmosphere, such as was utilized for early spacecraft (Mercury, Gemini, and Apollo), has a total pressure of 34.5 kPa. Skylab used an atmosphere at 34.4 kPa (258 millimeters of mercury), but the crews reported numerous discomforting effects.

**Table 4.3      Symptoms of Carbon Dioxide Toxicity**

Signs/Symptoms at increasing levels
Increase in respiratory rate, tidal volume
Headaches
Hyperventilation
Dyspnea, intercostal pain with exercise
Airway resistance (at larynx, possibly)
Hand tremors, visual acuity decrements
Slow linear increase of CO <sub>2</sub> over 8 hrs; decrease in response time, possibly vomiting
Hearing and vision affected

In addition to the carbon dioxide load noted above in Table 4.1, human beings also emit volatile compounds, products of metabolic processes, on a per-crewmember per-day basis and cabin equipment on a per-mass-of-equipment-per-day basis, as noted in Table 4.4 (Perry, 2009). NASA establishes Spacecraft maximum allowable concentration (SMAC) values for many compounds. The load model contains all of the primary life support system design driving compounds. These include NH<sub>3</sub>, CH<sub>4</sub>, CO, dichloromethane, methanol, 2-propanone, and several low molecular weight alcohols. Good functional class representation is provided with the most prevalent compounds reported from in-flight cabin air quality sample analyses included in the listing.

This load model is recommended for future design basis for trace contamination control effort. This replaces the 58 compound load model used previously (Perry, 1998). The new load model decreases the NH<sub>3</sub> production rate by 86% from the previous value of 350.0 mg/person-d based on greater number of literature sources.

**Table 4.4 Model for Trace Contaminant Generation** <sup>87</sup>

CONTAMINANT	SMAC* (mg/m <sup>3</sup> )	RATE	
		EQUIPMENT (mg/kg-d)	METABOLIC (mg/person-d)
Methanol	90	1.3 × 10 <sup>-3</sup>	0.9
Ethanol	2,000	7.8 × 10 <sup>-3</sup>	4.3
n-butanol	40	4.7 × 10 <sup>-3</sup>	0.5
Methanal	0.12	4.4 × 10 <sup>-6</sup>	0.4
Ethanal	4	1.1 × 10 <sup>-4</sup>	0.6
Benzene	0.2	2.5 × 10 <sup>-5</sup>	2.2
Methylbenzene	15	2 × 10 <sup>-3</sup>	0.6
Dimethylbenzenes	37	3.7 × 10 <sup>-3</sup>	0.2
Dichloromethane	10	2.2 × 10 <sup>-3</sup>	0.09
2-propanone	52	3.6 × 10 <sup>-3</sup>	19
Trimethylsilanol	4	1.7 × 10 <sup>-4</sup>	0
Hexamethylcyclotrisiloxane	9	1.7 × 10 <sup>-4</sup>	0
Ammonia	2	8.5 × 10 <sup>-5</sup>	50
Carbon monoxide	17	2 × 10 <sup>-3</sup>	18
Hydrogen	340	5.9 × 10 <sup>-6</sup>	42
Methane	3,500	6.4 × 10 <sup>-4</sup>	329

\*180-day SMAC, JSC 20584 (2008).

#### 4.1.2 GAS STORAGE

Gas storage is necessary for any life support system. Gas can be stored in pressure vessels, as a cryogenic fluid, adsorbed, or chemically combined. The “costs” of storage depends on the gas, with the “permanent” gases, such as nitrogen and oxygen, requiring higher pressure and remaining in the gaseous state at normal temperatures, whereas the “non-permanent” gases, such as carbon dioxide, can be stored as liquids under pressure. Cryogenic storage requires either continuous thermal control or use of a small quantity of the gas to provide cooling by evaporation. Adsorption and chemical combination are very gas-specific, and vary in performance. See Table 4.5 for known gas storage tank masses.

**Table 4.5 Gas Storage**

Type of Storage	Performance [kg of tankage/kg of gas]	
	Nitrogen	Oxygen
Pressure Vessel	0.556 – 1.70 <sup>(1)</sup>	0.364 <sup>(2)</sup>
Cryogenic Storage	0.524 <sup>(2)</sup>	<sup>(2)</sup>

#### References

- <sup>(1)</sup>Personal communication with S. Lafuse in 2001  
<sup>(2)</sup>Hamilton Sundstrand (1970)

#### 4.1.3 PLANETARY DUST

Apollo astronauts learned first-hand how problems with dust impact lunar surface missions. After 3 days, lunar dust contamination on EVA suit bearings led to such great difficulty in movement that another EVA would not have been possible. Dust clinging to EVA suits was transported into the Lunar Module. During the return trip to Earth, when micro gravity was reestablished, the dust became airborne and floated through the

<sup>87</sup> From Perry (2009).

cabin. Crews inhaled the dust and it irritated their eyes. Some mechanical systems aboard the spacecraft were damaged due to dust contamination (Wagner, 2006).

As NASA embarks on future exploration missions, the effects of these extraterrestrial dusts must be well understood and systems must be designed to operate reliably and protect the crew in the dusty environments of the Moon, Mars, and asteroids.

#### 4.1.3.1 REGOLITH

Regolith is defined as the layer of loose material covering the bedrock of the Earth and Moon, etc., comprising soil, sand, rock fragments, volcanic ash, glacial drift, etc. Because the Moon does not have an atmosphere and running water, erosion forces that weather the Earth do not exist. Asteroids and meteors strike the lunar surface creating craters and large rocks. High energy particles and micro-meteors continuously bombard the Moon further breaking these rocks into very fine dust.

When lunar samples were brought to Earth during the Apollo missions, scientists in the receiving laboratory sorted and catalogued rocks greater than 1 centimeter. The sub-centimeter portion was further broken down into “coarse fines” (1 cm to 1 mm) and “fine-fines” (sub-millimeter) and although the definition was sub-centimeter, in practice, it is the sub-millimeter fine-fines are called soil. The portion of the soil less than 50 micrometers was informally called dust.

“Roughly 10% to 20% of the lunar soil is finer than 20  $\mu\text{m}$ , and a thin layer of dust adheres electrostatically to everything that comes in contact with the soil: spacesuits, tools, equipment, and lenses ... The shapes of individual lunar soil particles are highly variable, ranging from spherical to extremely angular. In general, the particles are somewhat elongated and are subangular to angular. Because of the elongation, the particles tend to pack together with a preferred orientation of the long axes.” (Heiken, 1991) As particle size decreases, adhesive, cohesive, and excitatory forces become very strong. This is important from an engineering perspective because the smaller particles will tightly adhere to surfaces they contact and tend to stick together.

On Mars, the unconsolidated material is a mix of windblown sand and dust and fragments of underlying bedrock. The sand is predominantly basalt, whose composition has been only minimally altered chemically by interactions with atmospheric gases and water. In contrast, the dust is brighter and very red, and consists of basaltic rocks that have been broken into small particles and oxidized by exposure to the atmosphere and possibly water. Martian dust is sticky and tends to adhere to exposed surfaces.

<http://crism.jhuapl.edu/science/geology/geology.php>

“The Viking Lander 1 site has two types of fine-grained sediment deposits: drift and blocky material. The drift material, which has the “consistency of loose kitchen flour” (Arvidson et al. 1989a) covers about 14% of the Viking Lander 1 site. Blocky material, having the apparent consistency of “dry cloddy garden soil,” was also present in the rocky area in front of the Lander where it was usually overlain by drift material.”

<http://www.uapress.arizona.edu/onlinebks/ResourcesNearEarthSpace/resources24.pdf>

Study results obtained by robotic Martian missions indicate that Martian surface soil is oxidative and reactive. Exposure to the reactive Martian dust may pose a concern to crew health and the integrity of mechanical systems.

Describing Martian dust, Morris (2006) wrote, “Bright Martian dust can therefore be described as an assemblage of particles in the clay plus fine silt size range (<5  $\mu\text{m}$ ) that contain primary igneous minerals (olivine, pyroxene, feldspar, and magnetite) and sulfate-bearing alteration/weathering products (npOx but not phyllosilicate minerals). Discrete dust particles are predominately composites of these phases rather than predominantly monophase [e.g., Madsen et al., 1999; Goetz et al., 2005]. The strongly magnetic mineral in the dust (and Laguna Class soil in general) is magnetite [Morris et al., 2004, 2006; Goetz et al., 2005].” This paper included the table (shown below), which provides chemical composition of Martian dust.

Readers can find more information about Martian dust in (Tomasko 1999).

**Table 4.6 Elemental Data for Martian Dust, Panda Subclass Soil, and MoessBerry Subclass Soil**

	Martian Dust			Panda Subclass Soil		MoessBerry Subclass			
	GC, <sup>a</sup> %	MP, <sup>a</sup> %	Average, <sup>b</sup> %	GC, <sup>c</sup> %	MP, <sup>c</sup> %	Observed, <sup>c</sup> %	Spherule, <sup>d</sup> %	CBS2A, <sup>e</sup> %	CBS2B, <sup>f</sup> %
SiO <sub>2</sub>	44.71 ± 0.52	44.97 ± 0.29	44.84 ± 0.52	46.52 ± 0.57	46.78 ± 1.22	38.54 ± 1.10	0.00	45.69 ± 1.32	45.81 ± 1.19
TiO <sub>2</sub>	0.89 ± 0.08	1.01 ± 0.07	0.95 ± 0.08	0.87 ± 0.15	1.02 ± 0.18	0.73 ± 0.05	0.00	0.86 ± 0.06	0.99 ± 0.17
Al <sub>2</sub> O <sub>3</sub>	9.49 ± 0.16	9.14 ± 0.09	9.32 ± 0.18	10.46 ± 0.71	9.67 ± 0.49	7.63 ± 0.23	0.00	9.05 ± 0.28	9.50 ± 0.46
Cr <sub>2</sub> O <sub>3</sub>	0.31 ± 0.04	0.32 ± 0.03	0.32 ± 0.04	0.36 ± 0.08	0.41 ± 0.08	0.28 ± 0.03	0.00	0.33 ± 0.04	0.37 ± 0.04
Fe <sub>2</sub> O <sub>3</sub>	6.58 ± 0.07	7.97 ± 0.03	7.28 ± 0.70	4.20 ± 0.54	4.36 ± 0.74	20.24 ± 4.37	99.70	5.62 ± 0.97	5.82 ± 0.98
FeO	10.52 ± 0.11	10.31 ± 0.04	10.42 ± 0.11	12.18 ± 0.57	13.75 ± 1.00	11.17 ± 3.55	0.00	13.24 ± 4.26	12.09 ± 0.88
MnO	0.31 ± 0.02	0.34 ± 0.01	0.33 ± 0.02	0.33 ± 0.02	0.38 ± 0.02	0.28 ± 0.02	0.00	0.34 ± 0.02	0.36 ± 0.02
MgO	8.20 ± 0.15	7.57 ± 0.08	7.89 ± 0.32	8.93 ± 0.45	7.31 ± 0.30	6.55 ± 0.25	0.00	7.76 ± 0.30	7.60 ± 0.31
CaO	6.13 ± 0.07	6.54 ± 0.04	6.34 ± 0.20	6.27 ± 0.23	7.12 ± 0.28	5.23 ± 0.37	0.00	6.20 ± 0.44	6.73 ± 0.26
Na <sub>2</sub> O	2.89 ± 0.29	2.22 ± 0.19	2.56 ± 0.33	3.02 ± 0.37	2.23 ± 0.23	2.16 ± 0.11	0.00	2.56 ± 0.13	2.40 ± 0.25
K <sub>2</sub> O	0.48 ± 0.07	0.48 ± 0.06	0.48 ± 0.07	0.41 ± 0.03	0.49 ± 0.07	0.38 ± 0.03	0.00	0.45 ± 0.04	0.49 ± 0.07
P <sub>2</sub> O <sub>5</sub>	0.90 ± 0.09	0.93 ± 0.07	0.92 ± 0.09	0.83 ± 0.23	0.82 ± 0.05	0.81 ± 0.04	0.00	0.96 ± 0.05	0.87 ± 0.05
SO <sub>3</sub>	7.56 ± 0.13	7.28 ± 0.07	7.42 ± 0.13	4.90 ± 0.74	4.97 ± 0.58	5.17 ± 0.42	0.00	6.13 ± 0.50	6.20 ± 0.72
Cl	0.88 ± 0.03	0.78 ± 0.01	0.83 ± 0.05	0.61 ± 0.08	0.57 ± 0.06	0.69 ± 0.03	0.00	0.81 ± 0.04	0.70 ± 0.07
Br (x10 <sup>4</sup> )	29 ± 22	26 ± 14	28 ± 22	49 ± 12	39 ± 27	56 ± 22	0	66 ± 26	34 ± 24
Ni (x10 <sup>4</sup> )	636 ± 73	467 ± 42	552 ± 85	544 ± 159	399 ± 100	854 ± 182	3000	479 ± 106	476 ± 119
Zn (x10 <sup>4</sup> )	406 ± 32	401 ± 14	404 ± 32	204 ± 71	238 ± 63	329 ± 25	0	391 ± 30	321 ± 85
Total	99.85	99.87	99.86	99.89	99.89	99.84	100.00	100.00	99.88
Fe <sup>3+</sup> /Fe <sub>T</sub>	0.36 ± 0.03	0.41 ± 0.03	0.39 ± 0.03	0.24 ± 0.02	0.22 ± 0.03	0.66 ± 0.06	1.00	0.28 ± 0.02	0.30 ± 0.02

<sup>a</sup>GC, Gusev crater; MP, Meridiani Planum. Analyses of Desert\_Gobi and MontBlanc\_LesHauches are from *Gellert et al.* [2006a,b].

<sup>b</sup>Uncertainty is larger of deviation from average value and maximum value for analytical uncertainty.

<sup>c</sup>Data are average ±1σ of data from *Gellert et al.* [2006] and R. Gellert (manuscript in preparation, 2006).

<sup>d</sup>Model spherule elemental composition.

<sup>e</sup>Calculated composition of basaltic soil (CBS2A) from Observed = 0.16 × (Spherule) + 0.84 × (CBS2A). In this calculation, the spherules account for ~50% of the total Fe.

<sup>f</sup>Calculated composition of basaltic soil (CBS2B) from CBS2B = 0.50 × (Ave. Dust) + 0.50 × (MP Panda Subclass).

#### 4.1.3.2 PLANETARY DUST SYSTEM IMPACTS

A NASA team of multi-disciplined engineers and scientists was tasked to identify systems that will be affected by dust and how they will be affected (Wagner 2008). The tables that follow resulted from that study.

**Table 4.7 Air Revitalization System Effects of Dust Exposure**

Subsystem/Component	Effect due to Dust Exposure
Ventilation System	Mechanical components of vents, fans, intakes, louvers, may be compromised. Certain failures in these systems have the potential to become active dust spreaders rather than dust eliminators.
Trace Contaminant Control	Impaired system would decrease the capacity to scrub contaminants.
CO <sub>2</sub> removal	Desiccant and sorbent beds may become fouled with dust, reducing performance.
CO <sub>2</sub> reduction	Catalytic beds may become fouled with dust, reducing performance.
O <sub>2</sub> generation	May become fouled with dust, reducing performance.
CO <sub>2</sub> compressor	May become fouled with dust, reducing performance.
Particulate Control System	Possible system overload and/or drastic increase in mass due to high use of expendables.

**Table 4.8 Water Recovery System Effects of Dust Exposure**

Subsystem/Component	Effect due to Dust Exposure
Biological Water Processor	Bacterial organisms may be poisoned by chemicals in dust.
Water Quality Monitor	Clogging or blocking of chemically reactive sites or physical pathways of instrument resulting in performance degradation.

**Table 4.9 Solid Waste Effects of Dust Exposure**

Subsystem/Component	Effect due to Dust Exposure
Waste Collectors	If salts and metals from the dust are present biological processes may not be able to remove said materials from the system and if trying to use recycled materials contaminated with dust constituents, time dependent buildup to unacceptable levels could occur. Effects crops and water.
Waste Compactor	Compactor tubes may be scratched, scored, damaged.
Particle Size Reducer	Dulled cutting blades.
Waste Disposal	Filters and other components will be frequently replaced placing a burden on waste disposal processes and storage.

**Table 4.10 Thermal Effects of Dust Exposure**

Subsystem/Component	Effect due to Dust Exposure
Radiators	Deposits on the radiator surface may degrade performance.
Humidity Control	Clogging of pitot tubes, small orifices in rotary separators, and porous media used to separate condensate from the air stream.



**Table 4.11 Other Life Support Systems Effects of Dust Exposure**

Subsystem/Component	Effect due to Dust Exposure
Crop Growth	If dust is used in the root substrates, when it dries, circulating air around the plants may stir up dust. Chemicals in dust may poison plant organisms.
Crop Harvesting	Harvesting of dry crops may produce organic dust.
Valves	Compromise sealing surfaces, corroding or scoring turning shafts.
Pumps	Plugging, eroding bearings, moving parts.
Membranes	Chemical attack, fouling, puncturing, plugging.
Filters	Plugging.
Seals	Plugging or compromising sealing surfaces.
Heat Exchangers	Internal clogging, covering of external heat exchanging surfaces.
Flow Tubes	Clogged, scratched, scored, damaged.
Fluid Connectors	Sliding seals can get scratched and lead to leakage.

**Table 4.12 Airlock Effects of Dust Exposure**

Subsystem/Component	Effect due to Dust Exposure
Quick Disconnects (QDs)/ Connectors	Seal degradation, leaks, higher spares/maintenance.
Hatch Seals	Seal degradation, leaks, higher gas makeup, spares/maintenance, dust transfers into habitat/vehicle.

**Table 4.13 Space Suit Assembly Effects of Dust Exposure**

Subsystem/Component	Effect due to Dust Exposure
Outer Garment	Dust accumulation/transfer to airlock-habitat; degradation of materials.
Bearings	Seal degradation, leaks, higher spares/maintenance.
Visor Coatings	Scratches/severe abrasion; loss of coatings.
Lighting	Reduced illumination due to dust coating illumination source.

**Table 4.14 PLSS Power and Communications Effects of Dust Exposure**

Subsystem/Component	Effect due to Dust Exposure
Electrical Circuits	Charged dust particles could result in static shock to electronics.
Battery/Fuel cell	Dust in battery contacts cause power drain and potential short circuit.

**Table 4.15 PLSS Cooling Effects of Dust Exposure**

Subsystem/Component	Effect due to Dust Exposure
Evaporative Membrane	Contamination of membrane surface; transport blockage.
QDs and Connectors	Seal degradation, leaks, higher spares/maintenance.
Radiator Surface	Thermal coating degradation/loss of cooling efficiency.

**Table 4.16 PLSS O<sub>2</sub> Effects of Dust Exposure**

Subsystem/Component	Effect due to Dust Exposure
QDs/connectors	Seal degradation, leaks, higher spares/maintenance.
Regulators	Contamination of orifices; transport blockage.

**Table 4.17 PLSS Vent Effects of Dust Exposure**

Subsystem/Component	Effect due to Dust Exposure
QDs/connectors	Seal degradation, leaks, higher spares/maintenance.
Venting Membranes	Contamination of membrane surface; transport blockage.

**Table 4.18 Ancillary Equipment Effects of Dust Exposure**

Subsystem/Component	Effect due to Dust Exposure
Power Tools	Dust in battery contacts cause power drain & potential short circuit.
Wrenches	Buildup and restriction of working parts.
Sockets	Buildup and restriction of working parts.
Drills	Buildup and restriction of working parts.
Joints on Translation Aids	Buildup and restriction of working parts.
Structures	Buildup and restriction of working parts. Corrosive constituents in dust may lead to degradation of structures if water used in EVA operations contacts dust on surfaces.
Tools/Hardware	Buildup and restriction of working parts.

**Table 4.19 Advance Food Systems Effects of Dust Exposure**

Subsystem/Component	Effect due to Dust Exposure
Food Storage System	Contamination.
Processing Equipment	Contamination.
Food preparation equipment	Contamination.

*4.1.3.3 REGOLITH CONTAMINATION MANAGEMENT - LAYERED ENGINEERING DEFENSE STRATEGY*

*"A common sense, layered, engineering design defense can solve any apparent problem with dust during long-term human activity and habitation in the lunar environment."*

*Harrison H. Schmitt  
Ames Research Center  
Lunar Dust Symposium  
February 2, 2004*

Space Systems Engineers design their individual components and systems for reliability, as they should. And, for cross-cutting challenges, such as regolith contamination, an integrated systems strategy needs to be considered. Such a strategy is described in (Wagner 2014). An integrated systems approach incorporates contamination prevention, exterior cleaning and protection, interior cleaning and protection, and maintaining air quality. It depends mostly on sound operations and engineering design, though some technology investments will be required.

The first two layers of defense are materials and engineering design. Materials, when possible, should consist of smooth, dust- and abrasion-resistant surfaces. Pockets, folds, and other points on space suits that could trap dust should be minimized and designed so they do not collect dust. Specialized surfaces that reject dust, either because of inherent surface properties or through active means, should be considered in original design where appropriate.

Engineering design should incorporate dust covers for sensitive equipment and employ grates on floors to collect dust. Best practices for cleanable design should be followed and include minimizing gaps where dust and dirt can collect, designing rounded corners, and including human factors experts throughout the design process to assess crew access.

Operational design is another key component for particulate management. Suit and contaminated equipment ingress to habitable volumes should be eliminated, where practical. Where feasible, automated operations, such as continuously active or automated cleaning systems, will reduce the amount of crew-time required for managing regolith particulate contamination. “Asteroid, Lunar and Planetary Regolith Management: A Layered Engineering Defense” NASA/TP-2014-217399 identifies the technology capabilities needed to implement the layered engineering defense strategy. It includes example technologies that would allow NASA to reach each capability, and it identifies the missions that each of these technologies support.

## 4.2 WATER SUBSYSTEM

Water will not be the most time-critical life support commodity, but water regeneration streams are the most massive of the life support subsystems. Further, water quality is of great concern with respect to crew health. A complementary regimen of technologies must be employed, which address contaminant removal issues mechanically and chemically. In the past, power use has driven water regeneration. However, other infrastructure “costs” are also important.

### 4.2.1 DESIGN VALUES FOR WATER SUBSYSTEMS

Clean water is required for drinks, food preparation, personal hygiene, and possibly for cleaning clothes and equipment. Water quality standards will vary, but they might include potable, and hygiene, and water purified to technical grade. The tables here provide anticipated usage rates for several scenarios. The values are averages during nominal operation of the life support system. Degraded or emergency life support system values may be different. Table 4.20 lists steady-state water usage estimates for missions of 30 days or less. Table 4.21 lists steady-state water usage estimates for longer-duration missions. More importantly here, Table 4.22 details anticipated wastewater generation rates to be processed by the Water Subsystem for long-duration missions. Please note that the water usage rates and wastewater generation rates sometimes differ, as a quick comparison of Table 4.21 to Table 4.22 confirms. In some cases, either the water usage or wastewater generation rates are unknown. In other cases, water usage does not correspond to wastewater generated and sent to the Water Subsystem, depending upon the configuration of the system using the water.

The mission scenarios are defined as: (1) Devon Island (described below, for comparison); (2) Assembly complete ISS, assumed as lacking a hygiene water facility (i.e., sink); (3) A transit mission, currently assumed to have similar hygiene capabilities as ISS; (4) Early Planetary Base, assumed to have the capability for limited hygiene water use; and (5) Mature Planetary Base, assumed to have the capability for full hygiene water use as well as a biomass production chamber for food cultivation. For more information on the ISS state-of-the-art water recover system, see (Carter et al. 2013).

**Table 4.20 Steady-State Values for Vehicle Water Usage for Short Duration Missions**

Parameter	Units	Assumptions			Notes:
		lower	nominal	upper	
Crew Water Allocation, assuming Minimal Hygiene Water for a Mission Less Than 30 days	kg/CM-d		2.7 <sup>(1)</sup>		<sup>(1)</sup> Based on Orion This 'steady-state' value does not include additional per mission water requirements of 0.5 L/CM for eyewash, 1 L/CM for pre-landing fluid loading or 0.5 L/CM for post-landing.

The Haughton-Mars Project is an international interdisciplinary field research project. The project is centered on Devon Island in the High Arctic, which is viewed as a terrestrial analog for Mars. The rocky polar desert setting, geologic features, and biological attributes of the site offer unique insights into the possible evolution of Mars; in particular, the history of water and of past climates on Mars, the effects of impacts on Earth and on other planets, and the possibilities and limits of life in extreme environments. In parallel with its science program, the Haughton-Mars Project supports an exploration program aimed at developing new technologies, strategies, human factors experience, and field-based operational know-how key to planning the future exploration of the Moon, Mars, and other planets by robots and humans. The concept of simulating some aspects of a Martian mission: EVA, Long Range Pressurized Rover, medical telemedicine and communication, studying immune system changes, plant growth using artificial light, and water-formed geologic features, all suggest that possibly Mars had a similar geologic past to the Devon Island environment.

The section in Table 4.21 that contains the water use numbers for the Devon Island Mars analog study is valuable in that it demonstrates actual water use values that are reasonably close to the projected figures from other studies that they serve as a terrestrial analog comparison for other modeling and analysis projections on water use (Bamsey, et al., 2009).

**Table 4.21 Typical Steady-State Water Usage Rates for Various Missions** <sup>88</sup>

Parameter	Units	Devon Island Mars Research Station Study	International Space Station	Transit Vehicle	Early Planetary Base	Mature Planetary Base
Drinking Water	kg/CM-d	2.59	2.00 <sup>(2)</sup>	2.00 <sup>(2)</sup>	2.00 <sup>(2)</sup>	2.00 <sup>(2)</sup>
Food Rehydration Water	kg/CM-d	1.03	0.50 <sup>(2)</sup>	0.50 <sup>(2)</sup>	0.50 <sup>(2)</sup>	0.50 <sup>(2)</sup>
<i>Total Human Consumption</i>	<i>kg/CM-d</i>	<i>3.62</i>	<i>2.50</i>	<i>2.50</i>	<i>2.50</i>	<i>2.50</i>
Urinal Flush	kg/CM-d	0	0.30 <sup>(1)</sup>	0.30 <sup>(1)</sup>	0.50 <sup>(2)</sup>	0.50 <sup>(2)</sup>
Personal Hygiene	kg/CM-d	0.46 <sup>(4)</sup>	0.4 <sup>(2)</sup>	0.4 <sup>(2)</sup>	0.4 <sup>(2)</sup>	0.4 <sup>(2)</sup>
Hand Wash	kg/CM-d	0.64	n/a	n/a		
Shaving	kg/CM-d	0.05				
Medical water			5 kg plus 0.5 kg/CM-d <sup>(2)</sup>	5 kg plus 0.5 kg/CM-d <sup>(2)</sup>	5 kg plus 0.5 kg/CM-d <sup>(2)</sup>	5 kg plus 0.5 kg/CM-d <sup>(2)</sup>
Cleaning Science & Engineering	kg/CM-d	0.08				
Shower <sup>89</sup>	kg/CM-d	1.08	n/a	n/a	1.08 <sup>(6)</sup>	1.08 <sup>(6)</sup>
Laundry	kg/CM-d	1.95	n/a	n/a	n/a	1.8 <sup>(5)</sup>
Dish Wash	kg/CM-d	3.54	n/a	n/a	n/a	3.54 <sup>(6)</sup>
<i>Total Hygiene Consumption</i>	<i>kg/CM-d</i>	<i>7.80</i>	<i>0.7</i>	<i>0.7</i>	<i>1.98</i>	<i>7.32</i>
Payload	kg/CM-d		2.18 <sup>(1)</sup>	TBD <sup>(3)</sup>	TBD <sup>(3)</sup>	TBD <sup>(3)</sup>
<i>Total Payload Consumption</i>	<i>kg/CM-d</i>		<i>2.18</i>			
<b><i>Total Water Consumption</i></b>	<b><i>kg/CM-d</i></b>	<b><i>11.42</i></b>	<b><i>4.85</i></b>	<b><i>3.17</i></b>	<b><i>10.17</i></b>	<b><i>28.08</i></b>
Biomass Production Water Consumption <sup>90</sup>	kg/m <sup>2</sup> •d	0.10 <sup>91</sup>	n/a	n/a	n/a	4.00

**References**

- <sup>(1)</sup> NASA (2004)
- <sup>(2)</sup> NASA HIDH (2014)  
Values assumed for all future missions. Additional water is specified for pre-landing and post-landing.
- <sup>(3)</sup> Architecture dependent.
- <sup>(4)</sup> oral hygiene
- <sup>(5)</sup> Ewert & Jeng (2015)
- <sup>(6)</sup> Assume Devon Island value

<sup>88</sup> Note that additional water may enter the system through moist food and metabolically generated water.

<sup>89</sup> Assuming Devon Island value.

<sup>90</sup> The water quality may differ from the standards for crew use for water provided to plants as nutrient solution. In fact, plants might provide some water reclamation functions even while providing raw agricultural products.

<sup>91</sup> The Devon Island study uses units of kg/CM-d for biomass water consumption.

**Table 4.22 Typical Steady-State Wastewater Generation Rates for Various Missions**

Parameter	Units	International Space Station	Transit Vehicle	Early Planetary Base	Mature Planetary Base	References
Urine	kg/CM-d	1.20 <sup>(1)</sup>	1.50 <sup>(2)</sup>	1.50 <sup>(2)</sup>	1.50 <sup>(2)</sup>	<sup>(1)</sup> NASA (2004) <sup>(2)</sup> NASA (1991) <sup>(3)</sup> Architecture dependent.
Urinal Flush	kg/CM-d	0.30 <sup>(1)</sup>	0.30 <sup>(1)</sup>	0.50 <sup>(2)</sup>	0.50 <sup>(2)</sup>	
<i>Total Urine Wastewater Load</i>	<i>kg/CM-d</i>	<i>1.50</i>	<i>1.80</i>	<i>2.00</i>	<i>2.00</i>	
Oral Hygiene	kg/CM-d	n/a	n/a	0.37 <sup>(2)</sup>	0.37 <sup>(2)</sup>	
Hand Wash	kg/CM-d	n/a	n/a	4.08 <sup>(2)</sup>	4.08 <sup>(2)</sup>	
Shower <sup>92</sup>	kg/CM-d	n/a	n/a	2.72 <sup>(2)</sup>	2.72 <sup>(2)</sup>	
Laundry	kg/CM-d	n/a	n/a	n/a	11.87 <sup>(2)</sup>	
Dish Wash	kg/CM-d	n/a	n/a	n/a	5.41 <sup>(2)</sup>	
Food Preparation and Processing	kg/CM-d	n/a	n/a	n/a	TBD	
<i>Total Hygiene Wastewater Load</i>	<i>kg/CM-d</i>	<i>0.00</i>	<i>0.00</i>	<i>7.17</i>	<i>24.45+</i>	
Crew Latent Humidity Condensate	kg/CM-d	2.27 <sup>(2)</sup>	2.27 <sup>(2)</sup>	2.27 <sup>(2)</sup>	2.90 <sup>(2)</sup>	
Animal Latent Humidity Condensate	kg/CM-d	n/a	n/a	TBD	TBD	
<i>Total Latent Wastewater Load</i>	<i>kg/CM-d</i>	<i>2.27</i>	<i>2.27</i>	<i>2.27+</i>	<i>2.90+</i>	
Payload	kg/CM-d	n/a	n/a	TBD <sup>(3)</sup>	TBD <sup>(3)</sup>	
<i>Total Payload Wastewater Load</i>	<i>kg/CM-d</i>	<i>0.00</i>	<i>0.00</i>	<i>0.00+</i>	<i>0.00+</i>	
<b><i>Total Wastewater Load</i></b>	<b><i>kg/CM-d</i></b>	<b><i>3.77</i></b>	<b><i>4.07</i></b>	<b><i>11.44+</i></b>	<b><i>29.35+</i></b>	
Biomass Production Wastewater <sup>93</sup>	kg/m <sup>2</sup> •d	n/a	n/a	n/a	TBD	

#### 4.2.2 WASTEWATER COMPONENT CONTAMINANT LOADING

Studies by Carter (1998) and Putnam (1971) provide the data for Table 4.23 through Table 4.28, which presents wastewater stream, aqueous contaminant loadings. Work by Carter (1998) focuses on anticipated wastewater streams from ISS systems to aid sizing the ISS water processor. Thus, some contaminants, especially those associated with ISS cleansing agents in the originally planned shower (Table 4.25) and hygiene (Table 4.26) streams may be unique to the ISS. Likewise, wastes listed for the EMU (Table 4.23) are specific to equipment employed by the Space Shuttle Program and ISS Program. However, such loadings are likely representative. Work by Putnam (1971) characterized only human urine. The corresponding values given by Carter (1998) for urine reflect the urine processor product stream, as passed to the other ISS water processing equipment, and not an untreated urine stream.

Table 4.23 through Table 4.28 have a similar formats. The first column of each table provides the contaminant name. When the common name differs from International Union of Pure and Applied Chemistry (IUPAC) nomenclature, the IUPAC name appears in brackets. The next two columns, when checked with an “x,” identify those compounds in the wastewater stream that are defined as either controlled inorganic compounds (CI) for potable water streams or have an associated SMAC for the cabin atmosphere.<sup>94</sup> The molecular weight (MW) and percent carbon are listed next. The loading density provides the concentration in

<sup>92</sup> Assuming one shower per two days. ISS does not have a shower despite early space station plans for that capability.

<sup>93</sup> The water quality may differ from the standards for crew use for water provided to plants as nutrient solution. In fact, plants might provide some water reclamation functions even while providing raw agricultural products.

<sup>94</sup> See ELS RD (2008) for CI and SMAC requirements.

milligrams of contaminant per liter of wastewater stream. Finally, the last column provides the percentage of the specific contaminant with respect to the total contaminant loading.

Each table is organized in order of descending concentration, or loading density. Those components in aggregate comprising less than 5% of the total contaminant loading, or trace components, are listed below the thick line near the bottom of each table. Trace components that are CI or have a SMAC are listed individually whereas all other trace components are listed under the generic heading of “constituents totaling less than 5%.”

Table 4.23 details the anticipated aqueous contaminants in the greywater stream from an EMU. This stream reflects Space Shuttle or ISS Program technology, so a similar stream for an advanced spacesuit may differ. Carter (1998) developed this list based on the ISS Program.

**Table 4.23 Wastewater Contaminants in EMU Stream**

<b>Component</b>	<b>C I</b>	<b>S M A C</b>	<b>MW</b>	<b>Percent Carbon [%C]</b>	<b>Concentration [mg/L]</b>	<b>Percent of Total Contam- inants [%]</b>
acetone [2-propanone]		x	58.1	62.0	0.0256	34.4
caprolactam			113.2	63.7	0.0227	30.6
Freon 113 [1,1,2-trichloro-1,2,2-trifluoroethane]	x	x	187.4	12.8	0.0108	14.5
ethylene glycol [1,2-ethandiol]		x	62.1	38.7	0.0035	4.7
tetraoxadodecane [2,5,8,11-tetraoxadodecane]			178.2	53.9	0.0035	4.7
tetradecanol [1-tetradecanol]			214.4	78.4	0.0029	3.9
sulfolane [tetrahydrothiophene-1,1-dioxide]			120.2	40.0	0.0020	2.7
<i>constituents totaling less than 5%</i>					<i>0.0029</i>	<i>3.9</i>
<i>benzene</i>		x	<i>78.1</i>	<i>92.3</i>	<i>0.0002</i>	<i>0.3</i>
<i>toluene</i>		x	<i>92.1</i>	<i>91.2</i>	<i>0.0002</i>	<i>0.3</i>
<b>Total</b>					<b>0.0742</b>	<b>100</b>

Table 4.24 lists the anticipated contaminants from the latent condensate derived from the crew cabin. Carter (1998) developed this list based on the ISS Program.



**Table 4.24 Wastewater Contaminants in Crew Latent Condensate**

Component	C I	S M A C	MW	Percent Carbon [%C]	Concentration [mg/L]	Percent of Total Contam- inants [%]
2-propanol		x	60.1	60.0	46.297	18.6
1,2 propanediol			76.1	47.4	45.234	18.2
bicarbonate			61.0	19.7	33.170	13.3
acetic acid [ethanoic acid]		x	60.1	40.0	14.614	5.9
ammonium	x		18.0	0.0	13.527	5.4
caprolactam			113.2	63.7	11.834	4.8
ethylene glycol [1,2-ethandiol]		x	62.1	38.7	10.224	4.1
glycolic acid [hydroxy acetic acid]			76.1	31.6	10.194	4.1
ethanol		x	46.1	52.1	8.181	3.3
formaldehyde [methanal]		x	30.0	40.0	8.136	3.3
formic acid [methanoic acid]			46.0	26.1	7.239	2.9
propanoic acid			74.1	48.6	3.916	1.6
methanol		x	32.0	37.5	3.737	1.5
lactic acid [2-hydroxy-propanoic acid]			90.1	40.0	3.079	1.2
4-ethyl morpholine			115.2	62.6	2.516	1.0
urea			60.1	20.0	2.415	1.0
chloride	x		35.5	0.0	1.465	0.6
4-hydroxy-4-methyl-2-pentanone			116.2	62.0	1.247	0.5
2-butoxyethoxy-ethanol			162.2	59.2	1.130	0.5
4-acetyl morpholine			129.2	55.8	1.092	0.4
1-butanol		x	74.1	64.8	0.937	0.4
2-butoxyethanol			118.2	61.0	0.803	0.3
carbon disulfide	x	x	76.1	15.8	0.785	0.3
octanoic acid			144.2	66.6	0.665	0.3
zinc	x		65.4	0.0	0.650	0.3
N,N-dimethylformamide [N,N-dimethyl formic acid amide]			73.1	49.3	0.608	0.2
total protein			3,206.3	53.0	0.600	0.2
hexanoic acid			116.2	62.0	0.582	0.2
isocitric acid [1-hydroxy-1,2,3-propanetricarboxylic acid]			192.1	37.5	0.576	0.2
dibutyl amine			129.2	74.3	0.566	0.2
potassium	x		39.1	0.0	0.542	0.2
<i>constituents totaling less than 5%</i>					<i>9.546</i>	<i>3.8</i>
<i>nitrite</i>	x		<i>46.0</i>	<i>0.0</i>	<i>0.517</i>	<i>0.2</i>
<i>2-ethoxyethanol</i>		x	<i>90.1</i>	<i>53.3</i>	<i>0.504</i>	<i>0.2</i>
<i>acetone [2-propanone]</i>		x	<i>58.1</i>	<i>62.0</i>	<i>0.348</i>	<i>0.1</i>
<i>magnesium</i>	x		<i>24.3</i>	<i>0.0</i>	<i>0.282</i>	<i>0.1</i>
<i>phenol</i>		x	<i>94.1</i>	<i>76.6</i>	<i>0.204</i>	<i>0.1</i>
<i>silver</i>	x		<i>107.9</i>	<i>0.0</i>	<i>0.200</i>	<i>0.1</i>
<i>acetaldehyde [ethanal]</i>		x	<i>44.1</i>	<i>54.5</i>	<i>0.098</i>	<i>0.0</i>
<i>cyclohexanone</i>		x	<i>98.1</i>	<i>73.4</i>	<i>0.089</i>	<i>0.0</i>
<i>nickel</i>	x		<i>58.7</i>	<i>0.0</i>	<i>0.087</i>	<i>0.0</i>
<i>acetophenone</i>		x	<i>120.2</i>	<i>80.0</i>	<i>0.083</i>	<i>0.0</i>
<i>calcium</i>	x		<i>40.1</i>	<i>0.0</i>	<i>0.060</i>	<i>0.0</i>
<i>sulfate</i>	x		<i>96.1</i>	<i>0.0</i>	<i>0.052</i>	<i>0.0</i>
<i>methylene chloride [dichloromethane]</i>	x	x	<i>84.9</i>	<i>14.1</i>	<i>0.050</i>	<i>0.0</i>
<i>manganese</i>	x		<i>54.9</i>	<i>0.0</i>	<i>0.035</i>	<i>0.0</i>
<i>methyl ethyl ketone [2-butanone]</i>		x	<i>72.1</i>	<i>66.6</i>	<i>0.023</i>	<i>0.0</i>
<i>iron</i>	x		<i>55.9</i>	<i>0.0</i>	<i>0.008</i>	<i>0.0</i>
<i>tetrachloroethene</i>	x	x	<i>165.8</i>	<i>14.5</i>	<i>0.005</i>	<i>0.0</i>
<i>copper</i>	x		<i>63.6</i>	<i>0.0</i>	<i>0.004</i>	<i>0.0</i>
<i>isobutyl methyl ketone [4-methyl-2-pentanone]</i>		x	<i>100.2</i>	<i>72.0</i>	<i>0.002</i>	<i>0.0</i>
<i>cadmium</i>	x		<i>112.4</i>	<i>0.0</i>	<i>0.001</i>	<i>0.0</i>
<i>lead</i>	x		<i>207.2</i>	<i>0.0</i>	<i>0.001</i>	<i>0.0</i>
<i>toluene</i>		x	<i>92.1</i>	<i>91.2</i>	<i>0.001</i>	<i>0.0</i>
<i>ethyl benzene</i>		x	<i>106.2</i>	<i>90.5</i>	<i>trace</i>	<i>0.0</i>
<i>benzene</i>		x	<i>78.1</i>	<i>92.3</i>	<i>trace</i>	<i>0.0</i>
<i>chloroform [trichloromethane]</i>	x	x	<i>119.4</i>	<i>10.1</i>	<i>trace</i>	<i>0.0</i>
<b>Total</b>					<b>248.76</b>	<b>100</b>

Table 4.25 details the contaminants from a potential crew shower stream. Depending on the actual cleansing agent employed, actual components in a shower greywater stream may vary. Carter (1998) developed this list based on early space station plans. Verostko, *et al.* (1989) and Wydeven and Golub (1990) also provide crew shower greywater models. Sodium coconut acid-n-methyl taurate is the major surfactant component of the cleanser originally planned for the space station. If a different cleansing agent is used, this component would be replaced with the major components of the new cleanser.

**Table 4.25 Wastewater Contaminants in Crew Shower Stream**

Component	C I	S M A C	MW	Percent Carbon [%C]	Concentration [mg/L]	Percent of Total Contam- inants [%]
sodium coconut acid-n-methyl taurate			341.0	58.0	449.96	47.6
chloride	x		35.5	0.0	106.54	11.3
sodium			23.0	0.0	106.10	11.2
bicarbonate			61.0	19.7	39.10	4.1
total protein			3,206.3	53.0	36.77	3.9
urea			60.1	20.0	36.15	3.8
acetic acid [ethanoic acid]		x	60.1	40.0	30.11	3.2
propanoic acid			74.1	48.6	30.00	3.2
lactic acid [2-hydroxy-propanoic acid]			90.1	40.0	24.16	2.6
potassium	x		39.1	0.0	17.50	1.9
ammonium	x		18.0	0.0	16.80	1.8
sulfate	x		96.1	0.0	12.33	1.3
<i>constituents totaling less than 5%</i>					32.39	3.4
<i>ethanol</i>		x	46.1	52.1	3.08	0.3
<i>ethylene glycol [1,2-ethandiol]</i>		x	62.1	38.7	2.51	0.3
<i>methanol</i>		x	32.0	37.5	0.90	0.1
<i>phenol</i>		x	94.1	76.6	0.37	0.0
<i>acetone [2-propanone]</i>		x	58.1	62.0	0.21	0.0
<i>formaldehyde [methanal]</i>		x	30.0	40.0	0.10	0.0
<i>propionaldehyde [propanal]</i>		x	58.1	62.0	0.09	0.0
<b>Total</b>					<b>945.2</b>	<b>100</b>

Table 4.26 details the contaminants from a crew hygiene stream derived from hand and oral cleansing operations. Depending on the actual cleansing agent employed, actual components in a hygiene greywater stream may vary. Carter (1998) developed this list based on early space station plans. Wydeven and Golub (1990) also provides a crew hygiene greywater model. As in Table 4.25, Table 4.26 assumes the use of a cleanser based on sodium coconut acid-n-methyl taurate. If a different cleansing agent is used, this component would be replaced with the major components of the new cleanser.

**Table 4.26 Wastewater Contaminants in Crew Hygiene Stream**

Component	C I	S M A C	MW	Percent Carbon [%C]	Concentration [mg/L]	Percent of Total Contam- inants [%]
sodium coconut acid-n-methyl taurate			341.0	58.0	638.85	62.8
sodium chloride	x		23.0	0.0	85.00	8.3
lactic acid [2-hydroxy-propanoic acid]			35.5	0.0	76.12	7.5
acetic acid [ethanoic acid]		x	90.1	40.0	34.34	3.4
total protein			60.1	40.0	28.59	2.8
bicarbonate			3,206.3	53.0	25.04	2.5
sulfate	x		61.0	19.7	24.44	2.4
formic acid [methanoic acid]			96.1	0.0	11.09	1.1
potassium propanoic acid	x		46.0	26.1	11.05	1.1
ethanol		x	39.1	0.0	10.78	1.1
phosphate			74.1	48.6	9.56	0.9
<i>constituents totaling less than 5%</i>			46.1	52.1	8.57	0.8
methanol		x	95.0	0.0	7.20	0.7
ammonium	x				32.09	3.2
ethylene glycol [1,2-ethandiol]		x	32.0	37.5	6.36	0.6
1-propanol		x	18.0	0.0	5.81	0.6
2-propanol		x	62.1	38.7	1.58	0.2
phenol		x	60.1	60.0	0.58	0.1
dimethyl disulfide	x		60.1	60.0	0.26	0.0
acetone [2-propanone]		x	94.1	76.6	0.16	0.0
pentane		x	94.2	25.5	0.13	0.0
formaldehyde [methanal]		x	58.1	62.0	0.09	0.0
propionaldehyde [propanal]		x	72.2	83.2	0.09	0.0
1-butanol		x	30.0	40.0	0.07	0.0
dimethyl sulfide	x	x	58.1	62.0	0.05	0.0
carbon disulfide	x	x	74.1	64.8	0.05	0.0
<b>Total</b>					<b>1,018.0</b>	<b>100</b>

Table 4.27 lists the composition of unprocessed urine as derived from the human metabolic process. The reference is Putnam (1971). For more recent information on calcium in urine issues during space flight, see Smith (2012) and Smith (2014).

**Table 4.27 Wastewater Contaminants in Crew Urine Stream**

Component	C I	S M A C	MW	Percent Carbon [%C]	Concentration [mg/L]	Percent of Total Contam- inants [%]
urea			60.1	20.0	13,400	36.2
sodium chloride	x		58.4	0.0	8,001	21.6
potassium sulfate	x		174.3	0.0	2,632	7.1
potassium chloride	x		74.6	0.0	1,641	4.4
creatinine			113.1	42.5	1,504	4.1
ammonium hippurate	x		196.2	55.1	1,250	3.4
magnesium sulfate	x		120.4	0.0	783	2.1
ammonium nitrate	x		80.0	0.0	756	2.0
ammonium glucuronate	x		211.2	34.1	663	1.8
potassium bicarbonate	x		100.1	12.0	661	1.8
ammonium urate	x		185.1	32.4	518	1.4
ammonium lactate	x		107.1	33.6	394	1.1
uropepsin (as tyrosine)			181.2	59.7	381	1.0
creatine			131.1	36.6	373	1.0
glycine			75.1	32.0	315	0.9
phenol		x	94.1	76.6	292	0.8
ammonium L-glutamate	x		164.2	36.3	246	0.7
potassium phosphate	x		212.3	0.0	234	0.6
histidine			155.2	46.4	233	0.6
androsterone			290.4	78.6	174	0.5
1-methylhistidine			169.2	49.7	173	0.5
glucose			180.2	40.0	156	0.4
imidazole			68.1	52.9	143	0.4
magnesium carbonate	x		84.3	14.2	143	0.4
taurine [2-aminoethanesulfonic acid]			125.1	19.2	138	0.4
<i>constituents totaling less than 5%</i>					<i>1,487</i>	<i>4.0</i>
<i>ammonium aspartate</i>	x		<i>150.1</i>	<i>32.0</i>	<i>135</i>	<i>0.4</i>
<i>ammonium formate</i>	x		<i>63.1</i>	<i>19.0</i>	<i>88</i>	<i>0.2</i>
<i>calcium phosphate</i>	x		<i>310.2</i>	<i>0.0</i>	<i>62</i>	<i>0.2</i>
<i>ammonium pyruvate</i>	x		<i>105.1</i>	<i>34.3</i>	<i>44</i>	<i>0.1</i>
<i>ammonium oxalate</i>	x		<i>124.1</i>	<i>19.4</i>	<i>37</i>	<i>0.1</i>
<b>Total</b>					<b>37,057</b>	<b>100</b>

Table 4.28 lists the anticipated contaminants from the latent condensate derived from experimental animals. Carter (1998) developed this list based on the ISS Program.

**Table 4.28 Wastewater Contaminants in Animal Latent Condensate**

Component	C I	S M A C	MW	Percent Carbon [%C]	Concentration [mg/L]	Percent of Total Contam- inants [%]
ammonium	x		18.0	0.0	581.88	81.9
acetic acid [ethanoic acid]		x	60.1	40.0	33.58	4.7
2-propanol		x	60.1	60.0	14.76	2.1
acetone [2-propanone]		x	58.1	62.0	14.69	2.1
phosphate			95.0	0.0	12.09	1.7
glycerol [1,2,3-propanetriol]			92.1	39.1	11.23	1.6
total protein			3,206.3	53.0	8.81	1.2
<i>constituents totaling less than 5%</i>					16.36	2.3
potassium	x		39.1	0.0	5.07	0.7
ethylene glycol [1,2-ethandiol]		x	62.1	38.7	4.18	0.6
sulfate	x		96.1	0.0	1.47	0.2
methanol		x	32.0	37.5	1.25	0.2
nitrate	x		62.0	0.0	0.87	0.1
chloride	x		35.5	0.0	0.74	0.1
calcium	x		40.1	0.0	0.74	0.1
2-butanol		x	74.1	64.8	0.60	0.1
magnesium	x		24.3	0.0	0.56	0.1
barium	x		137.3	0.0	0.53	0.1
zinc	x		65.4	0.0	0.41	0.1
acetaldehyde [ethanal]		x	44.1	54.5	0.33	0.0
formaldehyde [methanal]		x	30.0	40.0	0.12	0.0
nickel	x		58.7	0.0	0.08	0.0
copper	x		63.6	0.0	0.07	0.0
phenol		x	94.1	76.6	0.04	0.0
arsenic	x		74.9	0.0	0.03	0.0
iron	x		55.9	0.0	0.02	0.0
silver	x		107.9	0.0	0.01	0.0
manganese	x		54.9	0.0	0.01	0.0
<b>Total</b>					<b>710.55</b>	<b>100</b>

#### 4.2.3 WASTEWATER AND INTERMEDIATE WATER SYSTEM SOLUTION FORMULATIONS FOR TESTING

Formulations for standardized wastewater solutions for developmental hardware are presented in (Verostko and Carrier, 2006). Verostko (2009) defined formulations of wastewater streams in spacecraft closed-loop life support systems. The document includes procedures to prepare ersatz wastewaters of urine, humidity condensate, and hygiene. The urine ersatz consists of 21 organic compounds and 7 inorganic salts. The document summarizes minimum, average, and maximum physiological values of major urinary constituents. The humidity condensate ersatz consists of 26 ingredients for a total organic concentration, total organic carbon (TOC) of 453 mg/L and 5 inorganic compounds with a total concentration of 131 mg/L. Approximately 90% of TOC is attributed to ten organic compounds with concentrations greater than 10 mg-TOC/L. The major inorganic constituent in humidity condensate is ammonium bicarbonate at a concentration of 125 mg/L.

### 4.3 WASTE SUBSYSTEM

The Waste Subsystem collects waste materials from life support subsystems and interfaces. Commonly, wastes are perceived as materials that have no further utility. However, because of the need for increased material loop closure for exploration missions, “wastes” encompass a variety of materials with varying degrees of possible future utility. Wastes might include crew metabolic wastes, food packaging, wasted food, paper, tape, soiled clothing, brines, inedible biomass, expended hygiene supplies, and equipment replacement parts from the other subsystems. The traditional definition of a waste within this document excludes most gases,

depending on the system configuration. For example, crew-expelled carbon dioxide might not be recycled within a given life support system architecture. In such a case, although carbon dioxide is technically a waste material, the Air Subsystem typically assumes the responsibility for waste gases. However, the Waste Subsystem might ultimately collect the expended carbon dioxide scrubbing materials and trapped gases if those gases are not vented. Subsystem definitions can be somewhat blurry. For example, a waste-processing device might incorporate off-gassing contaminant control hardware, which is usually an Air Subsystem function, to control the release of potentially harmful gases. When the waste system incorporates it, it is referred to as Source Contamination Control (SCC). When the function is provided by the Air Subsystem, it is referred to as Trace Contamination Control (TCC). Further information related to waste types and characteristics are included below.

Wastes sent to the Waste Subsystem may be handled in many ways. Wastes accepted by the Waste Subsystem may be collected, immediately prepared for short-term or long-term storage, processed to recover resources, processed to render them safe for disposal, and/or disposed of, depending on the mission-specific requirements and constraints. The mission requirements and constraints consider cost, safety, planetary protection if applicable, integration with other subsystems, resource recovery, and any other pertinent issues defined for a specific vehicle or habitat.

Current NASA spacecraft waste-handling approaches rely on venting and/or storage. On Shuttle missions, most waste was stored and returned to Earth with little or no processing. Consequently, the volume of wastes was significant. Fecal waste on the Shuttle was processed by drying fecal material via exposure to the vacuum of space as a form of SCC. Wet trash was similarly vented to space vacuum with special bags and compartments as a form of SCC. Urine and excess fuel cell water was vented to space vacuum on Shuttle missions to avoid the breakdown of urea to ammonia and to reduce reentry mass. On ISS, wastes can be returned to Earth either previously aboard the Shuttle (in the Orbiter mid-deck or, within a multi-purpose logistics module in the payload bay), or currently with a commercial cargo vehicle (such as the SpaceX Dragon). However, the majority of ISS wastes are removed using a disposable vehicle that is intentionally incinerated during reentry (i.e., Russian Progress, H-II Transfer Vehicle [HTV], Automated Transfer Vehicle [ATV], and commercial cargo vehicles).

Future long-duration mission wastes may be disposed directly like past missions. However, they are more likely to be processed (Pisharody, *et al.*, 2002; Broyan, *et al.*, 2014) with the goals of reducing microbial growth and its accompanying odors, reducing its stored volume, processed to recover oxygen or water, or partly processed and stored. For example, during transit to Mars, jettisoning trash might be acceptable, though waste might be more useful if retained for radiation shielding. Jettisoning waste on the Martian surface may be constrained by planetary protection protocols for exploration missions. Waste processing options will depend upon the mission scenario and cost/benefit ratio.

#### **4.3.1 HISTORICAL DATA ON SKYLAB**

Within the Gemini and Apollo programs, wastes were either returned to Earth in the vehicle, or dumped, most notably on the lunar surface. On Skylab, the Saturn S-IVB<sup>95</sup> oxygen tank was used as a waste storage tank. The tank was vented to space through non-propulsive vents. Wastes were placed in the tank through an airlock and off-gassed to space. This eliminated the possibility of contamination of the interior crew areas, but likely contaminated the Skylab's exterior surfaces.

#### **4.3.2 HISTORICAL WASTE LOADS FROM SPACE TRANSPORTATION SYSTEM MISSIONS**

On Shuttle missions, waste was contained and stowed for return to Earth in either "dry" trash bags, or in the volume F "wet" trash.<sup>96</sup> Waste stream characterization and water content studies were performed for each of six missions: STS-29, STS-30, STS-35, STS-51D, STS-99, and STS-101. The waste analyses for STS-29 through STS-51D were conducted to improve solid waste management for the Space Shuttle Program (Peterson 2004). The waste analyses for STS-99 and STS-101 provided data to develop a waste model to support planning for future waste handling within the Life Support Project. Some data on waste composition have also been provided from STS 122 and STS-123.

---

<sup>95</sup> The Skylab space station was fabricated from a modified Saturn S-IVB rocket stage.

<sup>96</sup> Shuttle stored trash generated within the vehicle itself in plastic bags or liners that were housed within designated storage areas on the middeck. Volume F is one such trash storage cabinet.

In 1985, wastes for STS-51D were analyzed at NASA Ames Research Center to determine the chemical composition of wastes and characterize the trash (Wydeven and Golub, 1991). This study found that for 49.2 kg of total waste, 27.8 kg was food-related trash. Approximately 22%, or 10.8 kg, of the trash recovered was comprised of food-related plastic packaging materials. Another 12.2 kg of other plastics and paper brought the total for packaging materials within the trash to almost 47%. These data are presented in Table 4.29 and summarized in Table 4.30 and is equivalent to 49 CM-d.

**Table 4.29 Waste Analysis for STS-51D Trash**

Trash Item	Mass [kg]	Moisture Content [%]	Fraction of Total Mass [%]	Reference
Food and Food Packaging				
Plate Waste	4.8	70	9.8	
Plastic Food Containers	10.8	0.2	22.0	
Uneaten Food and Beverages <sup>97</sup>	12.2	0.2	24.7	
Biomedical	6.4		13.0	
Aluminum and Tape				
Grey Duct Tape	1.6		3.3	
Aluminum Cans	1.2	2	2.4	
Plastic and Paper				
Paper (mixed)	6.4	10.2	13.0	
Plastic Bags	3.2	0.2	6.5	
Miscellaneous Plastic	2.6	0.2	5.3	
<b>Total</b>	<b>49.2</b>		<b>100.0</b>	

Storage of wastes on-orbit during early Shuttle missions of 30 CM-d or less posed no challenge for the allotted resources of the Orbiter vehicle. However, as Shuttle missions lengthened for Extended Duration Orbiter of 112 CM-d or more, the volume allocated was inadequate for the safe stowage of trash. Research to determine future waste stowage requirements for Shuttle missions was initiated in 1989 by the Personal Hygiene and Housekeeping Laboratory at Johnson Space Center. The study objectives were to determine the mass and volume of waste generated per crewmember per day, and the amount of liquid stored in trash per crewmember per day (Grounds, 1990). Trash from Shuttle missions STS-29 (Garcia, 1989), STS-30 (Garcia, 1989), and STS-35 (Grounds, 1990) were analyzed. STS-35 differed from the two previous missions because STS-35 used pouches, and not boxes, for beverages and carried a prototype trash compactor (Grounds, 1990). Thus, there is a marked decrease in the volume of trash from STS-35 compared with the previous missions, probably in large part due to the change in drink packaging. This reduction in volume was consistent with data collected for STS-99 and STS-101 (Maxwell, 2000a and 2000b). The data from these missions are summarized in Table 4.30.

Not included in the trash data for Shuttle missions are dirty laundry or life support expendables, such as filters, that return to Earth separately from the trash. STS-101 generated approximately 50 kg of dirty laundry, consisting of clothing and towels, occupying approximately 0.5 m<sup>3</sup> (Maxwell, 2000b). Laundry was returned to Earth in mesh laundry bags. Storage, stabilization, and odor control for laundry, some of it wet, will require dedicated facilities on longer-duration missions if no change is made to the current storage process. No data were available on life support system expendables for STS-101.

Table 4.30 summarizes waste stream analyses completed for STS-99 and STS-101, as well as historical data from STS-29, STS-30, STS-51D, STS-122, and STS-123.

The data from STS-122 and STS-123 were tabulated and recorded by an email by J. Villarreal in 2008.

<sup>97</sup> This value corresponds to food and drink food packages that were never opened.

### 4.3.3 SOLID WASTE MANAGEMENT FOR THE INTERNATIONAL SPACE STATION MISSION

Although limited containment and stowage planning is acceptable for Shuttle, the ISS – with its 90-day resupply – requires additional planning and controls.

**Table 4.30 Space Transportation System Crew Provision Wastes from Past Missions**

Mission	Duration [CM-d]	Trash (Solids)		Water		Reference:
		[kg /CM-d]	[m <sup>3</sup> /CM-d]	[kg /CM-d]	Percent of Total Trash (by mass) [%]	
STS-29 <sup>(1)</sup>	25	1.49	0.0139	0.345	27.35	<sup>(1)</sup> Garcia (1989)
STS-30 <sup>(1)</sup>	20	1.63	0.0133	0.417	35.35	<sup>(2)</sup> Grounds (1990)
STS-35 <sup>(2)</sup>	63	1.14	0.0067	0.218	26.80	<sup>(3)</sup> Wydeven and Golub (1991)
STS-51D <sup>(3)</sup>	49	1.01		0.096	9.61	<sup>(4)</sup> Maxwell (2000a)
STS-99 <sup>(4)</sup>	66	1.47	0.0029	0.290	19.75	<sup>(5)</sup> Maxwell (2000b)
STS-101 <sup>(5)</sup>	63	1.62	0.0041	0.439	27.09	<sup>(6)</sup> e-mail by J. Villarreal in 2008
STS-122 <sup>(6)</sup>	91	1.16	0.0120	0.211	15.3 <sup>98</sup>	
STS-123 <sup>(6)</sup>	49	1.57	0.0125	0.231	13.3 <sup>99</sup>	
Average	54	1.39	0.0093	0.281	21.82	

ISS solid waste management today is similar to that for the Russian space station Mir. Wastes are contained either in metal containers for human wastes, or plastic bags for crew provision and housekeeping wastes. Filled containers are returned to Earth by Progress, ATV, HTV, or Cygnus, which incinerate upon reentry. ISS added a urine processor to its wastewater processing system in 2009, which led to additional water recovery but also urine brine as a waste product. This brine is currently disposed of together with its container.

Calculated overall waste generation rates, according to the life support subsystem and interface categories, using data from ISS human missions, are shown in Table 4.31, for reference missions associated with ISS, and in Table 4.34, for reference missions associated with near-term exploration missions to Mars using the Mars Dual Lander Architecture. RMD (2008) details the assumed reference missions. Some data here are inferred, such as air filters. These tables present generation of storable or disposable wastes based on the assumed configurations. A common list of hardware is used for all vehicles. In cases where particular hardware is not part of the configuration for a specific reference mission, the location within the table is marked with an “x.” A “☑” appears when hardware is present, but where a storable or disposable waste is not produced. When hardware is present and a storable or disposable waste is produced, a rate, in terms of mass per crewmember per day, is listed. These tables list only wastes delivered from the hardware or elements for disposal or storage listed, including any containers. Thus, wastes should not be counted more than once.

The technology suite for segments or vehicles in Table 4.31 and Table 4.34 are denoted by prefixes. Vehicles or segments with a prefix of “ISS” assume a hardware suite using primarily technologies listed in Carrasquillo, *et al.* (1997) for the ISS. Vehicles or segments with a prefix of “ADV” use advanced technologies, as appropriate. Segments listed as Russian On-Orbit Segments of ISS use Russian ISS hardware and are provided as a reference. See RMD (2001) for details.

Possible types of waste are virtually unbounded, so Table 4.31 and Table 4.34 do not encompass all possible types of waste within a space mission. Further, the waste types are organized according to the

<sup>98</sup> Assumed the Shuttle category wet trash is 30% moisture and so the total percentage of water is 30% of wet trash mass divided by the total trash mass.

<sup>99</sup> Assumed the Shuttle category wet trash is 30% moisture and so the total percentage of water is 30% of wet trash mass divided by the total trash mass.



subsystems and interfaces defined in Section 2.4 and detailed in RMD (2001). The configurations are not unique, nor are they necessarily complete. However, they provide a documented baseline. The crew contribution to the waste stream can enter more than one subsystem or interface. For example, the crew respiration and perspiration load is first received by the life support system within the Air Subsystem, in the form of water vapor, or by the Human Accommodations Interface, on the clothing or as the result of crew hygiene maintenance such as bathing. Thus, it is difficult to account for all crew-generated wastes when they are divided between, and applied to, various subsystems until a mission is clearly defined.

The overall waste generation rates, including both Russian and United States On-Orbit Segments, listed in Table 4.31 include all currently known waste streams. This table should be a good estimate of an actual waste load for future long-duration missions. There are, however, significant gaps in the data, and the total will likely be greater than what is listed here.

**Table 4.31 International Space Station Reference Mission Vehicle Wastes**

Component	Assumptions [kg/CM-d]					Notes
	Russian Segment, Phase 2	Russian Segment, Assembly Complete	ISS United States Segment, Assembly Complete	ADV. TECH. United States Segment, Post-Phase 2	ADV. TECH. United States Segment, Assembly Complete	
<b>Waste Subsystem Hardware</b>						
Compactor	✗	✗	☑	☑	☑	Compactors reduce waste volume and waste storage containment mass
Commode	☑	☑	☑	☑	☑	
Dryer	✗	✗	✗	✗	☑	
Fecal Storage	0.50 <sup>(1)</sup>	0.50 <sup>(1)</sup>	0.50 <sup>(1)</sup>	0.50 <sup>(1)</sup>	0.13 <sup>(1)</sup>	This entry includes the Russian KTO (Russian solid waste container). Usage is based on mass of waste. Mass of waste depends on moisture content, which varies between options.
Lyophilization	✗	✗	✗	✗	✗	This technology yields a dry, stable solid waste and a separate greywater component.
Solid Waste Storage	☑	☑	☑	☑	☑	
Urine Collection	☑	☑	☑	☑	☑	
Urine Pretreatment	0.04 <sup>(2)</sup>	0.04 <sup>(2)</sup>	0.01 <sup>(2)</sup>	0.01 <sup>(2)</sup>	✗ <sup>(3)</sup>	This entry reflects chemical pretreatment, whether Russian or U.S. This is the mass of chemicals only.
<b>Subtotal</b>	<b>0.54</b>	<b>0.54</b>	<b>0.51</b>	<b>0.51</b>	<b>0.13</b>	

In cases where particular hardware is not part of the configuration for a specific reference mission, the location within the table is marked with an “✗.” When hardware is present, but a storable or disposable waste is not produced, a “☑” appears. When hardware is present and a storable or disposable waste is produced, a rate, in terms of mass per crewmember per day, is listed.

References: <sup>(1)</sup> Jones (2000); <sup>(2)</sup> Wieland (1998a and 1998b); <sup>(3)</sup> Personal Communication with M. Flynn 2003; <sup>(4)</sup> Carrasquillo, et al. (1997); <sup>(5)</sup> This current document Table 4.44; <sup>(6)</sup> Lange (1998); <sup>(7)</sup> Lin (1998).

**Table 4.32 International Space Station Reference Mission Vehicle Wastes (continued)**

Component	Assumptions [kg/CM-d]					Notes
	Russian Segment, Phase 2	Russian Segment, Assembly Complete	ISS United States Segment, Assembly Complete	ADV. TECH. United States Segment, Post-Phase 2	ADV. TECH. United States Segment, Assembly Complete	
<b>Waste Subsystem Interfaces</b>						
Air Subsystem	0.13 <sup>(4)</sup>	0.13 <sup>(4)</sup>	0.13 <sup>(4)</sup>	0.13 <sup>(4)</sup>	0.13 <sup>(4)</sup>	Based on ISS data at Assembly Complete. Reflects spares for the Air Subsystem.
EVA Support Interface Wastes	0.02 <sup>(5)</sup>	0.02 <sup>(5)</sup>	0.02 <sup>(5)</sup>	0.02 <sup>(5)</sup>	0.02 <sup>(5)</sup>	The difference in values reflects variations in EVA workload.
<b>Food Interface Wastes</b>						
Prepackaged Food Wastes	0.32 <sup>(5)</sup>	0.32 <sup>(5)</sup>	0.32 <sup>(5)</sup>	0.32 <sup>(5)</sup>	0.28 <sup>(5)</sup>	Assumption: Biomass production reduces prepackaged food mass slightly.
Inedible Biomass	×	×	×	×	×	
<b>Habitation Interface Wastes</b>						
Expended Clothing			0.23 <sup>(5)</sup>	0.23 <sup>(5)</sup>	0.02 <sup>(5)</sup>	Clothing mass reduced by a factor of 40 with laundry.
Hygiene Wipes	0.23 <sup>(5)</sup>	0.23 <sup>(5)</sup>	0.23 <sup>(5)</sup>	0.23 <sup>(5)</sup>	0.15 <sup>(5)</sup>	
Thermal Interface Wastes	0.03 <sup>(4)</sup>	0.03 <sup>(4)</sup>	0.03 <sup>(4)</sup>	0.03 <sup>(4)</sup>	0.03 <sup>(4)</sup>	Based on ISS data for Assembly Complete.
<b>Waste Subsystem to Environment</b>						
Urine to Earth	1.83 <sup>(1)</sup>	0.16 <sup>(1)</sup>	×	×	×	Assumption: Stowage in EDV.
Solid Waste to Earth	☑	☑	☑	☑	☑	
Vacuum Vent (Lyophilizer)	×	×	×	×	×	Mass losses for Air and Water to be determined.
<b>Subtotal</b>	<b>3.38</b>	<b>1.71</b>	<b>1.55</b>	<b>1.55</b>	<b>0.63</b>	

In cases where particular hardware is not part of the configuration for a specific reference mission, the location within the table is marked with an “×.” When hardware is present, but a storable or disposable waste is not produced, a “☑” appears. When hardware is present and a storable or disposable waste is produced, a rate, in terms of mass per crewmember per day, is listed.

References: <sup>(1)</sup> Jones (2000); <sup>(2)</sup> Wieland (1998a and 1998b); <sup>(3)</sup> Personal Communication with M. Flynn 2003; <sup>(4)</sup> Carrasquillo, et al. (1997); <sup>(5)</sup> This current document Table 4.44; <sup>(6)</sup> Lange (1998); <sup>(7)</sup> Lin (1998).

**Table 4.33 International Space Station Reference Mission Vehicle Wastes (concluded)**

Component	Assumptions [kg/CM-d]					Notes
	Russian Segment, Phase 2	Russian Segment, Assembly Complete	ISS United States Segment, Assembly Complete	ADV. TECH. United States Segment, Post-Phase 2	ADV. TECH. United States Segment, Assembly Complete	
Water Subsystem						
Air Evaporator Wicks	x	x	x	0.08 <sup>(6)</sup>	0.04 <sup>(6)</sup>	This value includes air evaporator wicks and urine solids. Assumption: Cases with a biological water processor are 50% less massive.
Flush Water	0.00 <sup>(2)</sup>	0.00 <sup>(2)</sup>	0.00 <sup>(2)</sup>	0.00 <sup>(2)</sup>	0.00 <sup>(2)</sup>	None identified to date.
Greywater from Dryer to Water Subsystem	x	x	x	x		
Urine Processing System Brine to Waste Subsystem	x	☑	☑	x	x	
Urine to Water Subsystem	x	☑	☑	☑	☑	
Urine Processor	x	☑	0.33 <sup>(1,7)</sup>	☑	☑	This entry based on vapor compression distillation performance. Brine is stored in an EDV (Russian wastewater container).
Water Processor Spares	0.33 <sup>(4)</sup>	0.33 <sup>(4)</sup>	0.33 <sup>(4)</sup>	TBD	TBD	
Miscellaneous	0.89 <sup>(5)</sup>	0.89 <sup>(5)</sup>	0.89 <sup>(5)</sup>	0.89 <sup>(5)</sup>	0.89 <sup>(5)</sup>	Based on ISS data for Assembly Complete.
<b>Subtotal</b>	<b>1.22</b>	<b>1.22</b>	<b>1.55</b>	<b>0.97</b>	<b>0.93</b>	
<b>Overall Total</b>	<b>5.14</b>	<b>3.47</b>	<b>3.61</b>	<b>3.03</b>	<b>1.69</b>	

In cases where particular hardware is not part of the configuration for a specific reference mission, the location within the table is marked with an “x.” When hardware is present, but a storable or disposable waste is not produced, a “☑” appears. When hardware is present and a storable or disposable waste is produced, a rate, in terms of mass per crewmember per day, is listed.

References: <sup>(1)</sup> Jones (2000); <sup>(2)</sup> Wieland (1998a and 1998b); <sup>(3)</sup> Personal Communication with M. Flynn 2003; <sup>(4)</sup> Carrasquillo, et al. (1997); <sup>(5)</sup> This current document Table 4.44; <sup>(6)</sup> Lange (1998); <sup>(7)</sup> Lin (1998).

**Table 4.34 Advanced Mars Exploration Reference Mission Vehicle Wastes**

Component	Assumptions [kg/CM-d]					Notes
	ISS TECH. Mars Transit Vehicle	ISS TECH. Surface Habitat Lander	ISS TECH. Mars Decent / Ascent Lander	ADV Mars Transit Vehicle	ADV Surface Habitat Lander	
<b>Waste Subsystem Hardware</b>						
Compactor	☑	☑	✗	☑	☑	Compactors reduce waste volume and waste storage containment mass
Commode	☑	☑	☑	☑	☑	
Dryer	✗	✗	✗	✗	☑	
Fecal Storage	0.50 <sup>(1)</sup>	0.50 <sup>(1)</sup>	0.50 <sup>(1)</sup>	0.50 <sup>(1)</sup>	0.13 <sup>(1)</sup>	This entry includes the Russian KTO (Russian solid waste container). Usage is based on mass of waste. Mass of waste depends on moisture content, which varies between options.
Lyophilization	✗	✗	✗	✗	☑	This technology yields a dry, stable solid waste and a separate greywater component.
Solid Waste Storage	☑	☑	☑	☑	☑	
Urinal	☑	☑	☑	☑	☑	
Urine Pretreatment	0.01 <sup>(2)</sup>	0.01 <sup>(2)</sup>	0.01 <sup>(2)</sup>	0.01 <sup>(2)</sup>	✗ <sup>(3)</sup>	This entry reflects chemical pretreatment, whether Russian or U.S. This is the mass of pretreatment chemicals only.
<b>Subtotal</b>	<b>0.51</b>	<b>0.51</b>	<b>0.51</b>	<b>0.51</b>	<b>0.13</b>	

In cases where particular hardware is not part of the configuration for a specific reference mission, the location within the table is marked with an “✗.” When hardware is present, but a storable or disposable waste is not produced, a “☑” appears. When hardware is present and a storable or disposable waste is produced, a rate, in terms of mass per crewmember per day, is listed.

References: <sup>(1)</sup> Jones (2000); <sup>(2)</sup> Wieland (1998a and 1998b); <sup>(3)</sup> Personal Communication with M. Flynn 2003; <sup>(4)</sup> Carrasquillo, et al. (1997); <sup>(5)</sup> This current document Table 4.44; <sup>(6)</sup> Lange (1998); <sup>(7)</sup> Lin (1998).

**Table 4.35 Advanced Mars Exploration Reference Mission Vehicle Wastes (continued)**

Component	Assumptions [kg/CM-d]					Notes
	ISS TECH. Mars Transit Vehicle	ISS TECH. Surface Habitat Lander	ISS TECH. Mars Decent / Ascent Lander	ADV Mars Transit Vehicle	ADV Surface Habitat Lander	
<b>Waste Subsystem Interfaces</b>						
Air Subsystem	0.13 <sup>(4)</sup>	0.13 <sup>(4)</sup>	0.13 <sup>(4)</sup>	0.13 <sup>(4)</sup>	0.13 <sup>(4)</sup>	Based on ISS data at Assembly Complete. Reflects spares for the Air Subsystem.
Extravehicular Activity Support Interface Wastes	×	0.25 <sup>(5)</sup>	0.25 <sup>(5)</sup>	×	0.25 <sup>(5)</sup>	The difference in values reflects variations in EVA workload.
<b>Food Interface Wastes</b>						
Prepackaged Food + Packaging Wastes	0.36 <sup>(5)</sup>	0.36 <sup>(5)</sup>	0.36 <sup>(5)</sup>	0.36 <sup>(5)</sup>	0.32	Assumption: Biomass production reduces prepackaged food mass slightly.
Inedible Biomass	×	×	×	0.01	0.01	Estimates assume 1 m <sup>2</sup> of growing area producing 0.1 kg/d fresh biomass with at 90% harvest index and 90% moisture content.
<b>Habitation Interface Wastes</b>						
Expended Clothing	0.23 <sup>(5)</sup>	0.23 <sup>(5)</sup>	0.23 <sup>(5)</sup>	0.2	0.02 <sup>(5)</sup>	Clothing mass reduced by a factor of 10 with laundry.
Hygiene Wipes	0.23 <sup>(5)</sup>	0.23 <sup>(5)</sup>	0.23 <sup>(5)</sup>	0.23 <sup>(5)</sup>	0.15 <sup>(5)</sup>	
Thermal Interface Wastes	0.03 <sup>(4)</sup>	0.03 <sup>(4)</sup>	0.03 <sup>(4)</sup>	0.03 <sup>(4)</sup>	0.03 <sup>(4)</sup>	Based on ISS data for Assembly Complete.
<b>Waste Subsystem to Environment</b>						
Urine to Earth	×	×	×	×	×	Assumption: Stowage in EDV.
Solid Waste to Earth	×	×	×	×	×	
Vacuum Vent (Lyophilizer)	×	×	×	×	☑	Mass losses for Air and Water to be determined.
<b>Subtotal</b>	<b>1.53</b>	<b>1.78</b>	<b>1.78</b>	<b>0.74</b>	<b>0.87</b>	

In cases where particular hardware is not part of the configuration for a specific reference mission, the location within the table is marked with an “×.” When hardware is present, but a storable or disposable waste is not produced, a “☑” appears. When hardware is present and a storable or disposable waste is produced, a rate, in terms of mass per crewmember per day, is listed.

References: <sup>(1)</sup> Jones (2000); <sup>(2)</sup> Wieland (1998a and 1998b); <sup>(3)</sup> Personal Communication with M. Flynn 2003; <sup>(4)</sup> Carrasquillo, et al. (1997); <sup>(5)</sup> This current document Table 4.44; <sup>(6)</sup> Lange (1998); <sup>(7)</sup> Lin (1998).

**Table 4.36 Advanced Mars Exploration Reference Mission Vehicle Wastes (concluded)**

Component	Assumptions [kg/CM-d]					Notes
	ISS TECH. Mars Transit Vehicle	ISS TECH. Surface Habitat Lander	ISS TECH. Mars Decent / Ascent Lander	ADV Mars Transit Vehicle	ADV Surface Habitat Lander	
Water Subsystem						
Air Evaporator Wicks	x	x	x	0.08 <sup>(6)</sup>	0.04 <sup>(6)</sup>	This value includes air evaporator wicks and urine solids. Assumption: Cases with a biological water processor are 50% less massive.
Flush Water	0.00 <sup>(2)</sup>	0.00 <sup>(2)</sup>	0.00 <sup>(2)</sup>	0.00 <sup>(2)</sup>	0.00 <sup>(2)</sup>	None identified to date.
Greywater from Dryer to Water Subsystem	x	x	x	x	☑	
Urine Processing System Brine to Waste Subsystem	☑	☑	x	x	x	
Urine to Water Subsystem	☑	☑	☑	☑	☑	
Urine Processor	0.33 <sup>(1,7)</sup>	0.33 <sup>(1,7)</sup>	x	0.33 <sup>(1,7)</sup>	☑	This entry based on vapor compression distillation performance. Brine is stored in an EDV (Russian wastewater container).
Water Processor Spares	TBD	TBD	TBD	TBD	TBD	
Miscellaneous	0.89 <sup>(5)</sup>	0.89 <sup>(5)</sup>	0.89 <sup>(5)</sup>	0.89 <sup>(5)</sup>	0.89 <sup>(5)</sup>	Based on ISS data for Assembly Complete.
<b>Subtotal</b>	<b>1.22</b>	<b>1.22</b>	<b>0.89</b>	<b>1.30</b>	<b>0.93</b>	
<b>Overall Total</b>	<b>3.26</b>	<b>3.51</b>	<b>3.18</b>	<b>2.55</b>	<b>1.93</b>	

In cases where particular hardware is not part of the configuration for a specific reference mission, the location within the table is marked with an “x.” When hardware is present, but a storable or disposable waste is not produced, a “☑” appears. When hardware is present and a storable or disposable waste is produced, a rate, in terms of mass per crewmember per day, is listed.

References: <sup>(1)</sup> Jones (2000); <sup>(2)</sup> Wieland (1998a and 1998b); <sup>(3)</sup> Personal Communication with M. Flynn 2003; <sup>(4)</sup> Carrasquillo, et al. (1997); <sup>(5)</sup> This current document Table 4.44; <sup>(6)</sup> Lange (1998); <sup>(7)</sup> Lin (1998).

#### **4.3.4 SOLID WASTE MANAGEMENT FOR FUTURE LONG-DURATION MISSIONS**

Waste treatment and removal for missions to Mars and other likely near-term destinations will be more challenging due to the longer mission duration, regardless of complications from the environment. Waste management for such missions may employ more efficient versions of technologies developed for Shuttle and ISS, or completely different approaches may be more cost effective. Future missions will also generate significant amounts of inedible biomass. In later or far-term missions, inedible biomass may dominate all other waste sources. See Table 4.100 for example, and refer to Section 4.13. Finally, depending on the mission protocols, indefinite stable storage for the end products of any waste-processing scheme will be necessary.

Historically, wastes generated during human space flight are materials with no further utility requiring only storage until mission's end. However, Exploration Waste Subsystems may reclaim resources from input wastes allowing greater closure within the overall life support system. It is also plausible that wastes from previous missions could be processed for useful resources on subsequent missions as additional technologies become available during accumulation of infrastructure.

The following tables provide data for various waste products, organized with references. Though not listed here, waste volumes can be significant. Further, although wastes are listed separately below, some wastes may be contained in or associated with other wastes. For example, feces may adhere to toilet paper, waste food may adhere to corresponding food packaging, and miscellaneous body wastes may adhere to hygiene wipes and dissolve or suspend in hygiene water. Also, various degrees of source separation are possible. For example, contaminated toilet paper might be collected in a container separate from the feces collector, or contaminated food packages might be collected separately from waste food.

These tables do not list all possible waste types for human space flight. Because many spacecraft systems routinely replace parts during scheduled maintenance on long-duration missions, a comprehensive list of wastes is contingent upon the hardware and configurations used throughout the vehicle. Thus, for a full understanding of equipment-related wastes during a particular mission, the replaceable units for each piece of hardware must be known, including any associated packaging. Rather, the tables list the wastes that are commonly of interest to advanced waste technology developers, due to an anticipated presence or processing potential. Processing potential may be related to resource recovery potential and anticipated pre-disposal treatment requirements. The tables list materials that have historically been sent to the Waste Subsystem. Thus, wastes such as carbon dioxide gas and trace gas contaminants are not included here.

As noted above, most wastes depend upon the life support system or vehicle design. For example, the rate of clothing supply and associated waste generation depends on the presence of a laundry system. The rate waste is generated from food packaging depends on the degree of food bioregeneration, or crop growth, within the vehicle. Further, the quantity and composition of metabolic wastes depend on the composition and quantity of food consumed; greater metabolic demands and greater consumption of dietary fiber may alter the generation rate for feces.

The tables present several mass values for some wastes. In such cases, an asterisk denotes the "preferred" or suggested value for waste models if there is an appropriate entry for that particular waste with other important defining factors about the waste being unknown. The suggested values are also summarized in Table 4.37. The variability between sources is somewhat indicative of the variability in data collection methods. When known, the data variability is provided below. Additionally, when known, variation of waste mass and composition with particular environmental parameters are noted, allowing for customization of waste characteristics for a specific purpose. The degree of confidence in data values is highly variable and often unknown. In some cases, data have not been diligently collected, and mass estimates are included. In other cases, the values are contingent upon environmental variables. Finally, the original or earliest data source available for a particular value is listed first, followed by other sources that reference the earliest source.



**Table 4.37 Summary Information on Wastes for Developing Waste Models for Future Long-Duration Missions <sup>100</sup>**

Waste	Assumptions [g/CM-d]		
	lower	Nominal	upper
Equipment Wastes		TBD <sup>(1)</sup>	
Experiment Wastes		TBD <sup>(1)</sup>	
Extravehicular Activity Maximum Absorption Garments (MAGs) <sup>101</sup>		173 <sup>(1) 89</sup>	
Feminine Wastes: <sup>102</sup>			
Menstrual Hygiene Products		104 <sup>(2) 90</sup>	
Menses		113.4 <sup>(2) 90</sup>	
Food Packaging and Adhered Food		324 <sup>(3)</sup>	
Gloves		7 <sup>(4)</sup>	
Grey or Duct Tape		33 <sup>(5)</sup>	
Greywater		TBD <sup>(6)</sup>	
Greywater Brine		TBD <sup>(6)</sup>	
Human Detritus:			
Finger and Toe Nails		0.01 <sup>(7)</sup>	
Hair		0.33 <sup>(7)</sup>	
Mucus		0.4 <sup>(7)</sup>	
Saliva Solids		0.01 <sup>(7)</sup>	
Skin Cells		3 <sup>(7)</sup>	
Skin Oils		4 <sup>(7)</sup>	
Sweat Solids		8 <sup>(7)</sup>	
Hygiene Products, Miscellaneous		TBD <sup>(5)</sup>	
Inedible Biomass and Wasted Crop Materials		TBD <sup>(3)</sup>	
Laundry: Clothing, Towels and Wash Cloths		230 <sup>(11)</sup>	
Medical Wastes		TBD <sup>(1)</sup>	
Metabolic Wastes:			
Feces		123 <sup>(8)</sup>	
Urine		1,562 <sup>(9)</sup>	
Paper		77 <sup>(5)</sup>	
Wipes:			
Toilet Paper		28 <sup>(10)</sup>	
Wipes, Detergent		58 <sup>(4)</sup>	
Wipes, Disinfectant		56 <sup>(4)</sup>	
Wipes, Dry		13 <sup>(4)</sup>	
Wipes, Wet		51 <sup>(4)</sup>	

**References**

- Table 4.46 Other Waste Streams
- <sup>(2)</sup> Table 4.40 Menstruation
- <sup>(3)</sup> Table 4.44 Selected References on Food Packaging, Inedible Biomass, and Wasted Food
- <sup>(4)</sup> Table 4.43 Disposable Hygiene Products
- <sup>(5)</sup> Table 2.1
- <sup>(6)</sup> Section 4.3.4.9
- <sup>(7)</sup> Table 4.42
- <sup>(8)</sup> Table 4.43
- <sup>(9)</sup> Table 4.39
- <sup>(10)</sup> Table 4.41
- <sup>(11)</sup> Ewert & Jeng 2015

<sup>100</sup> This table includes both wet and dry components. Component moisture content is presented in the references.

<sup>101</sup> Units for this category: grams per crewmember per EVA event [g/CM-EVA].

<sup>102</sup> The waste production rates in this category only exist for a woman during her menstrual period. Thus, units for this category are: grams per crewmember per menstrual period [g/CM-φ].

#### 4.3.4.1 FECES

The mass and composition of feces varies with, among other factors, the quantity and composition of consumed food. Additional fiber in the diet is known to increase daily stool mass (Tucker, *et al.*, 1981). Wydeven and Golub (1990) provide detail for dry human feces. Hawk (1965) states "...the amount of fecal discharge varies with the individual and diet. Various authorities claim that on an ordinary mixed diet the daily excretion by an adult male will aggregate 110-170 g with a solid content ranging between 25 and 45 g; the fecal discharge of such an individual on a vegetable diet will be much greater and may even be as great as 350 g and possess a solid content of 75 g."

Feces composition is described in Wignarajah, *et al* (2006). The physical consistency of feces is also highly variable between crewmembers and within the same crewmember over the mission.

NASA HIDH (2014) states that the fecal collection system "must be capable of collecting and containing an average of 150 grams (by mass) and 150 mL (by volume) of fecal matter per crewmember per defecation at an average two defecations per day". Consult the HIDH for additional information on maximum design values such as containment of 1.5 L of diarrhea discharge. Table 4.38 summarizes mass and composition information on feces from several sources. Note that values in this table are more typical average values versus conservative design values from the HIDH in the paragraph above.

**Table 4.38 Feces**

Waste	Units	Value	Comments
Feces	g/CM-d	123 <sup>(1)</sup>	Composition: 32 g/CM-d solids and 91 g/CM-d water. Ingested Food Composition: not available.
	g/CM-d	114 <sup>(2)</sup>	Composition: 32 g/CM-d "dehydrated residue" (4.5 g/CM-d fat, 4.5 g/CM-d protein, 1.8 g/CM-d cellulose, 9.5 g/CM-d inorganic matter, 11.4 g/CM-d bound water) and 82 g/CM-d water. Ingested Food Composition: not available.
	g/CM-d	120 <sup>(3,4)</sup>	Composition: 20 g/CM-d solids and 100 g/CM-d water. Ingested Food Composition: not available.
	g/CM-d	95.5 <sup>(5,6)</sup>	Composition: 20.5 g/CM-d solids (19.5 g/CM-d standard deviation) and 75 g/CM-d water. Ingested Food Composition: "relatively low fiber diet, not unlike that eaten while in space." Note: 24 h mean sample; standard deviation of 95.7 g/CM-d.
	g/CM-d	132 <sup>(7)</sup>	Composition: 21 g/CM-d solids and 111 g/CM-d water. Ingested Food Composition: not available.
	g/CM-d	30 <sup>(8)</sup>	Composition: 30 g/CM-d solids. Ingested Food Composition: not available. Note: <b>Dry mass only.</b> Wet mass unavailable.

Table References: <sup>(1)</sup> NASA (1991), <sup>(2)</sup> LSDB (1962), <sup>(3)</sup> BDB (1973), <sup>(4)</sup> Parker and Gallagher (1992), <sup>(5)</sup> Wydeven and Golub (1990), <sup>(6)</sup> Diem and Lentner (1970), <sup>(7)</sup> Schubert, *et al.* (1984), <sup>(8)</sup> Tucker, *et al.* (1981).

#### 4.3.4.2 URINE

The mass and composition of urine varies with the individual, with the quantity and composition water and food consumed, as well as with other factors. Wydeven and Golub (1990) provide detailed estimates of human urine. For more recent information on calcium in urine issues during space flight, see Smith (2012) and Smith (2014).

NASA HIDH (2014) states that the urine collection devices shall have the capacity to accommodate urine output volume of 3,000 mL/CM on the first flight day and 2,000mL/CM-d after that and a discharge up to 1000 mL in a single urination event at a delivery rate of up to 50 mL/s.

Depending on the post-urination-event cleansing methods, urine may adhere to toilet paper or wipes. Depending on the life support system configuration, urine may or may not be included with greywater. Table 4.39 summarizes information on urine. Quantity varies based on fluid intake, which has been increasing on board ISS in recent years.

**Table 4.39 Urine**

Waste	Units	Value	Comments
Urine	g/CM-d	* 1,562 <sup>(1-4)</sup>	Composition: 59 g/CM-d solids and 1,503 g/CM-d water. Ingested Food Composition: not available.
	g/CM-d	1,700 <sup>(5)</sup>	Composition: 70 g/CM-d solids and 1,630 g/CM-d water. Ingested Food Composition: not available.
	g/CM-d	1,470 <sup>(6)</sup>	Composition: 70 g/CM-d solids and 1,400 g/CM-d water. Ingested Food Composition: not available.
	g/CM-d	2,107 <sup>(7,8)</sup>	Composition: not available. Ingested Food Composition: not available. Note: 24 h mean sample; standard deviation of 1,259 g/CM-d. <sup>103</sup> The wet mass was calculated from urine volumes assuming a density of 1.02 g/mL.
	g/CM-d	1,390 <sup>(9)</sup>	Composition: not available. Ingested Food Composition: not available. Note: The wet mass was calculated from urine volumes assuming a density of 1.02 g/mL.

Table References: <sup>(1)</sup> BDB (1973), <sup>(2)</sup> NASA (1991), <sup>(3)</sup> Wydeven and Golub (1990), <sup>(4)</sup> Schubert, *et al.* (1984), <sup>(5)</sup> MSIS (1995), <sup>(6)</sup> LSDB (1962), <sup>(7)</sup> Parker and Gallagher (1988), <sup>(8)</sup> Diem and Lentner (1970), <sup>(9)</sup> Leach (1983).

#### 4.3.4.3 MENSTRUATION

Normally, adult female human beings menstruate once every 26 to 34 days for a duration of 4 to 6 days (NASA HIDH, 2014). These excretion products provide another waste generation source. Menstrual flow is highly variable between individuals. Consequently, menstrual pad and tampon use is also highly variable between individuals. Female crewmembers on ISS use medication before flight to prevent menstruation for up to 6 months during flight. This approach, for many reasons, may not be acceptable for longer-duration flights. Depending on the menstruation management and cleansing method used, menses may adhere to tampons, menstrual pads, toilet paper, or wipes. Table 4.40 summarizes information on menstruation using units of grams per crewmember per menstrual cycle [g/CM-d].

**Table 4.40 Menstruation By-products**

Waste	Units	Value	Comments
Menses	g/CM-d	* 113.4 <sup>(1)</sup>	Composition: 80% is released during the first 3 d of menstruation. Note: Menstrual period duration is 4 to 6 d every 26 to 34 d.
	g/CM-d	28 <sup>(2,3)</sup>	Composition: 10 g/CM-d solids (estimated).
Menstrual Pads and Tampons	g/CM-d	104 <sup>(3)</sup>	Note: Mean estimated tampon or menstrual pad usage is 16.2 products/CM-d. The average menstrual product (menstrual pads or tampons) is 6.4 g/product (clean).

Table References: <sup>(1)</sup> NASA HIDH (2014), <sup>(2)</sup> Hallberg and Nilsson (1964), <sup>(3)</sup> Parker and Gallagher (1992).

#### 4.3.4.4 TOILET PAPER

Toilet paper usage varies with production rates and consistency of metabolic waste excretions. Toilet paper is an important cleansing agent for all crewmembers. Because of relatively frequent resupply, toilet paper usage on current human missions, such as ISS, may not be as frugal as possible for longer-duration missions with more-limited or no resupply. Thus, the value provided in Table 4.41 may be an upper limit.

<sup>103</sup> 78% of the variation in urine output could be explained by variations in fluid consumed. What does this refer to and what is the reference for it?

**Table 4.41 Toilet Paper**

Waste	Units	Value	Comments
Toilet Paper	g/CM-d	* 28 <sup>(1)</sup> 104	
	g/CM-d	5.1 <sup>(2,3)</sup>	Note: Value computed assuming 6.0 g per bowel movement and 0.86 bowel movements/CM-d based on statistical data. Additionally, for female crewmembers, add 36 g/CM-d to support post-urination cleansing following each of 6 urinations/CM-d.

Table References: <sup>(1)</sup> Personal communication with S. Maxwell/Boeing in 2001, <sup>(2)</sup> Parker and Gallagher (1992), <sup>(3)</sup> Wydeven and Golub (1990).

#### 4.3.4.5 MISCELLANEOUS BODY WASTES

In addition to metabolic excretions, human beings also shed various wastes from the exposed surfaces of their bodies. These include sweat solids, dead skin cells and associated oils, hair, saliva solids, mucus, and finger and toe nails. Estimates and data for these waste stream components are detailed in Table 4.42.

Sweat solids may adhere to clothing, hygiene wipes, towels, wash cloths, and dissolve or suspend in hygiene greywater. Wydeven, and Golub (1990) and BDB (1973) provide approximate compositions for dry solids in sweat.

Dead skin cells, once free from the surface of the body, exist as cabin “dust,” and collect in the cabin air filter. However, some skin cells may adhere to clothing, hygiene wipes, towels, washcloths, or suspend in hygiene greywater. Wydeven, *et al.* (1989) provides estimates for particle and dust generation rates by human beings within a space station.

**Table 4.42 Miscellaneous Body Wastes**

Waste	Units	Value	Comments
Sweat Solids	g/CM-d	18 <sup>(1)</sup>	
	g/CM-d	3 <sup>(2,3)</sup>	
Skin Cells	g/CM-d	3 <sup>(2,3)</sup>	
Skin Oils	g/CM-d	4 <sup>(2,3)</sup>	
Hair	g/CM-d	0.33 <sup>(2,3)</sup>	Composition: 0.3 g/CM-d for facial shaving and 0.03 g/CM-d for depilation. Note: The study used only male subjects.
Saliva Solids	g/CM-d	0.01 <sup>(2,3)</sup>	
Mucus	g/CM-d	0.4 <sup>(2,3)</sup>	
Finger and Toe Nails	g/CM-d	0.01 <sup>(2,3)</sup>	

Table References: <sup>(1)</sup> NASA (1991), <sup>(2)</sup> LSDB (1962), <sup>(3)</sup> NASA HIDH (2014).

#### 4.3.4.6 DISPOSABLE HYGIENE PRODUCTS

Aboard ISS, crewmembers use a variety of wipes and gloves for various housekeeping and hygiene tasks. Personal communication with S. Maxwell/Boeing in 2001 estimates consumption rates for these items based on ISS usage.

Though confirmed only verbally, gloves are used at a rate of one glove per day to clean the toilet after defecation. These gloves are non-powdered, medium, latex laboratory gloves. Following use, human metabolic wastes, such as feces or urine, may adhere to the gloves.

Wipes are essential to many tasks aboard ISS and the estimated consumption rates here are based on ISS usage. Four types of wipes are listed below, though detergent and disinfectant wipes are the same as wet wipes with a commercial detergent or disinfectant solution applied to them. Because of relatively frequent resupply, wipe usage on current human missions, such as ISS, may not be as frugal as possible for longer-duration missions with less frequent or no resupply. Thus, the values provided in Table 4.43 may be an upper limit.

<sup>104</sup> Charmin (2002) claims that “the average person uses 57 sheets [of toilet paper] per day,” or 23 g/CM-d.

**Table 4.43 Disposable Hygiene Products**

Waste	Units	Value	Comments
Gloves	g/CM-d	7 <sup>(1)</sup>	Usage: 1 glove/CM-d to clean the toilet following defecation.
<b>Wipes</b>			
Dry	g/CM-d	13 <sup>(1)</sup>	Usage: This is equivalent to 3 Kimwipe® brand, low-lint 29.2 cm by 30.5 cm wipes/CM-d.
Wet	g/CM-d	51 <sup>(1)</sup>	Usage: This is equivalent to 4.7 Huggies® brand wet baby wipes/CM-d. K. Clark/ARC Personal Communication in 2003) states that Huggies® wet baby wipes at 75% moisture have a mass of 10.9 g/wipe.
Detergent	g/CM-d	58 <sup>(1)</sup>	
Disinfectant	g/CM-d	56 <sup>(1)</sup>	

Table Reference: <sup>(1)</sup> Maxwell (2000a).

#### 4.3.4.7 FOOD PACKAGING, INEDIBLE BIOMASS, AND WASTED FOOD

The food system, whether prepackaged or based on the conversion of crops, invariably generates a significant and unique waste stream. Prepackaged food systems generate waste streams including packaging, comprised of plastic bonded to a metallic layer, with adhered food. Crop-based food systems generate wastes associated with the crops and with the conversion of crops to finished entrees. Finally, the crew for many reasons may waste food in either system.

The first estimate in Table 4.44 provides an estimate of the minimal waste stream from a prepackaged food system. Levri, *et al.* (2001) assumed ambient-stored, prepackaged food, similar in nature to the Shuttle Training Menu. Further, each crewmember requires metabolic energy from food of 11.82 MJ/CM-d and only 3% of all prepackaged food and rehydration water is wasted. This is a lower practical wastage limit to estimate the material wasted if the crew attempted to eat all of the food in every package that is opened. The food wastage represents approximately 3% of prepackaged food and rehydration water adheres to the sides of the packaging. Additionally, this study assumed that a small salad crop provides less than 1% of the crew's food energy needs.

The second estimate, from personal communication with S. Maxwell/Boeing in 2001b, an unpublished source to date, studied actual ISS food usage rates. This study collected information on the preferred menus of three ISS occupants during one expedition and computed the daily average per crewmember usage rates for food, packaging, and rehydration water. This study additionally assumed that 15% of all food packages shipped to ISS were unopened and discarded and that 5% of all opened food with any rehydration water was discarded while adhered to the food packaging. The actual values in Table 4.44 assume modified packaging numbers to reflect more recent food packaging mass data as presented in Levri, *et al.* (2001). Further, because actual crewmembers are not nominal crewmembers, the nominal metabolic energy of 11.82 MJ/CM-d does not apply to these data. Lastly, food wastage assumptions for future long-duration missions are usually more conservative than ISS usage values because resupply may be more limited or completely nonexistent.

Crops and food processing may generate wastes during crop production, in the form of inedible biomass and expended nutrient solution or other growth support agents, and post-harvest during the production of food products and meals from the crops, in the form of wasted edible biomass, cleansing agents, food preparation fluids and agents, and even plate waste. These waste generation rates are highly variable and mission dependent.

Table 4.44 summarizes information on food packaging, inedible biomass, and wasted food.

**Table 4.44 Selected References on Food Packaging, Inedible Biomass, and Wasted Food**

Waste	Units	Lower	Nominal	Upper	Comments
<b>Food Packaging Waste</b>	kg/ CM-d	0.23 <sup>(2)</sup>	0.26 <sup>(1)</sup>	0.31	Lower & Nominal values of plastic packaging are based on Metabolic Energy = 11.82 MJ/CM-d and Ingested Food Composition = ambient-stored, prepackaged food system. Lower value assumes that 10% of the food packaging launched never reaches the trash because there will be food reserves left at the end of a nominal mission.
<b>Waste Food Adhered to Packaging</b>	kg/ CM-d	0.06 <sup>(1)</sup>	0.10 <sup>(2)</sup>		Lower value: 62 g/CM-d adhered food (~73% moisture content, including beverages). Nominal value represents 7% adhered, of 90% of mission food consumed (46.4% moisture).
<b>Inedible Biomass and Wasted Crop Materials</b>	kg/ CM-d		TBD		Note: Highly mission dependent. See Table 4.97 for inedible biomass productivity under typical crop growth chamber conditions. See Table 4.99 for examples of diets using crops.

Table References: <sup>(1)</sup> Levri, *et al.* (2001), <sup>(2)</sup> 2014 Logistics Reduction model v.2.5

*4.3.4.8 PAPER, TAPE, MISCELLANEOUS HYGIENE PRODUCTS, AND CLOTHING*

Human activities generate a number of waste streams not related to metabolic activity. In particular, documentation generates waste paper, tape is used to seal plastic garbage bags, crew hygiene activities contribute many items to the waste stream, and clothing, when used, adds another waste stream for long-duration missions.

ISS uses paper for documentation and the data point in Table 4.31 is based on ISS usage rates. Waste paper generation rates can vary significantly between ISS increments and may not be closely correlated to the number of crewmembers. It is theorized that the relatively frequent upload and download of supplies to ISS is strongly related to the somewhat high rate of waste paper generation from documentation. Much lower waste paper generation rates for documentation are likely on longer-duration missions with little or no resupply.

Grey or duct tape has traditionally been used on Shuttle and ISS missions to bind bags of trash. On future missions, the crew may utilize other approaches for sealing trash bags and other tasks where tape might be used. Thus, tape usage is contingent on vehicle design.

As noted in Table 4.43, waste generation rates associated with personal hygiene products can be significant. The data here are based on ISS usage rates. These values may include items such as commercial off-the-shelf (COTS) dental floss, toothbrushes, and containers for toothpaste, shave cream, razors, mouthwash, shampoo, moisturizing lotion, deodorant, sun block, lip balm, makeup, and similar personal hygiene products. It may be possible to reduce these through custom design containers but given the emphasis on COTS to reduce costs, that may be unlikely. Theoretically, the relatively frequent resupply schedule for ISS is strongly correlated to the surprisingly high rate of miscellaneous hygiene product waste generation because the individual crew products may not be completely used during an ISS crew rotation.

Clothing usage and associated dirty clothing generation rates are also significant historically, as documented in

Table 4.49 for the early years of ISS. Actual expended clothing generation rates have been less than these early projections and a more recent value is found in Table 4.37. A laundry can increase clothing life, thus reducing waste generation rates associated with discarded clothing, at a cost of other vehicle resources such as power, crewtime, and water usage.

As a simplifying assumption, clothing is comprised of 100% cotton and has 8.5% moisture content when clean and dry, which is an industry standard for cotton. Actual clothing may be comprised of other materials that are more efficient and fire retardant, but historically crewmembers prefer clothing with higher cotton content. Cotton has also been used for ISS due to fire considerations. Clothing is in close contact with skin and will char rather than melt during a fire or high heat event. Recent Advanced Exploration Systems (AES) Logistics Reduction and Repurposing Project research investigated wool, monoacrylic, and cotton polyester blends as possible replacements for cotton-based clothing (Broyan 2014).



However, clothing will probably not be discarded in clean form. Rather, clothing, towels, and washcloths will likely contain skin cells, sweat solids, skin oil, hair, and other miscellaneous body wastes. Towels and washcloths will likely also contain moisture from sweat and bathing. McGlothlin (2000) reports that the average 49-g Class III <sup>105</sup> Shuttle washcloth, measuring 30.5 cm by 30.5 cm and comprised of 100% cotton, retains up to 202 g of water when completely soaked. On ISS, crewmembers typically allow their wash cloths, towels, and clothes to air dry prior to disposal to allow recovery of the moisture. Table 4.45 summarizes information on waste streams from paper, tape, miscellaneous hygiene products, and clothing.

**Table 4.45 Composition of Paper, Tape, Miscellaneous Hygiene Products, and Clothing**

Waste	Units	Value	Comments
Paper	g/CM-d	77 <sup>(1)</sup>	Composition: 6% moisture content.
Grey or Duct Tape	g/CM-d	33 <sup>(2)</sup>	Note: This value is highly design contingent. The value here represents ISS usage.
Misc. Hygiene Products	g/CM-d	781 <sup>(1)</sup>	Note: This value is highly design contingent. The value here represents ISS usage. Future missions may allow much lower waste generation rates from miscellaneous hygiene products.
Clothing, Towels, and Wash-cloths	g/CM-d	230 <sup>(3)</sup>	Composition: 100% cotton solids, with 8.5% moisture content (clean and dry).

Table References: <sup>(1)</sup> Personal communication with S. Maxwell/Boeing in2001, <sup>(2)</sup> Wydeven, *et al.* (1989), <sup>(3)</sup> Ewert (2013).

**4.3.4.9 GREYWATER AND BRINE**

Wastewater and brines, though historically processed by the Water Subsystem, may initially or after processing pass to the Waste Subsystem. Section 4.2.2 lists wastewater generation rates and stream compositions. However, these tables do not provide greywater generation data for configurations with crop production or food processing. Greywater production from such activities depends on the crops produced, the growing techniques, the crop processing approaches following harvest, the food processing technology, and the processing equipment and crop cleansing approaches. Finally, greywater may also include urine.

In general, greywater production rates and, more importantly here, the rate of wastewater transfer to the Waste Subsystem, are highly dependent upon the vehicle design. The individual greywater production rates are variable, and decisions about how the wastewater streams are managed significantly influence the wastewater and brine loads passed to the Waste Subsystem.

Brine production rates depend primarily upon the architecture of the water system. If greywater is processed for reuse, the degree of recovery determines the composition of the brine remaining after treatment. Most advanced physicochemical water processors recover up to 95% to more than 99% of the water within the input greywater stream.

**4.3.5 ELEMENTAL COMPOSITION OF WASTE**

Table 4.48 represents approximate elemental compositions for some components that make up the waste stream. Approximations of the major constituents of the waste stream and an assumed end product of CO<sub>2</sub> and H<sub>2</sub>O or CH<sub>4</sub> will allow a quantitative look at mass of end products in the proposed reaction. Using tools such as this can lead to system mass balances that can be quite useful in looking at loop closure modeling for life support by tracking carbon, oxygen, nitrogen and hydrogen. This approach yields a simplified but beneficial model.

Different missions will likely have different requirements in the waste stream produced and in the amount of waste produced. A transit mission to the lunar surface might be roughly equivalent to a Shuttle mission because they all originate from relatively short missions. From the initial mass of input components, all

<sup>105</sup> Note: “Class III” hardware is dimensionally the same and functionally similar to flight, or “Class I,” hardware. However, Class III hardware is not, in general, identical to Class I hardware.

the product and waste components can be calculated. The feces produced is 123 grams  $\text{CM}^{-1}\text{d}^{-1}$  Table 4.38, is 70% water by mass initially, and the dry initial mass of feces is 36.9 grams  $\text{CM}^{-1}\text{d}^{-1}$ . A 300-day mission for four crewmembers could produce 44 kg of feces. If completely oxidized, this could produce 32 kg of water in addition to the 103 kg from the initial drying step.

This approach, when performed on the entire waste stream, provides insight into the amount of waste generated and the potential yield of useful commodities gained from waste component recycling. The results of some calculations based on stoichiometry by assuming waste is composed of only major elements, are shown in Equation 4.1.

Usually, the waste product is a polymer and the estimation is made assuming the molecular weight of the polymer building block. For example, cellulose is composed of linked chains of glucose molecules. Paper is made of wood pulp, which consists mainly of hexose and pentose chains of simple carbohydrates. This allows a modeling relationship between the mass of wastes on prior missions and the stoichiometry used to predict the product.

#### 4.3.5.1 MODELING WASTE SYSTEMS

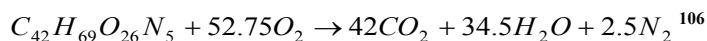

**Equation 4.1**

**A stoichiometric approach to oxidation of feces**

#### 4.3.5.2 OTHER WASTE STREAMS

Several other notable waste streams are possible. Wastes associated with EVAs depend on the frequency of EVAs. Other waste streams from equipment, experiments, and medical tests are highly variable and depend on the vehicle and mission architecture.

EVA supply waste streams to the life support system. While some wastes are gaseous, others are solid wastes. Most significantly, crewmembers are provided with a maximum absorption garment (MAG) to catch metabolic wastes. A used garment may be contaminated with urine, feces, and other wastes associated with exposure to human skin. The data in Table 4.46 are based on ISS equipment and production rates in terms of grams per crewmember per EVA sortie [g/CM-EVA]. Data on other likely EVA wastes, such as food sticks, drink pouches, and batteries, were unavailable. EVA consumption rates for consumables are given in Table 4.46 although these values do not reflect solid waste production rates. Equipment wastes are highly variable and depend upon the overall vehicle design. Equipment wastes include supplies for life support hardware, such as filters and plastic bags. Generally, the Waste Subsystem design depends upon the life support system architecture, including the degree of resource recovery and containment for pre-processing storage, post-processing storage, and disposal. For example, a system in which there is no recovery from solid wastes, such as on ISS, may require more Waste Subsystem resupply items than a system that reuses or recovers resources. Regarding storage options, some equipment wastes might be returned to its original stowage volumes, although cleaning may be required before such an approach is acceptable. For example, contaminated membranes from the Water Subsystem might be cleaned to remove water wastes and then stowed in the original stowage volume for membranes. Experimental wastes are highly variable and depend upon experimental procedures and the mission objectives. Some waste materials may be hazardous. Medical wastes are also highly variable and depend upon medical protocols. These waste loads could be very sporadic and may require special handling. Some waste product materials may even be a biohazard. Table 4.46 summarizes information on EVA, equipment, experiment, and medical waste streams.

---

<sup>106</sup> [personal communication with K. Wignarajah in 2008] has measured an O/C ratio of 0.6-0.7 and cites several references including [Liu, 2008] and [Tikhomirov, 2003] that are in agreement. There is however a great deal of variability in feces composition due to dietary variability. This should be considered by analysts, as the literature is not conclusive.



**Table 4.46 Other Waste Streams<sup>107</sup>**

<b>Waste</b>	<b>Units</b>	<b>Value</b>	<b>Comments</b>
<b>EVA Wastes</b>	g/CM-EVA	173 <sup>(1)</sup>	Note: This value represents the maximum absorption garment (clean and dry)
<b>Equipment Wastes</b>	g/CM-d	TBD	Note: Highly variable and dependent on vehicle design.
<b>Experiment Wastes</b>	g/CM-d	TBD	Note: Highly variable and dependent on mission design. Waste streams delegated to the Waste Subsystem will depend on mission protocols. Some wastes may be hazardous.
<b>Medical Wastes</b>	g/CM-d	TBD	Note: Highly variable and dependent on mission medical protocol. Waste streams delegated to the Waste Subsystem will depend on mission protocols. Some wastes may be biohazards.

#### **4.3.6 WASTEWATER RECOVERY MODEL FOR A LUNAR SURFACE MISSION**

Prior to performing a system-level trade study to evaluate the potential effect of recovering water from waste, it is necessary to have a waste model that reasonably characterizes the anticipated waste streams. Similarly, in combination with Research and Technology Development, and Waste Management System (WMS) requirements and drivers, this waste model will drive technology development. A significant amount of previous work has been performed that identified potential wastes from various historical mission scenarios, both from post-mission analyses of discarded wastes as well as supply uploading information. This information is largely kept current within this document. There is no widely established waste model for a long-duration lunar surface mission at this time. Therefore, mission analyses are often conducted using analysis-specific (customized) waste models that employ varying assumptions and design values.

A major goal of this waste model development effort is to generate a central “working document” that is widely accessible and that could serve as a focal point for continuing refinement. Developing this type of waste model for new classes of missions that are still in initial planning creates a significant amount of uncertainty. Therefore, it is anticipated that data contained in this model could change significantly as mission definition and development progresses. This waste model is therefore not intended to be a final product, but rather a beginning point. With this in mind, the model was constructed using a spreadsheet format that allows users to readily change mission assumptions, mission design values and even add functionality (Hogan, 2010).

A full characterization of wastes requires a large number of parameters. The most pertinent waste characteristics that require examination for a water balance study include the waste type, mass, and moisture content. These data are sufficient to estimate the water recovery potential and are the central data for this model development. Additional data will eventually be needed for a more refined analysis to support detailed waste processing equipment selection, sizing, and integration studies. These additional data may include waste volume in relevant waste mixtures and under different levels of compaction (e.g., none, manual, mechanical, heat-melt), including materials of construction, elemental composition, and biodegradability. As such, the wastes would need to be generated in a realistic fashion and processed in actual WMS technologies to obtain much of this information.

##### *4.3.6.1 MODEL DEVELOPMENT AND CHARACTERISTICS*

The data collected for this model were obtained or derived from a number of sources including various technical papers, textbooks, and previous waste model studies. The general approach was to identify the anticipated wastes and to classify them according to waste similarity and/or subsystem/operation. Although certain waste streams are currently difficult to predict or are unplanned (e.g., experiment wastes, biomass production), those classes were included to ensure they are addressed as data become available.

The model is designed to allow the user to select various mission parameters. This includes the crew size during the nominal mission, as well as during any mission overlap period. The mission overlap period is

---

<sup>107</sup> Table Reference: EDCC (1998).

that time between when a new crew arrives and the old crew departs. Estimates appear to vary with exactly how long this overlap period will be, but 30 days appears to be the current maximum. Likewise, the mission duration and overlap period are specified as model parameters. The average percent of female crewmembers is required in that males and females impose different hygiene waste loads.

EVA is accounted for by requesting the average number of EVA sorties per day. Currently, the only calculation that EVA pertains to is the generation of Maximum Absorption Garments (MAGs). It is assumed that each EVA performed by a crewmember requires a fresh MAG, and that the EVA duration is approximately 7-8 hours. Even though the assumed average EVA rate may be fractional, in total the number will be equivalent to the total number of MAGs utilized. An important feature of the MAG as a waste item is that it will contain human urine and feces. Extended EVA will result in a significant portion of a crewmember's daily urine generation to be trapped in the MAG. No data were found that approximate the average percentage, so a value of 33% was estimated. It is also unclear what percentage of fecal wastes will be contained in a used MAG, but it is assumed that the crew will be resistant to defecate in the MAG during EVA. Therefore, it was assumed that MAGs contain 10% of fecal waste. This is equivalent to defecating a 1-day amount of feces once out of every 10 EVA operations. This appears reasonable considering the long duration of EVA periods.

Another related assumption is that a certain fraction of defecations will be diarrheal. This is important in that diarrhea will contain much higher amounts of water than nominal feces. From NASA HIDH (2014), it was assessed that each diarrheal event would be 0.5 L on average. Additionally, it is assumed that the same amount of fecal solids are contained in that volume, and that the remainder is composed of water. As no data were found with regards to the average number of diarrheal events, particularly for a lunar mission, it was assumed that one defecation per month was diarrheal.

The data inputs for the actual mass and water content of wastes expected for the model waste components were provided as nominal, minimum, and maximum values. The nominal values were selected to be the most likely value at this point in the mission planning. The minimum and maximum values were provided to give a reasonable design range. This is anticipated to be valuable for technology developers when sizing waste processing and storage equipment. These upper and lower values were synthesized by evaluating data ranges (when available) or by alternatively assuming a percent variance from nominal.

Using the various mission parameters, waste component design mass values and moisture content are calculated and listed separately in a separate area of the spreadsheet. These data are summarized in the final section to allow the user to easily discern the totals of various waste stream component mixtures. This was performed because there are uncertainties within the mission architecture that will play a critical role in what the WMS will receive, and therefore, what the WMS must accommodate. For example, if wastewater brine is not processed further by dewatering, this waste stream will exert a strong influence on overall waste stream water content and how the waste system must be designed to process/store it.

#### 4.3.6.2 LUNAR OUTPOST WASTE MODEL RESULTS

Table 4.47 contains a model used to calculate lunar outpost wastes. Again, it must be noted that certain design assumptions are currently under development, and significant changes in the assumptions are likely with time. Therefore, it is valuable to approach the results of this model as preliminary guidance, rather than final results (Hogan, 2010).

Hogan gave results for the total mass of lunar outpost mission wastes for the case of 4 crew staying 210 days and a second crew of 4 overlapping for the last 30 days. Here only normalized data will be presented on a per-crewmember per-day basis. The water mass contained in waste is also presented in Table 4.47. Each crewmember produces a nominal average of 1.49 kg/CM-day at a moisture content of 41.9% when brine is not included.

The data in the table are presented in a manner that facilitates understanding how waste production rates will vary in accordance with future WMS designs. For example, the nominal crewmember production rates will increase from 1.49 to 1.90 kg/CM-day if wastewater brines are not further dried for both water recovery and volume reduction. This significant increase, which is mostly water, points to serious consideration of drying wastewater brines. The waste mass will increase only slightly due to the inclusion of the brine solids obtained after drying (1.56 kg/CM-day).

If a laundry system is utilized and clothes are not discarded, the waste production rate drops significantly (1.01 kg/CM-day). Because this mixture does not contain feces, laundry items or brines, it is likely akin to the waste fraction typically referred to as trash in past missions. It should be noted that some clothes will eventually be discarded as they age beyond functional use. A value of 0.0373 kg/CM-day can be used as a

clothes attrition rate with a laundry system for a 180-day mission, and can replace the laundry values used in this spreadsheet if a clothes washing system is implemented.

The rate of feces production increases from 0.123 to 0.140 kg/CM-day by including a single diarrheal event per month. Further definition is required to fully reflect the issues of fecal production rates, including the effect of high rates of EVA, which may increase food intake and concomitant feces generation.

Another waste source that was revealed to be a significant source of water was the urine contained in the MAGs used during EVA. The model assumed that 33% of a crewmember's total daily urine production was collected in the MAG per EVA event (EVA events were assumed to be of long duration, 7-8 hrs). Although it is likely that the crew will take measures to empty their bladder prior to EVA, the EVA will be conducted for a long period, and a substantial amount of water will be consumed by the crew while inside the suit. The 33% value represents approximately 0.515 kg/CM-day, which is a significant portion of the overall waste produced per day. This is also the principal reason why the moisture contents presented in Table 4.34 are substantially higher than previous waste model values. This is an important issue when evaluating the potential for water recovery from wastes, as the MAGs would likely need to be stored in the lunar rovers and processed at the core habitat to recover that water. The assumed rate of EVA used in this model (22.3 hrs EVA per day) is substantially higher than the value used in a previous analysis (7.3 hrs EVA per day, Lange, 2009). This value was the result of a lunar architecture study aimed at surface systems (R. Bagdigian, 2009). One area that remains undefined and is not addressed in this model is the issue of packaging used for items other than food. There is the potential that consumable items may come individually wrapped in plastic, paper, or foam. While paper and plastic (film) can readily be incorporated with most other wastes, the foam that often protects shipped hardware can be stiff and bulky. It must be decided where such wastes will be processed and/or stored. They are unlikely to contain any significant water, so these types of additional wastes are unlikely to serve as a significant water source/sink, and the exclusion of them from this model will affect only the waste mass estimates as definition is required.

#### *4.3.6.3 FUTURE WASTE MODEL EFFORTS*

The 2010 lunar model effort focused on defining the major waste model needs for waste type, amount, and water content. To increase the utility of the model to serve more refined analyses, more data are required. With regards to water content, the production of water via mineralization should be examined in addition to the potential to recover free water. This entails understanding the elemental composition of the wastes, as well as their transformation during mineralization.

In addition to total waste quantities produced, the potential patterns of generation (e.g., frequent vs. intermittent) also require examination. For example, the waste generation will likely be very high for the initial phase of a mission when habitats and pressurized rovers are setup and packaging material to reduce launch or landing loads are removed. Of particular interest is the potential for large amounts of stored waste to be returned from long lunar rover excursions. This waste could present a processing challenge to WMS processors, particularly if all crew are away from the core habitat for extended periods. Unless wastes can be processed autonomously in a continuous system, oversized processors would need to be developed to process wastes while the core habitat is manned. This could significantly affect WMS operations. Therefore, increased detail is required on the EVA schedule, including duration, number of events and the availability of crew to process wastes.

Additionally, the issue of waste mixtures will need to be studied. For example, certain wastes may be generated in combination and in particular proportions, and may strongly influence processing possibilities. Certain waste streams may therefore be addressed as mixtures rather than as individual components. In addition, waste segregation can be examined with respect to its potential effect on general waste management and water recovery goals. Segregation may be required to enable certain waste processing needs, such as potentially segregating dry wastes from wet wastes to decrease waste drying operations. The potential for waste variability both during a mission and among mission types will also need to be assessed, as this can also influence the types of waste processors that can be utilized.

Another effort that requires consideration is the need to develop and maintain a system that can track the "waste" materials generated by the various mission subsystems. This could be considered to be a "waste catalogue" that allows each subsystem to identify the materials/parts of that system to be discarded. This could include nominal (predicted) process products and expendables. The catalogue would best be maintained as a web-based tool that allows real-time updating from authorized personnel from each of the relevant subsystems. This information would allow the waste subsystem to optimize their research and technology development program to best meet the needs of the mission. Additionally, this information would allow the WMS element to

provide feedback to other subsystems regarding certain problematic wastes. This provides an opportunity for material substitution to be investigated in a timely fashion.

From 2012-2014, Ewert developed an 'exploration' logistics and waste model for NASA's Logistics Reduction and Repurposing project (Ewert, 2013 and Broyan, 2014). This model predicted 1.0 kg/CM-day of crew solid waste, including feces, but excluding brine, plus an additional 0.5 kg/CM-day of life support systems waste such as filters, waste tanks, etc. One waste item that was quite a bit lower than Hogan's earlier estimates was clothing and towels. It is expected that future efforts on waste model development will occur as time and opportunity allow.

**Table 4.47 Lunar Outpost Mission Waste Sources Design Values and Water Content**

Waste Components	Nominal Design Values	Minimum Design Values	Maximum Design Values	Units	Nominal Moisture Content (%)	Minimum Moisture Content (%)	Maximum Moisture Content (%)
<b>Lunar Outpost Mission - Waste Sources Design Values and Water Content Food System Wastes:</b>							
Food Packaging	262	236	288	g/CM-d	0.0	0	0
Food Adhered to Packaging	62	59	68	g/CM-d	73.0	68	78
<b>Equipment Wastes:</b>							
TBD	0	0	0	g/CM-d	0.0	0	0
<b>Experiment Wastes:</b>							
TBD	0	0	0	g/CM-d	0.0	0	0
<b>Feminine Wastes:</b>							
Menstrual Hygiene Products	3.7	3.3	4.1	g/CM-d	0	0	0
Menses	1	0.8	5	g/CM-d	36	36	36
<b>Wastewater Recovery System Wastes:</b>							
Hygiene Wastewater (no urine)	7,170	6,453	7,887	g/CM-d	99.8	99.5	99.9
Humidity Condensate	2,270	2,043	2,497	g/CM-d	99.99	99.9	99.999
Urine	1562	1390	2107	g/CM-d	96.2	95.7	96.7
Solids in Brine After Processing	18	15	20	% Solids	na	na	na
<b>Human Detritus:</b>							
Finger and Toenails	0.01	0.01	0.01	g/CM-d	0	0	0
Hair	0.33	0.30	0.36	g/CM-d	0	0	0
Mucus	0.40	0.36	0.44	g/CM-d	95	95	95
Saliva Solids	0.01	0.01	0.01	g/CM-d	0	0	0
Skin Cells	3.00	2.70	3.30	g/CM-d	0	0	0
Skin Oils	4.00	3.60	4.40	g/CM-d	0	0	0
Sweat Solids	18.00	16.20	19.80	g/CM-d	0	0	0
<b>Hygiene Products:</b>							
Miscellaneous	0.00	0.00	0.00	g/CM-d	0	0	0
<b>Biomass Production Wastes</b>							
Inedible Biomass/Waste Crop Materials	0.00	0.00	0.00	g/CM-d	0	0	0
<b>Laundry:</b>							
Clothing, towels, washcloths	343	309	377	g/CM-d	8.5	8.5	15
<b>Medical Wastes:</b>							
Miscellaneous	0.00	0.00	0.00	g/CM-d	0	0	0

**Table 4.47 Lunar Outpost Mission Waste Sources Design Values and Water Content (cont)**

<b>Waste Components</b>	Nominal Design Values	Minimum Design Values	Maximum Design Values	Units	Nominal Moisture Content (%)	Minimum Moisture Content (%)	Maximum Moisture Content (%)
<b>Lunar Outpost Mission - Waste Sources Design Values and Water Content</b>							
<b>Metabolic Wastes:</b>							
Feces (nominal non-diarrheal)	123.00	95.50	132.00	g/CM-d	74	69	79
Diarrheal Feces	500.00	450.00	550.00	g/CM-event	93.6	92.8	94.2
Vomit	11.70	11.70	50.00	g/CM-d	80	70	90
Urine	1,562	1,390	2,107	g/CM-d	96.2	95.7	96.7
<b>Extravehicular Activity:</b>							
Extravehicular Activity MAG	173.00	173.00	173.00	g/ MAG	8.0	7.0	10.0
Urine contained in MAG per EVA event	25	20	30	% of total daily urine production	96	96	96
Feces contained in MAG per EVA event	5	2	10	% of total daily feces production	75	70	80
<b>Wipes:</b>							
Toilet Paper (Clean and Dry)	6	5	28	g/CM-d	8.0	7.0	10.0
Wipes, Detergent	58	52	64	g/CM-d	75	70	80
Wipes Disinfectant	56	50	62	g/CM-d	75	70	80
Wipes: Dry	13	12	14	g/CM-d	8	7	10
Wipes, Wet	51	46	56	g/CM-d	75	70	80
<b>Miscellaneous:</b>							
Gloves	7.00	7.00	14.00	g/CM-d	0.0	0.0	0.0
Tape	33	0	40	g/CM-d	0	0	0

**Table 4.47 Lunar Outpost Mission Waste Sources Design Values and Water Content (Results)**

<b>Moisture Content (%)</b>	<b>% Water (Nominal)</b>	<b>% Water (Minimum)</b>	<b>% Water (Maximum)</b>
Waste (no brine or brine solids)	41.9	38.9	49.2
Waste (includes brine and brine solids)	50.5	54.2	54.6
Waste (includes brine solids)	39.9	36.2	47.2
Waste (no brine/solids, laundry items)	51.9	48.7	58.1
Waste (no brine/solids, laundry items, feces)	48.6	45.7	55.5
Feces only (normal and diarrheal)	76.4	72.3	80.9
<b>Crew Production Rates</b>	<b>kg/CM-D (Nominal)</b>	<b>kg/CM-D (Minimum)</b>	<b>kg/CM-D (Maximum)</b>
Waste (no brine or brine solids)	1.49	1.26	1.84
Waste (includes brine and brine solids)	1.90	1.89	2.23
Waste (includes brine solids)	1.56	1.36	1.92
Waste (no brine/solids, laundry items)	1.15	0.95	1.46
Waste (no brine/solids, laundry items, feces)	1.01	0.85	1.32
Feces only (normal and diarrheal)	0.14	0.11	0.15
Wastewater Brine (urine, humidity cond., hygiene)	0.41	0.39	0.63

**Table 4.48 Estimated Stoichiometric Model of Useful Waste Products**

Waste Processing Stoichiometry					
			Theoretical Products, kg/CM d	H <sub>2</sub> O, kg/CM-d	CH <sub>4</sub> kg/(CM-d)
feces	Volk (1987)	C <sub>42</sub> H <sub>69</sub> O <sub>13</sub> N <sub>5</sub>	0.123	0.09	
food pkg, kg/CM*d	polyethylene, polystyrene, polypropylene (equal 3rds)	C <sub>n</sub> H <sub>2n</sub>	0.220		0.13
plus adhered food	50% CHO(glucose), 27.5% fat(squalene), 22.5% Protein(isoleucine)	C <sub>6</sub> H <sub>12</sub> O <sub>6</sub> , C <sub>5</sub> H <sub>9</sub> O <sub>2</sub> , C <sub>6</sub> H <sub>15</sub> O <sub>2</sub> N <sub>2</sub>	0.098	0.07	
uneaten food	50% CHO(glucose), 27.5% fat(squalene), 22.5% Protein(isoleucine)	C <sub>6</sub> H <sub>12</sub> O <sub>6</sub> , C <sub>5</sub> H <sub>9</sub> O <sub>2</sub> , C <sub>6</sub> H <sub>15</sub> O <sub>2</sub> N <sub>2</sub>	0.249	0.21	
MAGS, kg/CM d	Wikipedia, 520 1/2 day Sorties per year allowed so: 520/365=0.7 EVA/day allowed	CH <sub>2</sub> -CH(COONa)	0.173	0.058	
Gray Tape, kg/CM*d	80% polyethylene polymer + 20% butadiene polymer	C <sub>2</sub> H <sub>4</sub> +C <sub>5</sub> H <sub>10</sub>	0.033		0.14
Paper	Cellulose (glucose polymer); wood fiber (analysis the components showed glucose (65.8%), xylose (19.8%), galactose (12.5%) and mannose (1.3%))	C <sub>6</sub> H <sub>12</sub> O <sub>6</sub> , C <sub>5</sub> H <sub>10</sub> O <sub>5</sub>	0.105	0.08	
Towels & Washcloths	cotton(95% cellulose)	C <sub>6</sub> H <sub>12</sub> O <sub>6</sub>	if "x" is the mass sent to waste	0.09x	
Clothing	With polybenzimidazole fire retardant	C <sub>11</sub> H <sub>15</sub> N <sub>2</sub>	"x" is the mass sent to waste		0.37x



## 4.4 HABITATION INTERFACE

Habitation functions are diverse and cross many systems, including environmental control & life support, crew health & safety, and logistics. There are many potential definitions of habitability depending on the vehicle level assumed. At the highest vehicle level, habitation consists of the entire crew module including the pressure shell structure, ECLSS, power/avionics systems, human systems architecture, and crew health/medical equipment. At the lower vehicle levels, habitation consists of discrete hardware systems ranging from tools and crew quarters structures to specific human factors requirements. For purposes of this section, Habitability is defined as crew hardware and logistics required to utilize vehicle systems and to maintain crew productivity. It does not include primary vehicle structure (the habitat), ECLSS, or medical equipment. Habitation areas that do not impact ECLSS (i.e., autonomous logistics management, quiet acoustic interiors, logistics packaging, crew structures) are generally not discussed in this document.

Habitation systems are needed for (1) future crewed weightless transits, (2) reduced gravity planetary lunar or Martian surfaces, and (3) long-duration, deep-space environments. Logistics required to support humans are generally proportional to the duration of the space mission and may amount to 3.7 kg/CM-day (Ewert, 2013). Exploration missions away from low-Earth orbit greatly limit allowable consumables and require development of innovative low maintenance, re-configurable, and reusable systems. Minimal volume configurations (or dual use) during non-use mission phases are highly desirable.

### 4.4.1 CLOTHING SYSTEMS

Clothes have not traditionally been part of an ECLSS. However, the data here detail some of the many interfaces between crew clothing, overall crew support mass, and the Water and Waste Subsystems. The approach for ISS is to resupply disposable clothes as needed. Alternately, clothes could be cleaned and reused to significantly reduce the mass of clothes allotted per mission.

The main interfaces between other life support subsystems and a traditional laundry would be the mass of water to support an aqueous washer and the corresponding water vapor load. The water vapor load would depend on the performance of the laundry system, but assuming that most of the wash water is removed mechanically, leaving a mass of water within the fabric equal to the mass of the clothes.

Table 4.49 provides a summary of clothing and laundry options. Table 4.50 provides details of another study; the authors assumed clothing would have a useful life of 40 laundry cycles (Lunsford and Grounds, 1993). Table 4.51 and Table 4.52 provide additional summary information on space laundry trade off studies.

Equations 4.2-4.4 below are calculations using the formula developed by the Habitation team, (Villarreal, 2006), which contains variable amount of clothing based on the length of mission and a constant amount per crewmember.

$$\left[ \left( 4.99 \frac{kg}{CM} \right) + \left( 0.3323 \frac{kg}{CM-d} \times 21.1d \right) \right] \times 4CM = 48.1kg \quad \text{Equation 4.2 Clothing Needed for CEV Mission}$$

$$\left[ \left( 4.99 \frac{kg}{CM} \right) + \left( 0.3323 \frac{kg}{CM-d} \times 7d \right) \right] \times 4CM = 29.3kg \quad \text{Equation 4.3 Clothing needed for a LL Mission}$$

$$\left[ \left( 4.99 \frac{kg}{CM} \right) + \left( 0.3323 \frac{kg}{CM-d} \times 210d \right) \right] \times 4CM + \dots \quad \text{Equation 4.4 Clothing Needed for LO Mission}$$

$$\left[ \left( 4.99 \frac{kg}{CM} \right) + \left( 0.3323 \frac{kg}{CM-d} \times 30d \right) \right] \times 4CM = 358.9kg$$

**Table 4.49 Clothing and Laundry Options**

	Mass [kg]	Mass [kg/CM-d]	Volume [m <sup>3</sup> /CM-d]	Power [kW]
<b>ISS Approach (clothes shipped, single use):</b>				
From Chaput (2003)		0.343 <sup>(1)</sup> <sup>108</sup>		
From JCPC (1999)		0.718 <sup>(2)</sup>	0.0013 <sup>(2)</sup>	
From Branch (1998)		1.69 <sup>(3)</sup>	0.00135 <sup>(3)</sup>	
From Reimers and McDonald (1992)		1.47 <sup>(4)</sup>	0.00140 <sup>(4)</sup>	
<b>Using a Laundry:</b>				
Clothes		0.267 <sup>(4)</sup>	0.000351 <sup>(4)</sup>	
		0.0746 <sup>(6a)</sup>	0.00044 <sup>(6a)</sup>	
		0.0373 <sup>(6b)</sup>	0.00022 <sup>(6b)</sup>	
		0.0191 <sup>(6c)</sup>	0.00011 <sup>(6c)</sup>	
		See <sup>(7)</sup>		
Laundry Equipment	118 <sup>(4)</sup>			0.31 <sup>(4)</sup>
	80 <sup>(6)</sup>			0.751 <sup>(6)</sup>
Interfaces (Water)		12.47 <sup>(5)</sup> <sup>109</sup>		
		7.33 <sup>(6)</sup>		

**References**

- <sup>(1)</sup> Chaput (2003). Based on clothing allocation “as planned” for ISS
- <sup>(2)</sup> JCPC (1999). Based on clothing “as planned” for ISS.
- <sup>(3)</sup> Branch (1998)
- <sup>(4)</sup> Reimers and McDonald (1992)
- <sup>(5)</sup> NASA (1990)
- <sup>(6)</sup> Jeng and Ewert (2002)
- <sup>(6a)</sup> Jeng and Ewert (2002); 90 d mission duration
- <sup>(6b)</sup> Jeng and Ewert (2002); 180 d mission duration
- <sup>(6c)</sup> Jeng and Ewert (2002); 600 d mission duration
- <sup>(7)</sup> Ewert & Jeng (2015)

**Table 4.50 Early ISS Laundry Equipment Specifications**

Washer Unit	Value	Units	Comments
Mass	118	kg	
Volume	0.66	m <sup>3</sup>	
Capacity	2.7	kg/load	
Water Usage	49	kg/load	Effluent is greywater. This unit does not release water vapor.
Crewtime	0.33	CM-h/load	Load, remove, fold, and stow clothes.
Energy	3.3	kWh/load	
Consumables	0.0024	kg/load	Detergent

**References**

From Lunsford and Grounds (1993) with updates from material presented at the ALS Systems Workshop (1998). This information is based on the laundry originally under development for ISS.

<sup>108</sup> Chaput (2003) gives ISS planning values for clothing of 10.3 kg per crewmember per 30 days.

<sup>109</sup> The laundry uses clean water and provides a waste stream of greywater to the water recovery system.

**Table 4.51 Recent Laundry Break-Even Studies and Their Major Parameters**

Study	Missions	Crew	Author	Clothing Supply Rate, kg/CM - day	WRS Technologies used in the study	Break-Even Time, days	Report Year
“Lunar Outpost Technologies Break- Even Study”	Lunar Outpost	4	Perka A	0.486	VPCAR w/out AES PMWC- Lyoph Storage	144 - 851	2007
“Clothing for Lunar Outpost”	Lunar Outpost	4	Drysdale A.	0.625	Closed water processing system	24 - 81	2006
“Trade Study on Laundry Systems for Advanced and ISS Missions”	Mars	6	Jeng F., and Ewert M.	0.486	Biological Water Recovery System.	145 - 290	2002
“Laundry Study for Constellation” <sup>110</sup>	Lunar Outpost or Mars	4	Jeng F.	0.382 <sup>a 111</sup> 0.500 <sup>b</sup>	VPCAR w/out AES	240 <sup>a</sup> 180 <sup>b</sup>	2008
“Will Astronauts Wash Clothes on the Way to Mars?”	Mars	4	Ewert M. and Jeng F.	0.206	ISS	770 (440 w/ other items)	2015

Symbols <sup>a</sup> and <sup>b</sup> relate the supply rate with the breakeven time

**Table 4.52 Advanced Washer/Dryer Specifications**

Washer Unit	Value	Units	Comments	Reference
Mass	80	kg		From Jeng and Ewert (2002)
Volume	0.18	m <sup>3</sup>		
Capacity	4.5	kg/load	Clothes	
Water Usage	51.3 <sub>112</sub>	kg/load	Effluent is greywater. This unit does not release water vapor.	
Crewtime	0.42	CM-h/load	Load, remove, fold, and stow clothes.	
Energy	0.95 <sub>113</sub>	kWh/load	Low setting	
Consumables	0.010	kg/load	Detergent	

<sup>110</sup> The data cited here was calculated using the assumptions of four clothes washes per week, and one towel washed per week.

<sup>111</sup> Actual ISS clothes supply average among missions EXP 9 and EXP 13

<sup>112</sup> A washer using ozone, O<sub>3</sub>, for the detergent will use less water. Energy usage, however, increases to support ozone production.

<sup>113</sup> Corresponding energy usage values: The washer cycle is 40 minutes at 300 W, and the dryer cycle is 60 minutes at 750 W.

#### **4.4.2 STOWAGE SYSTEMS**

Interior/exterior stowage systems are required that maximize usable volume and include contents identification and inventory control systems. Long-term external stowage for biological or other wastes on a planetary surface that is safe and consistent with planetary protection policies will be needed. One example of a planned stowage system is the EVA and Crew Survival System currently planned for Orion (Table 4.53).

**Table 4.53 Estimates of Mass and Volume for Stowed EVA Suits and Emergency Suits**

<b>System</b>	<b>Subsystem</b>	<b>Unit Volume, m<sup>3</sup></b>	<b>Length, m</b>	<b>Width, m</b>	<b>Height, m</b>	<b>Unit Mass, kg</b>	<b>Stowed Volume (4 CM) m<sup>3</sup></b>	<b>Mass, kg</b>
EVA& CREW SURVIVAL	Pressure Suits&Equipment for Launch	0.188	0.575	0.574	0.574	37.3	0.750	149.1
	Suits&Equipment for Post Landing	0.004	0.160	0.160	0.160	1.81	0.016	7.21
	Emergency O2	0.495	0.457	0.178	0.040	4.54	0.209	18.1
	Umbilicals (5 CM)	0.025	3.050	0.090	0.090	6.35	0.124	31.8

#### **4.4.3 WARDROOM SYSTEMS**

Wardroom Systems are erectable or inflatable systems that support crew dining, conference, external viewing (windows), illumination, and relaxation activities. This includes off-nominal events, such as emergency medical or equipment repair. The Wardroom system typically does not have an ECLSS interface. However, some crew functions such as eating, emergency medical, or repair activities may require functions to capture particulate or liquid material.

#### **4.4.4 CREW HYGIENE SYSTEMS**

Crew Hygiene Systems are low maintenance/self-cleaning fecal, urine, menstrual, emesis, hand/body wash, and grooming systems. Specific areas include non-foaming separators and no-rinse/non-alcohol hygiene products. On ISS, full-body hygiene is conducted by dispensing a small amount of water into a wash cloth and taking a sponge bath. The wash cloth and towel are allowed to air dry to recover water via the air system condensing heat exchanger. No dedicated area is defined for drying hygiene items and it has resulted in periodic surface mold growth on ISS. Future areas should incorporate a dedicated drying area with antimicrobial treatments. Long-term missions should improve full-body hygiene.

Toilet systems should consider air, liquid, vacuum, and low-gravity transport methods. Collected waste should be prepared for recovery or long-term stabilization. Urine pretreatment systems may be part of the toilet hardware system but their development is part of the water recovery system. Integrated hygiene systems should provide, acoustic and odor isolated private crew volumes compatible with multi-gravity interfaces.

#### **4.4.5 CREW ACCOMMODATION SYSTEMS**

Habitation systems should consider the following general crew accommodation system functions: configurable crew volumes, multi-use work stations, crew radiation exposure mitigation, physically and psychologically ergonomic personal volumes, automated deployment, quiescent operations between missions, multi-purpose stowage systems, and automated housekeeping.

ISS currently has dedicated crew quarter (CQ) volumes with ~250 lbs of integrated radiation shielding material. For exploration, minimal mass deployable crew quarters that can utilize logistics and processed waste for radiation shielding are desired. Approximately 5% of ISS CQ mass and ~15% of ISS CQ volume was dedicated to acoustic mitigation. For exploration, low mass and volume acoustic mitigation using active noise cancellation of ventilation ducts and open cabin environments are potential approaches. Active quiet fan development will also reduce the need for both passive and active noise mitigation.

#### **4.4.6 GALLEY SYSTEMS**

Galley systems are systems requiring minimal crew preparation (heating, cooling, and rehydration) for food heating and accurate water dispensing. Specific areas include systems that allow individual crew meal flexibility and high-energy efficiency. Conductive heating of food is typically used because of its low average power and ability to minimize hot spots in foods that may have variable water content (dehydrated foods to which water has been added). A forced convective oven may offer reduced heating times when combined with a conductive heating element. Although microwave ovens are typically faster for terrestrial applications, the variability of rehydrated food moisture and the use of metallic foil food packaging to help limit oxygen diffusion into the food (which shortens shelf life), generally prevents the use of microwaves in space flight.

The rehydration system is generally one of the distribution points of the water processing system. The rehydration system requires protection of back contamination of food and microorganisms that may develop from the food/rehydration system interface. On ISS, the food package septum and rehydration system needle leaked water due to crew manipulation of the food package and resulted in fouling and eventual replacement of the food hydration interface. The rehydration system also requires long life point-of-use microbial filters to protect the water processor. The rehydration system may also require removal of the water processor biocide if the crew cannot tolerate consumption for long periods of time (e.g., ISS iodine/iodide biocide must be removed by ion exchange (I/X) prior to rehydrating food).

#### **4.4.7 HABITAT LIGHT OUTPUT AND DISTRIBUTION**

ISS originally was outfitted with primarily florescent lighting, which typically required small amounts of mercury within the glass tubes. The glass tubes of florescent lighting needed to be protected to contain glass particles in the event the tubes were inadvertently broken. During the last 10 years, the efficiency of florescent

lights has been matched and exceeded by light emitting diode (LED)-based lighting and is an inherently directional light offering better control than sources like incandescent, fluorescent, or metal halide lamps. In addition, LEDs are solid state devices that contain no mercury and have a long operating life, up to five times that of arc discharge lamps (Bourget, 2008). If properly designed to direct light where it is needed, LED fixtures can provide efficient, uniform lighting at the desired illumination for space habitats and vehicles (Roberts, 2008; Bourget, 2008; Shultz 2009). LED technology is envisioned to be the primary technology for future vehicles. In general, commercial industry will drive the technology and only require adaption of thermal dissipation from LED technology for microgravity space applications. LED operating temperature must be controlled to prevent excessive heating from decreasing their high light output efficiency and long life. There is medical research in the area of multispectral lighting to control circadian rhythm and improve sleep. These may be useful in future long-duration missions, especially if more than one crew shift is required.

## **4.5 FOOD INTERFACE**

Food, though historically omitted from life support analysis, has significant impacts on closure and the cost of crew support. In particular, food, if grown on-site, can regenerate some or all of the crew's air and water. If more than about 25% of the food, by dry mass, is produced locally, all the required water can be regenerated by the same process. If approximately 50% or more of the food, by dry mass, is produced on-site, all the required air can be regenerated by the same process (Drysdale, *et al.*, 1997). The former value depends on the crop and growth conditions. The latter number, however, depends on the cropping scenario and the overall harvest index.

### **4.5.1 PHYSICAL PARAMETERS FOR HISTORICAL FOOD FLIGHT SYSTEMS**

The crew food energy requirement will depend on the crew themselves, their lean body mass in particular, and the amount of physical work they perform. EVA, for example, requires additional food energy compared with crews conducting only intravehicular activities (IVAs) because more physical work is typically associated with an EVA. Unless specified otherwise, this document assumes an average body mass of 82 kg, and an intravehicular metabolic requirement of 12.99 MJ/CM-d, which are consistent with ELS RD (2008) and derived from NASA (1991).

The mass of food required depends heavily on the lipid content and the degree of hydration. A 30% lipid content, by metabolic energy, is generally recommended though much lower levels of lipids have been suggested by some sources. Degree of hydration is largely a function of the type of food, and the method of processing and storage. Fresh foods can have as much as 99% water content, by mass, whereas dehydrated foods have as little as 3% moisture.

Food quality is not specifically discussed here, because this topic is addressed when the Food Subsystem is designed. However, food quality can have a tremendous impact on crew morale and the success of a long-duration mission. The mass of food also depends on food quality. Digestibility will also vary, being lowest for vegetarian diets. As noted above, these factors are currently beyond the scope of this discussion.

Besides the mass of food itself, food requires packaging and/or appropriate containment to protect it from degradation and contamination. Packaging includes wrapping and/or boxes around the food itself, such as for individual servings. The material of the packaging is a strongly driven by the requirement to minimize oxygen permeation from the atmosphere. Oxygen will generally react with food and cause spoilage and reduced shelf life. Currently, the ISS type food packaging only provides a shelf life of ~18 months or less for most food items. NASA's Human Research Program recognizes this as a risk for exploration but to date there has been limited development of new materials. Appropriate containment describes stowage, such as food lockers, provision of a suitable atmosphere, temperature, and other environmental conditions, such as freezers for some foods, and secondary structure to house the stowage and environmentally conditioned chambers. Section 3.2.4 provides estimates for supporting secondary structure with the Food Subsystem. Analysis indicates that an additional ~17 % mass penalty, based on fresh food mass, is appropriate for individually packaged meals. Note that the values presented in Table 4.54 are historical or predicted averages for the indicated programs and, therefore, may or may not provide the current requirements for metabolic energy.

**Table 4.54 Historical and Near-Term Food Subsystem Masses**

Parameter	Mass [kg/CM-d]	Volume [m <sup>3</sup> /CM-d]	Comments	Water Content [%]
IVA Food, dw	0.67 <sup>(1)</sup>		A Reference Value	0 <sup>(1)</sup>
<b>Space Transportation Food System</b>				
STS Food <sup>114</sup>	0.66 <sup>(2)</sup>		Food Dehydrated, 11.82 MJ/CM-d	0 <sup>(2)</sup>
	1.147 <sup>(2)</sup>		Food As-Shipped, No Packaging, 11.82 MJ/CM-d	42 <sup>(2)</sup>
	0.26 <sup>(2)</sup>		Packaging Alone (clean)	
	0.35 <sup>(2)</sup>		Container Mass (ISS “Pantry-style storage”) without secondary structure	
	1.76 <sup>(2)</sup>	0.0048 <sup>(2)</sup>	Food As-Shipped, Packaged (ISS “Pantry-style storage”), and within a Container	42 <sup>(2)</sup>
<b>International Space Station Food Systems</b>				
ISS	1.83 <sup>(3)</sup>	0.00472	Food As-Shipped, Packaged	

**References**

- <sup>(1)</sup> MSIS (1995), Section 7.2.2.2.3
- <sup>(2)</sup> Levri (2002)
- <sup>(3)</sup> Perchonok, *et al.* (2002)

**Table 4.55 A 10-Day Menu for Short-Term Missions**

Mission Day	Mass, kg	Energy, MJ	Rehydration Water, liters (l)
1	1.60	12.41	2.99
2	1.68	13.01	2.67
3	1.45	12.41	2.45
4	1.26	12.33	2.67
5	2.04	13.27	2.31
6	1.38	12.37	2.81
7	1.82	13.21	2.16
8	1.16	11.97	2.70
9	1.23	12.36	2.52
10	1.68	12.53	2.72

For a food system based on the Shuttle Training Menu, as detailed above, Levri (2002) lists the properties of the rehydration apparatus and conduction oven collectively as 36.3 kg occupying 0.094 m<sup>3</sup> based on the Shuttle galley. During use, the rehydration apparatus consumes up to 0.540 kW to heat water. The

<sup>114</sup> Space Transportation System (STS) food systems are provided for reference only. They do not meet nutritional requirements for long-duration space flight. (For example, while this diet meets all minimum nutritional requirements, it exceeds the limit for sodium and iron for a weightless diet.) These food systems do not use any refrigeration. Historically, in a personal communication with C. Bourland (May 25, 1999) he reported an empty locker for food aboard Shuttle has a mass of 6.4 kg. Filled, this locker holds up to 42 individual meals (Perchonok, *et al.*, 2002). The overall locker mass, when filled, is 24.5 kg (personal communication with C. Bourland (May 25, 1999)). This is equivalent to 0.583 kg/meal, or 1.75 kg/CM-d. The Shuttle food system is shelf-stable without any frozen components. Note that assessments from Levri (2002) assume ISS “Pantry-style storage” and not Shuttle lockers.



conduction oven, when operational, consumes up to 0.360 kW for heaters and 0.060 kW for fans. Thus, the maximum total power load for the galley is 0.960 kW during operation.

Perchonok, *et al.* (2002) reports that a loaded ISS food container for Phase II averages 5.5 kg each and contains nine meals plus snacks. This is equivalent to a single day's food for three ISS crewmembers. This is equivalent, on average, to 0.611 kg/meal, assuming snacks are extensions of the standard meals, or 1.83 kg/CM-d. Individual food container masses vary according to individual crew entrée preferences and nutritional requirements, and the containers themselves are placed in racks, incurring a secondary structure penalty not included in the masses above.

Cooper (2011) and Cooper (2012) discuss exploration food systems, including those which contain a bio-regenerative component.

#### 4.5.2 PHYSICAL PARAMETERS OF REFRIGERATION EQUIPMENT

Table 4.56 presents characteristics for the ISS refrigerator/freezer technology. These units were designed, but the ISS Program decided not to launch them or the planned frozen food system. The internal volume and internal load apply to the internal refrigerator or freezer cargo capacity within a single unit assigned to a single rack, while the other parameters generally describe the exterior properties of the overall unit. ISS later added a small refrigerator for the crew.

Each previously mentioned ISS refrigerator/freezer was designed to fit within one ISS rack and had four cold volume compartments, each with a dedicated thermoelectric thermal control system. The refrigerator/freezer could operate in one of three modes, depending on the thermostat settings for the internal compartments. In the freezer mode, all four compartments operate as freezers; in the refrigerator mode, all four compartments operate as refrigerators; and in the refrigerator/freezer mode, two compartments operate as refrigerators while the other two compartments operate as freezers. The overall system thermodynamic coefficient of performance (COP<sub>s</sub>) for the ISS refrigerator/freezer in freezer mode is 0.36 (Ewert, 2002a). Waste heat is rejected to the internal thermal control loops. The unit was designed to have an operational lifetime of 10 years, with servicing provided on the ground once a year.

**Table 4.56 International Space Station Refrigerator / Freezer Properties**

	Units	Freezer Mode	Refrigerator / Freezer Mode
Unit Mass	kg	321.0 <sup>(1)</sup>	321.0 <sup>(1)</sup>
Secondary Structure Mass	kg	91 <sup>(2)</sup>	91 <sup>(2)</sup>
Volume, Including Rack	m <sup>3</sup>	2.00 <sup>(3)</sup>	2.00 <sup>(3)</sup>
Volume, Without Rack	m <sup>3</sup>	1.16 <sup>(3)</sup>	1.16 <sup>(3)</sup>
Power	kW	0.268 <sup>(4)</sup>	0.205 <sup>(4)</sup>
Thermal Control	kW	0.297 <sup>(4)</sup>	0.228 <sup>(4)</sup>
Crewtime	CM-h/y	0 <sup>(1)</sup>	0 <sup>(1)</sup>
Logistics	kg/y	321.0 <sup>(1)</sup>	321.0 <sup>(1)</sup>
Internal Load	kg	295 <sup>(1)</sup>	295 <sup>(1)</sup>
Internal Volume	m <sup>3</sup>	0.614 <sup>(1)</sup>	0.614 <sup>(1) 115</sup>

#### References

- (1) Toups, *et al.* (2001)
- (2) Personal communication with C. Shepherd in 2001
- (3) Vonau (2002)
- (4) Winter, *et al.* (2001)

More generally, Table 4.57 lists properties for frozen food storage per frozen-food-mass (ffm) basis. The nominal and low values reflect advanced or anticipated technologies, while the high values are based on ISS technology. Vapor compression and Stirling refrigeration technologies are more efficient, generally exhibiting higher COP<sub>s</sub> values than thermoelectric approaches. However, these advanced technologies are at low technology readiness and require further development to meet space flight requirements, especially with respect to weightlessness and acoustics (Ewert, 2002).

<sup>115</sup> In refrigerator/freezer mode, half of the internal cold volume is a refrigerator while the other half is a freezer.

As described in Ewert (2002) and presented in Equation 4.5, the specific power consumption for a cooled volume within a cabinet,  $\hat{W}_{RF}$  [kW/kg<sub>ffm</sub>], may be expressed as an empirical function of two system-level values, the composite thermal resistance,  $R_S$  [m<sup>2</sup>•K/kW], and COP<sub>S</sub> [kW<sub>electrical</sub>/kW<sub>thermal</sub>].  $R_S$  characterizes the overall resistance to heat transfer to or from a cooled volume, such as a refrigerator or freezer, through the cabinet wall accounting for insulation, door seals, and any other pathways for heat transfer. COP<sub>S</sub> is the system-level coefficient of performance defined as the net heat removed from the cooled volume divided by the total electrical power consumed by the refrigerator or freezer unit including the heat pump cycle and all supporting equipment. The assumed frozen food density within the cooled volume, including packaging and gaps, is 480 kg/m<sup>3</sup>. The assumed air temperature within the cooled volume is -22°C, while the ambient external cabin temperature is 23°C.

$$\hat{W}_{RF} = 1.028 \left( \frac{1}{R_S} \right) \left( \frac{1}{COP_S} \right) \quad \text{Equation 4.5}$$

**Table 4.57 Frozen Food Storage on a Property per Frozen-Food-Mass Basis**

Characteristic	Units	Assumptions			References
		low	nominal	high	
1/COP <sub>S</sub>	$\frac{kW_{\text{electrical}}}{kW_{\text{thermal}}}$	0.5 <sup>(1)</sup>	1.0 <sup>(1)</sup>	9.2 <sup>(1)</sup>	<sup>(1)</sup> Personal Communication with M. Ewert in 2002 <sup>(2)</sup> Toups, <i>et al.</i> (2001) <sup>(3)</sup> Rodriguez and England (1998) <sup>(4)</sup> Vonau (2002)
1/R <sub>S</sub>	kW/m <sup>2</sup> •K × 10 <sup>-3</sup>	0.28 <sup>(1)</sup>	0.32 <sup>(1)</sup>	0.32 <sup>(1)</sup>	
Mass <sup>116</sup>	kg		220 <sup>(4)</sup>	321 <sup>(2)</sup>	
	kg/kg <sub>ffm</sub>		0.75	1.09	
External Volume, Including Rack	m <sup>3</sup>		TBD	2.00 <sup>(3)</sup>	
	m <sup>3</sup> /kg <sub>ffm</sub> × 10 <sup>-3</sup>			6.78	
External Volume, Excluding Rack	m <sup>3</sup>		1.16 <sup>(4)</sup>		
	m <sup>3</sup> /kg <sub>ffm</sub> × 10 <sup>-3</sup>		3.93		
Power	kW	0.048 <sup>(1)</sup>	0.096 <sup>(1)</sup>	0.268 <sup>(1)</sup>	
	kW/kg <sub>ffm</sub> × 10 <sup>-3</sup>	0.16	0.33	0.91	
Thermal Control	kW	0.053 <sup>(1)</sup>	0.106 <sup>(1)</sup>	0.297 <sup>(1)</sup>	
	kW/kg <sub>ffm</sub> × 10 <sup>-3</sup>	0.18	0.36	1.01	
Crewtime	CM-h/y	0.0	0.0	0.0	
	CM-h/(y•kg <sub>ffm</sub> )	0.0	0.0	0.0	
Logistics	kg/y	0.0	0.0	321 <sup>(2)</sup>	
	kg/(y•kg <sub>ffm</sub> )	0.0	0.0	1.09	

### 4.5.3 CREWTIME FOR THE FOOD SUBSYSTEM

Overall crewtime requirements in the galley depend on the form in which food is shipped and its preparation requirements. Crewtime required for food preparation during Space Transportation System (STS, or Shuttle) missions was 45 to 90 minutes per day for a crew of up to six (NASA, 1996). This approach uses individually packaged servings. If food preparation requires more than heating and/or re-hydration, then the additional preparation complexity increases crewtime for preparation compared with current systems. However, more involved preparation may allow for higher quality food.

Personal communication with J. Hunter in 1999 provides another estimate of crewtime for food preparation. Hunter's model assumes that each crewmember eats 10 different food dishes per day. For a crew of

<sup>116</sup> Including the freezer mass and rack but excluding the secondary structure.

six, each dish prepared using ingredients provided by bioregenerative methods requires 15 to 45 minutes each, while each dish taken from resupplied stocks requires an average of 6 minutes to prepare based on NASA (1996). Assuming meals prepared using bioregenerative methods each require 30 minutes, on average, to prepare, a diet based on crops grown on-site would require 5.0 CM-h/d, or 0.83 CM-h/CM-d, assuming a crew of six. Daily meals prepared completely from resupplied foods would require 1.0 CM-h/d, or 0.17 CM-h/CM-d. Assuming five dishes are prepared from crops grown on-site and five dishes are prepared from resupplied stocks, daily meal preparation time would be 3.0 CM-h/d or 0.50 CM-h/CM-d.

Kloeris, *et al.* (1998) report meal preparation time during the Lunar Mars Life Support Test Program (LMLSTP) Phase III test while using the 10-day BIO-Plex menu averaged 4.6 CM-h/d.

There will also be crewtime requirements to process the crops into edible food ingredients. These times, though expected to be significant, have not been estimated to date.

#### 4.5.4 FOOD SUBSYSTEM WASTE GENERATION

Wastage will depend on the type of food and the type of preparation, but can be quite large. For example, during the 10-day BIO-Plex menu test conducted during the LMLSTP Phase III, total waste, including preparation, plate waste, and unused, leftover food, was 42% (Kloeris, *et al.*, 1998). Typically much-lower values are assumed for prepackaged food systems. Wastage occurs both due to food adhering to packaging and due to plate wastage. Waste model values are noted below and in Section Table 4.44 for both historical pre-packaged food systems and projected food systems based on crops from bioregenerative life support systems.

#### 4.5.5 OVERALL FOOD SUBSYSTEM PARAMETERS

Typical values from the literature for food-related masses are shown in Table 4.58. However, the food mass values here do not reflect as great a range as is associated with the metabolic gas exchange values in Table 4.1. The listed food masses in Table 4.58 are “as shipped” and before addition of any hydration fluid and reflect historical pre-packaged food systems, although the upper value for crewtime is associated with a Food Subsystem using crop products derived from a biomass production chamber.

**Table 4.58 Food Quantity and Packaging**

Parameter	Units	Assumptions			References
		lower	nominal	upper	
IVA Food, dry mass <sup>117</sup>	kg/CM-d	0.54 <sup>(8)</sup>	0.617 <sup>(1)</sup>	0.66(TBR) <sup>(2)</sup>	(1) NASA (1991)
IVA Human Metabolic Water Production	kg/CM-d		0.345 <sup>(1)</sup>		(2) Levri (2002)
IVA Energy	MJ/CM-d		11.82 <sup>(1)</sup>		(3) Personal communication with M. Perchonok in 2001 and NASA (1991)
IVA Potable Water Consumption	kg/CM-d		3.909 <sup>(3)</sup>		(4) Derived from McBarron, <i>et al.</i> (1993); metabolic rate of 293 W/CM and a respiratory quotient of 0.9.
EVA Food, dry mass, added <sup>118</sup>	kg/CM-h		+ 0.029 <sup>(4)</sup>		(5) Personal communication with M. Rouen in 2001
EVA Metabolic Water Production added <sup>118</sup>	kg/CM-h		+ 0.016 <sup>(4)</sup>		(6) NASA (1996)
EVA Energy added <sup>118</sup>	MJ/CM-h		+ 0.570 <sup>(5)</sup>		(7) Kloeris, <i>et al.</i> (1998)
EVA Potable Water Consumption	kg/CM-h			0.24 <sup>(1)</sup>	(8) ELS RD (1998)
Packaging <sup>119</sup>	kg/kg food		+ 16.5 %		
Crewtime	CM-h/d	1 – 1.5 <sup>(6)</sup>	1.5 <sup>(6)</sup>	4.6+ <sup>(7)</sup> 120	

<sup>117</sup> On a dry mass (dw) basis.

<sup>118</sup> EVA requirements are in addition to any IVA requirements.

<sup>119</sup> Source: 2014 Logistics Reduction model v.2.5. Packaging accounts for individual food packages only. Secondary structure, lockers, and trays are additional.

#### 4.5.6 FOOD SUBSYSTEM BASED ON BULK PACKAGING <sup>121</sup>

French and Perchonok (2006) recently developed a 10-day menu using a bulk commodity supply approach that may serve as a basis for estimates for supplying food via such an approach. Specifically, this approach endeavors to reduce packing mass and storage volume by packing food commodities in bulk. This benefit is offset by increasing crewtime to prepare meals and adding some additional food processing equipment to enable more complicated food preparation processes. This approach also increases overall menu shelf-life by storing food commodities in a form that is inherently more stable, thus assuring better food quality for longer-duration missions. Finally, because some commodities cannot be successfully stored in any form, this approach assumes a biomass production facility to provide salad crops, white potatoes, and sweet potatoes. The initial study assumed a 600-day surface mission on Mars, but the format presented below should be applicable to missions of any duration with the most direct benefit derived from those of longer durations. The presentation here is, by necessity, abbreviated and interested readers should consult French and Perchonok (2006) for additional information.

##### 4.5.6.1 COMMODITIES

Table 4.59 provides a listing on the ingredients for the 10-day, bulk-commodity menu on a per-crewmember per-day basis. The “daily menu ingredient mass” is the ingredient mass required by the menu recipes. The list containing “nominal unprocessed ingredient mass” also contains the expected ingredient input prior to processing assuming the “nominal yield,” to produce the “daily ingredient mass.” When the yield varied, French and Perchonok (2006) also provided different minimum and maximum yield values. More precisely, these values are a specific volume of  $1.33 \times 10^{-3} \text{ m}^3/\text{kg}$  for dry beans, peanuts, rice, soybean, wheat, and liquid resupply items. Specific volume factors of  $1.78 \times 10^{-3}$ ,  $7.69 \times 10^{-3}$ , and  $7.3 \times 10^{-4} \text{ m}^3/\text{kg}$  are used for powder, leafy, and granule resupply items, respectively, while a specific volume factor of  $2.5 \times 10^{-3} \text{ m}^3/\text{kg}$  is used for resupply pasta items. Because some ingredients, denoted as salad, sweet potato, or white potato inputs in the “source” column, are derived from a limited biomass production facility, the corresponding volume is not listed implying that these ingredients are used shortly after harvest and occupy no appreciable storage volume beyond that associated with the biomass production facility. Volume for “water” is also omitted because this commodity is drawn from the life support system stores as needed.

---

<sup>120</sup> This value is derived using “ready to use” ingredients and includes no crop processing to develop ingredients. An estimate including crop processing to develop ingredients might be double this value, or ~9 CM-h/d, or more.

<sup>121</sup> Unless noted otherwise, all material in this section is derived from French and Perchonok (2006).

**Table 4.59 Ingredients, Commodity Sources, and Yield Values on a Per-Crewmember Per-Day Basis for 10-Day, Bulk-Commodity Menu**

<b>Ingredient</b>	<b>Source</b>	<b>Daily Menu Ingredient Mass [g/CM-d]</b>	<b>Minimum Yield</b>	<b>Nominal Yield</b>	<b>Maximum Yield</b>	<b>Nominal Unprocessed Ingredient Mass [g/CM-d]</b>	<b>Specific Volume Factor [m<sup>3</sup>/kg]</b>	<b>Nominal Unprocessed Ingredient Volume [m<sup>3</sup>/CM-d]</b>
allspice	resupply	0.015	100%	100%	100%	0.015	0.00178	$2.670 \times 10^{-8}$
baking powder	resupply	1.108	100%	100%	100%	1.108	0.00178	$1.973 \times 10^{-6}$
baking soda	resupply	0.020	100%	100%	100%	0.020	0.00178	$3.560 \times 10^{-8}$
basil, dried/leaves	resupply	0.363	100%	100%	100%	0.363	0.00769	$2.794 \times 10^{-6}$
bay leaf, dried	resupply	0.007	100%	100%	100%	0.007	0.00769	$5.127 \times 10^{-8}$
bell pepper, whole	salad	21.500	40%	45%	50%	47.778	n/a	n/a
black beans, uncooked	dry bean	9.540	100%	100%	100%	9.540	0.00133	$1.269 \times 10^{-5}$
black pepper	resupply	0.249	100%	100%	100%	0.249	0.00178	$4.440 \times 10^{-7}$
bouillon cube, beef	resupply	0.600	100%	100%	100%	0.600	0.00073	$4.380 \times 10^{-7}$
bouillon cube, chicken	resupply	1.508	100%	100%	100%	1.508	0.00073	$1.100 \times 10^{-6}$
brown rice, uncooked	rice	8.992	100%	100%	100%	8.992	0.00133	$1.196 \times 10^{-5}$
butter sprinkles	resupply	0.020	100%	100%	100%	0.020	0.00073	$1.460 \times 10^{-8}$
cabbage, shredded	salad	3.750	85%	90%	95%	4.167	n/a	n/a
carrot, whole	salad	45.957	55%	60%	65%	51.063	n/a	n/a
carrots, grated	salad	7.661	55%	60%	65%	12.769	n/a	n/a
carrots, shredded	salad	8.272	55%	60%	65%	13.786	n/a	n/a
carrots, sliced/chopped	salad	11.437	55%	60%	65%	19.061	n/a	n/a
cayenne pepper	resupply	0.025	100%	100%	100%	0.025	0.00178	$4.450 \times 10^{-8}$
chili powder	resupply	0.250	100%	100%	100%	0.250	0.00178	$4.450 \times 10^{-7}$
cilantro, dried	resupply	0.030	100%	100%	100%	0.030	0.00769	$2.307 \times 10^{-7}$
cinnamon	resupply	0.155	100%	100%	100%	0.155	0.00178	$2.759 \times 10^{-7}$
cloves, ground	resupply	0.004	100%	100%	100%	0.004	0.00178	$7.417 \times 10^{-9}$
cocoa powder	resupply	4.938	100%	100%	100%	4.938	0.00178	$8.790 \times 10^{-6}$
coffee, instant	resupply	0.133	100%	100%	100%	0.133	0.00073	$9.733 \times 10^{-8}$
coriander, ground	resupply	0.035	100%	100%	100%	0.035	0.00178	$6.181 \times 10^{-8}$
coriander, seeds	resupply	0.016	100%	100%	100%	0.016	0.00073	$1.196 \times 10^{-8}$
cornstarch	resupply	1.070	100%	100%	100%	1.070	0.00178	$1.905 \times 10^{-6}$
cumin	resupply	0.284	100%	100%	100%	0.284	0.00178	$5.053 \times 10^{-7}$

**Table 4.59 Ingredients, Commodity Sources, and Yield Values on a Per-Crewmember Per-Day Basis for 10-Day, Bulk-Commodity Menu**

<b>Ingredient</b>	<b>Source</b>	<b>Daily Menu Ingredient Mass [g/CM-d]</b>	<b>Minimum Yield</b>	<b>Nominal Yield</b>	<b>Maximum Yield</b>	<b>Nominal Unprocessed Ingredient Mass [g/CM-d]</b>	<b>Specific Volume Factor [m<sup>3</sup>/kg]</b>	<b>Nominal Unprocessed Ingredient Volume [m<sup>3</sup>/CM-d]</b>
dill weed, dried	resupply	0.091	100%	100%	100%	0.091	0.00769	6.964 × 10 <sup>-7</sup>
egg, dried/white	resupply	0.233	100%	100%	100%	0.233	0.00178	4.153 × 10 <sup>-7</sup>
egg, dried/whole	resupply	2.912	100%	100%	100%	2.912	0.00178	5.183 × 10 <sup>-6</sup>
elbow macaroni, uncooked	resupply	3.150	100%	100%	100%	3.150	0.00250	7.875 × 10 <sup>-6</sup>
extract, almond	resupply	0.173	100%	100%	100%	0.173	0.00133	2.298 × 10 <sup>-7</sup>
extract, maple	resupply	0.010	100%	100%	100%	0.010	0.00133	1.293 × 10 <sup>-8</sup>
extract, vanilla	resupply	3.738	100%	100%	100%	3.738	0.00133	4.971 × 10 <sup>-6</sup>
garlic, granulated	resupply	0.606	100%	100%	100%	0.606	0.00073	4.421 × 10 <sup>-7</sup>
garlic, powder	resupply	0.514	100%	100%	100%	0.514	0.00178	9.147 × 10 <sup>-7</sup>
ginger, dried/ground	resupply	0.078	100%	100%	100%	0.078	0.00178	1.389 × 10 <sup>-7</sup>
green onion, chopped	salad	11.335	85%	95%	95%	11.932	n/a	n/a
kidney beans, uncooked	dry bean	3.017	100%	100%	100%	3.017	0.00133	4.012 × 10 <sup>-6</sup>
lemon juice	resupply	0.808	100%	100%	100%	0.808	0.00133	1.075 × 10 <sup>-6</sup>
lentils, uncooked	dry bean	13.007	100%	100%	100%	13.007	0.00133	1.730 × 10 <sup>-5</sup>
lettuce	salad	2.815	85%	90%	95%	3.128	n/a	n/a
lime juice	resupply	0.009	100%	100%	100%	0.009	0.00133	1.219 × 10 <sup>-8</sup>
mustard, ground	resupply	0.273	100%	100%	100%	0.273	0.00178	4.851 × 10 <sup>-7</sup>
navy beans, uncooked	dry bean	7.313	100%	100%	100%	7.313	0.00133	9.726 × 10 <sup>-6</sup>
nutmeg, ground	resupply	0.015	100%	100%	100%	0.015	0.00178	2.670 × 10 <sup>-8</sup>
oil, peanut	peanuts	24.578	30%	35%	40%	70.223	0.00133	9.340 × 10 <sup>-5</sup>
onion, dried/flakes	resupply	9.173	100%	100%	100%	9.173	0.00769	7.054 × 10 <sup>-5</sup>
oregano, dried/whole	resupply	0.279	100%	100%	100%	0.279	0.00769	2.147 × 10 <sup>-6</sup>
paprika	resupply	0.035	100%	100%	100%	0.035	0.00178	6.230 × 10 <sup>-8</sup>
parsley, dried	resupply	0.294	100%	100%	100%	0.294	0.00769	2.260 × 10 <sup>-6</sup>
peanut butter	peanuts	11.022	90%	95%	100%	11.602	0.00133	1.543 × 10 <sup>-5</sup>
peanuts w/o shell	peanuts	0.677	92%	95%	98%	0.713	0.00133	9.481 × 10 <sup>-7</sup>
pinto beans, uncooked	dry bean	4.962	100%	100%	100%	4.962	0.00133	6.599 × 10 <sup>-6</sup>

**Table 4.59 Ingredients, Commodity Sources, and Yield Values on a Per-Crewmember Per-Day Basis for 10-Day, Bulk-Commodity Menu**

<b>Ingredient</b>	<b>Source</b>	<b>Daily Menu Ingredient Mass [g/CM-d]</b>	<b>Minimum Yield</b>	<b>Nominal Yield</b>	<b>Maximum Yield</b>	<b>Nominal Unprocessed Ingredient Mass [g/CM-d]</b>	<b>Specific Volume Factor [m<sup>3</sup>/kg]</b>	<b>Nominal Unprocessed Ingredient Volume [m<sup>3</sup>/CM-d]</b>
potato, white	white potato	41.933	65%	70%	75%	59.905	n/a	n/a
potato, white/peeled	white potato	15.237	60%	65%	70%	23.441	n/a	n/a
potato, white/shredded	white potato	11.067	65%	70%	75%	15.810	n/a	n/a
potato, white/sliced/diced	white potato	2.833	65%	70%	75%	4.048	n/a	n/a
radish	salad	1.068	45%	50%	55%	2.137	n/a	n/a
red pepper flakes	resupply	0.014	100%	100%	100%	0.014	0.00769	1.047 × 10 <sup>-7</sup>
rosemary, dried	resupply	0.005	100%	100%	100%	0.005	0.00769	4.059 × 10 <sup>-8</sup>
sage, dried	resupply	0.041	100%	100%	100%	0.041	0.00769	3.161 × 10 <sup>-7</sup>
Salt	resupply	4.790	100%	100%	100%	4.790	0.00073	3.497 × 10 <sup>-6</sup>
savory, dried	resupply	0.033	100%	100%	100%	0.033	0.00769	2.563 × 10 <sup>-7</sup>
soy sauce powder	resupply	2.852	100%	100%	100%	2.852	0.00178	5.076 × 10 <sup>-6</sup>
soybeans, uncooked	soybean	4.750	100%	100%	100%	4.750	0.00133	6.318 × 10 <sup>-6</sup>
soymilk	soybean	237.862	688%	750%	816%	31.715	0.00133	4.218 × 10 <sup>-5</sup>
spinach	salad	27.750	85%	90%	95%	30.833	n/a	n/a
starch, instant	resupply	7.908	100%	100%	100%	7.908	0.00178	1.408 × 10 <sup>-5</sup>
strawberries	salad	28.708	30%	35%	40%	82.024	n/a	n/a
sugar, brown	resupply	0.346	100%	100%	100%	0.346	0.00073	2.523 × 10 <sup>-7</sup>
sugar, granulated	resupply	63.389	100%	100%	100%	63.389	0.00073	4.627 × 10 <sup>-5</sup>
sweet potato	sweet potato	46.567	35%	40%	45%	116.417	n/a	n/a
sweet potato, mashed	sweet potato	5.925	35%	40%	45%	14.813	n/a	n/a
sweet potato, sliced	sweet potato	22.667	35%	40%	45%	56.667	n/a	n/a
tarragon, dried	resupply	0.017	100%	100%	100%	0.017	0.00769	1.282 × 10 <sup>-7</sup>
textured soy protein	soybean	2.575	100%	100%	100%	2.575	0.00133	3.425 × 10 <sup>-6</sup>
thyme, dried	resupply	0.280	100%	100%	100%	0.280	0.00769	2.153 × 10 <sup>-6</sup>
tofu, firm	soybean	39.913	367%	400%	433%	9.978	0.00133	1.327 × 10 <sup>-5</sup>
tofu, soft	soybean	20.513	367%	400%	433%	5.128	0.00133	6.821 × 10 <sup>-6</sup>
tomato, diced	salad	51.755	40%	45%	50%	115.010	n/a	n/a
tomato, dried	salad	0.373	40%	45%	50%	0.830	n/a	n/a

**Table 4.59 Ingredients, Commodity Sources, and Yield Values on a Per-Crewmember Per-Day Basis for 10-Day, Bulk-Commodity Menu**

<b>Ingredient</b>	<b>Source</b>	<b>Daily Menu Ingredient Mass [g/CM-d]</b>	<b>Minimum Yield</b>	<b>Nominal Yield</b>	<b>Maximum Yield</b>	<b>Nominal Unprocessed Ingredient Mass [g/CM-d]</b>	<b>Specific Volume Factor [m<sup>3</sup>/kg]</b>	<b>Nominal Unprocessed Ingredient Volume [m<sup>3</sup>/CM-d]</b>
tomato, paste	salad	1.027	40%	45%	50%	2.281	n/a	n/a
tomato, sauce	salad	85.703	40%	45%	50%	190.450	n/a	n/a
tomato, whole	salad	39.385	40%	45%	50%	87.523	n/a	n/a
vinegar	resupply	7.450	100%	100%	100%	7.450	0.00133	9.909 × 10 <sup>-6</sup>
water	water	317.263	100%	100%	100%	317.263	n/a	n/a
water, cook	water	238.943	100%	100%	100%	238.943	n/a	n/a
water, ice	water	20.737	100%	100%	100%	20.737	n/a	n/a
water, rinse	water	39.500	100%	100%	100%	39.500	n/a	n/a
wheat flour	wheat	59.574	98%	99%	100%	60.176	0.00133	8.003 × 10 <sup>-5</sup>
white flour	wheat	94.234	67%	72%	77%	130.881	0.00133	1.741 × 10 <sup>-4</sup>
white pepper	resupply	0.061	100%	100%	100%	0.061	0.00178	1.078 × 10 <sup>-7</sup>
white rice, uncooked	rice	5.682	110%	115%	120%	4.941	0.00133	6.571 × 10 <sup>-6</sup>
yeast, dried	resupply	2.663	100%	100%	100%	2.663	0.00073	1.944 × 10 <sup>-6</sup>
ziti, uncooked	resupply	5.677	100%	100%	100%	5.677	0.00250	1.419 × 10 <sup>-5</sup>



#### 4.5.6.2 EQUIPMENT

Equipment allows food commodities to be processed into ingredients and ultimately into palatable and nutritious food entries. The equipment selected and described here addresses one or more necessary functions. These functions are to (1) provide the ingredients required by the 10-day menu, (2) keep ingredients or products viable, or (3) prepare menu items from ingredients. Because corresponding flight hardware is unavailable, the hardware below reflect commercial machines that are believed to be representative in both functionality and size to what might be designed ultimately for flight. French and Perchonok (2006) note that “the listed equipment, though smaller in size, may still be [over-sized] for missions supporting” the number of people associated with projected near-term crews. Table 4.60 and Table 4.61 list the recommended hardware to support preparation of the 10-day bulk commodity menu from bulk commodities, crops taken from a biomass production chamber, and other foodstuffs supplied to the finished menu listed by French and Perchonok (2006). Note that this level of food preparation would likely require a dishwasher, which is not listed here.

**Table 4.60 Mechanical Processor Characteristics for 10-Day Bulk Commodity Menu**

Technology	Manufacturer / Model <sup>122</sup>	Ingredient(s) Produced	Processing Rate	Unit Mass [kg]	Unit Volume [m <sup>3</sup> ]	Unit Power [kW <sub>e</sub> ]	Duty Cycle
Grind Mill	Brabender /Quadramat Jr.	wheat flour, white flour	5.9 kg/h	69	0.22	0.46	
Dehydrator	L’Equip/528	tomato, dried	n/a	4.54	0.034	0.55	
Concentrator	Armfield/FT18	tomato, paste; tomato, sauce	3 L/h	220	0.54	2.2	
Soy milk / Tofu Maker	SoyaJoy	soymilk	6 kg/h	2.95	0.015	0.8	
		tofu, firm; tofu, soft	n/a				
Oil Press	Skeppsta Maskin AB /Type 20	oil, peanut	4 kg/h	5.9	0.069	0.4	
Refrigerator / Freezer <sup>123</sup>	Sub Zero /700 BC		n/a	86	0.37 <sup>124</sup>	1.725	0.030

<sup>122</sup> This is for reference only and does not imply product endorsement.

<sup>123</sup> French and Perchonok (2006) recommend two refrigerator/freezer units, minimum, to support the 10-day bulk commodity menu.

<sup>124</sup> Internal capacity is 0.141 m<sup>3</sup>, divided as 0.082 m<sup>3</sup> for the refrigerator and 0.059 m<sup>3</sup> for the freezer.

**Table 4.61 Food Preparation Equipment for 10-Day Bulk Commodity Menu**

<b>Equipment Name</b>	<b>Unit Mass [kg]</b>	<b>Unit Volume [m³]</b>	<b>Unit Power [kW<sub>e</sub>]</b>	<b>Duty Cycle</b>
Baking Dish/Pan	1.50	0.004		
Biscuit Cutter	0.03	0.000		
Blender	6.70	0.015	0.6	
Bowl (Large)	0.44	0.013		
Bowl (Medium)	0.35	0.009		
Bowl (Small)	0.30	0.006		
Breadmaker	6.62	0.026	0.52	
Brillo	0.03	0.000		
Cake Pan	0.19	0.005		
Colander	0.40	0.013		
Convection Oven	174.60	1.080	5.5	
Cookie Sheet	0.33	0.002		
Food Processor #2	6.70	0.020	0.72	
Fork	0.03	0.000		
Hot Pad	0.10	0.000		
Ice Cream Maker	2.75	0.012	0.01	
Juicer	4.33	0.023	0.4	
Knife (Bread)	0.14	0.000		
Knife (Chef)	0.22	0.000		
Knife (Paring)	0.07	0.000		
Loaf Pan	0.16	0.002		
Measuring Cup	0.30	0.001		
Measuring Spoons	0.10	0.000		
Muffin Cups	0.37	0.033		
Pan (Pie)	0.16	0.003		
Pasta Maker	3.05	0.005		
Pot (Large)	3.35	0.023		
Pot (Medium)	2.28	0.014		
Pot (Small)	1.20	0.006		
Potato Masher	0.16	0.002		
Potato Peeler	0.07	0.000		
Pressure Cooker	2.70	0.016		
Range	0.00	0.000	3.35	
Rolling Pin	0.64	0.002		
Saucepan (Large)	2.36	0.014		
Saucepan (Medium)	1.77	0.010		
Saucepan (Small)	1.18	0.006		
Skillet (Large)	1.47	0.018		
Slotted Spoon	0.04	0.001		
Spatula	0.07	0.001		
Spoon, Metal	0.03	0.000		
Spoon, Wooden	0.05	0.000		
Tongs	0.08	0.001		
Tortilla Press	15.50	0.047	1.8	
Whisk	0.13	0.001		
Wire Rack	0.15	0.001		
<b>Total</b>	243.16	1.43	12.9	

#### 4.5.6.3 CREWTIME

Many food interface activities require additional mechanical inputs beyond what is currently associated with the hardware listed in Section 4.5.6.2. While it may be possible to automate some food preparation activities, historically such complex inputs are provided by human beings. Thus, here, without further analyses, it is assumed that mechanical inputs beyond those provided by the hardware listed above will be fulfilled by the crew.<sup>125</sup>

Per French and Perchonok (2006), crewtime has been classified as either active or passive time. Active time includes those activities that require the full attention of a crewmember, whereas passive time may not require the full attention of the crewmember but the task does have some level of cognitive impact. French and Perchonok (2006) include estimates of crewtime for the following activities:

- Recipe preparation
- Meal consumption
- Ingredient processing
- Equipment maintenance

##### 4.5.6.3.1 RECIPE PREPARATION, MEAL CONSUMPTION AND MEAL CLEANUP

French and Perchonok (2006) recorded preparation times for each recipe in the 10-day bulk commodity menu. Table 4.62 provides a breakdown of active and passive time for each day of the menu. For this study, French and Perchonok (2006) assumed a crew of six. Thus, a smaller crew will require less crewtime than is listed here for this same menu, but food preparation crewtime is not expected to scale linearly as a function of crew size for crews of four to six crewmembers or smaller.

**Table 4.62 Crewtime Requirements for 10-Day Bulk Commodity Menu**

<b>Event</b>	<b>Active Time [min]</b>	<b>Passive Time [min]</b>
Day 1	160	115
Day 2	145	397
Day 3	120	182
Day 4	210	700
Day 5	140	170
Day 6	155	357
Day 7	195	520
Day 8	190	185
Day 9	100	232
Day 10	115	345
Total	1,530	3,203

For this menu, a 30-minute allotment is assumed for meal consumption. Because there are three meals per day scheduled for this 10-day bulk commodity menu, this assumption becomes 90 minutes per crewmember per day. A 10-minute total allotment is assumed to cleanup each meal. Similarly, this assumption becomes 30 minutes per day to accommodate the three-meal schedule.

##### 4.5.6.3.2 INGREDIENT PROCESSING AND EQUIPMENT MAINTENANCE

French and Perchonok (2006) determined crewtime values for each piece of ingredient processing equipment based on the documented throughput capacity of the processing equipment, the mass totals of the associated ingredient(s), Table 4.59, the ingredient source nominal yield value, also Table 4.59, and estimated

<sup>125</sup> While this is one approach, it may or may not be an optimal approach. Additional testing and analysis of the benefits and costs of using automation versus the crew for various food preparation tasks is most likely necessary before this question can be addressed with any certainty.

times for indirectly associated steps. Table 4.60 provides documented throughput capacity values and French and Perchonok (2006) provide the rationale surrounding determination of estimated ingredient processing equipment crewtime values for interested readers.

During long-duration missions, food processing equipment will require maintenance of some kind. It is assumed that an additional 10% of ingredient processing time will be required to perform this function. Table 4.63 lists the associated crewtime for each of the processed ingredients per 10-day menu cycle. As with the other work in French and Perchonok (2006), this assessment assumes a crew of six.<sup>126</sup>

**Table 4.63 Ingredient Processing Equipment Crewtime Values for Each 10-Day Menu Cycle**

<b>Technology</b>	<b>Manufacturer / Model<sup>127</sup></b>	<b>Associated Ingredient(s)</b>	<b>Crewtime [CM-h]<sup>128</sup></b>
Grind Mill	C. W. Brabender /Quadramat Jr.	wheat flour white flour	2.0
Dehydrator	L'Equip/528	tomato, dried	8.0
Concentrator	Armfield/FT18	tomato, sauce tomato, paste	1.0
Soymilk /Tofu maker	SoyaJoy	soymilk tofu, soft tofu, firm	8.1
Oil Press	Skeppsta Maskin AB /Type 20	oil, peanut	1.1
Subtotal			20.0
Maintenance (10% of Subtotal)			2.0
Total			22.0

#### 4.5.6.4 NUTRITION

French and Perchonok (2006) analyzed their 10-day menu using bulk-packaged foods for nutrient content using the Nutritionist Five® database. Table 4.64 presents these results along with the corresponding Recommended Dietary Allowance (RDA) goals and NASA nutritional goals for each component.<sup>129</sup>

While the nominal daily metabolic intake for a generic 70 kg crewmember is 11.82 MJ/CM-d, and the overall metabolic energy value in Table 4.64 falls short of this goal, this menu assessment, according to French and Perchonok (2006), excludes snacks and beverages. Once they are added to this menu, the daily metabolic energy will be closer to NASA's flight requirement. Further, the inclusion of calcium fortified beverages will increase the calcium content of the menu; however, this is an area of continued focus. Other means of calcium delivery may be available to this bulk-ingredient menu that have not been used historically by NASA for human space flight programs.

<sup>126</sup> While the crewtime values here may include some setup time, so the total time expended will not scale linearly with crew size, as a first approximation linear scaling should be sufficiently accurate.

<sup>127</sup> This is for reference only and does not imply product endorsement.

<sup>128</sup> French and Perchonok developed these estimates based on a crew of six. The values here represent crewtime for one 10-day menu cycle. While the crewtime values here may include some setup time, so the total time expended will not scale linearly with crew size, as a first approximation linear scaling should be sufficiently accurate.

<sup>129</sup> While these values apply for a generic menu, French and Perchonok (2006) note that "current menu planning for shuttle was and for the International Space Station (ISS) is personalized to kilocalorie and nutrient intake requirements; some vitamins and minerals such as vitamin C, iron and biotin have adjusted requirement levels to accommodate a reduced (microgravity) gravity environment." Further, they note "Vitamin D supplements are currently provided for the ISS crewmembers' daily use."

**Table 4.64 Nutrient Values for 10-Day Bulk-Packaged Food Menu**

<b>Nutrition Parameter</b>	<b>Menu Value</b>	<b>Units</b>	<b>RDA Goal</b>	<b>NASA Goal</b>	<b>% RDA Goal</b>	<b>% NASA Goal</b>
Metabolic Energy	1,777.8 7.44	kcal/CM-d MJ/CM-d	2,000.0 8.37	-- --	89 89	-- --
<i>Macronutrients</i>						
Protein	57.3	g/CM-d	50.0	--	115	--
Carbohydrates	299.0	g/CM-d	300.0	--	100	--
Fat	43.8	g/CM-d	65.0	--	67	--
Cholesterol	50.0	mg/CM-d	300.0	300.0	17	17
Saturated Fat	7.4	g/CM-d	20.0	20.0	37	37
Dietary Fiber	38.2	g/CM-d	25.0	25.0	153	153
<i>Micronutrients</i>						
Sodium	2,984.1	mg/CM-d	2,400.0	2,400.0	124	124
Potassium	2,915.9	mg/CM-d	3,500.0	3,500.0	83	83
Vitamin A	28,233.3	IU/CM-d <sup>130</sup>	5,000.0	5,000.0	565	565
Vitamin C	110.5	mg/CM-d	60.0	100.0	184	111
Calcium	369.3	mg/CM-d	1,000.0	1,000.0	37	37
Iron	18.9	mg/CM-d	18.0	10.0	105	189
Vitamin D	5.5	IU/CM-d <sup>131</sup>	400.0	400.0	1	1
Vitamin E	13.6	IU/CM-d <sup>132</sup>	30.0	30.0	45	45
Thiamin	2.1	mg/CM-d	1.5	1.5	138	138
Riboflavin	1.4	mg/CM-d	1.7	2.0	81	70
Niacin	16.8	mg/CM-d	20.0	20.0	84	84
Vitamin B <sub>6</sub>	1.4	mg/CM-d	2.0	2.0	71	71
Folate	349.1	µg/CM-d	400.0	400.0	87	87
Vitamin B <sub>12</sub>	0.1	µg/CM-d	6.0	2.0	2	5
Biotin	21.1	µg/CM-d	300.0	100.0	7	21
Pantothenic acid	3.4	mg/CM-d	10.0	5.0	34	68
Vitamin K	145.5	µg/CM-d	80.0	80.0	182	182
Phosphorous	983.7	mg/CM-d	1,000.0	1,000.0	98	98
Magnesium	379.3	mg/CM-d	400.0	350.0	95	108
Zinc	6.9	mg/CM-d	15.0	15.0	46	46
Copper	1.9	mg/CM-d	2.0	2.0	93	93
Manganese	5.2	mg/CM-d	2.0	5.0	259	104
Selenium	0.07	mg/CM-d	0.07	0.07	98	98
Chromium	0.07	mg/CM-d	0.12	0.12	58	58
Molybdenum	29.5	µg/CM-d	75.0	75.0	39	39

#### 4.5.7 FOOD SUBSYSTEMS BASED ON BIOMASS PRODUCTION SYSTEMS

Crops within a biomass production chamber will likely be grown and harvested on a bulk basis, rather than quasi-continuously. This assumption is designed to minimize crewtime requirements by making crew activities more efficient, and may be revisited when more data are available. The three diets presented here assume differing availabilities for crops grown on-site. Table 4.65 provides wet or fresh masses for the dietary

<sup>130</sup> 1 International Unit (IU) of Vitamin A is the biological equivalent of 0.3 µg retinol, or of 0.6 µg beta-carotene.

<sup>131</sup> 1 International Unit (IU) of Vitamin D is the biological equivalent of 1/40 µg, exactly, cholecalciferol / ergocalciferol.

<sup>132</sup> 1 International Unit (IU) of Vitamin E is the biological equivalent of 2/3 mg, exactly, of d-alpha-tocopherol or of 1 mg of dl-alpha-tocopherol acetate.

components, as received from the Biomass Subsystem, while Table 4.66 provides the corresponding nutritional information.

**Table 4.65 Menu Masses for Diets Using Advanced Life Support Crops and Resupplied Foods**  
 [Note that this table is based on 11.82MJ/CM-d, whereas subsequent tables have been updated to a higher energy requirement]

Crop	Average Production Based on Consumption, Fresh Mass [kg/CM-d]		
	Diet Using Only ELS Salad Crops <sup>133</sup>	Diet Using Salad and Carbohydrate Crops <sup>134</sup>	Diet Using All ELS Crops <sup>135</sup>
Cabbage	0.0194	0.0025	n/a
Carrot	0.0365	0.040	0.0401
Celery	n/a	0.0075	n/a
Dry Bean, inc. lentil and pinto	n/a	0.013	0.0214
Green Onion	0.0045	0.034	0.0226
Lettuce	0.0156	0.021	0.0075
Mushroom	n/a	0.0013	n/a
Pea	n/a	0.0038	n/a
Peanut	n/a	n/a	0.0288
Peppers	n/a	0.031	n/a
Radish	0.009	n/a	0.0150
Rice	n/a	n/a	0.0214
Snap Bean	n/a	0.010	n/a
Soybean	n/a	n/a	0.2340
Spinach	0.0048	0.040	0.0463
Sweet Potato	n/a	0.18	0.0768
Tomato	0.0460	0.21	0.2854
Wheat	n/a	0.22	0.0963
White Potato	n/a	0.17	0.1047
<b>Crop Sub Total</b>	<b>0.1358</b>	<b>1.0</b>	<b>1.00</b>
Water <sup>136</sup>	1.1581	2.1	0.6053
Resupplied Foodstuffs	1.168 <sup>137</sup>	0.5 <sup>137, 138</sup>	0.0944
<b>Total</b>	<b>2.462</b>	<b>3.6</b>	<b>1.70</b>
Potable Water <sup>139</sup>	2.0	2.0	2.0
Food Processing Waste	TBD	TBD	0.094

<sup>133</sup> From Hall, *et al.* (2000). This diet assumes a 10-day cycle.

<sup>134</sup> From Personal communication with Hall and Vodovotz in 1999. This diet assumes a 20-day cycle.

<sup>135</sup> From Ruminsky and Hentges (2000). This diet assumes a 10-day cycle.

<sup>136</sup> Water for hydration, cooking, and food preparation only. Water for cleanup is not included. Water tankage is not included.

<sup>137</sup> Resupplied food is a combination of STS and ISS foodstuffs.

<sup>138</sup> Oil is included as resupply. No frozen or refrigerated foods are assumed for this calculation. Packaging is not included. Resupplied food is about 40 % moisture by mass. Resupplied food includes meat.

<sup>139</sup> The crew also requires 2.0 L/CM-d for drinks, again excluding packaging/tankage. (Perchonok, 2001)

In all cases, the menus given in Table 4.65 and Table 4.66 are designed for use as a unit to maintain nutritional integrity. However, minor changes might include moving small amounts of crops from the list to be grown and into the resupplied mass, especially for those items like rice that are prepared for consumption with Outpost-plant growth processing operations that reduce the total edible biomass from the original crop. All diets are comparable in nutritional content to the International Space Station Assembly Complete food system.

**Table 4.66 Nutritional Content of Diets Using Advanced Life Support Crops and Resupplied Foods**  
**[Note that this table is based on original 11.82MJ/CM-d since its purpose is nutritional integrity, whereas subsequent tables have been updated to a higher energy requirement.]**

Dietary Component	Units	Goal	Diet Using Only ELS Salad Crops <sup>133</sup>	Diet Using Salad and Carbohydrate Crops <sup>134</sup>	Diet Using All ELS Crops <sup>135</sup>
Energy	MJ/CM-d	11.82 <sup>140</sup>	9.31	9.74	7.74
Carbohydrate	g/CM-d	–	312.179	357.1	314.12
Fat	g/CM-d	–	71.9141	71.6	46.84
Protein	g/CM-d	–	91.2913	73.1	54.91
Calcium, Ca	mg/CM-d	1,000 – 1,200 <sup>141</sup>	925.557	812	545
Iron, Fe	mg/CM-d	≤ 10 <sup>141</sup>	19.2385	21.5	17.23
Magnesium, Mg	mg/CM-d	350 <sup>141</sup>	294.687	386	376.48
Phosphorous, P	mg/CM-d	≤ 1.5 Ca intake <sup>141</sup>	1,440.68	1,356	1,079.52
Potassium, K	mg/CM-d	~ 3,500 <sup>141</sup>	3,316.57	3,723	3,179.86
Sodium, Na	mg/CM-d	1,500 – 3,500 <sup>141</sup>	3,909.56	3,600	3,205.96
Zinc, Zn	mg/CM-d	15 <sup>141</sup>	12.8077	10	7.5
Dietary Fiber	g/CM-d	10 – 25 <sup>141</sup>	25.1129	33.3	28.5
<b>Percentage of Energy Contributed to Diet</b>					
Carbohydrate	%	50 – 55 <sup>141</sup>	55.5	61	68.1
Fat	%	30 – 35 <sup>141</sup>	28.7	27	22.4
Protein	%	12 – 15 <sup>141</sup>	16.2	12	12

The Diet Using Only Salad Crops (Hall, *et al.*, 2000) is aimed at near-term missions and supplements more traditional packaged food systems with fresh food in the form of salad crops. The bulk of the nutritional content is supplied by the packaged food and the degree of food system closure is low.

The Diet Using Salad and Carbohydrate Crops (Personal Communication with P. Hall and Y. Vodovotz, in 1999) is also aimed at near-term missions, but this diet provides somewhere around half of the necessary mass through crops grown on-site. Resupply includes products high in protein, such as meat, in addition to seasonings and other supporting foodstuffs. Oil is also provided via resupply, as typical oil crops are not grown for this diet. Overall, this approach provides greater on-site food closure, adds only moderate additional food processing, and provides variety equivalent to that of a vegetable garden.

The Diet Using All Crops (Ruminsky and Hentges, 2000) uses a wide variety of species, and provides a high degree of closure. Oil is provided from peanut, but the specific processing has not been identified. With

<sup>140</sup> From NASA (1991).

<sup>141</sup> From Lane, *et al.* (1996).

respect to closure, the resupply mass includes herbs and condiments. As the crop variety is limited, resupply items provide necessary nutrients that are not available in sufficient quantities within the grown biomass.

Levri, *et al.* (2001) examined prepackaged food systems for exploration missions to Mars using the standard Shuttle Training Menu with a 7-day menu cycle as a basis. To support the nominal NASA crewmember, the standard Shuttle Training Menu was adjusted slightly to raise the energy content to 11.82 MJ/CM-d. In the 2014 BVAD, energy content was further increased to 12.707 MJ/CM-d to match modern nutritional requirements in the following four tables. Data collected by Levri, *et al.* (2001) showed that the practical minimum wastage rate of resupplied food for situations in which the crew attempts to eat all of the food with which they are supplied is 3% by mass. This remaining 3% of the food mass adheres to the inside of the food packaging.

Table 4.67 presents mass and volume properties for three study food systems, as originally formulated by Levri, *et al.* (2001), which are modified from the standard Shuttle Training Menu. Each system assumes crew metabolic loads consistent with IVAs. “As-shipped” food contains any moisture present when the food is packaged for launch. Food “as-consumed” also includes any additional water that is added to rehydrate food items and powdered beverages before consumption. The additional drinking water is computed based on the assumption that a crewmember consumes at least 239.0 milliliters of water, either within food or in addition to food, for every Mega-Joule of metabolic energy within the consumed food to provide proper hydration for metabolic assimilation of the food.<sup>142</sup> Some sources, such as the NRC (1989), recommend as much as 358.5 milliliters of water per Mega-Joule of energy in the consumed food. Generally, these food systems are stored under ambient conditions in an ISS food locker. Frozen storage, when noted, assumes an ISS thermoelectric freezer (Section 4.5.2). Locker and freezer volumes are computed with respect to external dimensions.

---

<sup>142</sup> Alternately, this guideline may be formulated as 1.0 milliliters of water per kilocalorie of food energy consumed.



**Table 4.67 Properties of Early Mars Diets for Intravehicular Activities Using Resupplied Foods**

		<b>Units</b>	<b>Modified Shuttle Training Menu <sup>143</sup></b>	<b>Low Moisture Content Menu <sup>143</sup></b>	<b>Menu Containing Some Frozen Food <sup>143</sup></b>
<i>IVA Food Properties, No Packaging</i>					
Food, Dry Mass		kg/CM-d	0.71	0.71	0.72
Food “As-Shipped”		kg/CM-d	1.23	0.99	1.48
Moisture Content of Food “As-Shipped”		%	42	28	52
Food “As-Consumed,” with Rehydration		kg/CM-d	2.58	2.37	2.56
Additional Drinking Water		kg/CM-d	1.22	1.42	1.24
<i>IVA Food Packaging Properties</i>					
Packaging Mass		kg/CM-d	0.28	0.29	0.26
<i>IVA Food Locker Properties <sup>144</sup></i>					
Locker Mass		kg/CM-d	0.37	0.35	0.27
Locker Volume		m <sup>3</sup> /CM-d	0.00519	0.00486	0.00381
<i>IVA Food Freezer Properties</i>					
Freezer Mass		kg/CM-d	n/a	n/a	0.866
Freezer Volume		m <sup>3</sup> /CM-d	n/a	n/a	0.00231
<i>IVA Food and Packaging Waste</i>					
Trash Mass		kg/CM-d	0.35	0.34	0.31

<sup>143</sup> From Levri (2002). The values here include material that normally clings to food packaging and is discarded.

<sup>144</sup> Food maintained at ambient conditions is stored in lockers aboard ISS. These values assume ISS “Pantry-style storage.”

Table 4.68 provides the nutritional analysis for the food systems presented in Table 4.67. However, unlike Table 4.67 – which is based on all food “as shipped,” including food that adheres to the food packaging and is not consumed by the crewmember – values in Table 4.68 consider only the edible material a nominal crewmember consumes, and assume the crewmember attempts to eat all of the food within a package and only wastes material that adheres to the package walls.

**Table 4.68 Nutritional Content of Early Mars Diets for Intravehicular Activities Using Resupplied Foods**

<b>Dietary Component</b>	<b>Units</b>	<b>Modified Shuttle Training Menu <sup>145</sup></b>	<b>Low Moisture Content Menu <sup>145</sup></b>	<b>Menu Containing Some Frozen Food <sup>145</sup></b>
Energy	MJ/CM-d	12.71	12.71	12.71
Carbohydrate	g/CM-d	404	411	399
Fat	g/CM-d	104	100	105
Protein	g/CM-d	122	124	125
Dietary Fiber	g/CM-d	35	36	40
Ash	g/CM-d	29	27	33
Water in Food <sup>146</sup>	g/CM-d	501	267	742
Rehydration Water	g/CM-d	1,321	1,350	1,057
Additional Drinking Water <sup>147</sup>	g/CM-d	1,218	1,423	1,241
<b>Percentage of Energy Contributed to Diet</b>				
Carbohydrate	%	53	54	53
Fat	%	31	30	31
Protein	%	16	16	16

Based on the dietary contributions of salad crops suggested by Perchonok, *et al.* (2002) and data compiled by Levri, *et al.* (2001), four diets using salad crops and resupplied food systems are presented in Table 4.69. The crop values listed here are based on fresh salad crops, as received from the Biomass Subsystem, less any biomass removed during preparation. Resupplied foodstuffs are listed “as-shipped,” without rehydration water, and do not include packaging materials. Values here do not include material that adheres to packaging and is ultimately wasted. Drinking water is listed near the bottom of the table. As above, the drinking water assumes that a crewmember consumes at least 239.0 milliliters of water, either within food or in addition to food, for every Mega-Joule of metabolic energy within the consumed food to provide proper hydration for metabolic assimilation of the food. The listings for food processing waste consider wasted edible biomass from preparation of the salad crops plus resupplied food that adheres to packaging materials. Here it is assumed that 3% of the food mass within a prepackaged food item will adhere to the packaging.

<sup>145</sup> From Levri (2002). The values here are based on food “as consumed” by a crewmember, excluding material that normally clings to the food packaging.

<sup>146</sup> Moisture, or water, held in the food as shipped before rehydration.

<sup>147</sup> The additional drinking water is computed based on the assumption that a crewmember consumes at least 239.0 milliliters of water, either within food or in addition to food, for every Mega-Joule of metabolic energy within the consumed food to provide proper hydration for metabolic assimilation of the food. These values are identical to those in Table 4.68 because losses were not measured or assumed.

**Table 4.69 Menu Masses for Diets Using Advanced Life Support Crops and Resupplied Foods**

Crop	Average Production Based on Consumption, Fresh Mass [kg/CM-d]			
	Diet Using Shuttle Training Menu and ELS Salad Crops <sup>148</sup>	Diet Using Low Moisture Content Menu and ELS Salad Crops <sup>148</sup>	Diet Using ISS Assembly Complete Menu with Some Frozen Food and ELS Salad Crops <sup>148</sup>	Diet Using Shuttle Training Menu and ELS Salad Crops plus Potato <sup>148</sup>
Cabbage	0.0107	0.0107	0.0107	0.0107
Carrot	0.0357	0.0357	0.0357	0.0357
Celery	n/a	n/a	n/a	n/a
Dry Bean, inc. lentil and pinto	n/a	n/a	n/a	n/a
Green Onion	n/a	n/a	n/a	n/a
Lettuce	0.0097	0.0097	0.0097	0.0097
Mushroom	n/a	n/a	n/a	n/a
Pea	n/a	n/a	n/a	n/a
Peanut	n/a	n/a	n/a	n/a
Peppers	n/a	n/a	n/a	n/a
Radish	0.0114	0.0114	0.0114	0.0114
Rice	n/a	n/a	n/a	n/a
Snap Bean	n/a	n/a	n/a	n/a
Soybean	n/a	n/a	n/a	n/a
Spinach	0.0134	0.0134	0.0134	0.0134
Sweet Potato	n/a	n/a	n/a	n/a
Tomato	0.0143	0.0143	0.0143	0.0143
Wheat	n/a	n/a	n/a	n/a
White Potato	n/a	n/a	n/a	0.0840
<b>Crop Sub Total</b>	<b>0.0953</b>	<b>0.0953</b>	<b>0.0953</b>	<b>0.1793</b>
Rehydration Water <sup>149</sup>	1.3115	1.3409	1.0492	1.2744
Resupplied Foodstuffs <sup>150</sup>	1.187	0.951	1.421	1.154
<b>Total</b>	<b>2.5942</b>	<b>2.3872</b>	<b>2.5656</b>	<b>2.6075</b>
Drinking Water <sup>151</sup>	1.14	1.35	1.17	1.13
Food Processing Waste <sup>152</sup>	0.0397	0.0324	0.0469	0.0412

Table 4.70 provides the nutritional analysis for the food systems presented in Table 4.69. As above, values in Table 4.70 consider only the edible material a nominal crewmember consumes, and the crewmember

<sup>148</sup> From Levri (2002). The values here are reflect food “as-shipped,” for prepackaged food, and “as-received” from the Biomass Subsystem less preparation waste, for food grown locally. Wasted food mass is listed separately at the bottom of the table. Thus, crewmembers consume all other masses in this table except for wasted mass.

<sup>149</sup> Water for rehydration only. Water for cleanup is not included. Water tankage is not included.

<sup>150</sup> Masses are for food “as shipped,” without packaging, storage lockers, or water for hydration.

<sup>151</sup> Again, this listing excludes packaging/tankage.

<sup>152</sup> These values include the wasted portion of fresh, edible biomass, as well as the wasted portion of resupplied, “as-consumed” food. These values do not include packaging.

only wastes food material that adheres to the package walls or serving dishes and some edible biomass from crop preparation.

**Table 4.70 Nutritional Content of Diets Using Advanced Life Support Crops and Resupplied Foods**

<b>Dietary Component</b>	<b>Units</b>	<b>Diet Using Shuttle Training Menu and ELS Salad Crops <sup>153</sup></b>	<b>Diet Using Low Moisture Content Menu and ELS Salad Crops <sup>153</sup></b>	<b>Diet Using ISS Assembly Complete Menu with Some Frozen Food and ELS Salad Crops <sup>153</sup></b>	<b>Diet Using Shuttle Training Menu and ELS Salad Crops plus Potato <sup>153</sup></b>
Energy	MJ/CM-d	12.71	12.71	12.71	12.71
Carbohydrate	g/CM-d	405	412	400	413
Fat	g/CM-d	103	100	104	101
Protein	g/CM-d	122	124	125	121
Dietary Fiber	g/CM-d	37	38	42	38
Ash	g/CM-d	30	28	33	30
Water in Food <sup>154</sup>	g/CM-d	585	352	825	631
<b>Percentage of Energy Contributed to Diet</b>					
Carbohydrate	%	53	54	53	54
Fat	%	31	29	31	30
Protein	%	16	16	16	16

The four diets, presented in Table 4.69 and Table 4.70 are derived from the standard Shuttle Training Menu and work by Levri, *et al.* (2001), subsequently updated in the 2014 BVAD to an energy basis of 12.707 MJ/CM-d. The first and fourth diets included prepackaged items from the Modified Shuttle Training Menu. See Table 4.67 and Table 4.68. The second diet considers prepackaged items from the Low Moisture Content Menu, while the third diet employs the Modified Shuttle Training Menu with some frozen items to simulate a food system similar to what is planned for ISS when that facility is completely assembled.

Perchonok, *et al.* (2002) provides estimates for salad servings based on preliminary menus for early mission scenario testing. This overall approach assumes a prepackaged food system augmented with grown salad crops. Thus, this diet is analogous to the Diet Using Only Salad Crops from (Personal Communication with P. Hall, Y. Vodovotz, and Laurie Peterson in 2000). Note that Table 4.71 provides inputs only for the dietary contributions derived directly from the vegetables. The supporting prepackaged food items are not included.

<sup>153</sup> From Levri (2002). The values here are based on food “as consumed” by a crewmember, excluding edible material that normally clings to food packaging or serving dishes.

<sup>154</sup> Moisture, or water, held in the food as shipped before rehydration.

Perchonok, *et al.* (2002) assumes:

- Salad is served four times per week.
- Raw carrots are served as a snack once per week.
- Carrots are served once per week steamed.
- Spinach is served once per week either steamed or raw.
- Bok choy can be served as Cole slaw once per week.

Table 4.72 provides overall values for locally grown crops for this diet.

See also (Cooper, 2011) and (Cooper, 2012) for recent work on exploration food systems.

**Table 4.71 Updated Salad Crop Only Dietary Contributions**

Menu Item	Vegetable	Serving Size <sup>155</sup> [g]	Number per Week	Serving Rate <sup>156</sup> [kg/CM-d]
Salad 1	Lettuce	34	2	0.00971
	Carrot	40	2	0.01114
	Radish	40	2	0.01143
Salad 2	Spinach	20	2	0.01086
	Tomato (Cherry)	50	2	0.01429
Snack	Carrot	85	1	0.01214
Steamed Side Dish	Spinach	55	1	0.00786
Cole Slaw	Cabbage	63	1	0.009

**Table 4.72 Overall Crops Masses for Updated Salad Crop Only Diet**

Vegetable	Serving Rate <sup>156</sup> [kg/CM-d]
Cabbage	0.009
Carrot	0.03542
Lettuce	0.00971
Radish	0.01143
Spinach	0.01872
Tomato (Cherry)	0.01429
<b>Total</b>	<b>0.09857</b>

#### 4.5.8 FOOD PROCESSING

Food processing takes the edible biomass produced by plant crops, either fresh or as prepared for storage, and produces food products and ingredients such as pasta and flour. These food products may be stored or used immediately, together with ingredients supplied from the Earth (or, for analog testing, from outside the facility), and prepared as menu items.

For long-duration missions beyond low-Earth orbit, current planning envisions that crops will be grown and processed on a bulk basis. Hunter and Drysdale (1996) estimated the equipment mass to perform food processing for a crew of four to be about 655 kg. However, this is a very preliminary estimate, and the actual

<sup>155</sup> Mass “as prepared.”

<sup>156</sup> Mass per crewmember per day “as grown.” This is listed as fresh edible biomass. The associated inedible biomass is also produced as given in Table 4.100.

processing equipment will likely differ. Thus, the value here is a suitable “placeholder” until more definitive values are available.

#### 4.6 EXTRAVEHICULAR ACTIVITY SUPPORT INTERFACE <sup>157</sup>

EVA for planetary exploration missions will exhibit significant differences from current EVA in low-Earth orbit. On a planetary surface, the presence of gravity raises the importance of suit mass, so planetary surface space suits must be much lighter than current systems. Such new space suits must also be designed for walking, assembly and setup of equipment, picking up surface samples, hammering, etc., to accommodate field geology and similar activities necessary for planetary exploration. The current space suit, or EMU, does not have these attributes. It has a mass on the order of 135 kg and is designed for weightless mobility using foot restraints. Table 4.73 represents local accelerations due to gravity for planetary bodies and Table 4.74 presents historical EMU masses. Finally, Table 4.75 presents the weight <sup>158</sup> of an average 70 kg crewmember plus historical and current EMU designs under a variety of gravitational conditions. As noted, the current EMU, if not reduced in mass for Mars, would burden a crewmember with a weight 12% greater than the weight of a nominal, unencumbered crewmember under terrestrial gravity.

- *Note: The analysis here is not meant to suggest that a historical Apollo EMU or the current EMU will be used for operations on the surface of the Moon or Mars, but rather to compare the effects of suits with similar mass. The current Space Shuttle Program EMU is inappropriate for surface operations, whereas the historical Apollo EMU has many limitations and would be inappropriate for Martian surface operations.*

**Table 4.73 Local Accelerations Due to Gravity**

Locale	Mean Acceleration due to Gravity [m/s <sup>2</sup> ]	Fractional Gravity compared to Earth Normal	Reference
Earth	9.807	1.000	Weast and Astle (1979)
Moon	1.620	0.165	
Mars	3.740	0.381	

<sup>157</sup> This section on advanced EVAs is from personal communication with M. Rouen in 2001.

<sup>158</sup> Weight, a force, is defined as the mass of an object [kg], which is invariant with locale, multiplied by the local acceleration due to gravity [m/s<sup>2</sup>]. More specifically, weight is the force with which a planet pulls a mass towards its surface and, therefore, the “on back weight” experienced by a crewmember carrying something on the surface in that gravity field.

**Table 4.74 Historical Extravehicular Activity Masses**

Item	Mass [kg]	References
Nominal Human Being	70 <sup>(1)</sup>	(1) See Section 3.3.4
Apollo Program Spacesuit, A7L <sup>159</sup>	83.0 <sup>(2)</sup>	(2) NASA (1969)
Apollo Program Spacesuit, A7LB <sup>160</sup>	90.7 <sup>(3)</sup>	(3) Personal communication with M. Rouen in 2002
Shuttle/ISS Program Spacesuit	135 <sup>(4)</sup>	(4) Personal communication with M. Rouen in 2001

**Table 4.75 Weights of Historical Spacesuits under Gravitational Loadings**

Locale and Loading	Total Mass [kg]	Weight for Human Alone [N]	Weight for Human Plus Space Suit [N]	Percentage of Unencumbered, Earth-Normal Weight [%]
<i>Earth</i>	70.0	686		100
<i>Moon</i>	70.0	113		16.5
Lunar Surface with Apollo A7L EMU	153.0		248	36.1
Lunar Surface with Apollo A7LB EMU	160.7		260	37.9
Lunar Surface with Shuttle EMU	205		332	48.4
<i>Mars</i>	70.0	262		38.2
Martian Surface with Apollo A7L EMU	153.0		572	83.4
Martian Surface with Apollo A7LB EMU	160.7		601	87.5
Martian Surface with Shuttle EMU	205		767	112

The entire EVA system, including airlocks, spacesuits, tools, and vehicle interfaces, must also be designed to minimize the mission launch mass. Thus, technology development is required. The final design solution depends upon the mission architecture as well as the success of development efforts. Several scenarios are described below that represent the best available assumptions with regard to EVA for planetary exploration missions.

#### 4.6.1 OPERATIONS DURING TRANSIT TO MARS

On a Mars transit vehicle, EVA would likely be reserved for contingency only. If EVA from the transit vehicle is minimal, then the transit vehicle airlock system should be as lightweight as possible and intrude into the crew habitat as minimally as possible. Solutions that use an existing volume within the cabin that can be

<sup>159</sup> The value here corresponds to the Apollo A7L EMU and a –6 portable life support system and associated equipment. Apollo 11 used this configuration on the lunar surface. The EVA surface duration per sortie was less than 8 hours in this configuration.

<sup>160</sup> The value here corresponds to the Apollo A7LB EMU and a –7 portable life support system and associated equipment. The later Apollo missions used this configuration on the lunar surface. The EVA surface duration per sortie was increased to 8 hours in this configuration.

isolated and depressurized or a fabric, fold-up airlock stowed externally to the outer cabin wall are some possible minimum impact solutions to provide contingency EVA capability. In an event, current EVA protocol requires at least two crewmembers at any time, so the minimum airlock should accommodate at least two crewmembers at a time. Thus, the minimum airlock internal volume is about 3.7 m<sup>3</sup>. This corresponds to the volume of the current Shuttle airlock.

#### **4.6.2 MARTIAN SURFACE OPERATIONS**

Because the gravity on Mars is about twice that of the Moon and about a third of that on Earth, the overall mass of a Mars spacesuit is extremely critical. A likely mission design to mitigate this problem is to reduce the standard EVA duration to 4 hours and plan to recharge the spacesuit consumables at midday. Thus, to maintain the same time outside the vehicle during exploration, two 4-hour, or “half-day,” EVA sorties per workday could replace the more traditional 8-hour EVA sortie. Assuming five workdays per week allows 520 half-day EVA sorties of two crewmembers per year without any allowance for holidays. This is also the expected number of airlock cycles per year. Each EVA sortie normally requires at least two crewmembers outside. This strategy would be impossible on ISS because of the long prebreathe times required for the crewmembers to adjust from the 101 kPa (14.7 psia) and 21% oxygen environment. Using the recommended exploration atmosphere of 57 kPa (8.2 psia) and 34% oxygen (Norcross 2013) can reduce the prebreathe time to effectively zero for some suit operation pressures. In other cases, it may at least reduce the time so it fits within other necessary activities such as suit checkout that would be conducted at 100% oxygen already. EVA operations may initially be performed at an elevated suit pressure until prebreathe time is met, and then the suit pressure will be reduced for greater mobility and reduced leak rate.

One method of reducing EVA consumables is to use a radiator to reject thermal loads from the spacesuit backpack rather than rely solely on consuming water to reject thermal loads, as is the current practice in low-Earth orbit. This could reduce cooling water usage to 0.19 kg/h from 0.57 kg/h, which is a typical value when a radiator is not used. The calculation here assumes a human metabolic rate of 1.06 MJ/h (295 W). Water, which remains within the spacesuit, also provides the thermal working fluid to transport heat from the astronaut’s skin to heat rejection equipment in the portable life support system (PLSS).

Another concept, which would completely eliminate loss of water to the environment for cooling, is a cryogenic spacesuit backpack. The cryogenic spacesuit backpack rejects thermal loads both to the environment, via a radiator, and to vaporize cryogenically stored oxygen for metabolic consumption. As above, water still provides the heat transport working fluid.

Oxygen usage and losses during EVA depend on the technologies employed in the PLSS. If a completely closed-loop system is used, oxygen is only consumed by metabolic activity and leakage. Under such conditions, oxygen usage is 0.3 kg per 4-hour EVA sortie, or 0.076 kg/h. If carbon dioxide generated while on EVA is stored by the PLSS and recycled once the crewmembers return to the vehicle, actual oxygen loss is associated only with leakage. Oxygen leakage alone accounts for a loss rate of 0.02 kg per 4-hour EVA sortie, or 0.005 kg/h. If the spacesuit PLSS employs a swing bed carbon dioxide removal technology to reject carbon dioxide and water to the Martian environment, then some additional oxygen is lost as a sweep gas to aid the bed’s operation. In this case, oxygen loss rates are 0.6 kg per 4-hour EVA sortie, or 0.15 kg/h. If cryogenic oxygen is used for thermal control as well as breathing, the overall oxygen usage rates are 4.0 kg per 4-hour EVA sortie, or 1.0 kg/h.

Normally flight rules require two exits to provide redundant means to enter and egress a vehicle. If pressurized rovers are used, one exit would be dedicated to docking rovers while an airlock would support on-foot EVA operations. As exits are only useful if coupled with a corresponding airlock, the contingency airlock for a secondary exit when another pressurized vehicle is not docked is often to depressurize the entire vehicle cabin.

Although the hatch size increases in an environment with gravity, the required airlock volume remains constant. A two-crewmember airlock has an empty volume of 4.25 m<sup>3</sup>. During use, the free gas volume within the airlock is 3.7 m<sup>3</sup> and two suited crewmembers fill the remaining volume. Though not generally acceptable under current rules, a single-person airlock has an empty volume of 1.02 m<sup>3</sup> and a free gas volume of roughly 0.89 m<sup>3</sup>. About 10% of the free gas within the airlock is lost to space and not recovered by the airlock compression pump during depressurization. These losses could be reduced to 5% at the expense of additional time and power consumption for the airlock pump. Other advanced concepts, however, may reduce the gas losses without corresponding time and power penalties.



Table 4.76 summarizes the estimates above for EVA operations on the surface of the Moon. All values are provided by personal communication with M. Rouen in 2001. Losses in Table 4.76 denote mass that leaves the pressurized volume of the spacesuit and, therefore, does not return to the vehicle at the end of EVA operations. Consumption listed in Table 4.77, denotes usage of a commodity by the crewmember regardless of whether that commodity leaves the pressurized spacesuit volume or is retained within that volume and later recycled. McBarron, et al. (1993) provide overall values describing the metabolic loads and inputs for an EVA crewmember assuming an average metabolic rate of 1,055 kJ/CM-h (293 W) and a respiratory quotient of 0.90; See Table 4.77.

**Table 4.76 Summary of Extravehicular Activity Values for Lunar Surface Operations**

Value	Units	low	nominal	high	Reference
Human Metabolic Rate During EVA	MJ /CM-h		1.06		1. Personal communication with M. Rouen in 2001
	W/CM		300		
EVA Crewmember Hours per Week	CM-h /wk		80	80	2. LAT2 (2007)
EVA Sorties <sup>161</sup> per Week	Sorties /wk	7	10	14	3. High Mobility Scenario
Cooling Water Losses (North & South Poles)	kg /CM-h	0.25	0.3375	0.5	
Cooling Water Losses (Equator)	kg /CM-h	0.4625	0.625	0.7625	
Oxygen Losses	kg /CM-h	0.069	0.092	0.110	
Airlock Volume	m <sup>3</sup>	3.3	3.3	3.3	
Airlock Free-Gas Volume	m <sup>3</sup>	2.9	2.9	2.9	
Airlock Cycles per Week	Cycles /wk	3.5	5	7	
Airlock Gas Losses per Cycle as a Percentage of Airlock Gas Volume <sup>162</sup>	%	5	10	10	

<sup>161</sup> Each EVA sortie assumes two crewmembers.

<sup>162</sup> As given, these values are as a percentage of the mass of gas occupying the free airlock volume when depressurization begins.

**Table 4.77 Extravehicular Activity Metabolic Loads**

Parameter	Units	Rate	References
Oxygen Consumption	kg/CM-h	0.075 <sup>(1)</sup>	<sup>(1)</sup> McBarron, et al. (1993); metabolic rate of 293 W/CM and a respiratory quotient of 0.9.
Potable Water Consumption <sup>163</sup>	kg/CM-h	0.24 <sup>(1, 2)</sup>	
Food Energy Consumption <sup>164</sup>	MJ/CM-h	1.062 <sup>(3)</sup>	
Carbon Dioxide Production	kg/CM-h	0.093 <sup>(1)</sup>	<sup>(2)</sup> MSIS (1995); a maximum value.
Respiration and Perspiration Water Production	kg/CM-h	highly* variable	<sup>(3)</sup> Personal communication with M. Rouen in 2001
Urine Production	kg/CM-h	highly variable*	

**4.6.3 LUNAR SURFACE OPERATIONS**

Future EVA scenarios on the lunar surface are likely to be similar to those described above for Mars, because lunar surface exploration is often cited as a precursor to Martian surface exploration missions. However, due to lower gravity on the Moon, it is easier to extend the EVA sorties to 8 hours, thus saving time and airlock cycle gas losses. However, radiant heat rejection would be a greater challenge during the lunar day.

**4.6.4 RECOMMENDED PREBREATHE INTERVALS FOR EVA**

**4.6.4.1 DECOMPRESSION SICKNESS PREVENTION**

*Decompression sickness takes place when the inert gas (generally nitrogen) that normally is dissolved in body tissues at one pressure forms a gas phase (“bubbles”) at a lower ambient pressure, when the tissues become supersaturated with nitrogen. [Powell, et al. (1993)]*

Decompression sickness (DCS) is an important consideration for mixed cabin atmospheres when EVAs are performed in lower-pressure space suits, and when changes in cabin pressure can occur as a result of planned activities and emergencies. DCS symptoms can include pain (“the bends”), pulmonary manifestations (“the chokes”), skin manifestations, circulatory collapse, and neurological disorders (NASA [1995]). A common approach for preventing or minimizing DCS is to prebreathe pure oxygen prior to depressurization to wash out nitrogen from body tissues. Minimizing the risk of DCS and the operational impact of prebreathe protocols is one of the primary drivers for the recommended reduction in cabin pressure for surface habitats and rovers (Norcross [2013]).

The occurrence and severity of DCS has been found to correlate with the ratio of the final partial pressure of inert gas in equilibrium with body tissue to the final ambient total pressure. This ratio, *R* (or *TR*), is known as the tissue ratio or bends ratio. When the inert gas is nitrogen and the final ambient pressure is the space suit pressure, *R* can be expressed as follows:

$$R = \frac{P_{N2-Tissue}}{P_{Suit}} \qquad \text{Equation 4.6}$$

The incidence of DCS, as well as venous gas emboli, increases with increasing *R* (see, for example, Horrigan, et al. [1993]). In addition to the dependence on *R*, DCS has been found to depend on the duration at

<sup>163</sup> For EVA sorties longer than 3 hours.

<sup>164</sup> This is the total energy expended, and thus consumed, per crewmember per hour of extravehicular activity.

reduced pressure, and the degree of physical activity and ambulation at reduced pressure (Conkin, et al. [1996]), Conkin and Powell (2001)). Test data also suggest that at the same  $R$ -value, a higher space suit pressure will result in a lower probability of DCS (Conkin, et al. [1996]).

During a pure-oxygen prebreathe, the elimination of nitrogen from body tissue follows an exponential decay curve with a tissue-dependent half-time,  $t_{1/2}$ , related to the blood perfusion rate, inert gas diffusion rate, and inert gas solubility in the tissue (Conkin, et al. [1987]):

$$p_{N2-Tissue}(t) = p_{N2-Tissue}(0) \exp\left[-(\ln 2) \frac{t}{t_{1/2}}\right] \quad \text{Equation 4.7}$$

In terms of  $R$  value,

$$R(t) = R(0) \exp\left[-(\ln 2) \frac{t}{t_{1/2}}\right] \quad \text{Equation 4.8}$$

The initial nitrogen partial pressure in equilibrium with body tissue prior to prebreathing is most appropriately assumed equal to the alveolar nitrogen partial pressure,  $p_{AN2}$ , that exists for the spacecraft cabin atmosphere. In correlating the incidence of DCS against  $R$ , Conkin and coworkers (1987) have used the atmosphere nitrogen partial pressure instead of  $p_{AN2}$  to avoid the complexity of using the Alveolar Gas Equation during intermediate exposures. These authors have also used a theoretical tissue type with a 360-minute half-time for modeling the dependence of DCS incidence on  $R$ .

For any given spacecraft cabin atmosphere and space suit pressure, Equation 4.8 can be used calculate the prebreathe time necessary to achieve a final required  $R$ -value prior to EVA. In establishing a bound on the atmosphere design space based on DCS prevention, the final required  $R$ -value and the maximum allowable prebreathe time must be established.

#### 4.6.4.2 FINAL $R$ VALUE

Current NASA ISS prebreathe protocols are based on a final  $R$  value of 1.65-1.68 after oxygen prebreathe (see Horrigan [1993], and NASA [2002, 2003]). Actual operational values are frequently lower. For surface-exploration EVAs, DCS risks from mixed cabin atmospheres have not been established, nor has the acceptable level of DCS risk. Higher physical loads imposed by partial gravity suggest higher DCS risk than in microgravity. DCS symptoms must also be treated locally without the option for a quick return to Earth. A final  $R$ -value of 1.3-1.4 (following prebreathe) has been suggested by Conkin (2004) as a reasonable starting point based on current knowledge.

#### 4.6.4.3 MAXIMUM PREBREATHE TIME

Minimization of the prebreathe time is highly desirable in missions with frequent EVAs to maximize crew productivity. An operational prebreathe of approximately 20 minutes is expected during space suit purge and checkout procedures. A longer minimum prebreathe (up to 1 hour) may be required to denitrogenate the brain and spinal cord to guard against serious (Type II) DCS symptoms (Gernhardt [2004]). A prebreathe time of 1 hour is therefore assumed as a tentative upper bound for surface exploration EVAs.

#### 4.6.4.4 PREBREATHE BOUND

Equation 4.8 was used to map curves of constant prebreathe time over the spacecraft cabin atmosphere pressure and oxygen concentration design space. Results are shown in Figure: 4.1- Figure: 4.4 for space suit pressures of 29.6 kPa (4.3 psia) and 41.4 kPa (6 psia), and for final  $R$ -values of 1.3 and 1.4. These results were calculated taking  $p_{N2-Tissue}(0)$  equal to the cabin atmosphere nitrogen partial pressure, and using a tissue half-time of 360 minutes. Curves are shown for prebreathe times ranging from 0 minutes to 240 minutes. The 60-minute prebreathe curve (shown dashed and bolded) represents the assumed upper bound on prebreathe time.

The strong dependence on space suit pressure is evident by comparing Figure: 4.1 and Figure: 4.2 with Figure: 4.3 and Figure: 4.4.

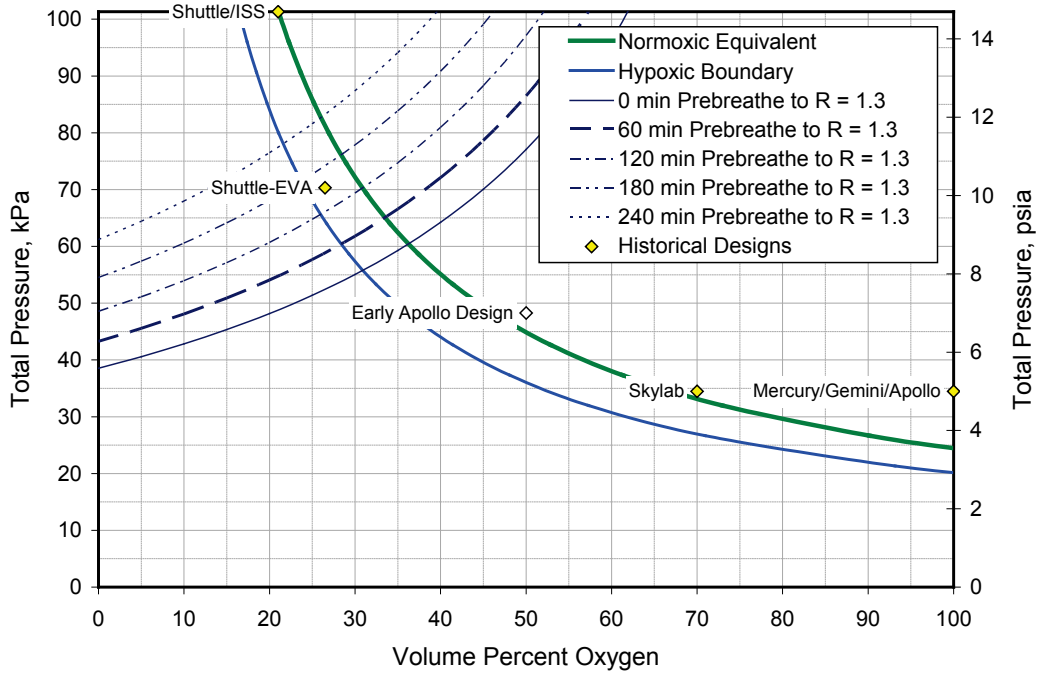

**Figure: 4.1** Curves of constant EVA prebreath time for a 29.6 kPa space suit with a final R-value of 1.3. Assumed upper bound on prebreath time is 60 minutes.

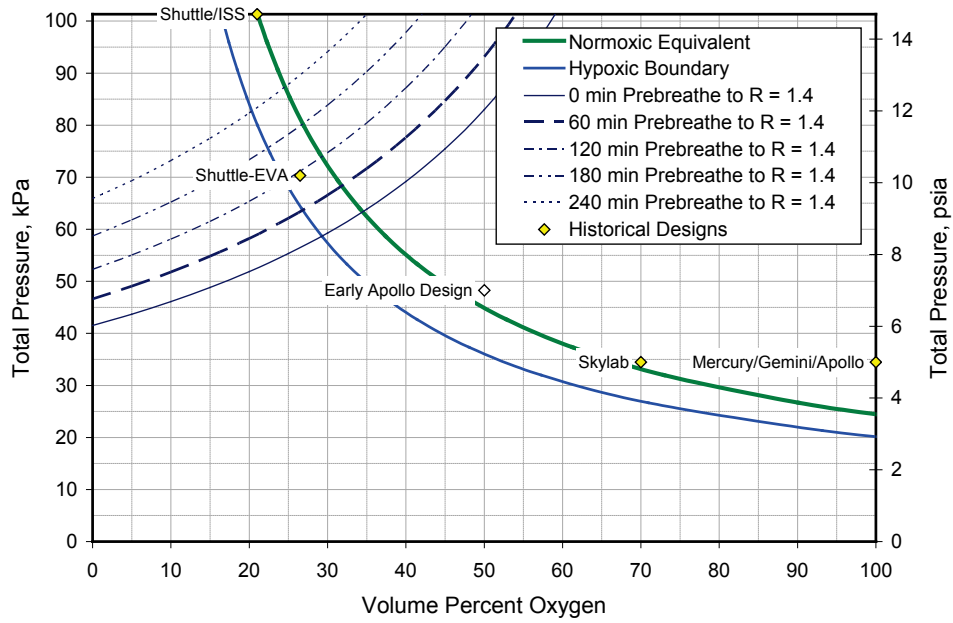

Figure: 4.2 Curves of constant EVA prebreath time for a 29.6 kPa space suit with a final R-value of 1.4. Assumed upper bound on prebreath time is 60 minutes.

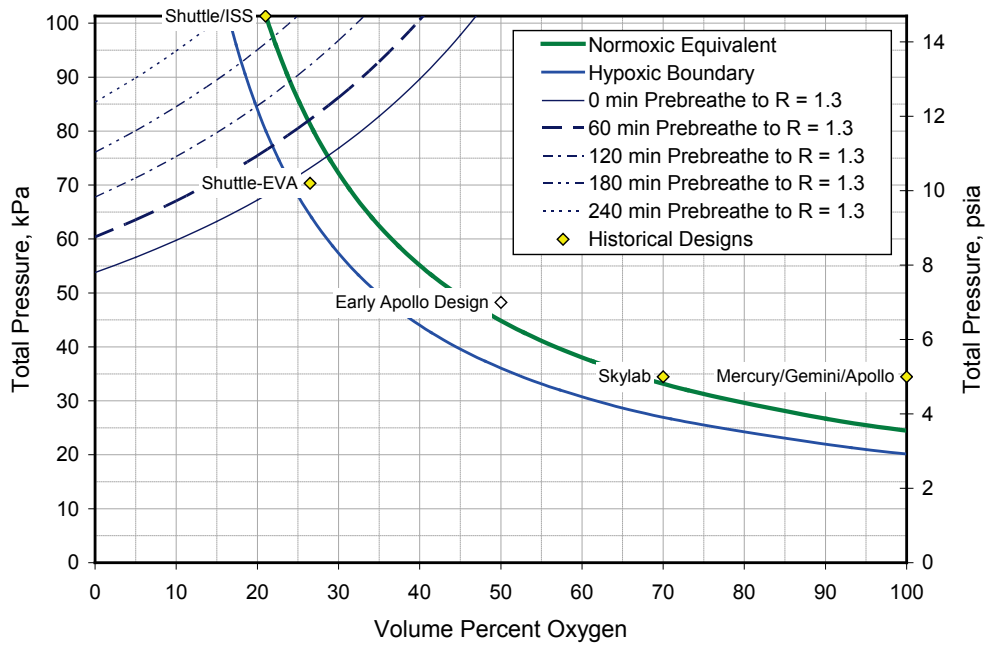
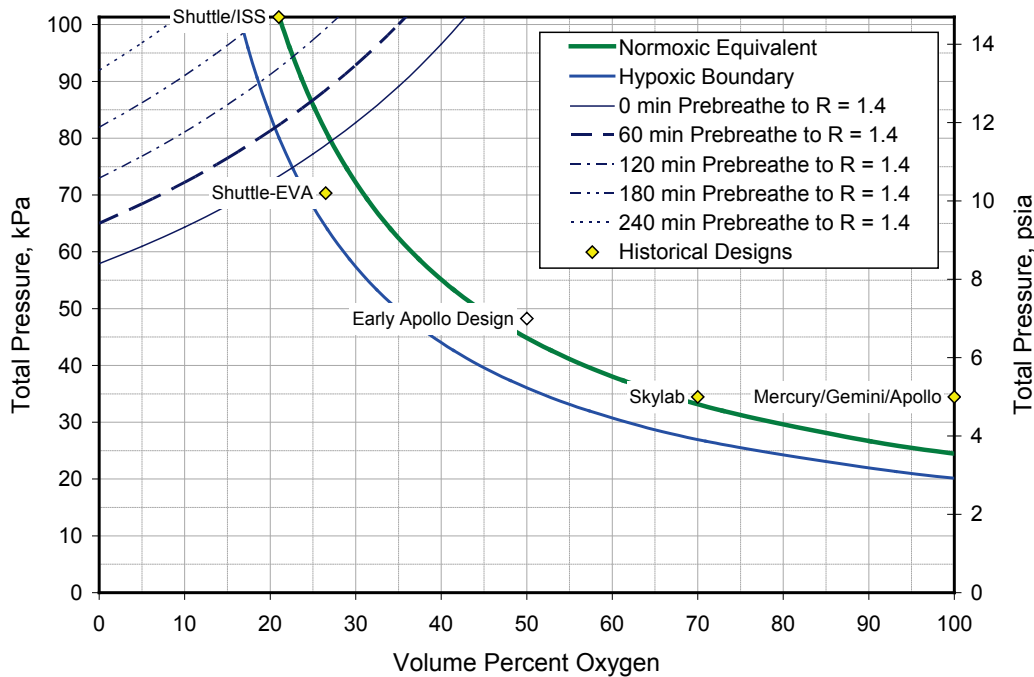

Figure: 4.3 Curves of constant EVA prebreath time for a 41.4 kPa space suit with a final R-value of 1.3. Assumed upper bound on prebreath time is 60 minutes.



**Figure: 4.4** Curves of constant EVA prebreathe time for a 41.4 kPa space suit with a final R-value of 1.4. Assumed upper bound on prebreathe time is 60 minutes.

#### 4.6.4.5 ISS PREBREATHE PROTOCOLS<sup>165</sup>

The ISS uses four prebreathe protocols with the 29.7 kPa (4.30 psia, 222 mm Hg) EMU suit. A different prebreathe protocol is used for the Russian Orlan suit since it has a higher operating pressure of 40.0 kPa, (5.80 psia, 300 mm Hg). All of these protocols are significantly longer than those specified in the exploration maximum prebreathe time due to the much higher cabin pressure. The ISS nominally operates at 101 kPa (14.7 psia) while exploration mission could be 55 kPa (8 psia). The selection of protocols for a given EVA depends on the mission objectives, DCS risk, crew timeline, and overall operational risks. The four prebreathe protocols for EMU are:

**Exercise – Exercise while breathing 100% O<sub>2</sub>** has been shown to eliminate N<sub>2</sub> from the body tissues more quickly. This protocol includes intense exercising for 10 minutes of an 80-minute mask prebreathe of 100% O<sub>2</sub>, with the cabin starting at 101 kPa and decompressing the airlock to 70.3 kPa over the 20 or more minutes required to don the suit. This is followed by a 60-minute in-suit prebreathe that is completed before the airlock begins its purge to vacuum.

**Airlock Campout –** This is a 2-day protocol. On the first day, crewmembers preparing for EVA use a mask to prebreathe 100% O<sub>2</sub> for 60 minutes while the pressure in the airlock decompresses from 101 kPa to 70.3 kPa. On the second day a 70-minute mask prebreathe of 100% O<sub>2</sub> is performed 8 hours and 40 minutes after 70.3 kPa pressure is reached in the airlock. A final 50-minute in-suit prebreathe is performed to conclude this protocol.

**In-suit Light Exercise (ISLE) –** For the ISLE protocol does not engage in a short bout of intense exercise but instead performs a longer bout of mild exercise in the EMU. The ISLE prebreathe protocol shares

<sup>165</sup> NASA HIDH (2014)

many steps with the Exercise prebreathe protocol. It differs in that 40 minutes are spent breathing 100% O<sub>2</sub> by mask, followed by a 20-minute depressurization to 70.3 kPa. Once the crewmember has completed suit donning, there is a repressurization to 101 kPa followed by in-suit arm and leg motions performed for 50 minutes with a minimum O<sub>2</sub> consumption of 6.8 ml/kg-min. An additional 50 minutes of in-suit rest completes the prebreathe protocol followed by a 30-minute depressurization of the airlock to vacuum.

4-hour In-Suit Prebreathe – Includes 4 hours of unbroken breathing 100% O<sub>2</sub> at an airlock pressure above 86.2 kPa.

#### 4.6.4.6 CONTINGENCY EVA

A contingency EVA is one that is required to affect the safety of the vehicle and crew. If time allows, a nominal prebreathe protocol should be used. If the EVA preparation time needs to be minimized to assure crew safety, a minimum of 2.5 hours of unbroken prebreathe with greater than 95% O<sub>2</sub> is recommended at a vehicle pressure above 86.2 kPa. A minimum prebreathe of 2.5 hours would reduce the estimated risk of incapacitating bends to less than 50% for an EVA up to 6 hours in duration. This recommended time is very approximate and should be extended if possible. Preparations for decompression treatment should be conducted as early as possible in case of an incident. The flight surgeon needs to be consulted for recommended prebreathe protocol for any contingency EVA. (NASA, 2011)

### 4.7 POWER INTERFACE

Within this manuscript, power enters analyses and modeling through use of a power-mass penalty. Thus, information on power systems is provided under the description of infrastructure in Section 3.2.

### 4.8 RADIATION PROTECTION INTERFACE

Radiation may impact numerous systems and is a critical issue for human exploration beyond low-Earth orbit. Vehicle structure, including the primary structure, avionics, and propulsion system can provide varying degrees of protection just due to the nature of their mass (Duffield, 2010). The Life Support System contains several items that could because of their high hydrogen content, act as effective radiation shields. However, the most likely interaction for the Radiation Protection Interface is with the Water Subsystem and then only as a contingency source. For operations in near-Earth space, the spacecraft is likely to be designed to limit the lifetime radiation exposure of the crew. While the initial activity from solar particle events enters from the direction of the Sun, the radiation field soon becomes effectively isotropic, so any effective radiation protection must provide a complete enclosure for the crew. This radiation shelter may include the entire crew cabin. On short-duration missions such as a lunar transit, such protection may only encompass a portion of the crew cabin (e.g., sleeping quarters) due to the added mass associated with complete radiation shielding. Perhaps something like a polyethylene garment could be worn, as suggested in the last line of Section 4.8.

As implied above in Section 3.2.2 on infrastructure using inflatables, galactic cosmic radiation is much more difficult to stop. For extended-duration transit missions, all mass to protect against galactic cosmic radiation must come with the spacecraft. On a planetary surface, local resources such as regolith packed into “sandbags” or underground caverns might be used to protect against radiation. Additionally, the carbon dioxide atmosphere of Mars, as well as the mass of the planet itself, provides some protection.

The most effective way to shield a transport vehicle may be to develop materials that serve both as structural elements and as shields. Polymeric materials such as polyethylene or polyetherimide with high hydrogen content, perhaps sandwiched between fire resistant materials, would offer both structural strength and provide radiation shielding (Duffield, 2010).

## 4.9 THERMAL CONTROL INTERFACE

Thermal control, in terms of its most direct impact on a spacecraft, maintains temperatures throughout the vehicle. Or, from another perspective, thermal energy, or heat, transfers from regions of high temperature to regions of low temperature and the thermal control hardware regulates when and how thermal energy transfers from regions of high temperature within the spacecraft to regions of low temperature outside of the spacecraft so that all components within the spacecraft are maintained between their prescribed temperature limits. As a distinguishing attribute, thermal control does not directly address heating associated with aerodynamic drag, although aerodynamic heating may impose greater thermal loads for the thermal control hardware, such as when heat conducts through the vehicle structure and into the crew cabin. Heating generated by aerodynamic drag is managed by the thermal protection system.

### 4.9.1 HEAT TRANSFER MECHANISMS

To appreciate heat management technology some background in the underlying mechanisms is beneficial. Thus, a brief discussion of heat transfer mechanisms follows. Please see Incropera and DeWitt (1985), the primary reference for this section, for a more thorough discussion.

Physically, heat transfers from high to low temperature via one of three distinct mechanisms. These mechanisms are conduction, convection, and radiation, although heat transfer with a phase change is sometimes discussed separately and thus might be viewed as a fourth heat transfer mechanism.<sup>166</sup>

#### 4.9.1.1 CONDUCTION

Conduction describes the transfer of heat within matter by diffusion or heat transfer through matter in the absence of macroscopic bulk motion of the matter. An example is heat moving up the shaft of a metal spoon sitting in a heated pot on a stove. The thermal energy, which is expressed as vibrational, rotational, and translational energy on atomic scales, is transferred from more-quickly vibrating atoms closer to the heated surface to less-quickly vibrating atoms further from the heated surface by interactions between adjacent atoms.

#### 4.9.1.2 CONVECTION

Convection describes the transfer of heat in which matter acquires heat, by close molecular interaction, such as is described above for conduction, and then bulk motion of that matter carries both the matter and thermal energy away from its location of origin. For example, heat may diffuse from hotter metal to an adjacent cooler moving fluid, and then the bulk motion of the moving fluid carries the heat away from its origin. Likewise, the reverse process, that of transferring heat from a hot moving fluid to a cooler solid, is also convection.

#### 4.9.1.3 RADIATION

Radiant heat transfer is an exchange of heat between two surfaces without any intervening matter. Specifically, heat transfers from one surface to another surface that it can “see” simply by virtue of a temperature difference between the two surfaces. In a perfect vacuum, which is approximated in free space, no intervening matter is present to convey heat from one surface to another by either conduction or convection, yet heat does transfer from a hotter surface to a cooler surface via electromagnetic waves in the mechanism called radiation. Warm spacecraft reject their thermal loads from relatively hot surfaces to relatively cold space by radiant heat transfer. Please note that while radiation also describes the mechanism by which other forms of energy, such as solar particles and x-rays, pass through a vacuum, thermal radiation merely transfers heat and has no additional mutagenic effect on biological creatures exposed to it. Also, please note that while radiant transfer is generally of the greatest importance in a vacuum, radiant transfer occurs in all situations where two surfaces that can “see”

---

<sup>166</sup> As noted below, phase change represents a special case of one of the three heat transfer mechanisms with the additional stipulation that one of the participating materials changes its physical state as a result of gaining or losing heat. However, even though phase change is not a unique mechanism, it is sometimes useful to distinguish heat transfer operations with phase change from other heat transfer operations.



each other are at different temperatures, even if, for example, a fluid fills the gap between those two surfaces and heat is transferred to or from the surfaces also by conduction and/or convection.<sup>167</sup>

#### *4.9.1.4 HEAT TRANSFER WITH PHASE CHANGE*

Phase change describes heat transfer when matter accepts or discharges heat and changes its physical state. Thus, though it is mentioned here separately, phase change is really a specialized case of one of the three heat transfer mechanisms in which matter changes state. As an example, when water boils in a stovetop pan, liquid water approaches the bottom of the heated pan and leaves in the form of steam bubbles after accepting heat. Thus, this is really heat transfer by convection with the matter undergoing bulk motion and changing its state from liquid to vapor upon accepting heat from the solid. Likewise, phase change may occur in situations without bulk motion, such as when butter melts between two slices of hot bread, which is an example of conduction with phase change of a participating conducting material.

### **4.9.2 THERMAL CONTROL ORGANIZATION**

Thermal control may be subdivided in several ways. One organization classifies thermal control as either passive or active. Passive thermal control hardware encourages or inhibits heat transfer as the heat passes directly through the hardware and eventually to the external environment, radiating from the vehicle's entire external surface. Active thermal control hardware acquires thermal loads near where the loads are generated and then transports those loads to some other portion of the vehicle before the loads are discharged to the environment by specifically designed radiating surfaces.

#### *4.9.2.1 PASSIVE AND ACTIVE THERMAL CONTROL*

Thermal control hardware may be classified as either passive or active. As outlined below, passive thermal control hardware is generally integrated into the vehicle structure and retards the flow of thermal energy either in to or out of the vehicle. Active thermal control hardware acquires thermal loads at or near their point of generation and transports those loads to the exterior of the vehicle for rejection.

#### *4.9.2.2 PASSIVE THERMAL CONTROL*

Passive thermal control hardware controls heat leakage from the vehicle and maintains cabin walls within prescribed temperature bounds. Passive thermal control hardware is deployed within the vehicle structure and generally takes the form of insulation and resistive heaters. Insulation impedes the transfer of heat in to and out of the vehicle, while resistive heaters allow active control of the wall temperatures when completely passive approaches are inadequate. Because passive thermal control hardware is generally incorporated into the vehicle structure, it is included within mass penalties for the vehicle structure.

---

<sup>167</sup> Within a pressurized crew cabin, though all three heat-transfer mechanisms are active, conduction and/or convection usually dominate compared to radiant exchange. Physically, the driving potentials for conduction and convection heat transfer are proportional to the simple difference in temperature, while the driving potential for radiant heat transfer is proportional to the difference in temperature to the fourth power. Within the crew cabin, coupled with appropriate transport properties, conduction and convection are greater in magnitude than corresponding radiant exchanges. Thus, within a crew cabin, analysts often neglect radiant exchange with only a minor loss in accuracy. As a cautionary note, there are situations, especially within terrestrial industry, in which radiant exchange is significant or dominates as the preferred heat transfer mechanism even when conduction and/or convection are also viable modes. Please see Incropera and DeWitt (1985) for a more expansive discussion.

#### 4.9.2.3 ACTIVE THERMAL CONTROL

Active thermal control hardware removes excess thermal loads from within the vehicle to the environment by physically transporting those loads from their site of generation to an appropriate rejection site. Active thermal control is comprised of three basic processes. These are acquisition of thermal energy, transport of thermal energy, and rejection of thermal energy. Acquisition hardware is comprised of fans, coldplates, and condensing heat exchangers for primary functionality. Transport hardware can, theoretically, use any mechanism. Historically for human spacecraft, transport relies on a liquid working fluid constrained within an enclosed flow channel, using the convection heat transfer mechanism to take loads from acquisition devices and to release loads to rejection devices.<sup>168</sup> Using this architecture, transport hardware consists of fluid tubes or pipes, pumps, accumulators, and valves. The working fluid may be two-phase, but historically NASA has employed single-phase working fluids. Finally, rejection hardware may be radiators, devices that reject expendable materials carrying thermal loads, such as a flash evaporator or a sublimator, or phase change devices such as packages containing phase change materials. Thermal control infrastructure penalties generally represent active thermal control hardware.

#### 4.9.2.4 GENERAL THERMAL CONTROL ARCHITECTURE

Active thermal control may be divided into internal thermal control and external thermal control. In this arrangement, the internal thermal control system (ITCS)<sup>169</sup> initially acquires thermal loads from the crew cabin. The ITCS transports the thermal loads and releases them to a heat exchanger common to both the ITCS and the external thermal control system (ETCS).<sup>170</sup> The ETCS acquires thermal loads from the heat exchanger in common with the ITCS and from heat sources outside the crew cabin. The ETCS transports the combined heat loads to the vehicle heat rejection devices.

This architecture, using an ITCS with an ETCS, allows a non-toxic working fluid to circulate in all thermal control hardware located inside the crew cabin while allowing a fluid with greater heat transfer characteristics to be used in thermal control hardware outside the crew cabin. With NASA vehicles, such as the Shuttle Orbiter and ISS, the ITCS working fluid was water, which is non-toxic and has ideal properties for transporting thermal loads, except that it has a relatively high freezing point compared to the external environment in low-Earth orbit. The Shuttle Orbiter and ISS both used more toxic working fluids in their ETCS that have lower freezing point temperatures. The Shuttle Orbiter used Freon 21 whereas ISS relies on anhydrous liquid ammonia.

While this architecture, using an ITCS with an ETCS, allows use of more toxic, freeze-resistant working fluids in the ETCS while circulating a non-toxic fluid in the ITCS, this approach is more complex than a single fluid system. In particular, a thermal control system using both an ITCS and an ETCS has the added mass of the heat exchanger common to the ITCS and ETCS plus the added mass of an additional pump for the additional loop. Noting that both the Shuttle Orbiter and ISS use two ITCS and two ETCS loops, for redundancy, this arrangement actually adds two extra heat exchangers and two extra pump packages. Further, while the ITCS and ETCS loops are cross-linked or plumbed in a manner that any heat load may be acquired and rejected by either of the two loops serving a particular location in the spacecraft, loss of either an ITCS loop or an ETCS loop degrades the overall heat transport and rejection capabilities of the thermal control system. Thus, the additional inherent complexity may actually reduce overall system reliability.

---

<sup>168</sup> It is possible to envision thermal transport using either conduction or radiant heat transfer. For short distances, relatively small thermal loads, or even highly temperature-tolerant equipment, conduction via solid material pathways to the exterior of the vehicle is possible. In fact, passive thermal control uses conduction as its transport mechanism through the vehicle structure. Radiant transport mechanisms are also possible, but less likely, within a vehicle because convective heat transfer within a working fluid is generally more efficient for relatively small temperature differences associated with temperature variations within a vehicle than is radiant heat transfer.

<sup>169</sup> Likewise, this may be designated as the “internal thermal control subsystem.”

<sup>170</sup> At assembly complete, ISS also uses the terminology “internal thermal control system” for its corresponding water coolant loops. However, the corresponding ISS “external thermal control system” is referred to as the “external active thermal control system” (EATCS). Combined, the ITCS and EATCS are the “active thermal control system” (ATCS).

#### 4.9.2.5 INTERNAL THERMAL CONTROL SYSTEM

The internal thermal control system (ITCS) acquires thermal loads from thermal acquisition sites within the crew cabin and transports those loads to a heat exchanger in contact with the external thermal control system (ETCS). The ITCS acquires thermal loads through specified interfaces. These interfaces are usually coldplates, where the heat loads are cooled by conduction through the hardware's external structure, or heat exchangers, where the heat loads are initially cooled by convection to a working fluid. In the second case, the most common working fluid within a crew cabin is the enclosed atmosphere because many heat loads release their waste heat to the cabin atmosphere either by convection or radiant transfer. Gas-liquid heat exchangers transfer the atmospheric heat loads to the ITCS.

Cabin atmospheric thermal loads are removed by the gas-liquid heat exchanger through two approaches. Sensible heat is released from cabin atmospheric gases by convection to the gas-liquid heat exchanger. Latent heat is released by condensing water vapor, also called humidity, from the cabin atmospheric gases, removing both humidity and thermal energy by convection with phase change.

Though removal of sensible and latent thermal loads from the cabin atmosphere is a necessary function, because the cabin atmospheric gases and extracted condensate are involved in this process, it is possible that the cabin condensing heat exchanger may organizationally be grouped in whole or in part outside of the Thermal Subsystem even though the underlying processes remove heat. For completeness, here the condensing heat exchanger is grouped with the Thermal Subsystem.

#### 4.9.2.6 CABIN ATMOSPHERIC THERMAL LOADS

The cabin has several types of thermal loads that get applied to the atmosphere. The most direct type would be forced air convection that would be applied by an electronics box that contains an internal cooling fan. Some passive devices, such as sensors or control valves, lose their heat via conduction to cabin structure. Some equipment and the crew reject heat via low-speed convection and radiation to the cabin surfaces. In space, natural convection is nonexistent as it depends on a contribution by gravity. Numerous commercial electronics packages depend on the presence of natural convection to maintain their component temperatures. Additionally, the surfaces of any powered device need to be maintained below touch temperature limits<sup>171</sup> (NASA, 2009) for the crew to be able to safely touch the device. Due to these factors, extra effort is required by the provider to show that the equipment will not fail thermally in space. This usually is a combination of analysis and properly designed testing. Since the absence of gravity can only be simulated for a few seconds in a specially designed aircraft trajectory, most researchers try show acceptance by analysis.

#### 4.9.2.7 EXTERNAL THERMAL CONTROL SYSTEM

The ETCS acquires thermal loads from the ITCS and from thermal acquisition sites outside of the crew cabin. Because the equipment outside of the crew cabin is almost universally in an unpressurized environment, thermal acquisition interfaces are almost universally coldplates. The ETCS rejects thermal loads to the environment using specified heat rejection devices, such as radiators, phase change devices, and devices that reject expendable materials carrying thermal loads. Mixing warm and cooled working fluid in the return line adjusts the temperature of the ETCS working fluid returning from the heat rejection suite to a prescribed set-point temperature. While the heat-rejection suite thermally cools working fluid, warm working fluid is routed around the heat rejection suite using a flow bypass as necessary to meet the set-point temperature for the ETCS heat acquisition devices.

Figure: 4.5 illustrates the interrelationship between the various component definitions for the ATCS. The ITCS, denoted in black with plain type, acquires thermal loads within the crew cabin and rejects those thermal loads to the ETCS. The ETCS, denoted in green with italicized type, acquires thermal loads from the

---

<sup>171</sup> The touch temperature limit in SSP 57000 is listed as 120°F. At this hardware temperature, there is no problem with the crew touch temperature. At higher temperature, an analysis would need to be performed based on the procedure in NASA HIDH to determine if the hardware is safe to touch. This analysis depends on the hardware temperature, material and contact time.

ITCS and equipment outside of the crew cabin and rejects those thermal loads to the environment.

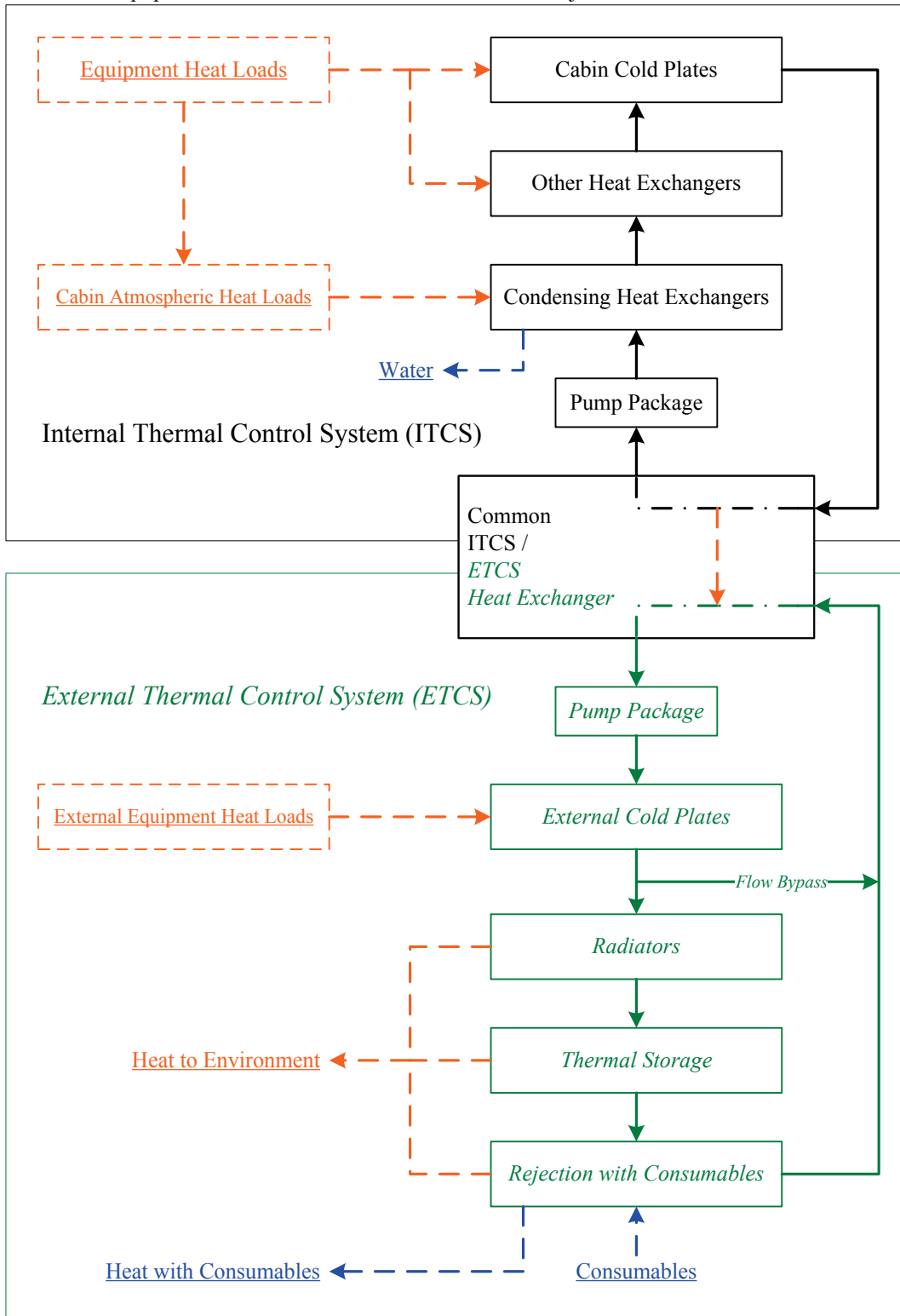

**Figure: 4.5 Active Thermal Control System component definitions.**

### 4.9.3 THERMAL CONTROL TECHNOLOGY

#### 4.9.3.1 HISTORICAL THERMAL CONTROL APPROACHES

While all NASA human-rated vehicles to date have used thermal control hardware to control the crew cabin atmospheric temperature and humidity, recent concerns over safety prohibit all but the most recent designs. In particular, some older spacecraft, such as Apollo, used a mixture of ethylene glycol with water as a working fluid within an active thermal control system loop that entered the crew cabin. Recent flight rules strongly advise against using ethylene glycol in any application within a vehicle in which a crewmember may contact it. Thus, the discussion of historical thermal control approaches is limited to designs for the Shuttle Orbiter and the ISS.

##### 4.9.3.1.1 SHUTTLE THERMAL CONTROL

Figure: 4.6 shows the ordering of components for one of two ETCS loops in a Shuttle Orbiter. A mechanical pump package, with two identical units plumbed in parallel, drives the single-phase Freon 21 working fluid. For this application, one pump is active and the second is a spare. The accumulator sets the low pressure for the fluid loop. When the working fluid contracts, the accumulator adds fluid, and when the working fluid expands, the accumulator stores any excess fluid. Because even liquid material properties are not truly invariant to temperature variations, the accumulator most often compensates for working fluid density variations associated with temperature changes.

The Shuttle was designed to reject heat through several means depending on the mission segment. On the launch pad and after the ground crew can make connections following landing, the ETCS rejects heat to ground facilities through the ground service equipment heat exchanger. On launch, reentry, and when necessary on-orbit, the flash evaporator allows excess water to evaporate from the outside of the ETCS working fluid line, expelling the vapor, with its waste heat, to space. Upon reentry, when the external atmospheric pressure is too great to operate the flash evaporator efficiently, the ammonia boiler evaporates anhydrous ammonia to cool the ETCS working fluid lines, again expelling the vapor to the environment.<sup>172</sup> The radiators, which are mounted on the inside of payload bay doors, reject heat by radiant transfer to space while the Shuttle is on-orbit. Shuttle controls the ETCS working fluid temperature from the radiators with a bypass loop as depicted. Varying internal flowrates or expendable fluid consumption rates control the other heat rejection devices.

Heat is gathered by the ETCS from many sites throughout the vehicle. Those listed as heat exchanger are liquid/liquid devices where the second operating fluid is the coolant for the attached hardware. The water/Freon interchanger is the common ITCS/ETCS heat exchanger, while the oxygen restrictor is a heat exchanger between the ETCS loop and the pressurized cabin oxygen supply.

---

<sup>172</sup> In practice, the ammonia boiler was rarely used as designed. Rather, just before the radiators are removed from service by closing the payload bay doors, the Shuttle flies an attitude so that the radiators face deep space. This maneuver fills the radiator panels with chilled Freon 21 and chills the metallic panels as well. Following this maneuver, the radiators are completely bypassed and the flash evaporator rejects the entire vehicle thermal load. When the flash evaporator ceases operations high in the atmosphere, flow through the now-stowed radiators is re-established, releasing the previously cooled working fluid. This approach provides sufficient cooling from when the flash evaporator ceases operations until about 15 minutes after touch down. If all proceeds on schedule, the ground-cooling cart that interfaces with the ground service equipment heat exchanger is operational by 15 minutes after touch down, and the ammonia boiler is not used. The ammonia boiler is provided on each mission as a contingency for heat rejection, and would provide primary cooling if the ground-cooling cart was not available in time or the Shuttle executed a launch abort.

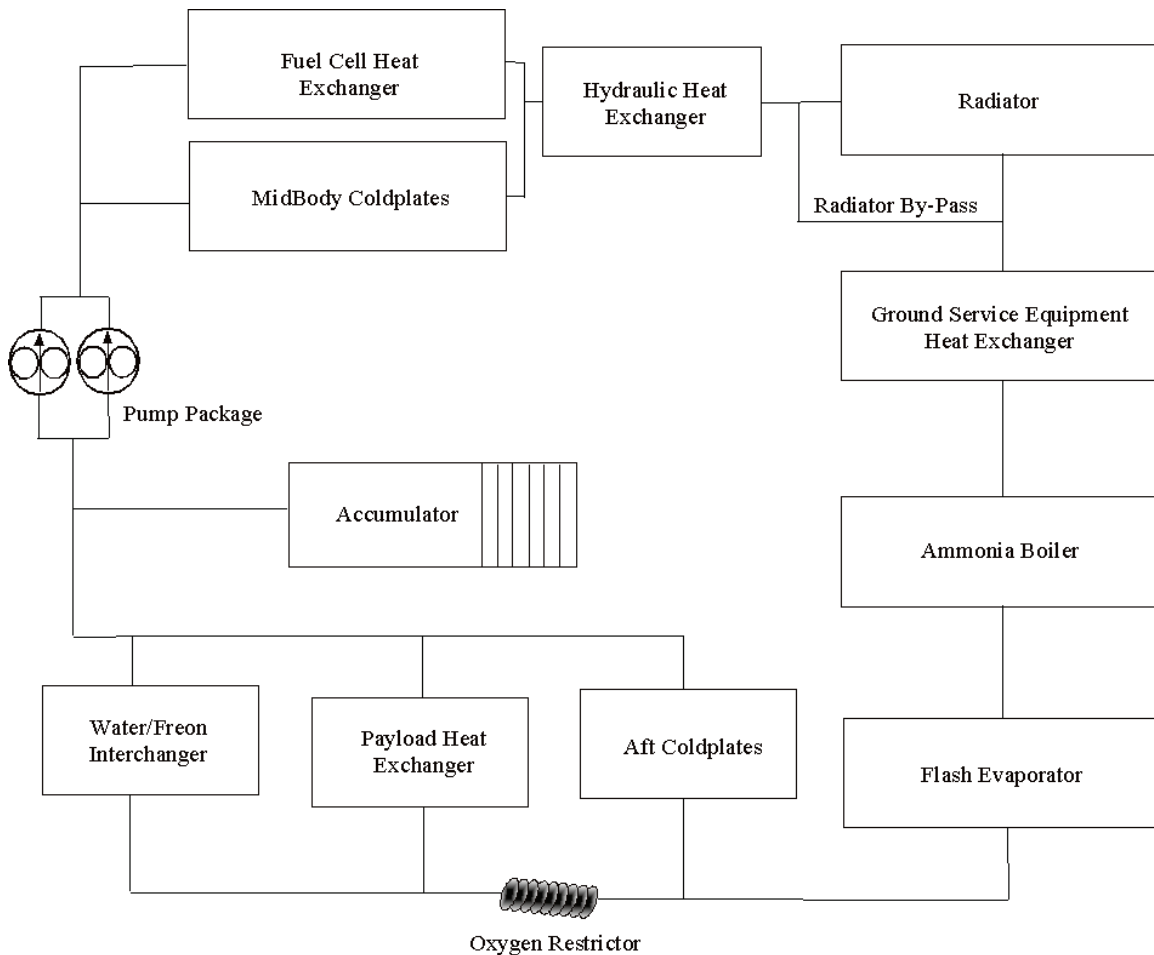

**Figure: 4.6 Active Thermal Control System hardware for the Shuttle Orbiter.**

Figure: 4.6 presents one of two Freon 21 loops in the Shuttle Orbiter ETCS. Coolant flow is clockwise. Because the ETCS loops run through an unpressurized portion of the vehicle, the heat exchangers are integral with the devices they cool. The Water/Freon Interchanger and the Oxygen Restrictor are heat exchangers between the ITCS water loop and the pressurized cabin oxygen supply, respectively. The Accumulator maintains pressure within the flow loop. The Radiator, Ground Service Equipment Heat Exchanger, Ammonia Boiler, and Flash Evaporator are all heat rejection devices.

#### 4.9.3.1.2 INTERNATIONAL SPACE STATION THERMAL CONTROL

The external active thermal control system (EATCS) for ISS at Assembly Complete is very similar to the architectures presented above. The ISS EATCS uses single-phase, anhydrous liquid ammonia as its working fluid, although the corresponding ITCS uses water. The radiators are mounted on booms that connect to the P1 and S1<sup>173</sup> truss segments through a thermal radiator rotary joint (TRRJ). The TRRJ's orient the radiator panels so that they display their thinnest face, their "edges," to the Sun, allowing their radiant face-sheets to be exposed

<sup>173</sup> The ISS truss segments are numbered in ascending order from the center of the vehicle. The S0, "starboard zero," truss segment forms the base for the other truss segments and connects directly to the other ISS modules through the U.S. Laboratory. The first starboard segment outboard of S0 is S1, while the first port segment outboard is P1, or "port one."

only to relatively cooler environments.<sup>174</sup> While not depicted in Figure: 4.7, many of the fine details are similar to those in earlier diagrams.

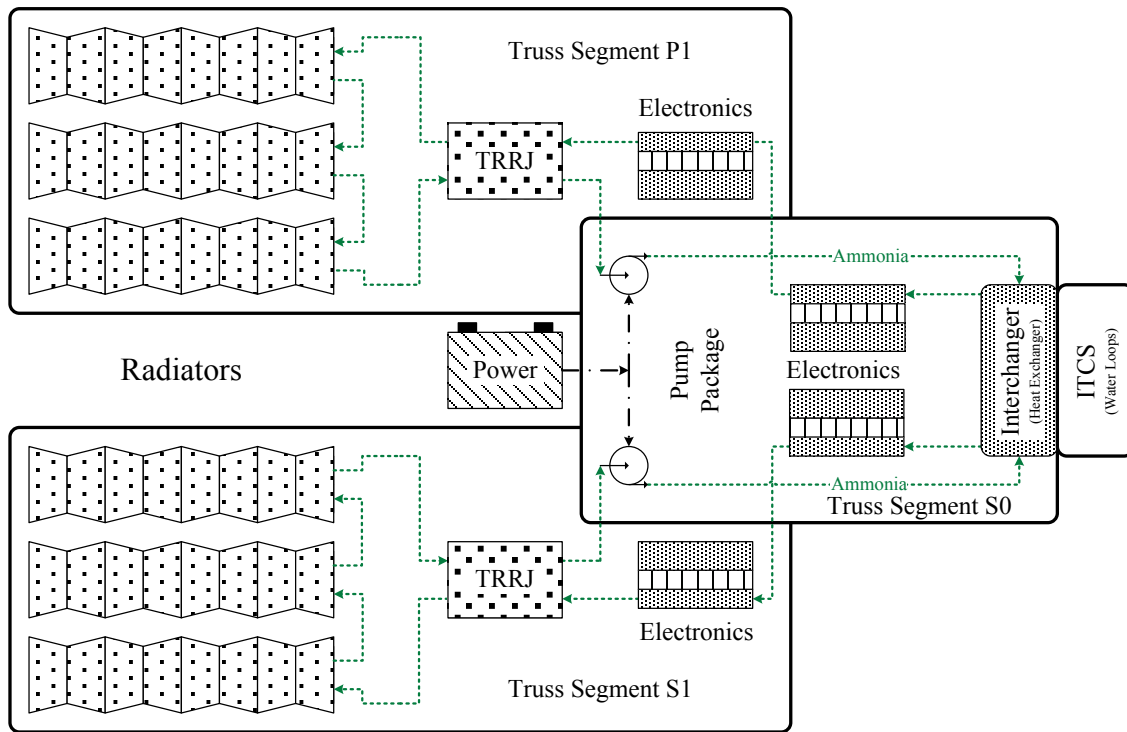

**Figure: 4.7 External Active Thermal Control System hardware for International Space Station at assembly complete.**

As noted by the arrows in Figure: 4.7, ammonia flows from radiators to the common ITCS/EATCS heat exchanger and then to the warmer thermal loads associated with electronics mounted on coldplates. Each Thermal Radiator Rotary Joint (TRRJ) rotates to position the radiator panels so that they face anti-Sun, or “edge-on” to the Sun. The bulk of the EATCS is located on truss segments S0, S1, and P1.

#### 4.9.3.1.3 ADVANCED THERMAL CONTROL APPROACHES

There are many concepts to increase the efficiency of thermal control hardware, and several of the more common ideas are summarized in the paragraphs below. Please, note, however, that this is not an exhaustive discussion and other viable approaches exist.

As noted above, the ATCS is the summation of both the ITCS and ETCS.<sup>175</sup> Further, dividing the ATCS into two loops when, physically, only one loop is required, adds inefficiency to the process of removing thermal loads from the vehicle even when there are benefits from this approach. An alternate approach employs only a single ATCS loop in place of each ITCS/ETCS combination. The working fluid requirements are more stringent because the working fluid may not be a significant hazard to the crew if leaked into the crew cabin, nor may it be overly susceptible to freezing when flowing through heat rejection equipment. While not employed currently, such systems are under development and the concept is mentioned here as background.

Another possible advanced concept is a two-phase thermal control working fluid. Thermal control loops using single-phase working fluids rely on the heat capacity of the working fluid to accept and transport thermal loads. However, single-phase working fluids are limiting in practice because acquiring a thermal load

<sup>174</sup> In rare situations, the TRRJ are not able to completely orient the radiator edges at the sun, but this case is not common and only occurs for brief periods.

<sup>175</sup> Or the EATCS when using ISS nomenclature.

raises the temperature of the working fluid, so hardware downstream must reject their thermal loads to a working fluid at a higher temperature than hardware upstream, and this concern can lead to other inefficiencies. Secondly, a single-phase working fluid generally can acquire less heat over its entire liquid temperature range than is required to change the phase of the same mass of working fluid from a liquid to a vapor. If the thermal control working fluid is allowed to vaporize as it acquires thermal loads, the working fluid remains at a constant temperature and actually less fluid mass is required to carry the same thermal load. Issues associated with two-phase flows under non-terrestrial gravitational fields remain as challenges to this approach so far.

Heat pumps also offer promise as advanced thermal control technologies. While terrestrial heat pumps move heat either into or out of a volume, heat pumps as part of an advanced thermal control system move heat from the vehicle to the environment only. Specifically, heat pumps use work, either thermal or mechanical, to raise the temperature of waste heat loads so as to increase the ease of rejecting those loads by radiant heat transfer. While heat pumps add hardware and use power, the increased temperature of the heat load for radiant emission from the vehicle decreases the required radiator size so that the overall system may be less massive than a thermal control system without a heat pump, especially in a hot environment.

#### 4.9.4 RADIANT ENERGY BALANCE

Heat transfer is a broad topic and any in depth treatment is beyond the scope of this document. See, for example, a heat transfer text such as Incropera and DeWitt for a more complete introduction. However, several definitions and assumptions are common when analyzing radiant heat transfer for space applications within NASA. Except as specifically noted, the development below follows Incropera and DeWitt.

In general, heat emitted by a perfectly black body,  $q_{bb}$  [W], may be described by the Stefan-Boltzmann equation.

$$q_{bb} = \sigma A T^4 \quad \text{Equation 4.9}$$

where  $\sigma$  is the Stefan-Boltzmann constant with a value of  $5.67 \times 10^{-8}$  W/(m<sup>2</sup>•K<sup>4</sup>), A is the body's surface area [m<sup>2</sup>], and T is the body's absolute temperature [K]. A black body is a perfect emitter and its emittance is a function only of its temperature once its geometry is fixed.

In practice, most real surfaces are not perfect emitters, and their surface emittance may be described as some fraction of the emittance from a perfectly black body. For a non-ideal body whose emittance fraction is constant, a slightly modified relation applies;

$$q_e = \sigma \epsilon A T^4 \quad \text{Equation 4.10}$$

$q_e$  is emittance [W], and  $\epsilon$  is the emissivity or the fraction of the surface's actual emittance compared to its ideal or black body emittance at its current absolute temperature, T. Alternately,  $\epsilon$  is unity only for an ideal or black body.

As noted earlier, radiant exchange of thermal energy does not depend on intervening matter for transfer. Rather, radiant exchange is possible between any two surfaces with a view of each other. Physically, according to one theory, thermal energy transfers between the surfaces via electromagnetic waves.<sup>176</sup> According to classic physics, thermal radiation, which is a subset of a broader phenomenon known as electromagnetic radiation, varies between wavelengths of 0.1 and 100  $\mu\text{m}$ . Visible light, according to the human eye, is confined to a range varying from 0.40 to 0.70  $\mu\text{m}$ . In addition to visible radiation, classical physics defines thermal radiation at wavelengths less than 0.40  $\mu\text{m}$  as also being ultraviolet radiation, and thermal radiation at wavelengths greater than 0.70  $\mu\text{m}$  is also infrared radiation. As context, electromagnetic radiation at wavelengths less than 0.1  $\mu\text{m}$  is classified, depending on its wavelength, as ultraviolet radiation,<sup>177</sup> x-rays, or gamma rays. Electromagnetic radiation at wavelengths immediately greater than 100  $\mu\text{m}$  is classified as microwaves.

<sup>176</sup> Alternate theories describe the transfer via photons or quanta, but the image of an electromagnetic wave is most applicable to the current discussion.

<sup>177</sup> Ultraviolet radiation varies from 0.01 to 0.40  $\mu\text{m}$ , and so overlaps the range classified as thermal radiation.



When thermal radiation strikes a solid object, it may be absorbed, reflected from the surface, or transmitted through the object. If the surface is opaque to the incident radiation, transmittance is zero and only absorbance or reflectance is possible.

$$\alpha + \rho = 1 \quad \text{Equation 4.11}$$

where  $\alpha$  is the absorptivity and  $\rho$  is the reflectivity. For an ideal or black body, reflectivity is zero and absorptivity is unity.

At any given wavelength,  $\lambda$ , according to Kirchoff's Law, absorptivity and emissivity are equal for a particular surface if (1) the incident irradiation is invariant with respect to direction, or diffuse, and (2) the surface properties are invariant with respect to direction, or diffuse.

$$\alpha_\lambda = \epsilon_\lambda \quad \text{Equation 4.12}$$

Additionally, if (3) the incident irradiation is diffuse and if (4) the surface properties, the absorptivity and emissivity, are independent of wavelength,  $\lambda$ , the surface is called a gray surface.

$$\alpha = \epsilon \quad \text{Equation 4.13}$$

While most real surfaces do not abide by this final requirement to qualify as gray surfaces, many are effectively gray over some subset of the range of thermal radiation. At Johnson Space Center, two thermal radiation sub ranges are often defined for radiant transfer calculations (Conger and Clark, 1997). Thermal irradiation between 0.25  $\mu\text{m}$  and 2.5  $\mu\text{m}$ , inclusive, is designated as solar thermal radiation (AZ Technology, 1993), while thermal irradiation above 2.5  $\mu\text{m}$  is designated as infrared thermal radiation. Over each of these sub ranges, material surface properties are assumed gray.

$$\begin{aligned} \alpha_s &= \epsilon_s \\ \alpha_{ir} &= \epsilon_{ir} \end{aligned} \quad \text{Equation 4.14}$$

where the subscript "s" denotes surface properties over the range of solar thermal radiation and the subscript "ir" denotes surface properties over the range of infrared thermal radiation. This does not imply that  $\alpha_s$  equals  $\alpha_{ir}$  or that  $\epsilon_s$  is equal to  $\epsilon_{ir}$ . This approach effectively considers Equation 4.9 applicable in a piecewise manner over two sub ranges for thermal radiation.

Physically, except during reentry or similar operations with extremely high aerodynamic drag, the surface temperatures of spacecraft in space do not approach the range where surfaces emit in the solar range. Thus, surface emissions from spacecraft, planetary surfaces, and other non-glowing physical bodies have surface properties as defined by the second relation in Equation 4.10. Irradiation coming from the Sun, or reflected irradiation that originated from the Sun, however, emit in the solar range. Thus, incident or reflected irradiation from the Sun uses surface properties as defined by the first relation in Equation 4.11.

From the perspective of a spacecraft, which emits infrared thermal radiation but likewise absorbs incident solar thermal radiation, it is meaningful to define the  $\epsilon_{ir}$ , for both infrared thermal emittance and absorptivity, and  $\alpha_s$ , for solar thermal absorptivity.

#### **4.9.5 THERMAL CONTROL VALUES**

This section provides values necessary to estimate heat transfer both within a spacecraft and between a spacecraft and its environment. In fact, many values below may apply both to thermal control within a spacecraft as well as to heat rejection from the spacecraft.

Table 4.78 presents solar absorptivities and infrared emissivities for several common aerospace structural materials. The end-of-life properties reflect changes associated with external usage in near-Earth space, and are not applicable within the crew cabin. While surfaces within the crew cabin certainly wear, aging mechanisms differ from those in the vacuum of space or even on the Martian surface. Thus, as a first approximation emissivities for new materials apply even for a used interior.

**Table 4.78 Surface Optical Properties for Common Exterior Space Material**

Material	New		End-of-Life <sup>178</sup>	
	$\alpha_s$	$\epsilon_{ir}$	$\alpha_s$	$\epsilon_{ir}$
Silverized Teflon	0.07	0.80	0.14	0.80
Aluminized Teflon	0.12	0.80	0.20	0.80
Ortho Fabric <sup>179</sup>	0.18	0.84		
Beta Cloth	0.26	0.90		
A276 White Paint	0.28	0.87	0.36	0.90
Clear Anodized Aluminum	0.38	0.83	0.58	0.79
Gold Anodized Aluminum	0.55	0.81	0.63	0.81
Black Anodized Aluminum	0.81	0.88	0.84	0.79
Alodine Aluminum	0.45	0.35		
Bare Stainless Steel	0.42	0.11		
Sand-Blasted Stainless Steel	0.58	0.38		
Bare Titanium	0.52	0.12		
Tiodized Titanium	0.82	0.51		

**References**

From Conger and Clark (1997) unless otherwise noted.

Within the crew cabin, thermal considerations are dictated by two concerns. The first is crew comfort and maintaining equipment within its thermal bounds. The second concern is to maintain humidity within an acceptable range. If the overall cabin atmospheric temperature drops below the local dew-point temperature, water vapor is allowed to condense. Because liquid water poses a significant hazard to electronics especially in weightless situations, maintaining cabin atmospheric and humidity within prescribed limits is important. Table 4.79 presents applicable thermal limits for crew cabins.

**Table 4.79 Crew Cabin Thermal Ranges**

Parameter	Units	Assumptions		
		lower	nominal	upper
Air Temperature <sup>180</sup>	K	291.15		300.15
Dew-Point Temperature	K	271		295
Relative Humidity	%	25		75
Ventilation	m/s	0.076		0.6096

**Reference**

NASA HIDH (2014); dew points calculated at the given air temperature and RH.

Transport properties for several common thermal control working fluids are tabulated in Table 4.80 at likely operating temperatures. These values support basic thermal loop energy balances.

<sup>178</sup> These values apply to external applications only because aging and wear mechanisms within the crew cabin differ considerably from external aging and wear mechanisms. As a first approximation, surface properties for materials within the crew cabin do not change with time.

<sup>179</sup> The exterior fabric on the EMU.

<sup>180</sup> The cabin “dry bulb” atmospheric temperature.

**Table 4.80 Properties for Common Thermal Control Loop Working Fluids**

Fluid	Hazards	Temperature = 280.0 K			Temperature = 297.0 K			Temperature = 300.0 K		
		Density [kg/m <sup>3</sup> ]	Specific Heat [kJ/kg•K]	Viscosity [kg/m•s]	Density [kg/m <sup>3</sup> ]	Specific Heat [kJ/kg•K]	Viscosity [kg/m•s]	Density [kg/m <sup>3</sup> ]	Specific Heat [kJ/kg•K]	Viscosity [kg/m•s]
Water		1,002.08	4.204	0.00148				998.35	4.187	0.00083
30% Ethylene Glycol / 70% Water	Irritant	1,042.15	3.741	0.00311				1,033.34	3.788	0.00176
60% Ethylene Glycol / 40% Water	Irritant	1,083.84	3.130	0.00796				1,071.70	3.216	0.00417
50% Propylene Glycol / 50% Water					1042	3.54	.0055			
40% Glycerin / 60% Water					1097	3.015	0.0029			
Fluorinert 72		1,722.12	1.025	0.00117				1,669.92	1.056	0.00092
Hydrofluoroether HFE-7100		1,522.76	1.147	0.00088				1,477.38	1.187	0.00071
Ammonia (liquid)	Toxic	628.20	4.679	0.000232				600.46	4.854	0.00021
D Limonene	Flammable				847.5	2.05	0.00091			

**References**

From Schoppa (1997) unless noted otherwise.  
 Propylene glycol/water Properties from Dowfrost.com  
 Glycerine/water properties from Lienhard (1981)

Table 4.81 and Table 4.82 provide appropriate thermodynamic values to compute energy balances of phase-change materials for representative materials. Of the materials available, both here and more generally, water requires the greatest heat input for the least mass and is the “best” phase-change material available, although the temperatures at which it transitions from one phase to the next sometimes prohibits its use. While the temperature at which a liquid boils varies directly with pressure, melting point temperatures are effectively invariant with pressure for applications likely to see use in space flight.

**Table 4.81 Thermodynamic Properties of Common Thermal Control Phase-Change Materials for Liquid-Vapor Transitions**

Material	Formula	Liquid Density [kg/m <sup>3</sup> ]	Saturation Pressure [kPa]	Saturation Temperature [K]	Heat of Vaporization [kJ/kg]	Reference
Ammonia	NH <sub>3</sub>	702.2 <sup>(1)</sup>	40.7 <sup>(1)</sup>	223.2 <sup>(1)</sup>	1,425.8 <sup>(1)</sup>	<sup>(1)</sup> Howell and Buckius (1987)
		690.1 <sup>(1)</sup>	71.6 <sup>(1)</sup>	233.2 <sup>(1)</sup>	1,392.5 <sup>(1)</sup>	
		677.5 <sup>(1)</sup>	119.5 <sup>(1)</sup>	243.2 <sup>(1)</sup>	1,361.1 <sup>(1)</sup>	
Water	H <sub>2</sub> O	1,000 <sup>(1)</sup>	0.61 <sup>(1)</sup>	273.2 <sup>(1)</sup>	2,500.0 <sup>(1)</sup>	
		1,000 <sup>(1)</sup>	1.23 <sup>(1)</sup>	283.2 <sup>(1)</sup>	2,478.4 <sup>(1)</sup>	
		998 <sup>(1)</sup>	2.34 <sup>(1)</sup>	293.2 <sup>(1)</sup>	2,455.0 <sup>(1)</sup>	

**Table 4.82 Thermodynamic Properties of Common Thermal Control Phase-Change Materials for Solid-Liquid Transitions**

Material	Formula	Solid Density [kg/m <sup>3</sup> ]	Liquid Density at 293.2 K [kg/m <sup>3</sup> ]	Melting Temperature [K]	Heat of Fusion [kJ/kg]	References
Water	H <sub>2</sub> O	920 <sup>(1)</sup>	998 <sup>(2)</sup>	273.2 <sup>(3)</sup>	333.5 <sup>(3)</sup>	<sup>(1)</sup> Incropera and DeWitt (1985)
Waxes (Paraffin)						<sup>(2)</sup> Howell and Buckius (1987)
n-Dodecane	C <sub>12</sub> H <sub>26</sub>		748.7 <sup>(3)</sup>	263.6 <sup>(4)</sup>	210.5 <sup>(4)</sup>	<sup>(3)</sup> Weast and Astle (1979)
n-Tetradecane	C <sub>14</sub> H <sub>30</sub>		762.8 <sup>(3)</sup>	279.1 <sup>(4)</sup>	229.9 <sup>(4)</sup>	<sup>(4)</sup> Humphries and Griggs (1977)
n-Hexadecane	C <sub>16</sub> H <sub>34</sub>		773.3 <sup>(3)</sup>	291.4 <sup>(4)</sup>	228.9 <sup>(4)</sup>	
n-Octadecane <sup>181</sup>	C <sub>18</sub> H <sub>38</sub>		776.8 <sup>(3)</sup>	301.4 <sup>(4)</sup>	243.5 <sup>(4)</sup>	

#### 4.10 CREW HEALTHCARE

Qualitative impact of the challenges for designers of medical care systems are complex. The health care system can't look like its Earth counterpart because of the effects of gravity as well as mass, power, volume, and crewtime restrictions that are certain to be levied on the system. It could be argued that the medical system has been minimal to this point and there's been little need to make it more inclusive, but as missions move farther from Earth and have longer durations, the likelihood of necessary medical intervention becomes greater.

<sup>181</sup> The liquid density for n-octadecane is evaluated at 28°C.

Consider the possible illnesses and injuries divided into three classes (Table 4.83). Since treatment in Class I is unlikely to have a large impact on life support commodities and Class III treatment might be prohibitively expensive, the therapies likely to impact life support are those therapies in response to Class II illnesses and injuries.

**Table 4.83 Classification of Illnesses and Injuries in Healthcare (Houtchens, 1993)**

Characteristics	Examples	Response
<b>Class I</b>		
Mild Symptoms	Gastrointestinal Distress	Self Care
Effects Performance Minimally	Headache	
No Threat To Life	Mild Ulcer	
Prognosis Is Self-Limited	Laceration of Abrasion	
	Sprains and Strains	
<b>Class II</b>		
	Urinary Infection or Inflammation	Self Care
	Respiratory Irritation	
	Allergy, Conjunctivitis, or, Dermatitis	
Moderate To Severe Symptoms		Prompt adequate diagnosis and treatment
Marked Effect On Performance	DCS	
Potentially Life Threatening	Air Embolism	
Could Be Protracted	Arrhythmia	
	Partial Circulatory Blockage	
	Ulcer	
	Respiratory Distress	
	Toxic Inhalation Exposure	
	Chemical burns	
	Stones	
	Diverticulitis	
	Appendicitis	
<b>Class III</b>		
Symptoms Immediate And Severe	Explosive Decompression	Evaluate Promptly and Transport or; Take Measures to Store, Return, or Destroy the Body
Incapacitating	Complicated Heart Malfunction	
Life Threatening If Not Immediately Fatal	Overwhelming Infection	
Crewmember Won't Survive If Not Treated Promptly	Crush Injury	
	Brain Surgery	
	Burn > 40% of Body Surface Area	

The question from a life support perspective is how do medical activities affect ECLSS commodities? Certainly some of the issues in Table 4.83 have been addressed by planners, as the EVA suit is required to have the capability of a one-time increase in pressure to 156.5 kPa for treatment of DCS. Conceivably, the suit could also act as an oxygen delivery device without increasing the cabin oxygen percentage, but such an arrangement would present obstacles for such activities as surgical procedures, intravenous therapy, or certain kinds of diagnostic testing. A rebreathing mask or a valved non-rebreathing mask might aid in oxygen delivery without significantly increasing cabin oxygen levels (Yam, 1993).

Medical care is mentioned in NASA-STD-3001 (2007) and five levels of care are identified. The Lunar and Mars Sortie and Outpost missions would fall under “Level of Care Four,” which is listed as a moderate level of risk for medical issues (mission length from 30 days to 210 days). Preventative measures are still being stressed at this level, but intervention strategies should be available to reduce risk to an acceptable level. Medical capabilities will be limited because of limited ability to rapidly return to Earth in the event of a major crisis. Strategies to limit risk include increasing the advanced care in the form of medications, equipment, training, or consumables over and above previous levels. It is the level of consumables that will most affect life support and thus is an area where further definition is desirable. The following example may be used as a starting point: (Table 4.84 and Table 4.85).

**Table 4.84 Medical Hardware and Stowage - Lunar Outpost**

Item	Mass, kg	Volume, m <sup>3</sup>	Development Concept
Medical System	136	1.50 (similar to ISS ISO rack)	Program Provided
Telemedicine Workstation	22.7	Technology development	
Contaminant Cleanup Kit	4.5	COTS	
Portable Imager (Ultrasound)	6.8	COTS	
Advanced Life Support/Trauma Stabilization Kit	11.3	Modified COTS	
Medical Procedure Kit ---Dental ---Laceration repair ---Acute Care pack	9.1	COTS	
Environmental Hardware ---Total Organic Carbon Analyzer ---Volatile Organic Analyzer ---Radiation Detection System ---Compound Specific Analyzer ---Microbiology Analyzer ---Dust Monitor ---Acoustic Monitoring ---Hearing Protection Device	45.4	Based on ISS hardware, technology development will be necessary for miniaturization and better reliability.	
Contingency Breathing Apparatus (Possibly portable)	9.1	Modified COTS	
Other: Biomedical Sensors, Assisted Procedure Device, Medical Grade Water Generation, Closed Loop Oxygen Concentrator/Delivery System		Technology Development	

**Table 4.85 Medical Hardware and Stowage - Lunar Outpost Exercise Countermeasures or Dust Management**

Item	Mass, kg	Volume, m <sup>3</sup>	Development Concept
Aerobic	34	3.1	Tech. Dev't
Resistive	56.7	5.7	Tech. Dev't
Dust	Dust management: Suit Lock may reduce dust loading	No available data	Tech Dev't

**Table 4.86 Medical Hardware and Stowage- Lunar Sortie**

Item for Lunar Sortie	Mass, kg	Volume, m <sup>3</sup>	Development
Concept Medical Kit	4.5	0.007	COTS
Medical Contingency Kit	4.5	0.010	Modified COTS
EVA Contingency Response Kit (with Contamination Cleanup)	2.7	0.036	Modified COTS
Environmental Health Kit	0.23	0.007	Modified COTS
Exercise Equipment	2.3	0.003	Technology Development Required

#### 4.11 ENVIRONMENTAL MONITORING

An ECLS system provides a habitable environment in manned vehicles by fundamentally addressing the physical, chemical, and biological risks external to the human body that can impact the health of a person. Environmental health risks are mitigated not only by employing these active and passive controls, but also establishing environmental standards (SMACs, Spacecraft Water Exposure Guidelines, microbial and acoustics limits) and environmental monitoring. Because risks can vary during missions and change over time, environmental monitoring is considered a vital component to an environmental health management strategy for maintaining a healthy crew and achieving mission success. Environmental monitoring involves monitoring four aspects of the habitable environment of the vehicle to ensure crew health.

- Air Quality – assesses potential airborne contaminant exposures during space flight and establishes SMACs that will protect crew while living and working in space;
- Water Quality – assesses and characterizes the quality of water sources, verifies these systems meet potability requirements, and establishes Spacecraft Water Exposure Guidelines;
- Microbiology – assesses bacterial and fungal contamination levels in the air, water, and surfaces and addresses issues related to infectious disease and microbial ecology of spacecraft; Microbiology also establishes pre-flight and in-flight acceptability levels;
- Acoustics Management – assesses the spacecraft environment and ensures noise levels are within acceptable limits so the crew can comfortably and safely live, communicate, and work; Acoustics also establishes noise exposure levels.



Figure: 4.8 below shows the parameters used to assess environmental health. The various concentration limits and levels for crew health can be found in the Medical Operation Requirements Document. Table 4.87 lists the typical volatile organic compounds found in the habitable cabin of ISS. The average low and average high are based on ground analyses of returned grab sample containers from January 2001 to March 2011. Table 4.88 to Table 4.90 are the microbial limits and acoustic limits for ISS. Oxygen and carbon dioxide are monitored primarily by the Major Constituents Analyzer during nominal scenarios. During contingency scenarios, small, battery-powered, hand-held devices are used to back-up the Major Constituents Analyzer. System chemicals such as ammonia, used as the working fluid of the external thermal control system, are monitored for potential leaks.

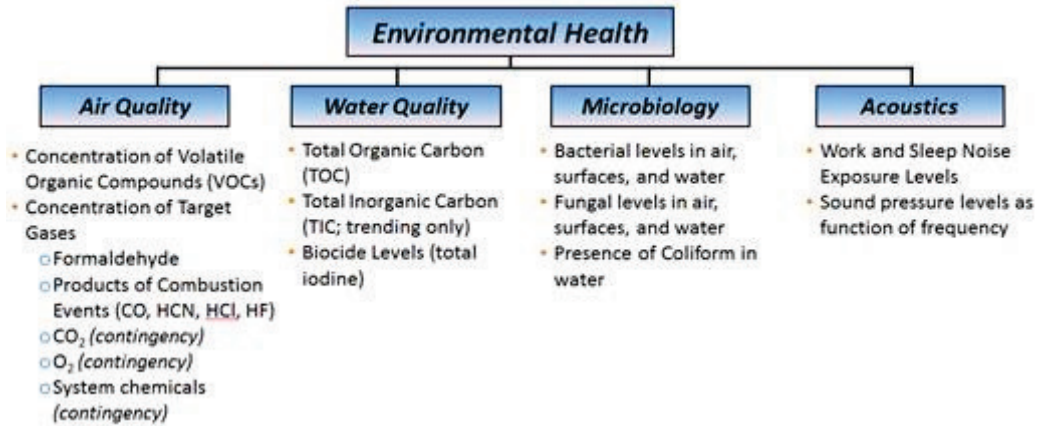

**Figure: 4.8 Environmental Health.**

**Table 4.87 Volatile Organic Compounds**

Volatile Organic Compounds*		Concentration Range (ppm)	
VOC Type	Chemical	low	high
Alcohols	**Ethanol	0.531	3.715
	**Methanol	0.076	0.763
	**2-Propanol	0.041	0.407
	**1-Butanol	0.016	0.330
	Propylene glycol	0.000	0.000
Aldehydes	Formaldehyde	0.008	0.081
	**Acetaldehyde	0.056	0.333
	**Acrolein (Propenal)	0.004	0.044
	Pentanal (C3-C8 Aliphatic Sat. Aldehyde)	0.003	0.142
	**Hexanal (C3-C8 Aliphatic Sat. Aldehyde)	0.002	0.122
Alkanes	Pentane (C5-C7 Alkanes)	0.003	0.169
	**Hexane (C5-C7 Alkanes)	0.003	0.142
Ketones	**Acetone	0.042	0.421
	**2-butanone	0.034	0.339
Organosilicones	**Octamethylcyclotetrasiloxane	0.008	0.165
	**Hexamethylcyclotrisiloxane	0.011	0.220
	**Decamethylcyclopentasiloxane	0.007	0.132
	**Trimethylsilanol	0.027	1.08
Aromatic	**Benzene	0.016	0.313
	Ethyl benzene	0.002	0.023
	**Toluene	0.027	0.265
	**ortho-Xylenes	0.023	0.230
	**meta, para-Xylenes	0.023	0.230
Halogenated	**Dichloromethane	0.014	0.288
	Freon 218 (perfluoropropane)	13.0	130
Esters	**Ethyl acetate	0.028	0.277
Combustion Products <sup>#</sup>		Monitoring Range	Accuracy
Carbon Monoxide (CO)		5 – 1000 ppm	5 - 50 ppm ±20% 50 – 1000 ppm ±10%
Hydrogen Cyanide (HCN)		1 – 50 ppm	1 – 50 ppm ±25%
Hydrogen Chloride (HCl)		1 – 50 ppm	1 – 50 ppm ±25%
Hydrogen Fluoride (HF)		1 – 50 ppm	1 – 50 ppm ±25%

**References:**  
 \*NASA (2003)  
 #James (2013)

\*\*denotes VOC currently monitored in real-time on board ISS

**Table 4.88 Microbial Specifications of USOS air and surfaces for ISS**

	Maximum for Bacteria	Maximum for Fungi
Air	1000 CFU/m <sup>3</sup>	100 CFU/m <sup>3</sup>
Internal Surfaces	10,000 CFU/100 cm <sup>2</sup>	100 CFU/100 cm <sup>2</sup>
*NOTE: Microbial specifications have been established to provide an alert level indicating that an assessment shall be performed to determine risk to crew health or systems performance. Refer to Section 7.4.6.		

**Table 4.89 Microbial Specifications of ISS water in USOS.**

Water Parameter	Units	Russian Ground-Supplied potable SVO-ZV (2)	Regenerated Potable SRV-K	Hygiene	U.S Water Recovery System and CWC-I (3)
Bacteria Count	CFU/mL	50	50	1000	50
Coliform Bacteria Count	CFU/100mL	Non-detectable	Non-detectable	Non-detectable	Non-detectable
Protozoa	N/A (4)	TT(5)	N/A	TT	TT
(1) Microbial acceptability limits have been established to provide an alert level indicating that an assessment shall be performed to determine risk to crew health or systems performance. (2) SSP 50129 standards apply to Russian grade water delivered by ATV. (3) SSP 50917 standards apply to U.S. grade water delivered by HTV. (4) N/A = not applicable (5) TT = Treatment Technique. Source water shall be filtered through a one micron filter. No analysis is required.					

**Table 4.90 Acoustic Noise Limits in the USOS of ISS.**

Work Area	Octave Frequency Band, Hz							
	63	125	250	500	1000	2000	4000	8000
(NC-50)	71	64	59	54	51	49	48	47
(NC-48 + NC-50) where payload complement applies	73	66	60	56	53	51	50	49
Sleep Area (NC-40)	64	56	50	45	41	39	38	37

#### 4.12 IN-SITU RESOURCE UTILIZATION INTERFACE

Significant quantities of local resources are available at Mars that might be used for life support. Sridhar, *et al.* (1998) identified some resources that might be needed (Table 4.91) Drysdale (1998) estimated very roughly the masses required for each resource and the cost leverage that seemed credible from ISRU based on data from John Finn (NASA Ames Research Center). (See Table 4.92)

Regolith may be used for radiation and meteoroid protection at a long-term base, and would be available for the cost of moving it and bagging it.

Water would be a high leverage item, particularly if bioregeneration is used extensively. It could be available from the atmosphere, despite its dryness, from permafrost that is expected to be extensive a meter or two below the surface, from polar ice, or from subsurface water or ice deposits. It could also be made from atmospheric carbon dioxide, if a source of hydrogen is available. Even if hydrogen had to be shipped from Earth, this would still give a 5-to-1 cost advantage. The cost of acquisition would depend on the cost of

extraction and purification. Currently, the abundance and location of water on Mars is undetermined. The atmosphere of Mars carries water vapor in minimal quantities. Likewise, large deposits of water exist at both Martian poles, but accessing that water is complicated by the seasonal deposition of frozen carbon dioxide on top of the ice deposits. Atmospheric carbon dioxide could support plant growth, particularly if a plant growth unit is set up and started remotely. It could be readily extracted from the atmosphere, which is 95% carbon dioxide, though at a low pressure.

An inert gas would be needed to dilute the cabin oxygen, assuming the base air would not be pure oxygen. This could be extracted from the atmosphere by removing the carbon dioxide and water vapor.

Finally, oxygen, for crew respiration can be obtained from the atmosphere, either by removing the rest of the gas, or by reaction with the atmospheric carbon dioxide using either a Sabatier/electrolysis or Zirconia cell reaction.

A design reference mission (Hoffman and Kaplan, 1997) proposes using local resources to make rocket propellant, liquid methane, and liquid oxygen, for the Mars ascent vehicle from the Martian atmosphere. While oxygen is available as a product from splitting carbon dioxide, methane production requires a source of hydrogen. Water provides a readily used source of hydrogen but, as addressed above, it may not be readily available. The design reference mission avoids the issue of water availability by providing liquid hydrogen from Earth for ISRU propellant production.

Similar propellants could be used for power storage, including propelling surface or aerial vehicles, especially if a local source of water is available. In addition, the same chemical processing plant could be used to make life support commodities, such as listed below in Table 4.93. Some of these, inert gases, for example, might be made available as by-products at minimal added cost.

Note that shipped commodities will have a negative cost leverage to account for packaging. This can be a significant mass factor, as shown in

Table 4.5 for permanent gases. This is in addition to any cost factor for the shipping location as identified in Table 3.3.

**Table 4.91 Nitrogen Gas Losses Associated with International Space Station Technology**

Parameter	Mass [kg/y]	Comments
Nitrogen Resupplied	796	
ISS Module Leakage	18 - 44	
Airlock Losses	10%	mass of nitrogen lost per cycle is 1 kg

**Reference**  
Information from Sridhar, *et al.* (1998)

**Table 4.92 Nitrogen Gas Losses for the Mars Design Reference Mission (One Cycle) Using ISS Technologies**

Mission Phase	Event	Mass [kg]	per Event	Total Mass Lost [kg]	Calculation Basis
Transit	Module Leakage	$\leq 0.15^{(2)}$	day	39	260 days transit; both ways
Surface	Airlock Usage	1	cycle	1,200	2 cycles/day for 619 days
Surface	Module Leakage	$\leq 0.15^{(2)}$	day	93	619 days
<b>Total</b>				<b>1,332</b>	Gas Mass Excluding Tanks

**Reference**  
(<sup>1</sup>) Sridhar, *et al.* (1998)  
(<sup>2</sup>) CA0042-PO, NASA, 2011)

**Table 4.93 Estimation of Cost Leverages from In-Situ Resource Utilization** <sup>182</sup>

Commodity	Requirement [kg]	Cost Leverage	Comments / Assumptions	Likelihood <sup>183</sup>
Regolith	620,000	3,100	Assumes a Rover is Available	Always
Water	12,000	310	From Local Permafrost	Unknown to Unlikely
Water	12,000	390	From Local Atmosphere	Unlikely
Water	12,000	5	Produced Using Hydrogen from Earth	Always
Carbon Dioxide	528	47	For 30 days of Plant Growth; Using Local Atmosphere	Always
Inert Gas (Argon/Nitrogen)	508	1.6	From Local Atmosphere	Always
Oxygen	121	19	From Electrolysis of Local Water	Unknown to Unlikely
Hydrogen	system dependent	1.2	From Electrolysis of Local Water	Depends on water availability

Allen and Zubrin (1999) suggest ISRU is also available on the Moon, though the variety and source of commodities is different. Specifically, oxygen is available as an oxide within the lunar regolith. Further, though very limited in extent, water, as ice, is present in deep craters at both lunar poles.

#### 4.13 INTEGRATED CONTROL INTERFACE

Most life support uses direct feedback with manual override capability possible or even likely. Adding oxygen to the cabin was done by relatively slow response valves, which might overshoot their target point; but the overall effect on the system was small as the operating point was not critical. As processes become more interrelated, and as the mass of commodities is more critical, control systems must be more sophisticated, faster responding with greater accuracy of information, and autonomous control of many interdependent systems.

Life support missions prior to the ISS were open loop and involved measuring temperature, pressure, and flowrate using fairly simple devices. Lunar and Mars Life Support Systems will likely require detailed air and water composition using real-time measurements without frequent intervention from the crew. Smart sensors, which combine the sensing device, electronics, data processing, and data analysis, can speed up control processes and reduce computer loads. Arrays of sensors are possible with built in redundancy and diagnostics, all on a single chip (Finn, 1993). Much of this work is being done at the NASA Glenn Research Center in Cleveland, Ohio (Hunter, 2005).

Research on advanced automation specific to life support has been limited, although much attention has been devoted to control algorithm development in general. System integration refers to the problem of putting together disparate, heterogeneous systems to perform specific system functions to meet system operating goals (Overland, 2006). As missions develop to the point where there is greater closure of life support elements (recycling and reuse of elements of the system), longer operating times with smaller buffers, interdependencies between systems or system elements, and increased system closure, the missions are going to require more responsive or more robust control (Finn, 1993). Addition of biological components will further complicate the system as reactions and reaction rates are generally more complex than physical chemical processes. The individual processes will have to be thoroughly understood to apply control algorithms effectively.

<sup>182</sup> From Drysdale (1998) using data from J. Finn (NASA/Ames Research Center). These estimates are very preliminary.

<sup>183</sup> Likelihood assesses how likely a particular commodity might be available based on current knowledge of Mars for a typical site. Assessment scale: "Always" implies availability at all sites. "Likely" implies availability at most sites in unlimited quantities. "Unlikely" implies availability at some sites in unlimited quantities, or available at most sites in limited quantities. "Unknown" implies unknown availability.

## 4.14 BIOMASS PRODUCTION

### 4.14.1 PLANT GROWTH CHAMBERS

#### 4.14.1.1 LIGHTING ASSUMPTIONS

Plants offer the greatest opportunity for self-sufficiency and, possibly, cost reduction for long-duration missions, but at the same time have some of the greatest unknowns. An attempt has been made to estimate the mass of a plant growth system on the surface of an extraterrestrial body such as Mars. Two uncertainties are the cost of power, and the availability of water locally. The initial assumption, as shown in Table 4.94, is that natural lighting cannot be used because the solar radiation reaching Mars is only 43% that reaching Earth, and Mars is susceptible to large dust storms that can reduce light reaching the surface. Yet recent analyses suggest that some latitudes on Mars can receive up to 30 mol/(m<sup>2</sup>•d) for much of the year, which is nearly 50% that of some of the brightest areas on Earth (Clawson, 2006), so future biomass production systems might use natural sunlight supplemented by electrical lighting to achieve optimal biomass production per infrastructure mass required.

In addition, fresh food is crucial to crew welfare, and nutritionists generally recommend deriving food from original sources such as grown plants and/or livestock. Because livestock production is more expensive even terrestrially, early in-situ food production will likely concentrate on growing crops. As shipped, fresh foodstuffs from crops are heavier than dehydrated or low-moisture foods due to the significant mass associated with natural moisture. Thus, while plants will probably be grown on an extraterrestrial body, the question remains as to what proportion of the food will be grown locally versus what proportion will be shipped.

**Table 4.94 Lighting Data**

Parameter [Units]	low	nominal	high	References
Light Conversion Efficiency [W <sub>photosynthetically active radiation</sub> /W <sub>electrical</sub> ] <sup>184</sup>	0.18 <sup>(1)</sup>		0.5 <sup>(1)</sup>	<sup>(1)</sup> Personal communication with J. Sager in 1999 <sup>(2)</sup> Bourget (2014) <sup>(3)</sup> Personal communication with J. Sager 2006
Light Delivery Efficiency [PPF <sub>delivered</sub> /PPF <sub>emitted</sub> ] <sup>185</sup>	0.3 <sup>(1)</sup>		0.8 <sup>(3)</sup>	
Overall Lighting Efficiency	0.05 <sup>(1)</sup>	0.40 <sup>(2)</sup>	0.40 <sup>(3)</sup>	

A key parameter for plant growth is lighting, and electrical lighting might provide this. The efficiency of electrical lighting depends on the efficiency of the conversion of electricity into radiant energy, and the direction of this energy onto the plant canopy. The conversion efficiency depends on the type of lamp. Thus, many factors impact photosynthetically active radiation (PAR). Photosynthetic photon flux (PPF) is another way of expressing PAR but specifically using quantum units, such as μmol/(m<sup>2</sup>•s), instead of W/m<sup>2</sup>. Incandescent lamps are good because they are red-rich, but the conversion efficiency to PAR is low. High-pressure discharge lamps produce more light, but their spectrum varies depending on the type of lamp, with metal halide lamps producing a broad spectrum and high-pressure sodium producing a yellow-orange light with a low amount of blue. Both types have proved acceptable for photosynthesis. Some lamp types, such as microwave lamps, have a high efficiency and a broad spectrum (personal communication with J. Sager in 1999), yet improvements are needed in their magnetron power supplies to sustain long duty cycles. Direction of the energy to the canopy depends on the geometry of the lamp, the distance from the lamp to the canopy, and the quality of the reflectors. The Biomass Production Chamber (BPC) at Kennedy Space Center used relatively unsophisticated reflectors, and only achieved a rating of about 30%. Much higher ratings can be achieved, but maintaining these high ratings over long time periods requires upkeep, such as periodic cleaning and adjustments to the lamp reflectors.

<sup>184</sup> Light Conversion Efficiency describes the proportion of lighting system power that eventually becomes PPF.

<sup>185</sup> Light Delivery Efficiency describes the proportion of PPF at the lamp surface that is delivered to the canopy.

Nelson and Bugbee (2014) point out that artificial plant growth lights have been improving rapidly and report the following values for photosynthetic photons per Joule of electrical energy:

- High-pressure sodium (HPS) (double ended) 1.70 micromoles/J
- Light-emitting diode (LED) 1.66 micromoles/J
- Fluorescent 0.95 micromoles/J

The authors explain that “Photosynthesis and plant growth is determined by moles of photons. It is thus important to compare lighting efficiency based on photon efficiency, with units of micromoles of photosynthetic photons per joule of energy input. This is especially important with LEDs where the most electrically efficient colors are in the deep red and blue wavelengths.”

If LEDs are run well below their rated current, their electrical efficiencies can be quite high. For the Veggie plant growth system on ISS, overall light cap efficiency is about 40% at maximum light (Bourget, M, 2014). Individual LED efficiencies are:

- Red 34.5%
- Blue 69%
- Green 24.5%

Again, see Nelson and Bugbee (2014) for a better understanding of this subject.

#### 4.14.1.2 LIGHTING EQUIPMENT DATA

Additional assumptions can be made about specific lighting systems. Data for 400 W HPS are shown in Table 4.95.

**Table 4.95 High Pressure Sodium Lighting Data**

	Units	low	nominal	high	References
Lamp Power (not including ballast)	kW	--	0.4 <sup>(2)</sup>	--	<sup>(1)</sup> Personal Communication with A. Drysdale in 1999
Lamp Mass	kg		0.21 <sup>(2)</sup>		<sup>(2)</sup> Hanford (1997)
Lamp Life	10 <sup>3</sup> h		20 <sup>(1)</sup>	24 <sup>(1)</sup>	<sup>(3)</sup> Hunter and Drysdale (2002) based on Personal communication with J. Sager in 1999
Number of 400 W Lamps per Area to Give 1,000 μmol/(m <sup>2</sup> •s)	lamps/m <sup>2</sup>	1.43 <sup>(3)</sup>	4.504 <sup>(4)</sup>	9.259 <sup>(3)</sup>	<sup>(4)</sup> Hunter and Drysdale (2002) based on Ewert (1998)
Time to Change Out Lamps	CM-h		0.03 <sup>(5)</sup>		<sup>(5)</sup> A rough value from Hunter, J.
Photoperiod per Day <sup>186</sup>	h/d	10 <sup>(1)</sup>	10-24 <sup>187</sup>	24 <sup>(1)</sup>	<sup>(6)</sup> Personal Communication with M. Ewert in 2001
Lamp Volume for Resupply	m <sup>3</sup> × 10 <sup>-3</sup>		0.625 <sup>(1)</sup>		<sup>(7)</sup> Barta and Ewert (2002)
Ballast Power	kW/lamp	0.03 <sup>(1)</sup>	0.06 <sup>(2)</sup>	0.08 <sup>(1)</sup>	<sup>(8)</sup> Ewert (1998)
Ballast Mass	kg/lamp	2.85 <sup>(6)</sup>	4.76 <sup>(1)</sup>	9.52 <sup>(2)</sup>	<sup>(9)</sup> BIO-Plex drawings
Ballast Life	10 <sup>3</sup> h		88 <sup>(7)</sup>		<sup>(10)</sup> See Table 3.10. This value corresponds to storing lamps within trays.
Mass of Coldplate, Water Barrier, Condensing Heat Exchangers per Growing Area	kg/m <sup>2</sup>	4.43 <sup>(8)</sup> <sup>188</sup>	7.02 <sup>(8)</sup> <sup>189</sup>	25.83 <sup>(8)</sup> <sup>190</sup>	
Height of Lighting Assembly	m		0.15 <sup>(9)</sup>	0.3 <sup>(1)</sup>	
Lamp Resupply Mass Factor	kg/kg		0.8 <sup>(10)</sup>		
Lamp Resupply Volume Factor	m <sup>3</sup> /m <sup>3</sup>		0.5 <sup>(1)</sup>		

Resupply mass and volume factor account for the extra mass and volume required to package replacement lamps. This is in addition to any mass and volume associated with the lamp itself.

<sup>186</sup> This is generally crop dependent, although the values here provide the range for all ELS crops.

<sup>187</sup> See Table 4.97 for nominal photoperiods of candidate Life Support crops.

<sup>188</sup> This system uses only a bulb in a water jacket. Transmissivity, relative to the baseline case using a coldplate and no barrier, is 0.92. The ratio of total radiation to PAR is 1.6 compared to 2.0 for the baseline. Note: This configuration provided the best overall performance in testing.

<sup>189</sup> This system uses a bulb in a water jacket with a Teflon barrier. Transmissivity, relative to the baseline case using a coldplate and no barrier, is 0.846. The estimated ratio of total radiation to PAR is 1.6 compared to 2.0 for the baseline.

<sup>190</sup> This system uses a coldplate with a glass barrier. Transmissivity, relative to the baseline case using a coldplate and no barrier, is 0.89. The ratio of total radiation to PAR is 1.7 compared to 2.0 for the baseline.



#### 4.14.1.3 PLANT GROWTH CHAMBER COST FACTORS

The cost factors for a plant growth chamber have been estimated on a square-meter basis. This addresses the plant growth chamber itself. If crew access is needed, and it generally will be, provision must be made for that access. A reasonable number might be 25 – 50% of the plant canopy area. Lower numbers might be adequate if extensive physical automation is planned. A higher number might be appropriate if most tasks are performed manually. Crew access space would not, however, require the equipment and other “costs” shown here. Crew height will be greater than the height of most plants that have been considered for Life Support crops. Layout of the crops and crew space will depend on issues such as the type of plant lighting. Thus, if natural lighting is to be used, only a single layer of crops might be possible due to the diffuseness of light on Mars. In this case, the limiting height would be the taller of the crew and the plants. Table 4.96 (Drysdale, 1999b) presents preliminary values for an optimized biomass production chamber based on projecting current NASA growth chambers to flight configurations.

From a power perspective, most research has focused on more efficient lighting and progress has been made. Integrated plant growth chambers also need power for blowers, pumps, etc. Reference values for biomass production per unit energy range from 1.6 g/kWh (based on JSC’s VPGC) to 10 g/kWh (based on a mixed crop in South Pole Food Growth Chamber).

**Table 4.96 Plant Growth Chamber Equivalent System Mass per Growing Area**

Component	Mass [kg/m <sup>2</sup> ]	Volume [m <sup>3</sup> /m <sup>2</sup> ]	Power [kW/m <sup>2</sup> ]	Thermal Control [kW/m <sup>2</sup> ]	Crew-time [CM-h /m <sup>2</sup> •y]	Logistics [kg /m <sup>2</sup> •y]	Reference
Crops	20.0	–	–	–	13.0		From Drysdale (1999)
Shoot Zone	3.6	0.67	0.3 <sup>191</sup>	0.3 <sup>191</sup>	–	–	
Root Zone Water and Nutrients	36.8	0.11	0.14	0.14	TBD	TBD	
Lamps	22.9	0.25	2.1	2.1	0.027	0.57	
Ballasts	8.4	TBD	0.075	0.075	0.032	3.24	
Mechanization Systems	4.1	TBD	TBD	TBD	TBD	TBD	
Secondary Structure	5.7	–	–	–	–	–	
<b>Total</b>	<b>101.5</b>	<b>1.03</b>	<b>2.6</b>	<b>2.6</b>	<b>13.1</b>	<b>3.81</b>	

#### 4.14.1.4 PLANT VALUES

##### 4.14.1.4.1 TIME-AVERAGED VALUES DESCRIBING PLANT GROWTH

Plant growth rates depend on the type of plant (species and cultivar) and the growth conditions. Table 4.87 through Table 4.89 provide design values for candidate crops for space (Behrend and Henninger, 1998).

Table 4.97 presents overall life-cycle growth rates in terms of grams of biomass per square meter per day. The dry mass (dw) fresh mass (fw)<sup>192</sup> and water content for both edible and inedible biomass are given. The harvest index is the ratio of edible biomass to total biomass. Table 4.99 provides nominal and upper biomass

<sup>191</sup> Power consumption and thermal control within the shoot zone reflect fans for gas movement.

<sup>192</sup> Historically, “dw” and “fw” denote “dry weight” and “fresh weight,” respectively. Scientifically, these quantities are masses and not weights. Weight is a force derived from the gravitational attraction between a body and, practically, a much larger body such as a planet. Thus, a body always has mass, but it has weight only within a planet’s gravitational field.

generation rates. The lower rate is zero, and the given upper limit is the highest rate recorded in the literature. This may not be the absolute maximum, however. For example, wheat may well produce higher growth rates with higher light intensities (received from a personal communication from B. Bugbee, 1998). These maximal rates are generally for small chambers under ideal conditions, and they might be difficult to achieve in larger chambers that have been optimized for space flight. The nominal rates are derived from testing within the BPC at Kennedy Space Center (personal communication with R. Wheeler in 2001), and the values presented may be composite or average values from several different tests. These rates are lower partly because of the lower light levels, but a less homogeneous environment, due to the larger scale, may also impact the growth rates. In addition, BPC data are conservative in that they used fixed spacing from germination to harvest. Use of variable spacing or transplanting schemes for widely spaced crops could save up to 15 days on production cycles. For example, the cycle for lettuce is reduced from 28 to ~14 days. Obviously, seedling nurseries would require some area, but this would be on the order of only 1% to 10% of the area required for mature-plant production. Table 4.98 also presents the biomass chemical composition in terms of carbon and the metabolic reactants and products averaged over the crop life cycle.

**Table 4.97 Exploration Life Support Cultivars, Intended Usage, and Environmental Growth Conditions**

Crop	ELS Transit Crop <sup>(1)</sup>	ELS Surface Crop <sup>(1)</sup>	Photosynthetic Photon Flux [mol/(m <sup>2</sup> •d)]	Diurnal Photo-Period [h/d] <sup>(3)</sup>	Growth Period <sup>193</sup> [dAP]	Temperatures [ C] <sup>(3)</sup>		
						Air during Day	Air during Night	Nutrient Solution
Cabbage	×	×	28 <sup>(2)</sup>		85 <sup>(4)</sup>	>25		
Carrot	×	×	28 <sup>(2)</sup>		75 <sup>(4)</sup>	16-18		
Chard	×	×	17 <sup>(2)</sup>	16	45 <sup>(3)</sup>	23	23	23
Celery			17 <sup>(2)</sup>		75 <sup>(4)</sup>			
Dry Bean		×	24 <sup>(3)</sup>	18	85 <sup>(5)</sup>	28	24	26
Green Onion			26 <sup>(6)</sup>		50 <sup>(5)</sup>	25	25	25
Lettuce	×	×	17 <sup>(3)</sup>	16	28 <sup>(3)</sup>	23	23	23
Mushroom			0	0				
Onion	×	×	17		50			
Pea			24 <sup>(2)</sup>		75 <sup>(4)</sup>			
Peanut		×	27 <sup>(3)</sup>	12	104 <sup>(3)</sup>	26	22	24
Pepper			27 <sup>(2)</sup>		85 <sup>(5)</sup>			
Radish	×	×	26 <sup>(6)</sup>	16	25 <sup>(4)</sup>	23	23	23
Red Beet			17 <sup>(3)</sup>	16	38 <sup>(3)</sup>	23	23	23
Rice		×	33 <sup>(3)</sup>	12	85 <sup>(3)</sup>	28	24	24
Snap Bean			24 <sup>(2)</sup>	18	85 <sup>(5)</sup>	28	24	26
Soybean		×	28 <sup>(3)</sup>	12	97 <sup>(3)</sup>	26	22	24
Spinach	×	×	17 <sup>(3)</sup>	16	30 <sup>(4)</sup>	23	23	23
Straw-berry			22 <sup>(3)</sup>	12	85 <sup>(4)</sup>	20	16	18
Sweet Potato		×	28 <sup>(3)</sup>	12	85 <sup>(5)</sup>	26	22	24
Tomato	×	×	27 <sup>(3)</sup>	12	85 <sup>(3)</sup>	24	24	24
Wheat		×	115 <sup>(4)</sup>	20-24	79 <sup>(3)</sup>	20	20	18
White Potato		×	28 <sup>(3)</sup>	12	132	20	16	18

**References**

Information from Drysdale 2001 except as noted.  
<sup>(1)</sup>Behrend and Henninger (1998)  
<sup>(2)</sup>Estimated by similarity to other crops.  
<sup>(3)</sup>Wheeler, *et al.* (2003)  
<sup>(4)</sup>personal communication with R. Wheeler in 2001  
<sup>(5)</sup>Ball, *et al.* (2001) and EDIS (2001)  
<sup>(6)</sup>Richards, *et al.* (2005, 2006)

<sup>193</sup> Growth period is measured here in terms of “days after planting,” [dAP].

**Table 4.98 Overall Physical Properties at Maturity for Nominal Crops** <sup>194</sup>

Crop	Mature Plant Height [m]	Harvest Index [%]	Edible Biomass Productivity			Inedible Biomass Productivity		
			Dry Basis [g <sub>dw</sub> /m <sup>2</sup> •d]	Fresh Basis [g <sub>fw</sub> /m <sup>2</sup> •d]	Fresh Basis Water Content [%]	Dry Basis [g <sub>dw</sub> /m <sup>2</sup> •d]	Fresh Basis [g <sub>fw</sub> /m <sup>2</sup> •d]	Fresh Basis Water Content [%]
Cabbage	0.35	90	6.06 <sup>(2)</sup>	75.78	92	0.67	6.74	90
Carrot	0.25	60	8.98 <sup>(2)</sup>	74.83	88	5.99	59.87	90
Chard	0.45 <sup>(1)</sup>	65 <sup>(1)</sup>	7.00 <sup>(1)</sup>	87.50	92	3.77	37.69	90
Celery	0.25	90	10.33 <sup>(2)</sup>	103.27	90	1.15	11.47	90
Dry Bean	0.50 <sup>(1)</sup>	40 <sup>(1)</sup>	10.00 <sup>(3)</sup>	11.11	10	15.00	150.00	90
Green Onion	0.25	90	9.00 <sup>(3)</sup>	81.82	89	1.00	10.00	90
Lettuce	0.25 <sup>(1)</sup>	90 <sup>(1)</sup>	6.57 <sup>(1)</sup>	131.35	95	0.73	7.30	90
Mushroom		90			90			90
Onion	0.25	80	9.00	81.82	89	2.25	22.50	90
Pea	0.50	40	10.73 <sup>(2)</sup>	12.20	12	16.10	161.00	90
Peanut	0.65 <sup>(1)</sup>	25 <sup>(1)</sup>	5.63 <sup>(1)</sup>	5.96	5.6	16.88	168.75	90
Pepper	0.40	45	10.43 <sup>(3)</sup>	148.94	93	12.74	127.43	90
Radish	0.20 <sup>(1)</sup>	50 <sup>(1)</sup>	5.50 <sup>(3)</sup>	91.67	94 <sup>(3)</sup>	5.50	55.00	90
Red Beet	0.45 <sup>(1)</sup>	65 <sup>(1)</sup>	6.50	32.50	80	3.50	35.00	90
Rice	0.80 <sup>(1)</sup>	30 <sup>(1)</sup>	9.07 <sup>(1)</sup>	10.30	12	21.16	211.58	90
Snap Bean	0.50	40	11.88 <sup>(2)</sup>	148.50	92 <sup>(3)</sup>	17.82	178.20	90
Soybean	0.55 <sup>(1)</sup>	40 <sup>(1)</sup>	6.00 <sup>(1)</sup>	6.60	10	6.80	68.04	90
Spinach	0.25 <sup>(1)</sup>	90 <sup>(1)</sup>	6.57 <sup>(3)</sup>	72.97	91	0.73	7.30	90
Strawberry	0.25 <sup>(1)</sup>	35 <sup>(1)</sup>	7.79 <sup>(2)</sup>	77.88	90	14.46	144.46	90
Sweet Potato	0.65 <sup>(1)</sup>	40 <sup>(1)</sup>	15.00 <sup>(3)</sup>	51.72	71	22.50	225.00	90
Tomato	0.40 <sup>(1)</sup>	45 <sup>(1)</sup>	10.43 <sup>(1)</sup>	173.76	94	12.74	127.43	90
Wheat	0.50 <sup>(1)</sup>	40 <sup>(1)</sup>	20.00 <sup>(3)</sup>	22.73	12	30.00	300.00	90
White Potato	0.65 <sup>(1)</sup>	70 <sup>(1)</sup>	21.06 <sup>(1)</sup>	105.30	80	9.03	90.25	90

**References**

Information from Drysdale 2001 except as noted.  
<sup>(1)</sup>Wheeler, *et al.* (2003)  
<sup>(2)</sup>Ball, *et al.* (2001) and EDIS (2001)  
<sup>(3)</sup> personal communication with R. Wheeler in 2001

<sup>194</sup> Productivities could increase for most species by ~10% to 15% by use of transplanting schemes for more efficient spacing according to Wheeler, *et al.* (2006).

**Table 4.99 Nominal and Highest Biomass Production, Composition, and Metabolic Products** <sup>195</sup>

Crop	Total Biomass (Edible + Inedible), Dry Basis [g <sub>dw</sub> /m <sup>2</sup> •d]		Carbon Content [%]	Metabolic Reactants and Products		
	nominal	high		Oxygen (O <sub>2</sub> ) Production [g/m <sup>2</sup> •d]	Carbon Dioxide (CO <sub>2</sub> ) Uptake [g/m <sup>2</sup> •d]	Water (H <sub>2</sub> O) Uptake / Transpiration [kg/m <sup>2</sup> •d]
Cabbage	6.74	10.0	40	7.19	9.88	1.77
Carrot	14.97	16.7	41	16.36	22.50	1.77
Chard	10.77		40	11.49	15.79	1.77
Celery	11.47		40	12.24	16.83	1.24
Dry Bean	25.00		40	30.67	42.17	2.53
Green Onion	10.00		40	10.67	14.67	1.74
Lettuce	7.30	7.9	40 <sup>(1)</sup>	7.78	10.70	1.77
Mushroom						
Onion	11.25		40	12.00	16.50	1.74
Pea	26.83		40 <sup>(3)</sup>	32.92	45.26	2.46
Peanut	22.50	36.0	60 <sup>(2)</sup>	35.84	49.28	2.77
Pepper	23.17		40	24.71	33.98	2.77
Radish	11.00		40 <sup>(2)</sup>	11.86	16.31	1.77
Red Beet	10.00		41	7.11	9.77	1.77
Rice	30.23	39.0	42	36.55	50.26	3.43
Snap Bean	29.70		40	36.43	50.09	2.46
Soybean	11.34	20.0	46 <sup>(1)</sup>	13.91	19.13	2.88
Spinach	7.30		40	7.78	10.70	1.77
Strawberry	22.25		43 <sup>(2)</sup>	25.32	34.82	2.22
Sweet Potato	37.50	51.3	41 <sup>(2)</sup>	41.12	56.54	2.88
Tomato	23.17	37.8	43 <sup>(2)</sup>	26.36	36.24	2.77
Wheat	50.00	150.0	42 <sup>(1)</sup>	56.00	77.00	11.79
White Potato	30.08	50.0	41 <sup>(1)</sup>	32.23	45.23	2.88

**References**

Information from Drysdale 2001 except as noted.  
<sup>(1)</sup> Wheeler, *et al.* (1995)  
<sup>(2)</sup> Calculated  
<sup>(3)</sup> Personal communication with S. Orcun and R. Wheeler in 2003

<sup>195</sup> Productivities could increase for most species by ~10% to 15% by use of transplanting schemes for more efficient spacing according to Wheeler, *et al.* (2006).

**Table 4.100 Inedible Biomass Generation for Exploration Life Support Diets Based on Fresh Weight**

Crop	ELS Crop	Edible Biomass [g/m <sup>2</sup> •d]	Inedible Biomass [g/m <sup>2</sup> •d]	Diet Using Only ELS Salad Crops		Diet Using Salad and Carbohydrate Crops		Diet Using All ELS Crops	
				Diet Growing Area [m <sup>2</sup> /CM]	Total Inedible Biomass [kg/CM-d]	Diet Growing Area [m <sup>2</sup> /CM]	Total Inedible Biomass [kg/CM-d]	Diet Growing Area [m <sup>2</sup> /CM]	Total Inedible Biomass [kg/CM-d]
Cabbage	×	75.78	6.74	0.256	0.002	0.033	0.000	n/a	n/a
Carrot	×	74.83	59.87	0.488	0.029	0.535	0.032	0.536	0.032
Chard	×	87.50	37.69	n/a	n/a	n/a	n/a	n/a	n/a
Celery		103.27	11.47	n/a	n/a	0.073	0.001	n/a	n/a
Dry Bean	×	11.11	150.00	n/a	n/a	1.170	0.176	1.926	0.289
Green Onion		81.82	10.00	0.055	0.001	0.416	0.004	0.276	0.003
Lettuce	×	131.35	7.30	0.119	0.001	0.160	0.001	0.057	0.000
Mushroom				n/a	n/a	TBD	0.0013	n/a	n/a
Onion	×	81.82	22.50	n/a	n/a	n/a	n/a	n/a	n/a
Pea		12.20	161.00	n/a	n/a	0.311	0.050	n/a	n/a
Peanut	×	5.96	168.75	n/a	n/a	n/a	n/a	4.832	0.815
Pepper		148.94	127.43	n/a	n/a	0.208	0.027	n/a	n/a
Radish	×	91.67	55.00	0.098	0.005	n/a	n/a	0.164	0.008
Red Beet		32.50	35.00	n/a	n/a	n/a	n/a	n/a	n/a
Rice	×	10.30	211.58	n/a	n/a	n/a	n/a	2.078	0.440
Snap Bean		148.50	178.20	n/a	n/a	0.067	0.012	n/a	n/a
Soybean	×	5.04	68.04	n/a	n/a	n/a	n/a	46.429	3.159
Spinach	×	72.97	7.30	0.066	0.000	0.548	0.004	0.635	0.005
Strawberry		77.88	144.46	n/a	n/a	n/a	n/a	n/a	n/a
Sweet Potato	×	51.72	225.00	n/a	n/a	3.480	0.783	1.485	0.334
Tomato	×	173.76	127.43	0.265	0.034	1.209	0.154	1.642	0.209
Wheat	×	22.73	300.00	n/a	n/a	9.679	2.904	4.237	1.271
White Potato	×	105.30	90.25	n/a	n/a	1.614	0.146	0.994	0.090
<b>Total</b>				<b>1.35</b>	<b>0.07</b>	<b>19.50</b>	<b>4.29</b>	<b>65.29</b>	<b>6.66</b>

Plant environmental demands differ compared to the crew's requirements. For example, the optimum partial pressure of carbon dioxide for plant growth is roughly 0.10 to 0.20 kPa (Wheeler, *et al.*, 1993); below this, productivities decrease. Sensitivity may vary from species to species, but plants do appear to have reduced productivity at very high partial pressures of carbon dioxide that are considered within the normal range for crew (up to about 1.0 kPa). Similarly, plants require higher relative humidity – about 75% – to avoid water stress and minimize nutrient solution usage. Such humidity levels are at the high end for crew comfort. Further, some key plants, such as wheat and potatoes, are most productive at temperatures below the standard crew comfort zone. Finally, at nominal Earth ambient carbon dioxide partial pressures ( $p[\text{CO}_2] = 0.04 \text{ kPa}$ ), plants grow better under atmospheres with reduced partial pressures of oxygen ( $p[\text{O}_2]$  less than 21 kPa). If the partial pressure of carbon dioxide is elevated to 0.1 to 0.2 kPa, the benefits of reduced oxygen partial pressure are negligible. However, because human beings live with plants on Earth, plants and crew can live in a common atmosphere.

Table 4.100 Inedible Biomass Generation for Exploration Life Support Diets Based on Fresh Weight enumerates growing areas and fresh weight inedible biomass production associated with the ELS Project diets presented in Section 4.5.7. The edible biomass values are the nominal values listed above in Table 4.100. The total inedible biomass production is based on the edible biomass production and the harvest index, and does not include any waste associated with uneaten portions or the material removed during food preparation.

#### 4.14.1.4.2 TIME-AVERAGED VALUES TO SUPPORT PLANT GROWTH

Table 4.101 presents some details about plant growth with current hydroponic technology, providing water and nutrient use necessary to keep the plants healthy. Luxuriant nutrient levels were provided, so lower levels of nutrients might also suffice. The nutrient solution shown was formulated to require only acid addition for pH control. However, alternative formulations might require less active pH control (and thus fewer consumables to maintain the pH). Finally, plant productivity varies from one cropping cycle to the next even under controlled conditions, so the values here should be viewed as typical. Actual productivity from any real cropping cycle might vary.

**Table 4.101 Plant Growth and Support Requirements per Dry Biomass**

	Units	Soybean	Wheat	Potato	Lettuce	Reference
Water Usage per Dry Biomass	L/g <sub>dw</sub>	0.32	0.13	0.15	0.34	From Wheeler, <i>et al.</i> (1999).
Stock Usage per Dry Biomass	L/g <sub>dw</sub>	0.026	0.021	0.022	0.034	
Acid Usage per Dry Biomass <sup>196</sup>	g <sub>acid</sub> /g <sub>dw</sub>	0.0548	0.0744	0.0428	0.0618	

Table 4.102 and Table 4.103 describe the major ionic components of the nutrient solutions used for studies within the Biomass Production Chamber at Kennedy Space Center as determined from Wheeler, *et al.* (1996) and Wheeler, *et al.* (1997). As indicated, the initial stock solution, which is at the desired concentration to support plant growth, is more dilute than the mixture of two replenishment solutions that are added incrementally, as necessary, to replace nutrient used by plants or otherwise lost. For this facility, replenishment solution is added in a fixed concentration as a function of electrical conductivity regardless of which ions are depleted. Each salt primarily contributes one important element, as noted. The elemental concentrations, then, are with respect to the listed important element. Note that because pH is controlled by adding nitric acid (HNO<sub>3</sub>), the nitrogen content of the acid must be considered in calculating the total nitrogen provided to the plants. In addition, minerals might be lost to the plants through uptake by microorganisms and by precipitation from solution. Some nitrogen may leave nutrient solution via volatilization as nitrogen gas or as nitrogen oxides as a result of microbial metabolism. Finally, to inhibit ionic build-up within the nutrient solution due to the procedures outlined here, especially sodium or boron, the nutrient solution is often replaced at regular intervals.

<sup>196</sup> For nitrate-based formulations. Acid is provided as 0.4 M HNO<sub>3</sub>. One mole of nitric acid (HNO<sub>3</sub>) contains 63.013 grams of solute.

**Table 4.102 Composition of Initial Nutrient Solution**

								Content		Reference
Initial Ionic Component		Important Element	Elemental Atomic Weight	Concentration [meq/L] <sup>197</sup>	Ion Molecular Weight	Valence	g/L (element)	g/L (ion)		
Nitrate,	NO <sub>3</sub> <sup>-</sup>	Nitrogen,	N	14.01	7.5	62.00	-1	0.1051	0.465	Wheeler, <i>et al.</i> (1996)
Phosphate,	PO <sub>4</sub> <sup>3-</sup>	Phosphorous,	P	30.97	0.5	94.97	-3	0.0465	0.142	
Potassium,	K <sup>+</sup>	Potassium,	K	39.10	3	39.10	+1	0.1173	0.117	
Calcium,	Ca <sup>2+</sup>	Calcium,	Ca	40.08	2.5	40.08	+2	0.2004	0.200	
Magnesium,	Mg <sup>2+</sup>	Magnesium,	Mg	24.31	1	24.31	+2	0.0486	0.049	
Sulfate,	SO <sub>4</sub> <sup>2-</sup>	Sulfur,	S	32.06	1	96.06	-2	0.0641	0.192	
<b>Total</b>									<b>1.166</b>	

**Table 4.103 Composition of Replenishment Nutrient Solution**

								Content		Reference
Replenishment Ionic Component		Important Element	Elemental Atomic Weight	Concentration [meq/L] <sup>197</sup>	Ion Molecular Weight	Valence	g/L (element)	g/L (ion)		
Nitrate,	NO <sub>3</sub> <sup>-</sup>	Nitrogen,	N	14.01	75	62.00	-1	1.051	4.650	Wheeler, <i>et al.</i> (1997)
Phosphate,	PO <sub>4</sub> <sup>3-</sup>	Phosphorous,	P	30.97	7.5	94.97	-3	0.697	2.137	
Potassium,	K <sup>+</sup>	Potassium,	K	39.10	68	39.10	+1	2.659	2.659	
Calcium,	Ca <sup>2+</sup>	Calcium,	Ca	40.08	7.5	40.08	+2	0.601	0.601	
Magnesium,	Mg <sup>2+</sup>	Magnesium,	Mg	24.31	9.8	24.31	+2	0.476	0.476	
Sulfate,	SO <sub>4</sub> <sup>2-</sup>	Sulfur,	S	32.06	9.8	96.06	-2	0.628	1.883	
<b>Total</b>									<b>12.406</b>	

<sup>197</sup> Here the units, [meq/L], denote milli-equivalent weights of the ionic component per liter of solution. An equivalent weight is the ion's molecular weight divided by the absolute value of the ion's valence.



#### 4.14.1.5 MODIFIED ENERGY CASCADE MODELS FOR CROP GROWTH

Cavazzoni (2001) presents a package of models appropriate for use in system-level modeling. These Modified Energy Cascade (MEC) models build upon the earlier work of Volk, *et al.* (1995) and benefit from studies by Monje (1998), Monje and (received from a personal communication from B. Bugbee, 1998), and Jones and Cavazzoni (2000).<sup>198</sup>

The MEC models calculate biomass production, on a dry-mass basis, as a function of photosynthetic photo flux, PPF, and the atmospheric carbon dioxide concentration [CO<sub>2</sub>].<sup>199</sup> The atmospheric temperatures, one for light periods and a second for dark periods, and the photoperiod are constant and the plant growth is not limited by water or nutrients. These models accommodate daily variations in PPF and [CO<sub>2</sub>], but weighted values of PPF and [CO<sub>2</sub>] should be used to estimate time for canopy closure, t<sub>A</sub>. The models generally apply over a range of PPF from 200 to 1,000 μmol/m<sup>2</sup>•s<sup>200</sup> and a range of [CO<sub>2</sub>] from 330 to 1,300 μmol/mol. For rice and wheat, these models apply up to 2,000 μmol/m<sup>2</sup>•s. The PPF range for lettuce is limited to 200 to 500 μmol/m<sup>2</sup>•s, because a light integral of only 17 mol/m<sup>2</sup>•d is recommended to prevent leaf tip burn. See, for example, Hopper, *et al.* (1997), for recommended PPF requirements for crop growth.

#### 4.14.1.6 MODIFIED ENERGY CASCADE MODELS FOR CROP BIOMASS PRODUCTION

The following material outlines the top-level MEC models developed by Cavazzoni (2001) in detail. The various parameters depend upon the crop cultivar and growing conditions. Parameters for nominal conditions of lighting, temperature, and atmospheric composition are presented in Section 4.14.1.7.1.

The fraction of PPF absorbed by the plant canopy, A, is a function of time, t, in terms of days after emergence [d<sub>AE</sub>], and the time for canopy closure, t<sub>A</sub> [d<sub>AE</sub>] by the following relationship:

$$\begin{aligned}
 A &= A_{\text{MAX}} \left( \frac{t}{t_A} \right)^n && \text{for } t < t_A \\
 A &= A_{\text{MAX}} && \text{for } t \geq t_A
 \end{aligned}
 \tag{Equation 4.15}$$

where A<sub>MAX</sub> is 0.93 and n is enumerated for various crops in Table 4.104 below. The parameter, t<sub>A</sub>, is computed as a function of PPF and [CO<sub>2</sub>] for each crop. This function is presented below with appropriate coefficients.

**Table 4.104 Values for the Exponent n in MEC Models**

Crop	n
Wheat	1.0
Rice, Soybean, Sweet Potato	1.5
Dry Bean, Peanut, White Potato	2.0
Lettuce, Tomato	2.5

<sup>198</sup> Jones and Cavazzoni present the Top-Level Energy Cascade models. Though the Modified Energy Cascade equations and the Top-Level Energy Cascade equations share some ideas, the Top-Level Energy Cascade equations provide models for quantities that are input parameters for the Modified Energy Cascade equations. Further, the Modified Energy Cascade equations include models to compute biomass oxygen generation.

<sup>199</sup> Other environmental and physiological factors may also vary. See Cavazzoni (2001) for complete details on this model.

<sup>200</sup> PPF is commonly expressed in units of either μmol/(m<sup>2</sup>•s), as listed here, or mol/(m<sup>2</sup>•d). The units for PPF are related by the expression:

$$\text{PPF } [\mu\text{mol}/(\text{m}^2\cdot\text{s})] = \text{PPF } [\text{mol}/(\text{m}^2\cdot\text{d})] \times 1/\text{H} \times (1 \text{ h}/3600 \text{ s}) \times (10^6 \mu\text{mol}/1 \text{ mol})$$

where H is photoperiod [h/d]. See Table 4.118 for nominal values of H, which are designated H<sub>0</sub>. Because units for PPF depend upon the duration during which crops receive photosynthetic irradiation, the conversion to a “per day” basis depends on the diurnal photoperiod per day.

The canopy quantum yield, CQY, [ $\mu\text{mol}_{\text{Carbon Fixed}}/\mu\text{mol}_{\text{Absorbed PPF}}$ ] is defined by:

$$\begin{aligned} \text{CQY} &= \text{CQY}_{\text{MAX}} && \text{for } t \leq t_Q \\ \text{CQY} &= \text{CQY}_{\text{MAX}} - (\text{CQY}_{\text{MAX}} - \text{CQY}_{\text{MIN}}) \frac{(t - t_Q)}{(t_M - t_Q)} \frac{(t - t_Q)}{(t_M - t_Q)} && \text{for } t_Q < t \leq t_M \end{aligned} \quad \text{Equation 4.16}$$

where  $t_M$  is time at crop harvest or maturity [ $d_{\text{AE}}$ ], and  $t_Q$  is the time at onset of canopy senescence [ $d_{\text{AE}}$ ].  $t_M$  and  $t_Q$  are model constants.  $\text{CQY}_{\text{MAX}}$  is a crop-specific function of PPF and  $[\text{CO}_2]$ , as noted below, while  $\text{CQY}_{\text{MIN}}$  is a crop-specific constant.

The 24-hour carbon use efficiency,  $\text{CUE}_{24}$ , a fraction, is constant for most crops. In such cases, a single value is listed under  $\text{CUE}_{\text{MAX}}$  in the tables below. For legumes,  $\text{CUE}_{24}$  is described by:

$$\begin{aligned} \text{CUE}_{24} &= \text{CUE}_{\text{MAX}} && \text{for } t \leq t_Q \\ \text{CUE}_{24} &= \text{CUE}_{\text{MAX}} - (\text{CUE}_{\text{MAX}} - \text{CUE}_{\text{MIN}}) \frac{(t - t_Q)}{(t_M - t_Q)} \frac{(t - t_Q)}{(t_M - t_Q)} && \text{for } t_Q < t \leq t_M \end{aligned} \quad \text{Equation 4.17}$$

where  $\text{CUE}_{\text{MAX}}$  and  $\text{CUE}_{\text{MIN}}$  are model inputs unique to each crop.

The daily carbon gain, DCG, [ $\text{mol}_{\text{Carbon}}/\text{m}^2 \cdot \text{d}$ ] is computed from:

$$\text{DCG} = 0.0036 \frac{\text{s}}{\text{h}} \frac{\text{mol}}{\mu\text{mol}} \frac{\text{s}}{\text{h}} \frac{\text{mol}}{\mu\text{mol}} \times H \times \text{CUE}_{24} \times A \times \text{CQY} \times \text{PPF} \quad \text{Equation 4.18}$$

where  $H$  is the photoperiod [ $\text{h}/\text{d}$ ], a crop-specific model input. Photoperiod may vary daily, but see Cavazzoni (2001) for the assumptions involved.

The daily oxygen production, DOP, [ $\text{mol}_{\text{O}_2} \text{mol}_{\text{O}_2}/\text{m}^2 \cdot \text{d}$ ] may be computed using:

$$\text{DOP} = \text{OPF} \times \text{DCG} \quad \text{Equation 4.19}$$

where OPF is the oxygen production fraction [ $\text{mol}_{\text{O}_2} \text{mol}_{\text{O}_2}/\text{mol}_{\text{Carbon}}$ ], which is a crop specific parameter.

The crop growth rate, CGR [ $\text{g}/\text{m}^2 \cdot \text{d}$ ], is related to DCG by:

$$\text{CGR} = \text{MW}_C \frac{\text{DCG}}{\text{BCF}} \frac{\text{DCG}}{\text{BCF}} \quad \text{Equation 4.20}$$

where  $\text{MW}_C$  is the molecular weight of carbon, 12.011  $\text{g}/\text{mol}$ , and BCF is the biomass carbon fraction, another crop-specific constant.

The total crop biomass (TCB), on a dry basis, TCB [ $\text{g}/\text{m}^2$ ], is determined by integrating CGR, from  $t = 0$  to the time of interest, such as harvest,  $t_M$ . Or:

$$\text{TCB} = \int_0^{t_M} \text{CGR} dt \quad \int_0^{t_M} \text{CGR} dt \quad \text{Equation 4.21}$$

Total edible biomass (TEB), on a dry basis, TEB [ $\text{g}/\text{m}^2$ ], may be estimated by integrating the product of CGR and the fraction of daily carbon gain allocated to edible biomass, XFRT, from time storage organs begin to form,  $t_E$  [ $d_{\text{AE}}$ ]. Both XFRT and  $t_E$  are tabulated below. Thus:

$$\text{TEB} = \text{XFRT} \int_{t_E}^{t_M} \text{CGR} dt \quad \text{XFRT} \int_{t_E}^{t_M} \text{CGR} dt \quad \text{Equation 4.22}$$

Inedible biomass is the difference between TCB and TEB.

**Table 4.105 Summary of Modified Energy Cascade Model Variables for Biomass Production**

Variable	Units	Description	Reference/Value
A	--	fraction of PPF absorbed by the plant canopy	Equation 4.15
A <sub>MAX</sub>	--	maximum value for A	0.93
BCF	--	biomass carbon fraction	Table 4.120
CGR	g/m <sup>2</sup> •d	crop growth rate	Equation 4.20
C <sub>i</sub>	varies	coefficients in functions describing t <sub>A</sub> and CQY <sub>MAX</sub>	Table 4.107
[CO <sub>2</sub> ]	$\frac{\mu\text{mol}_{\text{CO}_2}}{\text{mol}_{\text{Air}}}$	atmospheric concentration of carbon dioxide; model variable	none
CQY	$\frac{\mu\text{mol}_{\text{C, Fixed}}}{\mu\text{mol}_{\text{Ab, PPF}}}$	canopy quantum yield	Equation 4.16
CQY <sub>MAX</sub>	$\frac{\mu\text{mol}_{\text{C, Fixed}}}{\mu\text{mol}_{\text{Ab, PPF}}}$	maximum value for CQY that applies until t <sub>Q</sub>	Equation 4.23
CQY <sub>MIN</sub>	$\frac{\mu\text{mol}_{\text{C, Fixed}}}{\mu\text{mol}_{\text{Ab, PPF}}}$	minimum value for CQY at t <sub>M</sub>	Table 4.106
CUE <sub>24</sub>	--	24-hour carbon use efficiency; a fraction	Equation 4.17
CUE <sub>MAX</sub>	--	maximum value for CUE <sub>24</sub> that applies until t <sub>Q</sub>	Table 4.106
CUE <sub>MIN</sub>	--	minimum value for CUE <sub>24</sub> at t <sub>M</sub>	Table 4.106
DCG	mol <sub>Carbon</sub> /m <sup>2</sup> •d	daily carbon gain	Equation 4.18
DOP	$\frac{\text{mol}_{\text{O}_2}}{\text{m}^2 \cdot \text{d}}$	daily oxygen production	Equation 4.19
H	h/d	Photoperiod	Table 4.118
MW <sub>C</sub>	g/mol	molecular weight of carbon	12.011
n	--	an exponent	Table 4.104
OPF	$\frac{\text{mol}_{\text{O}_2}}{\text{mol}_{\text{Carbon}}}$	oxygen production fraction	Table 4.120
PPF	$\frac{\mu\text{mol}_{\text{Photon}}}{\text{m}^2 \cdot \text{s}}$	photosynthetic photon flux; model variable	none
TCB	g/m <sup>2</sup>	total crop biomass, on a dry basis	Equation 4.21
TEB	g/m <sup>2</sup>	total edible biomass, on a dry basis	Equation 4.22

t	d <sub>AE</sub>	time; model variable	none
t <sub>A</sub>	d <sub>AE</sub>	time until canopy closure	Equation 4.31
t <sub>E</sub>	d <sub>AE</sub>	time at onset of organ formation	Table 4.119
t <sub>M</sub>	d <sub>AE</sub>	time at harvest or crop maturity	Table 4.119
t <sub>Q</sub>	d <sub>AE</sub>	time until onset of canopy senescence	Table 4.119
XFRT	--	fraction of daily carbon gain allocated to edible biomass after t <sub>E</sub>	Table 4.119

The environmentally dependent parameters for these models are provided in the sections below. The MEC variables for biomass production models are summarized in Table 4.105

Summary of Modified Energy Cascade Model Variables for Biomass Production General model constants, which depend only on the crop cultivar and not on environmental conditions, are listed in Table 4.106.

**Table 4.106 Biomass Production Model Constants**<sup>201</sup>

Crop	Specific Cultivar	CQY <sub>MIN</sub> [ $\mu\text{mol}_C$ Fixed / $\mu\text{mol}_{Ab}$ . PPF]	CUE <sub>MAX</sub>	CUE <sub>MIN</sub>
Dry Bean	<i>Meso Amer. Hab. 1 – Determinate</i>	0.02	0.65	0.50 <sup>202</sup>
Lettuce	<i>Waldmann's Green</i>	n/a	0.625	n/a
Peanut	<i>Pronto</i>	0.02	0.65	0.30
Rice	<i>Early maturing types</i>	0.01	0.64	n/a
Soybean	<i>Hoyt</i>	0.02	0.65	0.30
Sweet Potato	<i>TU-82-155 (Tuskegee University)</i>	n/a	0.625	n/a
Tomato	<i>Reinmann Philippe 75/59</i>	0.01	0.65	n/a
Wheat	<i>Veery 10</i>	0.01	0.64	n/a
White Potato	<i>Norland or Denali</i>	0.02	0.625	n/a

Based on multivariable polynomial regression, the functions for maximum canopy quantum yield, CQY<sub>MAX</sub> [ $\mu\text{mol}_C$  Carbon Fixed/ $\mu\text{mol}$  Absorbed PPF], have the general form:

$$\begin{aligned}
\text{CQY}_{\text{MAX}}(\text{PPF}, [\text{CO}_2]) = & C_1 \frac{1}{\text{PPF}} \frac{1}{[\text{CO}_2]} \frac{1}{\text{PPF}} \frac{1}{[\text{CO}_2]} + C_2 \frac{1}{\text{PPF}} \frac{1}{\text{PPF}} + C_3 \frac{[\text{CO}_2]}{\text{PPF}} \frac{[\text{CO}_2]}{\text{PPF}} \\
& + C_4 \frac{[\text{CO}_2]^2}{\text{PPF}} \frac{[\text{CO}_2]^2}{\text{PPF}} + C_5 \frac{[\text{CO}_2]^3}{\text{PPF}} \frac{[\text{CO}_2]^3}{\text{PPF}} + C_6 \frac{1}{[\text{CO}_2]} \frac{1}{[\text{CO}_2]} + \text{Constant} + C_8 [\text{CO}_2] \\
& + C_9 [\text{CO}_2]^2 + C_{10} [\text{CO}_2]^3 + C_{11} \frac{\text{PPF}}{[\text{CO}_2]} \frac{\text{PPF}}{[\text{CO}_2]} + C_{12} \text{PPF} + C_{13} \text{PPF} [\text{CO}_2] + C_{14} \text{PPF} [\text{CO}_2]^2 \\
& + C_{15} \text{PPF} [\text{CO}_2]^3 + C_{16} \frac{\text{PPF}^2}{[\text{CO}_2]} \frac{\text{PPF}^2}{[\text{CO}_2]} + C_{17} \text{PPF}^2 + C_{18} \text{PPF}^2 [\text{CO}_2] + C_{19} \text{PPF}^2 [\text{CO}_2]^2 \\
& + C_{20} \text{PPF}^2 [\text{CO}_2]^3 + C_{21} \frac{\text{PPF}^3}{[\text{CO}_2]} \frac{\text{PPF}^3}{[\text{CO}_2]} + C_{22} \text{PPF}^3 + C_{23} \text{PPF}^3 [\text{CO}_2] + C_{24} \text{PPF}^3 [\text{CO}_2]^2 \\
& + C_{25} \text{PPF}^3 [\text{CO}_2]^3
\end{aligned}$$

Equation 4.23

<sup>201</sup> The parameters in this table apply independent of temperature regime, photoperiod, or planting density.

<sup>202</sup> This suggested value is based on Wheeler (2001a) whereby growth costs are less for dry bean than for soybean and peanut.

where  $C_1$  through  $C_{25}$  again denote coefficients. PPF is designated in  $[\mu\text{mol}/\text{m}^2\cdot\text{s}]$ , while  $[\text{CO}_2]$  is measured in  $\left[\frac{\mu\text{mol}_{\text{CO}_2}}{\text{mol}_{\text{Air}}}\right] \cdot \left[\frac{\mu\text{mol}_{\text{CO}_2}}{\text{mol}_{\text{Air}}}\right]$ . To simplify the presentation of these functions, Table 4.108 through Table 4.116 present the coefficient values for each crop in a matrix of the form presented in Table 4.107

**Table 4.107 Format for Tables of Coefficients for Equations Employing Multivariable Polynomial Regression Fits**

	1/PPF	1	PPF	PPF <sup>2</sup>	PPF <sup>3</sup>
1/[CO <sub>2</sub> ]	1/PPF × 1/[CO <sub>2</sub> ] or C <sub>1</sub>	1/[CO <sub>2</sub> ] or C <sub>6</sub>	PPF/[CO <sub>2</sub> ] or C <sub>11</sub>	PPF <sup>2</sup> /[CO <sub>2</sub> ] or C <sub>16</sub>	PPF <sup>3</sup> /[CO <sub>2</sub> ] or C <sub>21</sub>
1	1/PPF or C <sub>2</sub>	Constant Term	PPF or C <sub>12</sub>	PPF <sup>2</sup> or C <sub>17</sub>	PPF <sup>3</sup> or C <sub>22</sub>
[CO <sub>2</sub> ]	[CO <sub>2</sub> ]/PPF or C <sub>3</sub>	[CO <sub>2</sub> ] or C <sub>8</sub>	PPF [CO <sub>2</sub> ] or C <sub>13</sub>	PPF <sup>2</sup> [CO <sub>2</sub> ] or C <sub>18</sub>	PPF <sup>3</sup> [CO <sub>2</sub> ] or C <sub>23</sub>
[CO <sub>2</sub> ] <sup>2</sup>	[CO <sub>2</sub> ] <sup>2</sup> /PPF or C <sub>4</sub>	[CO <sub>2</sub> ] <sup>2</sup> or C <sub>9</sub>	PPF [CO <sub>2</sub> ] <sup>2</sup> or C <sub>14</sub>	PPF <sup>2</sup> [CO <sub>2</sub> ] <sup>2</sup> or C <sub>19</sub>	PPF <sup>3</sup> [CO <sub>2</sub> ] <sup>2</sup> or C <sub>24</sub>
[CO <sub>2</sub> ] <sup>3</sup>	[CO <sub>2</sub> ] <sup>3</sup> /PPF or C <sub>5</sub>	[CO <sub>2</sub> ] <sup>3</sup> or C <sub>10</sub>	PPF [CO <sub>2</sub> ] <sup>3</sup> or C <sub>15</sub>	PPF <sup>2</sup> [CO <sub>2</sub> ] <sup>3</sup> or C <sub>20</sub>	PPF <sup>3</sup> [CO <sub>2</sub> ] <sup>3</sup> or C <sub>25</sub>

The coefficients for  $\text{CQY}_{\text{MAX}}$  are independent of photoperiod and planting density, and are only a weak function of temperature regime. Thus, for life support crop-growth scenarios, the  $\text{CQY}_{\text{MAX}}$  coefficients are essentially functions of the crop cultivar alone. See Cavazzoni (2001) for applicability under extreme temperature ranges.

**Table 4.108 Maximum Canopy Quantum Yield, CQY<sub>MAX</sub>, Coefficients for Dry Bean**

	1/PPF	1	PPF	PPF <sup>2</sup>	PPF <sup>3</sup>
1/[CO <sub>2</sub> ]	0	0	0	0	0
1	0	$4.191 \times 10^{-2}$	$-1.238 \times 10^{-5}$	0	0
[CO <sub>2</sub> ]	0	$5.3852 \times 10^{-5}$	0	$-1.544 \times 10^{-11}$	0
[CO <sub>2</sub> ] <sup>2</sup>	0	$-2.1275 \times 10^{-8}$	0	$6.469 \times 10^{-15}$	0
[CO <sub>2</sub> ] <sup>3</sup>	0	0	0	0	0

**Table 4.109 Maximum Canopy Quantum Yield, CQY<sub>MAX</sub>, Coefficients for Lettuce**

	1/PPF	1	PPF	PPF <sup>2</sup>	PPF <sup>3</sup>
1/[CO <sub>2</sub> ]	0	0	0	0	0
1	0	$4.4763 \times 10^{-2}$	$-1.1701 \times 10^{-5}$	0	0
[CO <sub>2</sub> ]	0	$5.163 \times 10^{-5}$	0	$-1.9731 \times 10^{-11}$	0
[CO <sub>2</sub> ] <sup>2</sup>	0	$-2.075 \times 10^{-8}$	0	$8.9265 \times 10^{-15}$	0
[CO <sub>2</sub> ] <sup>3</sup>	0	0	0	0	0

**Table 4.110 Maximum Canopy Quantum Yield, CQY<sub>MAX</sub>, Coefficients for Peanut**

	1/PPF	1	PPF	PPF <sup>2</sup>	PPF <sup>3</sup>
1/[CO <sub>2</sub> ]	0	0	0	0	0
1	0	$4.1513 \times 10^{-2}$	0	$-2.1582 \times 10^{-8}$	0
[CO <sub>2</sub> ]	0	$5.1157 \times 10^{-5}$	$4.0864 \times 10^{-8}$	$-1.0468 \times 10^{-10}$	$4.8541 \times 10^{-14}$
[CO <sub>2</sub> ] <sup>2</sup>	0	$-2.0992 \times 10^{-8}$	0	0	0
[CO <sub>2</sub> ] <sup>3</sup>	0	0	0	0	$3.9259 \times 10^{-21}$

**Table 4.111 Maximum Canopy Quantum Yield, CQY<sub>MAX</sub>, Coefficients for Rice**

	1/PPF	1	PPF	PPF <sup>2</sup>	PPF <sup>3</sup>
1/[CO <sub>2</sub> ]	0	0	0	0	0
1	0	$3.6186 \times 10^{-2}$	0	$-2.6712 \times 10^{-9}$	0
[CO <sub>2</sub> ]	0	$6.1457 \times 10^{-5}$	$-9.1477 \times 10^{-9}$	0	0
[CO <sub>2</sub> ] <sup>2</sup>	0	$-2.4322 \times 10^{-8}$	$3.889 \times 10^{-12}$	0	0
[CO <sub>2</sub> ] <sup>3</sup>	0	0	0	0	0

**Table 4.112 Maximum Canopy Quantum Yield, CQY<sub>MAX</sub>, Coefficients for Soybean**

	1/PPF	1	PPF	PPF <sup>2</sup>	PPF <sup>3</sup>
1/[CO <sub>2</sub> ]	0	0	0	0	0
1	0	$4.1513 \times 10^{-2}$	0	$-2.1582 \times 10^{-8}$	0
[CO <sub>2</sub> ]	0	$5.1157 \times 10^{-5}$	$4.0864 \times 10^{-8}$	$-1.0468 \times 10^{-10}$	$4.8541 \times 10^{-14}$
[CO <sub>2</sub> ] <sup>2</sup>	0	$-2.0992 \times 10^{-8}$	0	0	0
[CO <sub>2</sub> ] <sup>3</sup>	0	0	0	0	$3.9259 \times 10^{-21}$

*Note: The function for soybean here is identical to the function for peanut.*

**Table 4.113 Maximum Canopy Quantum Yield, CQY<sub>MAX</sub>, Coefficients for Sweet Potato**

	1/PPF	1	PPF	PPF <sup>2</sup>	PPF <sup>3</sup>
1/[CO <sub>2</sub> ]	0	0	0	0	0
1	0	$3.9317 \times 10^{-2}$	$-1.3836 \times 10^{-5}$	0	0
[CO <sub>2</sub> ]	0	$5.6741 \times 10^{-5}$	$-6.3397 \times 10^{-9}$	$-1.3464 \times 10^{-11}$	0
[CO <sub>2</sub> ] <sup>2</sup>	0	$-2.1797 \times 10^{-8}$	0	$7.7362 \times 10^{-15}$	0
[CO <sub>2</sub> ] <sup>3</sup>	0	0	0	0	0

**Table 4.114 Maximum Canopy Quantum Yield, CQY<sub>MAX</sub>, Coefficients for Tomato**

	1/PPF	1	PPF	PPF <sup>2</sup>	PPF <sup>3</sup>
1/[CO <sub>2</sub> ]	0	0	0	0	0
1	0	$4.0061 \times 10^{-2}$	0	$-7.1241 \times 10^{-9}$	0
[CO <sub>2</sub> ]	0	$5.688 \times 10^{-5}$	$-1.182 \times 10^{-8}$	0	0
[CO <sub>2</sub> ] <sup>2</sup>	0	$-2.2598 \times 10^{-8}$	$5.0264 \times 10^{-12}$	0	0
[CO <sub>2</sub> ] <sup>3</sup>	0	0	0	0	0

**Table 4.115 Maximum Canopy Quantum Yield, CQY<sub>MAX</sub>, Coefficients for Wheat**

	1/PPF	1	PPF	PPF <sup>2</sup>	PPF <sup>3</sup>
1/[CO <sub>2</sub> ]	0	0	0	0	0
1	0	$4.4793 \times 10^{-2}$	$-5.1946 \times 10^{-6}$	0	0
[CO <sub>2</sub> ]	0	$5.1583 \times 10^{-5}$	0	$-4.9303 \times 10^{-12}$	0
[CO <sub>2</sub> ] <sup>2</sup>	0	$-2.0724 \times 10^{-8}$	0	$2.2255 \times 10^{-15}$	0
[CO <sub>2</sub> ] <sup>3</sup>	0	0	0	0	0

**Table 4.116 Maximum Canopy Quantum Yield, CQY<sub>MAX</sub>, Coefficients for White Potato**

	1/PPF	1	PPF	PPF <sup>2</sup>	PPF <sup>3</sup>
1/[CO <sub>2</sub> ]	0	0	0	0	0
1	0	4.6929 × 10 <sup>-2</sup>	0	0	-1.9602 × 10 <sup>-11</sup>
[CO <sub>2</sub> ]	0	5.0910 × 10 <sup>-5</sup>	0	-1.5272 × 10 <sup>-11</sup>	0
[CO <sub>2</sub> ] <sup>2</sup>	0	-2.1878 × 10 <sup>-8</sup>	0	0	0
[CO <sub>2</sub> ] <sup>3</sup>	0	0	4.3976 × 10 <sup>-15</sup>	0	0

4.14.1.7 MODIFIED ENERGY CASCADE MODELS FOR CROP TRANSPIRATION

Following the approach in Section 4.14.1.6 for biomass production, this section focuses on a similar model to predict crop canopy transpiration. In fact, the crop transpiration model employs many of the parameters computed by the algorithm above. The model in this section was adapted from Monje (1998).

The vapor pressure deficit, VPD [kPa], is the difference between the saturated vapor pressure for air at the mean atmospheric temperature, VP<sub>SAT</sub> [kPa], and the actual vapor pressure for the atmosphere, VP<sub>AIR</sub> [kPa]. Or:

$$\begin{aligned}
 VP_{SAT} &= 0.611 e^{\left[ \frac{17.4 T_{LIGHT}}{T_{LIGHT} + 239} \right]} e^{\left[ \frac{17.4 T_{LIGHT}}{T_{LIGHT} + 239} \right]} \\
 VP_{AIR} &= VP_{SAT} \times RH \\
 VPD &= VP_{SAT} - VP_{AIR}
 \end{aligned}
 \tag{Equation 4.24}$$

where T<sub>LIGHT</sub> [C] is the mean atmospheric temperature during the crop's light cycle and RH is the mean atmospheric relative humidity as a fraction bounded between 0 and 1, inclusive. Calculation of VP<sub>SAT</sub> assumes that the temperature of the canopy leaves, from which transpiration originates, is equal to the mean light-cycle air temperature, T<sub>LIGHT</sub>.

The gross canopy photosynthesis, P<sub>GROSS</sub> [μmol<sub>Carbon</sub>/m<sup>2</sup>•s], may be expressed in terms of previously defined values as:

$$P_{GROSS} = A \times CQY \times PPF
 \tag{Equation 4.25}$$

The net canopy photosynthesis, P<sub>NET</sub> [μmol<sub>Carbon</sub>/m<sup>2</sup>•s], may be expressed as:

$$P_{NET} = \left[ \frac{D_{PG} - H}{D_{PG}} + \frac{H \times CUE_{24}}{D_{PG}} \right] \left[ \frac{D_{PG} - H}{D_{PG}} + \frac{H \times CUE_{24}}{D_{PG}} \right] P_{GROSS}
 \tag{Equation 4.26}$$

where D<sub>PG</sub> [h/d] is the length of the plant growth chamber's diurnal cycle. During development of these models, Cavazzoni (2001) assumed a value of 24.0 h/d for D<sub>PG</sub>, which is consistent with ground-based data gathered to date.

**Table 4.117 Summary of Modified Energy Cascade Model Variables for Canopy Transpiration**

Variable	Units	Description	Reference/Value
A	--	fraction of PPF absorbed by the plant canopy	Equation 4.15
[CO <sub>2</sub> ]	$\frac{\mu\text{mol}_{\text{CO}_2}}{\text{mol}_{\text{Air}}}$	atmospheric concentration of carbon dioxide; model variable	none
CQY	$\frac{\mu\text{mol}_{\text{Carbon}}}{\mu\text{mol}_{\text{Photon}}}$	canopy quantum yield	Equation 4.16
CUE <sub>24</sub>	--	24-hour carbon use efficiency; a fraction	Equation 4.17
D <sub>PG</sub>	h/d	plant growth diurnal cycle	24 <sup>203</sup>
DTR	L <sub>Water</sub> /m <sup>2</sup> •d	daily canopy transpiration rate	Equation 4.30
g <sub>A</sub>	mol <sub>Water</sub> /m <sup>2</sup> •s	atmospheric aerodynamic conductance	Equation 4.28 and Equation 4.29
g <sub>C</sub>	mol <sub>Water</sub> /m <sup>2</sup> •s	canopy surface conductance	Equation 4.27
g <sub>S</sub>	mol <sub>Water</sub> /m <sup>2</sup> •s	canopy stomatal conductance	Equation 4.28 and Equation 4.29
H	h/d	photoperiod; model variable	none <sup>204</sup>
H <sub>O</sub>	h/d	nominal photoperiod	Table 4.118
MW <sub>W</sub>	g/mol	molecular weight of water	18.015
P <sub>ATM</sub>	kPa	total atmospheric pressure; model variable	none
P <sub>GROSS</sub>	$\frac{\mu\text{mol}_{\text{Carbon}}}{\text{m}^2 \cdot \text{s}}$	gross canopy photosynthesis	Equation 4.25
P <sub>NET</sub>	$\frac{\mu\text{mol}_{\text{Carbon}}}{\text{m}^2 \cdot \text{s}}$	net canopy photosynthesis	Equation 4.26
PPF	$\frac{\mu\text{mol}_{\text{Photon}}}{\text{m}^2 \cdot \text{s}}$	photosynthetic photon flux; model variable	none
PPF <sub>E</sub>	$\frac{\mu\text{mol}_{\text{Photon}}}{\text{m}^2 \cdot \text{s}}$	effective photosynthetic photon flux	Equation 4.32
RH	--	atmospheric relative humidity; model variable	none
T <sub>LIGHT</sub>	C	atmospheric temperature during crop's light cycle	Table 4.118
VP <sub>AIR</sub>	kPa	actual moisture vapor pressure	Equation 4.24
VP <sub>SAT</sub>	kPa	saturated moisture vapor pressure	Equation 4.24
VPD	kPa	vapor pressure deficit	Equation 4.24
ρ <sub>W</sub>	g/L	density of water	998.23

<sup>203</sup> This value applies to data used to date from terrestrial test facilities. More generally, it's the length of a local sol.

<sup>204</sup> For the nominal case, assume the photoperiod, H, equals the nominal photoperiod, H<sub>o</sub>, which is listed in Table 4.118.



The canopy surface conductance,  $g_C$  [ $\text{mol}_{\text{Water}}/\text{m}^2 \bullet \text{s}$ ], is based on the canopy stomatal conductance,  $g_S$  [ $\text{mol}_{\text{Water}}/\text{m}^2 \bullet \text{s}$ ], and the atmospheric aerodynamic conductance,  $g_A$  [ $\text{mol}_{\text{Water}}/\text{m}^2 \bullet \text{s}$ ].

$$g_C = \frac{g_A \times g_S}{g_A + g_S} \quad \text{Equation 4.27}$$

The following models for  $g_S$  and values for  $g_A$  were derived from the experimental conditions studied by Monje (1998).

With planophile-type canopies, such as for dry bean, lettuce, peanut, soybean, sweet potato, tomato, and white potato,  $g_S$  and  $g_A$  are computed as:

$$g_S = (1.717 T_{\text{LIGHT}} - 19.96 - 10.54 \text{ VPD}) \left( \frac{P_{\text{NET}}}{[\text{CO}_2]} \right)$$

$$(1.717 T_{\text{LIGHT}} - 19.96 - 10.54 \text{ VPD}) \left( \frac{P_{\text{NET}}}{[\text{CO}_2]} \right)$$

$$g_A = 2.5 \quad \text{Equation 4.28}$$

With erectophile canopies, such as for rice and wheat,  $g_S$  and  $g_A$  have the form:

$$g_S = 0.1389 + 15.32 \text{ RH} \left( \frac{P_{\text{NET}}}{[\text{CO}_2]} \right)$$

$$0.1389 + 15.32 \text{ RH} \left( \frac{P_{\text{NET}}}{[\text{CO}_2]} \right)$$

$$g_A = 5.5 \quad \text{Equation 4.29}$$

The daily canopy transpiration rate, DTR [ $\text{L}_{\text{Water}}/\text{m}^2 \bullet \text{d}$ ], is:

$$\text{DTR} = 3600 \frac{\text{S}}{\text{h}} \text{H} \left( \frac{\text{MW}_W}{\rho_W} \right) g_C \left( \frac{\text{VPD}}{P_{\text{ATM}}} \right) \frac{\text{S}}{\text{h}} \left( \frac{\text{MW}_W}{\rho_W} \right) \left( \frac{\text{VPD}}{P_{\text{ATM}}} \right) \quad \text{Equation 4.30}$$

where  $P_{\text{ATM}}$  [kPa] is the total atmospheric pressure,  $\text{MW}_W$  is the molecular weight of water, 18.015 g/mol, and  $\rho_W$  is the density of water, 998.23 g/L at 20 °C.

The parameters for the transpiration model are provided in the sections below and the variables are summarized in Table 4.117.

#### 4.14.1.7.1 MODIFIED ENERGY CASCADE MODEL CONSTANTS FOR NOMINAL TEMPERATURE REGIMES AND PHOTOPERIODS

For nominal temperature regimes and photoperiods, MEC model constants are provided here for the parameters in Section 4.14.1.6 and Section 4.14.1.7.

*Note: Some values in Table 4.118 differ from the corresponding values listed in Table 4.87*

**Table 4.118 Nominal Temperature Regimes, Planting Densities, and Photoperiods for the Plant Growth and Transpiration Models**

<b>Crop</b>	<b>Nominal Photoperiod <math>H_0</math> [h/d]</b>	<b>Planting Density <sup>205</sup> [plants/m<sup>2</sup>]</b>	<b>Light Cycle Temperature, <math>T_{LIGHT}</math> [ C]</b>	<b>Dark Cycle Temperature, <math>T_{DARK}</math> <sup>206</sup> [ C]</b>
Dry Bean	12	7	26	22
Lettuce	16	19.2	23	23
Peanut	12	7	26	22
Rice	12	200	29	21
Soybean	12	35	26	22
Sweet Potato	18	16	28	22
Tomato	12	6.3	26	22
Wheat	20	720	23	23
White Potato	12	6.4	20	16

**Table 4.119 Biomass Production Model Time Constants for Nominal Temperature Regime and Photoperiod**

<b>Crop</b>	<b>Fraction of Edible Biomass After <math>t_E</math> XFRT</b>	<b>Time at Onset of Edible Biomass Formation, <math>t_E</math> [d<sub>AE</sub>]</b>	<b>Time at Onset of Canopy Senescence, <math>t_Q</math> [d<sub>AE</sub>]</b>	<b>Time at Harvest, <math>t_M</math> [d<sub>AE</sub>]</b>
Dry Bean	0.97	40	42	63
Lettuce	0.95	1	n/a <sup>207</sup>	30
Peanut	0.49	49	65	110
Rice	0.98	57	61	88
Soybean	0.95	46	48	86
Sweet Potato	1.00	33	n/a <sup>207</sup>	120
Tomato	0.70	41	56	80
Wheat	1.00	34	33	62
White Potato	1.00	45	75	138 <sup>208</sup>

<sup>205</sup> Planting density affects the time to canopy closure,  $t_A$ , even though an explicit functionality is not apparent.

<sup>206</sup> The MEC models do not explicitly use the dark cycle temperature, but because the dark cycle temperature affects a crop's development, these values are assumed implicitly for this set of parameters.

<sup>207</sup> This crop is harvested before the canopy reaches senescence.

<sup>208</sup> White potato plants are harvested at  $t = 105$  d<sub>AE</sub>, but  $t_M = 138$  d<sub>AE</sub> is used for the models.

**Table 4.120 Biomass Carbon and Oxygen Production Fractions for Nominal Temperature Regime and Photoperiod**

Crop	Biomass Carbon Fraction, BCF	Oxygen Production Fraction, OPF [mol O <sub>2</sub> /mol C]
Dry Bean	0.45	1.10
Lettuce	0.40	1.08
Peanut	0.50	1.19
Rice	0.44	1.08
Soybean	0.46	1.16

Crop	Biomass Carbon Fraction, BCF	Oxygen Production Fraction, OPF [mol O <sub>2</sub> /mol C]
Sweet Potato	0.44	1.02
Tomato	0.42	1.09
Wheat	0.44	1.07
White Potato	0.41	1.02

The functions for the canopy closure time,  $t_A$  [d<sub>AE</sub>], have the general form:

$$\begin{aligned}
 t_A (PPF_E, [CO_2]) = & C_1 \frac{1}{[CO_2]} \frac{1}{PPF_E} \frac{1}{[CO_2]} + C_2 \frac{1}{PPF_E} \frac{1}{PPF_E} + C_3 \frac{[CO_2]}{PPF_E} \frac{[CO_2]}{PPF_E} + C_4 \frac{[CO_2]^2}{PPF_E} \\
 & \frac{[CO_2]^2}{PPF_E} + C_5 \frac{[CO_2]^3}{PPF_E} \frac{[CO_2]^3}{PPF_E} + C_6 \frac{1}{[CO_2]} \frac{1}{[CO_2]} + \text{Constant} + C_8 [CO_2] + C_9 [CO_2]^2 \\
 & + C_{10} [CO_2]^3 + C_{11} \frac{PPF_E}{[CO_2]} \frac{PPF_E}{[CO_2]} + C_{12} PPF_E + C_{13} PPF_E [CO_2] + C_{14} PPF_E [CO_2]^2 \\
 & + C_{15} PPF_E [CO_2]^3 + C_{16} \frac{PPF_E^2}{[CO_2]} \frac{PPF_E^2}{[CO_2]} + C_{17} PPF_E^2 + C_{18} PPF_E^2 [CO_2] + C_{19} PPF_E^2 [CO_2]^2 \\
 & + C_{20} PPF_E^2 [CO_2]^3 + C_{21} \frac{PPF_E^3}{[CO_2]} \frac{PPF_E^3}{[CO_2]} + C_{22} PPF_E^3 + C_{23} PPF_E^3 [CO_2] + C_{24} PPF_E^3 [CO_2]^2 \\
 & + C_{25} PPF_E^3 [CO_2]^3
 \end{aligned}$$

Equation 4.31

where  $C_1$  through  $C_{25}$  denote coefficients.  $PPF_E$  is expressed in [ $\mu\text{mol}/\text{m}^2 \cdot \text{s}$ ], while  $[CO_2]$  is measured in  $\left[ \frac{\mu\text{mol}_{CO_2}}{\text{mol}_{Air}} \right] \cdot \left[ \frac{\mu\text{mol}_{CO_2}}{\text{mol}_{Air}} \right]$ . To simplify the presentation of these functions, Table 4.121 through Table 4.129 present the coefficient values for each crop in a matrix using the form of Table 4.107 above.

The effective photosynthetic photon flux,  $PPF_E$  [ $\mu\text{mol}/\text{m}^2 \cdot \text{s}$ ], (Rodriguez and Bell, 2004) is:

$$PPF_E = PPF \left( \frac{H}{H_O} \right) \left( \frac{H}{H_O} \right)$$

Equation 4.32

where values for nominal photoperiod,  $H_O$  [h/d], are tabulated in Table 4.118

**Table 4.121 Canopy Closure Time,  $t_A$ , Coefficients for Dry Bean with Nominal Conditions**

	$1/PPF_E$	<b>1</b>	$PPF_E$	$PPF_E^2$	$PPF_E^3$
<b>1/[CO<sub>2</sub>]</b>	$2.9041 \times 10^{-5}$	0	0	0	0
<b>1</b>	$1.5594 \times 10^3$	15.840	$6.1120 \times 10^{-3}$	0	0
<b>[CO<sub>2</sub>]</b>	0	0	0	$-3.7409 \times 10^{-9}$	0
<b>[CO<sub>2</sub>]<sup>2</sup></b>	0	0	0	0	0
<b>[CO<sub>2</sub>]<sup>3</sup></b>	0	0	0	0	$9.6484 \times 10^{-19}$

**Table 4.122 Canopy Closure Time,  $t_A$ , Coefficients for Lettuce with Nominal Conditions**

	1/PPF <sub>E</sub>	1	PPF <sub>E</sub>	PPF <sub>E</sub> <sup>2</sup>	PPF <sub>E</sub> <sup>3</sup>
1/[CO <sub>2</sub> ]	0	0	1.8760	0	0
1	1.0289 × 10 <sup>4</sup>	1.7571	0	0	0
[CO <sub>2</sub> ]	- 3.7018	0	0	0	0
[CO <sub>2</sub> ] <sup>2</sup>	0	2.3127 × 10 <sup>-6</sup>	0	0	0
[CO <sub>2</sub> ] <sup>3</sup>	3.6648 × 10 <sup>-7</sup>	0	0	0	0

**Table 4.123 Canopy Closure Time,  $t_A$ , Coefficients for Peanut with Nominal Conditions**

	1/PPF <sub>E</sub>	1	PPF <sub>E</sub>	PPF <sub>E</sub> <sup>2</sup>	PPF <sub>E</sub> <sup>3</sup>
1/[CO <sub>2</sub> ]	3.7487 × 10 <sup>6</sup>	- 1.8840 × 10 <sup>4</sup>	51.256	- 0.05963	2.5969 × 10 <sup>-5</sup>
1	2.9200 × 10 <sup>3</sup>	23.912	0	5.5180 × 10 <sup>-6</sup>	0
[CO <sub>2</sub> ]	0	0	0	0	0
[CO <sub>2</sub> ] <sup>2</sup>	0	0	0	0	0
[CO <sub>2</sub> ] <sup>3</sup>	9.4008 × 10 <sup>-8</sup>	0	0	0	0

**Table 4.124 Canopy Closure Time,  $t_A$ , Coefficients for Rice with Nominal Conditions**

	1/PPF <sub>E</sub>	1	PPF <sub>E</sub>	PPF <sub>E</sub> <sup>2</sup>	PPF <sub>E</sub> <sup>3</sup>
1/[CO <sub>2</sub> ]	6.5914 × 10 <sup>6</sup>	- 3.748 × 10 <sup>3</sup>	0	0	0
1	2.5776 × 10 <sup>4</sup>	0	0	4.5207 × 10 <sup>-6</sup>	0
[CO <sub>2</sub> ]	0	- 0.043378	4.562 × 10 <sup>-5</sup>	- 1.4936 × 10 <sup>-8</sup>	0
[CO <sub>2</sub> ] <sup>2</sup>	6.4532 × 10 <sup>-3</sup>	0	0	0	0
[CO <sub>2</sub> ] <sup>3</sup>	0	0	0	0	0

**Table 4.125 Canopy Closure Time,  $t_A$ , Coefficients for Soybean with Nominal Conditions**

	1/PPF <sub>E</sub>	1	PPF <sub>E</sub>	PPF <sub>E</sub> <sup>2</sup>	PPF <sub>E</sub> <sup>3</sup>
1/[CO <sub>2</sub> ]	6.7978 × 10 <sup>6</sup>	- 4.326 × 10 <sup>4</sup>	112.63	- 0.13637	6.6918 × 10 <sup>-5</sup>
1	- 4.3658 × 10 <sup>3</sup>	33.959	0	0	- 2.1367 × 10 <sup>-8</sup>
[CO <sub>2</sub> ]	1.5573	0	0	0	1.5467 × 10 <sup>-11</sup>
[CO <sub>2</sub> ] <sup>2</sup>	0	0	- 4.911 × 10 <sup>-9</sup>	0	0
[CO <sub>2</sub> ] <sup>3</sup>	0	0	0	0	0

**Table 4.126 Canopy Closure Time,  $t_A$ , Coefficients for Sweet Potato with Nominal Conditions**

	1/PPF <sub>E</sub>	1	PPF <sub>E</sub>	PPF <sub>E</sub> <sup>2</sup>	PPF <sub>E</sub> <sup>3</sup>
1/[CO <sub>2</sub> ]	1.2070 × 10 <sup>6</sup>	0	0	0	4.0109 × 10 <sup>-7</sup>
1	4.9484 × 10 <sup>3</sup>	4.2978	0	0	0
[CO <sub>2</sub> ]	0	0	0	0	2.0193 × 10 <sup>-12</sup>
[CO <sub>2</sub> ] <sup>2</sup>	0	0	0	0	0
[CO <sub>2</sub> ] <sup>3</sup>	0	0	0	0	0

**Table 4.127 Canopy Closure Time,  $t_A$ , Coefficients for Tomato with Nominal Conditions**

	$1/PPF_E$	<b>1</b>	$PPF_E$	$PPF_E^2$	$PPF_E^3$
<b>1/[CO<sub>2</sub>]</b>	$6.2774 \times 10^5$	0	0.44686	0	0
<b>1</b>	$3.1724 \times 10^3$	24.281	$5.6276 \times 10^{-3}$	$-3.0690 \times 10^{-6}$	0
<b>[CO<sub>2</sub>]</b>	0	0	0	0	0
<b>[CO<sub>2</sub>]<sup>2</sup></b>	0	0	0	0	0
<b>[CO<sub>2</sub>]<sup>3</sup></b>	0	0	0	0	0

**Table 4.128 Canopy Closure Time,  $t_A$ , Coefficients for Wheat with Nominal Conditions**

	$1/PPF_E$	<b>1</b>	$PPF_E$	$PPF_E^2$	$PPF_E^3$
<b>1/[CO<sub>2</sub>]</b>	$9.5488 \times 10^4$	0	0.3419	$-1.9076 \times 10^{-4}$	0
<b>1</b>	$1.0686 \times 10^3$	15.977	$1.9733 \times 10^{-4}$	0	0
<b>[CO<sub>2</sub>]</b>	0	0	0	0	0
<b>[CO<sub>2</sub>]<sup>2</sup></b>	0	0	0	0	0
<b>[CO<sub>2</sub>]<sup>3</sup></b>	0	0	0	0	0

**Table 4.129 Canopy Closure Time,  $t_A$ , Coefficients for White Potato with Nominal Conditions**

	$1/PPF_E$	<b>1</b>	$PPF_E$	$PPF_E^2$	$PPF_E^3$
<b>1/[CO<sub>2</sub>]</b>	$6.5773 \times 10^5$	0	0	0	0
<b>1</b>	$8.5626 \times 10^3$	0	0.042749	$-1.7905 \times 10^{-5}$	0
<b>[CO<sub>2</sub>]</b>	0	0	$8.8437 \times 10^{-7}$	0	0
<b>[CO<sub>2</sub>]<sup>2</sup></b>	0	0	0	0	0
<b>[CO<sub>2</sub>]<sup>3</sup></b>	0	0	0	0	0

For certain crops under low-lighting conditions, the relationships above for  $t_A$  and  $A_{MAX}$  require modification. Physically, the canopy does not close under low light, so  $A_{MAX}$  does not reach 0.93, for the nominal photoperiod and planting densities listed in Table 4.118. Thus, to use the models above under such conditions and obtain reasonably accurate results, modified values for the time at canopy closure,  $t_A$ , and the maximum fraction of PPF absorbed by the plant canopy,  $A_{MAX}$ , are required. Table 4.130 provides modified values for the conditions listed, where  $t_A$  is the time until the listed  $A_{MAX}$  is attained. The nominal photoperiods and planting densities associated with these values are also given for reference, and they are consistent with values provided in Table 4.118 above.

**Table 4.130 MEC Model Parameters for Low-Light Conditions, Nominal Temperature Regimes**

Crop	Photo-period [h/d]	Planting Density [plants/m <sup>2</sup> ]	PPF [ $\mu\text{mol}/\text{m}^2\cdot\text{s}$ ]	[CO <sub>2</sub> ] [ $\mu\text{mol}/\text{mol}$ ]	t <sub>A</sub> [d <sub>AE</sub> ]	A <sub>MAX</sub>
Lettuce	16	19.2	200	330	32	0.18
				660	32	0.35
				990	32	0.46
				1,320	32	0.49
			300	330	32	0.75
Rice	12	200	200	330	45	0.13
				660	45	0.21
				990	45	0.26
				1,320	45	0.28
			300	330	50	0.33
				660	50	0.50
				990	50	0.59
				1,320	50	0.62
			400	330	50	0.57
				660	50	0.75
				990	50	0.82
				1,320	50	0.83
Sweet Potato	18	16	200	330	30	0.58
				660	30	0.76
				990	30	0.84
				1,320	30	0.86
			300	330	31	0.90
White Potato	12	6.4	200	330	36	0.34
				660	38	0.49
				990	38	0.58
				1,320	39	0.60
			300	330	40	0.80
				660	42	0.90

MEC model constants for additional temperature regimes are reported in Cavazzoni (2001).

## 4.15 PLANETARY PROTECTION

### 4.15.1 WHAT DESIGNS DECREASE THE PROBABILITY OF CONTAMINATING MARS AND EARTH?

NASA possesses several policy documents describing necessary constraints on missions traveling to and from extraterrestrial bodies that either may harbor indigenous life or could support terrestrial life. Two documents (NPD 8020.7G, 2013, and NPR 8020.12D, 2011) describe the processes NASA uses to comply with international agreements (UN, 1967, and COSPAR, 2005) to ensure that robotic probes do not contaminate potentially sensitive extraterrestrial destinations that may support their own indigenous life and to ensure that any samples returned from those targets do not release extraterrestrial life forms to Earth. Two documents

(NPD 8900.5B, 2011, and NPR 8900.1A, 2012) describe how crewmembers are to be protected while operating in an extraterrestrial environment where extraterrestrial life forms may be present.

What is missing, however, are NASA-approved and published guidance to address potential planetary protection for vehicles carrying human crews. The NASA Planetary Protection Officer is developing appropriate procedures and requirements to govern missions with human crews to Mars and other sensitive extraterrestrial destinations. Spry (2013) provides some preliminary material that may become part of the final NASA documents. Spry (2013) begins with four general principles:

1. *“Safeguarding the Earth from potential back contamination is the highest planetary protection priority in Mars exploration.”*
2. *“The greater capability of human explorers can contribute to the astrobiological exploration of Mars only if human-associated contamination is controlled and understood.”*
3. *“For a landed mission conducting surface operations, it will not be possible for all human associated processes and mission operations to be conducted within entirely closed systems.”*
4. *“Crewmembers exploring Mars, or their support systems, will inevitably be exposed to martian materials.”*

Spry (2013) also provides several implementation guidelines, with those applicable to the present discussion being:

1. *“Human missions will carry microbial populations that will vary in both kind and quantity, and it will not be practicable to specify all aspects of an allowable microbial population or potential contaminants at launch. Once any baseline conditions for launch are established and met, continued monitoring and evaluation of microbes carried by human missions will be required to address both forward and backward contamination concerns.”*
2. *“A quarantine capability for both the entire crew and for individual crewmembers shall be provided during and after the mission, in case potential contact with a martian life-form occurs.”*
3. *“A comprehensive planetary protection protocol for human missions should be developed that encompasses both forward and backward contamination concerns, and addresses the combined human and robotic aspects of the mission, including subsurface exploration, sample handling, and the return of the samples and crew to Earth.”*
4. *“Neither robotic systems nor human activities should contaminate “Special Regions”<sup>209</sup> on Mars, as defined by this [Committee on Space Research (COSPAR)]<sup>210</sup> policy.”*
5. *“An onboard crewmember should be given primary responsibility for the implementation of planetary protection provisions affecting the crew during the mission.”*
6. *“Planetary protection requirements for initial human missions should be based on a conservative approach consistent with a lack of knowledge of martian environments and possible life, as well as the performance of human support systems in those environments. Planetary protection requirements for later missions should not be relaxed without scientific review, justification, and consensus.”*

Spry (2013) recommends the following approach regarding introduction of ECLSS waste streams to the Martian environment:

---

<sup>209</sup> Special regions are defined by COSPAR as domains that may either support extraterrestrial life or terrestrial life (COSPAR, 2005). Beaty, *et al.* (2006) define special regions quantitatively for NASA, to comply with COSPAR (2005), as a region where the temperature rises above  $-20^{\circ}\text{C}$  **and** the water activity is 0.5 or above.

<sup>210</sup> COSPAR is an international body that, among other functions, defines protocols to comply with the Outer Space Treaty (UN, 1967). COSPAR’s planetary protection requirements are detailed in COSPAR (2005).

*“On the specific issue of waste streams, presuming that they are identified as having biologic or organic components (that could confound [planetary protection] efforts if released in an uncontrolled fashion), they should be filtered or otherwise processed prior to release/disposal (e.g., maybe [high-efficiency particulate air] filter of gases, autoclaving of solid/liquid wastes).”*

#### **4.15.2 BACKWARD CONTAMINATION**

The general principles and implementation guidelines above can be reduced to a few points in the context of ECLSS architecture and preventing backward contamination.

##### *4.15.2.1 SAFEGUARD EARTH*

Safeguarding Earth from any type of backward contamination is the principle of greatest importance. No unconstrained extraterrestrial life forms should be allowed to reach Earth either in returned samples or as an infection to the crew.

##### *4.15.2.2 HUMAN SURFACE SYSTEMS WILL NOT BE COMPLETELY CLOSED*

As currently envisioned, human surface systems will not be completely closed because for human beings to investigate the Martian surface, they must leave their habitat to conduct EVAs. This mechanism of departing the surface habitat enables a process by which the crew and/or the habitat are either intentionally or unintentionally exposed to Martian materials in an uncontrolled manner.

##### *4.15.2.3 PROVIDE A QUARANTINE CAPABILITY*

When crewmembers are exposed to Martian materials and, possibly, to Martian life forms, a quarantine capability is necessary to segregate the affected crewmembers from the rest of the crew while determining the severity and effects of the exposure.

##### *4.15.2.4 USE CONSERVATIVE APPROACHES INITIALLY*

The initial approaches for all surface habitat systems, including the ECLSS architecture, should be conservative. While future missions could potentially use more relaxed protocols once the Martian surface is determined to be biologically benign based upon thorough scientific examination, the overall ECLSS architecture is likely to remain mostly unchanged except as necessary to correct any design or operational deficiencies.

#### **4.15.3 FORWARD CONTAMINATION**

In like manner, the general principles and implementation guidelines provide some guidance on preventing forward contamination of the Martian environment via the ECLSS architecture.

##### *4.15.3.1 CONTROL AND UNDERSTAND HUMAN-ASSOCIATED CONTAMINATION*

Terrestrial biomarkers released on the Martian surface may confound any planetary science, so such events are to be avoided to preserve the integrity of planetary science. Historically, some lunar samples collected by Project Apollo contained water with the same elemental isotopes as terrestrial water. Because the Apollo heat rejection technologies for both the Lunar Module and the EVA space suit used vaporization of water to reject thermal loads, a possible explanation for the lunar water is that Apollo mission elements deposited it upon the samples before collection (Glavin, *et al.*, 2010). Another possible explanation is that the same mechanism that delivered water to Earth also provided the water found in the lunar samples. However, because Apollo surface assets potentially provided the observed water, a contamination scenario cannot be rejected without reasonable doubt remaining, so the mission elements themselves unintentionally confounded the planetary science.

Microbial terrestrial biomarkers are an intimate and vital part of any healthy human being. Indeed, separating the symbiotic microorganisms from the human being will eventually kill that human being. Because the symbiotic microorganisms cannot be removed from a human being, they are part of the potential terrestrial load that is part of any human crew. For a robotic probe, COSPAR (2005) requires prior to launch a detailed catalog of all substances comprising components of the probe that are intended to reach the Martian surface. Further, the microbial loading for a probe going to the Martian surface is to be significantly reduced, with the level of reduction dependent upon the intent of the mission and its expected interaction with potentially sensitive regions of Mars (COSPAR, 2005). Similar restrictions are impractical for a human crew because human beings cannot be segregated from their symbiotic microorganisms and because biological creatures are much harder to



definitively catalog for constitutive compounds compared with mechanical structures. Further, the composition of a living human being changes with time on much shorter timescales and in a less predictable manner than for a mechanical structure that may exhibit oxidation and similar surface degradation due to chemical interactions with the environment. In summary, human-associated contamination varies more widely than probe-associated contamination, and understanding this contribution from a human crew is essential for guarding and interpreting planetary science while using human beings as direct investigators on the Martian surface.

#### *4.15.3.2 HUMAN SURFACE SYSTEMS WILL NOT BE COMPLETELY CLOSED*

Human surface systems, if based upon or are similar to current technology, are unlikely to be completely closed, so terrestrial biomarkers could have an avenue to escape from the interior of human surface systems. Terrestrial biomarkers include living or recent deceased terrestrial microorganisms and any organic compounds produced by or incorporated within a terrestrial organism. As noted above, deposition of terrestrial biomarkers may confound Martian planetary science. Thus, even without complete isolation of human surface systems from the Martian environment, it is essential to inhibit the transfer of terrestrial biomarkers into areas of the Martian environment where those biomarkers may contaminate potential samples used to understand the evolution of the Martian environment. Therefore, as specifically recommended by Spry (2013), any discharge streams should be filtered to contain any terrestrial biomarkers within the human-occupied volume.

#### *4.15.3.3 DO NOT AFFECT "SPECIAL REGIONS"*

As noted above, special regions are those areas of Mars that may either be a haven for terrestrial life, if released into the Martian environment, or they may support indigenous Martian life.<sup>211</sup> To truly maximize planetary science, terrestrial biomarkers must not be allowed to contaminate these areas prior to investigating them thoroughly. If Martian life is discovered, such areas may remain perpetually excluded from willful terrestrial contamination. Current approaches within Mars DRA 5.0 (Drake, 2009a) envision using sterilized robotic assistants for initial exploration of any special regions near a human landing site both to ensure the planetary science and to reduce the likelihood of accidental human exposure to Martian life forms.

---

<sup>211</sup> Though far from a certainty, the underlying assumption is that Martian life will require similar conditions to those required by terrestrial life. Certainly for terrestrial life to flourish on Mars, the conditions must be sufficient to support that life. That Martian life will flourish only under similar conditions as those required for terrestrial life remains an active area of research.

## 5 REFERENCES

- AIAA, [www.discoverynow.us](http://www.discoverynow.us).
- Allen CC, Zubrin R. "In-situ Resources." In: Larson, WJ, Pranke, L, eds. *Human Space flight: Mission Analysis and Design*. New York, NY: McGraw-Hill Space Technology Series; 1999.
- ALS RD. "Advanced Life Support Program: Requirements Definition and Design Consideration." JSC-38571 (CTSD-ADV-245, Rev. A), Lange KE, Lin, CH, eds. National Aeronautics and Space Administration, Lyndon B. Johnson Space Center, Houston, TX; 1998.
- ALS RD. "Advanced Life Support Requirements Document." JSC-38571 (CTSD-ADV-245), Revision C, Duffield BE, ed. National Aeronautics and Space Administration, Lyndon B. Johnson Space Center, Houston, TX; 2003.
- ALS Systems Workshop. Presentation to the Advanced Life Support Systems Workshop. National Aeronautics and Space Administration, Lyndon B. Johnson Space Center, Houston, TX; March 1998.
- Atwell W, Badhwar G. "TransHab Shield Model and Crew Radiation Exposures." 33<sup>rd</sup> Scientific Assembly of the Committee on Space Research (COSPAR), Warsaw, Poland; 16-23 July 2000.
- AZ Technology. Laboratory Portable Spectroreflectometer LPSR-200 Briefing. Huntsville, AL. See also: <http://www.aztechnology.com/>. Presentation to National Aeronautics and Space Administration, Lyndon B. Johnson Space Center, Houston, TX; 18 November 1993.
- Bagdigian RM. "Challenges with Deploying and Integrating Environmental Control and Life Support Functions in a Lunar Architecture with High Degree of Mobility.;" 2009-01-2481.
- Ball VE, Butault J-P, Nehring R. "U. S. Agriculture, 1960-96: A Multilateral Comparison of Total Factor Productivity." Technical Bulletin Number 1895, United States Department of Agriculture, Economic Research Service, Resource Economics Division, Washington, DC; 2001.
- Bamsey M., Berinstain A., Auclair S, Battler M, Binsted K, Bywaters K, Harris J, Kobrick R, McKay C. Four-month Moon and Mars crew water utilization study conducted at the Flashline Mars Arctic Research Station, Devon Island, Nunavut, *Advances in Space Research*. 2009;43:1256-1274.
- Barta DJ, Castillo JM, Fortson RE. "The Biomass Production System for the Bioregenerative Planetary Life Support Systems Test Complex: Preliminary Designs and Considerations." SAE paper 1999-01-2188, 29<sup>th</sup> International Conference on Environmental Systems, Society of Automotive Engineers, Warrendale, PA; 1999.
- Barta DJ, Ewert MK. National Aeronautics and Space Administration, Lyndon B. Johnson Space Center, Houston, TX. Personal communication based on data from the Variable Pressure Growth Chamber at Lyndon B. Johnson Space Center; 30 April 2002.
- BDB. *Bioastronautics Data Book*, 2<sup>nd</sup> Edition. NASA SP 3006, Parker JS Jr, West VR, eds. National Aeronautics and Space Administration, Washington, DC; 1973.
- Behrend AF Jr, Henninger DL. "Baseline Crops for Advanced Life Support Program." JSC Memo EC3-98-066, National Aeronautics and Space Administration, Lyndon B. Johnson Space Center, Houston, TX; 1998.
- Berry W, et al. "NASA's Advanced Life Support Technology Program." SAE paper # 941290, ICES, 1994.
- Berte M, Capell B. Tables 2-4, "Balance of Plant Options for the Heat Pipe Bimodal System." American Institute of Physics, CP420, Space Technology and Applications International Forum (STAIF); 1998.
- Boeing. "System Specification for the International Space Station Alpha." SSP-41000, Contract Number NAS15-10000, CDRL Sequence Number MG02, Boeing Defense and Space Group, Space Station Program Office, Houston, TX; 9 February 1994.
- Boeing. "Orbiter Vehicle End Item Specification for the Space Shuttle System, Part 1, Performance and Design Requirements." MJ070-0001-1E, The Boeing Company, Houston, TX; 7 November 2002.
- Bourget CM. "An introduction to light-emitting diodes." *HortScience*. 2008;43(7):1944-1946.
- Bourget, M of Orbital Technologies Corp (Orbitec), email communication November 25, 2014.
- Branch G. "International Space Station Clothing Subsystem." Presentation to the Advanced Life Support Systems Analysis Workshop. National Aeronautics and Space Administration, Lyndon B. Johnson Space Center, Houston, TX; 27 March 1998.

- Broyan JL, Chu A, Ewert MK. "Logistics Reduction and Repurposing Technology for Long-Duration Space Missions." 44<sup>th</sup> International Conference on Environmental Systems, ICES-2014-59.
- Carrasquillo RL, Reuter JL, Philistine, CL. "Summary of Resources for the International Space Station Environmental Control and Life Support System." SAE Paper 972332, 27<sup>th</sup> International Conference on Environmental Systems, Lake Tahoe, Nevada, Society of Automotive Engineers, Warrendale, PA; 1997.
- Carter DL. "Waste Water Characterization for the ISS Water Processor." SAE Paper 981616, 28<sup>th</sup> International Conference on Environmental Systems, Society of Automotive Engineers, Warrendale, PA; 1998.
- Carter DL, Brown C, Orozco, N., "Status of ISS Water Management and Recovery", AIAA Paper 2013-3509, 43<sup>th</sup> International Conference on Environmental Systems, American Institute of Aeronautics and Astronautics, 2013
- Cataldo RL. "Comparison of Solar Photovoltaic and Nuclear Power Systems for Human Missions to Mars." Mars Exploration Forum, Lunar and Planetary Institute, Houston, TX; 4-5 May 1998.
- Cataldo RL. (2006) National Aeronautics and Space Administration, Glenn Research Center, Cleveland, Ohio. Personal communication.
- Cavazzoni, J. "Crop Specific Parameters for Use in Modified Energy Cascade Models." Bioresource Engineering, Department of Plant Science, Rutgers University, New Brunswick, NJ; January 2001.
- Chaput K. "On-orbit Consumables Matrix." National Aeronautics and Space Administration, Lyndon B. Johnson Space Center, International Space Station Program, Houston, TX; 5 February 2003.
- Charmin. "Bath Tissue Trivia," [http://www.charmin.com/en\\_us/pages/facts\\_trivia.shtml](http://www.charmin.com/en_us/pages/facts_trivia.shtml), Charmin<sup>®</sup>, The Procter and Gamble Company, Cincinnati, OH; 2002.
- Clawson JM. "Feasibility of a Mars Surface Inflatable Greenhouse: Availability of Photosynthetic Irradiance and the Durability of Transparent Polymer Films." Dissertation. University of Colorado, Boulder, CO; 2006.
- Conger BC, Clark CS. "Thermal Analysis Basics and Design Guidelines." Lockheed Martin Space Operations, Houston, TX; Internal teaching lecture notes from 12 January 1997.
- Cooper M., Douglas G., Perchonok, M. 2011. "Developing the NASA food system for long duration missions." *Journal of Food Science*. 76(2):R40-48.
- Cooper M., Catauro, P. Perchonok, M. 2012. "Development and evaluation of bioregenerative menus for Mars habitat missions." *Acta Astronautica*, *Journal of the International Academy of Astronautics*, [www.iaaweb.org](http://www.iaaweb.org).
- COSPAR (2005) "COSPAR Planetary Protection Policy." Committee on Space Research, World Space Congress, Houston, Texas, 20 October 2002, Amended 24 March 2005.
- Cucinotta FA, Kim M-H Y, Ren L. "Managing Lunar and Mars Mission Radiation Risks Part I: Cancer Risks, Uncertainties, and Shielding Effectiveness." NASA/TP-2005-213164.
- Database. Internal interim Advanced Life Support Database for Fiscal Year 2002. Lockheed Martin Space Operations for National Aeronautics and Space Administration, Lyndon B. Johnson Space Center, Houston, TX; 2002.
- Davis JM, Cataldo RL, Soeder JF, Manzo MA, Hakimzadeh R. "An Overview of Power Capability Requirements for Exploration Missions." NASA/TM-2005-213600, National Aeronautics and Space Administration, Glenn Research Center, Cleveland, OH; 2005.
- Derbés B. "Case Studies in Inflatable Rigidizable Structural Concepts for Space Power." AIAA Paper AIAA-99-1089, 37<sup>th</sup> AIAA Aerospace Sciences Meeting and Exhibit, Reno, Nevada, American Institute of Aeronautics and Astronautics, Reston, VA; 1999.
- de Vera TL Jr. (1998a) "Environmental Control and Life Support System (ECLS) Section of the Space Station Operations Data Book (SSODB) United States Laboratory Module." Draft Engineering Release, Revision B, The Boeing Company, Houston, TX; June 1998.
- de Vera TL Jr. (1998b) "Environmental Control and Life Support System (ECLS) Section of the Space Station Operations Data Book (SSODB) Joint Airlock." Draft Engineering Release, The Boeing Company, Houston, TX; August 1998.
- de Vera TL Jr. "Environmental Control and Life Support System (ECLS) Section of the Space Station Operations Data Book (SSODB) Node 1." Flight Release, Revision D, The Boeing Company, Houston, TX; March 1999.

- Diem K, Lentner C, eds. *Documenta Geigy: Scientific Tables*, 7<sup>th</sup> Edition, Ciba-Geigy Limited, Basle, Switzerland; 1970:657.
- Dornier. Equipment specification from Dornier System for Modular Spacelab.
- Drake, BG. Editor (2009a) "Human Exploration of Mars Design Reference Architecture 5.0." NASA/SP-2009-566, National Aeronautics and Space Administration, Lyndon B. Johnson Space Center, Houston, Texas.
- Drysdale A. "Clothing for Lunar Outpost." Report to NASA; December 2006.
- Drysdale AE. "KSC Systems Analysis." Presentation to the Advanced Life Support Systems Analysis Workshop. The Boeing Company. John F. Kennedy Space Center, FL; 26 March 1998.
- Drysdale AE. "Biomass Production System – Optimized from State-of-Art." Draft presentation for Systems Modeling and Analysis Project management. The Boeing Company. John F. Kennedy Space Center, FL; 7 June 1999.
- Drysdale AE., Beavers D., Posada V. "KSC Life Sciences Project Annual Report for January to December, 1997." The Boeing Company. John F. Kennedy Space Center, FL; June 1998.
- Drysdale AE. "Life Support Studies Involving Plants." SAE Paper 2001-01-2362, 28<sup>th</sup> International Conference on Environmental Systems, Society of Automotive Engineers, Warrendale, PA; 2001
- Duffield BE. "Power Mass Penalty Data." ESCG-4470-05-TEAN-DOC-126A, 01/17/2006, Houston, TX; 2006.
- Duffield BE. "Review of the Radiation Environment and Shielding Options for Deep Space Missions." ESCG-4470-09-TEAN-DOC-201, 01/17/2010. Houston, TX; 2010.
- Eagle Engineering. "Conceptual Design of a Lunar Base Solar Power Plant - Lunar Base Systems Study Task 3.3." Table 9, NASA-CR-172086, Eagle Engineering, Houston, TX; August 1988.
- Eagle-Picher. "Nickel Hydrogen Battery Technical Data Sheet for RNH 81 5 Cells." Eagle-Picher Technologies, LLC, Space Business Unit. Joplin, MO; 2003.
- Eckart P. *Space flight Life Support and Biospherics*, Space Technology Library, Microcosm Press, Torrance, CA; 1996.
- EDCC. "Maximum Absorption Garment III, Extravehicular Mobility Unit Equipment." Drawing Number SED 13101720, Revision B, National Aeronautics and Space Administration, Lyndon B. Johnson Space Center, Engineering Drawing Control Center, Houston, TX; 22 January 1998.
- EDIS. Extension Digital Information Source, Institute of Food and Agricultural Sciences, University of Florida, Gainesville, FL; 2001.
- El-Genk MS, Tournier J. "Conceptual Design of a 100 kW Reactor for a Space Nuclear Reactor Power System with high Powered AMTEC." American Institute of Physics, CP654, Space Technology and Applications International Forum (STAIF); 2003.
- Elliot JO, Lipinski RJ, Poston DI. "Design Concept for a Nuclear Reactor-Powered Mars Rover." American Institute of Physics, CP654, Space Technology and Applications International Forum (STAIF); 2003.
- ESAS. "NASA's Exploration Systems Architecture Study." NASA/TM-2005-214062, National Aeronautics and Space Administration, Washington, DC; November 2005.
- ESM GD. "Advanced Life Support Equivalent System Mass Guidelines Document." NASA TM-2003-212278, Levri JA, Drysdale AE, Ewert MK, Fisher JW, Hanford AJ, Hogan JA, Jones HW, Joshi JA, Vaccari DA. National Aeronautics and Space Administration, Ames Research Center, Moffett Field, CA; 2003.
- Ewert MK, Keller JR, Hughes B. "Conceptual Design of a Solar Powered Heat Pump for Lunar Base Thermal Control System." SAE Paper 961535. Society of Automotive Engineers, Warrendale, PA; 1996.
- Ewert MK. Personal communication based on data from internal Biomass Production Chamber Lighting System Trade Study. National Aeronautics and Space Administration, Lyndon B. Johnson Space Center, Houston, TX; October 1998.
- Ewert MK, Curry DM, Lin CH, Brown RG. "Thermal Control." Chapter 16, *Human Space flight: Mission Analysis and Design*, Larson WJ, Pranke L, eds. McGraw-Hill Space Technology Series, New York, NY; 1999.
- Ewert, MK. "A Simplified Method of Characterizing Refrigerator/Freezer Performance." National Aeronautics and Space Administration, Lyndon B. Johnson Space Center, Crew and Thermal Systems Division, Houston, TX; Internal Crew and Thermal Systems Division white paper dated 08 April 2002.

- Ewert MK, Broyan JL, "Mission Benefits Analysis of Logistics Reduction Technologies." AIAA-2013-3383, ICES, July 2013
- Ewert MK, Jeng F, "Will Astronauts Wash Clothes on the Way to Mars?" paper in work for ICES 2015.
- Finn, CK. "A Survey of Life Support Systems Automation and Control." NASA Technical Memorandum 103977, NASA Ames Research Center; January 1993.
- French SJ, Perchonok MH. "Evaluation of a 10-Day Menu Using a Bulk Commodity Supply Scenario." JSC 63366, Revision: Basic, National Aeronautics and Space Administration, Lyndon B. Johnson Space Center, Habitability and Environmental Factors Division, Houston, TX; February 2006.
- Frisbee RH, Hoffman NJ. "SP-100 Nuclear Electric Propulsion for Mars Cargo Missions." AIAA Paper AIAA-93-2092. 29<sup>th</sup> AIAA/SAE/ASME/ASEE Joint Propulsion Conference and Exhibit, Monterey, CA; June 1993. American Institute of Aeronautics and Astronautics, Washington, DC.
- Frisbee RH, Hoffman NJ. "Electric Propulsion Options for Mars Cargo Missions." AIAA Paper AIAA-96-3173. 32<sup>nd</sup> AIAA/ASME/SAE/ASEE Joint Propulsion Conference and Exhibit, Lake Buena Vista, FL; July 1996, American Institute of Aeronautics and Astronautics, Reston, VA.
- Garcia R. "Space Transportation System 29 (STS-29) Trash Evaluation Final Report." JSC-SP-89-1. National Aeronautics and Space Administration, Lyndon B. Johnson Space Center, Houston, TX; 1989.
- Gates M, et al. "The Asteroid Redirect Mission and Sustainable Human Exploration." IAC-14.A5.1.1, Paper at the 65<sup>th</sup> International Astronautical Congress, Toronto, Canada, 2014
- Glavin DP, Dworkin JP, Lupisella M, Williams DR, Kminek G., and Rummel JD. (2010) "In Situ Biological Contamination Studies of the Moon: Implications for Planetary Protection and Life Detection Missions." *Earth Moon Planets*, **107**, pp. 87-93.
- Green J, Lemmons N, Halligan J. "ISS Integrated Traffic Model." ISS Program Document TDS D8.1.1-04, International Space Station Program. The Boeing Company, Houston, TX; 3 June 2000.
- Grounds P. "Space Transportation System 35 (STS-35) Trash Evaluation Final Report." JSC-SP-90-2. National Aeronautics and Space Administration, Lyndon B. Johnson Space Center, Houston, TX; 1990.
- Hallberg L, Nilsson L. "Constancy of individual menstrual blood loss," *Acta Obst. Gynec. Scandinav.*;1964;**43**:352-360.
- Hamilton Sundstrand. "Trade-off Study and Conceptual Designs of Regenerative Advanced Integrated Life Support Systems (AILSS), February 1968 – January 1970." NASA-CR-1458. Hamilton Standard, Windsor Locks, CT; 1970.
- Hanford AJ. "Advanced Regenerative Life Support System Study." JSC-38672 (CTSD-ADV-287). National Aeronautics and Space Administration, Lyndon B. Johnson Space Center, Houston, TX; 1997. See also: Hanford A J. "Advanced Regenerative Life Support System Study Update." LMSMSS-32447. Lockheed Martin Space Mission Systems and Services, Houston, TX; 1997.
- Hanford AJ. "Power-Mass Penalties and Radiator Sink Temperatures on Luna and Mars for Advanced Life Support System Parametric Studies." LMSMSS-32749, Lockheed Martin Space Mission Systems and Services, Houston, TX; 1998.
- Hanford AJ. "A List of Life Support Subsystems for the Advanced Life Support Project." MSAD-00-0138. Lockheed Martin Space Operations, Houston, TX; 2000.
- Hanford AJ, Ewert MK. "Advanced Active Thermal Control Systems Architecture Study Report." NASA-TM-104822. National Aeronautics and Space Administration, Lyndon B. Johnson Space Center, Houston, TX; 1996.
- Hanford, AJ. (2012) "Planetary Protection Technical Issues for Human Crews Exploring the Surface of Mars." ESCG-4470-11-TEAN-DOC-0109, Engineering and Science Contract Group, Houston, Texas, 16 p., 06 January 2012.
- Hanford, AJ. (2013) "Martian Surface Habitat Lander Environmental Control and Life Support System Study for Fiscal Year 2013." JETS-JE33-13-TAED-DOC-0046, JSC Engineering, Technology and Science Contract Group, Houston, Texas, 16 p., 02 October 2013.
- Harty RB, Durand RE. "Lunar Electric Power Systems Utilizing the SP-100 Reactor and Dynamic Conversion Systems." NASA CR-191023. Rockwell International Corporation, Rocketdyne Division, Canoga Park, CA; March 1993.

- Hawk PB. *Hawk's Physiological Chemistry*. Oser BL, ed. McGraw-Hill, New York, NY; 1965:1472.
- Heiken GH., Vaniman DT, and French BM. "The Lunar Source Book a User's Guide to the Moon." Cambridge University Press, 1991
- Hoang D, Ludwigs S, Schmitz P, Wright J. "Mars Sample Return Power Supply." NASA-CR-184708. Texas A&M University, Nuclear Engineering Department, College Station, TX; 1988.
- Hogan J. Personal communication, OPIS; 2010. See also Fisher, et al. "Impact of Water Recovery from Wastes on the Lunar Surface Mission Water Balance", AIAA 2010-6008.
- Hoffman SJ, Kaplan DL. "Human Exploration of Mars: The Reference Mission of the NASA Mars Exploration Study Team." NASA-SP-6107. National Aeronautics and Space Administration, Lyndon B. Johnson Space Center, Houston, TX; 1997. <http://exploration.jsc.nasa.gov/marsref/contents.html>
- Hopper DA, Stutte GW, McCormack A, Barta DJ, Heins RD, Erwin JE, Tibbitts, TW. "Crop growth requirements (Appendix)." In Langhans RW, Tibbitts TW, eds, *Plant Growth Chamber Handbook*, Iowa Agriculture and Home Economics Experiment Station Special Report No. 99, Iowa State University, Ames, IA; 1997.
- Houtchens BA. *Medical Care Systems for Long Duration Space Missions*. Clinical Chemistry; 1993;39/1:13-21.
- Howell JR, Buckius RO. *Fundamentals of Engineering Thermodynamics, SI Version*. McGraw-Hill Book Company, New York, NY; 1987.
- Hughes B. "Lunar Base Power System for Solar Heat Pumps." LMES-31919. Lockheed Martin Engineering and Sciences, Houston, TX; 1995.
- Humphries WR, Griggs EI. "A Design Handbook for Phase Change Thermal Control and Energy Storage Devices." NASA Technical Paper 1074. National Aeronautics and Space Administration, George C. Marshall Space flight Center, Huntsville, AL; 1977.
- Hunter G. "Microfabricated Chemical Gas Sensors and Sensor Arrays for Aerospace Applications." NASA Publication 20050210196. NASA Glenn Research Center; 2005.
- Hunter J, Drysdale AE. "Concepts for Food Processing for Lunar and Planetary Stations." SAE paper 961415. 26<sup>th</sup> International Conference on Environmental Systems. Society of Automotive Engineers. Warrendale, PA; 1996.
- Hunter J, Drysdale AE. (2002) Department of Agricultural and Biological Engineering, Cornell University, Ithaca, New York, and The Boeing Company, Kennedy Space Center, Florida. Personal communication, 03 October 2002.
- Incropera FP, DeWitt DP. *Fundamentals of Heat and Mass Transfer*, 7th Edition, John Wiley and Sons, Inc., New York, NY; 2011.
- ISS. "On-Orbit Assembly Modeling and Mass Properties Data Book." JSC-26557, Rev. P, Vol. 1. National Aeronautics and Space Administration, Lyndon B. Johnson Space Center, Houston, TX; 2011.
- James JT. "Volatile Combustion Product Monitoring in Spacecraft." Memo No. TOX-JJ-2012-01rev, 04-Sep-2013
- Jan D. "Monitoring and Control Mass Estimate Issues." Presentation to the Advanced Life Support Systems Analysis Workshop. National Aeronautics and Space Administration, Headquarters, Washington, DC; 27 March 1998.
- JCPC "Joint Crew Provisioning Catalog." SSP 50477, Rogers JA, ed. National Aeronautics and Space Administration, Lyndon B. Johnson Space Center, International Space Station Program, Houston, TX; baseline dated September 1999.
- Jeng F, Ewert MK. "Trade Study on Laundry Systems for Advanced and ISS Missions." Presentation to NASA; January 2002.
- Jeng F, Ewert MK. "Trade Study on Laundry System for Advanced and ISS Missions." Revision 4, Presentation package for the National Aeronautics and Space Administration, 18 January 2002. National Aeronautics and Space Administration, Lyndon B. Johnson Space Center, Houston, TX; 2002.
- Jeng F. "Laundry Study for Constellation." ESCG-4470-08-TEAN-DOC-0281; August 18, 2008.
- Jones B. "Trash," [http://iss-www.jsc.nasa.gov/ss/issapt/mio/trash/trash\\_cat.html](http://iss-www.jsc.nasa.gov/ss/issapt/mio/trash/trash_cat.html), National Aeronautics and Space Administration, Lyndon B. Johnson Space Center, Houston, TX; 5 October 2000.

- Jones H, Cavazzoni J. "Crop Models for Advanced Life Support Analysis." SAE Paper 2000-01-2261. 30<sup>th</sup> International Conference on Environmental Systems, Toulouse, France. Society of Automotive Engineers, Warrendale, PA; 2000.
- Juhasz, JJ, Bloomfield HS. "Development of Lightweight Radiators for Lunar Based Power Systems." NASA/TM-1994-106604, National Aeronautics and Space Administration, Lewis Research Center, Cleveland, OH; 1994.
- K&K. "Luna's (Earth's Moon) Thermal Environment." (Note: Material extracted from "Thermal Environments." JPL D-8160.) K&K Associates, Westminster, CO; 1998.
- Kerslake TW. "Electric Power System Technology Options for Lunar Surface Missions." NASA/TM-2005-213629, National Aeronautics and Space Administration, Glenn Research Center, Cleveland, OH; April 2005.
- Kilbourn M. (1998) "ISS-TransHab Mass." National Aeronautics and Space Administration, Lyndon B. Johnson Space Center, Advanced Development Office, Houston, Texas. Internal NASA spreadsheet summarizing TransHab masses dated 09 October 1998.
- Kloeris V, Vodovotz Y, Bye L, Stiller CQ, Lane E. "Design and Implementation of a Vegetarian Food System for a Closed Chamber Test." *Life Support & Biosphere Science, International Journal of Earth/Space*. 1998;5:231-242.
- Lahey RT Jr, Dhir V. "Research in Support of the Use of Rankine Cycle Energy Conversion Systems for Space Power and Propulsion." NASA/CR-2004-213142. National Aeronautics and Space Administration, Glenn Research Center, Cleveland, OH; 2004.
- Landis GA, Appelbaum J. (1991) *Photovoltaic Power Options for Mars Space Power*, Vol. 10, No. 2, pp 225-237.
- Landis GA, McKissock BI, Bailey SG. (1999) "Designing Power Systems." Chapter 20, *Human Space flight: Mission Analysis and Design*, Larson WJ, Pranke L, eds. McGraw-Hill Space Technology Series, New York, New York.
- Lane HW, Bourland CT, Pierson D, Grigorov E, Agureev A, Dobrovolsky V. "Nutritional Requirements for International Space Station Missions up to 360 days." JSC-28038. National Aeronautics and Space Administration, Lyndon B. Johnson Space Center, Houston, TX; 1996.
- Lane HW, Sauer RL, Feedback DL, *Isolation: NASA Experiments in Closed-Environment Living, Advanced Human Life Support Enclosed System Final Report*. Vol. 104 Science and Technology Series, American Astronautical Society, copyright 2002.
- Lange KE. Lockheed Martin Space Mission Systems and Services, Houston, Texas. From a spreadsheet prepared by KE Lange compiling material presented at the Advanced Life Support Systems Analysis Workshop in Houston, TX; March 1998. See also: Hanford AJ "Advanced Life Support System (ALSS) Study Water Recovery System." Lockheed Martin Space Mission Systems and Services, Houston, TX. Presentation to the Advanced Life Support Systems Analysis Workshop; 27 March 1998.
- Lange KE, Lunar Surface Life Support Architecture Study. ESCG-4470-09-TEAN-DOC-0172. October 12, 2009.
- Langston L. "Generic Groundrules, Requirements, and Constraints Part 1: Strategic and Tactical Planning." SPP 50261-01, Revision G. Incorporates DCN 017, National Aeronautics and Space Administration, International Space Station Program, Lyndon B. Johnson Space Center, Houston, TX; 2012.
- Larminie J, Dicks A. *Fuel Cell Systems Explained*, 2<sup>nd</sup> Edition, John Wiley and Sons, Inc., New York, NY; 2003.
- Law J. "In-Flight Carbon Dioxide Exposures and Related Symptoms: Association, Susceptibility, and Operational Implications." NASA/TP-2010-216126, NASA Johnson Space Center, June 2010.
- Law J. et al. "Relationship Between Carbon Dioxide Levels and Reported Headaches on the International Space Station." *American College of Occupational and Environmental Medicine, JOEM Volume 56, Number 5*, May 2014.
- Leach CS. "Medical Results from STS 1-4: Analysis of Body Fluids." *Aviation, Space, and Environmental Medicine*. 1983;54:S50-S54.
- Lee W-C, Duffield BE. "Power Mass Penalty Data – 2005." ESCG-4470-05-TEAN-DOC-0126A, Revision A. Engineering and Science Contract Group, Houston, TX; August 2006. Original document released in October 2005.

- Levri JA. Summary Food Data Spreadsheet. National Aeronautics and Space Administration, Ames Research Center, Moffett Field, CA; 2002. Draft as of 25 February 2002.
- Levri JA, Vaccari DA, Drysdale AE. "Theory and Application of the Equivalent System Mass Metric." SAE Paper 2000-01-2395. 30<sup>th</sup> International Conference on Environmental Systems, Toulouse, France. Society of Automotive Engineers, Warrendale, PA; 2000.
- Levri J, Ewert M, Kloeris V, Perchonok M, Peterson L, Swango B, Toerne M, Vittadini E. "Food System Trade Study for an Early Mars Mission." SAE Paper 2001-01-2364. 31<sup>st</sup> International Conference on Environmental Systems, Orlando, FL. Society of Automotive Engineers, Warrendale, PA; 2001.
- Lienhard, JH. "A Heat Transfer Textbook, Prentice-Hall, Englewood Cliffs, New Jersey, 1981
- Lin CH. "Mars Transit Habitat ECLSS." National Aeronautics and Space Administration, Lyndon B. Johnson Space Center, Houston, TX; 1997. Internal NASA presentation package from Crew and Thermal Systems Division dated April 1997. See also: Lin CH. "Mars Transit Habitat ECLSS, Initial Baseline and Trade Studies." National Aeronautics and Space Administration, Lyndon B. Johnson Space Center, Houston, TX; 1997. Internal NASA presentation package from Crew and Thermal Systems Division dated 9 December 1997.
- Lin CH. "Node 3 Peer Review." National Aeronautics and Space Administration, Lyndon B. Johnson Space Center, Houston, TX. Internal NASA presentation package from Crew and Thermal Systems Division dated January 1998.
- Lipinski RJ, et al. "Small Fission Power System for NEP." American Institute of Physics, CP608, Space Technology and Applications International Forum (STAIF); 2002.
- Littman FD. "Mars Power System Concept Definition Study." NASA CR-195420. Rockwell International Corporation, Rocketdyne Division, Canoga Park, CA; 1994.
- Liu H, Yu CY, et al. "A Conceptual Configuration of The Lunar Base Bioregenerative Life Support System Including Soil-Like Substrate For Growing Plants." *Advances In Space Research*. 2008;42:1080-1088.
- LSDB. *NASA Life Sciences Data Book*, 1<sup>st</sup> Edition. Webb Associates, Yellow Springs, OH; 1962.
- Lunar Architecture Team Phase 2 (LAT2). Phase Two Summary Report NASA Lunar Architecture Team. NASA Johnson Space Center; 9/21/2007.
- Lunsford T, Grounds, P. "Single Phase Laundry System Development." SAE paper 932092, Society of Automotive Engineers, Warrendale, PA; 1993.
- MADS. "Modeling and Analysis Data Set (MADS)." Manifest Working Group, National Aeronautics and Space Administration, Lyndon B. Johnson Space Center, Houston, TX; 2001.
- Marshburn T. "Hypercarbia." Unpublished white paper presented via lecture 1996. NASA Johnson Space Center.
- Mason LS. "A Comparison of Fission Power System Options for Lunar and Mars Surface Missions." NASA/TM-2006-214120. National Aeronautics and Space Administration, Glenn Research Center, Cleveland, OH; 2006.
- Mason LS, Rodriguez CD, McKissock BI, Hanlon JC, Mansfield BC. "SP-100 Reactor with Brayton Conversion for Lunar Surface Applications." NASA TM 105637. National Aeronautics and Space Administration, Lewis Research Center, Cleveland, OH; 1992.
- Maxwell S. (2000a) "Waste Stream Analysis for STS-99." The Boeing Company, Boeing Space Coast Operations, Kennedy Space Center, FL; 2000. Internal Boeing Document.
- Maxwell S. (2000b) "Waste Stream Analysis for STS-101." The Boeing Company, Boeing Space Coast Operations, Kennedy Space Center, FL; 2000. Internal Boeing Document.
- McBarron JW, Whitsett CE, Severin GI, Abramov IP. "Individual Systems for Crewmember Life Support and Extravehicular Activity." *Space Biology and Medicine, Volume II, Life Support and Habitability*, Sulzman FM, Genin AM, eds. American Institute of Aeronautics and Astronautics, Washington, DC; 1993.
- McGlothlin EP. "ISS Hygiene Options for the Hygiene Compartment Design Effort." LMSEAT 33276. Lockheed Martin Space Operations, Houston, TX; 2000.
- Mehos M, Lewandowski A, Symko-Davies M, Kirtz S. "Concentrating Photovoltaics: Collaborative Opportunities within DOE's CSP and PV Programs." NREL/CP-520-31143, NCPV Program Review Meeting, Lakewood, CO; October 2001. National Renewable Energy Laboratory, Golden, CO; 2001.



- Metric. "Advanced Life Support Research and Technology Development Metric – Fiscal Year 2005." NASA/CR-2006-213694. Hanford AJ. National Aeronautics and Space Administration, Lyndon B. Johnson Space Center, Houston, TX; 2006.
- Monje O. "Predicting Transpiration Rates of Hydroponically-Grown Plant Communities in Controlled Environments." PhD Dissertation, Utah State University, Logan, UT; 1998.
- Monje O, Bugbee B. "Adaptation to High CO<sub>2</sub> Concentration in an Optimal Environment: Radiation Capture, Canopy Quantum Yield and Carbon Use Efficiency." *Plant, Cell and Environment*. 1998;21:315-324.
- Morris et al. "Mössbauer Mineralogy of Rock, Soil, and Dust at Meridiani Planum, Mars: Opportunity's Journey Across Sulfate-rich Outcrop, Basaltic Sand, Dust, and Hematite Lag Deposits," *Journal Of Geophysical Research*, Vol. 111, E12S15, doi:10.1029/2006JE002791, 2006
- MSIS. "Man-Systems Integration Standards." NASA-STD-3000, Volume I, Revision B. National Aeronautics and Space Administration, Lyndon B. Johnson Space Center, Houston, TX; 1995. [Note: MSIS and NASA-STD-3000 have been superseded by NASA-STD-3001, volumes 1 & 2 and "Human Integration Design Handbook." NASA/SP-2010-3407/REV1.]
- Muller HG, Tobin G. *Nutrition and Food Processing*. AVI Publishing Company, Westport, CT; 1980.
- NASA. "Apollo 11 Lunar Landing Mission Press Kit." Release Number 69-83K, National Aeronautics and Space Administration, Washington, DC; 6 July 1969.
- NASA. "Lunar/Mars Exploration Initiative; Conceptual Design of Power Systems." JSC-24101. National Aeronautics and Space Administration, Lyndon B. Johnson Space Center, Houston, TX; 1989.
- NASA. "Environmental Control and Life Support System Architectural Control Document." SSP-30262. Preliminary Design Review Draft, National Aeronautics and Space Administration, George C. Marshall Space flight Center, Huntsville, AL; 1990.
- NASA. "Environmental Control and Life Support System Architectural Control Document." SSP-30262. Revision D, National Aeronautics and Space Administration, Space Station Freedom Program Office, Reston, VA; 1991.
- NASA. "Food for Space Flight." NASA Facts, NP-1996-07-007JSC, National Aeronautics and Space Administration, Lyndon B. Johnson Space Center, Houston, TX; 1996.
- NASA. "International Space Station Familiarization." TD9702A. National Aeronautics and Space Administration, Lyndon B. Johnson Space Center, Mission Operations Directorate, Space Flight Training Division, Houston, TX; 31 July 1998.
- NASA. "TransHab: An Inflatable Habitation Module for ISS and other Space Applications." National Aeronautics and Space Administration, Lyndon B. Johnson Space Center, Advanced Development Office, Houston, TX. Internal presentation dated April 1999.
- NASA. (2001a) "JSC Advanced Design Team; Lunar Transfer Vehicle Management Review." National Aeronautics and Space Administration, Lyndon B. Johnson Space Center, Advanced Development Office, Houston, TX. Internal presentation to management dated 08 August 2001.
- NASA. (2001b) "Manifest for ISS Assembly Flight 5A." NASA CR 5060. National Aeronautics and Space Administration, Lyndon B. Johnson Space Center, Advanced Development Office, Houston, TX; 28 February 2001.
- NASA. (2001c) "Manifest for ISS Assembly Flight 7A." NASA CR 5872. National Aeronautics and Space Administration, Lyndon B. Johnson Space Center, Advanced Development Office, Houston, TX; 22 August 2001.

NASA. "Fuel Cell Power Plants." Internet Article. National Aeronautics and Space Administration, Human Space Flight, Washington, D. C., last updated April 2002.

NASA, "International Space Station Medical Operations Requirements Documents (ISS MORD)." SSP 50260, National Aeronautics and Space Administration, Lyndon B. Johnson Space Center, Houston, TX, 2003.

NASA. "Exploration Life Support Requirements Document." JSC-65527A, National Aeronautics and Space Administration, Lyndon B. Johnson Space Center, Houston, Texas. [ELS RD (June 2008)]

NASA. "Pressurized Payloads Interface Requirements Document." SSP 57000, Revision J, National Aeronautics and Space Administration, International Space Station Program, Houston, Texas, 2009

NASA. "Exploration Life Support Baseline Values and Assumptions Document." JSC-64367 Rev B. National Aeronautics and Space Administration, Lyndon B. Johnson Space Center, Houston, TX; 2010

NASA. "Preliminary Report Regarding NASA's Space Launch System and Multi-Purpose Crew Vehicle, Pursuant to Section 309 of the NASA Authorization Act of 2010 (P.L. 111-267)."; 2011.

NASA. "Joint ECLSS Functional Strategy (JEFS) Document, Rev A." SSP-50623. National Aeronautics and Space Administration, Lyndon B. Johnson Space Center, Houston, TX; 2011.

NASA. "NASA Space Flight Human-System Standard Volume 2: Human Factors, Habitability, and Environmental Health." NASA-STD-3001, Volume 2, approved 1-10-2011.

NASA. "System Specification for the International Space Station." SSP-41000 CA, Contract Number MAPI-NNJ12GA46C, Space Station Program Office, Houston, TX; 15 March, 2013.

NASA. "NASA Space Flight Human-System Standard Volume 1, Revision A: Crew Health." NASA-STD-3001, Volume 1, Revision A, approved 7-30-2014.

NASA. HIDH - "Human Integration Design Handbook." NASA/SP-2010-3407/REV1, approved 6-5-2014.

NASA-STD-3001. (2007). Space Flight Human System Standard, Volume 1. NASA JSC, Houston, TX.

NASA. Websites: <http://www.nasa.gov/asteroidforum/> and [http://www.nasa.gov/sites/default/files/files/AsteroidRedirectMission\\_Update\\_Panel.pdf](http://www.nasa.gov/sites/default/files/files/AsteroidRedirectMission_Update_Panel.pdf) (2014).

Nelson JA, Bugbee B. (2014) "Economic Analysis of Greenhouse Lighting: Light Emitting Diodes vs. High Intensity Discharge Fixtures." PLoS ONE 9(6):e99010. doi:10.1371/journal.pone.0099010.

Niehuss KO. "Environmental Control and Life Support System (ECLSS) Mass Properties Report #17." National Aeronautics and Space Administration, George C. Marshall Space flight Center, Huntsville, AL; 2001.

Norcross J, Norsk P, Law J, Arias D, Conkin J, Perchonok M, Menon A, Huff J, Fogarty J, Wessel JH, Whitmire, S. "Effects of the 8 psia / 32% O2 Atmosphere on the Human in the Spaceflight Environment." NASA/TM -2013-217377, National Aeronautics and Space Administration, Lyndon B Johnson Space Center, Houston, TX; 2013.

NPD 8010.2 D. "Use of the SI (Metric) System of Measurement in NASA Programs." NPD 8010.2 D. National Aeronautics and Space Administration, Headquarters, Office of the Chief Engineer, Washington, DC; 14 May 2004.

NPD 8020.7G (2013) "Biological Contamination Control for Outbound and Inbound Planetary Spacecraft (Revalidated 05/17/13 w/change 1)." NPD 8020.7G, National Aeronautics and Space Administration, Headquarters, Science Mission Directorate, Washington, D. C., NASA Policy Directive, 4 p., 17 May 2013. <http://nodis3.gsfc.nasa.gov/>

NPR 8020.12D (2011) "Planetary Protection Provisions for Robotic Extraterrestrial Missions." NPR 8020.12D, National Aeronautics and Space Administration, Headquarters, Science Mission Directorate, Washington, D. C., NASA Procedural Requirements, 49 p., 20 April 2011. <http://nodis3.gsfc.nasa.gov/>

NRC. "Recommended Dietary Allowances." 10<sup>th</sup> Edition. National Research Council, National Academy Press, Washington, DC; 1989.

Parker D, Gallagher SK. "Distribution of human waste samples in relation to sizing waste processing in space." The Second Conference on Lunar Bases and Space Activities of the 21st Century, NASA Conference Publication 3166, Mendell WW, ed. National Aeronautics and Space Administration, Washington, DC. 1992;2:563-568.

Patel MR. "Photovoltaic-Battery System." Chapter 4, *Spacecraft Power Systems*, CRC Press, Inc., Boca Raton, FL; 2005.

- Perchonok MH, Stevens I, Swango BE, Toerne ME. "Advanced Life Support Food Subsystem Salad Crops Requirements." SAE Paper 2002-01-2477. 32<sup>nd</sup> International Conference on Environmental Systems, San Antonio, TX; 2002. Society of Automotive Engineers, Warrendale, PA.
- Perka A. "Lunar Outpost Technologies Breakeven Study." ESCG-4470-07-TEAN-DOC-0193; November 2007.
- Perry JL. "Trace Chemical Containment Generation Rates for Spacecraft Contamination Control System Design." NASA-TM-108497. National Aeronautics and Space Administration, George C. Marshall Space Flight Center, Huntsville, AL; 1995.
- Perry JL. (1998) "Elements of Spacecraft Cabin Air Quality Control Design." NASA-TP-1998-207978, National Aeronautics and Space Administration, George C. Marshall Space flight Center, Huntsville, Alabama, May 1998. This document is not available for general release.
- Perry, JL. "A Design Basis for Spacecraft Cabin Trace Contaminant Control." SAE paper 2009-01-2592, 39<sup>th</sup> International Conference on Environmental Systems, Society of Automotive Engineers, Savannah, GA;1999.
- Perry JL, Cole HE, El-Lessy, HN. "An Assessment of the *International Space Station*'s Trace Contaminant Control Subassembly Process Economics." NASA/TM-2005-214008. National Aeronautics and Space Administration, Marshall Space Flight Center, Huntsville, AL; 2005.
- Peterson, B.V. et al., "Characterization of Microbial and Chemical Composition of Shuttle Wet Waste with Permanent Gas and Volatile Organic Compound Analysis." Advances in space research; Volume 34, Issue 7, Pages 1470-1476, 2004.
- Piñero LR, Bond T, Okada D, Pyter J, Wiseman S. "Design of a Modular 5 kW Power Processing Unit for the Next Generation 40-cm Ion Engine." NASA/TM-2002-211359. National Aeronautics and Space Administration, Glenn Research Center, Cleveland, OH; 2002.
- Pisharody S, Wignarajah K, Fisher J. "Oxygen Penalty for Waste Oxidation in an Advanced Life Support System - A Systems Approach." SAE Paper 2002-01-2396. 32<sup>nd</sup> International Conference on Environmental Systems, San Antonio, TX; 2002. Society of Automotive Engineers, Warrendale, PA.
- Pritchett, Steven, email communication to Michael Ewert, June 3, 2014.
- Putnam DF. "Composition and Concentrative Properties of Human Urine." NASA-CR-1802. National Aeronautics and Space Administration, Washington, DC. Prepared by McDonnell Douglas Astronautics Company – Western Division, Huntington Beach, CA; 1971.
- Ray CD, Littles JW, Blair JL, Jagow RB. "Design and Development of a Trace Contaminant Removal Canister for Spacelab." ASME Paper 79-ENAs-16. American Society of Mechanical Engineers, New York, NY; 1979.
- Ray CD, Stanley JB. "Spacelab baseline ECS trace contaminant removal test program." NASA-TM-78135, National Aeronautics and Space Administration, Washington, DC; 1977.
- Reimers and McDonald. "ISS Laundry Decision Package." National Aeronautics and Space Administration. Internal NASA presentation; 23 January 1992.
- Richards JT, Edney SL, Yorio MC, Stutte GW, Sisko MD, Cranston N, Wheeler RM. "Effect of Light Intensity and Temperature on Yield of Salad Crops for Space Exploration." SAE Paper 2005-01-2820, 35<sup>th</sup> International Conference on Environmental Systems, Rome, Italy; 2005. Society of Automotive Engineers, Warrendale, PA.
- Richards JT, Edney SL, Yorio MC, Stutte GW, Wheeler RM. "Yields of Salad Crops Grown Under Potential Lunar and Mars Habitat Environments: Effect of Temperature and Lighting." SAE Paper 2006-01-2029. 36<sup>th</sup> International Conference on Environmental Systems, Norfolk, VA; 2006. Society of Automotive Engineers, Warrendale, PA.
- RMD. "Exploration Life Support Reference Missions Document." JSC 64109. Duffield BE. National Aeronautics and Space Administration, Lyndon B. Johnson Space Center, Houston, TX; 2008.
- RMD. Stafford KW, Jerng LT, Drysdale AE, Maxwell S, Levri JA. "Advanced Life Support Systems Integration Modeling and Analysis Reference Missions Document." JSC 39502A. Ewert MK, Hanford AJ, eds. National Aeronautics and Space Administration, Lyndon B. Johnson Space Center, Houston, TX; 2001.
- Roberts V. "Comparing White Light LEDs to Conventional Light Sources." U S Department of Energy; October 2008.

- Rodriguez LF, Bell S. (2004) "Verification of the Modified Energy Cascade Model – Report." National Research Council at NASA Lyndon B. Johnson Space Center, Houston, TX; 2004. Internal NASA document. Rodriguez V, England W. "Rack to Mini Pressurized Logistics Module Interface Control Document (ICD), Part 1." SSP-41017, Revision D. National Aeronautics and Space Administration, International Space Station Program, Lyndon B. Johnson Space Center, Houston, TX; 1998. Revision D was signed on 01 May 2000 and published on 10 April 2001.
- Rudisill M, et al. "Lunar Architecture Team - Phase 2 Habitat Volume Estimation: Caution When Using Analogs." ntrs.nasa.gov/archive/nasa/casi.ntrs.nasa.gov/20080013517.pdf
- Ruminsky KA, Hentges DL. "Development of a Ten-Day Cycle Menu for Advanced Life Support." *Life Support and Biosphere Science, International Journal of Earth/Space*. 2000;7:193-201.
- Santos, BM, Vallad, GE. eds. "Vegetable Production Handbook for Florida 2013-2014." Institute of Food and Agricultural Services, University of Florida, 2013.
- Schoppa W. "ITCS Fluids White Paper." HDID-A44B-827. Lockheed Martin Space Mission Systems and Services, Houston, TX; 1997.
- Schubert FH, Wynveen RA, Quattrone, PD. "Advanced Regenerative Environmental Control and Life Support Systems: Air and Water Regeneration," *Advances in Space Research*. 1984;4:279-288.
- Shultz D, Broyan J. "FY 2009 Technology Development Plan for Habitat Lighting with LEDs."; 2009.
- Smith SM, et al. "Space Flight Calcium: Implications for Astronaut Health, Spacecraft Operations, and Earth." *Nutrients* 2012, 4, 2047-2068, [www.mdpi.com/journal/nutrients](http://www.mdpi.com/journal/nutrients).
- Smith SM, et al. "Fifty Years of Human Space Travel: Implications for Bone and Calcium Research." *Annu. Rev. Nutr.* 2014. 34:377–400, <http://www.annualreviews.org/journal/nutr>.
- SODB. "Shuttle Operational Data Book, Volume II, Mission Mass Properties." NSTS-08934, Volume II, Revision C. Mistrot JW, ed. National Aeronautics and Space Administration, Lyndon B. Johnson Space Center, Houston, TX; 1995.
- Spry JA. (2013) "RE: What are Planetary Protection Guidelines for Human Missions to Mars?" National Aeronautics and Space Administration, Jet Propulsion Laboratory, Pasadena, California, Private communication (electronic mail), 14 August 2013 at 5:29 p.m.
- Sridhar KR, Finn J, Kliss M. "ISRU Technologies for Mars Life Support." The University of Arizona in Tucson, AZ, and the National Aeronautics and Space Administration, Ames Research Center, Moffett Field, CA. Presentation to the Advanced Life Support Systems Analysis Workshop, 27 March 1998.
- Tikhomirov AA, Ushakova SA, et al. "Mass Exchange in an Experimental New-Generation Life Support System Model Based on Biological Regeneration of Environment." *COSPAR*, 2003;31, No.7:1711-1720.
- Tomasko LR, Doose M, Lemmon PH, Smith E, Wegryn. "Properties of dust in the Martian atmosphere from the Imager on Mars Pathfinder." Article first published online: 21 SEP 2012 DOI: 10.1029/1998JE900016 *Journal of Geophysical Research: Planets* (1991–2012) Volume 104, Issue E4, pages 8987–9007, 25 April 1999.
- Toups, L and Kennedy, K. "Constellation Architecture Team-Lunar Habitation Concepts." AIAA 2008-7633, Space Conference & Exposition, 2008.
- Toups L, Shepherd C, Fawcett M, DiPalermo P, Winter J. "Crew Refrigerator Freezer Rack RFR." V6.0. National Aeronautics and Space Administration, Lyndon B. Johnson Space Center, Houston, TX. Internal NASA technical interchange meeting package; 17 April 2001.
- Tri TO. "Scoping Document for the BIO-Plex 120-Day Test." Revision D. National Aeronautics and Space Administration, Lyndon B. Johnson Space Center, Houston, TX. Internal NASA document dated 03 October 2000.
- Tripathi RK, Wilson JW, Cucinotta FA, Nealy JE, Cloudsley MS, Yk Kim MH. "Deep Space Mission Radiation Shielding Optimization." 01ICES-2326; 2001.
- Tucker D, Sandstead H, Logan G Jr, Klevay L, Mahalko J, Johnson L, Inman L, Inglett G. "Dietary fiber and personality factors as determinants of stool output." *Gastroenterology*. 1981;81:879-883.
- Tucker JM. "HSIR Action to ECP to provide Sensible Heat Data, Respiratory Exchange Data, and Water Production Data For an Exercising Crew Member." National Aeronautics and Space Administration, Lyndon B. Johnson Space Center, Houston, TX Internal NASA technical memorandum; June 2006.

- UN (1967) "Treaty on Principles Governing the Activities of States in the Exploration and Use of Outer Space, Including the Moon and Other Celestial Bodies." United Nations, 27 January 1967.
- Verostko CE, "Development of Ersatz Formulations of Wastewater Streams Generated In Spacecraft Closed Life Support Systems" Bioastronautics TM No. LMBIO-TM09-097, December 2009.
- Verostko CE, Carrier C. "Ersatz Formulations for Testing Water Recovery System Processes." JSC 65336 (CTSD-ADV-612). National Aeronautics and Space Administration, Lyndon B. Johnson Space Center, Houston, TX; 2006.
- Verostko CE, Garcia R, Sauer R, Reysa RP, Linton AT, Elms T. "Test Results on Reuse of Reclaimed Shower Water – A Summary." Paper SAE 891443. 19<sup>th</sup> Intersociety Conference on Environmental Systems, San Diego, CA; 1989. Society of Automotive Engineers, Warrendale, PA.
- Villarreal J. Crew Exploration Vehicle (CEV) Crewed Stowage Assessment White Paper and Spreadsheet. Engineering Directorate, Crew and Thermal Systems Division. JSC 65238, CTSD-ADV-586, April 2006 National Aeronautics and Space Administration Lyndon B. Johnson Space Center Houston, TX; 2006.
- Volk T, Bugbee B, Wheeler R. "An Approach to Crop Modeling With the Energy Cascade." *Life Support and Biosphere Science, International Journal of Earth/Space*. 1995;1:119-127.
- Volk T, Rummel JD. "Mass Balances for a Biological Life Support System Simulation Model." *Adv, Space Res.* 1987; Vol 7, No. 4: (4)141-(4)148. Dept. of Applied Science, New York University for NASA Ames Research Center.
- Vonau WL Jr. "Examination of Study on Equivalent System Mass for Advance Refrigerator Technologies." MSAD-02-0115. Lockheed Martin Space Operations, Houston, TX; 2002.
- Wagner SA. "The Apollo Experience Lessons Learned for Constellation Lunar Dust Management." NASA/TP-2006-213726, Johnson Space Center, TX, 2006
- Wagner SA. "An Assessment of Dust Effects on Planetary, Surface Systems to Support Exploration Requirements." NASA/ TM-2008-213722, NASA Johnson Space Center, Houston, Texas 77058, December 2008.
- Wagner SA. "Asteroid, Lunar and Planetary Regolith Management: A Layered Engineering Defense." NASA/TP-2014-217399, August, 2014.
- Weast RC, Astle MJ. *CRC Handbook of Chemistry and Physics*. 94<sup>th</sup> Edition. CRC Press, Inc., Boca Raton, FL; 2013.
- Weaver GS, Westheimer DT. "Advanced Radiator Concepts and Carbon Velvet Cold Plate Thermal/Vacuum Test Post-Test Report." JSC-47823 (CTSD-ADV-485). National Aeronautics and Space Administration, Lyndon B. Johnson Space Center, Houston, TX; 2002.
- Wheeler RM. (2001a) National Aeronautics and Space Administration, John F. Kennedy Space Center, Kennedy Space Center, FL. From comments during an ALS project telecon, January 2001.
- Wheeler RM, Corey KA, Sager JC, Knott WM. "Gas Exchange Characteristics of Wheat Stands Grown in a Closed, Controlled Environment." *Crop Science*. 1993;33:161-168.
- Wheeler RM, Mackowiak CL, Berry WL, Stutte GW, Yorio NC, Ruffe LM. "Ten Years of Hydroponic Research in NASA's CELSS Biomass Production Chamber." Proceedings of the 18<sup>th</sup> Annual Conference, Hydroponic Society of America. 1997:103-113.
- Wheeler RM, Mackowiak CL, Berry WL, Stutte GW, Yorio NC, Ruffe LM, Sager JC. "Nutrient, acid, and water budgets of hydroponically grown crops." *Acta Horticulturae*. 1999;481:655-661.
- Wheeler RM, Mackowiak CL, Sager JC, Knott WM, Berry WL. "Proximate Composition of CELSS Crops Grown in NASA's Biomass Production Chamber." *Advances in Space Research*. 1996; 18 (4/5):43-47.
- Wheeler RM, Mackowiak CL, Stutte GW, Sager JC, Yorio NC, Ruffe LM, Fortson RE, Dreschel TW, Knott WM, Corey KA. "NASA's Biomass Production Chamber: A Testbed for Bioregenerative Life Support Studies." *Advances in Space Research*. 1995;18:215-224.
- Wheeler RM, Mackowiak CL, Stutte GW, Yorio NC, Ruffe LM, Sager JC, Knott WM. "Crop Production Data for Bioregenerative Life Support: Observations from NASA's Kennedy Space Center." COSPAR Abstract F4.1-0010-06, Committee on Space Research, International Council for Science, Paris, France; 2006.

- Wheeler RM, Sager JC, Prince RP, Knott WM, Mackowiak CL, Stutte GW, Yorio NC, Ruffe LM, Peterson BV, Goins GD, Hinkle CR, Berry WL. "Crop Production for Advanced Life Support Systems – Observations from the Kennedy Space Center Breadboard Project." NASA-TM-2003-211184. National Aeronautics and Space Administration, John F. Kennedy Space Center, FL; 2003.
- Wieland PO. (1998a) "Living Together in Space: The Design and Operation of the Life Support Systems on the International Space Station." Volume 1, NASA-TM-1998-206956. National Aeronautics and Space Administration, Marshall Space Flight Center, Huntsville, AL; 1998.
- Wieland PO. (1998b) "Living Together in Space: The Design and Operation of the Life Support Systems on the International Space Station." Volume 2, NASA-TM-1998-206956. National Aeronautics and Space Administration, Marshall Space Flight Center, Huntsville, AL; 1998.
- Wignarajah K, et al. "Simulated Human Feces for Testing Human Waste Processing Technologies in Space Systems." ICES 2006-01-2180.
- Williams DR. National Space Science Data Center. National Aeronautics and Space Administration, Goddard Space Flight Center, Greenbelt, MA; 1997.
- Winter J, Zell M, Hummelsberger B, Hess MP, Eicher L, DiPalermo P, Savage Ch, Tan G, Cassese F, Santachiara D, Deceuninck H, Townsend P, Kutch M, Renz M, Rapp U. "The Crew Refrigerator/Freezer Rack for the International Space Station." SAE paper 2001-01-2223. 31<sup>st</sup> International Conference on Environmental Systems. Society of Automotive Engineers, Warrendale, PA; 2001.
- Wong KL. "Carbon Dioxide. In: Spacecraft Maximum Allowable Concentrations for Selected Airborne Contaminants." National Academy Press, Washington, DC; 1996;2:105-187.
- Wydeven T, Golub MA. "Generation Rates and Chemical Compositions of Waste Streams in a Typical Crewed Space Habitat." NASA Technical Memorandum 102799. National Aeronautics and Space Administration, Ames Research Center, Moffett Field, CA; 1990.
- Wydeven T, Golub MA. "Waste Streams in a Crewed Space Habitat." *Waste Management and Research*. 1991;9:91-101
- Wydeven T, Tremor J, Koo C, Jacquez R. "Sources and Processing of CELSS Wastes." *Adv. Space Res.* 1989; 9, No. 8:85-97.
- Yam YC. "Clinical Applications of Oxygen Therapy in Hospitals and Techniques of Oxygen Administration." *Journal of the Hong Kong Medical Association*. December 1993; Vol. 45, No. 4.

## 6 APPENDICES

### 6.1 APPENDIX A - ACRONYMS AND ABBREVIATIONS<sup>212</sup>

Symbol	Definition	Symbol	Definition
AES	Advanced Exploration Systems	LAT	Lunar Architecture Team
ALS	Advanced Life Support	LED	light-emitting diode
ALS RD	ALS Requirements Document	LER	Lunar Electric Rover
Areal Density	Two dimensional distribution of mass g/cm <sup>2</sup>	LL	Lunar Lander
ATCS	active thermal control system	LMLSTP	Lunar Mars Life Support Test Program (integrated test)
BDB	Bioastronautics Data Book	LO	Lunar Orbiter
BGI	Bubble Growth Index	MAG	Maximum Absorption Garment
BIO-Plex	<u>Bioregenerative Planetary Life Support Systems Test Complex</u>	MEC	Modified Energy Cascade
BPC	Biomass Production Chamber	MSIS	Man-Systems Integration Standards
BVAD	Baseline Values and Assumptions Document	MW	molecular weight or Megawatt if used as a unit (See below.)
CH <sub>4</sub>	methane	n/a	not applicable
CI	controlled inorganic (compound)	NASA	National Aeronautics and Space Administration
CM	Number of crew or crewmembers	NH <sub>3</sub>	ammonioa
CO	carbon monoxide	NIOSH	National Institute for Occupational Safety and Health
CO <sub>2</sub>	carbon dioxide	NRC	National Research Council
COP <sub>s</sub>	overall system thermodynamic coefficient of performance	O <sub>2</sub>	oxygen
COTS	Commercial off-the-shelf	OSHA	Occupational Health and Safety Administration
CQ	crew quarters	PAR	photosynthetically active radiation
CTMP	crewtime-mass-penalty [kg/CM-h]	PCM	Pressurized Core Module
CTSD	Crew and Thermal Systems Division	PEM	Pressurized Excursion Module
CxP	Constellation Program	p[gas]	partial pressure exerted by gas
DC	direct current	pH	potential of hydrogen
DCS	decompression sickness	PLM	Pressurized Logistics Module
dw	dry mass (dry “weight”)	PLSS	portable life support system
EATCS	external active thermal control system	ppCO <sub>2</sub>	partial pressure of carbon dioxide

<sup>212</sup>Symbols specific to the crop models in Section 4.14.1.6 are defined in Table 4.105 and Table 4.117.

Symbol	Definition	Symbol	Definition
ECLSS	Environmental Control and Life Support System	PPF	photosynthetic photon flux
ELS	Exploration Life Support (Project)	PUP	portable utility palette
EMC	Environmental Monitoring and Control	PV	Photovoltaic
EMU	extravehicular mobility unit	QD	quick disconnect
ESAS	Exploration Systems Architecture Study	RDA	Recommended Dietary Allowance
ESCG	Engineering and Sciences Contract Group	RMD	Reference Missions Document
ESM	equivalent system mass	R <sub>s</sub>	system composite thermal resistance
ESM GD	ESM Guidelines Document	SCC	source contamination control
ETCS	external thermal control system	SI	Système Internationale d'Unités (Metric System)
EVA	extravehicular activity	SIMA	Systems Integration, Modeling, and Analysis (element of ELS Project)
ffm	frozen food mass	SMAC	spacecraft maximum allowable concentration
fw	fresh mass (fresh "weight")	SODB	Shuttle Operational Data Book
HNO <sub>3</sub>	nitric acid	SP100	type of nuclear reactor
HPS	high pressure sodium, a type of lamp	STS	Space Transportation System
HTV	H-II Transfer Vehicle	SVChp	solar vapor-compression heat pump
IBD	Individual breathing device	TBD	to be determined
ISLE	In Situ Light Exercise	TCB	total crop biomass
ISRU	in-situ resource utilization	TCC	trace contamination control
ISS	International Space Station	TEB	total edible biomass
IST	Invariantly-Scheduled Time	TOC	total organic carbon
ITCS	internal thermal control system	TRRJ	thermal radiator rotary joint
IUPAC	International Union of Pure and Applied Chemistry	USOS	United States On-orbit Segment
IVA	intra vehicular activity	VO <sub>2 max</sub>	maximal rate of oxygen uptake by the whole-body during exercise
I/X	ion exchange	VST	Variably-Scheduled Time
JCPC	Joint Crew Provisioning Catalog	$\hat{W}_{RF}$	specific power consumption for a cooled volume within a cabinet
JSC	Johnson Space Center	WMS	Waste Management System
KSC	Kennedy Space Center	WRS	Water Recovery System



## 6.2 APPENDIX B - ABBREVIATIONS FOR UNITS

Symbol	Actual Unit	Physical Correspondence
BTU	British thermal unit	energy (English)
°C	degrees Centigrade	temperature
CM	crewmember	person
CM-d	crewmember-days	crewtime
CM-h	crewmember-hours	crewtime
CM-wk	crewmember-week	crewtime
CM- $\phi$	crewmember-menstrual period	crewtime
c	centi-	prefix
d	day	time
°F	degrees Fahrenheit	temperature (English)
ft	foot	length (English)
g	gram	mass
H	hour	Time
Ht	height	length
IU	international unit	see specific usage
J	joule	energy
K	kelvin	absolute temperature
k	kilo-	prefix
kW	kilowatt	power
kW <sub>e</sub>	kilowatt electric	electric power
kW <sub>th</sub>	kilowatt thermal	thermal heat
L	liter	volume
lb <sub>m</sub>	pounds (mass)	mass (English)
M	mega-	prefix
MW <sub>e</sub>	megawatt electric	electric power
m	meter	length
m <sup>2</sup>	square meter	area
m <sup>3</sup>	cubic meter	volume
m	milli-	prefix
meq/L	milli-equivalents per liter	concentration
min	minute	time
mm Hg	millimeters of mercury	mole
mol	mole	
N	newton	force
Pa	pascal	pressure
ppm	parts per million	concentration
psia	pounds (force) per square inch, absolute	absolute pressure (English)
S	siemens	conductivity
s	second	time
W	watt	power
wk	week	time
y	year	time
μ	micro-	Prefix

REPORT DOCUMENTATION PAGE			Form Approved OMB No. 0704-0188	
Public reporting burden for this collection of information is estimated to average 1 hour per response, including the time for reviewing instructions, searching existing data sources, gathering and maintaining the data needed, and completing and reviewing the collection of information. Send comments regarding this burden estimate or any other aspect of this collection of information, including suggestions for reducing this burden, to Washington Headquarters Services, Directorate for Information Operations and Reports, 1215 Jefferson Davis Highway, Suite 1204, Arlington, VA 22202-4302, and to the Office of Management and Budget, Paperwork Reduction Project (0704-0188), Washington, DC 20503.				
1. AGENCY USE ONLY (Leave Blank)	2. REPORT DATE March 2015	3. REPORT TYPE AND DATES COVERED Technical Publication		
4. TITLE AND SUBTITLE Life Support Baseline Values and Assumptions Document			5. FUNDING NUMBERS	
6. AUTHOR(S) Molly S. Anderson; Michael K. Ewert; John F. Keener; Sandra A. Wagner				
7. PERFORMING ORGANIZATION NAME(S) AND ADDRESS(ES) Lyndon B. Johnson Space Center Houston, Texas 77058			8. PERFORMING ORGANIZATION REPORT NUMBERS S-1185	
9. SPONSORING/MONITORING AGENCY NAME(S) AND ADDRESS(ES) National Aeronautics and Space Administration Washington, DC 20546-0001			10. SPONSORING/MONITORING AGENCY REPORT NUMBER TP-2015-218570	
11. SUPPLEMENTARY NOTES				
12a. DISTRIBUTION/AVAILABILITY STATEMENT Unclassified/Unlimited Available from the NASA Center for AeroSpace Information (CASI) 7115 Standard Hanover, MD 21076-1320 Category: 54			12b. DISTRIBUTION CODE	
13. ABSTRACT (Maximum 200 words) The Baseline Values and Assumptions Document (BVAD) provides analysts, modelers, and other life support researchers with a common set of values and assumptions that can be used as a baseline in their studies. This baseline, in turn, provides a common point of origin from which many studies in the community may depart, making research results easier to compare and providing researchers with reasonable values to assume for areas outside their experience. With the ability to accurately compare different technologies' performance for the same function, managers will be able to make better decisions regarding technology development. The BVAD identifies specific physical quantities that define life support systems from an analysis and modeling perspective. For each physical quantity so identified, the BVAD provides a nominal or baseline value and often provides a range of possible or observed values. Finally, the BVAD documents each entry with a description of the quantity's use, value selection rationale, and appropriate references. The baseline values listed in the BVAD are designed to provide defaults for those quantities within each study that are not of particular interest for that study and may be adequately described by default values.				
14. SUBJECT TERMS life support systems; subsystems; environments; environmental control; systems integration; exploration			15. NUMBER OF PAGES 220	16. PRICE CODE
17. SECURITY CLASSIFICATION OF REPORT Unclassified	18. SECURITY CLASSIFICATION OF THIS PAGE Unclassified	19. SECURITY CLASSIFICATION OF ABSTRACT Unclassified	20. LIMITATION OF ABSTRACT Unlimited	



---