

Ultrasonic Method for Deployment Mechanism Bolt Element Preload Verification

Eric C. Johnson*, Yong M. Kim*, Fred A. Morris**, Joel Mitchell** and Robert B. Pan*

Abstract

Deployment mechanisms play a pivotal role in mission success. These mechanisms often incorporate bolt elements for which a preload within a specified range is essential for proper operation. A common practice is to torque these bolt elements to a specified value during installation. The resulting preload, however, can vary significantly with applied torque for a number of reasons. The goal of this effort was to investigate ultrasonic methods as an alternative for bolt preload verification in such deployment mechanisms. A family of non-explosive release mechanisms widely used by satellite manufacturers was chosen for the work. A willing contractor permitted measurements on a sampling of bolt elements for these release mechanisms that were installed by a technician following a standard practice. A variation of ~ 50% ($\pm 25\%$) in the resultant preloads was observed. An alternative ultrasonic method to set the preloads was then developed and calibration data was accumulated. The method was demonstrated on bolt elements installed in a fixture instrumented with a calibrated load cell and designed to mimic production practice. The ultrasonic method yielded results within $\pm 3\%$ of the load cell reading. The contractor has since adopted the alternative method for its future production.

Introduction

What was accomplished here was the adaptation of ultrasonic methodology to assist with the proper installation of satellite deployment mechanisms. The effort was focused on the Frangibolt® family of non-explosive actuators marketed by TiNi Aerospace, Inc. [1] These actuators consist of a Shape Memory Alloy (SMA) core that is encased in a heater as depicted in Figure 1. The SMA core is hydraulically compressed prior to installation. A bolt element, tightened to a specified preload, is passed through the SMA core to secure the component that will eventually be deployed. The bolt elements have a notch somewhere along the length. Actuation occurs when the heater is turned on causing the SMA core to

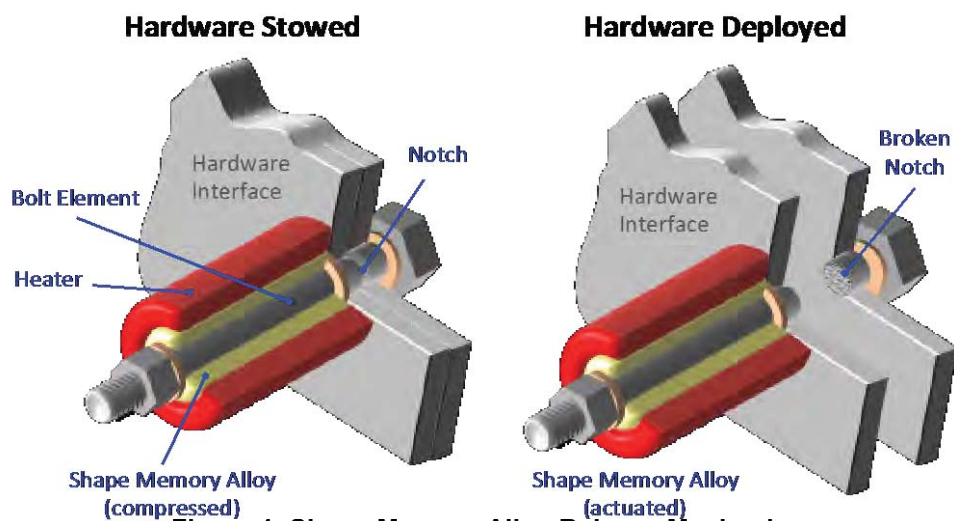

Figure 1. Shape Memory Alloy Release Mechanism

* The Aerospace Corporation, Los Angeles, CA

** Lockheed Martin Space Systems Company, Littleton, CO

return to (i.e., remember) its uncompressed state, which stretches the bolt element causing it to break at the notch. These ingenious devices are heavily used in a number of satellite programs for deployment of a wide variety of stowed appendages including solar panels, antennae, cover doors, and various payloads. Other uses include latches that lock hinges after deployment and deployment boom restraints.

If the preload is set low for a Frangibolt[®] release mechanism, it can result in a failure to develop fracture load levels in the bolt element, even after the SMA has fully stroked. Given the ramifications associated with a fouled release, bolt element preloads should be carefully set and verified. The most commonly used and easiest approach to setting preloads is to use a torque wrench to tighten the bolt element to a specified value. Unfortunately, the literature [2,3] indicates that preloads set by this method can vary by as much as 50% ($\pm 25\%$). Clearly, a preload verification method more accurate than the standard practice of torque specification is needed. Other options in rough order of increased accuracy, include (1) keeping track of the angular turns of the nut, (2) use of load indicating washers, (3) bolt elongation measurements, and (4) the use of strain gauges or ultrasonic measurements. Ultrasonic Time-of-Flight (TOF) measurements can be used to set preloads with an accuracy of $\pm 1\%$ for fasteners of simple geometry. The bolt elements in Frangibolt[®] actuators, a sampling of which are depicted in Figure 2, are notched, and can have various head designs, lengths and diameters, depending on the application. In addition, use of ultrasonic instruments generally requires more knowledge than use of a torque wrench. The challenge for this work was to develop a methodology that would overcome these hindrances and prove effective on the shop floor.

Proof-of-Concept Testing

The key to the ultrasonic approach [4,5] is to accurately measure changes in the Time-of-Flight (TOF) of ultrasonic pulses within the bolt elements as they are loaded. The basic concept is depicted in Figure 3 where the signal traces for two bolt element designs are presented. A small ultrasonic transducer is used to propagate a pulse within the bolt. The pulse traverses the bolt and reflects back to the transducer from features like the notch, thread and end of the bolt. The resulting signal (echo train) can be examined to see how the TOF of an echo changes when the bolt is loaded through tightening.

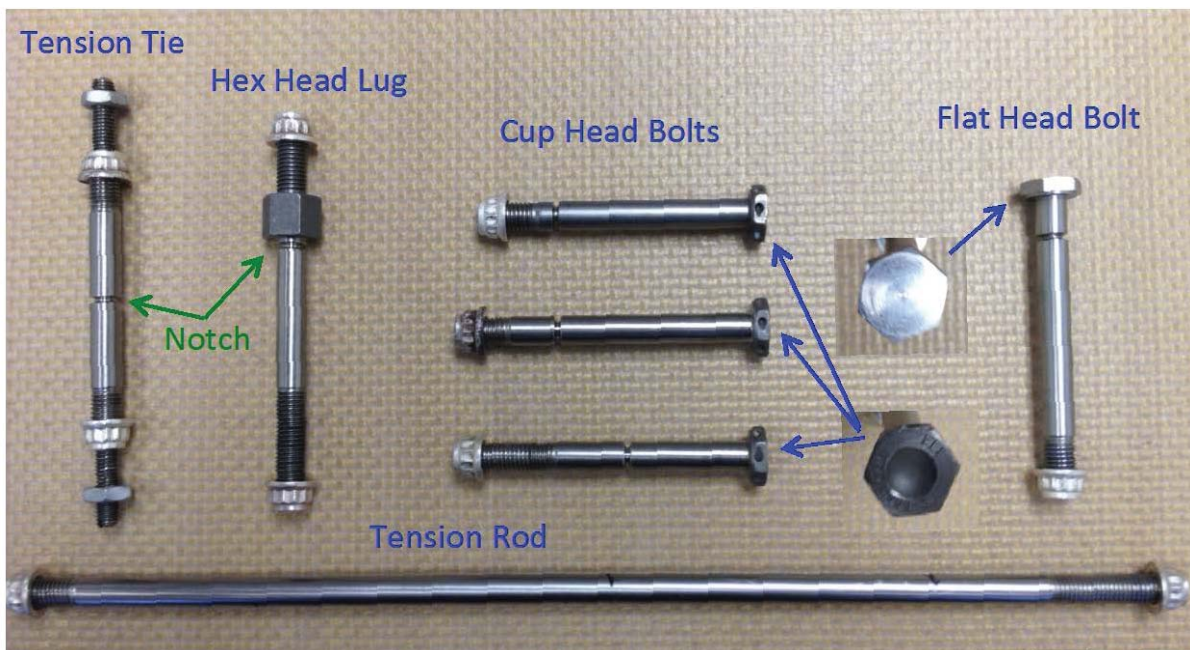

Figure 2. Titanium bolt elements tested in this study.

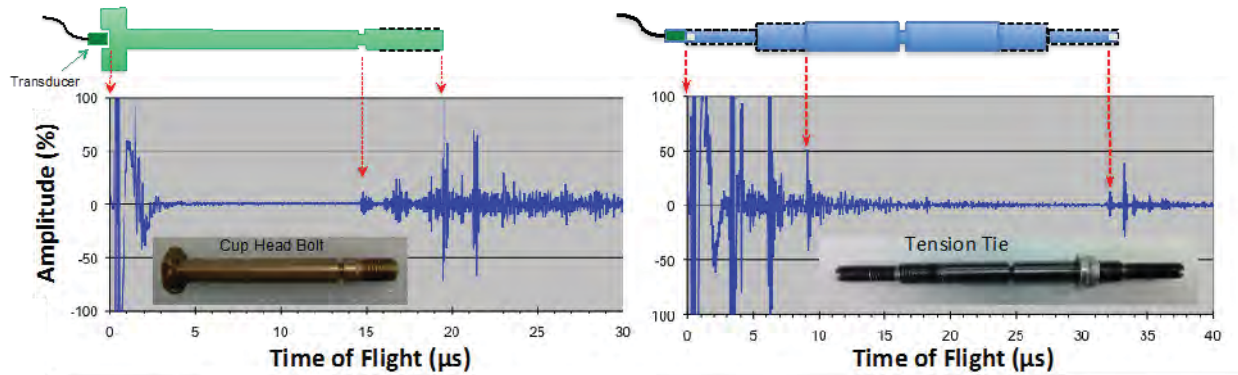

Figure 3. Basic Concept for using ultrasonic TOF measurements to determine bolt preloads. Dotted lines indicate threaded shaft. Depicted are typical signal traces from unloaded bolt elements. Amplitude units are % of full screen height.

Measurement System

The laboratory system used to perform TOF measurements consisted of a transducer, Panametrics 5052 PRX pulsar-receiver and LeCroy LT354 (1.0 GHz) digitizing scope and, for the purposes of this paper, will be referred to as the “Lab System.” Depending on the application, a selection of flat-faced, contact, ultrasonic transducers from common manufacturers were used with diameters between 3.2 – 6.6 mm ($1/8$ – $1/4$ in) and resonant frequencies from 5 – 15 MHz. Generally, broadband (fast rise-time) probes yield a more definitive time measurement. Several methods for coupling of the ultrasonic transducer to the bolt were examined for repeatability. For all, a drop of deionized water or oil provided a sufficient medium for coupling the sound from the transducer into the bolt. The bolt elements used in this study were comprised of titanium and had a 3.3 mm ($1/4$ inch) diameter main shaft with threaded portions. For some a sensor could simply be coupled to a threaded end through clever use of a magnet and nut as depicted in top photographs of Figure 4. For those where the head was flat, it was enough to just hold the transducer against the head. One heavily used design, however, had a forged head that was cupped. The difficulty encountered in hand-coupling an ultrasonic transducer to these bolt elements in a consistent fashion presented itself as a major problem to be solved. In the end, success was achieved with a custom spring-loaded sensor as depicted in the lower photographs in Figure 4 and Cross-Correlation Processing Scheme (CCPS) to combat operator induced signal variations.



Figure 4. Methods for attaching an ultrasonic transducer to the bolt elements. In the top photographs the magnets are attracted to the nut that is threaded to pull the sensor against the end of the bolt element. The spring-loaded sensor in the bottom photograph is manually pressed against the bolt head.

Cross-Correlation Processing Scheme

The CCPS method is worthy of additional discussion as it was found to be quite effective and could likely prove useful for a number of other field test methods where hand-held sensors are employed. To determine the change in TOF, the signal before the bolt is loaded is subtracted from that after load. The TOF change can be relatively small so that distortions in the shape of the pulse entering the bolt can lead to significant errors. Even when using the custom spring-loaded sensor, small differences in the way the operator holds the sensor can lead to noteworthy changes in the shape of the pulse and subsequent echoes. Consequently, to get the best measurement on a loaded bolt, the operator needs to hold the transducer so as to produce a pulse as similar as possible to that attained for the measurement on the unloaded bolt. Figure 5 illustrates the concept behind the Cross-Correlation Processing Scheme. In essence, while the probe is being held on the loaded bolt, the signal undergoes variations due to inherent instabilities in the way the probe is held. With the CCPS, this changing signal is continuously monitored and compared with the original signal before load until a good match occurs at which point, the signal is saved for further processing. To illustrate the CCPS, three signals from measurement on the same loaded bolt are depicted in Figure 5 and labeled a, b and c. Each of these signals is compared to the reference signal captured on the bolt before the load was applied. The mismatch, M , defined as the percent Root Mean Square (RMS) difference, between the two signals is then calculated. The lower M , the better the match. In Figure 5, the signal labeled (a) is the best match. Once the best signal is chosen, a cross-correlation function is used to accurately determine the TOF change, Δt , due to loading of the bolt.

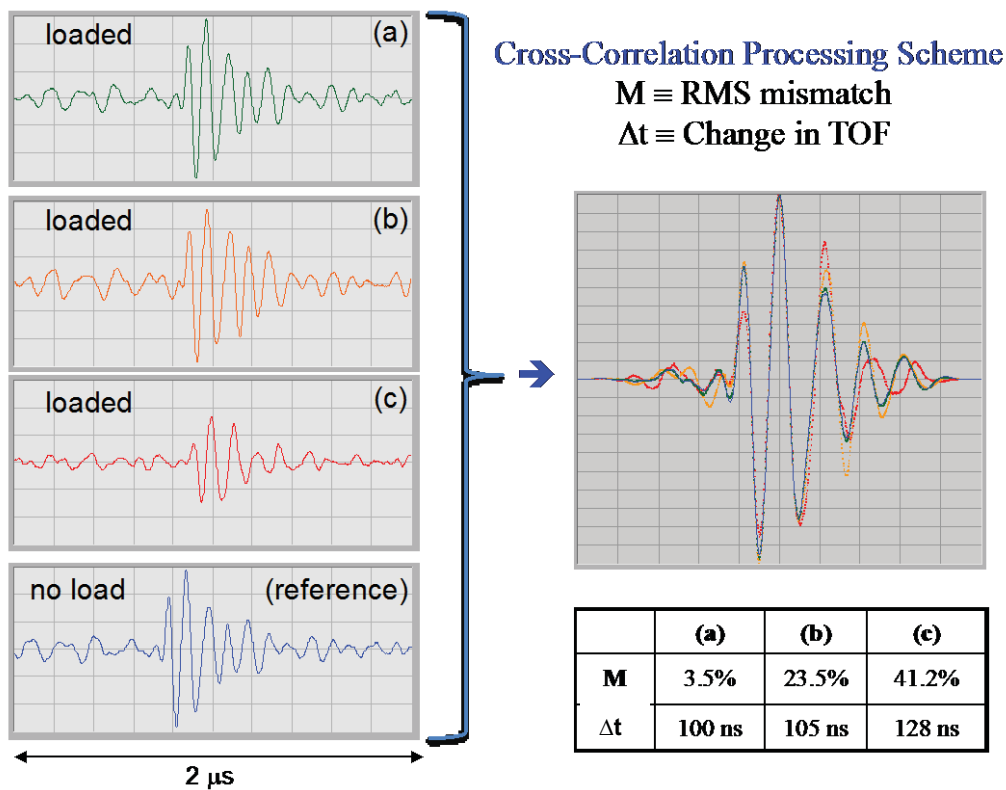

Figure 5. CCPS Illustration. Three end echo signals with the transducer held a little differently each time were captured on the same loaded bolt and labeled a, b, and c. Pictured is a 2 μ s window zoom from the entire echo train. These signals were compared to the reference to calculate M and Δt . Signal (a) was the best match.

Load Frame Tests

With a laboratory TOF measurement system in place and a means for coupling transducers established, several cup head bolts were instrumented with strain gauges and mounted in a load frame for tension

testing. The bolt end was found to be the choice reflector for the measurements. The notch deforms with load, which results in echo distortions that are more pronounced in the later portions of the echo train. As a result, monitoring the TOF of the earliest maximum (or minimum) in the echo from the bolt end was found to produce the most reliable results. Sample results for the bolt end echo are presented in Figure 6. By presenting the TOF data as in terms of fractional change, they can be plotted with the same abscissa and ordinate as the strain data. As indicated in the figure, two major factors contribute linearly, in first order, to the TOF changes with load: (1) acoustic velocity variations with strain [6] and (2) lengthening of the bolt. The TOF data for the echo from the end of the notch was subtracted from that at the beginning of the notch to isolate the fractional TOF change within the notch itself. The results are plotted in Figure 7. The data revealed that the TOF fractional change with load within the notch was ~ 7.8 times that of the body of the bolt. The ratio of the bolt body radius to that of the notch was 1.7. One would expect the ratio of strain in each region to go as the square of the radius ratio, or 2.9. Were the velocity change in the notch equivalent to the average for the whole bolt observed in Figure 6, the TOF change in the notch would have been $(0.05/0.04 + 1) \times 2.9 = 6.5$ times that of the bolt body, a little short of the observed 7.8 value. The difference likely reflects the fact that the velocity change was larger within the more highly strained notch material. There is also evidence of a subtle slope inflection near 10,675-N (2400-lb) load suggestive of some plastic deformation in the notch. This inflection was confirmed for multiple tensile test runs of the bolt.

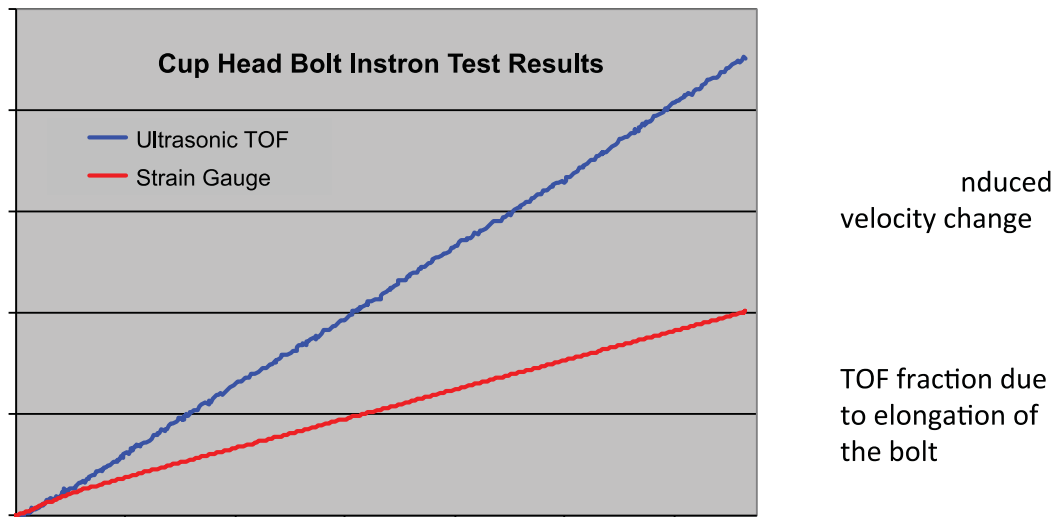

Figure 6. Load frame test results for a cup head bolt.

Torque Tests

Several unused cup head bolts and bolt elements of a different design dubbed, hex head lugs, were then mounted in a fixture with a load washer and tightened with a torque wrench. At load points, determined from the load washer, ultrasonic TOF measurements were performed. The torque test results are plotted in Figure 8 and can be seen to compare favorably with the load frame results.

Site Visit I

The above results were presented to a contractor who makes extensive use of Frangibolt® actuators in their product line. This resulted in an opportunity to perform TOF measurements at the contractor facility for a sampling of bolt elements installed by a technician on mock hardware using a standard procedure which included a specific method for pre-lubrication of the bolt threads. A load washer with a digital readout was included in the installation. The test results are presented in Figure 9. As expected, the TOF changes scaled linearly with the preload readings from the load washer. The slope for the two bolt

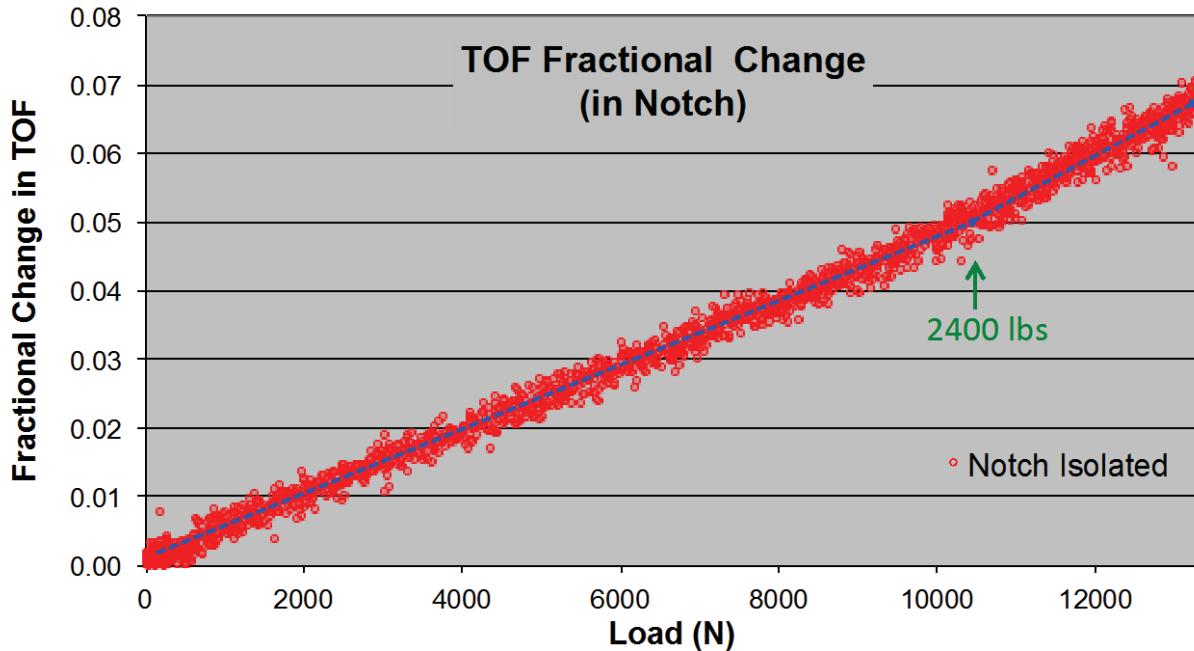

Figure 7. Fractional change in TOF for the notch.

element types is slightly different because the loaded lengths were not the same. The bolt-to-bolt preloads varied by $\pm 25\%$ about the mean for bolts tightened to the same torque, which is consistent with literature reports, but higher than the contractor anticipated, given their carefully controlled installation procedure. The contractor specification called for an accuracy of ± 222 N (50 lb) for a nominal 13,344-N (3000-lb) preload (e.g., $\pm 1.6\%$), not the low to high variation of over 4,448 N (1000 lb) observed here. In response, the specification was relaxed to require a method providing $\pm 10\%$ accuracy, which would still yield a substantial improvement over what was observed in these tests.

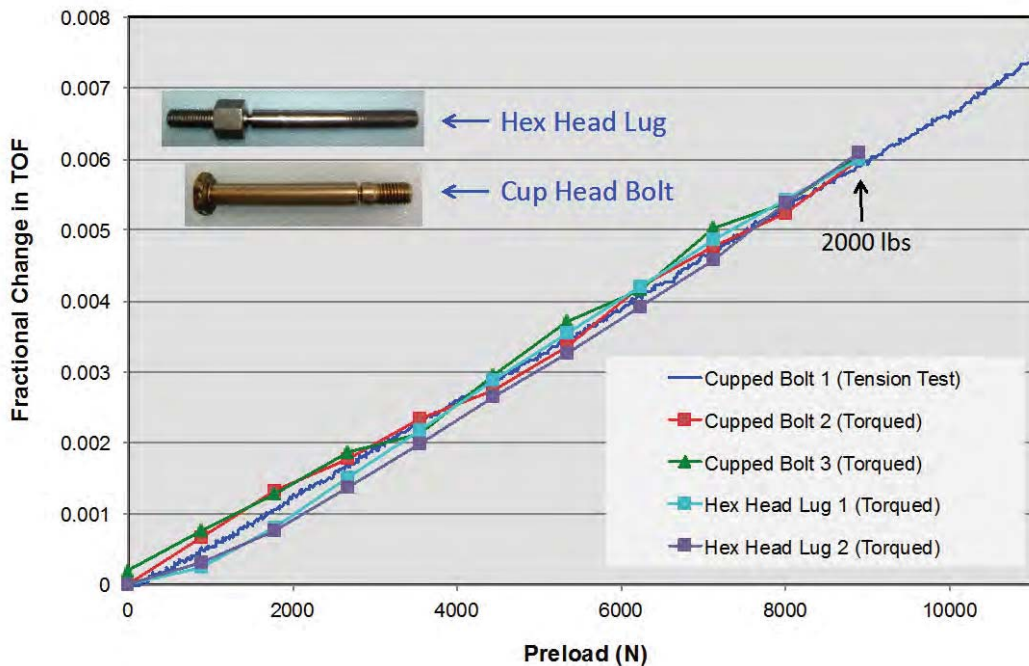
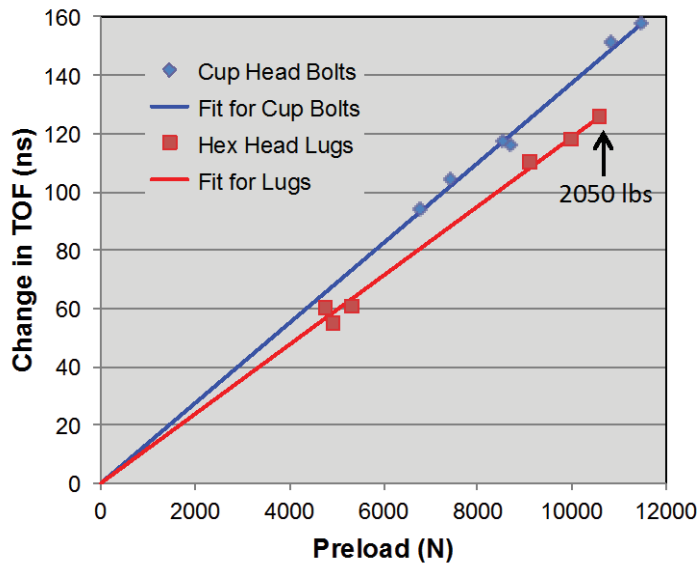

Figure 8. Comparison of load frame results with those from bolts that were tightened with a torque wrench. A load washer was incorporated into the fixture to measure the preload.



Cup Head Bolts

ID	Torque (N-m)	Torque (in/lbs)	Load (N)	Δt (ns)
Bolt A, Trial 1	5.31	47	7429	104
Bolt A, Trial 2	5.65	50	8687	116
Bolt A, Trial 3	5.65	50	8523	117
Bolt B, Trial 1	5.65	50	10845	151
Bolt B, Trial 2	5.65	50	11485	158
Bolt C, Trial 1	5.65	50	6792	94

Hex Head Lugs

ID	Torque (N-m)	Torque (in/lbs)	Load (N)	Δt (ns)
Lug A	2.82	25	4946	55
Lug A	5.65	50	9991	118
Lug B	2.82	25	5347	61
Lug B	5.65	50	10582	126
Lug C	2.82	25	4764	60
Lug C	5.65	50	9119	110

Figure 9. Change in TOF vs. Preload for bolt elements installed via a standard procedure.

Site Visit II

With an eye toward adopting the ultrasonic method for preload verification on the shop floor, the contractor chose to replace the widely used cup head bolts in future builds with some having flat heads that were machined parallel on both ends. This “design for inspection” change simplified adaptation of the ultrasonic method by eliminating the need for the CCPS. A number of devices being marketed to measure residual stresses on the basis of acoustoelasticity were examined with an eye toward finding a portable device that would suffice for the proposed ultrasonic preload measurements. To this end, a unit was procured that Dakota Ultrasonics, [7] and others, market called the Mini-Max Bolt Tension Monitor. This unit is depicted in Figure 10 along with the Lab System.

Additional tests were then performed at the contractor facility. The purposes of these tests were to:

- (1) generate refined TOF calibration curves for 6.3-cm (2.5-in) long, flat head bolts and 24-cm (9.5-in) tension rods,
- (2) measure the error for the ultrasonic method, and
- (3) demonstrate that the, 0.25-GHz sampling rate, Mini-Max Bolt Tension Monitor was sufficient for use in lieu of the more accurate, 1.0-GHz sampling rate, Lab System.

Load Frame Tests – Flat Head Bolts

A load frame was used to apply incremental loads up to 15,569 N (3500 lb) to eighteen, 6.3-cm (2.5-in) long, notched, flat head bolts from the same manufacturing lot. At each load increment ultrasonic TOF measurements were made with the Lab System. For the last four bolts, TOF data was also acquired using the Mini-Max unit in its Oscilloscope Mode. In both cases, an Aerotech, Model Alpha, 6.6-mm (1/4-in) diameter, 15-MHz, ultrasonic transducer was used. The data are depicted in Figures 11 and 12. For each bolt, its zero load TOF was subtracted from that of the ensuing higher loads. The Lab System results exhibited an average slope of 0.0126 ns/N (0.056 ns/lb), similar to the 0.0124 ns/N (0.055 ns/lb) value observed for the Mini-Max Bolt Tension Monitor results.

Torque Tests– Flat Head Bolts

Bolts 1 – 12 were then each installed in a fixture with a strain-gauge-instrumented load cell of the same length as the associated Frangibolt® actuator and torqued in accordance with the contractor’s installation

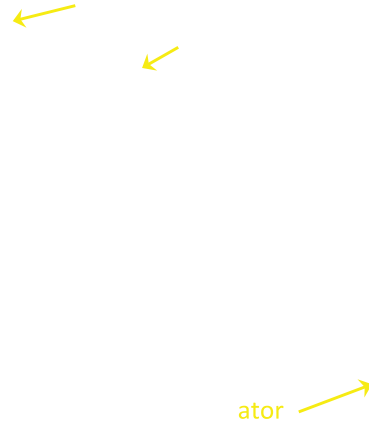

Figure 10. Results obtained with the portable Mini-Max Bolt Tension Monitor (left) were compared with those of the Lab System (right).

procedure. In preparation for the test, the load frame was used to validate the calibration of the load cell. At three specific levels of loading, as indicated by the load cell, ultrasonic TOF measurements were performed. The calibration slopes derived from the data in Figures 11 and 12, were then used to convert the TOF readings to a load value for comparison with those of the load cell as shown in Figure 13. The discrepancy between the load cell reading and those from both instruments was less than ± 445 N (100 lb) at 13,344-N (3000-lb) load or $\pm 3\%$. For Bolts 11 and 12, where both measurement systems were used, the discrepancy was higher for the lower resolution Mini-Max unit as one would expect, however, it was still well within the $\pm 10\%$ accuracy desired by the contractor.

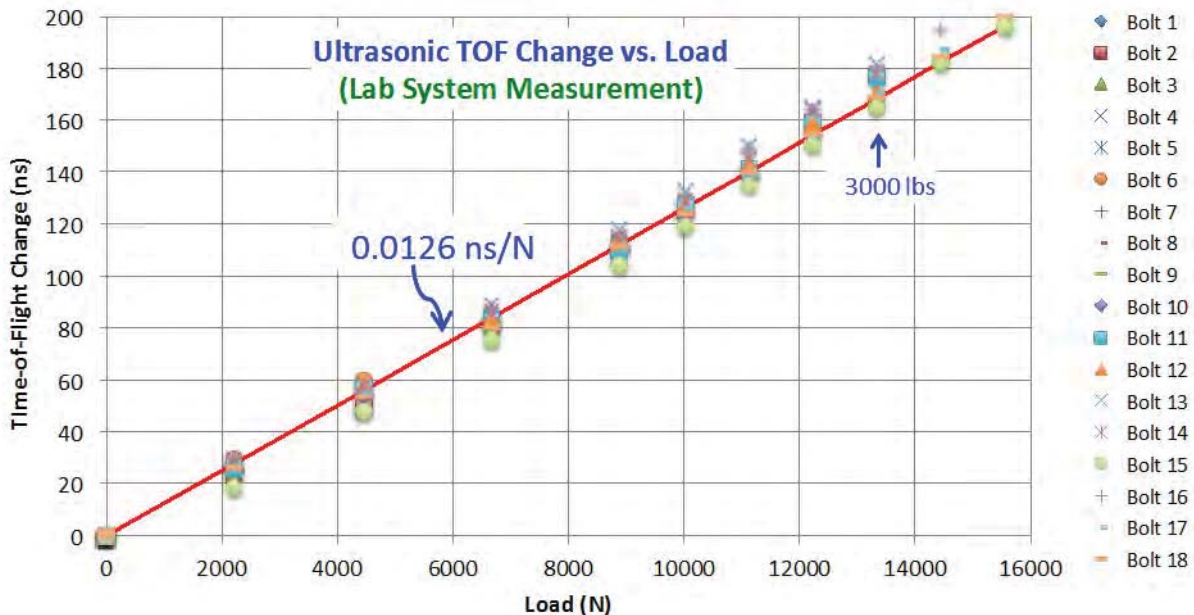

Figure 11. Ultrasonic TOF change observed for flat head bolt elements as a tensile load was applied. The Lab System depicted in the right photograph of Figure 10 was used to acquire these data points.

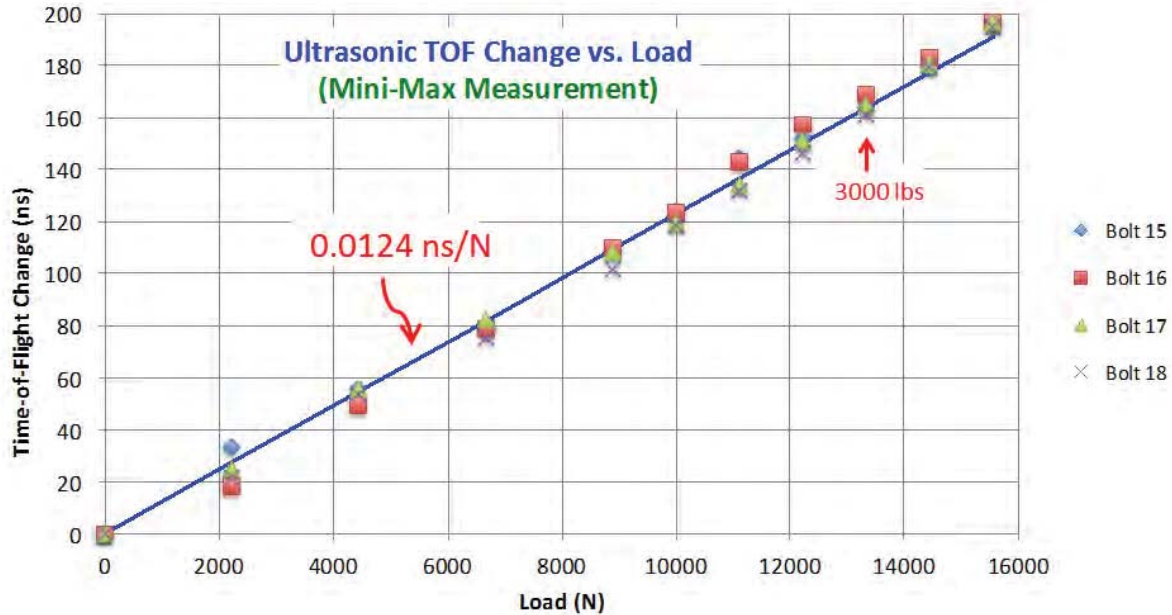

Figure 12. Ultrasonic TOF change observed for flat head bolt elements as a tensile load was applied. The Mini-Max Bolt Tension Meter depicted in the left photograph of Figure 10 was used to acquire these data points.

Load Frame - Tension Rods

The contractor also incorporates tension rods of length 24 cm (9.5 in) in some hardware and proper installation requires a specific preload. As with the flat head bolts, the contractor had both ends of the rods machined flat and parallel. These rods, one of which is included in Figure 2, provided a nice avenue for comparison with the bolts, having the same diameter and composition, but no notch. Three tension rods were therefore subjected to the same calibration tests as the bolts. Load frame tests resulted in the data presented in Figure 14. The slope was found to be 0.0468 ns/N (0.208 ns/lb) which when scaled by the length differences yields the same value as was obtained for the bolts:

$$\left(\frac{6.3 \text{ cm}}{24 \text{ cm}}\right) \times 0.0468 \frac{\text{ns}}{\text{N}} = 0.0123 \frac{\text{ns}}{\text{N}}$$

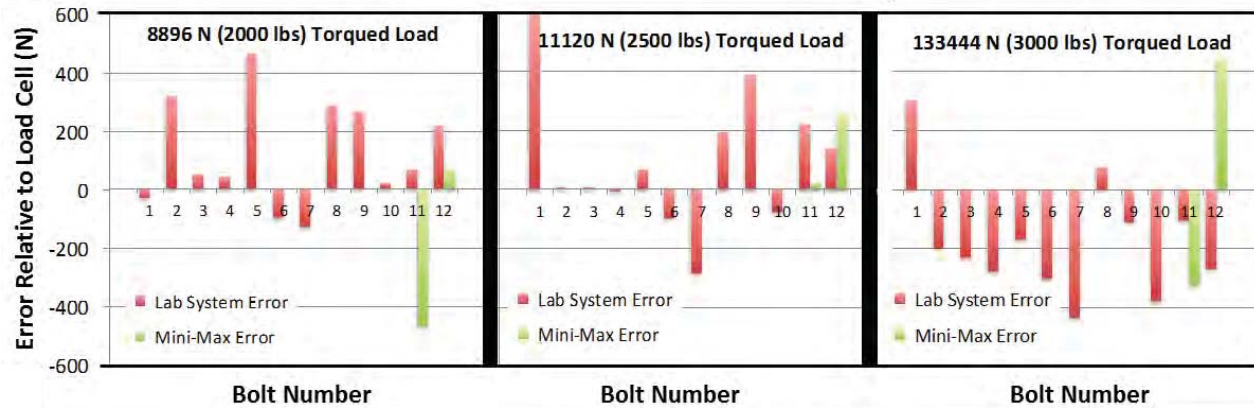

Figure 13. Histograms of the discrepancies noted between the load values registered on a load cell for torqued flat head bolts and that determined ultrasonically.

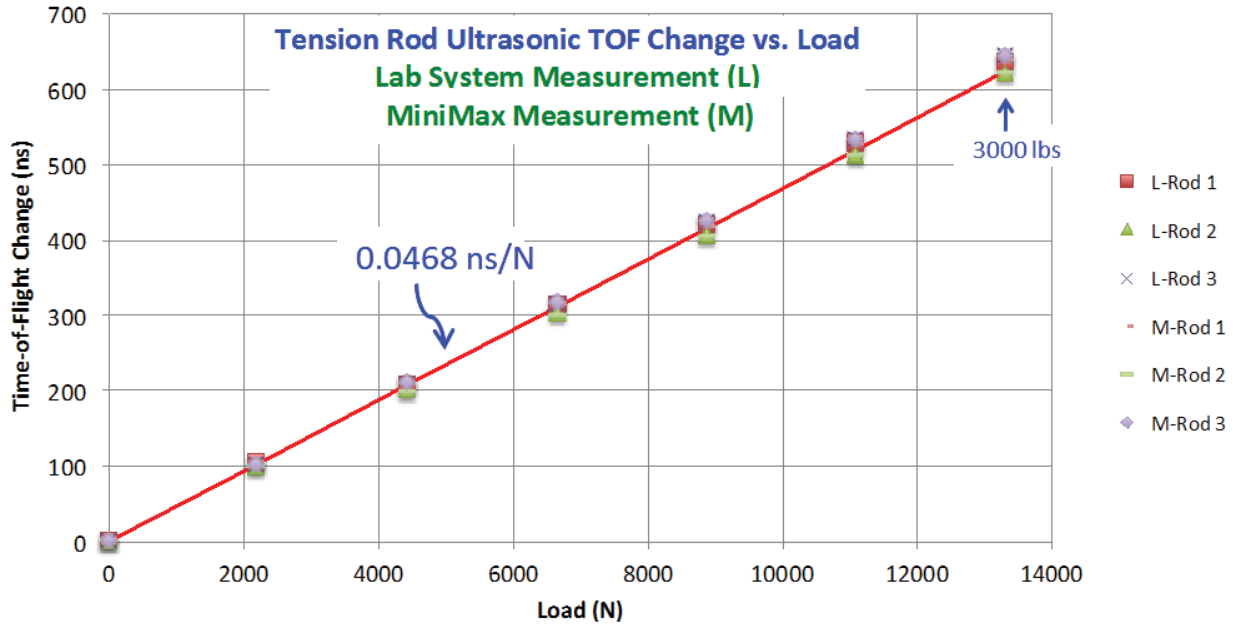

Figure 14. Ultrasonic TOF change observed in three 24-cm (9.5-in) tension rods as a tensile load was applied. The measurement was made both with the Lab System and the Mini-Max Bolt Tension Monitor for each tension rod.

A Panametrics, Model V129, 4.8-mm ($3/16$ -in) diameter, 10-MHz, transducer was used for the ultrasonic measurements. The 5-MHz version of the same model was found to work equally well. It was also noted that right angle probes (coaxial lead emanates from the side of the sensor) were decidedly easier to hold steadily against the end of the tension rod to produce a consistent signal.

Torque Tests – Tension Rods

The tension rods, like the flat head bolts, were then installed in a fixture with the calibrated load cell and torqued in accordance with the contractor’s installation procedure. TOF was measured with both systems and using the previously determined calibration factor of 0.0124 ns/N (0.055 ns/lb), the load was calculated and compared to the associated load cell reading. The results for three load levels are presented in Figure 15. The discrepancy between the load cell reading and those from both instruments was less than ± 400 N (90 lb) at 13,344-N (3000-lb) load. Again, as expected, the discrepancy was higher for the lower resolution Mini-Max unit, but well within the accuracy required.

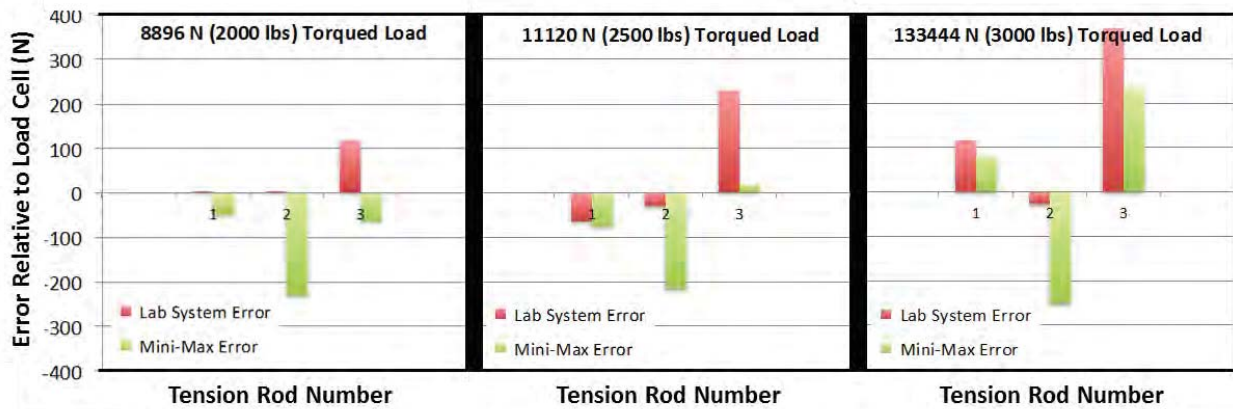

Figure 15. Histograms of the discrepancies noted between the load values registered on a load cell for torqued tension rods and that determined ultrasonically

Possible Contributors to Discrepancy

The magnitude of the discrepancy does not appear to scale monotonically with the applied torque. This suggests that a portion of the observed $\pm 3\%$ discrepancy between the load cell and TOF measurements may be rooted in factors other than the temporal resolution of the two ultrasonic systems. Such factors include variations in the (1) bolts themselves, (2) actual length of the bolt that is loaded (gage length), and (3) bolt temperature. It should be noted that errors in the gage length (active length of stretch) between calibration and measurement will propagate the same percentage error in the preload determination. For reference, variations in the geometry of the notch for the 18 flat head bolts load tested, plus two that were set aside (all from the same lot), were examined prior to the tests. Image analysis tools were applied to digital radiographs of each bolt to measure its notch diameter, notch radius and notch angle as defined in Figure 16. The notch diameter measured a consistent 3.7 mm (0.146 in) for all bolts. Histograms of the notch radius and notch angle variations are presented on the right of Figure 16. As a final step in the testing of the 18 bolts, an attempt was made to tighten them to 15,568-N (3500-lb) load. These bolts had all previously seen this value during the load frame testing (Figure 11), but one would expect frictional forces to result in a slight twist at the notch during torquing. This load was again achieved with all but one, Bolt Number 2, which broke at the notch. It is noteworthy that this bolt appears as an outlier in the histograms (Figure 16).

For metals, acoustic velocity is a strong function of temperature [8]. To measure the effect of bolt element temperature on the results, one of the tension rods was placed in a heated water bath with a magnetically affixed transducer. The TOF data was then acquired as a function of the water temperature resulting in the plot presented in Figure 17. If one divides the slope of this curve by that of Figure 12, the result indicates that a 1°C temperature change could lead to a $>200\text{ N}$ (45 lb) variation in the ultrasonically determined load for the tension rod. This is noteworthy, as it suggests that temperature variations could be a significant contributor to the observed small discrepancies between the load cell readings and the ultrasonic results. Because frictional forces result in heating of the bolt elements during tightening, it would be good practice to wait for at least 15 minutes before making the final ultrasonic determination of preload.

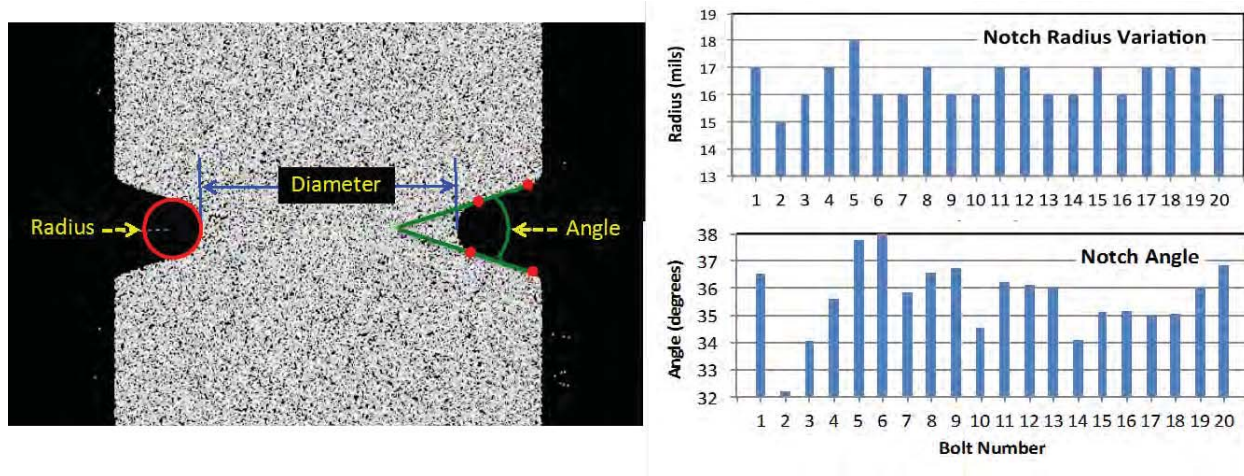

Figure 16. Digital radiographs were analyzed to measure variations in the notch geometry between twenty flat head bolts from the same lot.

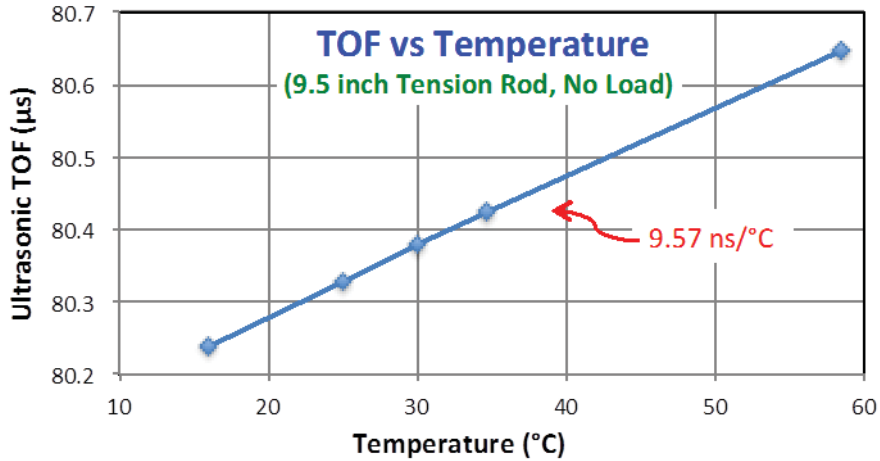

Figure 17. Change in ultrasonic TOF as a function of temperature for a 24-cm (9.5-in) unloaded tension rod.

Summary

Ultrasonic TOF measurements were successfully implemented as a means for determining the preload of installed bolt elements for Frangibolt[®] actuators. For each torqued bolt, the load was derived from the measured load-induced ultrasonic TOF change using an average conversion factor determined from load-frame tests. The discrepancy between the ultrasonic and load cell preload readings for 6.3-cm (2.5-in) long, notched bolts nominally torqued to 13,344 N (3000 lb) load was less than ± 445 N (100 lb) or $\pm 3\%$. Similar results were obtained for 24-cm (9.5-in) tension rods. The discrepancies observed likely contained contributions from bolt-to-bolt variations in the actual length loaded, the bolt temperature and bolt geometry. Improvement in the measurement fidelity could be achieved by calibrating the bolt elements individually as opposed to using an average calibration factor. The data suggest that a one-point calibration at 8896-N (2000-lb) load would suffice for the 6.3-cm (2.5-in), notched bolts. Having to load test each bolt, prior to tightening, however is probably not worth the marginal improvement that would be attained.

A commercially available Bolt Tension Monitor with a 0.25-GHz sampling rate was shown to be sufficient for the pre-load measurements. The accuracy gained through use of a system employing a 1.0-GHz digital scope was insignificant. For the notched bolts, it was found that monitoring the earliest maximum (or minimum) in the echo from the bolt end gave the most reliable load measurement result. Broadband transducers in the 5 – 15 MHz range were found to work effectively. The observed $\pm 3\%$ error obtained with the ultrasonic TOF methodology for setting the bolt element preloads is a significant improvement over the $\pm 25\%$ error observed with straightforward tightening to a specified torque.

Acknowledgement

Support of The Aerospace Corporation's Independent Research and Development Program is gratefully acknowledged.

References

1. TiNi Aerospace, Inc., 2505 Kerner Ave., San Rafael, CA 94901.
2. Bikford, J. H. and Nassar, S. (Eds.) (1998). *Handbook of Bolts and Bolted Joints*, New York, NY: Marcel Dekker, Inc., Chapter 25, Table 2, p. 674.
3. Table showing Accuracy of Bolt Tensioning Methods,
http://www.roymech.co.uk/Useful_Tables/Screws/Preloading.html
4. Allen, D. R., W. H. B. Cooper, C. M. Sayers, and M. G. Silk (1982). *The Use of Ultrasonics to Measure Residual Stresses*, Research Techniques in NDT, Vol. 6 (R. S. Sharpe, ed.). New York, NY: Academic Press, pp 151-209.
5. Smith, J. F. and J. D. Greiner. "Stress Measurement and Bolt Tensioning by Ultrasonic Methods," *Journal of Metals* (July, 1980), pp 34-36.
6. Pao, Y. H., W. Sachse and H. Fukuoka (1984), *Acoustoelasticity and Ultrasonic Measurements of Residual Stresses*, Vol XVII (W. P. Mason, ed.). New York, NY: Academic Press, pp 61-143.
7. Dakota Ultrasonics, 1500 Green Hills Road, #107, Scotts Valley, CA 95066
8. K. Salama and C. K. Ling, "The Effect of Stress on the Temperature Dependence of Ultrasonic Velocity," *Journal of Applied Physics*, 51, no. 3 (March 1980), pp. 1505-1509

All trademarks, service marks, and trade names are the property of their respective owners

