

Development of a Tendon-Actuated Lightweight In-Space MANipulator (TALISMAN)

William R. Doggett^{*}, John T. Dorsey^{*}, Thomas C. Jones^{*} and Bruce King^{**}

Abstract

An invention of a new and novel space robotic manipulator is described. By using a combination of lightweight truss links, a novel hinge joint, tendon-articulation and passive tension stiffening, this new robotic manipulator architecture achieves compact packaging, high strength, stiffness and dexterity while being very lightweight compared to conventional manipulators. The manipulator is also very modular; easy to scale for different reach, load and stiffness requirements; enabling customization for a diverse set of applications. Novel features of the new manipulator concept are described as well as some of the approaches to implement these design features. Two diverse applications are presented to show the versatility of the concept. First generation prototype hardware was designed, manufactured and has been assembled into a working manipulator that is being used to refine and extend development efforts.

Introduction

Devices for maneuvering and precisely placing payloads are critical for efficient space operations involving reusable assets or in-space assembly and construction. Key to the success of many of NASA's space activities has been the availability of long-reach manipulators, such as the Shuttle Remote Manipulation System (SRMS) and the Space Station Remote Manipulation System (SSRMS) (Refs. 1 and 2). These devices have been used for many operations including berthing spacecraft, space station assembly, astronaut positioning, payload transfer, satellite deployment, and spacecraft inspection prior to reentry. New missions and applications currently being considered, such as asteroid retrieval and redirection, asteroid mining, satellite servicing, and small payload delivery to space stations, can all benefit from long-reach manipulators.

Current manipulators embody an architecture whereby carbon composite tubes are joined by revolute joints, with the joints accounting for the majority of the device mass. Generally, the joints are driven by a gear train that applies the joint torque relatively close to the joint axis (Ref. 3). This results in the need to generate large torques, which in turn, requires large and massive gear-train-motor combinations. The area around the joint becomes a crowded location from a design stand point due to joint articulation, gearing, motors, and associated electronics all vying for space. Design is further complicated by the need to route a large electrical harness through the joint area to transmit power, sensor data, control and video signals between the joints and end-effector.

The current state-of-the-art in long-reach space robotics is represented by the SRMS and the SSRMS mentioned previously. Both of these incorporate traditional manipulator architectures, consisting of lightweight booms connected by massive rotary joints that are systems of motors, gearboxes and brakes. The rotary joints account for 85 to 90 percent of the manipulator mass and manipulator compliance in response to an applied load (Ref. 1). The long booms result in restrictive packaging options, and adding joints to improve packaging would incur an extremely high mass penalty. The high mass associated with the joints also results in practical limits to: reach, packaging, stiffness and tip force that can be achieved with the conventional architecture.

^{*} NASA Langley Research Center, Hampton, VA

^{**} Northrop Grumman, Hampton, VA

In order to enable future missions and applications, it is desirable to improve space manipulator state-of-the-art by significantly increasing manipulator reach, dexterity and packaging efficiency while reducing manipulator mass and complexity. The Tendon Actuated Lightweight In-Space MANipulator (TALISMAN) is an invention (patent application has been filed) of a new robotic manipulator architecture that incorporates a tendon-actuated joint with a novel hinge that allows a full 360-degree rotation between connecting links and the capability to incorporate auxiliary and passive tension stiffening. Tendon actuation incorporates spreaders to achieve longer moment arms between the force applied by tension cables and the joint rotation axis, thus gaining mechanical advantage for generating moments and actuating the joints.

Key features of the new TALISMAN architecture and approach are:

- Uses tendon actuation, which can be semi or fully antagonistic, with major components being the link, spreader, and lightweight cables, motors, gearboxes,
- Increased joint stiffness due to tendon architecture,
- Lightweight joints enable the number of joints to be optimized to achieve desired packaging efficiency, range-of-motion, dexterity, etc.,
- Potential to increase manipulator stiffness using passive tension elements (very lightweight),
- Versatility; many different cable/motor/control options can be implemented,
- Modularity; links and joints are easy to scale for different applications, can combine link and joints as needed for packaging, dexterity, etc. to achieve operational needs,
- Novel hinge joint allows full 360-degree rotation between adjacent links, improving dexterity and range of motion,
- Uses lightweight truss structures for links.

The TALISMAN architecture embodies and adds to many of the features that were developed for a new planetary surface hybrid crane/manipulator, the Lightweight Surface Manipulation System (LSMS) (Ref. 4). The LSMS is a cable-actuated manipulator that achieves high structural efficiency by using a pure tension / compression architecture (as opposed to bending in conventional robotic manipulators). Further mass efficiency is achieved by using the tension structure (cables) to also articulate the LSMS arm hinges. The tension cables provide mechanical advantage about the joint enabling small lightweight hoists or capstans to reel cable in and out (thus articulating the hinge), replacing the massive high-torque motor gear-boxes used in a conventional boom manipulator.

TALISMAN: New Approach for Space Manipulators

In conventional space manipulator architectures, a majority of the manipulator mass resides in the joints. TALISMAN's new and unique approach significantly reduces motor mass while simultaneously stiffening the links and allowing more compact packaging. In addition, a new joint architecture is described that allows a full 360-degree rotation of the joint. The invention described here creates a new class of manipulators through innovative use of tension networks to actuate the joints and stiffen the manipulator structure in a modular fashion. Both tension actuation of the manipulator joints and tension stiffening of the links are novel approaches to manipulator design. Each of these approaches enhances the performance of the manipulators and can be used independently or together depending on mission requirements for reach, packaging efficiency, weight and dexterity. Tensioning can be accomplished in a variety of ways including through cables, metallic tapes, rigid bars, etc., or some combination of these approaches. Actuating the manipulator joints using tension elements that are offset from the joint rotation axis (by the spreaders) provides large mechanical advantage for the joint motor enabling use of smaller lighter weight motors requiring less power. Low-precision motors can be used because the tension elements can be designed to damp out irregularities in the motor torque, further reducing motor complexity and costs. In addition, the tension actuation provides a large effective gear reduction, so that a motor revolution produces only a small change in joint angle.

Figure 1 illustrates an example of a manipulator that uses tension elements for actuation and stiffening. The manipulator in the figure shows 2 joints and 3 links; however any number and size of joints and links

can be combined into a manipulator, depending on the requirements for a particular application. The primary parts of a manipulator are labeled on the left of the figure and the components of a joint are labeled on the right. When developing a manipulator with the architecture depicted in Figure 1, tension elements can be used to actuate and stiffen a joint as well as stiffen a link. The motors used to actuate the joint can either drive hoists, where excess tension material (for example cable) is spooled, or drive capstans where the tension elements circulate from one side to the other. These tension networks increase the stiffness of the manipulator dramatically, allowing compression members with smaller cross sections to be used and lighter overall systems to be realized compared to the current state-of-the-art manipulators such as the SSRMS and SRMS. The spreaders (identified in the figure) are used to provide joint stiffening and mechanical advantage about the joint. Single spreaders above and below the joint, or multiple spreaders (depending on design requirements) can be incorporated as shown. Similar to joint spreaders that aid articulation, link towers (which are fixed elements along the link) can be used to provide a tension path to increase link stiffness.

The components of a single joint are identified on the right side of Figure 1. The joint rotates about the joint axis, identified in red in the middle of the figure. In this example, the capstan (B) and pulleys (A,C,D) are located equidistant from the joint axis and a single capstan (with dual warping profiles) located along one of the links is used to actuate the joint. The number and location of the drive motor(s) that actuate the joint can be varied, allowing significant design freedom to meet mission requirements. The link-mounted capstan in the figure has two warping end profiles of different diameters that operate two circulating cable loops simultaneously to achieve joint articulation. Extension/contraction of the springs shown in the figure are used to accommodate changes in the total cable path as the joint articulates.

Many variations of the joint architecture shown in Figure 1 are possible, with four possibilities shown in Figure 2. Starting in the upper left with image "I" and using the nomenclature defined on Figure 1, first the distance from "A" and "B" to the joint axis does not need to be equal as shown in Figure 2. In image "I" of Figure 2, "B" has moved to the end of the link. This arrangement uses a single cable, one each above and below the link, to not only stiffen the link, but also to stiffen and actuate the joint. The location of "B" in Figure 2 can be selected to be at any point along the link. The image also shows a manipulator configuration where the tension element is no longer in contact with the spreader, referred to as "spreader liftoff". Allowing liftoff is optional because it results in the tension element sweeping through a large portion of the workspace which might cause interference. However, a benefit of liftoff is that it enables significantly increased force to be applied between the link ends, achieving a large amount of joint torque. In Figure 2, image "II" in the upper right, the dual capstan warping end profiles may be the same diameter and combined with a single motor located along one of the spreaders. This results in one of the simplest configurations from a control standpoint. In the lower right of Figure 2, image "III" shows multiple spreaders used above the links. Additional spreaders can be located above or below the links and any number of spreaders can be used. In the final image in the lower left of Figure 2, four motors are used to actuate the joint, each one driving separate tension elements that run between the link end point and the top of the spreader. For optimal performance, each motor must be synchronized to keep the spreader tips equidistance from the links. Using multiple motors allows for many advanced control schemes including dynamic damping of structural modes. Image "IV" also depicts constrained lift-off, where the tension element along the lower portion of the joint is encapsulated and forced to remain affixed to the spreader, in this case, by a telescoping member that allows for some increase in spreader height. In Figures 1 and 2 the joint rotation axes between successive joints have been shown as parallel and tension stiffening is only shown in the plane of articulation. Successive joint rotation axes can also be rotated relative to one another and tension stiffening can be applied in multiple directions.

Tension stiffening enables much smaller truss cross sections to be used while achieving equivalent in tip deflection performance. For example, the 4-link manipulator shown in Figure 3, where the actuation tendons are connected to the link ends, places the links in pure compression, avoiding bending loads. Stiffness provided by the tension network enables a reduced link cross section and a smaller overall packaged device. When packaged for launch (middle of Figure 3) the spreaders slide in between the links allowing their maximum length to approach the length of the links without requiring any additional

complexity to collapse the spreaders. For the links, a large portion of the cross section is open, allowing integration of cable bundles as required.

In Table 1, the TALISMAN prototype shown in Figure 3 is compared to the SRMS. In this example, the TALISMAN has been sized for the SRMS tip force and stiffness requirements; 53.4 N (12 lbf) at the tip and 17.5 N/cm (10 lbf/in) deflection constraint (Ref. 2). Although the SRMS is a flight system and the TALISMAN is a laboratory prototype that have different levels of design fidelity, major advantages of the TALISMAN architecture are apparent. The TALISMAN prototype has not been optimized and is constructed from readily available rectangular tubes to allow inexpensive development, with the focus being on implementing and obtaining experience with the unique cable actuated joint. Currently, a single joint/two-link test bed has been fabricated using 7.62 x 15.2 cm (3 x 6 inch) rectangular aluminum tubes with a 6-mm (0.25-inch) wall thickness for the links. For the version summarized in Table 1, the links and spreaders are assumed to have the same geometry as the test bed, but are constructed from a polymeric composite material that has a Young's modulus of 138 GPa (20×10^6 psi); the joint mass is based on the as-built hardware that was designed and fabricated from aluminum and installed into the laboratory prototype and has a mass of 0.54 kg (1.2 lb); and the spreader is assumed to be a polymeric composite tube with its height fixed at 1 m (39.4 in). As shown in the table, the TALISMAN system mass is an order of magnitude less than that of the SRMS, with the link system mass (including the links, spreaders and cables) being significantly less than that of the SRMS tubes. When packaged for launch, the TALISMAN occupies only 1/7th of the SRMS volume. For comparison, at the bottom of Figure 3, the packaged TALISMAN is shown in two views packaged inside one of the two SRMS links (depicted as folded side by side for this image), where the SRMS links are each 0.381 m (15 in) in diameter and 7.65-m (25-feet) long. In the end view on the lower right, a dashed line is included showing the 0.33-m (13-in) diameter of the SRMS composite tubes. The SRMS composite tubes are thin walled and are encased in a protective bumper resulting in the 0.381-m (15-in) diameter shown. In contrast, the TALISMAN truss uses solid members, and does not require a protective covering. Finally, based on parametric motor sizing equations, the TALISMAN is expected to use significantly less power because less torque is required at the motors resulting in smaller lighter motors (Ref 5).

A limitation of the TALISMAN design used for the prototype configuration is that it is a planar system, having significantly more stiffness in the plane of articulation than out of that plane. If required, out-of-plane stiffness can be increased by adding passive tension elements or by increasing the depth of the truss cross-section perpendicular to the plane of actuation. Another limitation of the prototype is that the TALISMAN motors included in the comparison are not redundant as are the SRMS motors. Also, the TALISMAN does not include a wrist with roll, pitch and yaw capability or a snare end-effector as the SRMS does. However, the TALISMAN design does assume all joints have full articulation capability, but if this is not required, a much simpler and lighter deployment hinge and lock can be used.

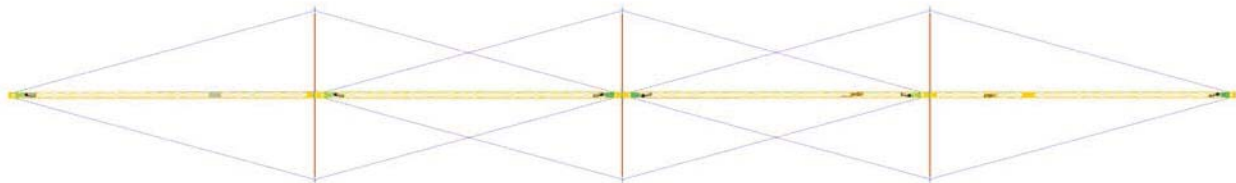

A Novel Joint Enabling Full 360-Degree Rotation

Joint range of motion directly affects the ability of a manipulator to reach locations, i.e. the useable manipulator workspace. Here a novel joint will be described that provides a full 360-degree rotation, while simultaneously supporting free rotation of a third member, the spreader, about the active joint rotation axis. The mechanism of interest is the center of a tension articulated joint that is shown in the top left of Figure 4. In the close up view of the joint shown on the top right of the figure, the yellow and purple components (on the left and right of the hinge) are the link plugs used to attach the joint to the links

(which are depicted as grey rectangles in the figure). Three components make up the center of the hinge, two identical linkage arms and a central spreader support component. Three hinge lines, labeled A, B and C, enable the range of motion as depicted in the bottom of the figure: where starting on the left, the hinge is at 0 degrees and progresses through to 360 degrees on the right. From 0 to 180 degrees, the top hinge line (B) is active, while from 180 to 360 the bottom hinge lines (A and C) are active. During joint rotation, the spreader support bisects the angle formed by the links, which keeps the transverse force resultants at the tip of the spreader balanced and the spreader in pure compression.

Tendon Routing Options: Evaluation and Selection

A large number of options are available for implementing the TALISMAN architecture including: the number of motor/drive systems used per joint, the location of the motor/drive systems along the links or on the spreaders, cable routes, and full versus partial antagonistic control. A simple test bed was designed and constructed to allow a variety of tendon-drive options to be easily implemented, operated and evaluated so that a configuration could be chosen to implement into a full-scale two-link articulating joint prototype. The test bed consists of two arm links connected at a central hub, with the left arm fixed, as shown in Figure 5. The spreader is attached to the hub and under ideal operations, would remain centered between the two arms. A counter-balance is attached to the rotating arm to off-load the arm weight so that the actuation system essentially experiences zero load as it rotates the joint.

Four major architecture options were evaluated by varying the number and location of motor/gear-box systems on the arms or spreader, as summarized in Figure 6. In the figure, the locations of motors, springs, pulleys, capstans and stops (tendon tie-down points) are indicated with icons. The figure also uses sequences of numbers and/or letters to indicate tendon routing and circulation. None of the options tested in the lab were the full antagonistic actuation version (the required control system is still being developed); all included springs so that the stiffness in one rotation direction reached that of the cables while the stiffness in the other direction was limited to that of the passive springs. The major attributes of each of the tendon routing and motor/spring position options, all of which are shown in Figure 6, are:

- Option 1: one motor/gearbox system, two capstans with one having half the diameter of the other, the motor/gear-box is mounted at a distance along the arm equal to $\frac{1}{2}$ the length of the spreader.
- Option 2: two motor/gearbox systems, each motor/gearbox system has a single capstan, both capstans are the same diameter, the motor/gear-boxes are each mounted at a distance along the arm equal to $\frac{1}{2}$ the length of the spreader, one on either side of the center of rotation, two independent cable loops used.
- Option 3a: two motor/gear-box systems; each motor/gearbox system has a single capstan, both capstans are the same diameter; the motor/gear-boxes are each mounted at a distance along the arm that is approximately equal to the length of the spreader, one on either side of the center of rotation; cable routing is top of spreader, around drive capstan system, around pulley on bottom of spreader, up spreader arm to hub (with the spring between the pulley and hub).
- Option 3b: this option is the same as Option 3a except; the cable routing was modified to; top of spreader, around drive capstan system, around pulley on bottom of spreader, through pulley (only) on opposite drive system along arm to hub (with the spring between the pulley and hub); modified 3a such that two springs are attached to each other with their connection point to the right of the hub.
- Option 4: one motor/gear-box system; motor/gearbox system has two capstans, one capstan is half the diameter of the other; the motor/gear-box is mounted at the top of the spreader; two independent cable loops, identical to Option 2; used the new constant-spring-force mechanisms for each loop.
- Option N: not evaluated in test-bed, but his option would be a fully antagonistic arrangement with no passive spring elements.

All of the options were rated against the set of criteria listed in Table 2. The fully antagonistic option (N) would be preferred in an implemented system, due to its high stiffness over the full 360-degree rotation range and its high degree of controllability and performance. However, the control system for this option is the most complex, and although it is currently being developed, was not available immediately. In order

to proceed with the TALISMAN joint prototype, Option 3b was chosen because of its good stiffness and spreader synchronization characteristics as well as its very good packaging capability. The packaging capability is important because the next phase of TALISMAN development will be focusing on demonstrating: efficient packaging; deployment, including the spreader, from a fully packaged state; and, full 360-degree articulation of the joint. A prototype section of the Option 3b has been fabricated and undergone limited operational testing in the laboratory, as shown in Figure 7. The prototype section has two aluminum truss links connected by a single-degree-of-freedom hinge joint. Each link is 3.66-m (144-inches) long and has a 7.62 x 15.24 cm (3 x 6 inch) cross-section and the total height of the spreader is 1 m (39.4 inches) above the joint rotation axis. Articulation of the prototype has been demonstrated from 0 degrees (straight out position) through 180 degrees (where the outer link is folded adjacent to the inner link).

Example TALISMAN Applications and Sizing Results

Two distinct embodiments of the TALISMAN are emerging: A Long Reach (LR) variant and a Compactly Stowable (CS) variant. LR applications would be focused on achieving long reach and maintaining high stiffness with less emphasis on high dexterity and the ability to stow and deploy multiple times. CS applications would be focused on achieving high dexterity, a large reach envelope, applying and reacting large tip forces, being able to deploy and restow multiple times, and packaging into a limited volume (for launch or within a spacecraft storage location).

300-meter LR Application

A Space Act Agreement was signed between Langley Research Center and Altius Space Machines to investigate and develop applications for a LR TALISMAN (LRT) design. As a result of this collaboration, Altius Space Machines investigated a mission concept for enabling inexpensive and rapid commercial payload delivery/recovery from the International Space Station (ISS). The mission concept requires that ISS payloads be captured and released beyond a strictly controlled 200-m radius keep-out sphere. Altius baselined a LRT having a reach of 300 meters, assuming a capture distance at 250 meters from the ISS. Due to the lack of additional mission definition at this time, the LRT was designed to achieve a reasonable and robust operational capability (dexterity for example) coupled with efficient structural performance. Due to the extreme length of the manipulator, passive tension stiffening is used to augment the stiffening provided by the tendon-actuation architecture. In this case, the tension-stiffened manipulator was designed to have 10 times the stiffness of the bare central truss. Features of the LRT are illustrated in Figure 8 and design/performance specifications are given in Table 3.

Asteroid Capture System CS Application

A current mission option being investigated within NASA is to capture an asteroid and return it to cislunar space where it would be examined by an astronaut crew. The original mission concept was limited to capturing a free-floating asteroid, assumed to be either an approximately 7-meter diameter sphere, or a 5 meter x 10 meter ellipsoid. The associated capture/enclosure concept used a series of deployable links, tensioning cables and inflatable envelopes to accomplish the mission. In order to improve mission versatility and increase the probability of mission success, a CS TALISMAN (CST) based concept for an asteroid retrieval mechanism was developed with the goal of accommodating many possible different mission scenarios (including retrieving a boulder from a large asteroid body) while also enabling and supporting astronaut Extra-Vehicular Activity asteroid evaluation operations in cislunar space. By leveraging TALISMAN technology currently being developed by NASA it might also be possible to reduce system cost and development schedule.

The complete asteroid material capture and enclosure system would consist of two major subsystems; a set of three 4-link TALISMANs attached to the retrieval spacecraft bus and a simple lightweight bag to enclose the asteroid and prevent loose particles from escaping as shown in Figure 9. The capture system is assumed to integrate with a solar electric retrieval stage at a 3-meter-diameter circular interface. The four links are folded for launch so that the packaged TALISMAN easily fits into the baseline launch vehicle (Atlas V) medium or long payload shroud. The three CSTs are attached along the outside edge of

the spacecraft interface at 120-degree intervals. Each CST has four truss links and four tendon-actuated hinge joints with the base of each CST mounted to a simple turntable (to provide a [fifth] rotary degree of freedom). The enclosure bag (EB) is attached to the circular interface structure at its base and folded in the center portion of the space between the stowed CSTs. The EB has a simple inflatable ring integrated at its open end that is inflated to provide a large circular opening for acquiring an asteroid. The system is redundant since the mission can be successfully completed even if one of the CSTs completely fails to operate. Design and performance specifications for the CST are given in Table 3.

TALISMAN Structural Sizing Analysis

One of the key advantages of the TALISMAN architecture is its structural simplicity and efficiency. These attributes are achieved by using a modular, periodic tension-compression design that lends itself well to analytical modeling. Closed-form, parametric equations were derived to calculate the member loads and tip deflection and allow systematic optimization of the key structural components of TALISMAN, including the core truss links, the spreaders and the tension elements. The analytical equations were derived using the following assumptions; spreaders and truss links have small axial deformations, all tension elements are always under load (achieved in practice using either active actuator control or passive springs) and material behavior is linear elastic. Typical requirements that must be specified are for in-plane (refers to those aligned with the plane of the spreaders; the stiffest plane), out-of-plane and torsional tip loads, and the required tip stiffness. The derived equations can be used to determine the optimum sizing, pretension level and mass of the system while taking into account constraints on the minimum gauge of thin-walled members, and local strength and buckling. A spreadsheet-based TALISMAN design tool was generated using these equations to enable rapid design studies and to investigate the sensitivities of various parameters including: number, length and cross-section of primary arm links; spreader height and geometry; cross-section of tension elements; material properties; safety factors on strength and buckling; lacing pattern of truss diagonals and; in-plane, out-of-plane and torsional tip loads and tip deflection. Figure 10 illustrates the geometry used in the model as well as load and displacement variables.

The TALISMAN design tool requires the user to input the basic geometry, tip loading and material properties and it outputs the internal loads, sizing and masses of all members. The geometric parameters include the length, number and cross-section of the arm links and the height of the spreaders. These parameters are not included in the optimization since they are typically dictated by the requirements for a specific application, such as component packaging volume, or spreader impingement into the operational work space. The links and spreaders are optimized by iterating on and requiring the value of a sizing parameter (either area or thickness) be equivalent when both strength and buckling constraints are satisfied. The tendons are sized for axial stiffness and strength, as they provide the primary in-plane stiffness. Separate safety factors are specified for the compressive and tension members, due to the typically higher factor on strength for tendons. The TALISMAN is designed for high structural efficiency in the plane of articulation. However, off-nominal loads, such as out-of-plane or torsion, are accounted for in the design process. Some examples of these off-nominal loads include push-off lateral loads induced by an attached Extra Vehicular Astronaut (EVA) astronaut, or torsional loads induced by lateral loads when the arm links are at different angles. For the CST, the worst-case torsional load was used for sizing. This torsional load occurs when all of the arm links ahead of the root link are perpendicular to the root and a lateral tip load is applied, thus creating a large moment that is reacted by the truss diagonals in the first bay of the link closest to the root or base.

The current design tool is intended to produce optimized TALISMAN architectures that are conservative by using reasonable and current material properties and worst-case loading scenarios. The structural members are sized for a tip load applied to a fully extended (straight-out) manipulator pose (i.e. the longest moment arm), with any lateral loads inducing compression in the truss longerons (through bending and torsion). The sizing is based on the maximum loads induced in the structural members, usually those that are at or near the root; this allows equivalent cross-sections to be used for each set of members, resulting in easy and inexpensive manufacture or purchase of off-the-shelf components. For example, extruded beam sections with standard rectangular cross-sections were inexpensively purchased and cut on a water-jet machine to obtain the optimal truss lacing pattern determined by this

design tool. Additional optimization could be included at a later date to allow: tapered members, different spreader sizes from root to tip, sizing based on specific member loads rather than maximum loads, and sizing based on nominal, as opposed to worst case loads (with safety factors). For instance, a fully extended manipulator pose is unlikely to be used for most applications; typical operations would have the links at some angle. In addition, the worst-case torsional load results from a highly unlikely manipulator pose. With a well-defined and actively controlled work envelope, the severity of the load cases could be reduced. The current sizing for tip stiffness assumes purely passive operation, i.e. the members are sized so that when a tip load is applied the structure deforms to a set tip displacement. However, with full antagonistic control, the tip displacement can be driven back to zero by actuating the tendons. This operation would result in a mid-manipulator displacement rather than a tip displacement, but could significantly reduce the mass of the system if tip stiffness is a primary objective, but at the cost of greater structural flexibility. Depending on the application and control system this might be an attractive option for future analysis. Since the tip stiffness requirement also determines the tendon sizing; a reduction in required passive tip stiffness would reduce the tendon diameters allowing smaller/faster gear trains and motors. This could allow greater actuation speeds that might be necessary to actively control the dynamic response of a flexible system. Any of these optimization features could be added in the future if desired.

The TALISMAN sizing tool is primarily used to explore the parameter design space and currently only calculates the structural mass. Future work will include adding mass estimating tools for joints, motors, gear trains, electronics and any additional hardware needed. A simple, pinned truss analysis tool, based on matrix structural analysis, was written in MATLAB and used successfully to verify and validate the results of the spreadsheet output and the analytical equations. To enable more refined analysis of a specific TALISMAN design, an ABAQUS Finite Element Model script was also written to recreate the geometry from the spreadsheet design tool. The Finite Element Model can then be used for dynamic, frequency and global buckling analyses. The script can create different operational poses, and can be integrated with structural models of candidate spacecraft. Loads can be applied at other points along the structure if needed and all internal loads and displacements can be interrogated. With these tools the TALISMAN architecture can be adapted and optimized for a wide range of applications and designs created that have accurate estimates of their structural performance and system mass.

Conclusions

Devices for maneuvering and precisely placing payloads are critical for efficient space operations involving reusable assets or in-space assembly and construction. New missions and applications currently being considered, such as asteroid retrieval and redirection, asteroid mining, satellite servicing, and small payload delivery to space stations can all benefit from having long reach manipulators that are also light weight and have high dexterity. The limits resulting from the current state-of-the-art in long reach space manipulators are discussed and a novel new manipulator architecture, the TALISMAN that directly addresses and mitigates these limits is introduced. By using a combination of lightweight truss links, a novel hinge joint, tendon-articulation and passive tension stiffening, this new robotic manipulator architecture achieves compact packaging, high strength, stiffness and dexterity while being very lightweight compared to conventional manipulators. There is a great deal of freedom and versatility in designing manipulators based on this new architecture and accompanying details and options are discussed. A hardware test-bed was created and several different manipulator options were implemented and tested. The results from the hardware assessment were used to rate and prioritize design options and a specific configuration was chosen for further development. The design and operation of this manipulator prototype is presented along with the development focus of current research. The extreme versatility of the TALISMAN architecture is demonstrated by presenting two different (a long-reach and a compactly stowable) applications and summarizing the design and performance attributes of the resulting manipulators. Finally, tools are described that have been developed to perform structural analysis, size structural members and estimate the mass of different TALISMAN implementations designed for different mission requirements.

References

1. Hunter, J. A.; Ussher, T. H.; and Gossain, D. M.: Structural Dynamic Design Considerations of The Shuttle Remote Manipulator System. AIAA 82-0762, pp. 500 - 505.
2. Kumar, P.; Truss, P.; and Wagner-Bartak, C. G.: System Design Features of the Space Shuttle Remote Manipulator. Proceedings of the Fifth World Congress on Theory of Machines and Mechanisms 1979. Published by the ASME, pp. 839 - 842.
3. Craig, John J.: Introduction to Robotics, Mechanics and Control, Third Edition. New Jersey: Pearson Prentice Hall, 2005.
4. Doggett, William R.; Dorsey, John T.; Collins, Timothy J.; King, Bruce; and Mikulas, Martin M.: A Versatile Lifting Device for Lunar Surface Payload Handling, Inspection and Regolith Transport Operations. Presented at the Space Technology and applications International Forum – STAIF 2008, Albuquerque NM, 10 – 14 February 2008. AIP Conference Proceedings Volume 969, Editor Mohamed S. El-Genk, 2008 American Institute of Physics.
5. Dorsey, John T.; Mikulas, Martin M.; and Doggett, William R.: Preliminary Structural Design Considerations and Mass Efficiencies for Lunar Surface Manipulator Concepts. Presented at the AIAA Space 2008 Conference and Exposition, 9 – 11 September 2008, San Diego, California. Available as AIAA-2008-7916.

Table 1. Comparison of TALISMAN to Shuttle Remote Manipulator System. (Refs. 1, 2)

Design Parameter	SRMS	TALISMAN
Total manipulator length	15.3 m (50 ft)	15.3 m (50 ft)
Number of joints in manipulator	6 (2 shoulder, 1 elbow, 3 wrist)	5 (2 base, 4 links)
Number of links in manipulator	2	4
Tube/Link System Mass [kg]	46 kg (101.4 lbf)	7.03 kg (15.5 lbf)
Manipulator Mass	410 kg (904 lbf)	36.1 kg (79.6 lbf)
Packaged Volume	1.74 m ³ (61.4 ft ³)	0.23 m ³ (8 ft ³)

Table 2. Results from tendon-routing option evaluation

Criteria	Option.1	Option.2	Option.3a	Option.3b	Option.4	Option.N
# of Motors	1	2	2	2	1	4
Control System Simplicity	5/5	4/5	4/5	4/5	5/5	1.67/5
Power Consumption	3/5	3/5	3.67/5	3.67/5	3.67/5	4.67/5
Stiffness Properties	2.5/5	1/5	2.5/5	2.5/5	2.5/5	5/5
Strength / Stiffness Symmetry	180° Full+ Bending / 180° Spring	180° Full Bending / 180° Spring	180° Full / 180° Spring	180° Full / 180° Spring	180° Full / 180° Spring	360° Full
Cable Mass	4/5	4.5/5	2.5/5	2/5	2.5/5	4/5
Packaging	2.5/5	2.5/5	3/5	4.5/5	3/5	4.5/5
Cable Routing Simplicity	1/5	2.5/5	3/5	1.5/5	3/5	5/5
Ease of Spreader Liftoff	2/5	3.5/5	3/5	3/5	2/5	5/5
Spring Travel	1/5	1.5/5	3.5/5	3/5	3.5/5	5/5
Ease of Motor Repair	1.5/5	2/5	2/5	1/5	4/5	4.5/5
Spreader Synchronization Robustness	1/5	3.5/5	3.5/5	3.5/5	1/5	5/5
TOTAL	23.5/50	28/50	30.67/50	28.67/50	30.17/50	44.34/50

Table 3. Specifications for two TALISMAN applications

Design Parameter, Specification	LR: ISS Payload Application	CS: Asteroid Capture Application
Total manipulator length, m (ft)	300.0 (984.3)	20.0 (65.6)
Number of links in manipulator	6	4
Link length, m (ft)	50.0 (164)	5.0 (16.4)
Number/types of degrees-of-freedom (dof)	7 total: 1 base rotation; 6 single dof hinges	5 total: 1 base rotation; 4 single dof hinges
Number of motor/gear-boxes per hinge joint	2	2
Control method	Fully antagonistic	Fully antagonistic
Hinge joint articulation range, degrees	From 0: +125; -180	From 0: +180; -180
Location of motor/gear-boxes	Link mid-point	Link end-point
Link structure	1m by 1m polymeric composite truss with titanium joints	7.62cm by 15.24cm (3in by 6in) polymeric composite integral truss
Structural assembly concept	Assembled robotically on orbit using Electron-Beam welding	Fully assembled & packaged on ground, deployed in space
Spreader height (tip to joint axis), m(ft)	4.5 (14.8)	1.0 (3.3)
Passive tension stiffening?	Yes: tower height 4.5 m (same as spreaders)	No
Tower base location	Link mid-point	NA
Design load: manipulator fully extended, transverse load at tip, N (lb)	100.0 (22.5)	66.7 (15.0)
Tip deflection, m (ft)	5.38 (17.7) [1.8% of length]	0.20 (0.66) [1.0% of length]
Mass estimate, kg (lb)	2200 (4840)	48.8 (107)
Mass per unit length, kg/m (lb/in)	7.33 (0.41)	2.44 (0.14)

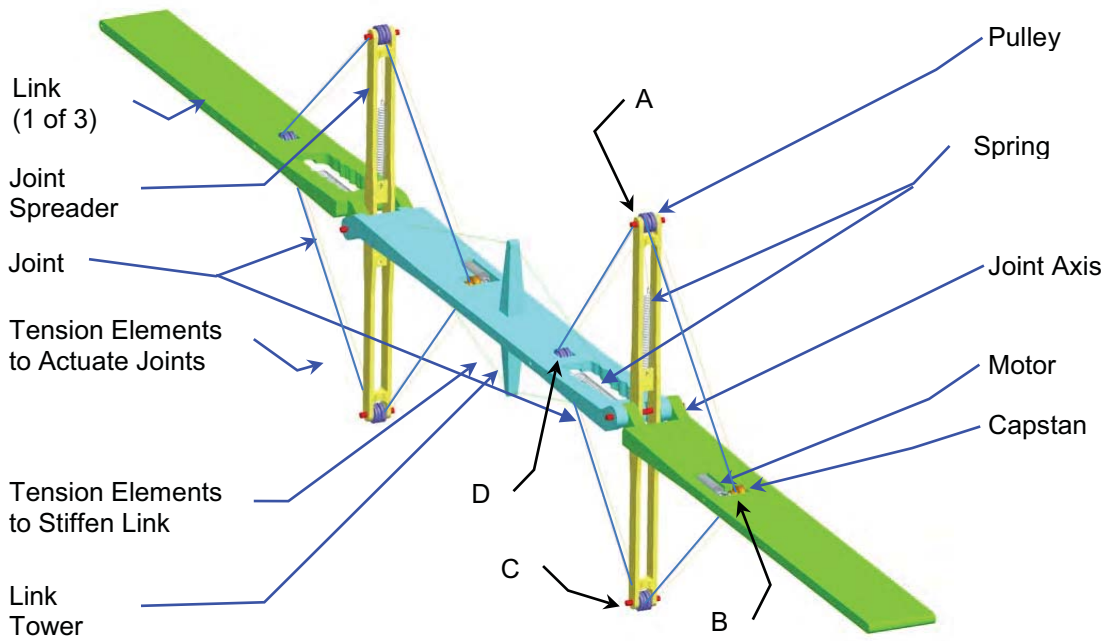

Figure 1. Planar embodiment of the Invention with Multiple Joints

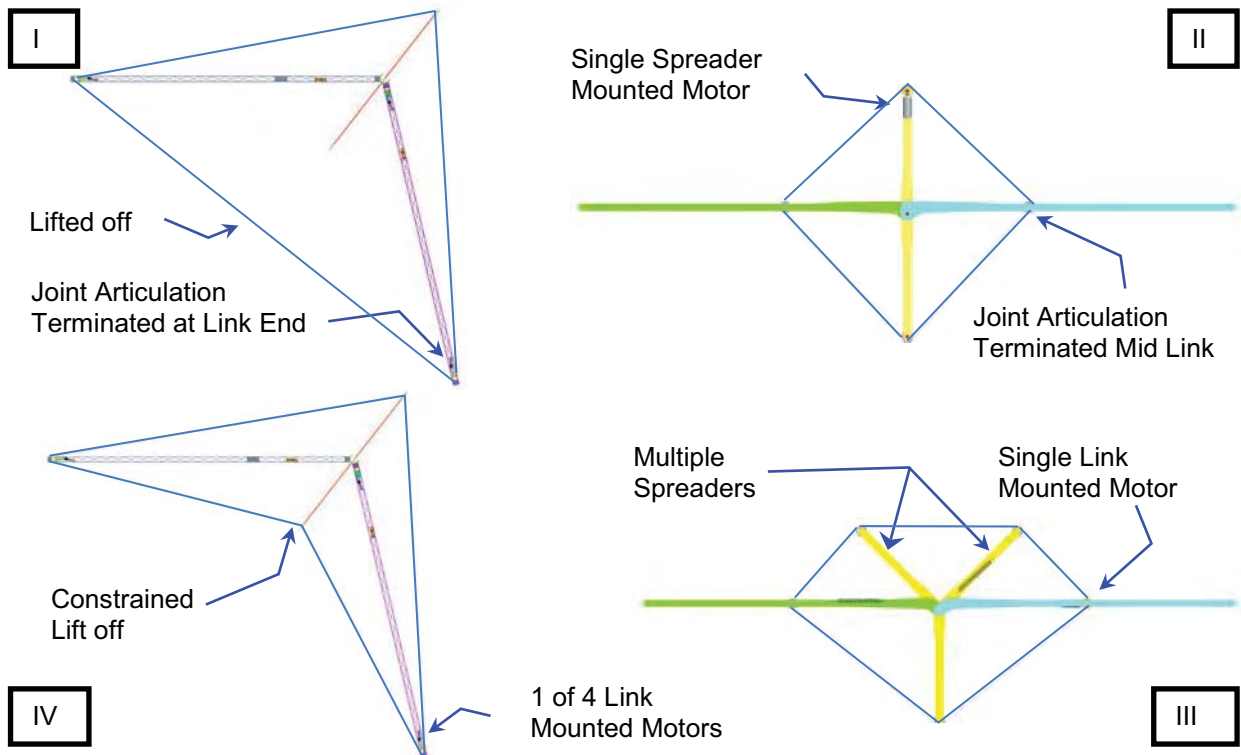

Figure 2. Variations of Tension Actuated Joint

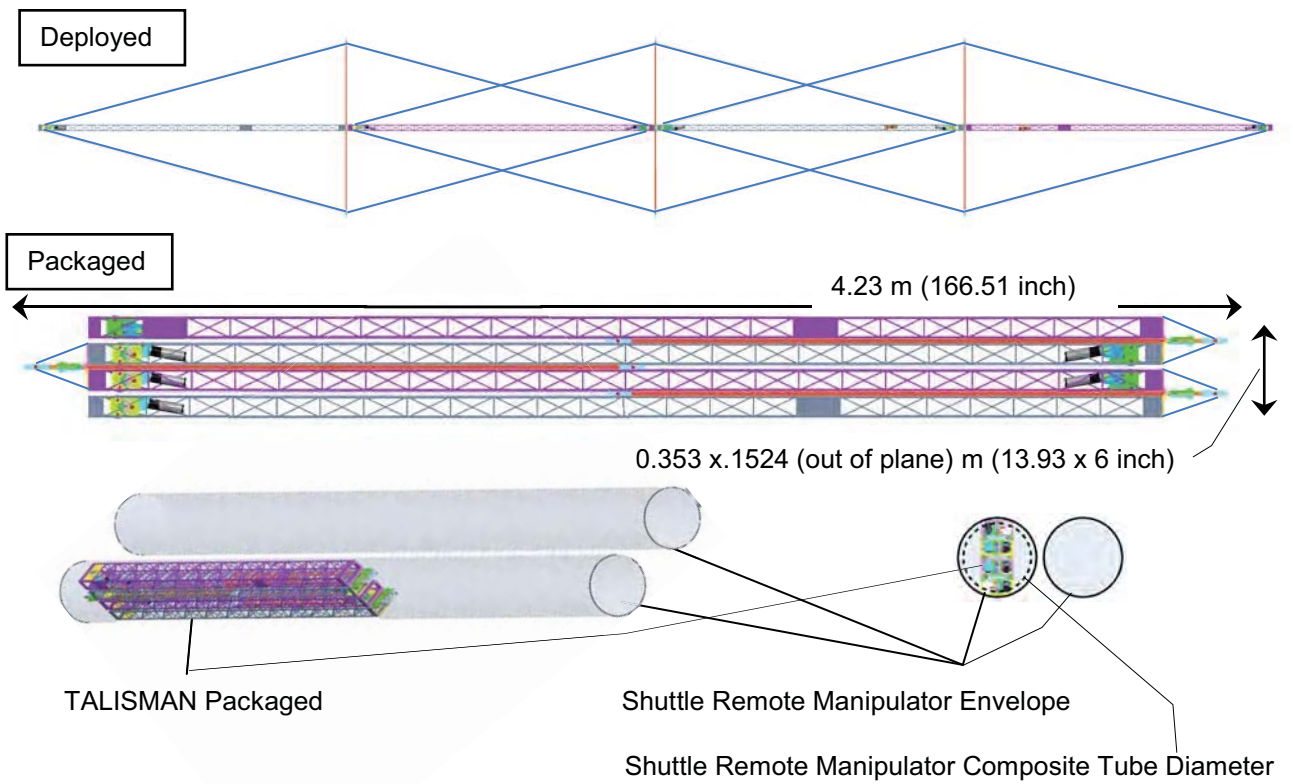

Figure 3. Packaging of TALISMAN

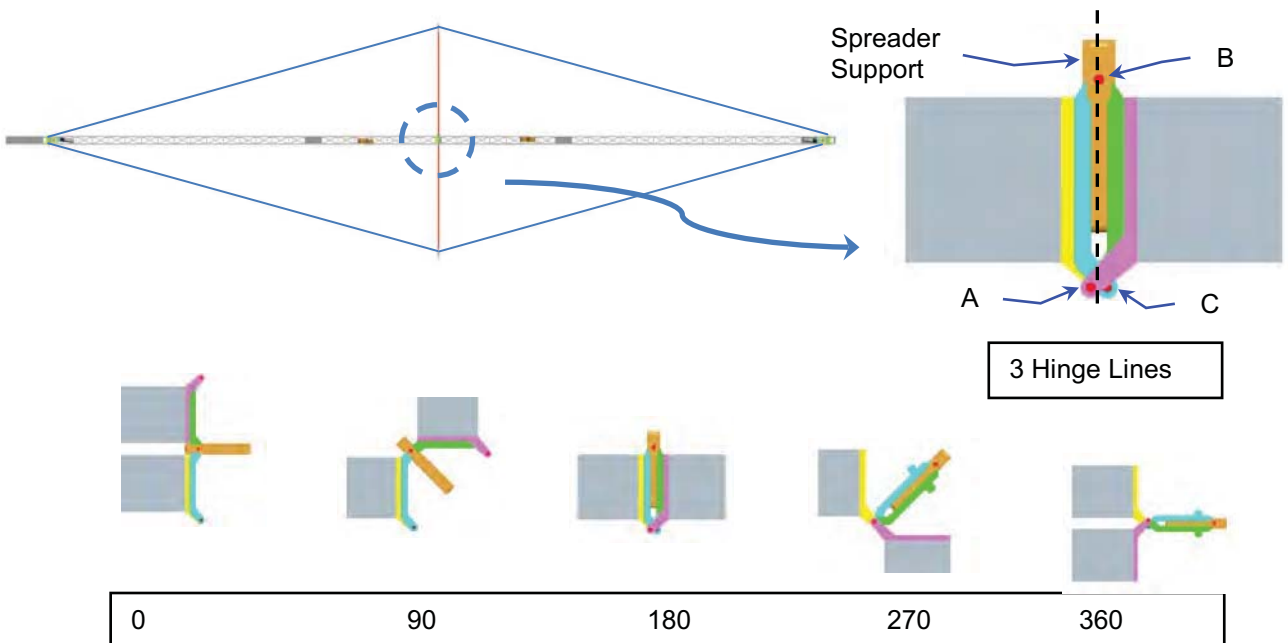

Figure 4. Novel Joint Provides 360 Degree Rotation

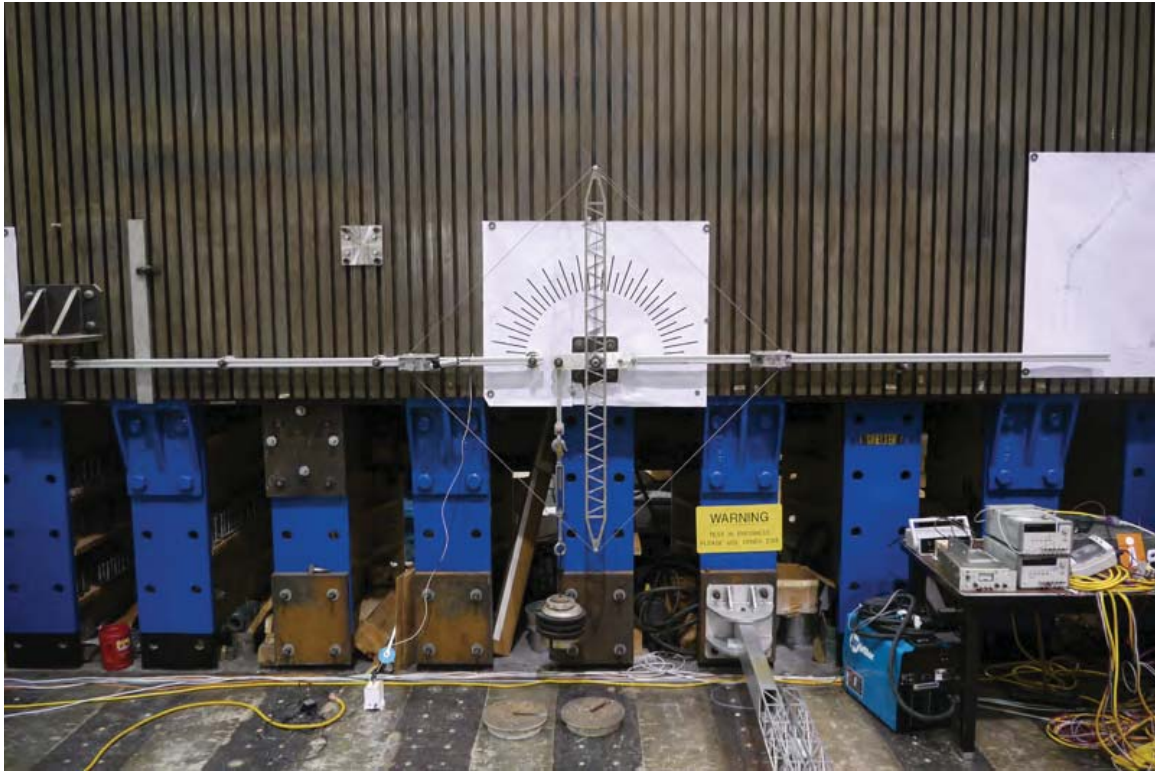

Figure 5. Tendon evaluation test bed set up showing option 1.

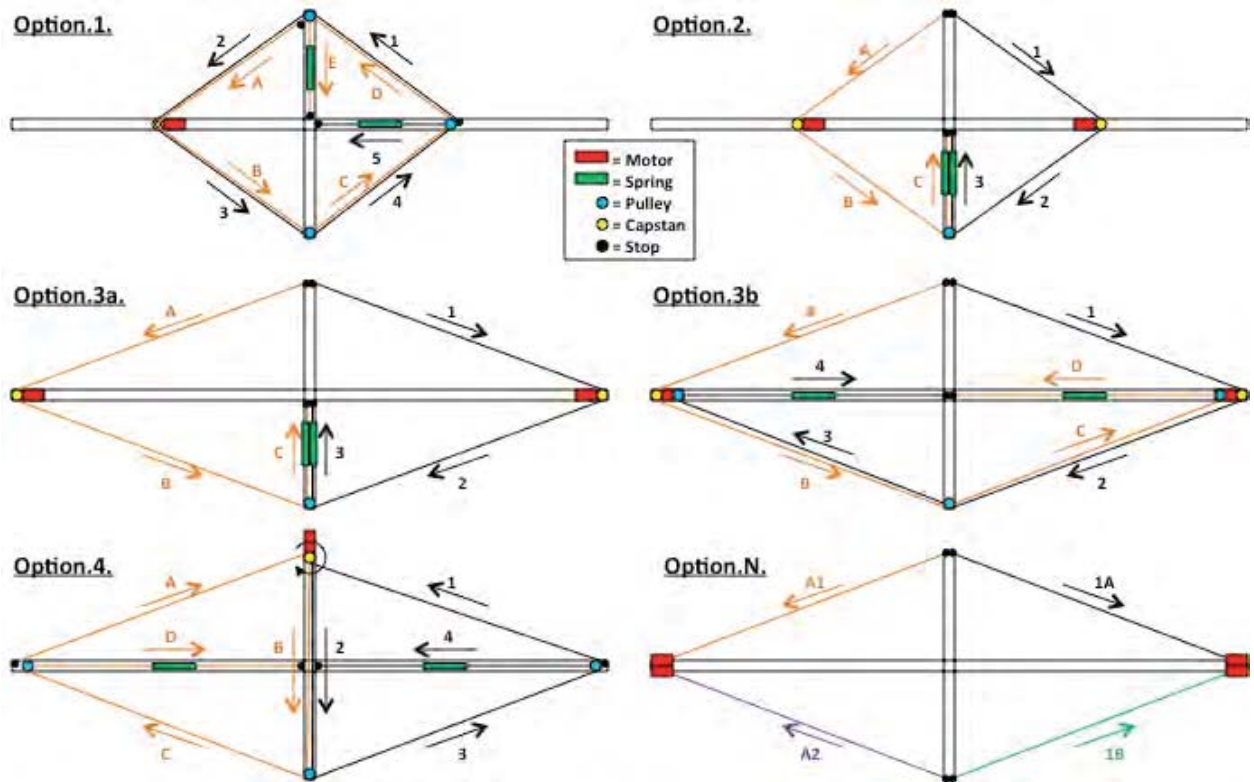

Figure 6. Tendon evaluation test bed set up.

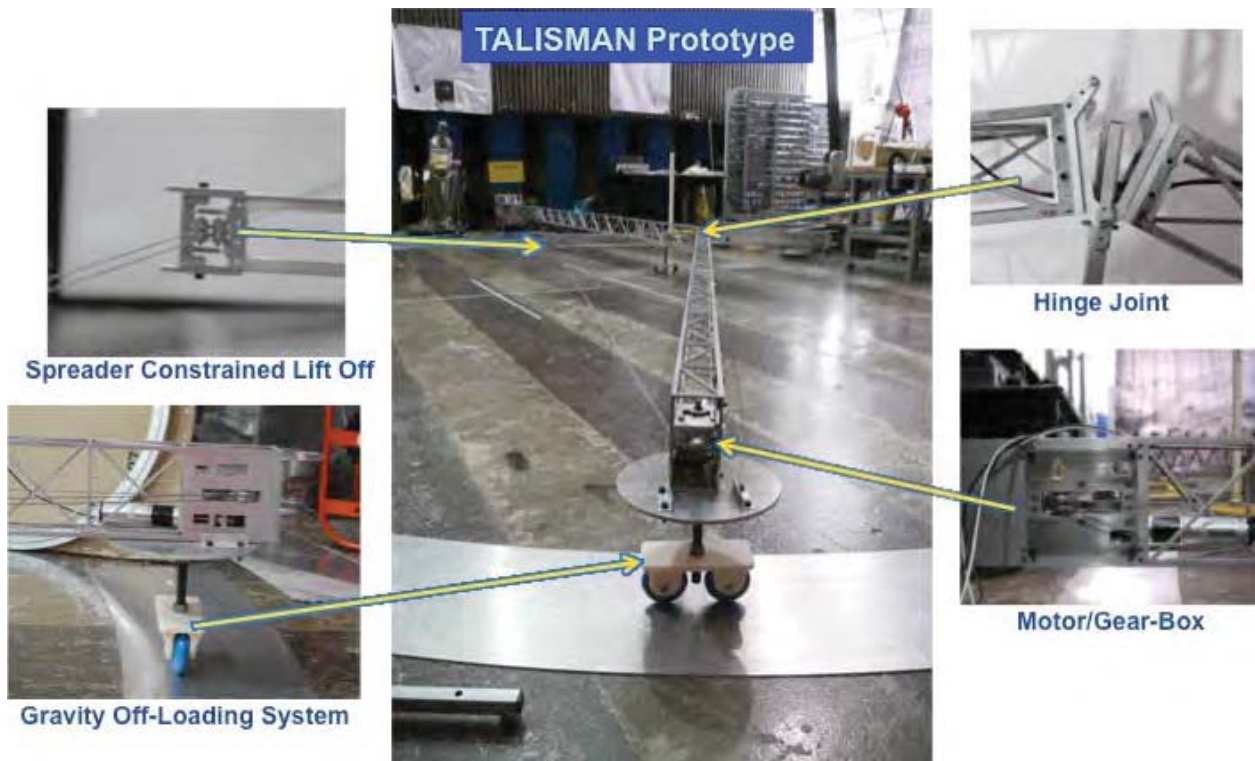

Figure 7. Prototype of TALISMAN tendon actuated joint section.

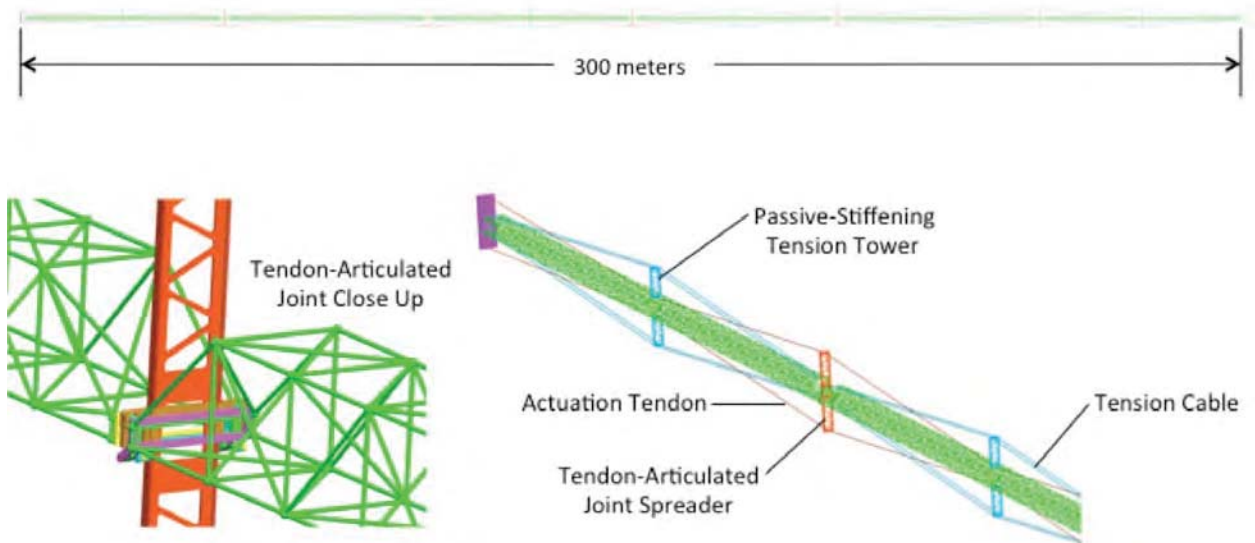

Figure 8. 300-meter-long TALISMAN configuration.

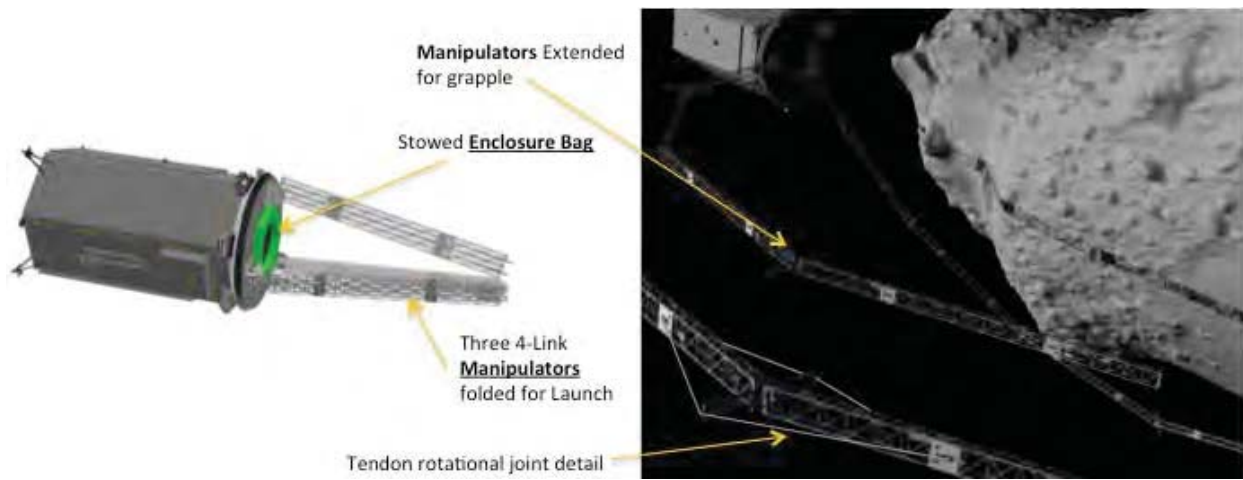

Figure 9. Asteroid capture mechanism TALISMAN configuration.

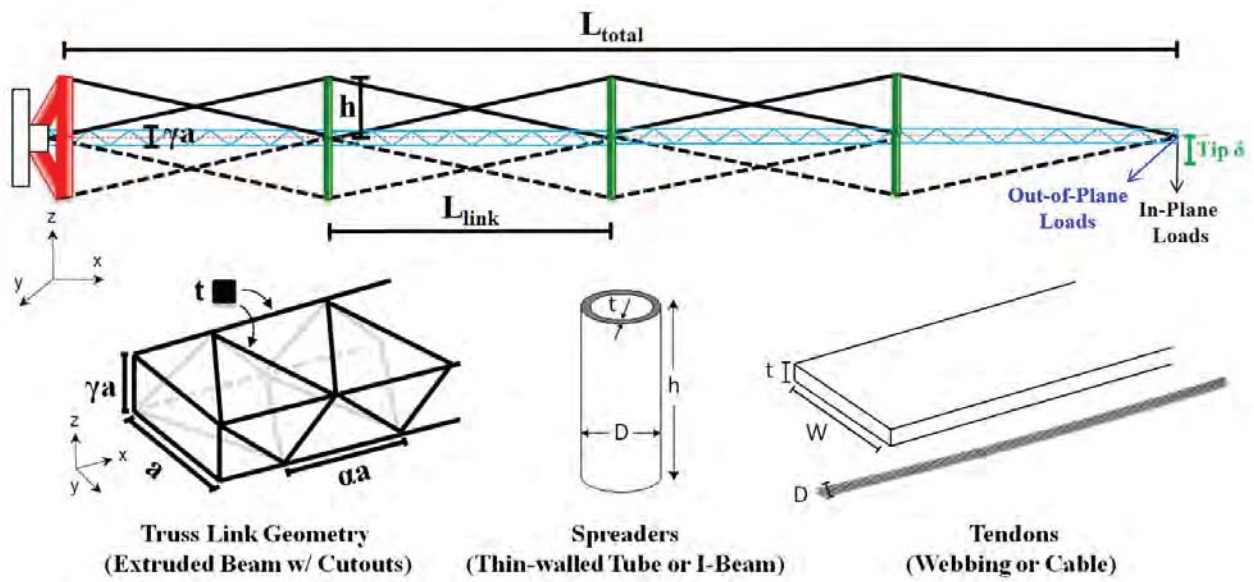

Figure 10. TALISMAN design tool member geometry, loads and tip displacement