



Lunar Pallet Lander (LPL)

Detailed overview of the NASA robotic lander concept

Summer 2015

Joshua Moore
Greg Chavers

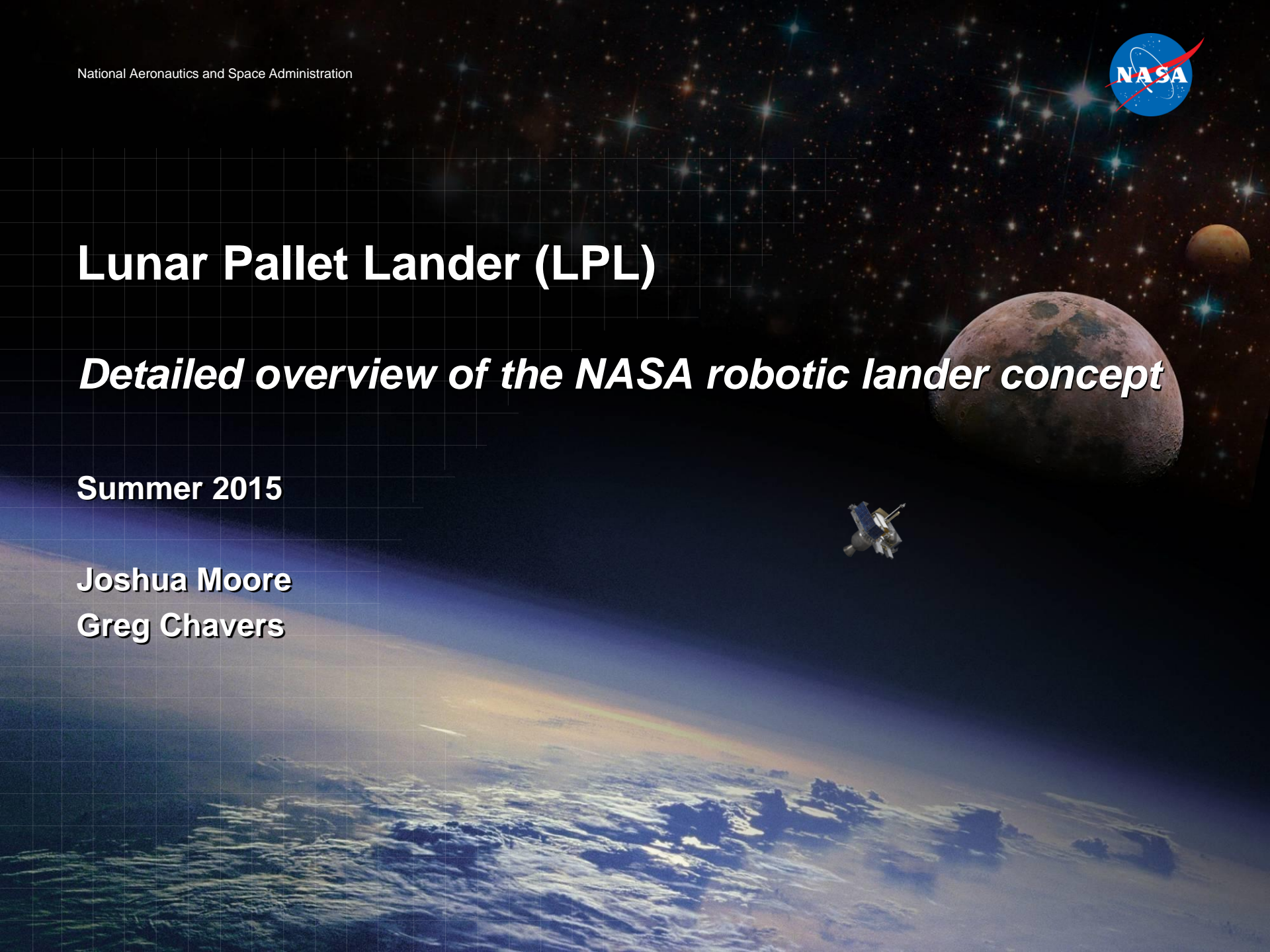

Getting There...



- Cruise Phase:
 - 5-day direct Earth to Moon transfer w/Deep Space Network S-band
 - Spin up to 6 deg/s using Attitude Control System (post-Trans Lunar Injection)
 - Perform system checkout
 - Perform two Trajectory Control Maneuvers (nominal)
 - Perform two Neutron Spec calibrations (nominal)

- Contingency / Off nominal
 - Allows for two (2) additional TCMs
 - Propellant margin for spin / de-spin for thermal anomalies

Moon Arrival
(Direct Descent)

Earth Departure

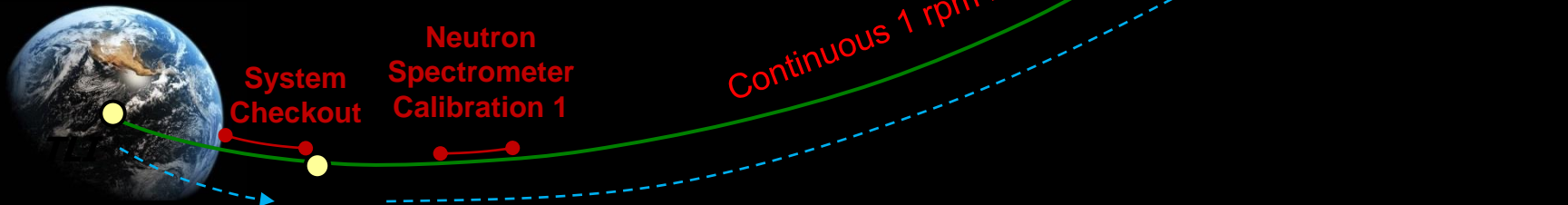

Mission Phases of Flight

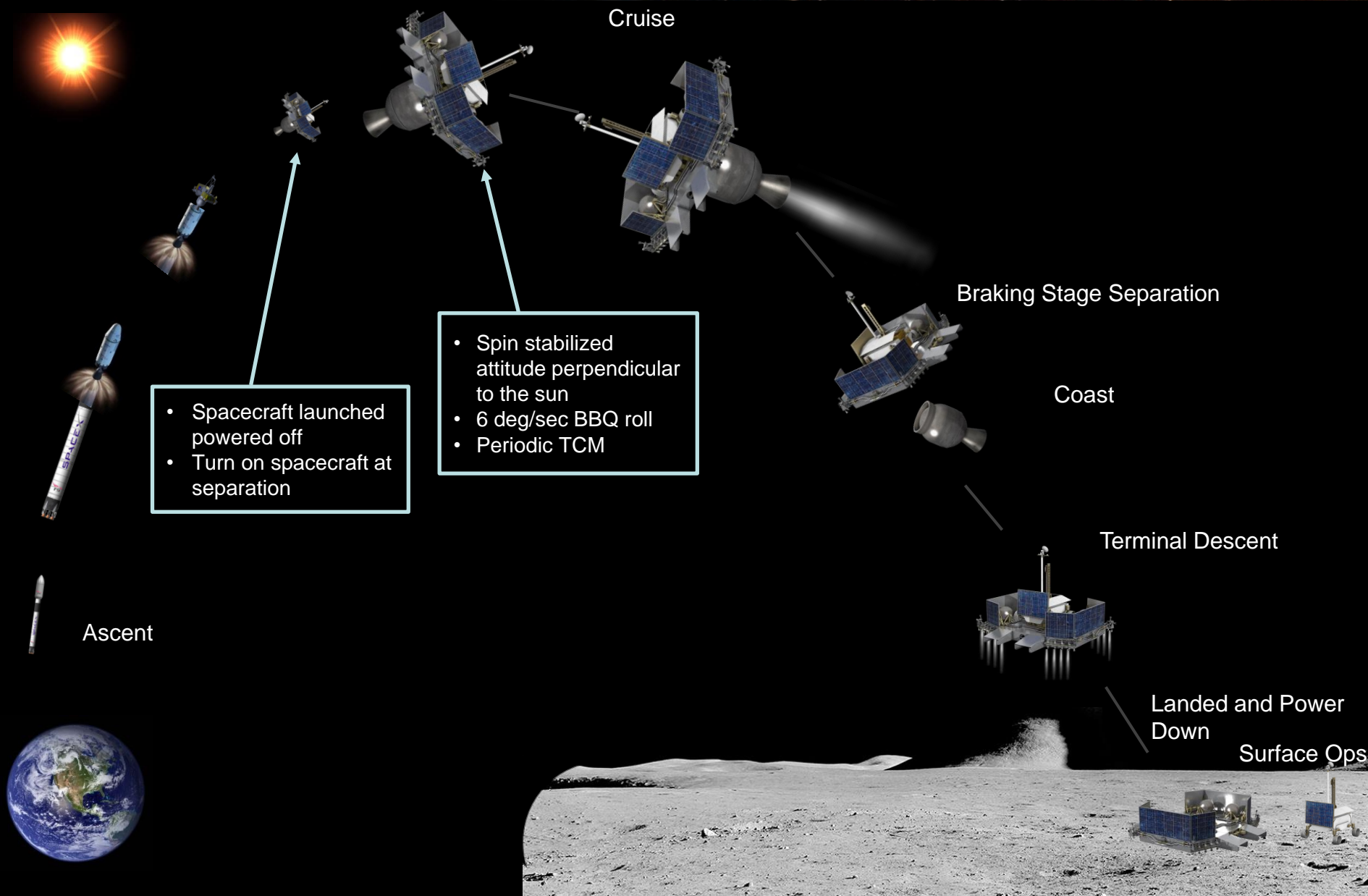

Flight Design Validation through Rigorous Prototype and Testing

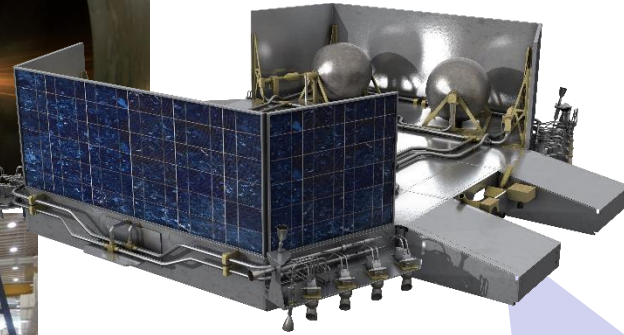
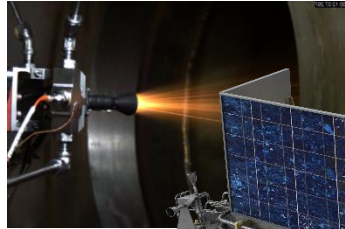
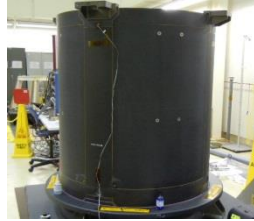
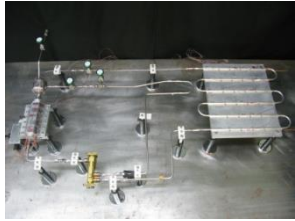

Near-Earth Asteroids



Moon



Thermal & Battery Tests

Software and Avionics Tests

Propulsion Thruster Hot Fire and Lander Stability test

Flight Robotic Lander



Mars / Phobos-Deimos

Robotic Lander Prototype



Cold Gas Test Article



GNC, Software, Avionics, Structures Test with a Pulsed Propulsion System



Initial Design

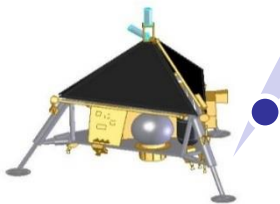

Integration of NASA Lander Activities



Mighty Eagle



Morpheus



NASA Robotic Lander Concept

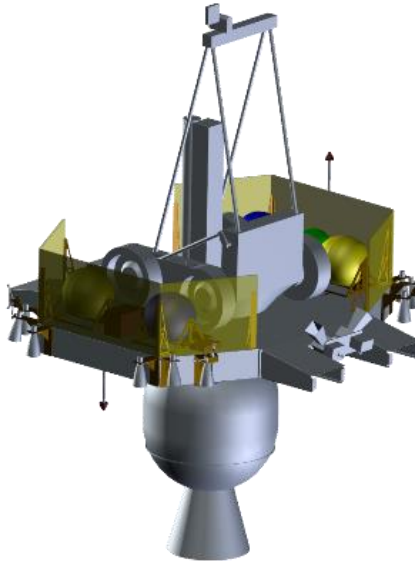

Commercial or International Partner



NASA Robotic Lander Concept



- NASA class D, requirements driven, low cost, rover delivery lunar lander (~325 kg rover + payload)
 - Single string except for personnel safety
 - This lander is low cost and will fit on a Falcon 9 V1.1
 - This lander has on-ramp or evolvable options for increased performance
 - This lander can be built with little technology development
 - Some tech development could enhance the performance
- Schedule (42 months (Funded to Launch), due to long lead items (tanks and thrusters))
 - 36 months if lander size is optimized for existing components (i.e. propellant tanks).
 - Reduced procurement cycle

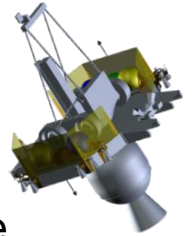

Physical Block Diagram

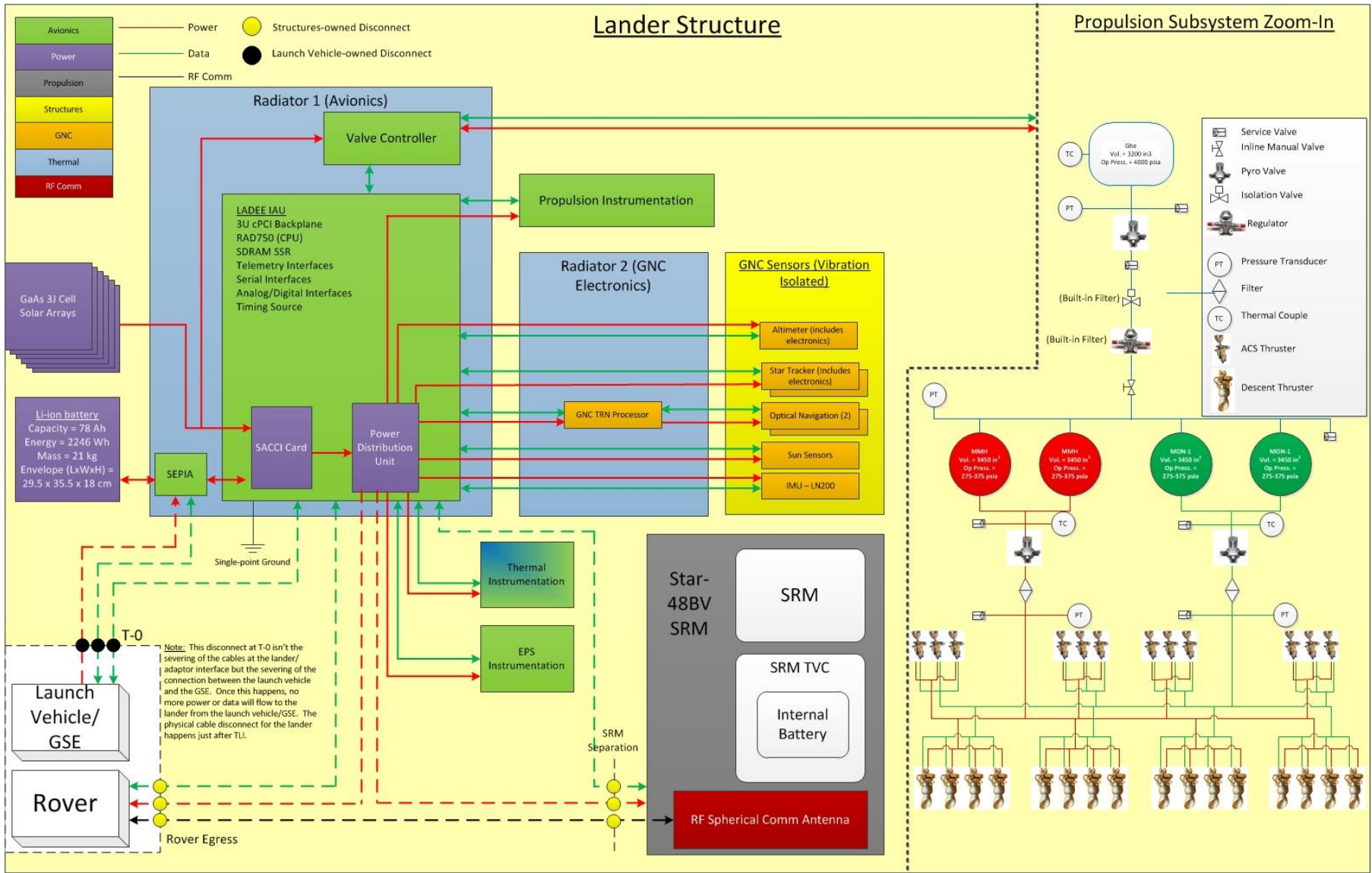

Landing Site Selection



- Terrain Topography Analysis (Landing Site Selection Team, ARC)
 - Local high-resolution DEM (digital elevation model) not available for candidate sites yet.
 - Analog Malapert DEM (~5m posts) available for slope analysis.
 - New DEM commissioned of near north pole candidate site.
- Surface Features (JPL)
 - Uses LRO/NAC automated image analyses (craters, boulders).
- Hazard Assessment (MSFC, JSC, APL, ARC, JPL)
 - Compares lander capability to surface characterization maps to derive hazard risk maps
 - Extrapolates high-resolution results to low-resolution data to assess risky, but unresolved, hazards

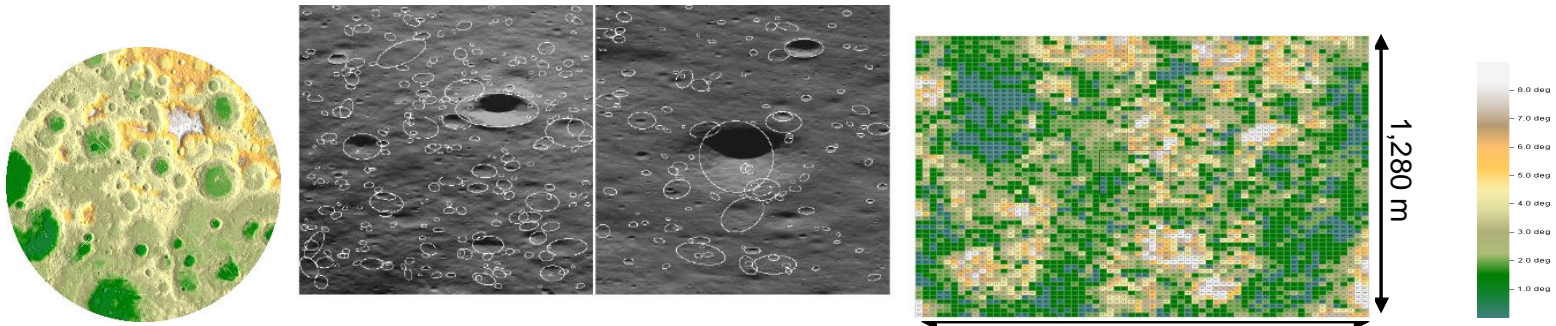

Operations Timeline

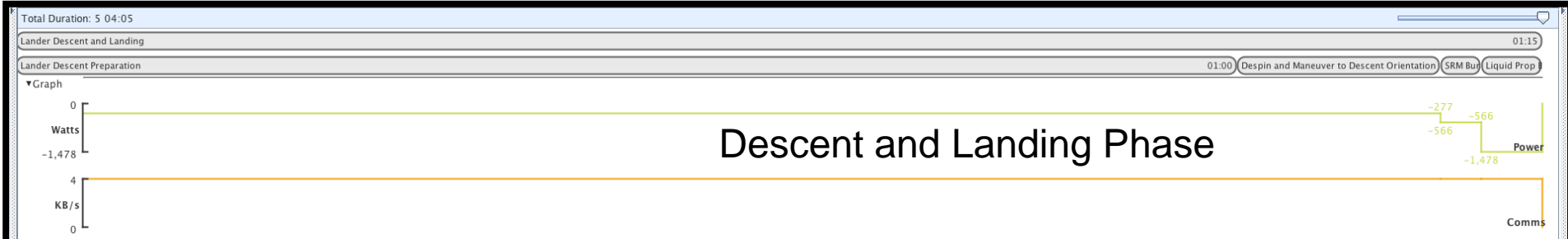
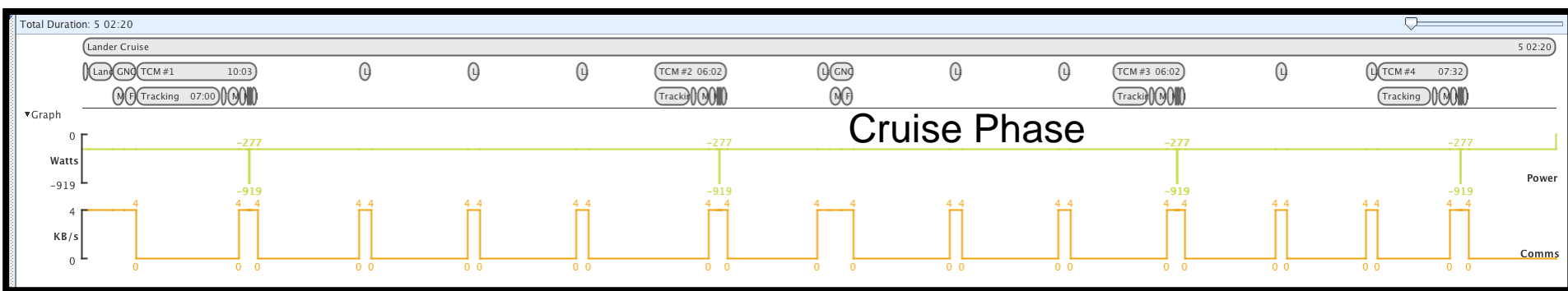

Lander Integration Considerations



- Integrated systems references:
 - Drawing tree
 - Master Equipment List (MEL)
- Component integration considerations:
 - Component maturity level
 - Proximity - power source/Thermal Radiator
 - Placement affects center of mass
 - Placement to reduce shadowing - cameras/sun sensors
- Integrated models - consistency throughout the team
 - Metric units
 - Assigned material properties
 - ProE - Creo. 2.0 CAD models
- Maturing subsystems affect the integrated design
 - Avionics - weight/placement
 - Thermal - radiators /MLI blankets
 - Power - solar arrays/battery

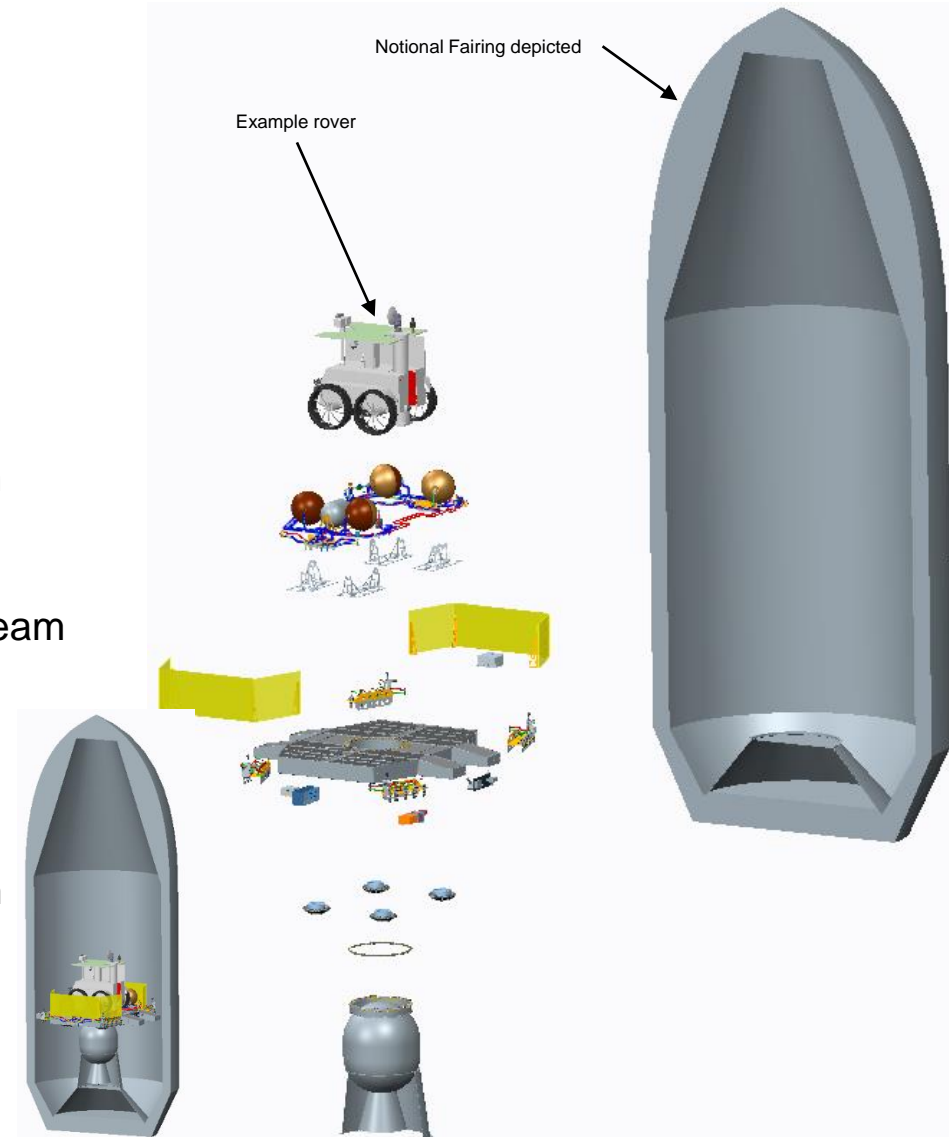

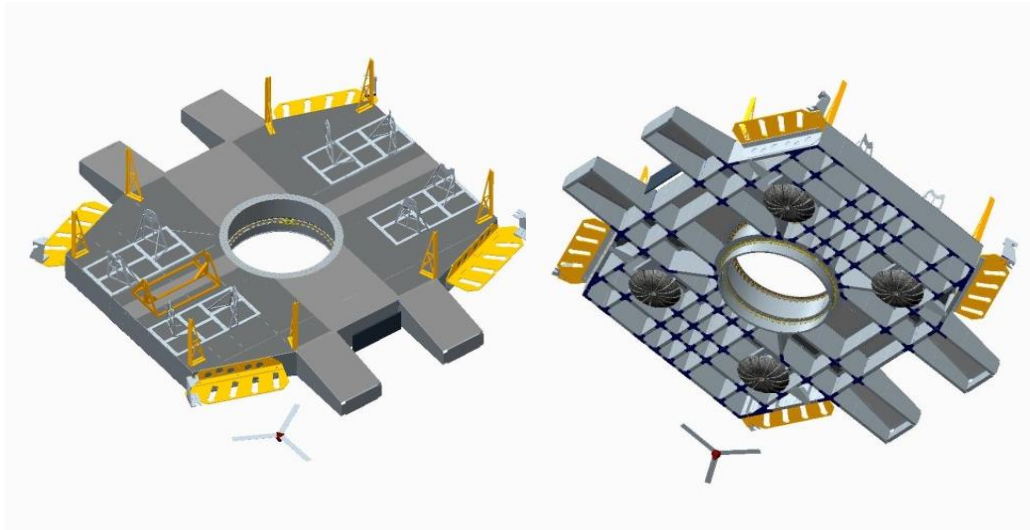

Landing Pads
219 mm (8.6") 'thick'
712 mm (28") dia

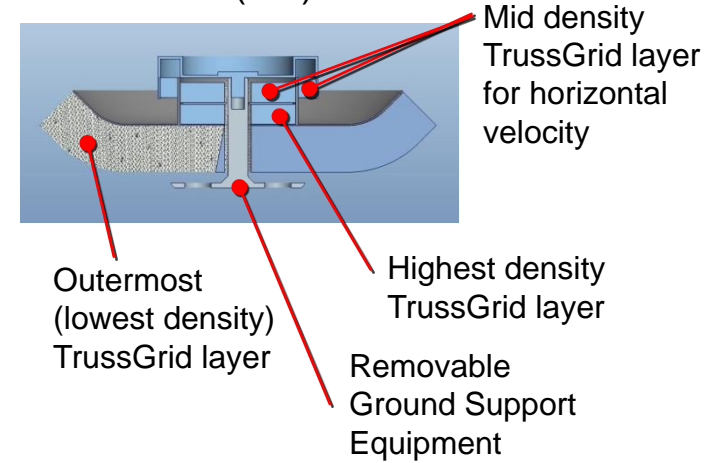

- Protoflight structural approach
- Prototype pallet structure build is complete



Primary Natural Frequencies

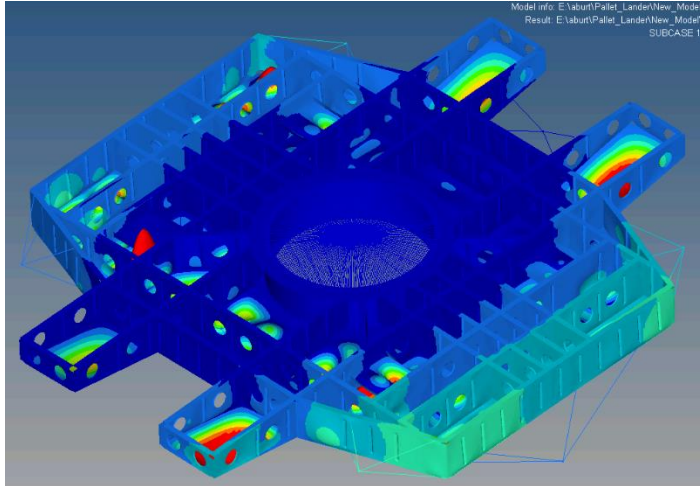

Parameters that affect natural frequencies

- How the non-structural mass is distributed
- Placement of large mass items (as well as accuracy of the mass, i.e. propellant tanks)
- Depth of beams
- Beaded patterns in beams
 - Boundary conditions fixed at the inner ring where it would be attached to the Solid Rocket Motor.
 - Primary Natural Frequencies
 - X – 23 Hz, 15% mass participation
 - Y – 38.5 Hz, 2% mass participation
 - Z - 48 Hz, 5% mass participation
 - The axial frequency does not meet the desired 35 Hz, nor the required 25 Hz
 - However, the mass participation is low so it may not be of great concern
 - Design solutions can be worked to increase the natural frequencies in this direction

Stress

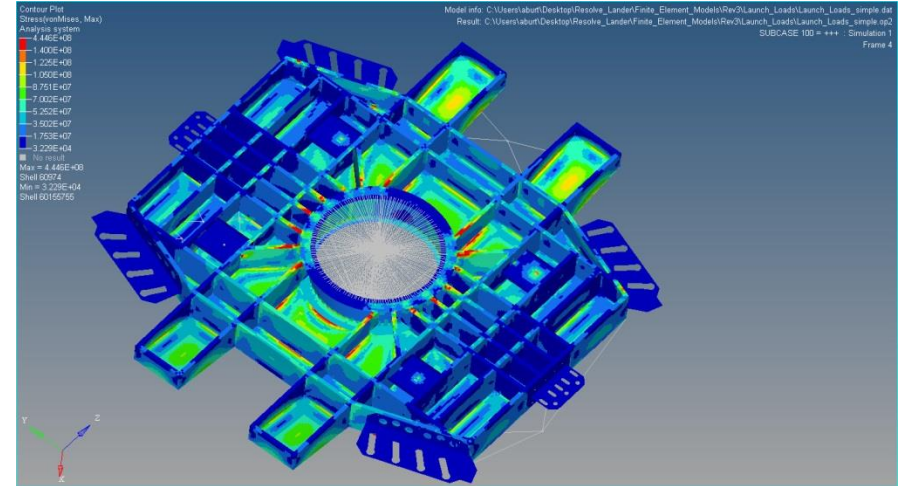

- Highest loaded areas are near the central load ring
- Other hot spots exist but need to be looked at more thoroughly as they are rigid body attach points which can produce arbitrarily high stress results
- The mass properties of subsystem components were obtained from the Master Equipment List
- The mass used is that of everything on the second stage, physically located above the Solid Rocket Motor
- Tanks and large boxes are modeled as 1D mass elements
- Other masses such as wiring, cabling, thermal insulation carried as non-structural mass smeared over the top deck
- Total wet mass = 1586 kg (3,490 lbs)

Quasi-Static Load Factors Contribution



Launch Ascent

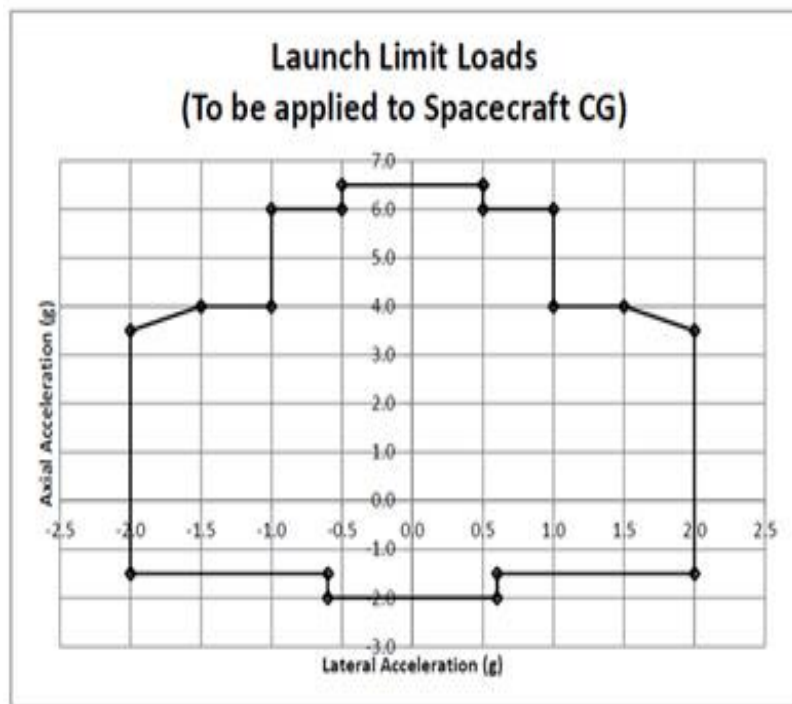

Single load case created using 6.5 G's axial and 2 G's lateral inputs to envelope all load cases

Braking Burn STAR48 Operation

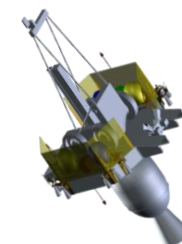

Star48 Motor	Lander		
	Mass	Acceleration	
(N)	(kg)	m/sec ²	G's
77800	1312	59.3	6.0

- The given thrust for the STAR48 for the lander vehicle mass produces 6 G's axial acceleration.
- Lander longitudinal accelerations assume the most conservative proportion of launch quasi-static environments at 2 G's (1/3 axial).

Summary of Combined Loads * for Launch and Star 48



- This dynamics analysis provides an in-depth understanding of each individual component response to all mission flight events.
- Load prediction methodology allows ample flexibility to accommodate changes in spacecraft design and launch vehicle architecture.

Launch			
Assembly	Axial (G)	Lateral 1 (G)	Lateral 2 (G)
Power Box	6.7	2.2	2.3
Battery	6.7	2.2	2.3
Communications Box	6.7	2.2	2.3
X-Band	7.3	3.3	2.4
X-Band Diplexer	7.3	3.3	2.4
X-Band SSPA Amplifier	7.3	3.3	2.4
COMSEC Unit	7.3	3.3	2.4
GNC_Star_Tracker	7.5	2.1	2.5
Solar Panel	7.1	2.6	2.4
Oxidizer Propellant Tank	6.7	2.2	2.3
Fuel Propellant Tank	6.6	2.2	2.3
Helium Pressurant Tank	6.7	2.5	2.3
Thrusters	6.9	2.6	2.4
Rover	6.5	2.0	2.4
Landing Pads	7.0	2.4	2.2

STAR48 Operation			
Assembly	Axial (G)	Lateral (G)	Lateral 2 (G)
Power Box	7.1	2.7	2.6
Battery	7.1	2.7	2.6
Communications Box	7.1	2.7	2.6
X-Band	6.9	3.0	2.7
X-Band Diplexer	6.9	3.0	2.7
X-Band SSPA Amplifier	6.9	3.0	2.7
COMSEC Unit	6.9	3.0	2.7
GNC_Star_Tracker	8.7	3.3	2.6
Solar Panel	7.3	3.4	2.9
Oxidizer Propellant Tank	7.1	2.7	2.7
Fuel Propellant Tank	6.8	3.0	2.7
Helium Pressurant Tank	6.5	2.7	2.7
Thrusters	7.5	3.7	2.8
Rover	8.5	2.8	2.8
Landing Pads	7.2	3.0	2.7

- Denotes higher load

*This is maximum predicted environment with no margin added.

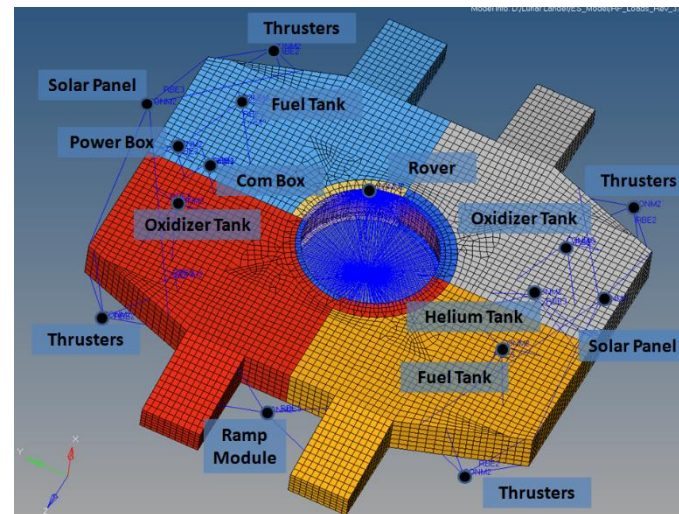

Current Thermal Control Approach & Features



The TCS architecture consists of:

- Spinning (BBQ roll) flight attitude
- Passive, centralized radiators
- Passively controlled heaters
- MLI and optical coatings

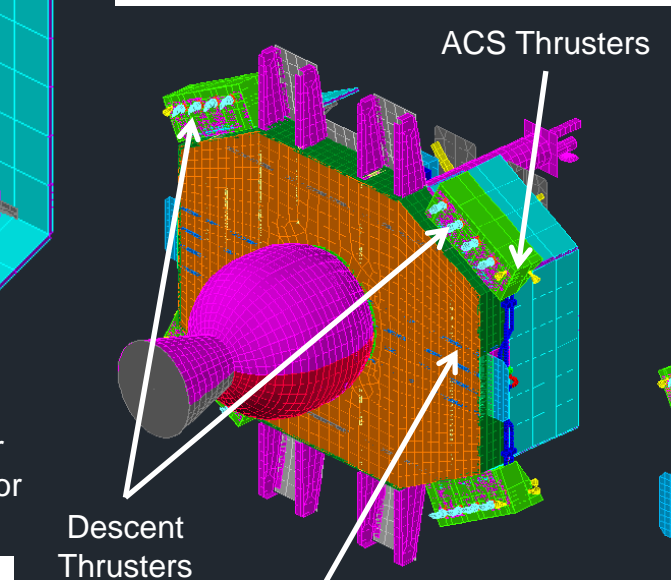
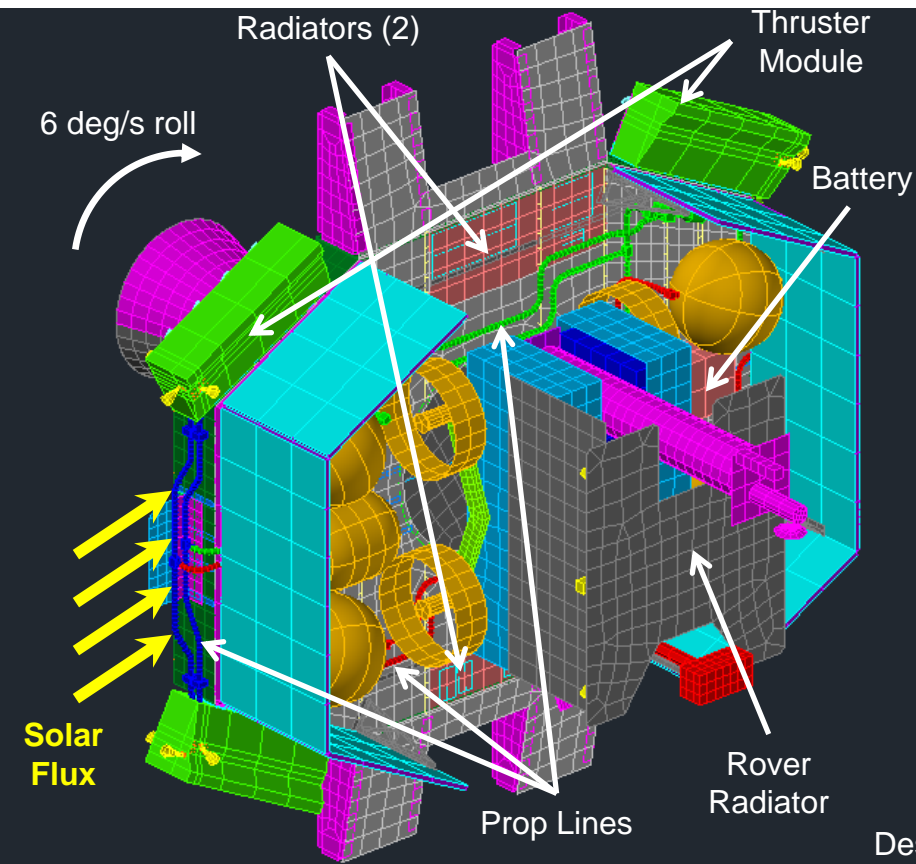

Avionics (blanket & brackets hidden)

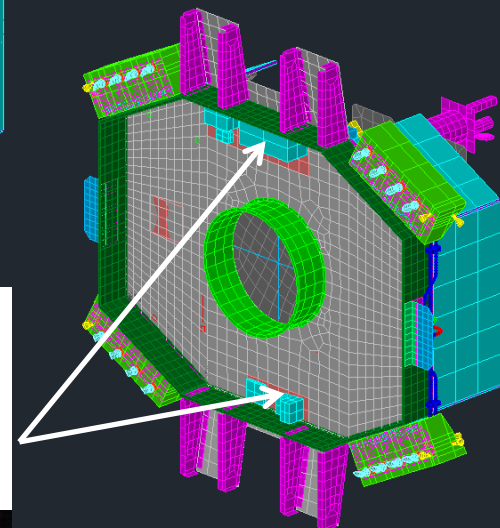

Propulsion Heater Zones and Heater Sizing

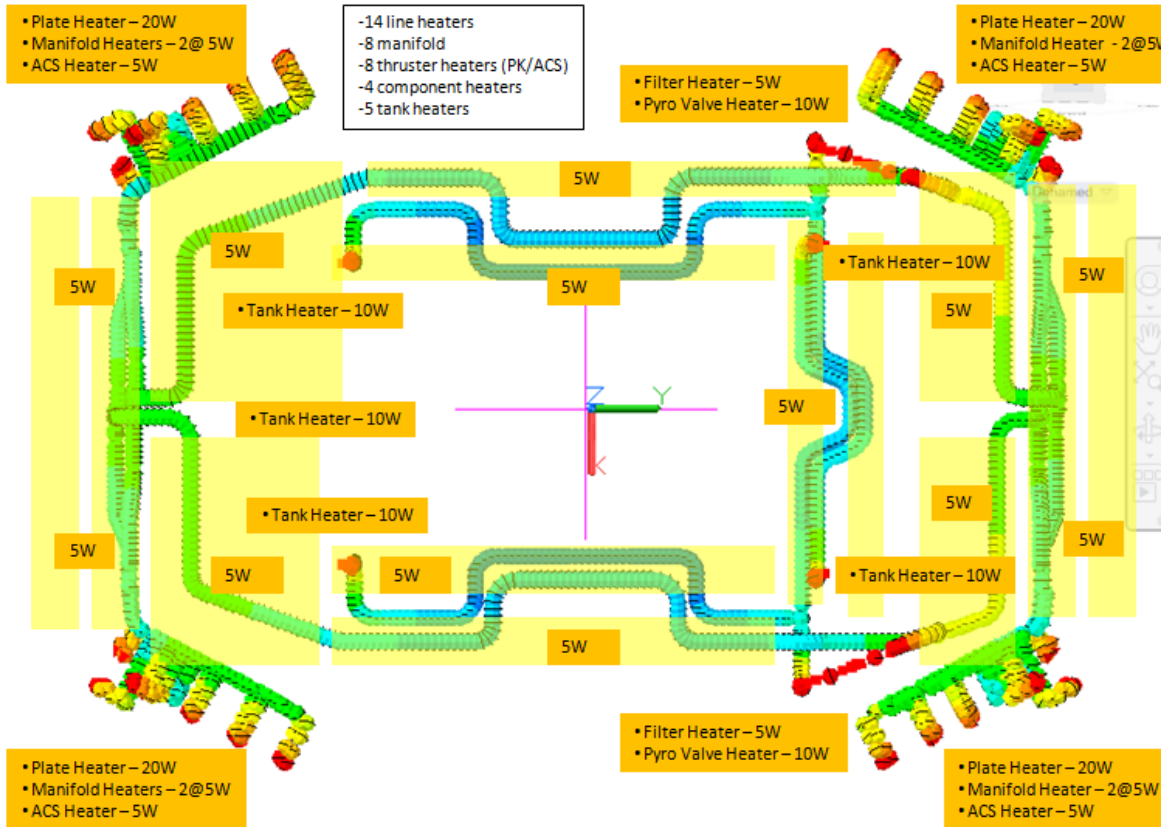

- Heater Zones: 70 total (largest contributor is propulsion with 45 zones)
- Heater zones were defined for nominal conditions, and are being evaluated for suite of other scenarios.
- Each heater is passively controlled – no redundancy assumed

Total Heater Power:

Expected peak heater power draw (Nominal case): 185W

Expected average heater power draw (Nominal case): 100W

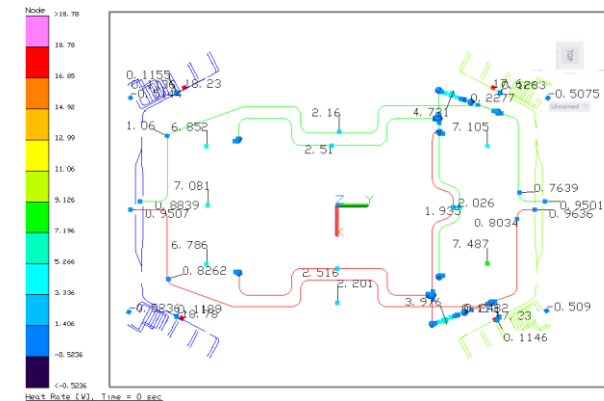

Lander Level Thermal Analyses



Latest Studies

Goals:

- Investigate nominal & transient pointing cases to evaluate component temperature variations and heater power needs
- Pointing cases represent an attempt to bracket the potential behavior encountered during planned & unplanned attitude changes
- Includes all updated subsystem models
- Nominal: 6 deg/s spin with spin axis perpendicular to solar vector.

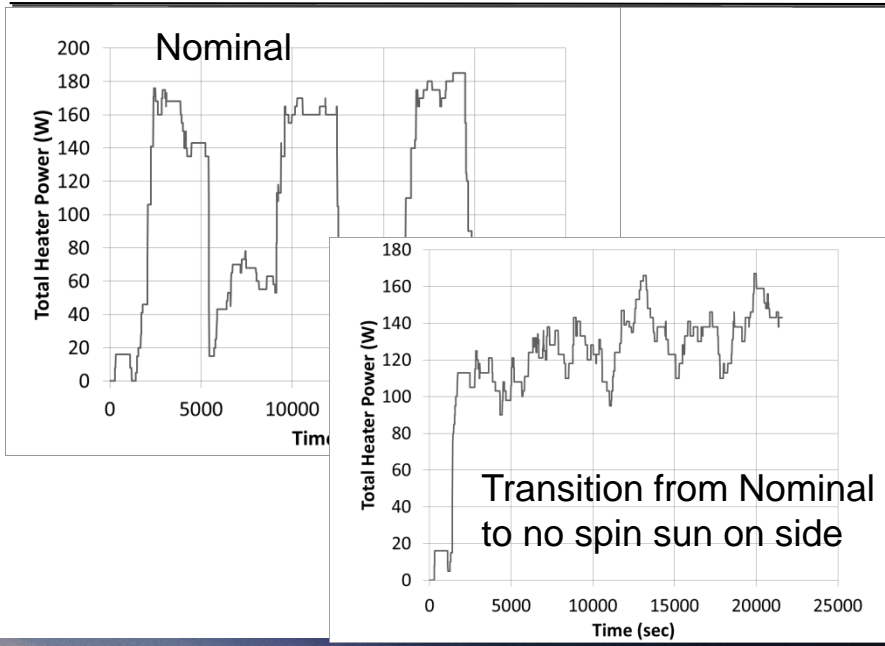
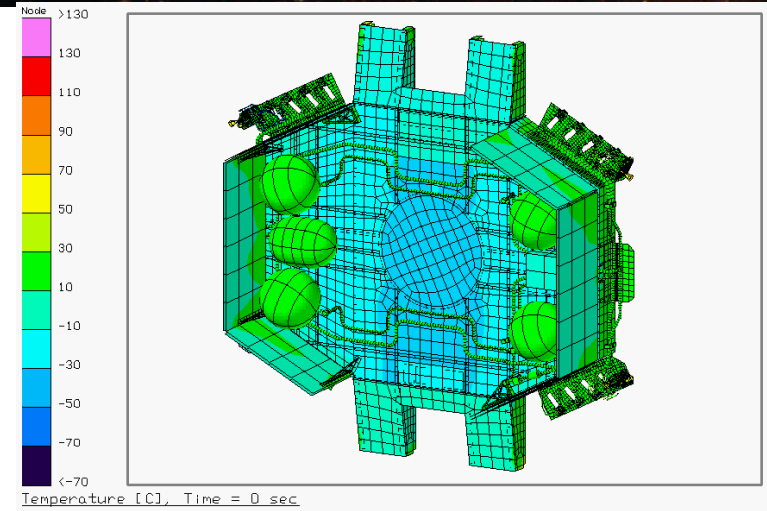

Transition from Nominal to No spin; Sun-side

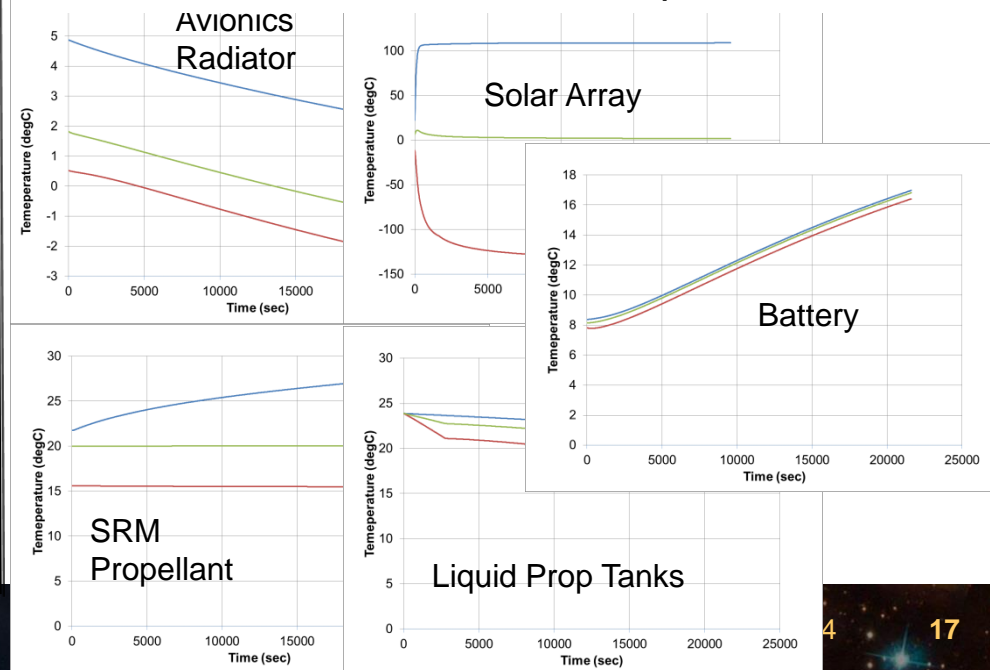

Baseline Architecture Configuration: Cruise



Rover Direct-To-Earth Comm

(Data Umbilical + Coaxial Cable)

(All communication hardware on Rover; Lander has an omni antenna to provide coverage)

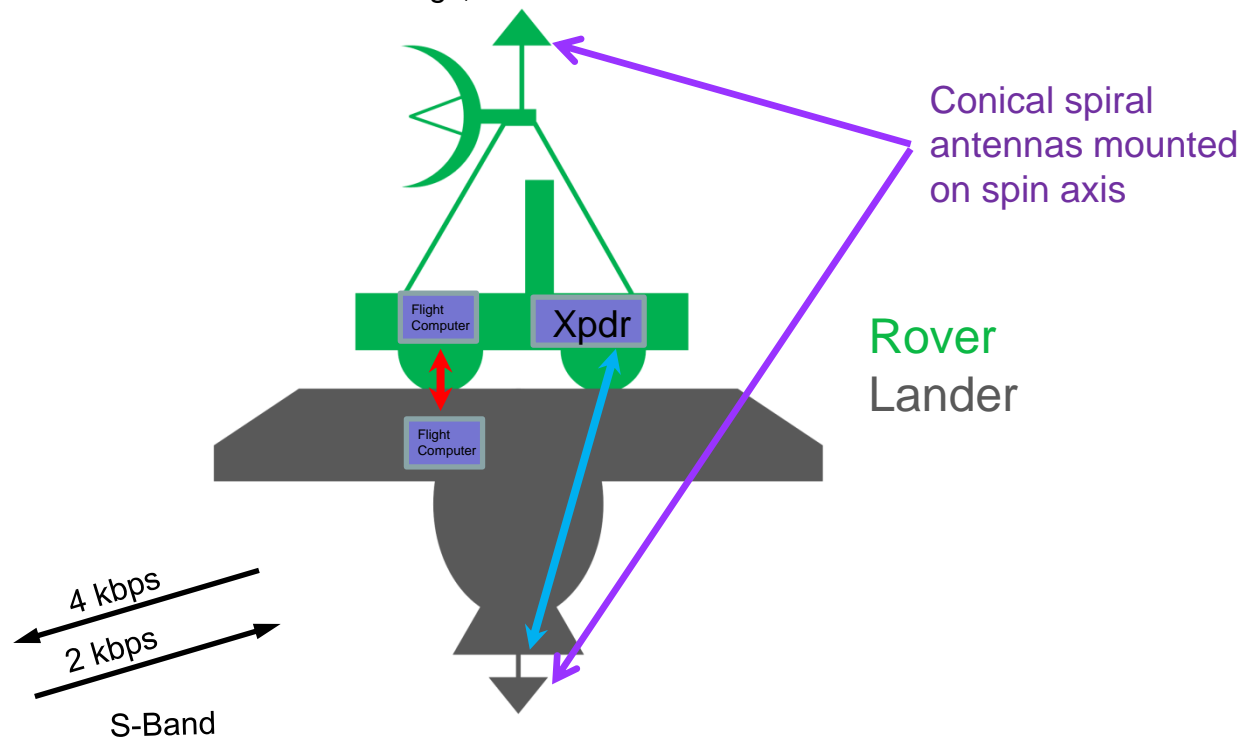

Deep Space Network 34m S-Band



Current Architecture Configuration: Surface



DSN 34m

Uplink: S-band, 2 kbps minimum.

Downlink:

1. S-Band Dish @ 600 kbps (450 kbps user B/W) (Goal: 1.5 Mbps)
2. S-Band Omni Contingency Mode @ 2 kbps

Lander downlinks data on lunar surface before Rover egress.

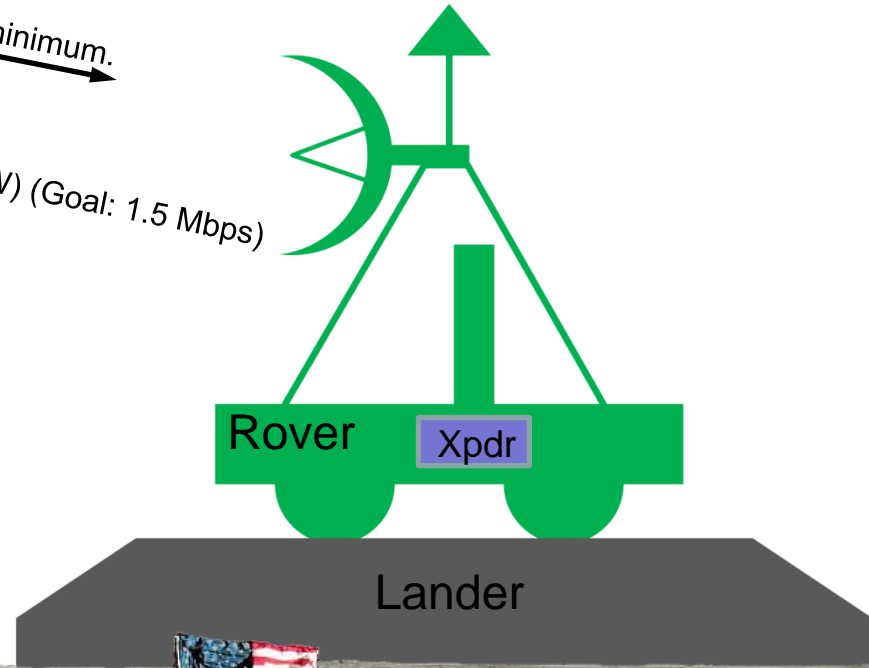

Configuration of Lander communications

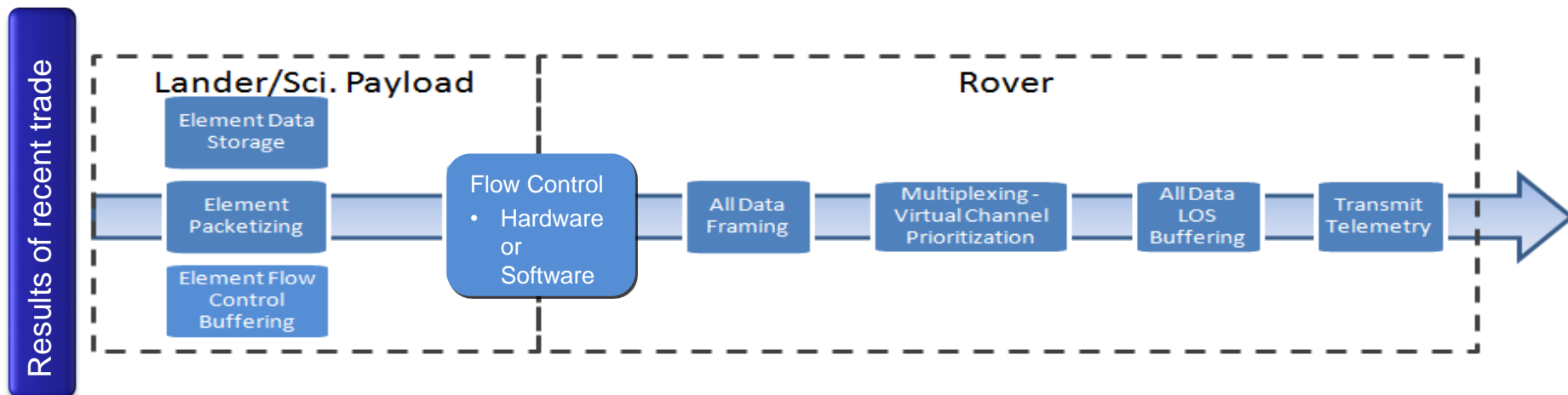
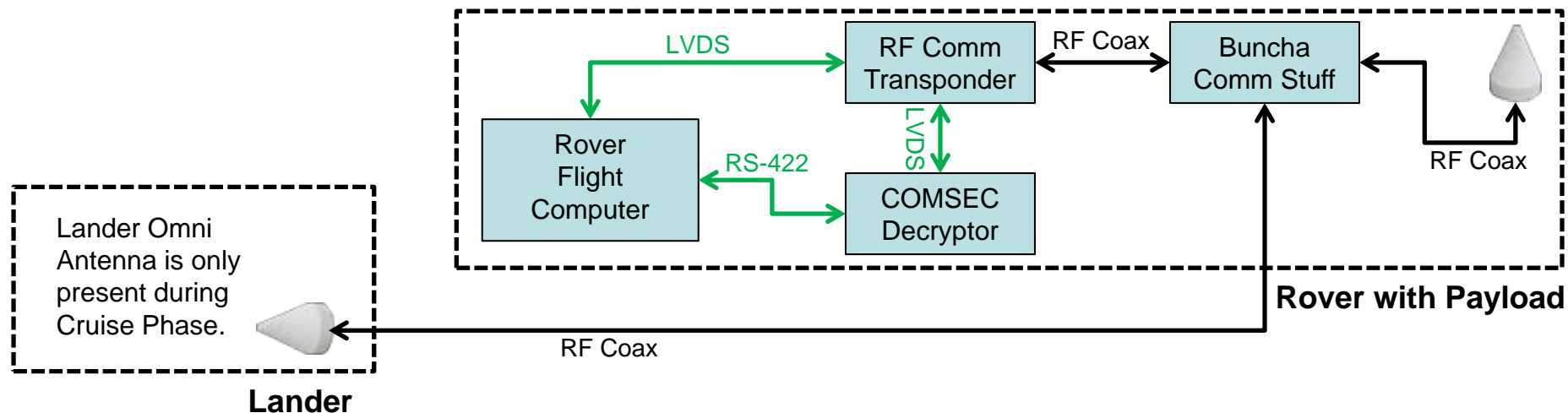

Results of recent trade

Electrical Power System Layout



- Triple Junction Gallium Arsenide Cells
- ~29.5% efficient
- 6 Panels, ~488 W, 13.53 A Avg at panels
 - (2) 1.758 x .711(m), 24 strings, 15 cells
 - (4) .94 x .711(m), 13 strings, 15 cells

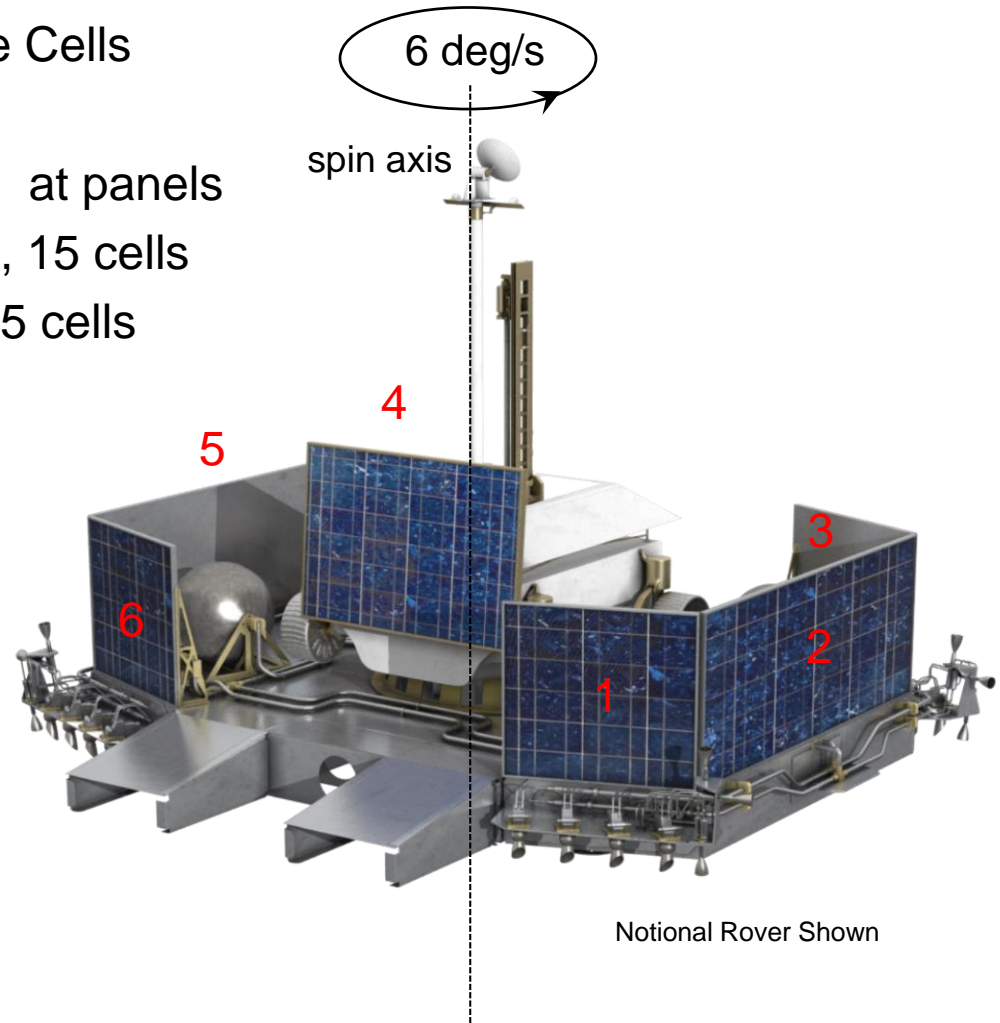
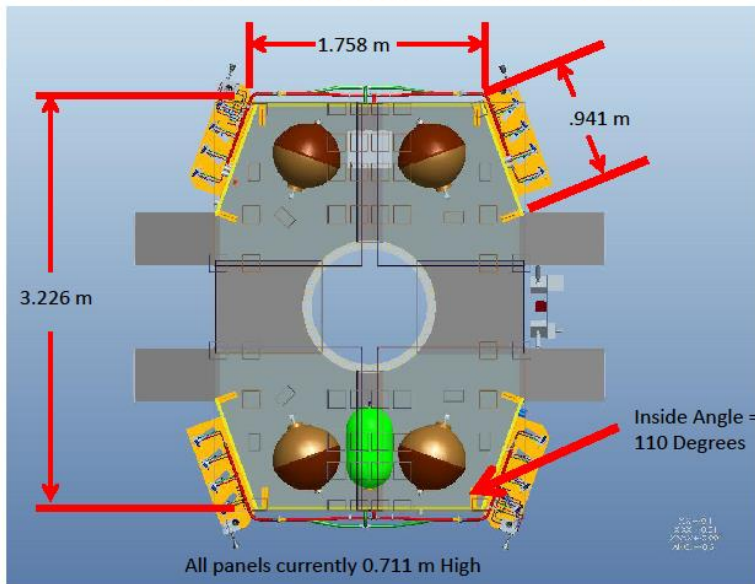

Energy Storage - ABSL BTP 8S52P



- Store Electrical Power
 - 78 Ampere Hour Lithium Cobalt Oxide Battery
 - 21 Kg Flight Configuration
 - 295 mm x 355 mm x 180 mm (l x w x h)
 - 416 Sony 18650HC cells, CID, PTC,
 - Burst Disc, Mandrel Safety Device

Test data for 42
day-night real time
lunar cycles

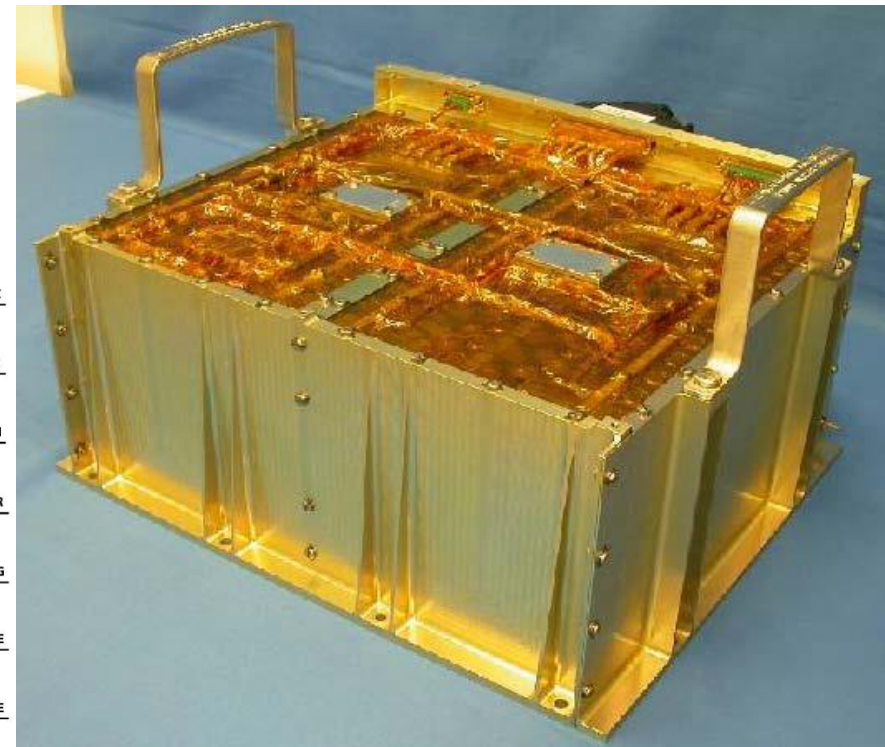

3-DoF Guidance Trajectory Performance Analysis



- Summary of results with Closed-loop Guidance, Perfect Navigation and Flight Control
 - Slow burning SRM will drive the descent starting conditions
 - Fast burning SRM will drive the liquid propellant load and liquid phase guidance logic
 - Increasing the heliocentric transfer time does not improve the initial descent conditions
 - Longer transfers go beyond the Moon's orbit and then back
 - Stay near the Hohmann transfer time (~5 days)
 - Increasing the liquid thrusters thrust and specific impulse (Isp) does improve the payload capability

Optical Navigation Status



- Updated position and velocity estimation algorithms into a single refactored version of the APLNav algorithm that can perform both phases in order to maximize code reuse
- Optimized the rendering algorithm C code and onboard map structures to minimize processing time for position estimation algorithm
- Performed a benchmark test of the updated position estimation code to estimate processing load on a flight processor

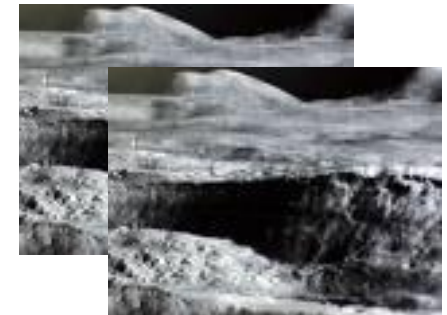

Velocity Estimate

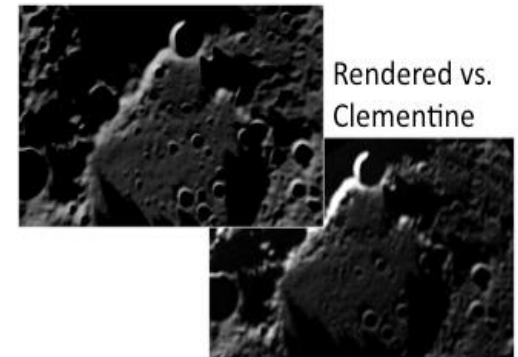

Position Estimate

Software Overview

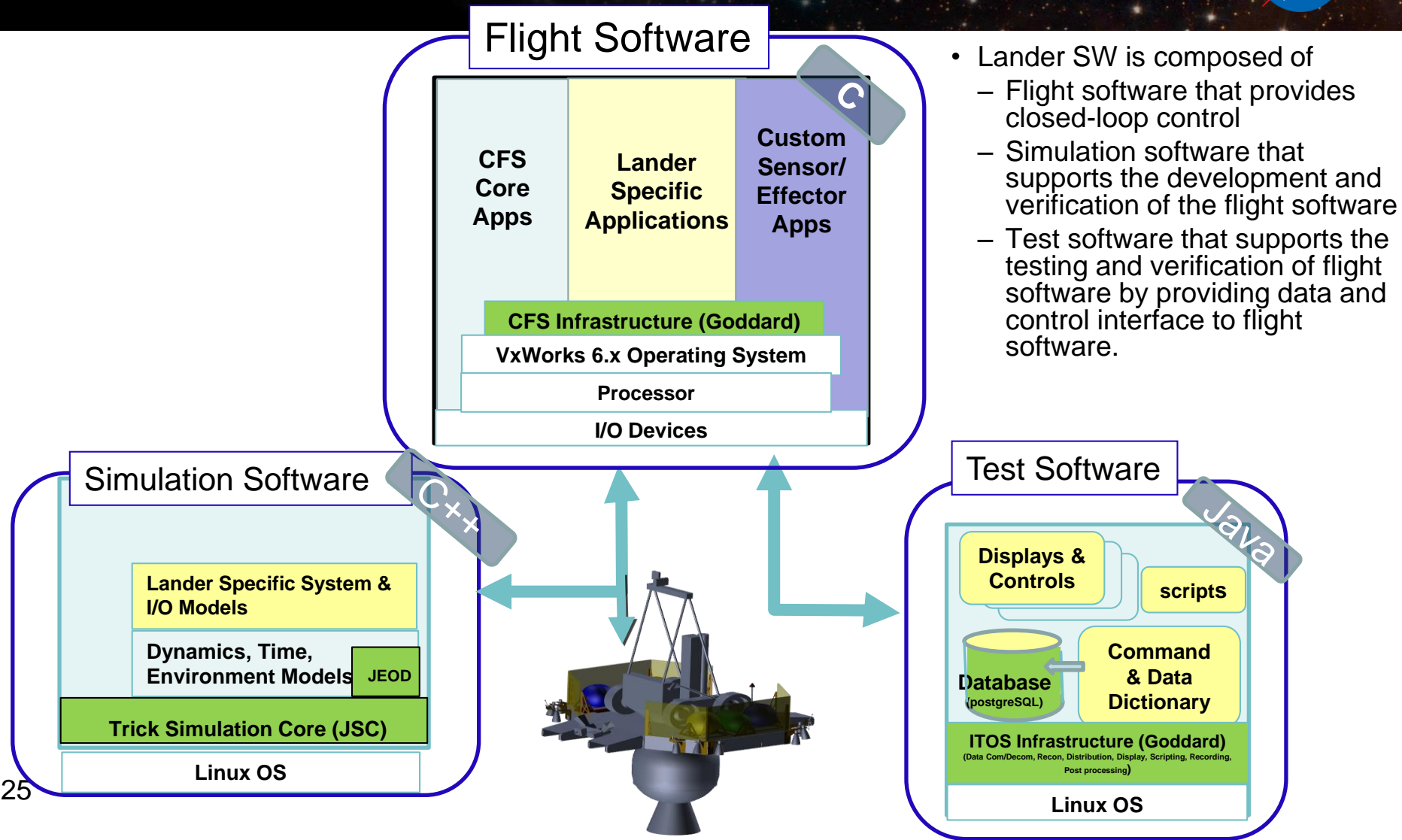

- Lander SW is composed of
 - Flight software that provides closed-loop control
 - Simulation software that supports the development and verification of the flight software
 - Test software that supports the testing and verification of flight software by providing data and control interface to flight software.

Propulsion Design Maturation



- Propulsion system layout and mechanical design
 - Completed early design of flight system
 - Released feed line system and integration drawings
 - Provided detailed Master Equipment List and propulsion/structure interfaces

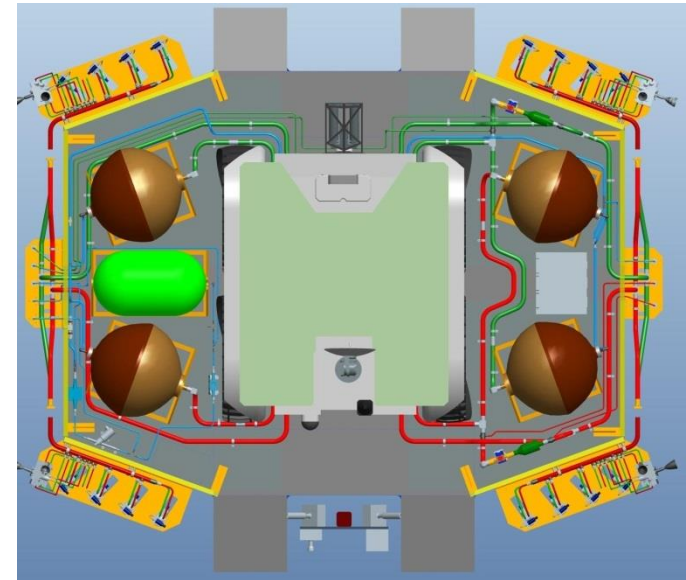
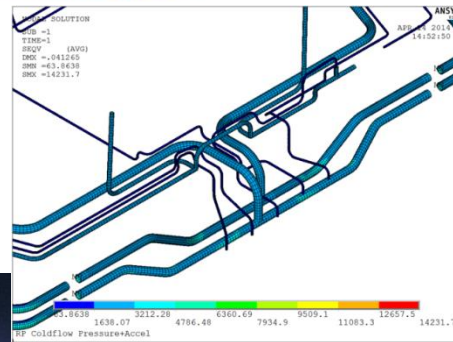
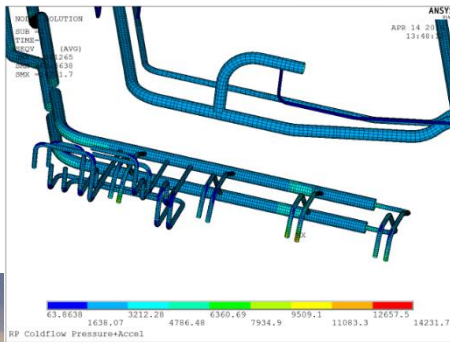
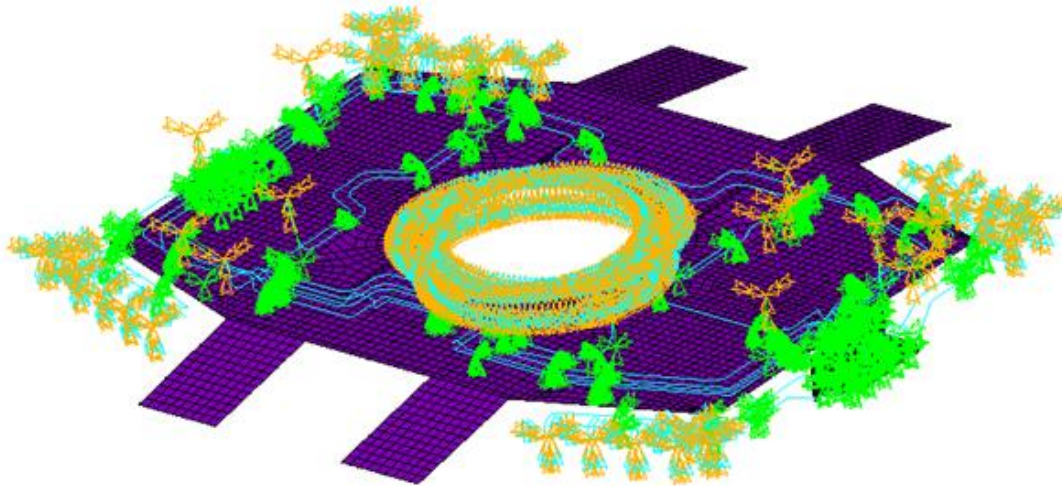

Cold Flow Testing



- Testing is complete
 - Test setup is based on flight design drawings with redline on modification

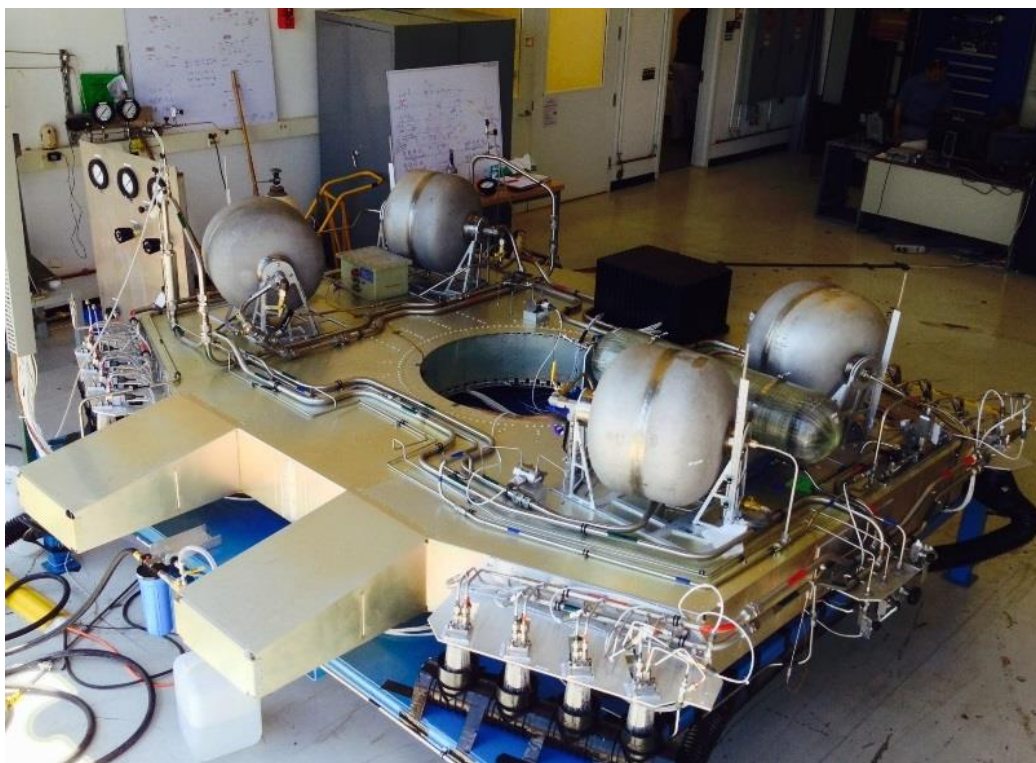

Propulsion components being installed on the lander structure

Summary



- NASA has developed a low cost, requirements-driven robotic lander concept
 - Design and analysis are partially complete
 - NASA looks forward to a partnership for completing a robotic lunar lander for the Resource Prospector Mission