



Understanding Radiation Thermometry – Part I

Timothy K. Risch

NASA Armstrong Flight Research Center

July 8, 2015



Lesson Plan

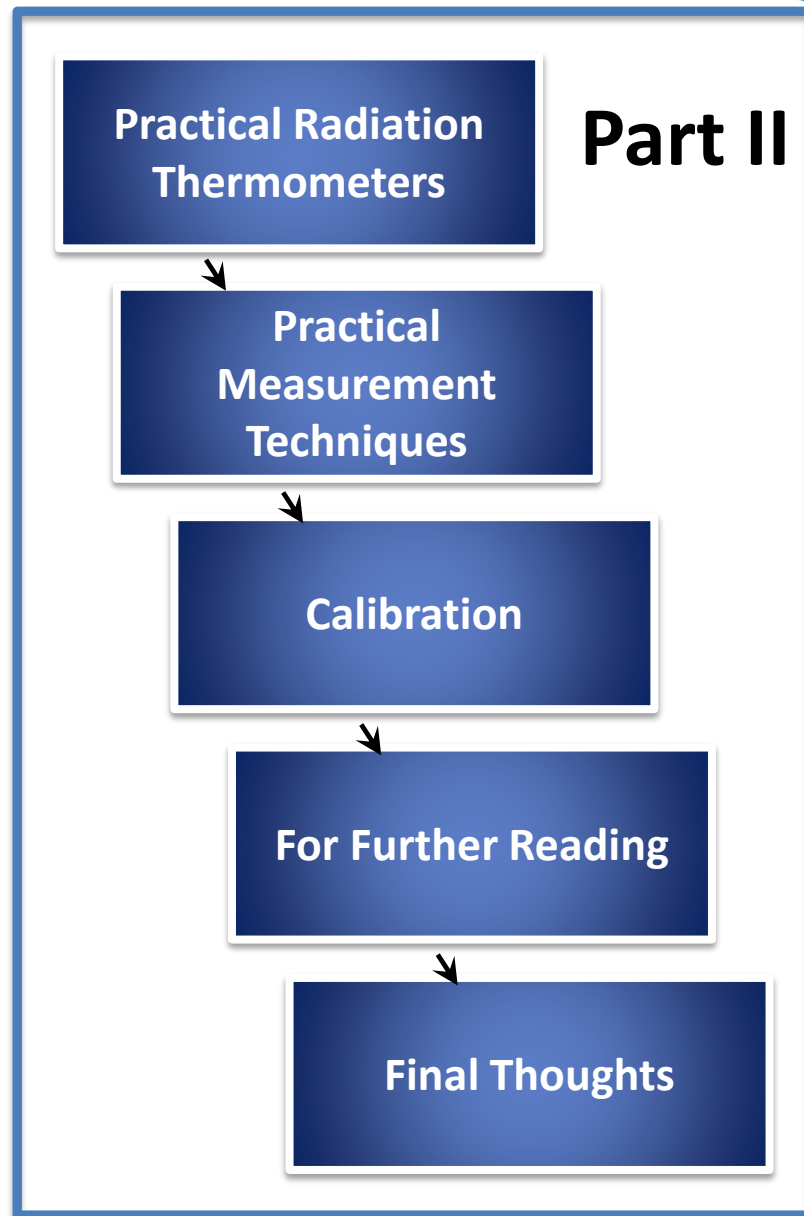
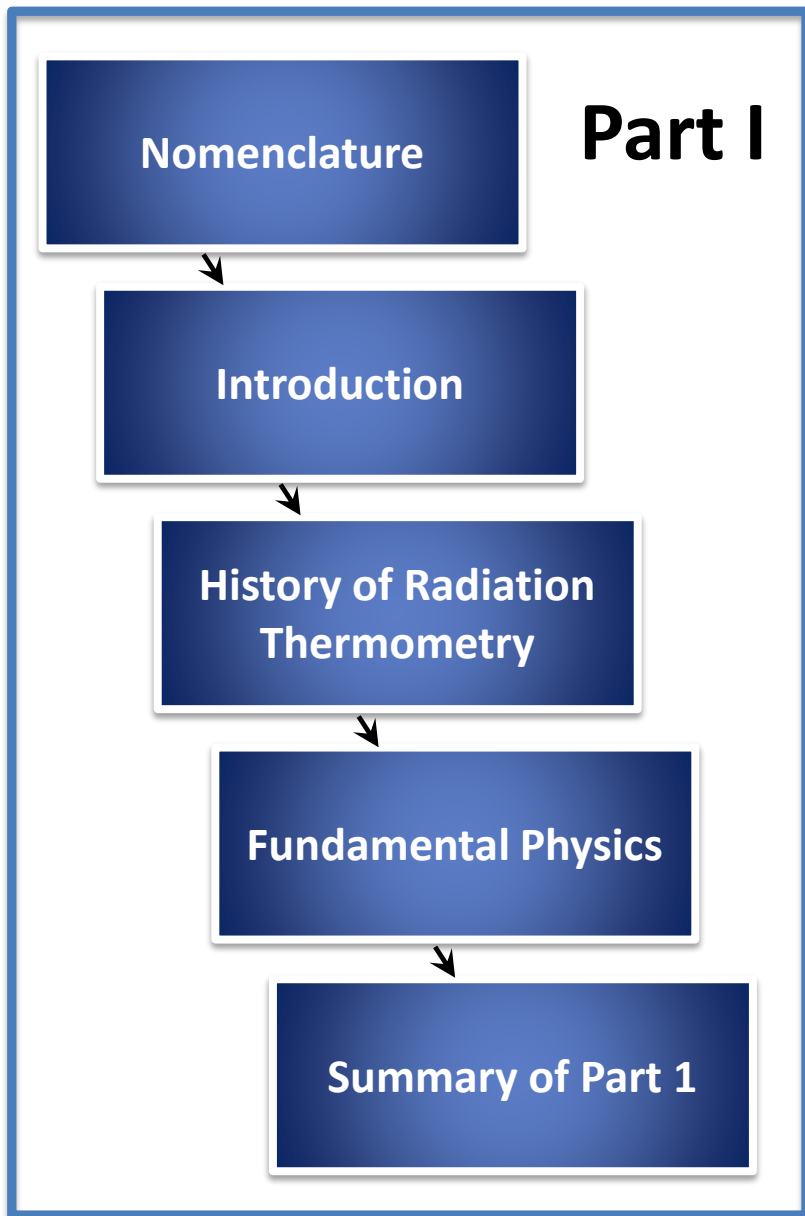



Preliminaries

An Excel[®] worksheet containing solutions to all examples are available from Tim Risch at Timothy.K.Risch@NASA.gov

Excel[®], Visual Basic for Applications[®], and Microsoft[®] are registered trademarks of Microsoft Corporation.



Nomenclature - I

c	speed of light, 2.99792458×10^8 m/s
C_1	Planck's first constant, $2\bar{h}c^2 = 1.191043 \times 10^8$ W- $\mu\text{m}^4/\text{m}^2\text{-sr}$
C_2	Planck's second constant, $\bar{h}c/k = 14,387.75$ $\mu\text{m-K}$
C_3	Constant in Wien's displacement law
C_4	Constant in equation for maximum blackbody intensity
$D_i(\lambda)$	detector spectral response function for detector i
\bar{h}	Planck's constant, 6.626068×10^{-34} J-s
k	Boltzmann constant, $1.3806503 \times 10^{-23}$ J/K
$i_{b,\lambda}(\lambda, T)$	spectral emissive radiance of a perfect blackbody at wavelength λ and temperature T , W/ $\text{m}^2\text{-sr-}\mu\text{m}$
$i_\lambda(\lambda, T)$	spectral radiant intensity of a non-blackbody at wavelength λ and temperature T , W/ $\text{m}^2\text{-sr-}\mu\text{m}$



Nomenclature - II

- $i_b(T)$ total radiant intensity of a blackbody at temperature T ,
W/m²-sr- μ m
- $i(T)$ total non-blackbody radiant intensity at temperature T ,
W/m²-sr- μ m
- T actual surface temperature, K
- T_r ratio temperature, K
- T_λ measured surface temperature at wavelength λ assuming a
perfect emitter, K



Nomenclature - III

$\varepsilon(T)$	total emissivity of a non-blackbody at temperature T
$\bar{\varepsilon}_i$	wavelength-averaged emissivity for detector i
$\bar{\varepsilon}_r$	wavelength averaged emissivity ratio for detector 1 and 2, $\bar{\varepsilon}_2/\bar{\varepsilon}_1$
ε_λ	monochromatic emissivity of a non-blackbody at wavelength λ and temperature T
$\bar{\varepsilon}(\bar{T})$	inferred total emissivity of a non-blackbody at temperature \bar{T}
ε_r	emissivity ratio at two wavelengths λ_1 and λ_2 , $\varepsilon_{\lambda_1}/\varepsilon_{\lambda_2}$
$\Delta\lambda_i$	bandwidth of narrow-band detector i , μm
Λ	equivalent wavelength, $\lambda_1\lambda_2/(\lambda_2 - \lambda_1)$, μm
λ_i	wavelength of detector i , μm



Nomenclature - IV

λ_l	lower wavelength on wide-band radiative thermometer, μm
λ_u	upper wavelength on wide-band radiative thermometer, μm
π	ratio of perimeter to diameter for a circle, 3.14159265358979
σ	Stefan-Boltzmann constant, $\frac{\pi C_1}{15} \left(\frac{\pi}{C_2} \right)^4 = 5.670401 \times 10^{-8}$, $\text{W}/\text{m}^2\text{-K}^4$
Ω	solid angle, sr

Note that the nomenclature or symbology for radiation is not standard across all disciplines or sources. For consistency, we have adopted the naming and symbolic convention used by Howell, J. R. , R. Siegel, and M. P. Mengüç, *Thermal Radiation Heat Transfer*, Fifth Edition, Taylor & Francis, New York, 2010.



Introduction

“If there be light, then there is darkness; if cold, then heat; if height, depth also; if solid, then fluid; hardness and softness, roughness and smoothness, calm and tempest, prosperity and adversity, life and death.”

— **Pythagoras**

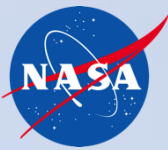

Radiation Thermometry - I

- All bodies above absolute zero emit thermal radiation.
- The quantity of power emitted is measured by the radiative intensity.
- Energy is distributed across the electromagnetic spectrum and the intensity of emission and the shape of the distribution is dependent on the temperature.
- Conversely, the temperature of a body can be measured by the quantity and spectral distribution of energy it emits.

Radiation Thermometry - II

- Radiation thermometry is most often applied to measuring the temperature of heated solid bodies
- However, the techniques discussed here are applicable to measuring the temperature of a group of hot particles in a cloud
- These applications emit radiation across the entire spectrum (continuum radiation) and we will exclude the measurement of radiation due to electronic or molecular transitions at specific wavelengths (line radiation)

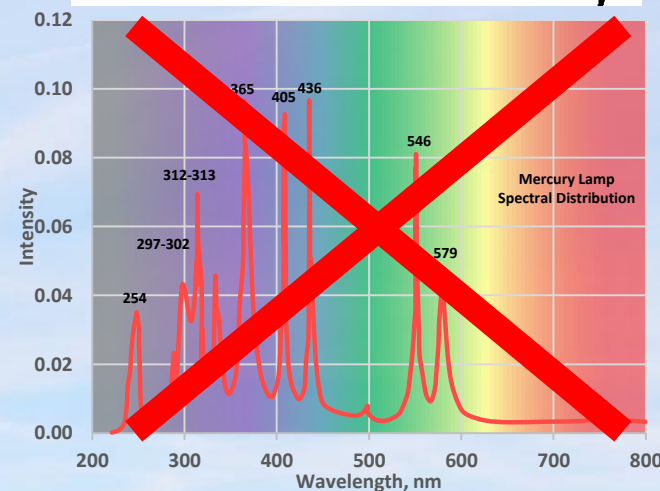
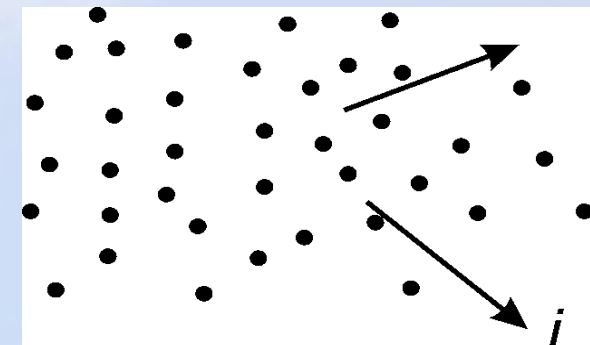

What is Temperature?

- Temperature is a numerical measure of the internal energy of a body.
- Heat flows between bodies at different temperatures.
- Heat flows from a body at higher temperature to a body with a lower temperature.
- Temperature is measured using a thermometer.



**World's Tallest Thermometer
Baker, CA**

Types of Thermometers

- Liquid in glass
- Thermocouple
- Resistance Temperature Devices (RTD)
- Thermistors
- Radiation

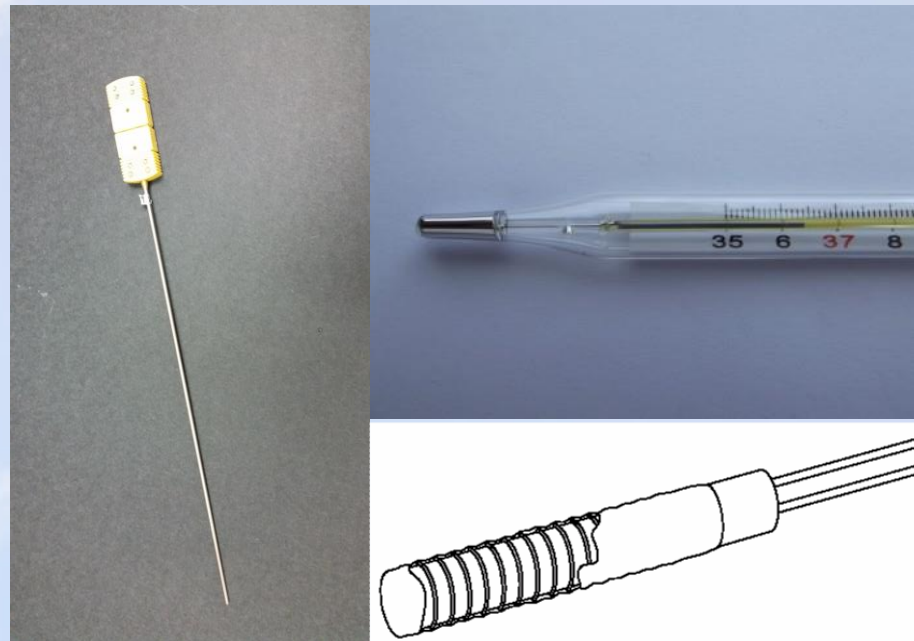

The first four thermometer types are “contact thermometers” in that they require actual physical contact with the object being measured. A radiation thermometer is a “non-contact” measurement device that does not require physical contact with the object to be measured.



Advantages of Radiation Thermometers - I

- Non-contact. Can be used when the object is:
 - › Too remote
 - › Too fragile
 - › Too hot
 - › Too sensitive to contamination
- Very fast response. Many radiation thermometers do not require the heating of a physical object for measurement, unlike contact devices.
- Does not perturb the temperature field. Contact sensors can cause heat losses and distortions to the temperature field resulting in inaccurate measurements.
- Immune from electrical interference. Signal transmission is by high-frequency electromagnetic waves not affected by the presence of electrical or magnetic fields.

Advantages of Radiation Thermometers - II

- For example,
 - › Temperature measurements can be made for bodies heated above 4000 K where no other physical sensor could survive.
 - › Response times on the order of nanoseconds are possible with the right detector.
 - › Temperatures of the sun and distant stars can be determined using the emitted radiation measured on earth.



Disadvantages of Radiation Thermometers

- Do not provide an unambiguous measurement.
 - › Measurement depends on the optical surface properties, which often are unknown.
- More difficult to calibrate
 - › Measurement is a radiative flux, not a voltage or displacement and calibration standards are more difficult to obtain.
- Generally more complex than other measurements methods
 - › Liquid in glass thermometers or a thermocouple are relatively simple compared to radiation thermometers.

Radiation Measurement Spectrum

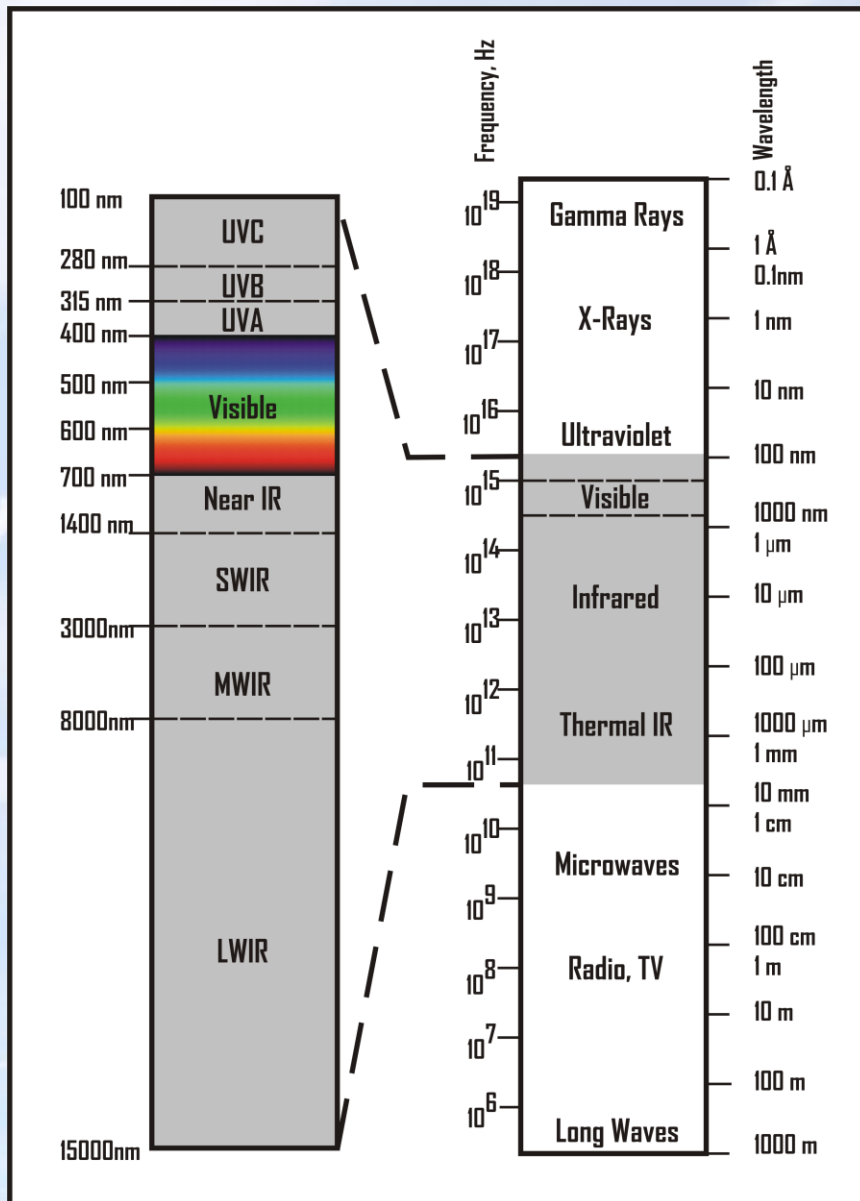

Radiation thermometers measure radiation in the ultra-violet (UV), visible, and infra-red (IR) ranges of the electromagnetic spectrum. These comprise the regions in the spectrum from about 0.1 to 5000 μm .



Radiation Temperature Measurement

- By measuring the radiation intensity or distribution, the temperature of a blackbody or black surface can uniquely be obtained.
- This is the basic principle of radiation temperature measurement.



History of Radiation Thermometry

*“Heat cannot be separated from fire, or
beauty from The Eternal.”*

— **Dante Alighieri**

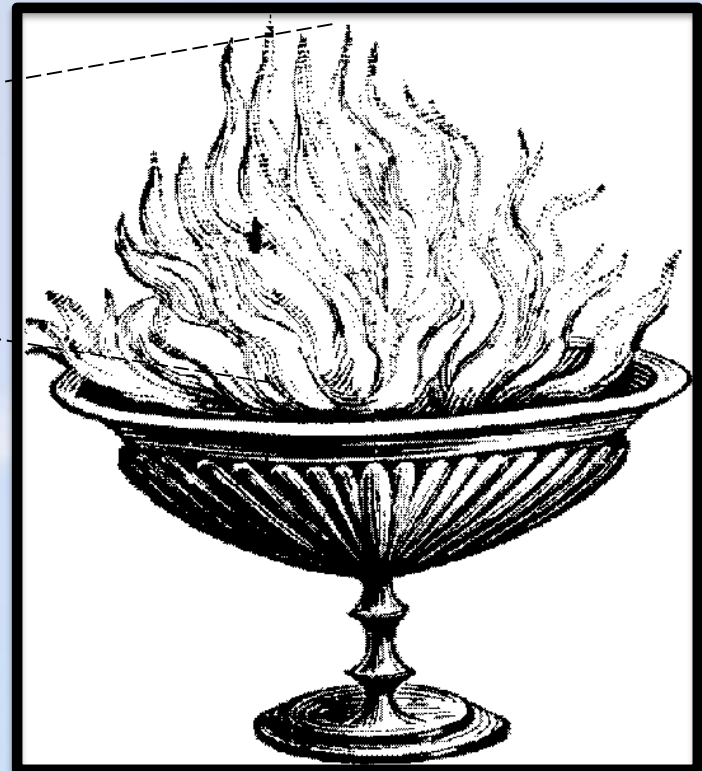
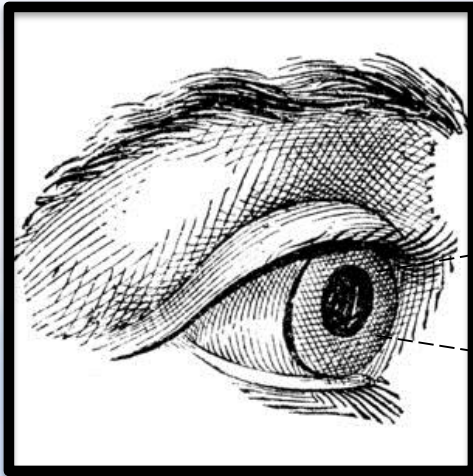

One of the first radiation thermometers was the human eye. The human eye can detect a luminance range of 10^{14} , or one hundred trillion (100,000,000,000,000) over an almost 180-degree forward-facing horizontal field of view. The human eye can distinguish about 10 million individual colors.¹

1) Judd, Deane B.; Wyszecki, Günter (1975). *Color in Business, Science and Industry*. Wiley Series in Pure and Applied Optics (third ed.). New York:Wiley-Interscience. p. 388. ISBN 0-471-45212-2.

As early as 1500 B.C. the process of making iron and steel consistently required that the furnace and the metals be heated to a repeatable temperature. Since there was no method capable of directly measuring temperature, it was discovered that the color of the furnace and the metal could indicate temperature.

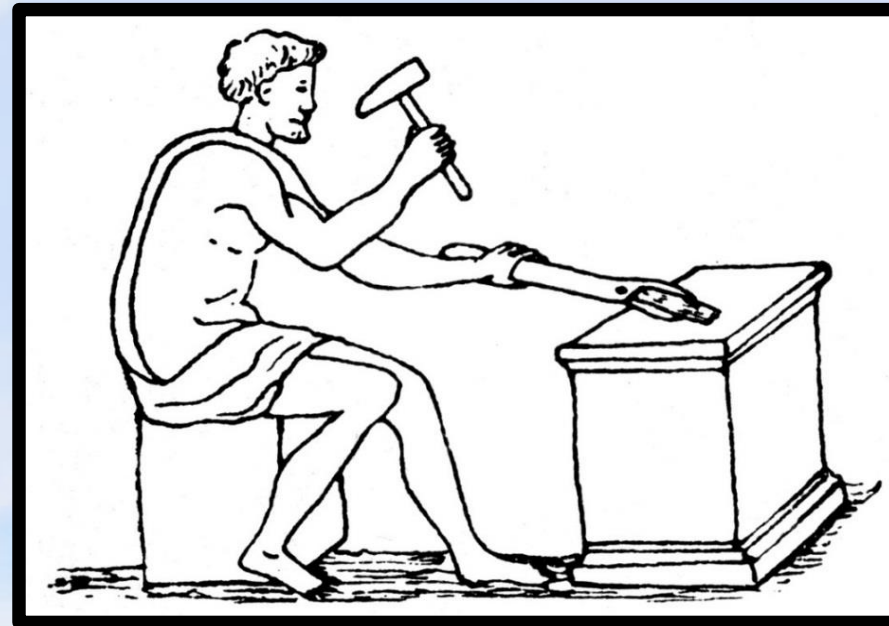
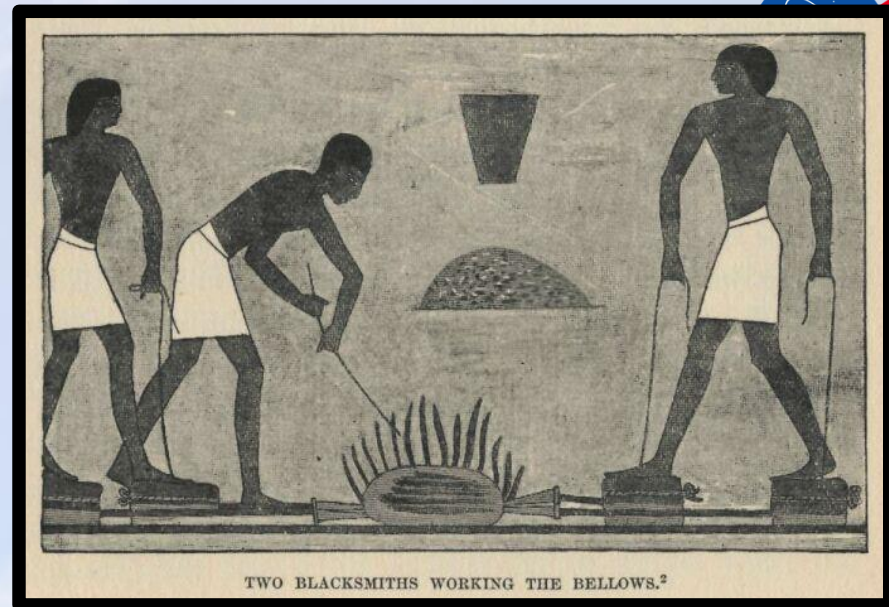

Early Roman Blacksmith

Ezekiel (593 to 565 BC)

“Then set the empty pot on the coals till it becomes *hot and its copper glows*, so that its impurities may be melted and its deposit burned away.”

[Ezekiel 24:11](#), New International Version (NIV)

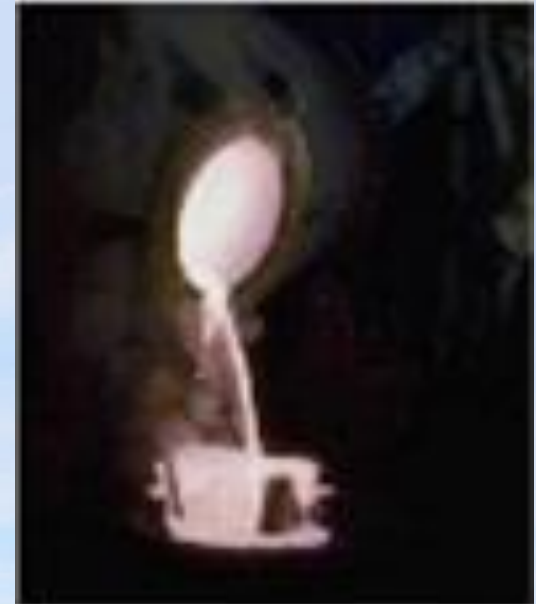

“...and from the Anvils,
the sturdy Strokes in
echoing Groans resound
the *red hot* Bars of Steel
hiss in the caverns, and
the Fire in the Furnace
pants.”

P. Virgil Maronis, Aneidos
Liber Octavus, 19 B.C.,
translated by Joseph
Davidson, 1890



The Forge of Vulcan by Diego Velázquez, (1630).

Even today, the color of heated steel is used to determine its temperature.

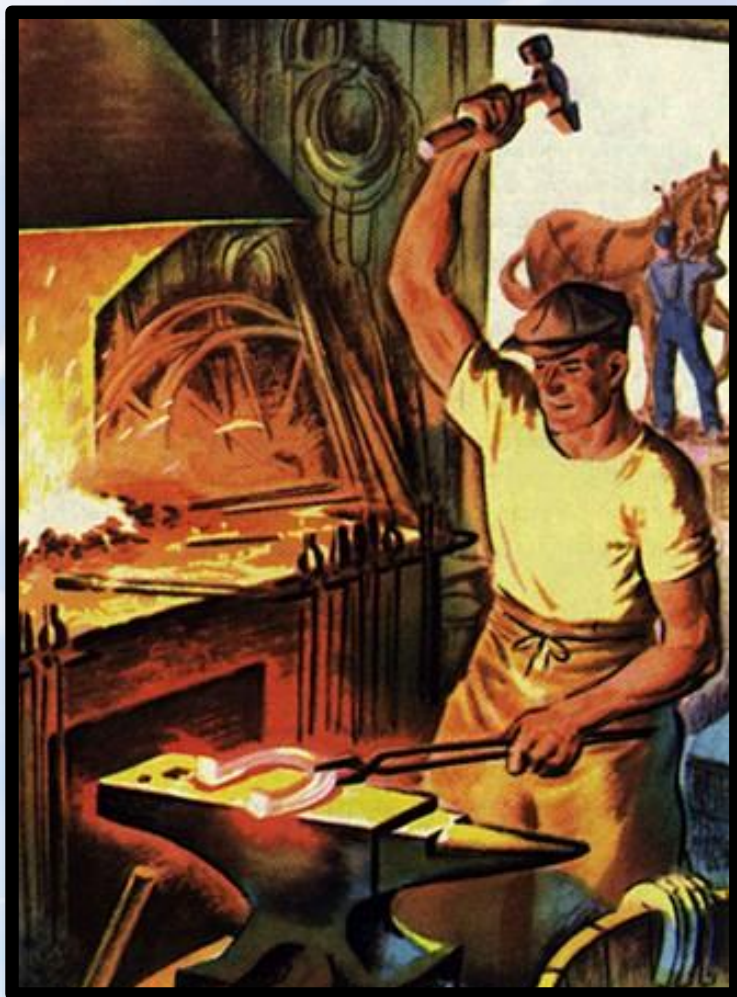

Fahrenheit	The Color of the Steel
2000°	Bright Yellow
1900°	Dark Yellow
1800°	Orange Yellow
1700°	Orange
1600°	Orange Red
1500°	Bright Red
1400°	Red
1300°	Medium Red
1200°	Dull Red
1100°	Slight Red
1000°	Very Slightly Red, Mostly Grey
800°	Dark Grey
575°	Blue
540°	Dark Purple
520°	Purple
500°	Brown/Purple
480°	Brown
465°	Dark Straw
445°	Light Straw
390°	Faint Straw



Practical Radiation Thermometers

“Is not Fire a Body heated so hot as to emit Light copiously? For what else is a red hot Iron than Fire? And what else is a burning Coal than red hot Wood?”

— **Sir Isaac Newton**

Opticks (1704), Book 3, Query 9, 134.

Early Radiation Thermometers

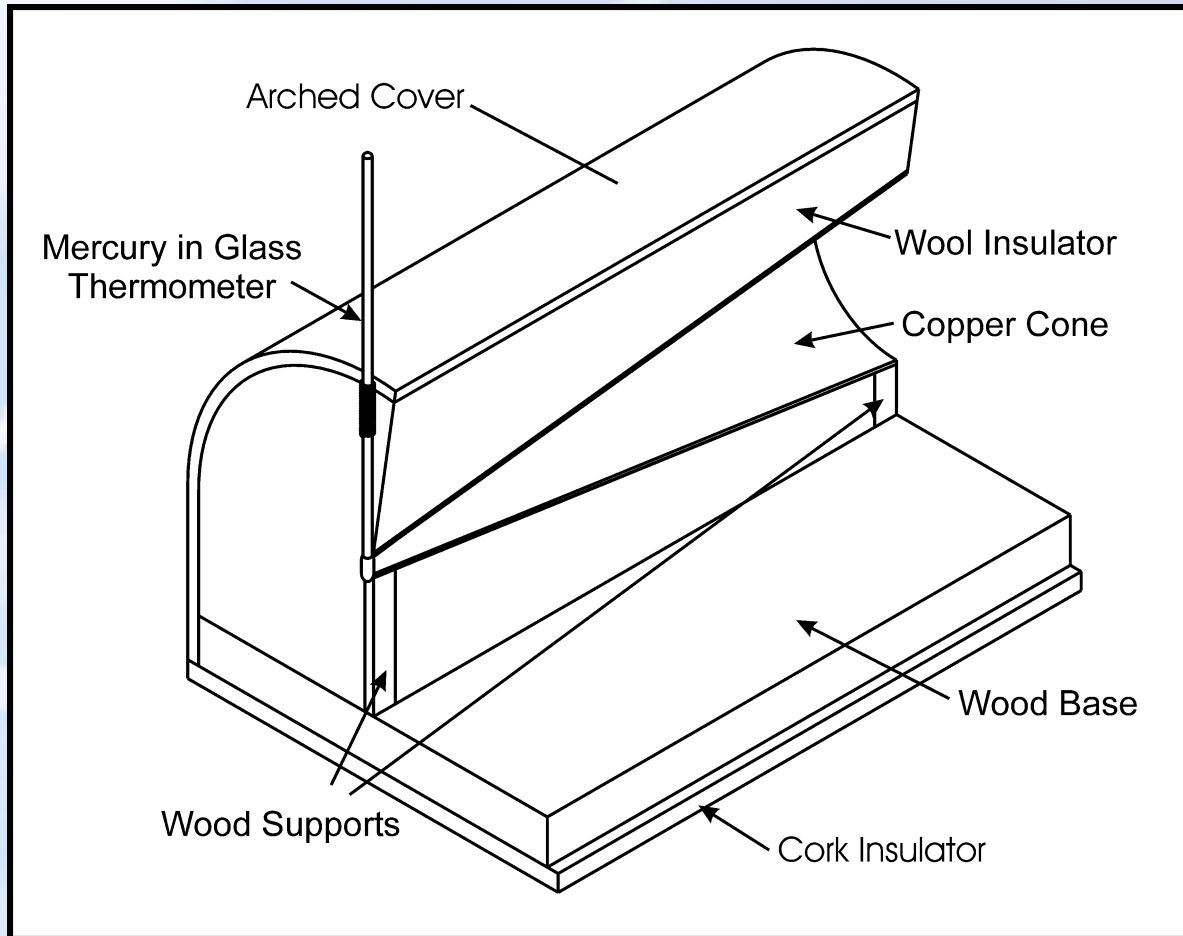

Early 1828
M'Sweeny
radiation
thermometer
(pyrometer)
used for
measuring
the
temperature
of furnaces.

Sketch based on the description from: M'Sweeny, J., "On Regulating the heat of Furnaces by means of Pyrometers, acted on by radiant heat.", *Journal of the Franklin Institute*, Vol. III, pp. 13-16, 1829.

- Disappearing filament pyrometer patent from 1902 which became the industrial and scientific standard pyrometer in the early 20th century

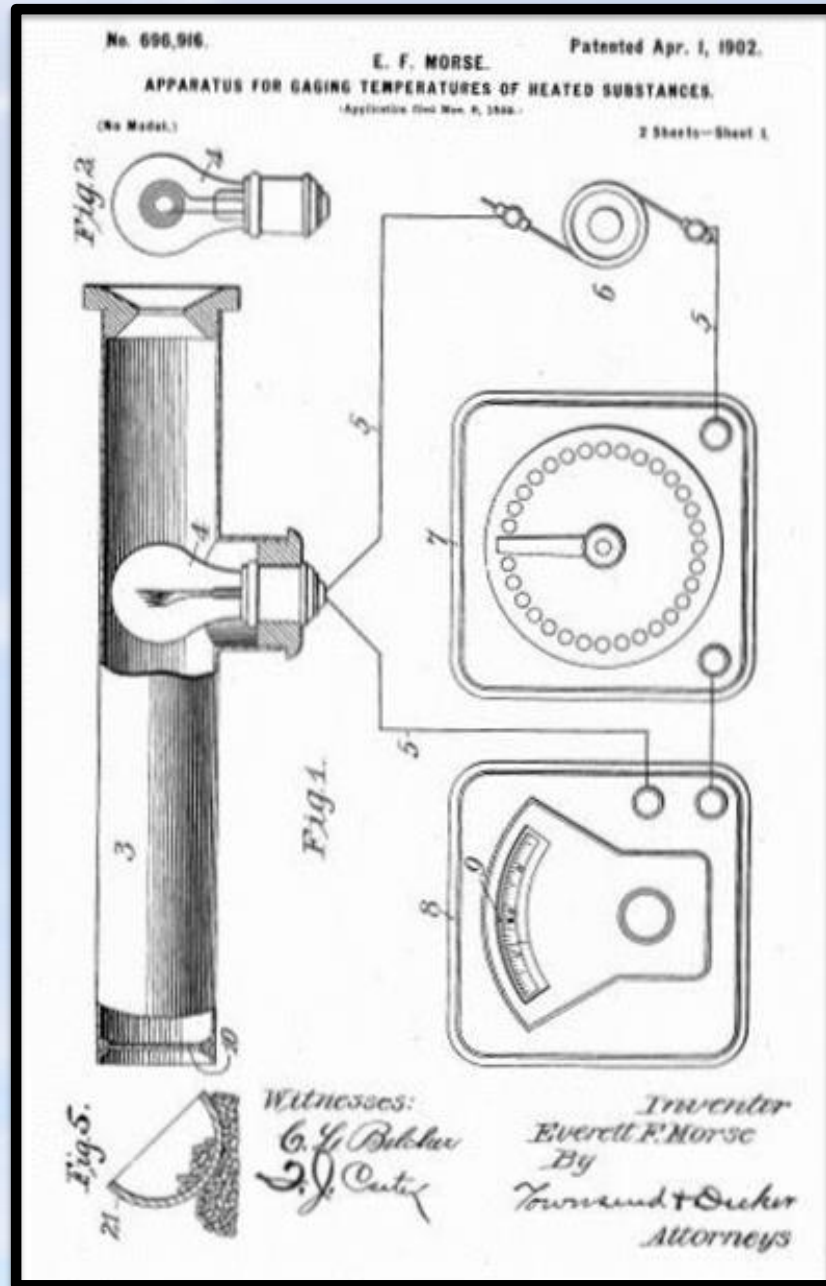

How a Disappearing Filament Pyrometer Works

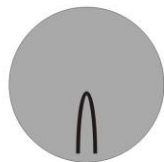
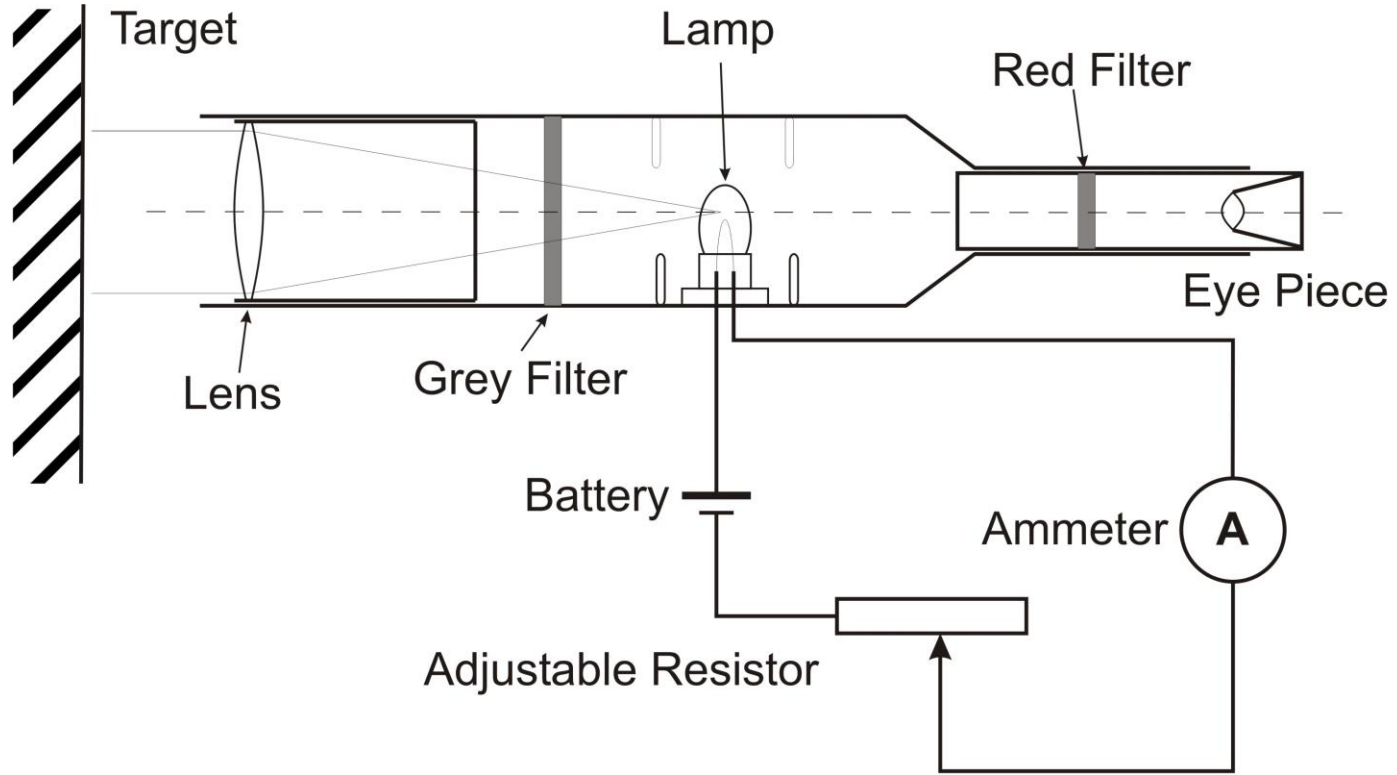

Filament is dark.
Filament temperature is below that of source.



Filament is bright.
Filament temperature is above that of source.

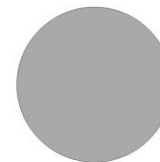

Filament disappears.
Filament temperature is the same as source.

Modern Development of Detectors

- In the times leading up to WWII, electronic detectors were invented that allowed fully automated temperature measurement.
- These include thermopile and pyroelectric detectors which actually measure the increase in temperature of a sensor and quantum sensors that measure the current generated when photons strike a semiconductor.
- In the last 30 years, solid-state radiation detectors have been developed and refined to provide low-cost solutions for temperature measurement across a wide range of wavelengths and intensities.



Original 1P25 image converter tube developed by RCA in the 1930's



Three Major Detector Types

- Internal photonic
 - › Electrons are created within a semiconductor material producing a voltage or current
- External photonic
 - › Electrons are emitted from photosensitive material creating a current
- Thermal
 - › Heat is generated that changes the property of a material

Common Radiation Detectors



Photodiode



Thermopile

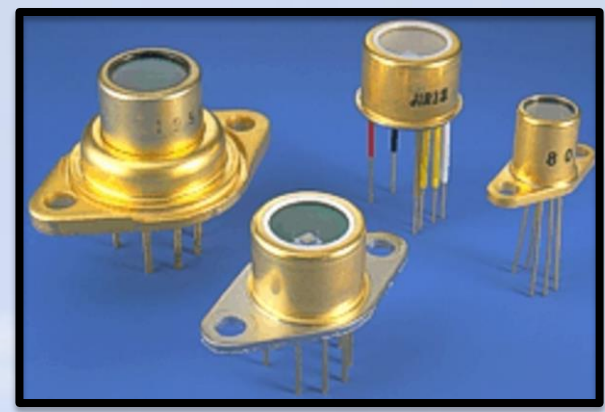

Uncooled IR detectors

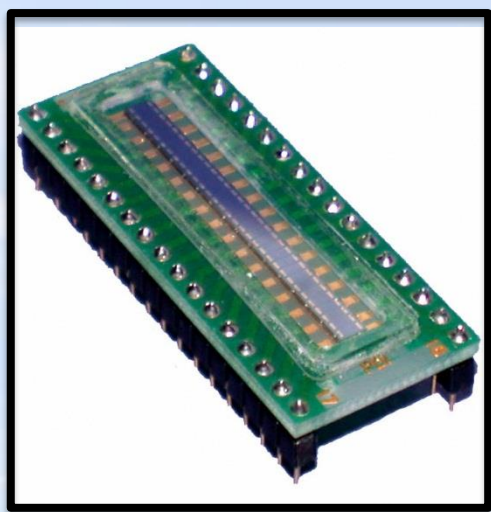

Linear Array Detectors



Photomultiplier Tube



Cryogenically cooled IR detectors

Wavelength Ranges of Common Detectors

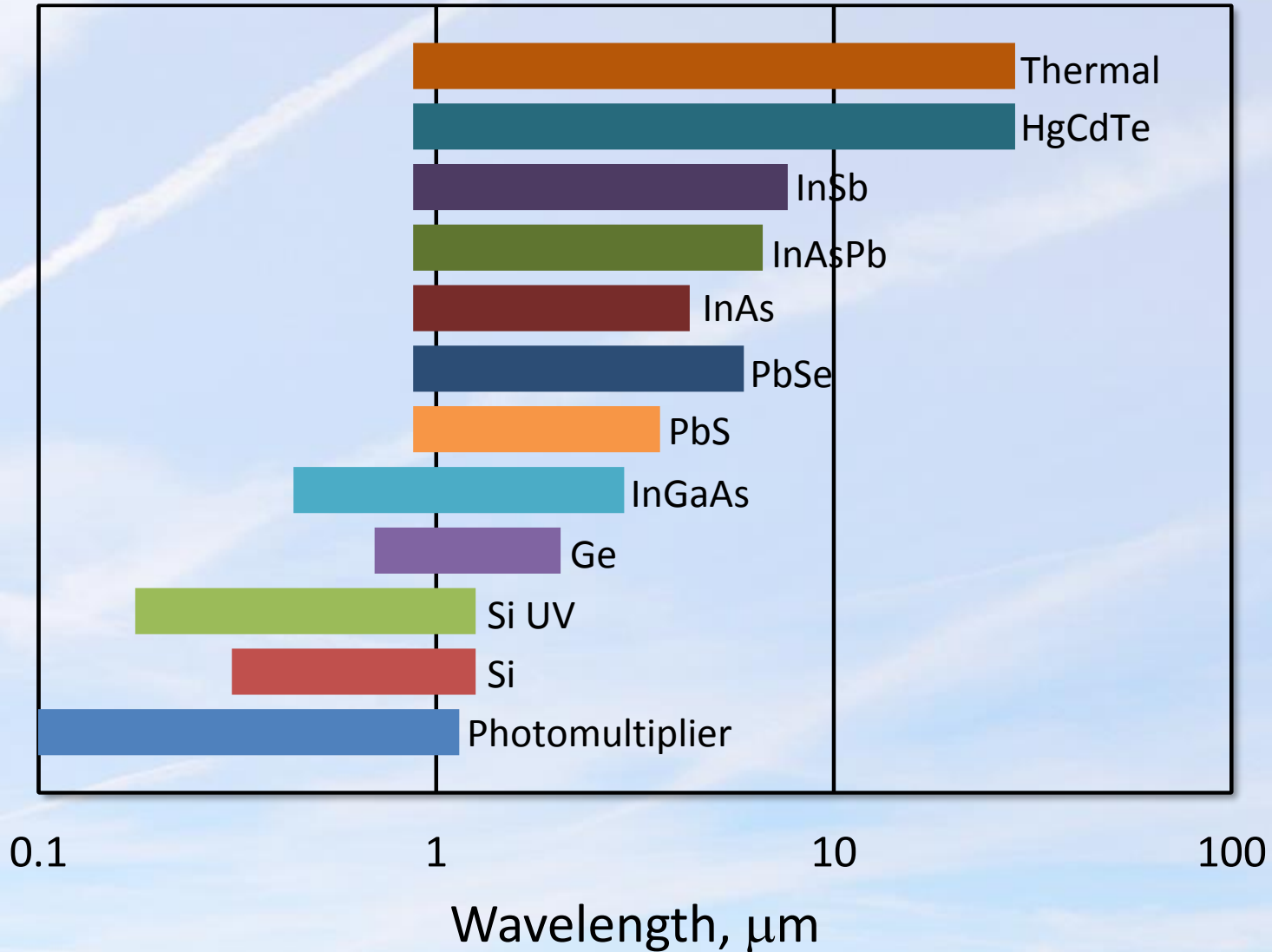

Wavelength Response of Detectors

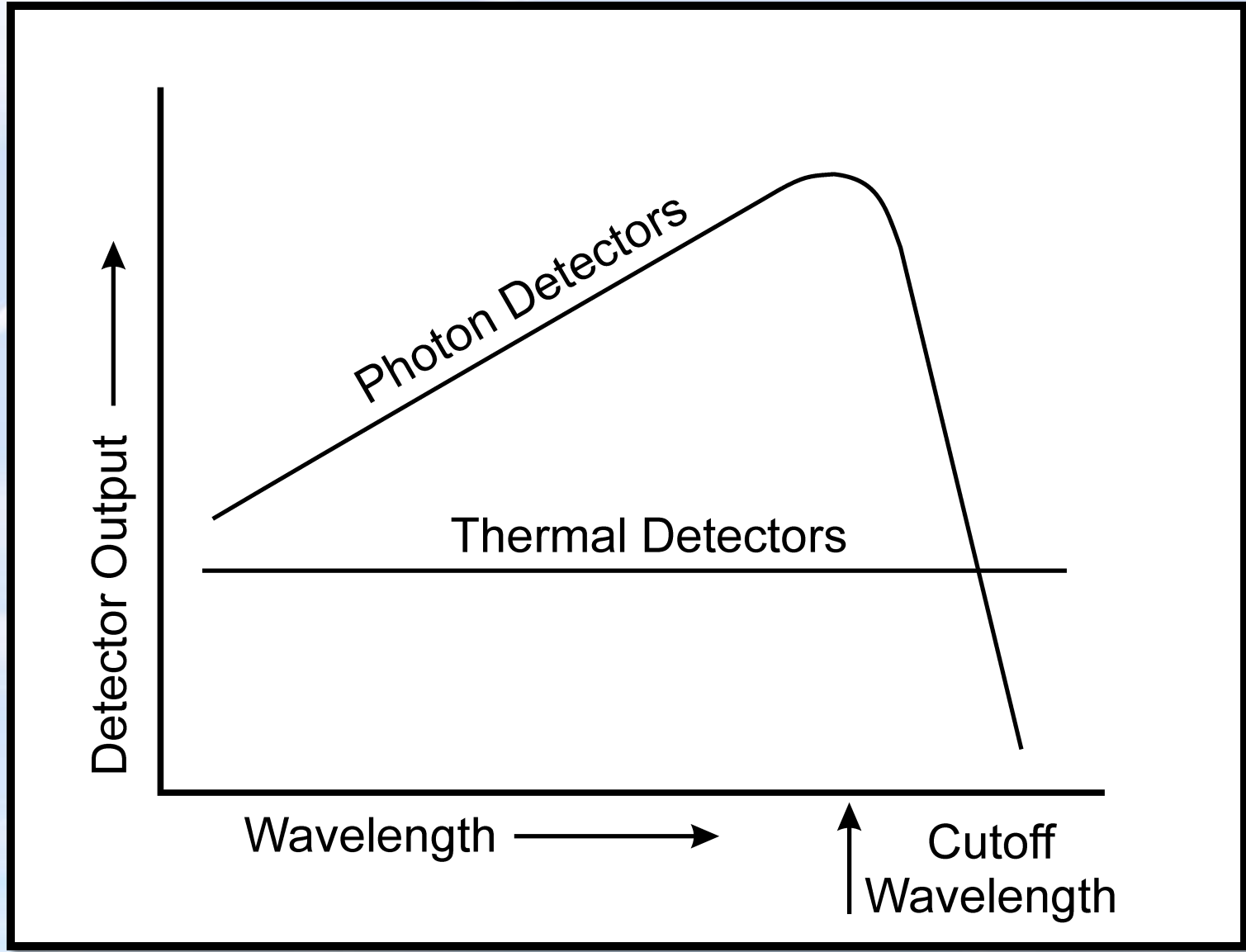

Features of Different Detectors

Type	Detector	Features
Internal Photonic	Si Photodiode Ge Photodiode InGaAs PbS PbSe InSb HgCdTe	<ul style="list-style-type: none"> • High speed response • Wide spectral range • Small size • Easy integration
External Photonic	Photomultiplier tube Photo tube Image Tube	<ul style="list-style-type: none"> • High sensitivity • High-speed response • Large photosensitive area
Thermal	Thermopile Bolometer Pyroelectric	<ul style="list-style-type: none"> • Insensitive to wavelength • Slow response



Ways Detectors are Used

- To simplify the analysis and improve measurement accuracy, the light incident on a detector is usually filtered to provide a narrow wavelength or color
- The bandwidth is usually made short – 10 to 100 nm wide so that the spectral intensity can be assumed constant across the band
- However, this reduces the light input and measured signal
- So in cases where high sensitivity is needed, wide-band detectors can be used

Methods to Limit Optical Bandwidth - I



Interference Filters

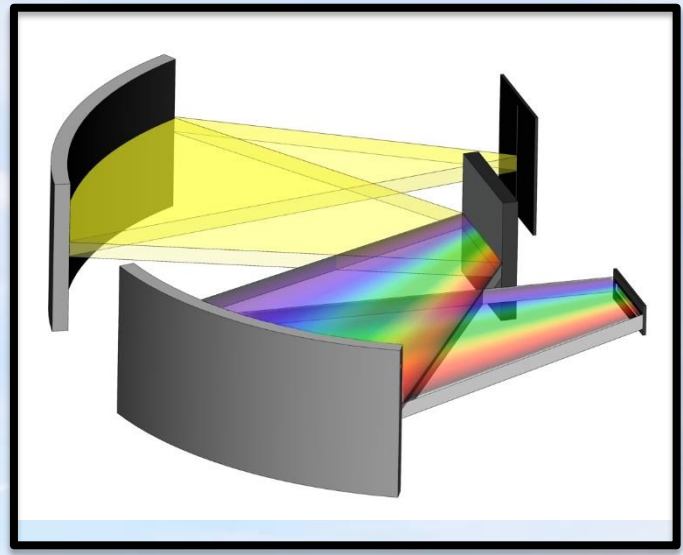

Dispersive Spectrometer

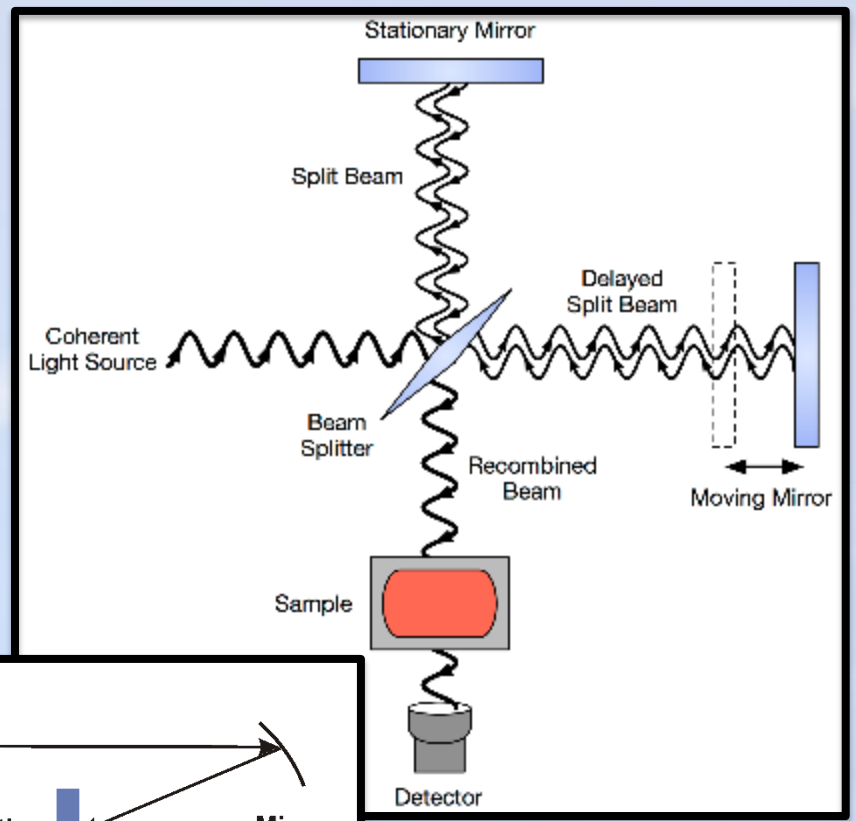
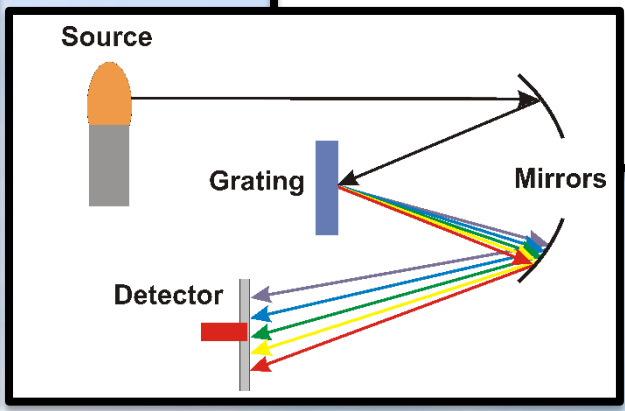

Interferometer

Methods to Limit Optical Bandwidth - II

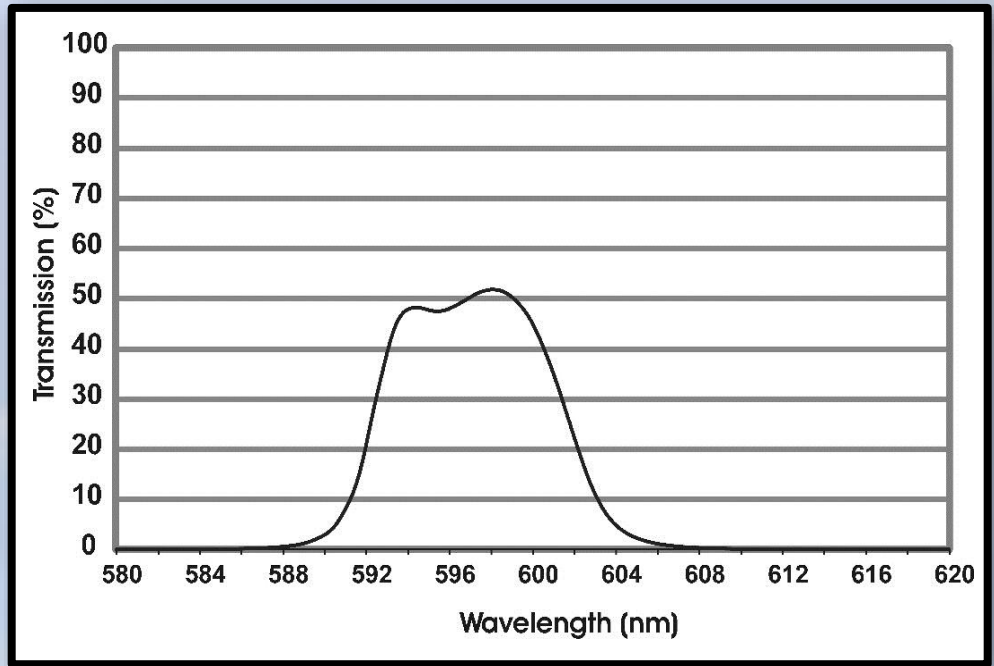

600-nm CW – 10-nm wide Interference Filter

Common interference filter spectral response.



Modern Radiation Thermometers

- Today, radiation thermometers covering a wide range of wavelengths and temperatures are available from instrument manufacturers.
- Additionally, components are readily available to make high precision instruments that can be tailored to meet specific requirements.

Radiation Thermometers in Use



An engineer uses a readily available handheld radiation thermometer to measure the temperature of a furnace

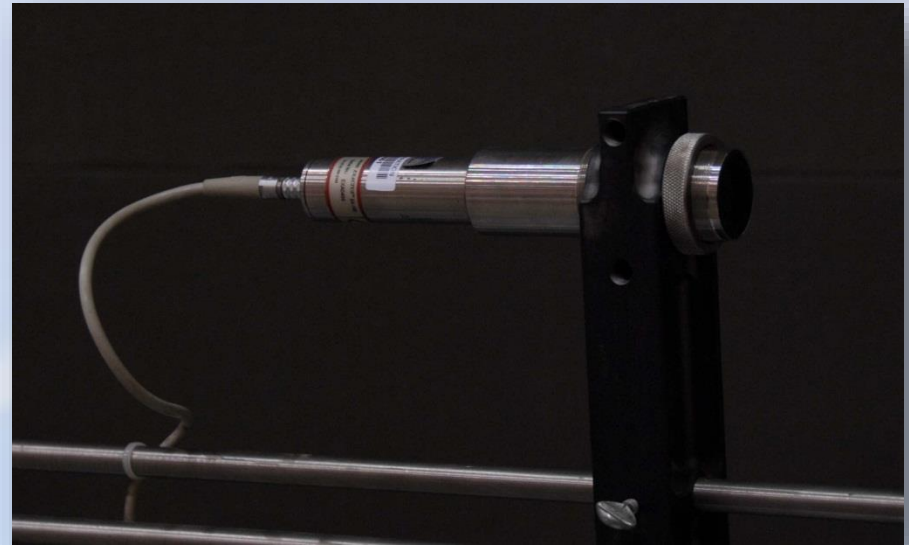

A precision commercial radiation thermometer for process measurement

Visible-Wavelength Radiation Thermometer

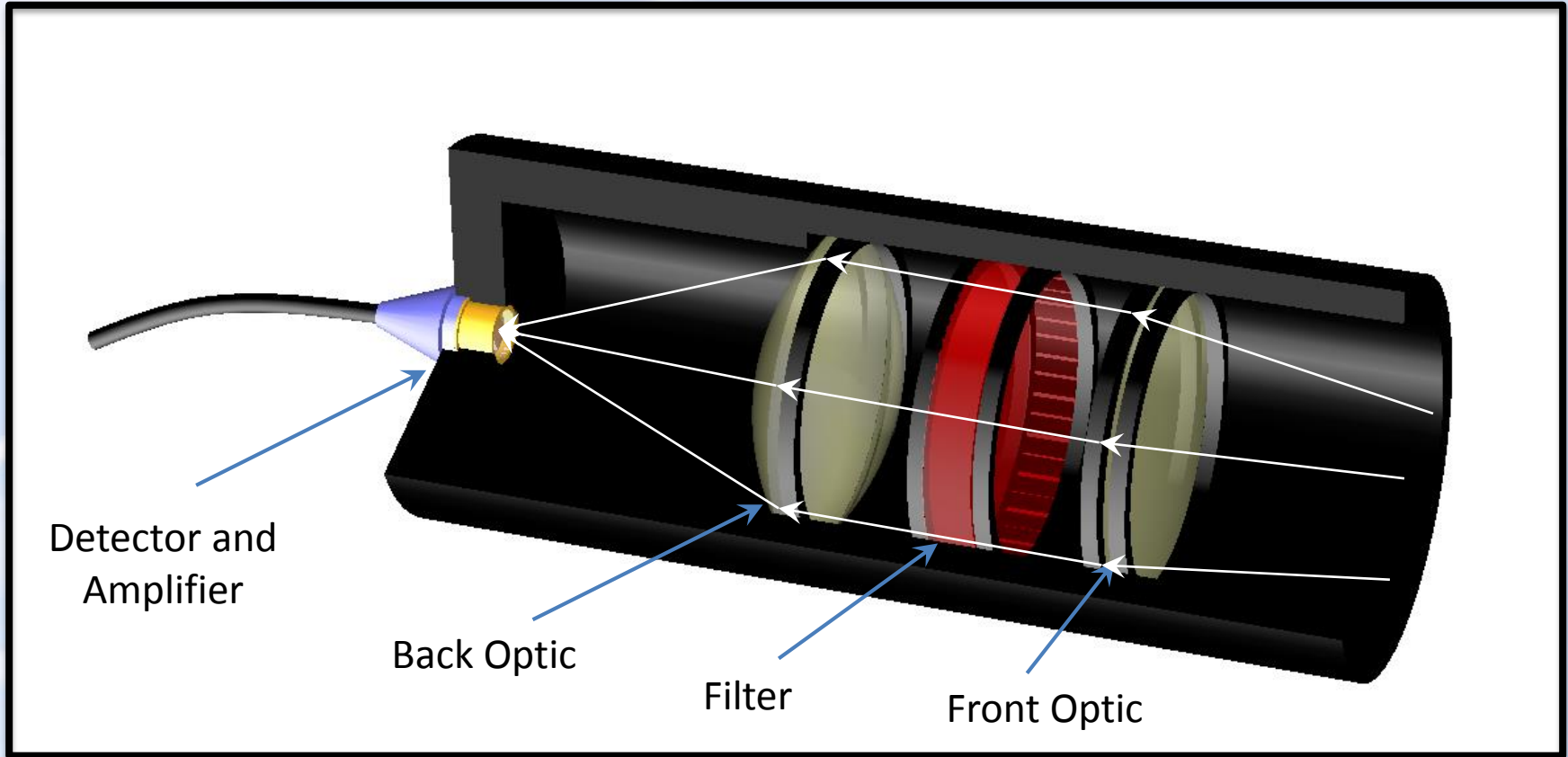
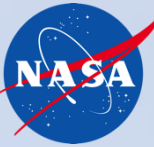

Detector and
Amplifier

Back Optic

Filter

Front Optic

3-Channel IR Radiation Thermometer

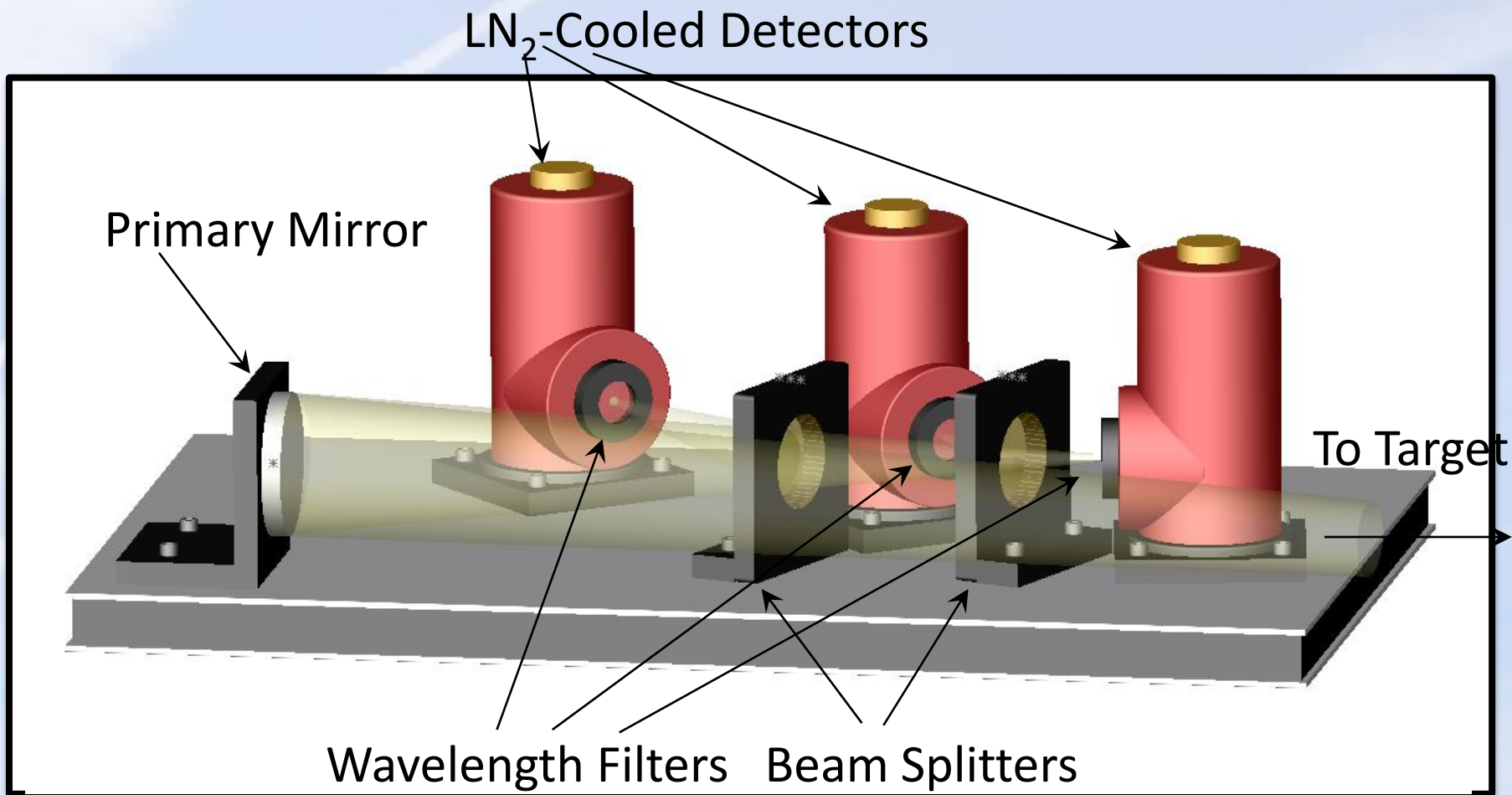

Practical Measurement Tips



To ensure accurate non-contact temperature measurements, be aware of the following:

- Field of View
 - › Ensure the sample area overfills the spot size
- Optical Path
 - › Smoke, fog, dust, etc. can attenuate the signal
- Instrument Temperature
 - › Environments that are too cold or too hot can degrade instrument accuracy
- Emissivity
 - › The surface emissivity can significantly reduce the measured signal



Fundamental Physics

“The spectral density of black body radiation ... represents something absolute, and since the search for the absolutes has always appeared to me to be the highest form of research, I applied myself vigorously to its solution.”

— **Max Planck**

Blackbody - I

- A blackbody is an idealized physical body that absorbs all incident electromagnetic radiation and emits electromagnetic radiation called blackbody radiation.

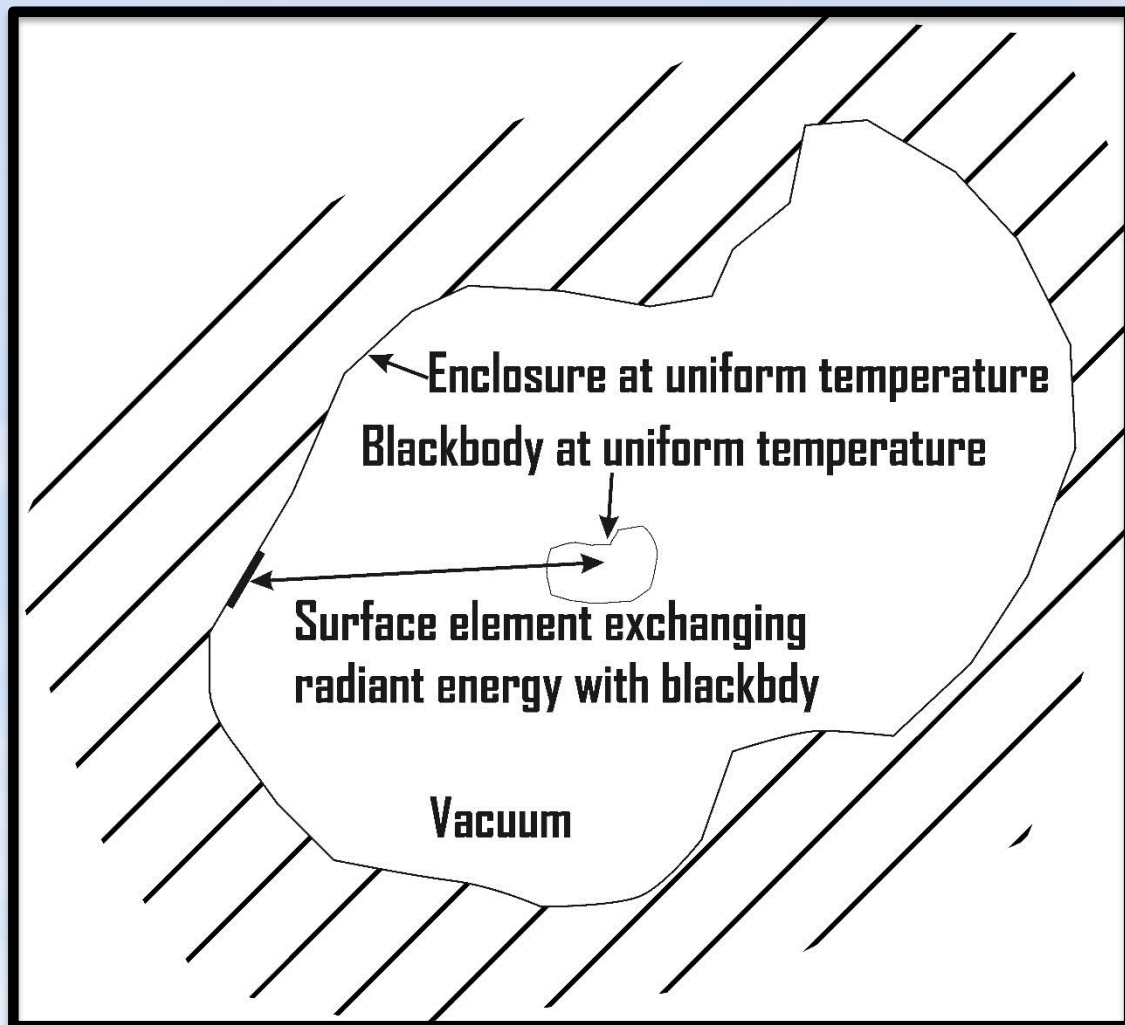

Blackbody - II

- The radiation emitted from a blackbody is determined by the temperature alone not by the body's shape or composition
- A blackbody in thermal equilibrium has two notable properties:
 - It is an ideal emitter: at every frequency and wavelength, it emits as much energy as – or more energy than – any other body at the same temperature.
 - It is a diffuse emitter: the energy is radiated isotropically independent of direction

Fundamental Physics - I

- All heated bodies emit thermal radiation
- The intensity and distribution of energy is governed by Planck's law and is determined by the wavelength of light and the temperature. For a perfect emitter (blackbody) in a vacuum:

$$i_{b\lambda}(\lambda, T) = \frac{C_1}{\lambda^5 (e^{C_2/\lambda T} - 1)} \quad (1)$$

Where $i_{b,\lambda}(\lambda, T)$ is the blackbody spectral radiant intensity at wavelength λ and temperature T (typically in units of $\text{W/m}^2\text{-sr-}\mu\text{m}$), and C_1 and C_2 are Planck's first and second constants, respectively.

Fundamental Physics - II

- The intensity distribution is expressed in units of $\text{W}/\text{m}^2\text{-sr-}\mu\text{m}$ which is a power per area, per unit wavelength, per solid angle.
- A solid angle Ω equals 4π times the area subtended by a spherical cap at a given distance divided by the entire area of the sphere at that distance.
- The entire sphere has a solid angle of 4π sr.

$$\Omega = A/4\pi R^2 \cdot 4\pi = A/R^2$$

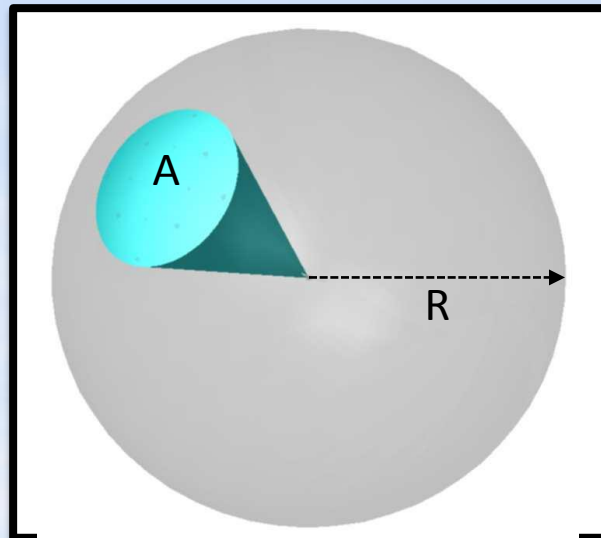

Emissive Power versus Temperature

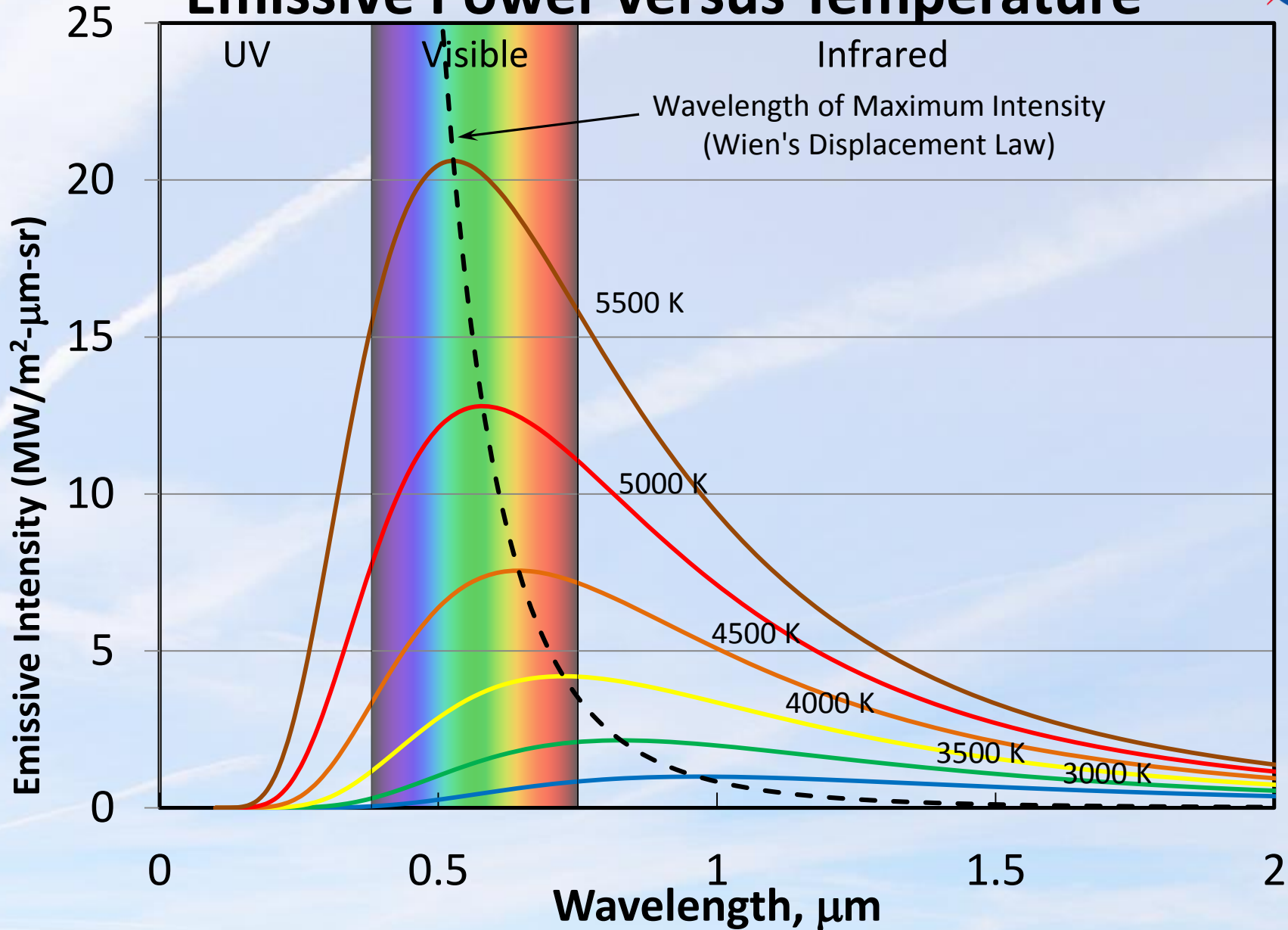



Planck Function Properties

The Planck function has the following three properties:

1. The radiant intensity increases with increasing temperature at all wavelengths and for all temperatures (i.e. $di_{b,\lambda}/dT$ is always greater than zero)
2. For any given temperature, the radiant intensity reaches a maximum at a specific wavelength and there are two wavelengths where the radiant intensity is equal for intensities less than the maximum.
3. The wavelength at the maximum radiant intensity decreases as the temperature increases (Wien's displacement law).



Wien's Law

- Peak monochromatic emissive power occurs at a wavelength dependent on the temperature
- The peak wavelength can be found by differentiating Planck's law with respect to wavelength
- The peak wavelength occurs where:

$$\lambda_{max}T = C_3 = 2897.77 \mu\text{m-K} \quad (2)$$

Wien's Law Peak Intensity and Wavelength

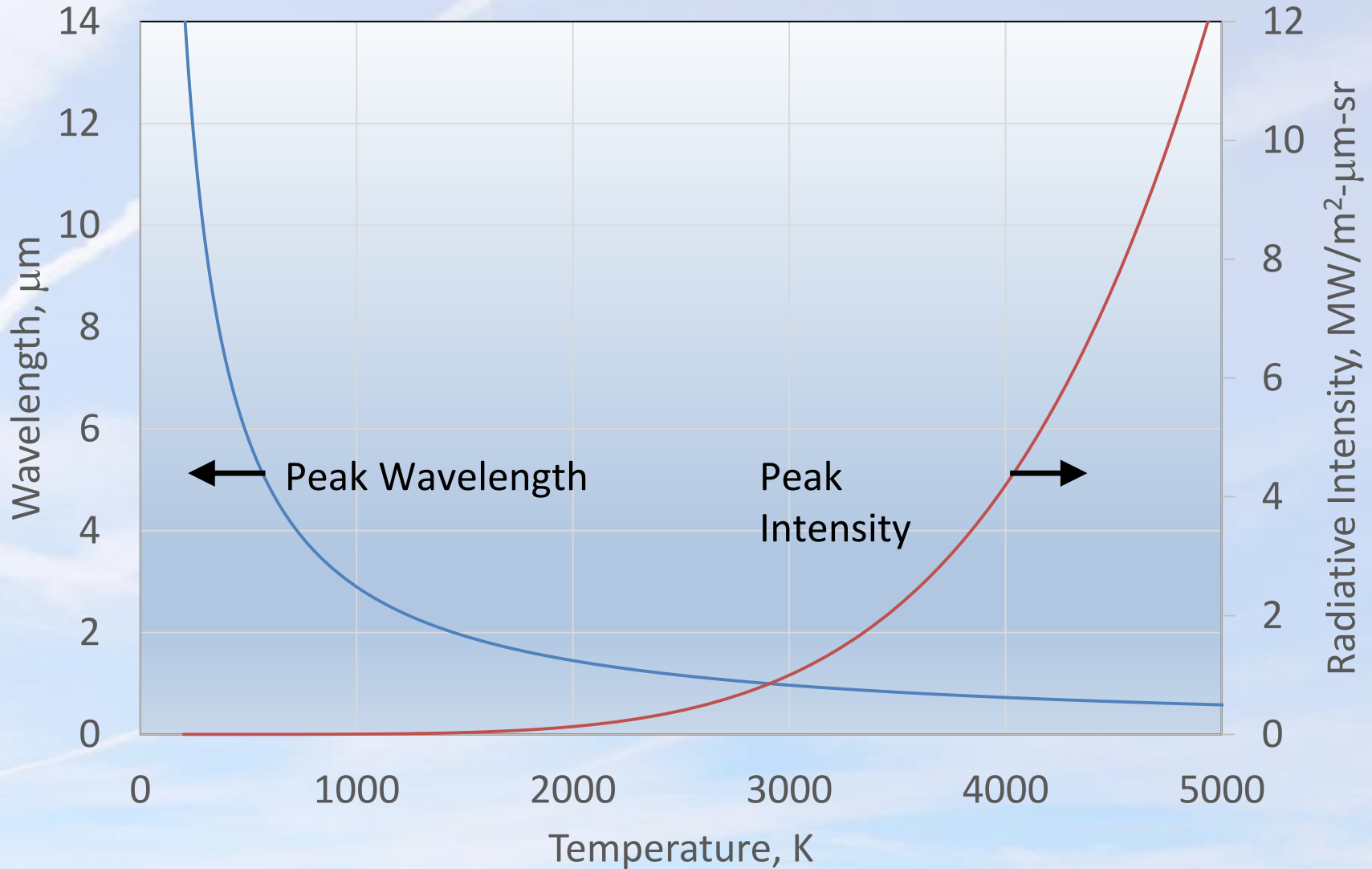



Example 1 - I

E1: What is the emitted spectral intensity for a blackbody at 3000 K and at a wavelength of $0.5 \mu\text{m}$?



Example 1 - II

A1: The spectral intensity is calculated from the Planck Equation (Equation 1) using routine `bb_ibl` from the Excel[®] library and is:

$$i_{b\lambda}(\lambda, T) = \frac{C_1}{\lambda^5 (e^{C_2/\lambda T} - 1)} = \frac{1.191043 \times 10^8}{0.5^5 (e^{14,387.75/0.5 \cdot 3000} - 1)}$$
$$= 2.60 \times 10^5 \text{ W/m}^2\text{-sr-}\mu\text{m}$$



Example 2 - I

E2: What is emitted power across a 10 nm ($0.01 \mu\text{m}$) waveband centered at $0.5 \mu\text{m}$ and at 3,000 K?



Example 2 - II

A2: Since the bandwidth is small, one can evaluate the total power using the spectral intensity at the given wavelength calculated using routine `bb_ibl` and then multiplied by the wavelength band:

$$i_{b\lambda}(\lambda_l, \lambda_u, T) \cong i_{b\lambda}(\lambda_l, T) \cdot \Delta\lambda$$

$$= 2.60 \times 10^5 \text{ W/m}^2\text{-sr-}\mu\text{m} \cdot 0.01 \mu\text{m} = 2.60 \times 10^3 \text{ W/m}^2\text{-sr}$$

Response over Wavelength Band - I

- The intensity across a wavelength band can be determined by integrating the Planck function:

$$\int_{\lambda_l}^{\lambda_u} i_{b\lambda}(\lambda, T) d\lambda = \int_{\lambda_l}^{\lambda_u} \frac{C_1}{\lambda^5 (e^{C_2/\lambda T} - 1)} d\lambda = i(\lambda_l, \lambda_u, T) \quad (3)$$

- However, no closed form solution exists, so that the integration must be performed numerically, for example by:
 - › Polynomial functions (e.g. Simpson's rule)
 - › Gaussian quadrature
 - › Series solution

Response over Wavelength Band-II

- A useful expression for the fraction of power between zero and a specified wavelength is:

$$F_{0 \rightarrow \lambda T} = \frac{15}{\pi^4} \sum_{n=1}^{\infty} \frac{e^{-n\xi}}{n} \left(\xi^3 + 3 \frac{\xi^2}{n} + 6 \frac{\xi}{n^2} + 6 \frac{1}{n^3} \right) \quad (4)$$

$$\text{where } \xi = \frac{C_2}{\lambda T} \text{ and } F_{0 \rightarrow \lambda T} = \frac{e_{0 \rightarrow \lambda T}}{\sigma T^4} \quad (5)$$

- So that the fractional power between two wavelengths is

$$F_{\lambda_l T \rightarrow \lambda_u T} = F_{0 \rightarrow \lambda_u T} - F_{0 \rightarrow \lambda_l T} \quad (6)$$

Fraction of Total Power In-Band Energy

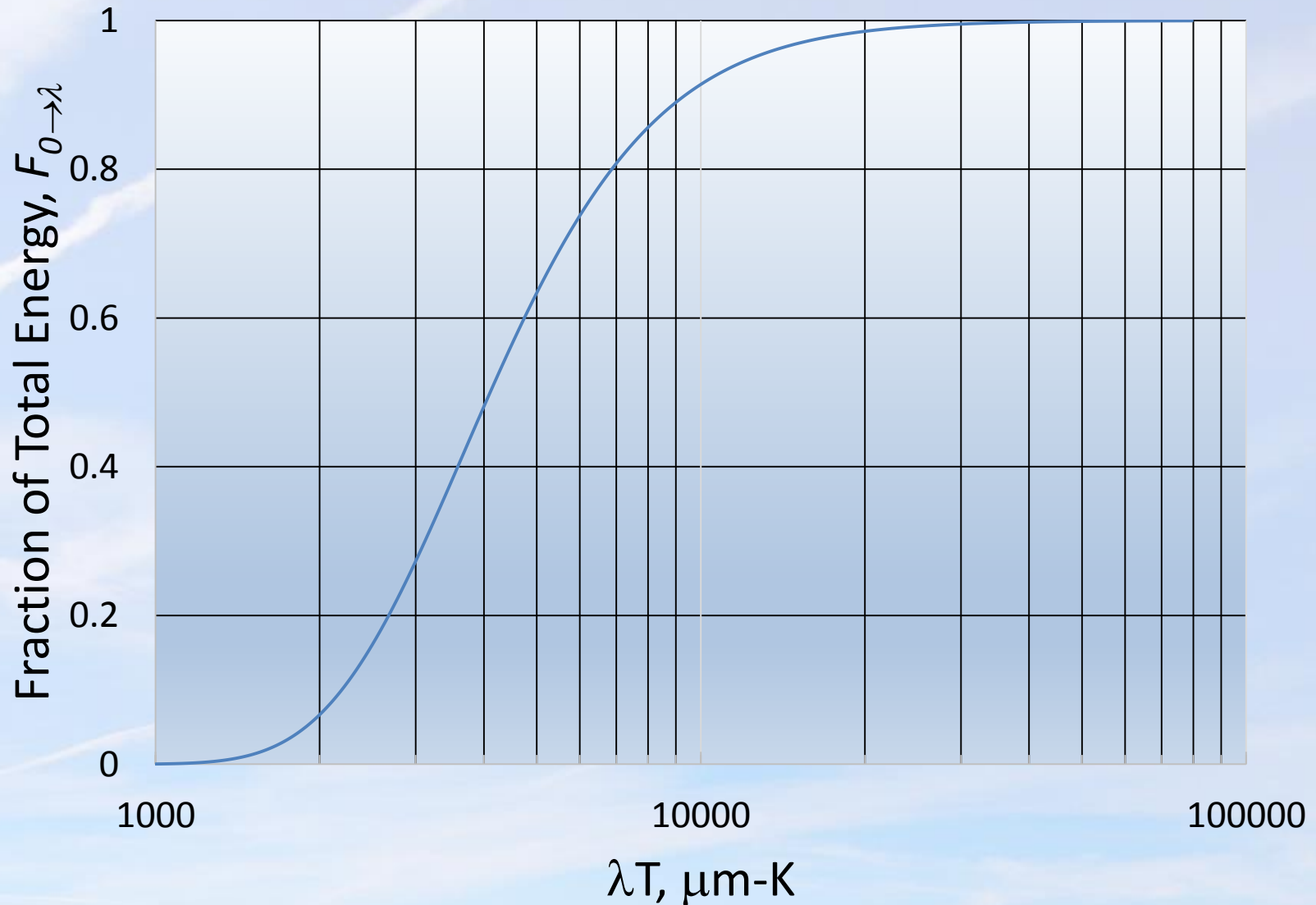

Response over Wavelength Band-III

Over all wavelengths, the total blackbody intensity is:

$$\int_0^{\infty} i_{b,\lambda}(\lambda, T) d\lambda = \int_0^{\infty} \frac{C_1}{\lambda^5 (e^{C_2/\lambda T} - 1)} d\lambda = i_b(0, \infty, T) = \frac{\sigma T^4}{\pi} \quad (7)$$

which is known as the Stefan-Boltzmann law.

The total hemispherical emissive power is:

$$e_b = \pi \int_0^{\infty} i_{b,\lambda}(\lambda, T) d\lambda = \sigma T^4 \quad (8)$$

The quantity σ is known as the Stefan-Boltzmann constant and is equal to:

$$5.6704 \times 10^{-8} \text{ W/m}^2\text{-K}^4 \text{ or } 0.1714 \times 10^{-8} \text{ Btu/hr-ft}^2\text{-}^\circ\text{R}^4$$

Definition of Hemispherical Emissive Power

- To calculate the radiant power of a planar surface requires the integration into a hemispherical cap over the surface

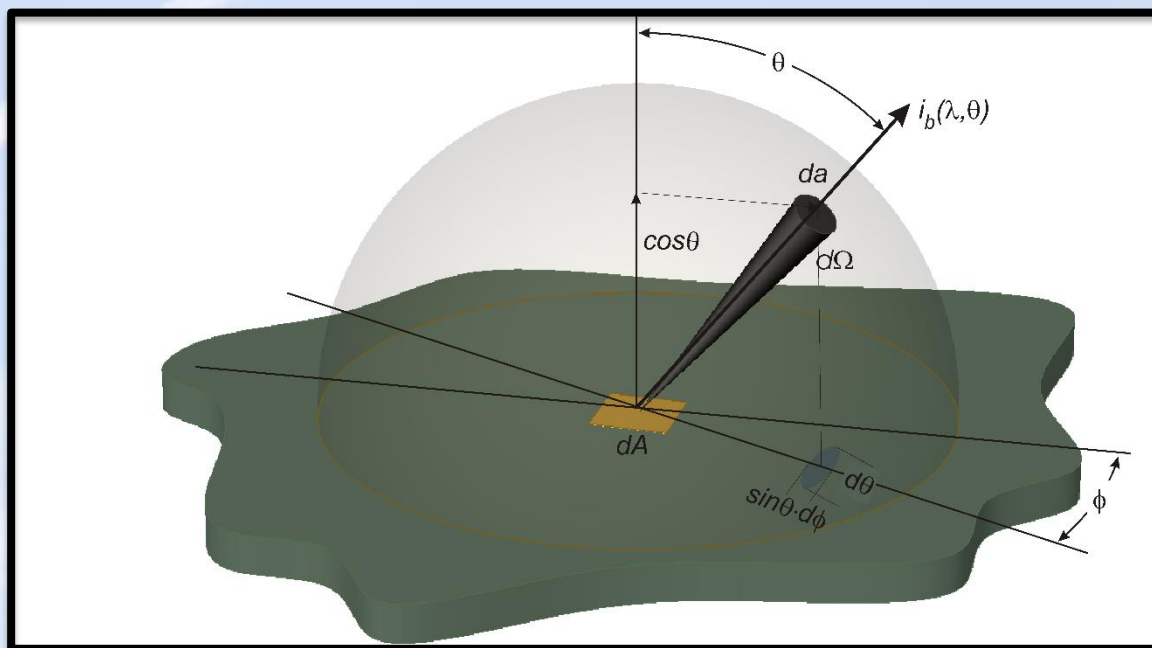

$$e_{b\lambda}(\lambda, T) = i_{b\lambda}(\lambda, T) \int_{\phi=0}^{2\pi} \int_{\theta=0}^{\pi/2} \cos \theta \sin \theta d\theta d\phi = \pi i_{b\lambda}(\lambda, T) \quad (9)$$

$e_{b\lambda}(\lambda, T)$ is known as the spectral blackbody emissive power



Example 3 - I

E3: What is the total emitted energy flux for a body at 1,500 K?
What is the emitted flux between the wavelengths of 1 to 3 μm ?

Example 3 - II

A3: The total emitted flux is given by Equation 8 and calculated using bb_eb:

$$e_b = \sigma T^4 = 5.67 \times 10^{-8} \cdot 1,500^4$$

$$= 2.87 \times 10^5 \text{ W/m}^2$$

The wavelength-temperature products for 1 and 3 μm at 1,500K are:

$$\lambda_l T = 1,500 \text{ } \mu\text{m-K} \text{ and } \lambda_u T = 4,500 \text{ } \mu\text{m-K}$$

$$F_{0 \rightarrow \lambda_l T} = 0.01285 \text{ and } F_{0 \rightarrow \lambda_u T} = 0.56430$$

$$\text{So } e_{\lambda_l T \rightarrow \lambda_u T} = F_{\lambda_l T \rightarrow \lambda_u T} \cdot \sigma T^4$$

$$= (F_{0 \rightarrow \lambda_u T} - F_{0 \rightarrow \lambda_l T}) \cdot \sigma T^4$$

$$= (0.56430 - 0.01285) \cdot 2.87 \times 10^5 \text{ W/m}^2$$

$$= 1.58 \times 10^5 \text{ W/m}^2$$

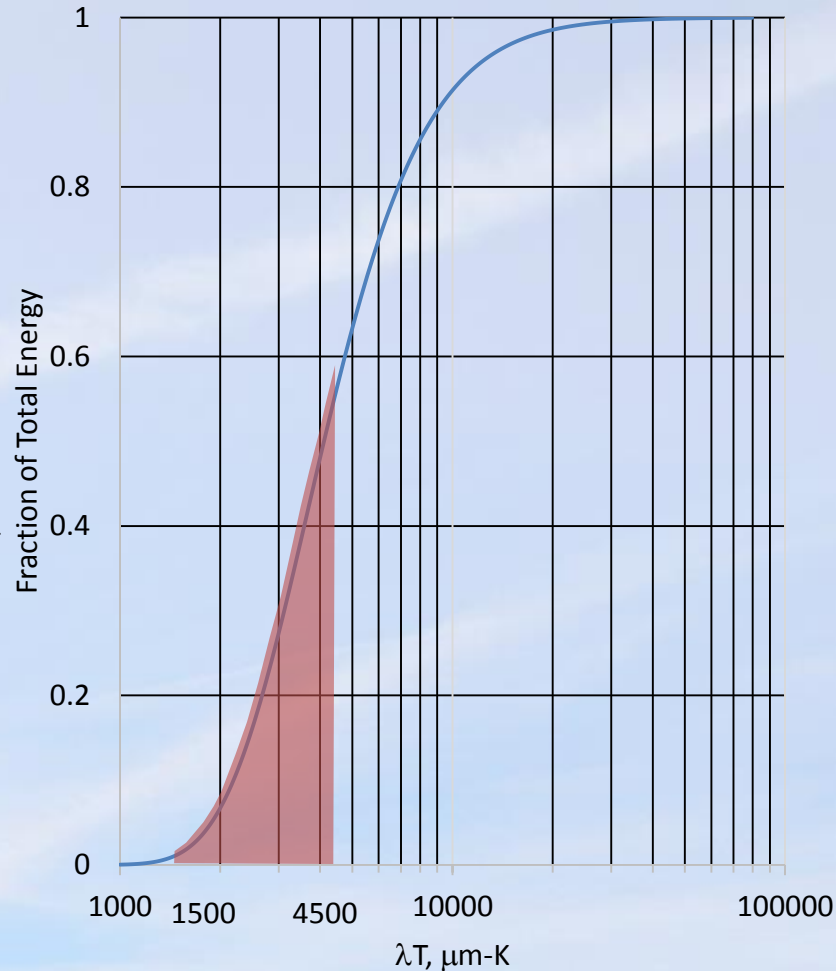



Fundamental Physics - III

- Real surfaces do not emit radiation like an idealized blackbody
- Instead, real surfaces emit at a lower rate
- The fraction of radiation a surface emits relative to a blackbody is known as the emissivity
- The emissivity of a surface varies with direction, wavelength, and temperature

Fundamental Physics - IV

- Non-black surfaces always emit less energy than a blackbody (Kirchhoff's Law).
- The ratio of the actual energy emitted by a body to that of a blackbody at the same temperature is known as the total hemispherical emissivity and is given by:

$$\epsilon = i(T)/i_b(T) \quad (10)$$

Where $i_b(T)$ is the spectral emitted intensity at temperature T for an ideal black surface and $i(T)$ is the actual emitted intensity of the surface.



Fundamental Physics - V

- The emissivity of a surface has a value from 0 to 1
- Surface emissivities vary from near 1 for non-reflective materials such as graphite and carbon black to values less than 0.1 for reflective surfaces such as polished gold and copper.
- The special case where the emissivity is constant across the wavelength band is known as a gray surface



Room-Temperature Emissivities of Common Materials

Metals		Non-Metals	
Material	Emissivity	Material	Emissivity
Aluminum Commercial Sheet	0.09	Asphalt	0.93
Aluminum Highly Polished	0.039 - 0.057	Black Epoxy Paint	0.89
Beryllium	0.18	Brick, red rough	0.93
Brass Polished	0.03	Carbon, not oxidized	0.81
Cast Iron, newly turned	0.44	Clay	0.91
Copper electroplated	0.03	Concrete	0.85
Copper Nickel Alloy, polished	0.059	Cotton cloth	0.77
Copper Polished	0.023 - 0.052	Glass smooth	0.92 - 0.94
Gold not polished	0.47	Ice rough	0.985
Gold polished	0.025	Ice smooth	0.966
Inconel X Oxidized	0.71	Lampblack paint	0.96
Iron, dark gray surface	0.31	Magnesium Oxide	0.20 - 0.55
Lead Oxidized	0.43	Masonry Plastered	0.93
Lead pure unoxidized	0.057 - 0.075	Paper	0.93
Magnesium Polished	0.07 - 0.13	Plaster	0.98
Mercury liquid	0.1	Plaster board	0.91
Molybdenum polished	0.05 - 0.18	Plastics	0.91
Nickel, electroplated	0.03	Pyrex	0.92
Platinum, polished plate	0.054 - 0.104	Rubber, natural hard	0.91
Silver Polished	0.02 - 0.03	Salt	0.34
Stainless Steel, polished	0.075	Sand	0.76
Steel Polished	0.07	Silica	0.79
Tin unoxidized	0.04	Silicon Carbide	0.83 - 0.96
Titanium polished	0.19	Soil	0.38
Tungsten aged filament	0.032 - 0.35	Teflon	0.92
Tungsten polished	0.04	Water	0.95 - 0.963
Wrought Iron	0.94	Wood Oak, planned	0.885
Zinc polished	0.045	Wood, Pine	0.95

Selected values taken from The Engineering Toolbox, Emissivity Coefficients of some common Materials, http://www.engineeringtoolbox.com/emissivity-coefficients-d_447.html



Fundamental Physics - VI

- The spectral emissivity is temperature and wavelength dependent and can vary substantially as the surface conditions change.
- There is no general theory that allows one to calculate the emissivity for all materials, so values are most often obtained experimentally.



Spectral Variation of Emissivity for Graphite, Carbon-Carbon, and Carbon-Silicon Carbide

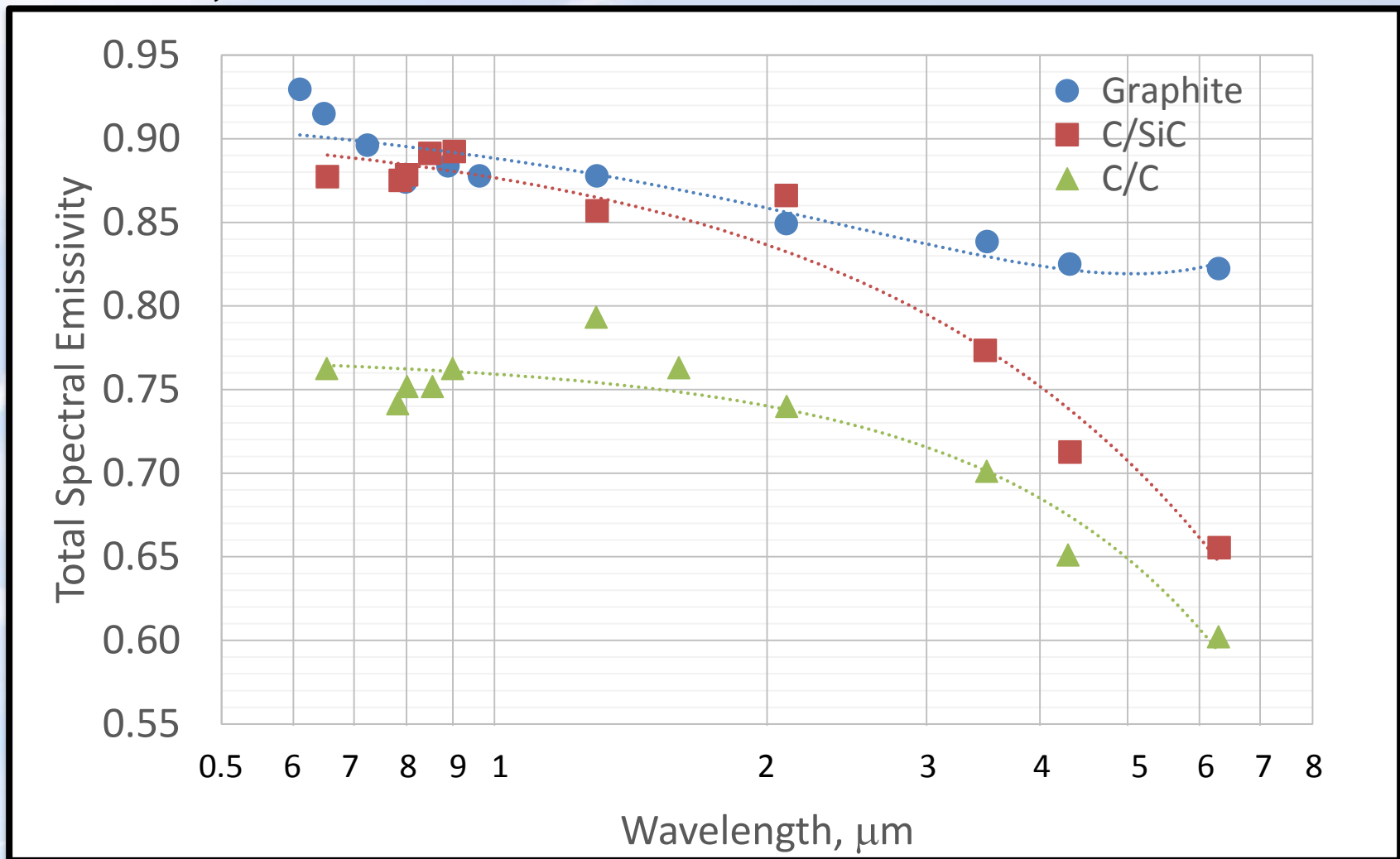

Data from Neuer, G., "Emissivity measurements on graphite and composite materials in the visible and infrared spectral range," *QIRT 92, Eurotherm Series 27*, EETI ed., Paris, 1992.



Emissivity as a Function of Temperature

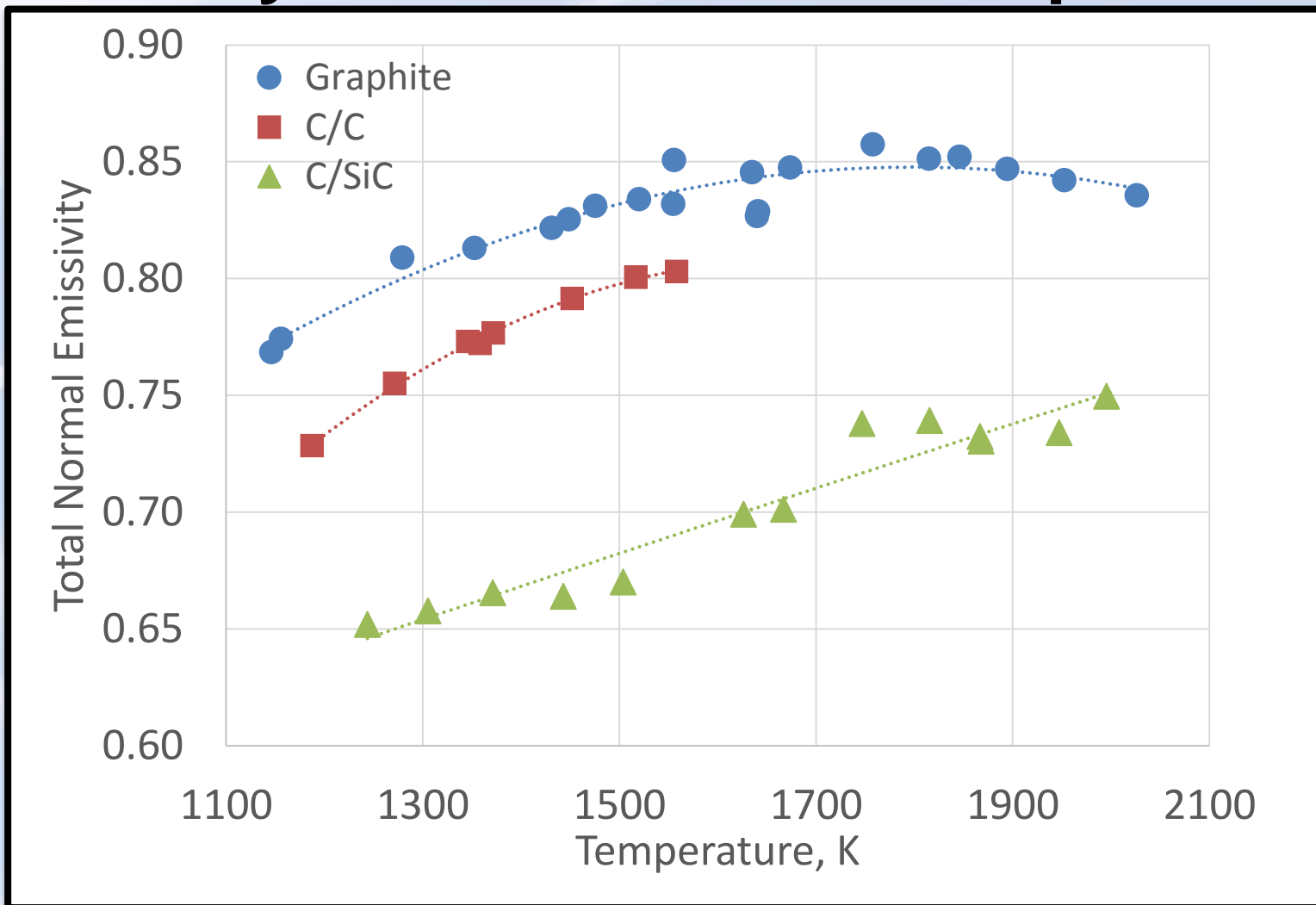

Total normal emissivity of graphite, carbon/carbon, and C/SiC composite. From Neuer, G., Emissivity Measurements on graphite and composite materials in the visible, and infrared spectral range, QIRT 92-Eurotherm Series 27 – EETI, Paris, 1992

Methods to Increase Emissivity

It is possible to increase the emissivity if physical modification to the sample surface is allowed. The following methods increase the effective emissivity of the sample to values near 1 and therefore decrease the relative uncertainty in derived temperatures.

- High Emissivity Paints and Coatings ($\epsilon > 0.95$)
 - › Organic and silicon based brush on coatings are good up to 625 K
 - › Ceramic-based, black-pigmented coating for ceramic fiber modules and refractories are good to 1,650 K
- Drilled cavity
 - › Drill a hole into the sample and measure the temperature inside the hole
- “Volcano” cavity
 - › Build up a “volcano” cavity on the surface using ceramic or carbon cements

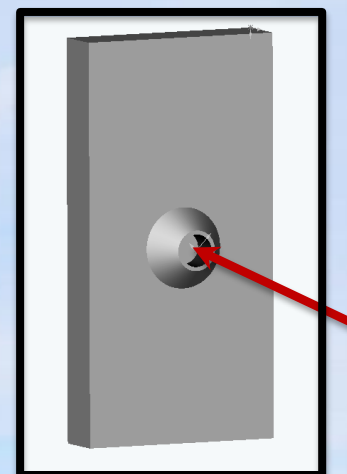
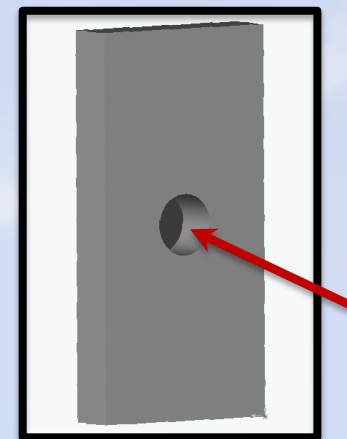



Summary of Part I

- All bodies above absolute zero emit thermal radiation.
- The quantity of power emitted is measured by the radiative intensity.
- Energy is distributed across the electromagnetic spectrum and the intensity of emission and the shape of the distribution is dependent on the temperature.
- Conversely, the temperature of a body can be measured by the quantity and spectral distribution of energy it emits.
- A blackbody is an idealized physical body that absorbs all incident electromagnetic radiation and emits electromagnetic radiation called blackbody radiation.
- The intensity and distribution of energy is governed by Planck's law and is determined by the wavelength of light and the temperature.
- Real surfaces do not emit radiation like an idealized blackbody, but instead, real surfaces emit at a lower rate.
- The fraction of radiation a surface emits relative to a blackbody is known as the emissivity.



**This is the end of Part I.
Please continue to Part II.**