



# Cryogenic Orbital Testbed (CRYOTE) Ground Test Article Final Report

*Wesley L. Johnson  
Glenn Research Center, Cleveland, Ohio*

*Noah O. Rhys and David E. Bradley  
Yetinspace, Inc., Huntsville, Alabama*

*Mark Wollen  
Innovative Engineering Solutions, Murrieta, California*

*Bernard Kutter and Mari Gravlee  
United Launch Alliance, Denver, Colorado*

*Laurie K. Walls  
Kennedy Space Center, Florida*

## NASA STI Program . . . in Profile

Since its founding, NASA has been dedicated to the advancement of aeronautics and space science. The NASA Scientific and Technical Information (STI) Program plays a key part in helping NASA maintain this important role.

The NASA STI Program operates under the auspices of the Agency Chief Information Officer. It collects, organizes, provides for archiving, and disseminates NASA's STI. The NASA STI Program provides access to the NASA Technical Report Server—Registered (NTRS Reg) and NASA Technical Report Server—Public (NTRS) thus providing one of the largest collections of aeronautical and space science STI in the world. Results are published in both non-NASA channels and by NASA in the NASA STI Report Series, which includes the following report types:

- TECHNICAL PUBLICATION. Reports of completed research or a major significant phase of research that present the results of NASA programs and include extensive data or theoretical analysis. Includes compilations of significant scientific and technical data and information deemed to be of continuing reference value. NASA counter-part of peer-reviewed formal professional papers, but has less stringent limitations on manuscript length and extent of graphic presentations.
- TECHNICAL MEMORANDUM. Scientific and technical findings that are preliminary or of specialized interest, e.g., “quick-release” reports, working papers, and bibliographies that contain minimal annotation. Does not contain extensive analysis.
- CONTRACTOR REPORT. Scientific and technical findings by NASA-sponsored contractors and grantees.
- CONFERENCE PUBLICATION. Collected papers from scientific and technical conferences, symposia, seminars, or other meetings sponsored or co-sponsored by NASA.
- SPECIAL PUBLICATION. Scientific, technical, or historical information from NASA programs, projects, and missions, often concerned with subjects having substantial public interest.
- TECHNICAL TRANSLATION. English-language translations of foreign scientific and technical material pertinent to NASA's mission.

For more information about the NASA STI program, see the following:

- Access the NASA STI program home page at <http://www.sti.nasa.gov>
- E-mail your question to [help@sti.nasa.gov](mailto:help@sti.nasa.gov)
- Fax your question to the NASA STI Information Desk at 757-864-6500
- Telephone the NASA STI Information Desk at 757-864-9658
- Write to:  
NASA STI Program  
Mail Stop 148  
NASA Langley Research Center  
Hampton, VA 23681-2199



# Cryogenic Orbital Testbed (CRYOTE) Ground Test Article Final Report

*Wesley L. Johnson  
Glenn Research Center, Cleveland, Ohio*

*Noah O. Rhys and David E. Bradley  
Yetinspace, Inc., Huntsville, Alabama*

*Mark Wollen  
Innovative Engineering Solutions, Murrieta, California*

*Bernard Kutter and Mari Gravlee  
United Launch Alliance, Denver, Colorado*

*Laurie K. Walls  
Kennedy Space Center, Florida*

National Aeronautics and  
Space Administration

Glenn Research Center  
Cleveland, Ohio 44135

## Acknowledgments

The authors would like to acknowledge the Launch Services Program and United Launch Alliance for providing funding and hardware for the test article and testing.

Trade names and trademarks are used in this report for identification only. Their usage does not constitute an official endorsement, either expressed or implied, by the National Aeronautics and Space Administration.

*Level of Review:* This material has been technically reviewed by technical management.

Available from

NASA STI Program  
Mail Stop 148  
NASA Langley Research Center  
Hampton, VA 23681-2199

National Technical Information Service  
5285 Port Royal Road  
Springfield, VA 22161  
703-605-6000

This report is available in electronic form at <http://www.sti.nasa.gov/> and <http://ntrs.nasa.gov/>

## Contents

1.0	Introduction.....	1
2.0	Test Objectives.....	2
3.0	Test Article Description.....	3
3.1	Multilayer Insulation.....	5
3.2	Instrumentation.....	6
4.0	Test Facility.....	9
5.0	Test Results and Analysis.....	11
5.1	Checkout Testing.....	11
5.2	Boil-Off Testing.....	12
5.3	TVS Testing.....	16
5.4	Fill Testing.....	20
5.4.1	Vented Fills.....	20
5.5	No Vent Fill.....	23
6.0	Conclusion.....	25
	References.....	26

## List of Figures

Figure 1.—CRYOTE GTA under construction.....	4
Figure 2.—The Cryo-Tracker, support rod, and spray head installed on the CRYOTE GTA lid.....	4
Figure 3.—P-clamp attachment of the fill, vent, and pressure sense line on the CRYOTE GTA lid.....	5
Figure 4.—Inlet diffuser.....	6
Figure 5.—MLI bottom layer designs, notice the yellow lines at the top of the cones where the three outer sub-blankets are terminated along the skirt.....	7
Figure 6.—Top MLI blankets, again notice the yellow rings on the top of the conical sections.....	7
Figure 7.—Detailed cross-section of CRYOTE GTA and main instrumentation (Courtesy of IES).....	8
Figure 8.—Tank lid with thermocouples on the lid, tank fill line, and tank vent line.....	9
Figure 9.—The ESTF at MSFC.....	10
Figure 10.—ESTF fluid schematic (Courtesy of Yetinspace).....	10
Figure 11.—CRYOTE GTA fill level during testing.....	11
Figure 12.—CRYOTE GTA heat loads and wetted wall surface area as a function of fill level.....	13
Figure 13.—Tank temperatures as a function of fill level.....	14
Figure 14.—Lower hemisphere steady state MLI temperatures as a function of fill level.....	15
Figure 15.—Upper hemisphere steady state MLI temperatures as a function of fill level.....	15
Figure 16.—CRYOTE GTA TVS cycle T-S diagram.....	16
Figure 17.—CRYOTE GTA TVS System.....	17
Figure 18.—TVS operations when fully open.....	17
Figure 19.—Bulk liquid temperature and pressure during long TVS run.....	18
Figure 20.—MLI temperatures reacting to TVS operation.....	18
Figure 21.—TVS cycles controlled on TC05: (a) temperature, (b) pressure, and (c) mass.....	19
Figure 22.—Facility performance during vented fill.....	21
Figure 23.—Mass balance during vented fill.....	21
Figure 24.—Tank pressure during vented fill.....	22
Figure 25.—Vented fill summary.....	22
Figure 26.—NVF summary.....	24
Figure 27.—Last 2 minutes of NVF.....	25
Figure 28.—NVTO pressure history.....	25

## List of Tables

Table 1.—CRYOTE GTA Test Matrix.....	11
Table 2.—Thermocouples That Did <i>Not</i> Work .....	12
Table 3.—Tabular Data from Figure 12 .....	13
Table 4.—Ventline Entrance Temperatures for Constant Heat Load .....	13
Table 5.—Comparison of TVS Runs and Passive Runs .....	20
Table 6.—Lessons Learned During Testing .....	26

# **Cryogenic Orbital Testbed (CRYOTE)**

## **Ground Test Article**

### **Final Report**

Wesley L. Johnson  
National Aeronautics and Space Administration  
Glenn Research Center  
Cleveland, Ohio 44135

Noah O. Rhys and David E. Bradley  
Yetinspace, Inc.  
Huntsville, Alabama 35808

Mark Wollen  
Innovative Engineering Solutions  
Murrieta, California 92562

Bernard Kutter and Mari Gravlee  
United Launch Alliance  
Denver, Colorado 80112

Laurie K. Walls  
National Aeronautics and Space Administration  
Kennedy Space Center  
Kennedy Space Center, Florida 32899

## **1.0 Introduction**

Liquid propulsion has been used since Robert Goddard started developing a liquid oxygen (LO<sub>2</sub>) and gasoline powered rocket and fired it in 1923 (Ref. 1). In the following decades engineers settled on the combination of liquid hydrogen (LH<sub>2</sub>) and LO<sub>2</sub> as the most efficient propellant combination for in-space travel. Due to their low temperatures (LH<sub>2</sub> at 20 K and LO<sub>2</sub> at 90 K), they require special handling and procedures. General Dynamics began developing LO<sub>2</sub> and LH<sub>2</sub> upper stages in 1956 in the form of Centaur, these efforts were soon funded by the Department of Defense in conjunction with NASA (beginning in 1958) (Ref. 2). Meanwhile NASA also worked with McDonnell Douglas to develop the SIV-B stage for the Saturn V rocket. In the subsequent years, the engineers were able to push the Centaur to up to 9 hr of orbital lifetime and the SIV-B to up to 6 hr. Due to venting the resultant boil-off from the high heat loads through the foam insulation on the upper stages, both vehicles remained in a settled configuration throughout the flights, thus the two phases of propellant (liquid and vapor) were separated at a known location. The one exception to this were the Titan/Centaur missions, which thanks to the lower boil-off using three layers of multilayer insulation (MLI), were able to coast unsettled for up to 5.25 hr during direct geosynchronous orbit insertion missions. In the years since there has been a continuous effort to extend the life of these upper stages from hours to days or even months.

There have been many attempts to develop long duration cryogenic fluid storage and transfer demonstrations in the past 50 years. Starting with the Mars Nuclear Vehicle (MNV) in the late 1960s and

early 1970s, NASA and industry has attempted multiple times to get funding for an in-space technology demonstration (Refs. 3 and 4). In the meantime large amounts of ground testing have been performed on candidate technologies for flight (Ref. 5). While most of these tests have been focused on the component level, more recently the idea of an integrated test system with multiple components has been envisioned. One such attempt at such a demonstration is the Cryogenic Orbital Testbed (CRYOTE) (Ref. 6). As a part of the CRYOTE technology demonstration concept, a ground test article (GTA) has been developed with multiple technologies and components. Some of the components included for testing are MLI to reduce the heat load to the entire system, a composite skirt to lower the structural heat load on the test article, a thermodynamic vent system (TVS) to remove the small amount of thermal energy that does pass through the MLI and structure, a vapor cooled heat exchanger on the skirt to increase the amount of sensible heat that can be extracted through the TVS, and a Cryo-Tracker (Sierra Lobo, Inc.) liquid level gauge. While the long term goal of the effort was LH<sub>2</sub> testing, liquid nitrogen (LN<sub>2</sub>) testing was completed in the first phase of testing due to budget constraints.

CRYOTE was conceived by United Launch Alliance (ULA) and was derived from work in partnership with the NASA Glenn Research Center as a possible low cost cryogenic flight experiment (Refs. 7 and 8). Early conceptual evaluation was performed by both ULA and Innovative Engineering Solutions (IES) in early 2008 (Refs. 6 and 9). Others soon joined the collaboration as interest grew. Of the partners, Sierra Lobo provided a Cryo-Tracker for the ground article, the Jet Propulsion Laboratory (JPL) donated surplus flight-qualified titanium tanks to use as receiver tanks, NASA Kennedy Space Center has funded avionics studies and designed, fabricated, and installed the MLI insulation system (fabrication and installation done in conjunction with United Space Alliance), and IES led the initial design effort, designed and coordinated fabrication of the composite structural skirt, and performed structural and fluid systems assembly of the first test article. Testing occurred at the NASA Marshall Space Flight Center (MSFC) using LN<sub>2</sub>.

## 2.0 Test Objectives

The goal of the testing described in this paper was to demonstrate possible CRYOTE operations throughout the life cycle of a long duration on-orbit cryogenic propellant demonstration using LN<sub>2</sub>. There were four specific test objectives for the CRYOTE GTA. The first objective was a vented fill of GTA. The second objective was to determine steady state thermal performance of GTA. The third objective was to demonstrate the use of a simple TVS and integrated vapor cooling along the GTA structure. The last objective was to demonstrate a No-Vent Fill (NVF).

Demonstrating a vented fill was necessary to allow for determining the duration to steady state from a warm fill of the test article. This testing also allowed for validation of transient thermal chilldown and fill models and to assess the performance of the Cryo-Tracker within the GTA. The various parameters were calculated from the measured pressure and temperature of the tank and liquid as well as the measured volumetric flow rate into and out of the test article.

Determining the steady state thermal performance of the system was essential to anchor heat load and boil-off calculations and to set a basis for the TVS testing performed later. All steady state testing was performed at  $18.000 \pm 0.001$  psia while temperatures throughout the test article were measured, the volumetric boil-off rate, and the change in mass over time of the test article using load cells. Testing was performed at multiple fill levels: approximately 90, 80, 40, and 25 percent full. Fill level was determined by load cells.

A TVS is designed to allow the rejection of heat (and maintenance of internal pressure) from the bulk liquid and vapor of the tank without venting liquid when access to the ullage is not guaranteed (Ref. 10).



Testing on the CRYOTE TVS was to verify the design and also to quantify any reduction of heat load due to using the integrated vapor cooling tubing along the test article structure.

NVF testing was desired in order to demonstrate the fill level achievable on the ground as an analog to a flight experiment. It was thought that by using the shower head, spraying in a direction opposed to the gravitational vector, gravity would be a much less important parameter and the data would be generally applicable to flight. Previous testing showed that hydrogen systems could be filled to nearly 95 percent full during a NVF at high flow rates (Ref. 11). However, those tests required pre-chilling of the tank and nominal CRYOTE mission operations started with a tank near room temperature. If multiple tests were possible, determining the effect of the LN<sub>2</sub> source sub-cooling level on the fill was desired along with optimizing the loading procedure.

### 3.0 Test Article Description

The CRYOTE GTA consists mainly of an Evolved Expendable Launch Vehicle (EELV) Secondary Payload Adaptor (ESPA) ring, a composite skirt and a spherical titanium tank (see Figure 1). The 29.7 in. titanium tank donated by JPL is considerably smaller than what could be accommodated within the ESPA ring (standard ESPA rings are approximately 60 in. in diameter), but the tank is a flight qualified design, light weight (hence low thermal mass), and was available at minimal cost. During the testing the ESPA ring provided little input except to act as a support for the rest of the test article, so it is generally ignored, during flight, it would provide structural support and allow for integration with the launch vehicle.

The conical composite structural skirt, fabricated of S-glass and Sapphire 77 (Scorpius Space Launch Company) cryogenic epoxy resin was designed to attach the cryogenic tank to the warm ESPA ring. Although some studies have shown that a system of small diameter cylindrical struts might yield slightly better mass and thermal properties for this particular application, a “skirt” design was chosen for two reasons. Firstly, skirt designs which provide continuous load paths between cryogenic tankage and warm structure are currently of greater interest for launch vehicle and large space tankage systems. Hence the selected “skirt” design is more representative these designs. Secondly, installation of MLI on multiple struts can be a tedious process, and degradation of the MLI performance around these struts can offset much of the thermal advantages that would otherwise be realized. It was thought to be much easier to feather in the MLI around the skirt than multiple struts.

The composite skirt includes an active cooling coil that intercepts heat being conducted through the skirt with hydrogen gas that is being vented from the tank. The active cooling coil functions as one part of a TVS, with the other parts being the expansion valve or orifice (installed inside and at the lower section of the tank), and the flow regulating orifice (at the warm gas outlet). For the GTA, the expansion valve is a fixed orifice, sized such that the vent gas pressure in the cooling coil will be approximately 5 to 10 psia when the outlet valve is open sufficiently to maintain a constant tank pressure by venting the boil-off caused by the expected tank heat load.

A single Sierra Lobo Cryo-Tracker (shown in Figure 2) was installed along a vertical rod cantilevered off the tank flange, and used to validate probe operation, demonstrate loading measurement capability, as well as provide basic fill level indication for the test article. The Cryo-Tracker had four temperature sensors located at approximately 1.625-, 14.625-, 21.0-, and 27.75-in. from the lid. The respective fill levels are 99, 50, 20.5, and 1 percent.

The titanium 6Al-4V tank is a 29.7 in. OD Spherical tank with 0.05 in. walls. There is an 8-in. diameter Stainless Steel 304 flange on the top of the tank (0.375 in. thick). At LN<sub>2</sub> temperature (77 K) the volume of the tank is 216 liters (7.616 ft<sup>3</sup> – the volume of a 29.6 in. sphere is 7.820 ft<sup>3</sup> after temperature

related shrinkage). The tank is connected to the composite skirt via four support tabs that are located at about the 40 percent full level. The tabs are approximately a half in deep and 2-in. wide.

The fill, vent, and pressure sense line wrap around the OD of the skirt once each. They are held off of the skirt approximately a half of an inch by P-clamps at four locations mounted equidistant around the skirt (see Figure 3). The fill and vent lines are each 0.5 in. tubing with 0.020 in. wall and made of stainless steel type 304. The length of each line is approximately 4.57 m (15 ft) long: 0.76 m (2.5 ft) from the top of the tank to the skirt, 3.6 m (12 ft) around the skirt, and 0.15 m (0.5 ft) coming through the ESPA ring. The tubing is then routed from the ESPA ring to the vacuum chamber feed-throughs, which were approximately 3.0 m (10 ft) away.

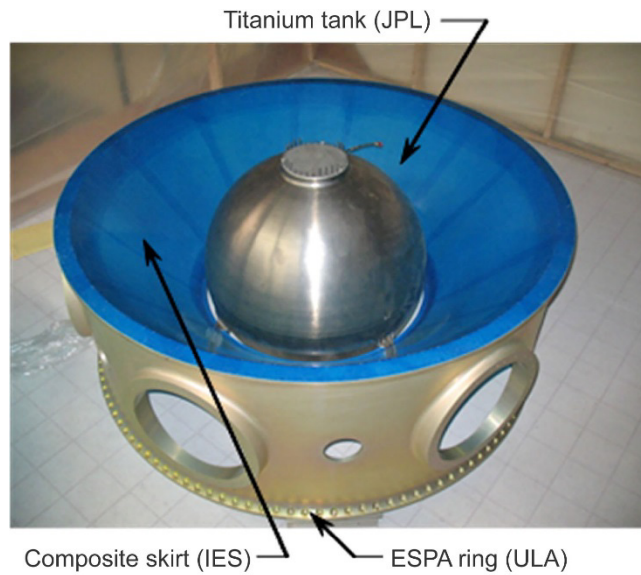

Figure 1.—CRYOTE GTA under construction.

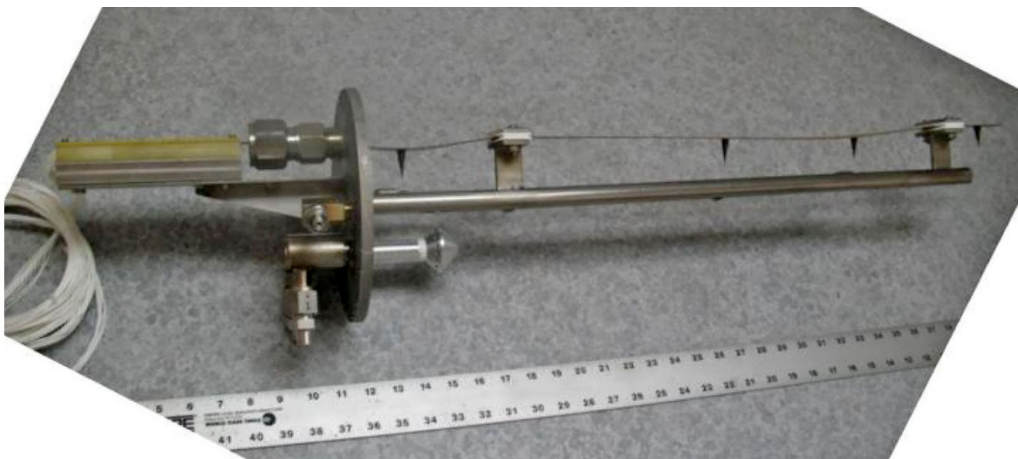

Figure 2.—The Cryo-Tracker, support rod, and spray head installed on the CRYOTE GTA lid.

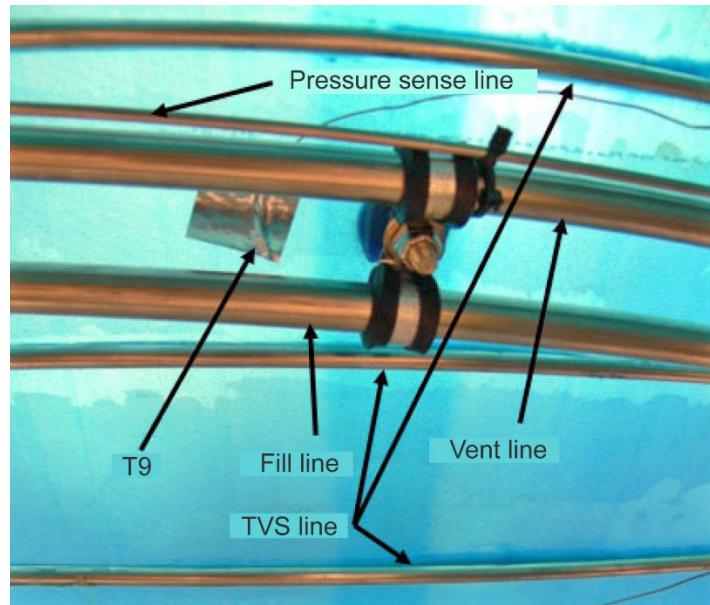

Figure 3.—P-clamp attachment of the fill, vent, and pressure sense line on the CRYOTE GTA lid.

The as-built TVS heat exchanger line has six loops around the skirt, is made of stainless steel type 304, and is 0.25 in. tubing with 0.020 in. wall thickness. The total length of the TVS heat exchanger is approximately 22.86 m (75 ft): 72.2 ft for the six loops around the skirt, 2.5 ft from the top of the tank to the skirt, and another approximately half of a foot from the skirt through the ESPA ring. At the entrance to the TVS line is a 0.020 in. orifice which is located at the second from bottom Cryo-Tracker cone.

The TVS line, pressure sense line, fill, and vent lines were all run into the tank from the top lid as see below. They are closed out at the top using VCR fittings with silver plated 316 stainless steel gaskets.

The inlet diffuser (see Figure 4) consists of an upward spraying shower head designed to cool off the large mass of the lid while the tank is filling. The diffuser exits are at 45° from the vertical, such that the flow is turned 315° within the diffuser. The inlet diffuser features 16 diffuser paths of diameter 0.0937 in. (3/32 in.), which totals roughly two-thirds of the area of the 0.5- by 0.020-in. inlet tubing.

### 3.1 Multilayer Insulation

The MLI on the GTA is nominally composed of 20 layers of double aluminized mylar and 40 layers of Dacron netting (B4A). The MLI blanket is composed of four sub-blankets each with an embossed inner and outer cover and four other layers of double aluminized mylar separated by double layers of netting. The seams (one per layer) are all overlapped on a layer by layer basis and were formed into conical and spherical shapes by laying the flat material over a dummy and cutting out a wedge to allow for shape formation. The sub-blankets are all held together by garment tags. The blankets were held in place by Velcro, however, on the blankets on the underside of the skirt, the Velcro had to be reinforced due to failure during shipping.



Figure 4.—Inlet diffuser.

The first sub-blanket completely covers the spherical tank (with exception to the Cryo-Tracker electronics, which will be discussed later), with two “doors” to all the tubing and thermocouple wires to come out near the interface with the skirt. Additionally, “doors” were cut to adapt around the four tank tab interfaces with the skirt. On the bottom hemisphere, the blankets come around the outer side of the skirt up in a conical manner to points along the skirt that were predetermined by a “temperature matching” scheme. Figure 5 shows the bottom MLI design, with the three yellow lines on the upper conical section of the skirt showing the termination points for the three outer blankets. The outer three sub-blankets on the top came down around the top hemisphere of the tank to the point where the temperature of the inner of the three sub-blankets matched the temperature along the skirt profile. At this point, the blankets were run across to the skirt, creating almost a shelf between the skirt and the tank. The outer two sub-blankets then ran up along the skirt to the position that where they matched the skirt temperature. The outer blankets are shown in Figure 6. The upper hat (visible in both Figure 5 and Figure 6) was required to encompass the Cryo-Tracker. It was constructed separately from the other blankets out of 20 layers of MLI (not in sub-blankets) and installed after the other sub-blankets were installed.

### 3.2 Instrumentation

Over 35 thermocouples were mounted onto the GTA to enhance understanding of how the system worked and to find issues within the system, all thermocouples are type E made from 30 gauge wire unless otherwise noted. Figure 7 shows the location of many of the thermocouples that were installed for testing.

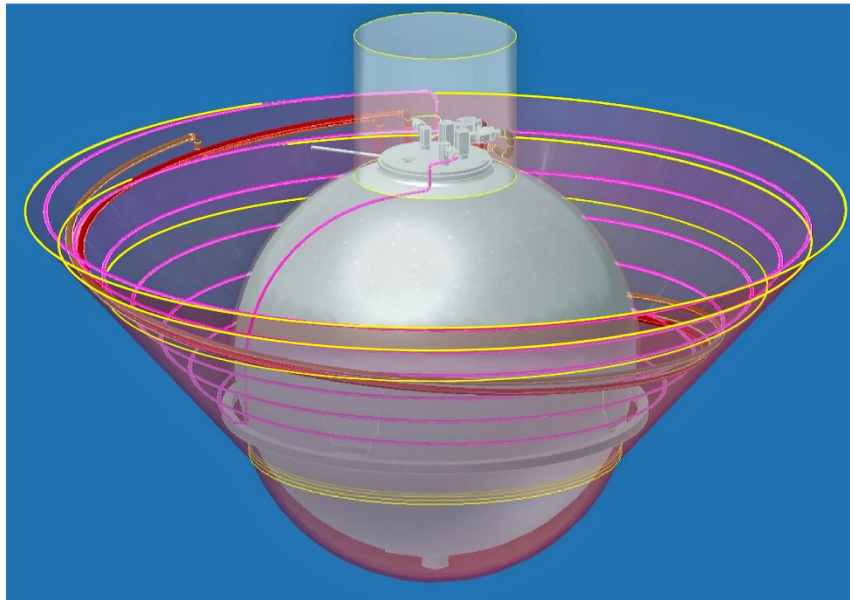

Figure 5.—MLI bottom layer designs, notice the yellow lines at the top of the cones where the three outer sub-blankets are terminated along the skirt.

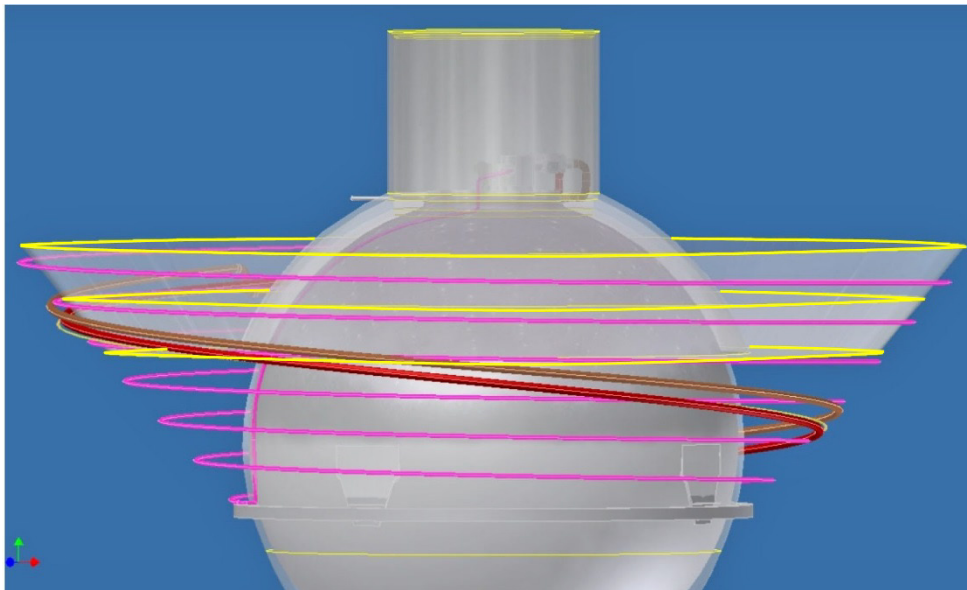

Figure 6.—Top MLI blankets, again notice the yellow rings on the top of the conical sections.

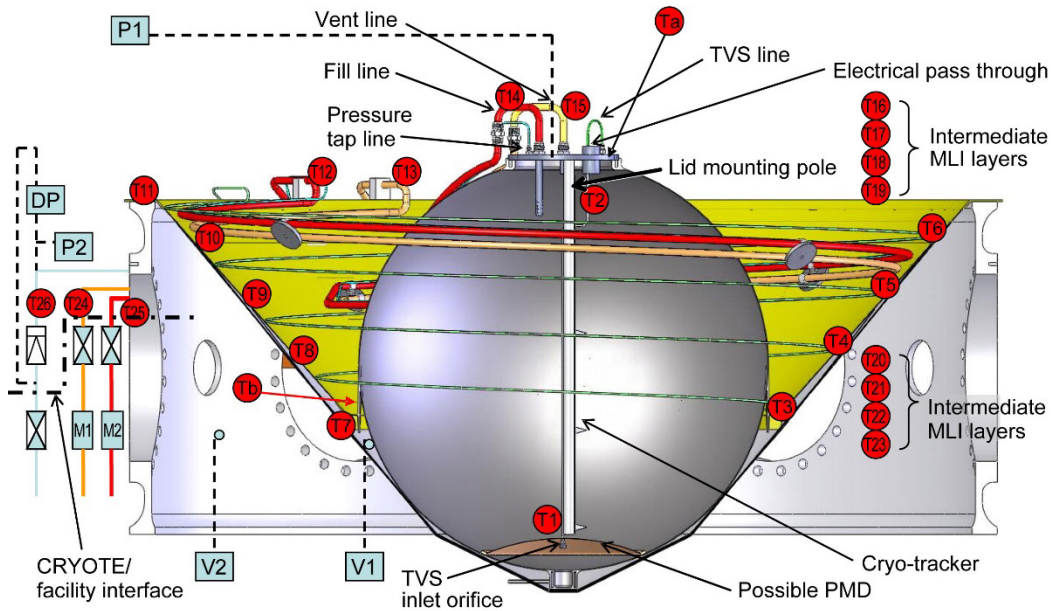

Figure 7.—Detailed cross-section of CRYOTE GTA and main instrumentation (Courtesy of IES).

The skirt was instrumented with seven thermocouples. Thermocouple number 7 (T7) was between the stiffener ring at the bottom of the skirt and the first loop of the TVS line. T8 was between the first and second loop of the TVS line, T9 was between the third and fourth loop of the TVS line. T10 was between the fifth and sixth loop of the TVS line. T11 was above the sixth loop of the TVS line and also above all of the MLI temperature matching locations. T7 – T11 were used to measure the temperature profile of the skirt. T16 and T17 were on the skirt where the second and third MLI sub-blankets abutted the skirt, they were used to measure the effectiveness of the temperature matching of the skirt. Four thermocouples are located along the skirt heat exchanger. T3 is at the point where the line comes through the skirt, T4 is one spiral up from T3, T5 is two more spirals up from T4, and T6 is two more spirals up from T5. Thermocouples on the TVS line were 180° apart from the sensors on the skirt.

Three temperature sensors were located on the tank directly; another was on a titanium support tab. Ta was located on the tank lid, but did not work during testing. T21 was located on the bottom hemisphere of the tank, at approximately the 25 percent full level. T28 was located on the top hemisphere at approximately the 80 percent full level. There were temperature measurements on the entrance to both the vent and fill lines (see Figure 8). These thermocouples (along with the temperature measurements on the top hemisphere of the tank) were routed along the pressure sense line through the skirt.

There are thermocouple sensors on each sub-blanket of MLI on both the top and bottom hemispheres. T22-T24 and T24H are on the bottom hemisphere and are numbered in order starting at the sub-blanket closest to the tank. On the top hemisphere, T29-T32 are on the outer layer of each sub-blanket. Additionally, T18 and T19 were on the top hemisphere blankets where the blankets met the skirt, closely in-line with T16 and T17 which were on the skirt.

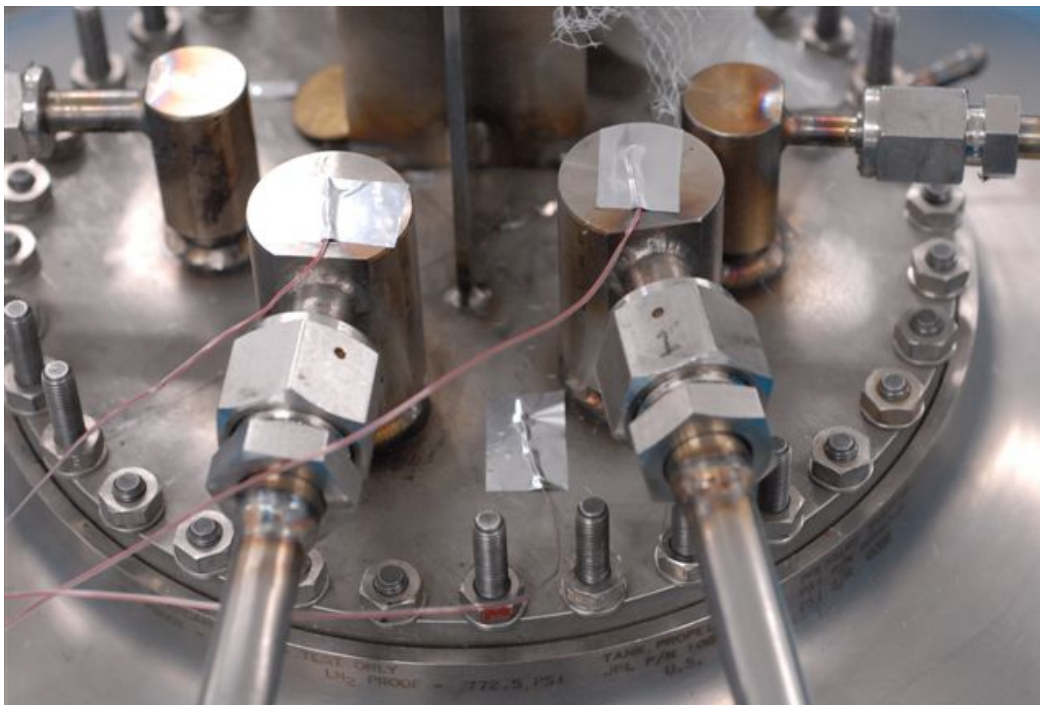

Figure 8.—Tank lid with thermocouples on the lid, tank fill line, and tank vent line

## 4.0 Test Facility

The CRYOTE GTA was tested at MSFC's Explorations Systems Test Facility (ESTF) (see Figure 9). The facility consists of a 9 ft diameter by 20 ft long vacuum chamber (capable of pressures below  $10^{-8}$  Torr), LN<sub>2</sub> supply and drain (either from facility dewars or a tanker), back pressure control anywhere between 0 and 1000 Torr (19.3 psia) to within 0.1 Torr, system control, data acquisition, and up to 240 kW of power. The entire system is certified for operation up to 150 psia and has a vacuum boil-off accumulator. Multiple flowmeters are plumbed in parallel to allow for a rapidly responding to multiple orders of magnitude change in flow. The schematic for the ESTF is shown in Figure 10.

Of main importance to the CRYOTE GTA is the fill line plumbing between the furthest most LN<sub>2</sub> bypass line and the test article itself. The closest LN<sub>2</sub> bypass is located inches away from the vacuum chamber itself. Inside the vacuum chamber, there was 10 ft of tubing between the vacuum chamber wall and the test article and then the aforementioned 15 ft of tubing between the entrance to the test article and the diffuser inside the tank. Thermocouples T14 and T12 show the temperature profile along this fill line. T14 is the fill line entrance as seen in Figure 8 and T12 is on the fill line exit right at the ESPA ring. These thermocouples provide important information regarding the chilling of the transfer line going into the GTA.

ESTF boil-off flowmeters installed during the CRYOTE GTA testing were V605 (range between 0.0025 and 0.025 actual cubic feet per minute (ACFM)), V602 (0.02 to 0.2 ACFM), V604 (1 to 10 ACFM), and V460. Liquid flowmeters was measured by F304 (0.75 to 7.5 gpm) while flow meter T362 (5 to 50 ACFM) is on the TVS line. When the back pressure system is on, the accumulator pressure is measured and controlled by a MKS Baratron 627D (0 to 1000 Torr) capacitance manometer with integrated valve.

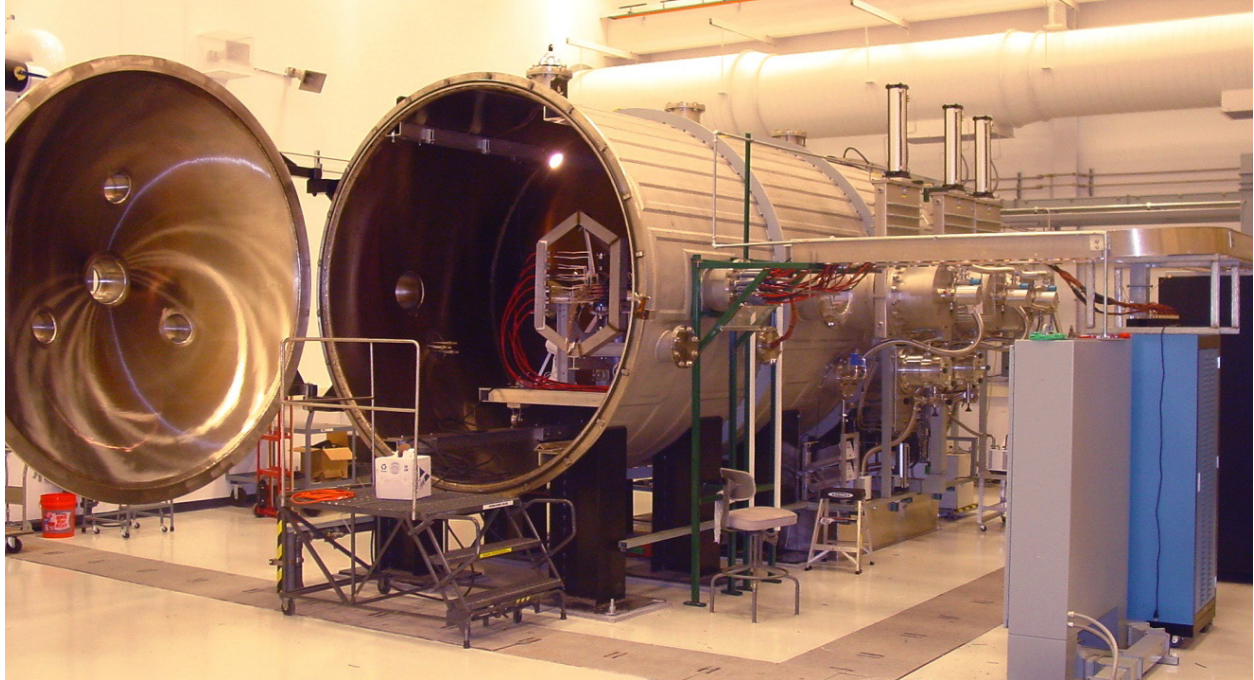

Figure 9.—The ESTF at MSFC.

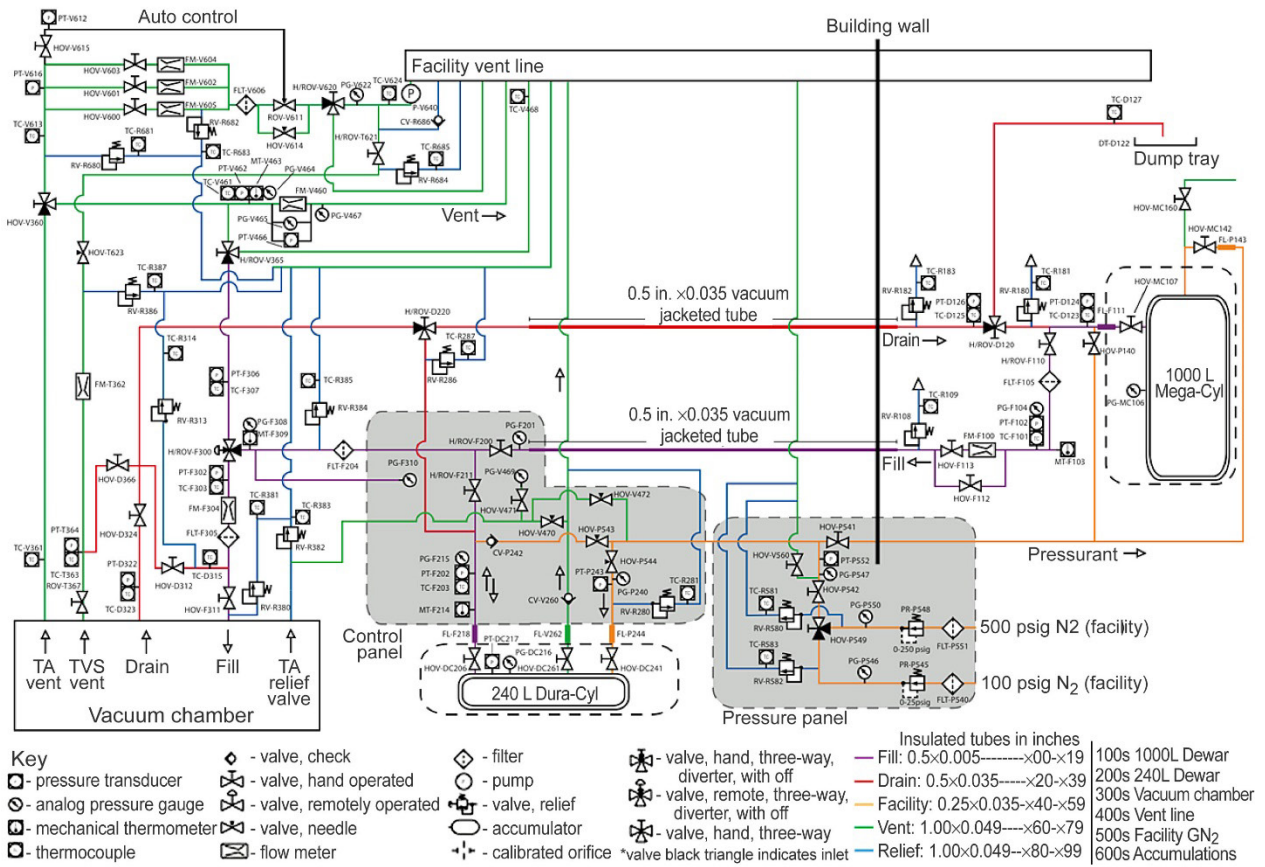

Figure 10.—ESTF fluid schematic (Courtesy of Yetinspace).



## 5.0 Test Results and Analysis

Testing consisted of checkout testing, boil-off testing (at various fill levels), several vented fills, TVS operations, a No-Vent Top-Off (NVTO), and a NVF. The test matrix is shown in Table 1. Testing mostly occurred between mid-November of 2011 and March of 2012 with the exception of the NVF which occurred towards the end of May 2012. Testing in 2011 was for facility checkout and data from this time frame was not used. Figure 11 shows the fill level of the test article over that time span. The sharp increase at the end of January is the NVTO. The first portion was checkout testing and the second portion was where the data presented was taken. Several locations in the plot show knees in the fill level curve; these are where the TVS operations began or ended.

### 5.1 Checkout Testing

After the GTA was installed in the vacuum chamber, it was filled via a vented fill and then underwent a series of boil-off tests and thermodynamic vent line check out tests. These checkout tests were mainly to give the operations team a feel for how the different systems worked together. Of special interest was the control logic for the TVS, understanding if the simple TVS could control to the tank pressure or if other logic would be required to enable control of the tank pressure. This checkout time was very valuable to the test team.

During checkout it was realized that without a drain line in the tank, it took many days (close to a month) for the system to fully drain. The team also tried to drain the tank using the TVS line, that worked and went much faster (it still took over a day to fully drain the system), however, it could not be used to quickly change the fill level because it took several days for the TVS system temperatures to return to the pre-operation levels.

TABLE 1.—CRYOTE GTA TEST MATRIX

Type	Fill level	Notes	Date
Transient Fill 2	0 to 100%	Thermal equilibrium reached at 90.8%	1/20/12
Steady State	93, 80, 40, and 25%		1/21/12, 2/7/12, 2/23/12, 3/5/12
TVS	25 to 30% 76 to 92%	TVS ops increased overall mass loss	12/16 to 12/18, 2011 2/8 to 2/20, 2012
No Vent Top Off	78 to 97%	Thermal equilibrium reached at 93.2%	1/31/12
No Vent Fill	0 to 100%	Saturated at 38 psia, not shown below	5/23/12

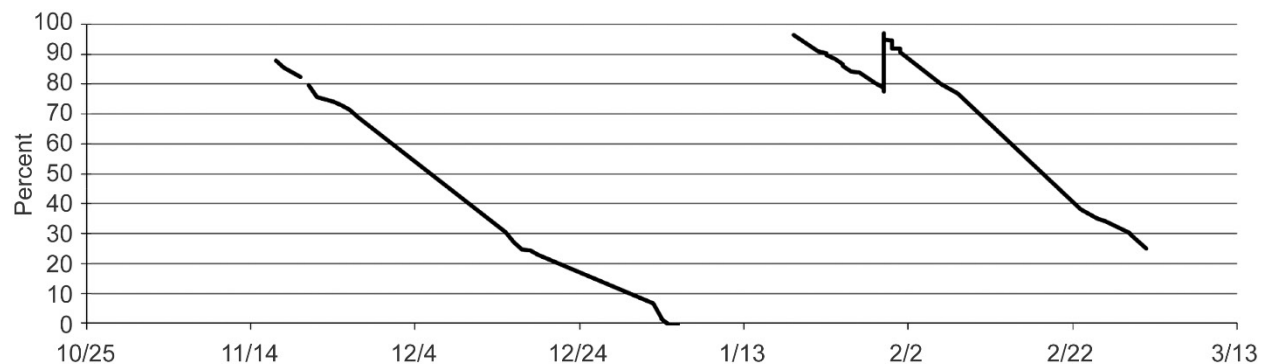

Figure 11.—CRYOTE GTA fill level during testing.

TABLE 2.—THERMOCOUPLES THAT DID *NOT* WORK

Designation	Location	Back-up for data purposes
a	Tank Lid	T14 and T15
T1	TVS line – tank exit	None
T2	TVS line - Inlet	None
T18	MLI at Temperature Match	T16
T19	MLI at Temperature Match	T17

The TVS system was originally designed to reject 10 W of cooling. During checkout testing it was discovered that the 0.02 in. orifice that was submerged in the liquid allowed a much higher flowrate than was anticipated. This meant that the TVS system could actually reject much closer to 60 W. This took the duty cycle of the TVS system from 50 percent to just under 10 percent to maintain pressure control.

During checkout testing, several thermocouples were found to have failed. These thermocouples are listed in Table 2. Several of the thermocouples had back-up options while others did not. The checkout time period allowed for spotting these thermocouples and planning workarounds.

## 5.2 Boil-Off Testing

Boil-off testing was accomplished at four different fill levels: 93, 80, 40, and 25 percent. The 93 percent level was as full as the tank could be filled and then allowed to settle back to steady state. The 80 percent testing was meant to give a reasonably full level that wasn't as full as it could be. The 40 percent fill level put the liquid vapor interface approximately at the location of the tabs where the tank connected to the composite skirt, and the 25 percent testing gave a low fill level and with the liquid vapor interface below the tabs. All of the flowmeter data was found to be within a few percent of the load cell data during the tests with the exception of the 40 percent full test where there was a 7 percent difference and it was felt that the load cell data was more accurate, so it was used for that test.

Figure 12 shows the heat load data for the testing at the various fill levels (the data is show in tabulated form in Table 3). The blue squares indicate the heat load if only the latent heat of vaporization of the fluid is accounted for and the red diamonds with blue outline include the sensible heat intercepted by the vapor based on the vent line entrance temperature (the thermocouple was mounted on the outside of the vent line entrance block—see Figure 8). The green curve shows the wetted surface area of the sphere as a function of fill level. Since heat load should not be a strong function of fill level, even with a titanium (low thermal conductivity) tank, this would indicate that measuring the two positions on the flange of the tank were not indicative of the actual vent flow temperature. By reverse calculation and assuming that the correct heat load was constant and at either 8.3 or 9.53 W, a range of probable vent temperatures can be calculated. These temperatures are shown in Table 4. The temperatures in the table, especially in the 8.3 W column are not extremely far off of the temperatures plotted in Figure 13. However, the 25 percent full case temperatures are much higher.

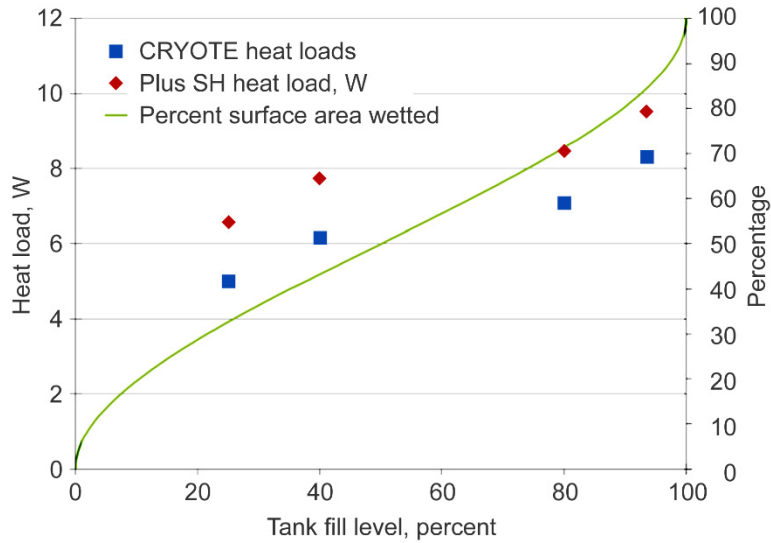

Figure 12.—CRYOTE GTA heat loads and wetted wall surface area as a function of fill level.

TABLE 3.—TABULAR DATA FROM FIGURE 12

Mean fill level, % full	Flow rate, kg/s	Latent heat	Plus SH
		Heat load, W	Heat load, W
93.6	$4.21 \times 10^{-5}$	8.30	9.53
80	$3.59 \times 10^{-5}$	7.08	8.50
40	$3.14 \times 10^{-5}$	6.16	7.74
25	$2.54 \times 10^{-5}$	5.01	6.57

TABLE 4.—VENTLINE ENTRANCE TEMPERATURES FOR CONSTANT HEAT LOAD

Mean fill level, % full	Flow rate, kg/s	8.3 W	9.53 W
		Heat input, K	Heat input, K
93.6	$4.21 \times 10^{-5}$	79.1	105.8
80	$3.59 \times 10^{-5}$	110.2	142.6
40	$3.14 \times 10^{-5}$	142.5	179.8
25	$2.54 \times 10^{-5}$	201.1	247.5

In conjunction with the total heat load decreasing with decreasing fill level, the tank temperatures increased with decreasing fill level. Figure 13 shows the tank temperature at two locations and the tank lid temperature. Even the MLI sub-blanket temperatures changed with the fill level (increasing with decreasing fill level) as shown in Figure 14 and Figure 15.

To determine how much of that change was due to conduction, a thermal model was put together. Starting with the temperature portion of the energy equation (often called the heat equation) in spherical coordinates, the conduction along the tank wall above the liquid level line can be described by:

$$\frac{1}{r^2} \frac{\partial}{\partial r} \left( kr^2 \frac{\partial T}{\partial r} \right) + \frac{1}{r^2 \sin^2 \theta} \frac{\partial}{\partial \phi} \left( k \frac{\partial}{\partial \phi} \right) + \frac{1}{r^2 \sin^2 \theta} \frac{\partial}{\partial \theta} \left( k \sin \theta \frac{\partial T}{\partial \theta} \right) + \dot{q} = \rho c_p \frac{dT}{dt}$$

Modeling the heat flux as a uniform heat generation term across the wall thickness, a simple, one-dimensional parameter can be derived using the boundary conditions of symmetry (temperature gradient equals 0) at the top of the tank and change in temperature equals 0 at the liquid interface at steady state. The result is:

$$T - T_0 = \frac{\dot{q}r^2}{k} \ln(\sin \theta) - \frac{\dot{q}r^2}{k} \ln(\csc \theta - \cot \theta) = \frac{\dot{q}r^2}{k} \ln(\sin \theta_0) + \frac{\dot{q}r^2}{k} \ln(\csc \theta_0 - \cot \theta_0)$$

where  $\theta_0$ , is the angle created between the center and the radius that intersects the tank at the liquid-vapor interface from the top (Ref. 12). The results of the equation when applied to the CRYOTE GTA tank is also shown in Figure 13. At the 80 and 93 percent fill levels, the conduction prediction is fairly close to both the measured lid temperature and the predicted temperatures in Table 4. However, a sharp divergence is seen in the 40 to 50 percent fill level. This indicates that the nitrogen gas convection is dominating the conduction heat transfer or that the temperature sensors are reading artificially low for some reason. No reason is known for the thermocouple to have been reading low. As such it is assumed that the convection in the ullage is becoming the dominant method of heat transfer

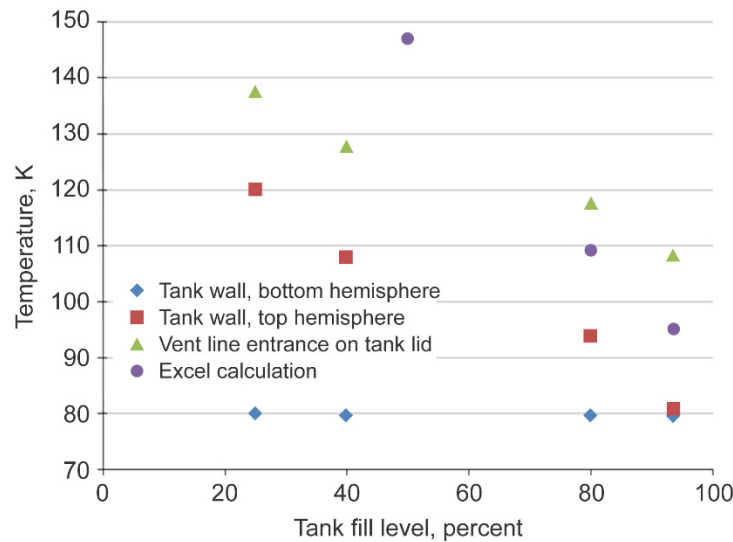

Figure 13.—Tank temperatures as a function of fill level.

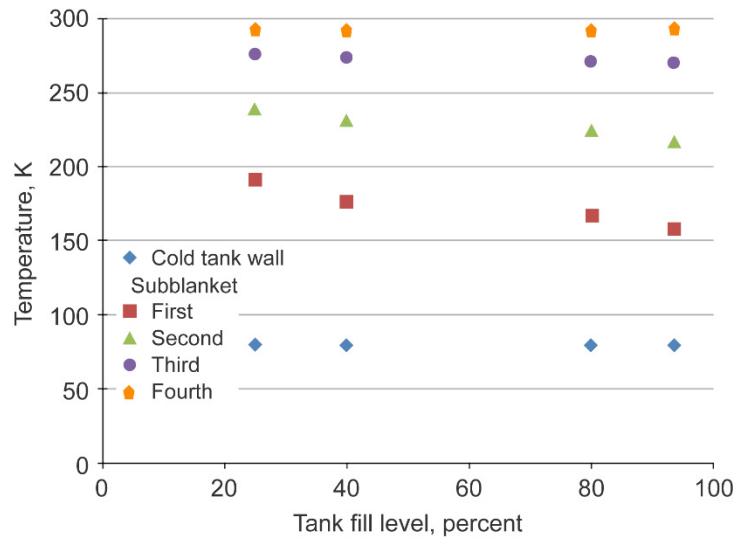

Figure 14.—Lower hemisphere steady state MLI temperatures as a function of fill level.

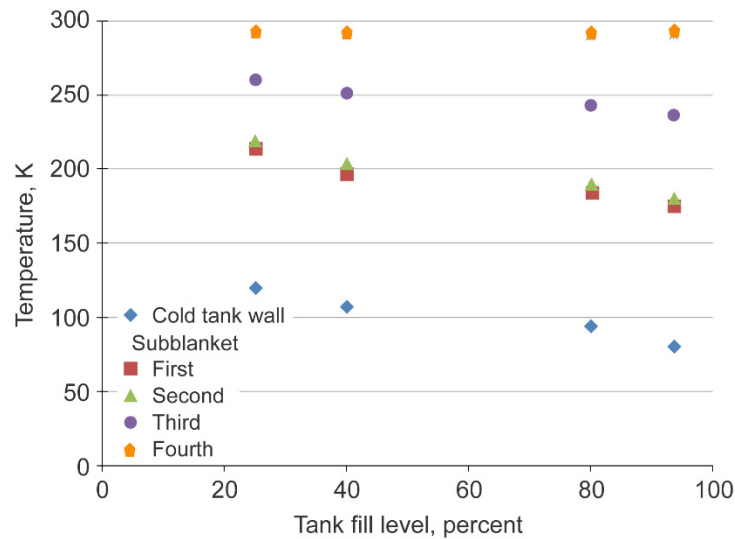

Figure 15.—Upper hemisphere steady state MLI temperatures as a function of fill level

The entire test article heat path was changing as a function of fill level. This impeded the attempt to temperature match the MLI blankets to the structure as the temperature of both became a moving target. This seems to mainly be attributed to the titanium tank, titanium has a much lower thermal conductivity than typical tank materials such as stainless steel and aluminum, by as much as an order of magnitude. Additionally, the tank was very thin walled, which only served to further limit the conduction from the bulk liquid to the top of the tank. However, as promising as this may seem for orbital cryogenic storage, the dominance of surface tension at low gravitational levels will cause much curvature in the interface and cause the entire tank surface area to be wetted a majority of the time. This will remove much of the advantage of the low conductivity tank design.

### 5.3 TVS Testing

A TVS is a method to vent only vapor during on-orbit operations when the ullage is at an unknown location. Figure 16 shows the basic thermodynamic cycle on a T-S diagram. The first phase is where the saturated bulk liquid is expanded across an orifice, flashing a portion of it through the isenthalpic expansion to a lower temperature, the second phase is where the energy is absorbed from the tank and the quality of the fluid flow increases. When the flow become a saturated vapor, the temperature begins to rise (phase 3) at which point it leaves the tank. As shown in Figure 17, the CRYOTE GTA TVS was a simple orifice (0.020 in. diameter) on the bottom of a tube that ran from the tank lid to nearly the bottom of the tank. The tube acted as the heat exchanger between the TVS fluid and the bulk liquid. When the TVS line left the tank, it routed down to the skirt, and then wrapped six loops around the skirt until it exited across the ESPA ring interface. The vapor leaving the TVS was vented to a vacuum. The tube wrapping around the skirt was designed to use the sensible heat of the vapor to intercept the heat coming down the skirt and lower the total heat load on the tank.

To show the effect of the TVS, it was left on continuously for 30 min, the result is shown in Figure 18. The top graph shows T3, T4, and T5 on the skirt. The temperatures of the skirt drop dramatically (it was determined that T3 is probably not well bonded to the tube, thus it's slower response time) when the TVS is initiated due to the cold vapor. T4 drops all the way below the temperature of saturated LN<sub>2</sub> at atmospheric pressure (-320 °F), indicating the pressure in the TVS line is below atmospheric and the TVS is working. The second graph shows the pressure in the tank does drop (a total of 0.8 psi in a matter of roughly 30 min), the first 0.1 psi is probably just a collapse of the ullage (indicative of initial stratification and naturally convective mixing) and the remainder a constant cooling of the bulk liquid (see Figure 19). Additionally, the TVS cools the entire test article, Figure 20 shows the reaction of T22 and T29, both within the MLI to TVS operation. T29 is located in the MLI on top of the article and cools more drastically due to the direct conduction from the cool flow between the tank exit and skirt mount as well as the fact that the MLI on top is being pulled by gravity on to the cooling skirt.

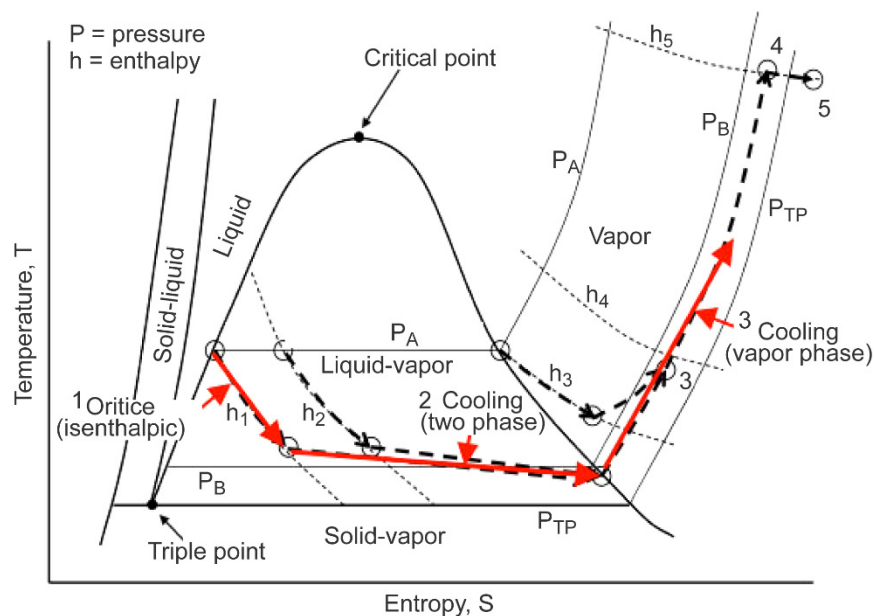

Figure 16.—CRYOTE GTA TVS cycle T-S diagram.

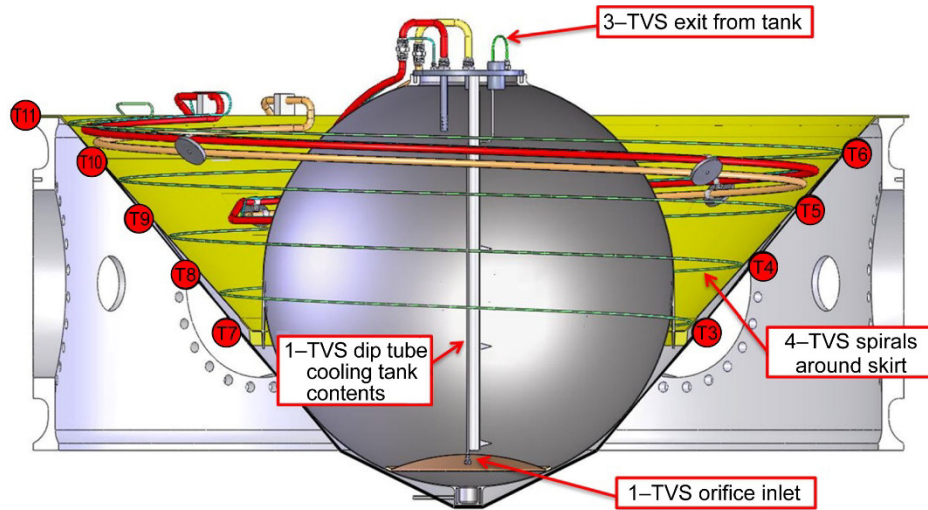

Figure 17.—CRYOTE GTA TVS System

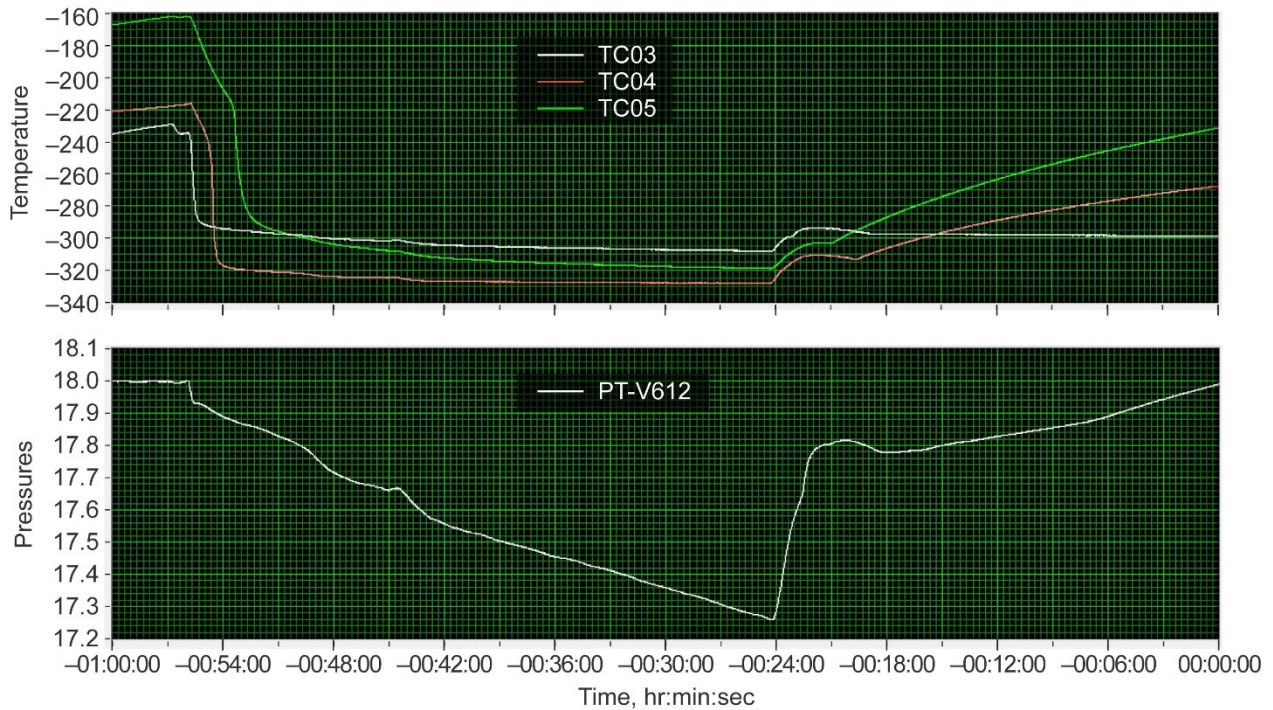

Figure 18.—TVS operations when fully open.

The TVS was run in several different control modes. The first control mode used was pressure control. The TVS vent valve was opened on a regular basis to maintain liquid loss rate (0.3 lb/hr) that was the same as during passive testing. However, the TVS couldn't control to pressure, as it didn't have enough surface area in the heat exchanger to effectively do that. Even when the system was allowed to run overnight as the pressure climbed, the TVS could steady out the pressure at the higher pressures.

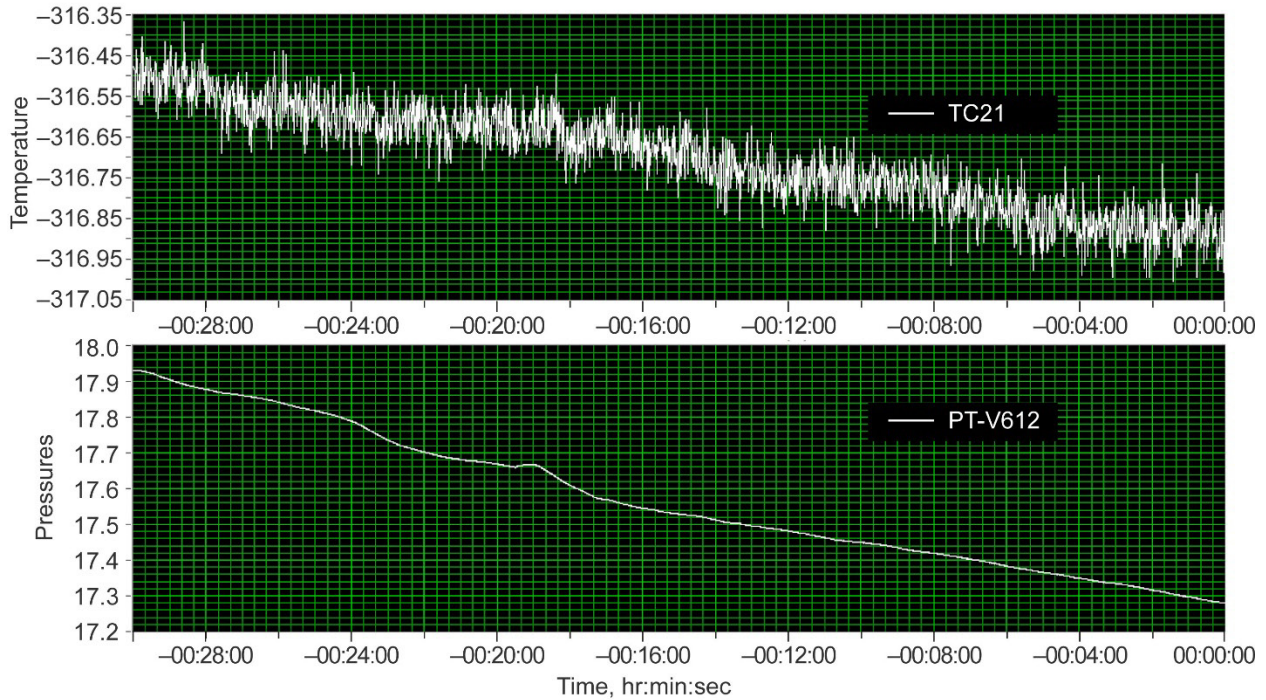

Figure 19.—Bulk liquid temperature and pressure during long TVS run.

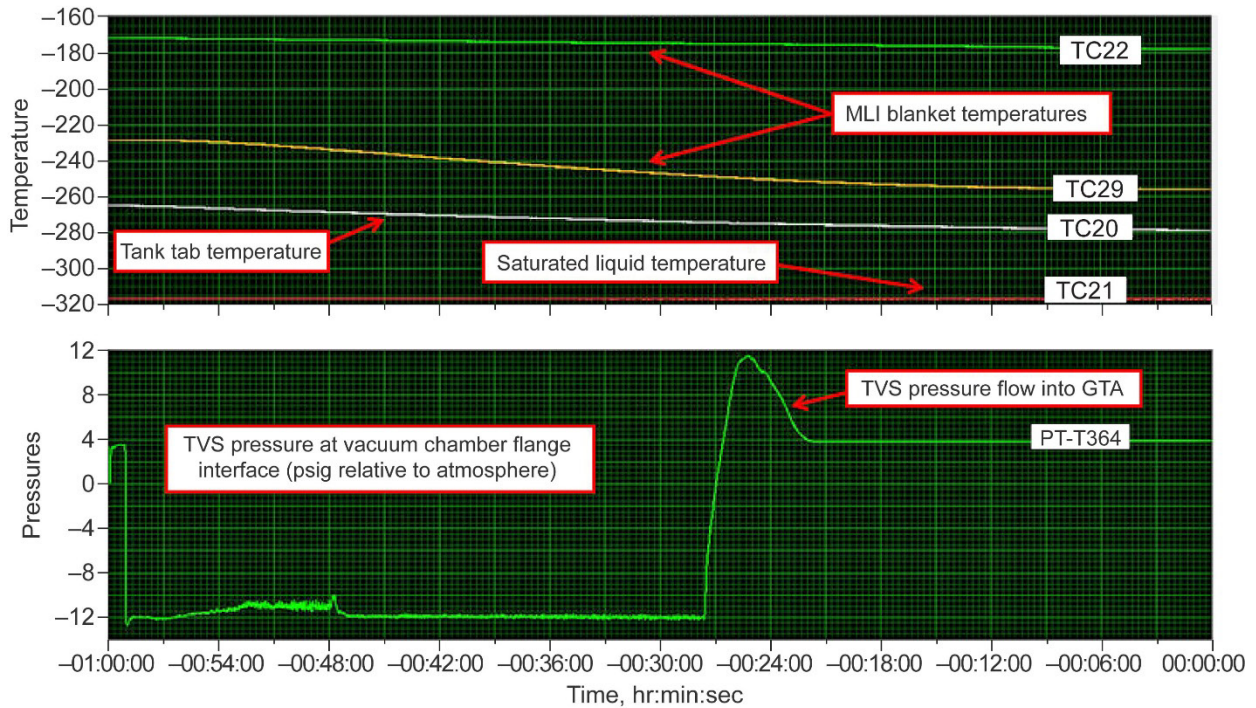

Figure 20.—MLI temperatures reacting to TVS operation.

The TVS was also run using various pulsed or cyclic operation. The cycle was set in one of two methods: temperature based and schedule based. The schedule based cycles left the TVS flow valve open for set periods of time, then closed the valve for another set period of time (for instance 20 sec open then 60 sec closed). The temperature based cycles used several different thermocouples as the control point,



but settled on T5 (on the third TVS coil) at roughly 189 K (−120 °F). Figure 21 shows the operation of the GTA triggered by TC05 and a timed duration. The cycles are clearly visible in the TVS tube temperatures and system pressures, but not in the GTA test article itself.

Table 5 shows a comparison between system operations when the TVS was running and when it wasn't running (passive mode only). The TVS operations did decrease the temperature of the skirt; however the overall mass loss ratio was higher. This was probably due to the fluid in the TVS line not being completely vaporized when it left the tank and thus vaporized in the TVS tubes, effectively increasing the surface area of the tank. Additionally, due to the transient nature of the TVS, there are start/stop inefficiencies and back flow from the TVS line that would be caused by liquid getting into the skirt heat exchanger. The addition of a more substantial heat exchanger in the tank would probably solve most of the issues that were seen with the simple TVS installed in the GTA.

During CRYOTE GTA testing, the TVS system was successfully operated. The TVS heat exchanger reduced the skirt structural temperatures by over 100 K in most places near the skirt-tank interface. The system was found to be well oversized for the passive heat load requiring the system to be operated in pulsed mode. The pulsed operations for this configuration worked best when they were based on temperature sensors on the skirt, not on system pressures. The TVS operational scenarios used roughly 25 percent more liquid than passive operation. It is expected that using a smaller orifice and adding a more substantial heat exchanger in the ullage will solve the issues encountered in the testing.

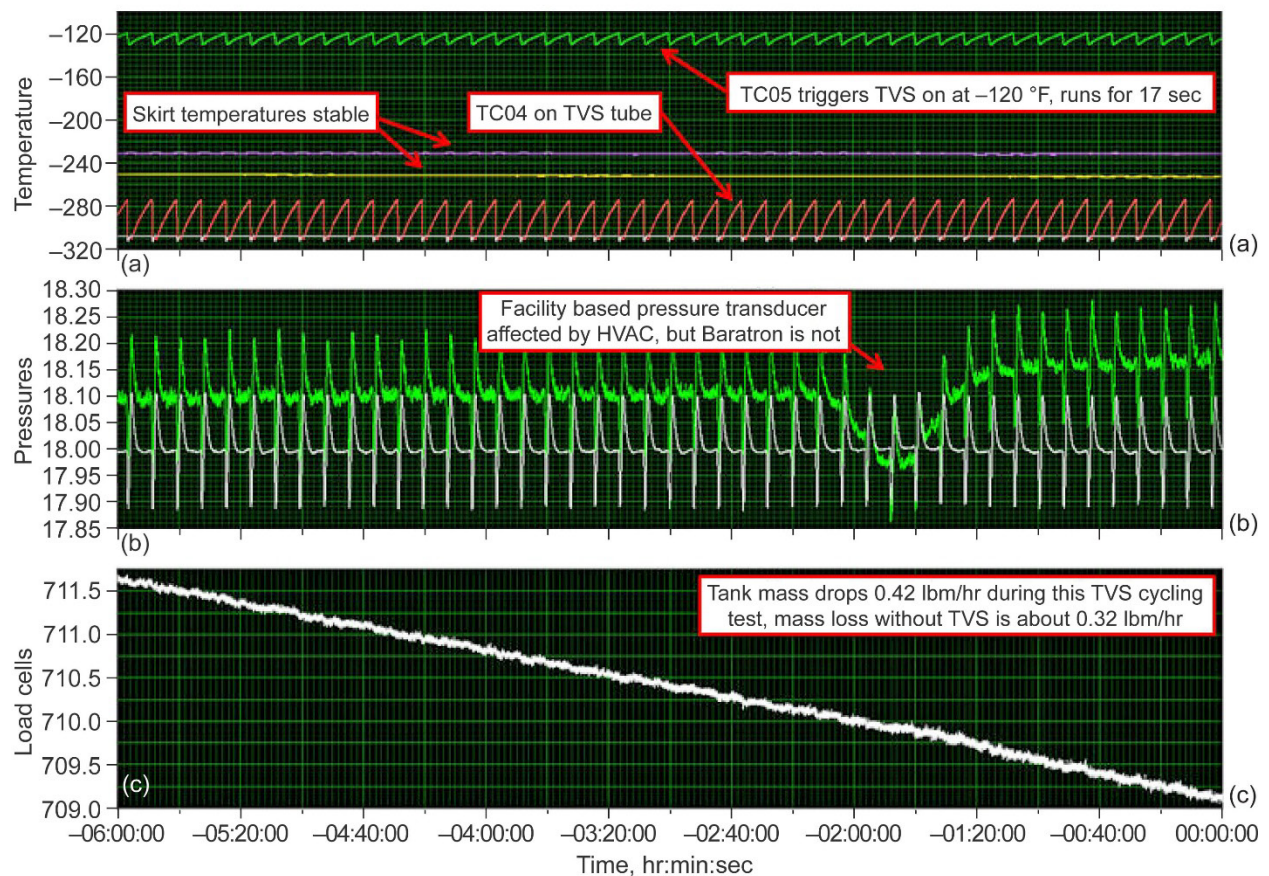

Figure 21.—TVS cycles controlled on TC05: (a) temperature, (b) pressure, and (c) mass.

TABLE 5.—COMPARISON OF TVS RUNS AND PASSIVE RUNS

Date	Control	On temp, °F	Off temp, °F	Run time, sec	Period, min	Fill, %	Loss rate, lb/hr
2/7/12	No TVS	-----	-----	----	-----	93	0.32
2/2/12	TC05	-250	N/A	17	7.8	91	0.42
2/3/12	TC05	-80	N/A	20	17.5	89	0.39
1/30/12	No TVS	-----	-----	----	-----	80	0.30
2/24/12	No TVS	-----	-----	----	-----	39	0.27
12/15/11	T4 temp	-260	-314	~54	13	33	0.33
12/16/11	T4 temp	-260	-305	~45	13	31	0.27
3/1/12	No TVS	-----	-----	----	-----	30	0.21
12/17/11	T4 temp	-260	-300	~40	8	27	0.23
12/18/11	T4 temp	-260	-290	~30	8	25	0.33
3/7/12	No TVS	-----	-----	----	-----	23	0.20

## 5.4 Fill Testing

Several different fill methods were tested out on the CRYOTE GTA. The fill testing was limited in test opportunities due to the long durations required to drain GTA of fluid. Testing included vented and NVFs. Two different NVFs were attempted both starting empty and starting with a partially full tank. All fill attempts were successful in filling the tank to fill levels greater than 90 percent full.

### 5.4.1 Vented Fills

The purpose of monitoring and analyzing the vented fills was to serve as a practice for the NVFs, to understand the facility transfer system along with important sensors on it, and to understand the mixing of the ullage due to the diffuser on the liquid inlet.

Figure 22 shows the facility systems during the fill. D-PT-D124 is the supply dewar pressure and TC-D123 is the dewar bulk liquid temperature. Station 100 is at the exit of the dewar and station 300 is at the entrance to the vacuum chamber (as close to the test article as the facility allows). ROV-F300 is the bypass valve that either allows the liquid into the test article or routes it directly to the vent line while the transfer line is chilling down (0 is into the ventline, 20 is into the test tank). Of note in Figure 22 is the final chilldown of the transfer line in the minute or so following the valve opening. This is most likely due to chilling down the roughly 20 ft of tubing that is between station 300 and the actual test article. Figure 23 shows that immediately fluid is flowing through the vent line. Once the test article starts to fill, the flow ramps up on its own and the line finishes chilling down. Also note that while the pressures decrease with time during the fill operation, the temperatures of the fluid inside the dewar and transfer line increase. The summation of mass across the various inlets and outlets of the tank showed that mass was conserved within 5 percent uncertainty.

Figure 24 shows the pressure of the GTA over time during the fill. The initial spike went up to 41.6 psig when the warm tank was hit with the first slug of cold liquid. However, the spray diffuser in the top of the tank did an excellent job of mixing the tank and collapsing the ullage along with the vent line. Figure 25 shows that the top of the tank (vent and fill line entrances to tank are on the top lid) was rapidly chilled down during the filling, also evidence of the effectiveness of the spray diffuser. It is interesting that the fill line is only slightly cooler than the vent line (compared to the temperature of the liquid flowing through it) until the flow stops at which point the temperature of the fill line entrance rapidly rises and equalizes with the vent line temperature.

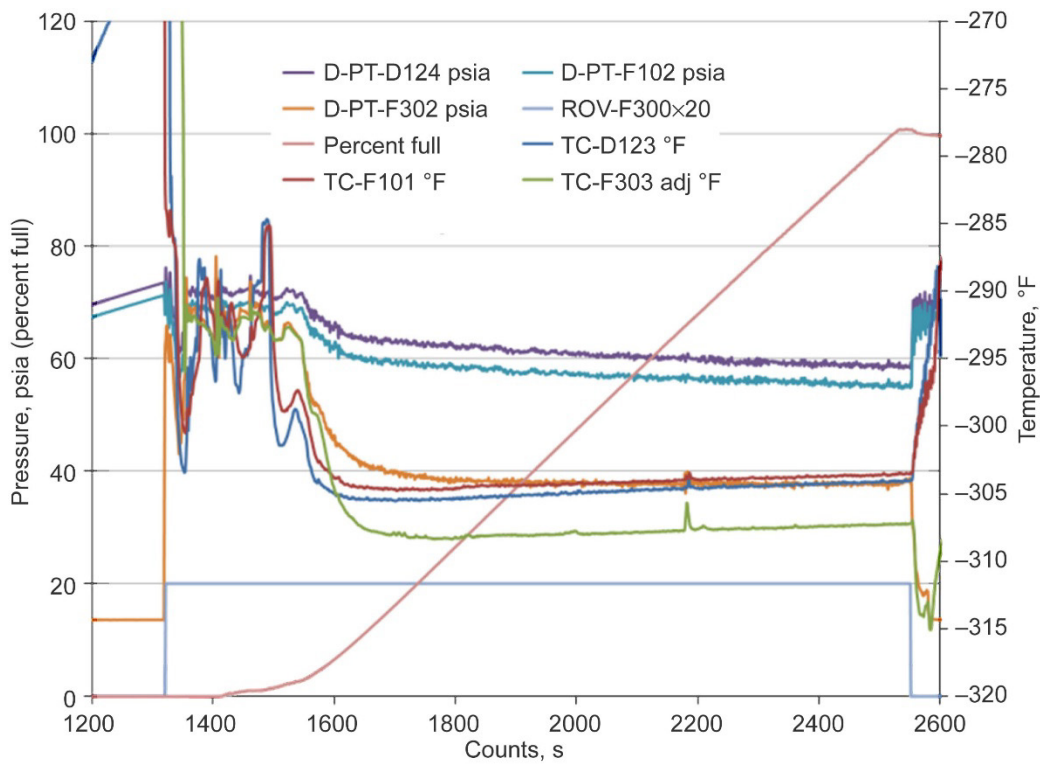

Figure 22.—Facility performance during vented fill.

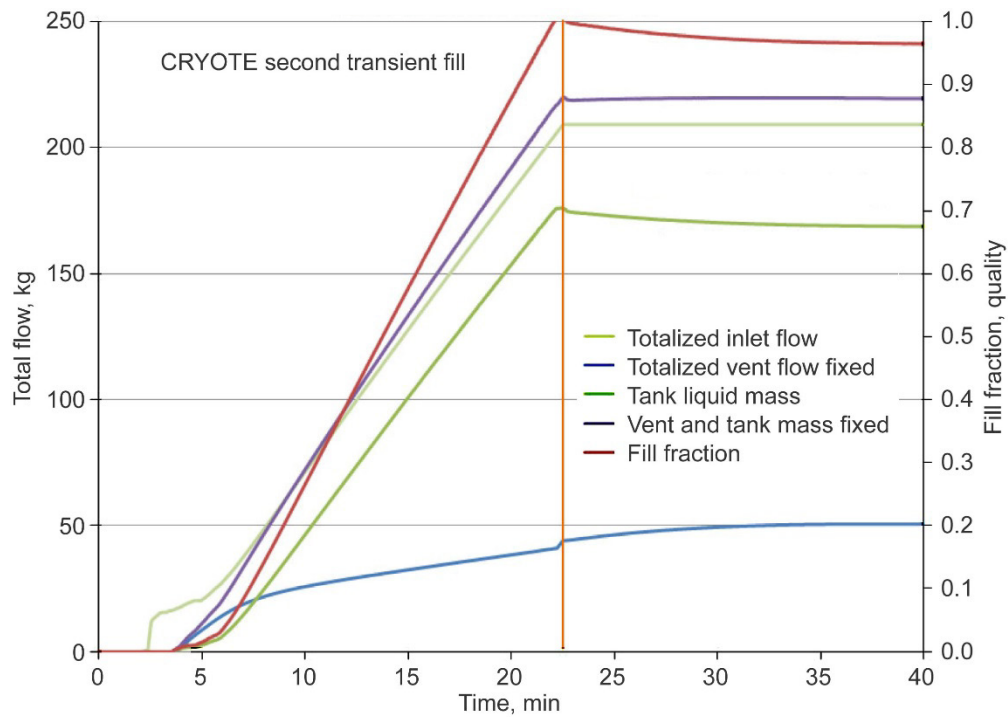

Figure 23.—Mass balance during vented fill.

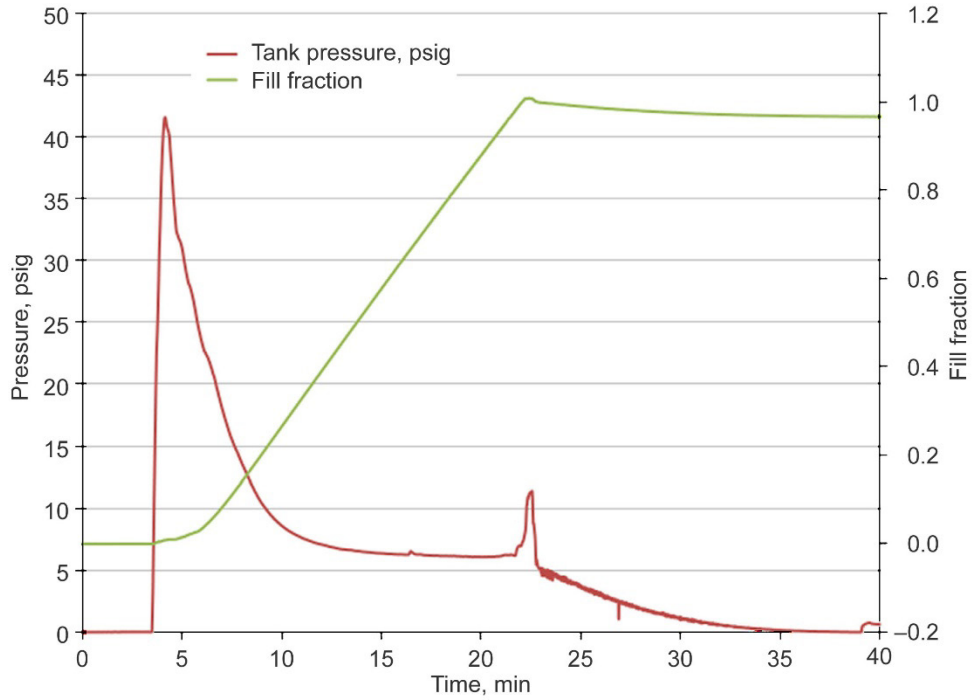

Figure 24.—Tank pressure during vented fill.

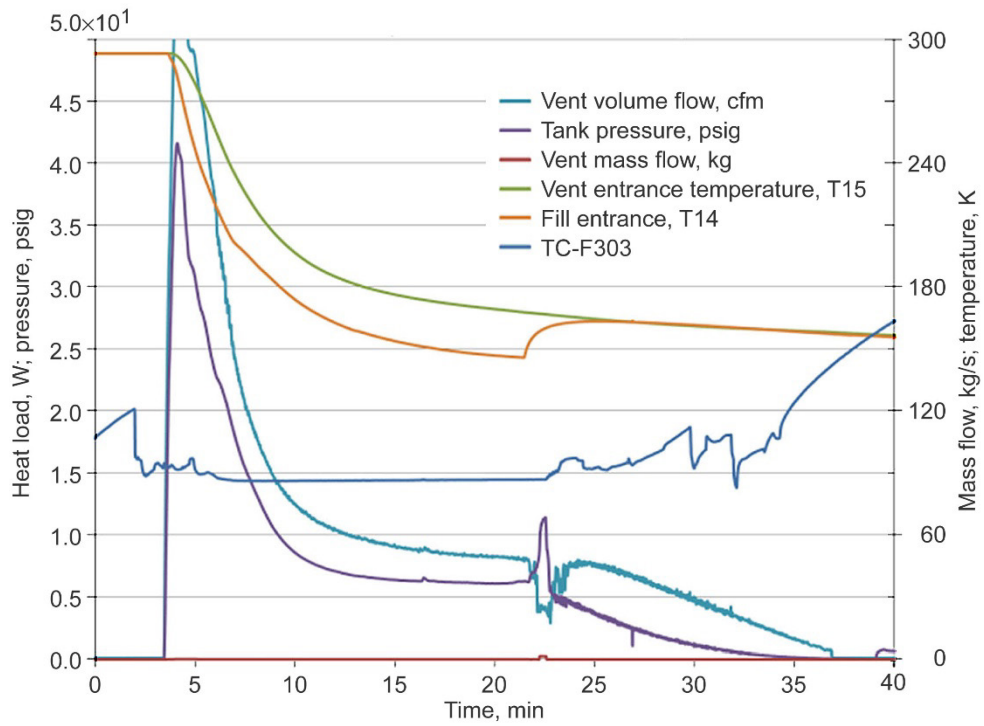

Figure 25.—Vented fill summary.

The final fill level of the tank was approximately 100 percent, however, when the inlet flow stopped, it rapidly decreased to approximately 97 percent full. The liquid efficiency of the fill (amount of liquid that was in the tank compared to the amount that flowed into it) was 72.5 percent when the fill valve closed and decreased to 68.1 percent by 40 min after flow initiation (just under 20 min after flow termination).

## 5.5 No Vent Fill

Prior to performing the NVF, the vented fills were thoroughly studied to help understand the operation of the test facility. Discussions were held on the approach for the NVF and three different operational procedures were identified: the academic NVF, the practical NVF, and the “Hail Mary” NVF. While there may be many more approaches to a NVF, these were the ones that were discussed for the CRYOTE GTA testing. The pre-test agreed upon trigger for transitioning from tank chilldown to tank fill was 116.5 K (–250 °F).

The academic NVF is as the no vent fill is commonly discussed in the literature. It includes a bypass of the transfer line as close to the tank interface as is readily possible to control the cryogen supply. The transfer line is chilled down by the use of the bypass line. The actual fill is preceded by repeated “Charge-Hold-Vents” (CHV) where a slug of liquid is passed into the tank, allowed to vaporize and warm up, and then vented to a vacuum. During the “hold” portion, the bypass is reopened to prevent the buildup of energy in the liquid and maintain its subcooled state. Once the tank reaches a target temperature, the liquid is pushed into the tank as quickly as possible until a maximum pressure is reached and the flow is stopped. This is deemed the academic method as it is the truest form of an isolated NVF, however, it may not be possible or practical to use a bypass line on an operational in-space system.

The practical NVF does not have a bypass of the transfer line, instead during the transfer line chilldown, the vapor flows through the tank and out the vent line. When the first slug of liquid hits the tank, the CHV cycle begins, except, again, there is no bypass line, so during the hold and vent portions of the operation, the liquid is warming up in the transfer line. This is deemed the practical approach because it is deemed to be closer to what may actually fly on early systems.

The “Hail Mary” NVF does not use either a bypass line or CHV cycles. It is the simplest operationally, but is expected to perform the worst of the three methods as far as final fill level. The transfer line is vented through the tank during chilldown. As the liquid front approaches the tank, the vent valve is closed and the liquid is allowed to accumulate in the warm tank. The receiver tank will continue to fill until it reaches an equilibrium pressure with the supply tank, at that point flow will be terminated unless the supply tank could be repressurized. This method is an attempt to get around the build-up of energy into the liquid during the CHV cycles without using a bypass line.

The actual NVF that was attempted was somewhere between the practical NVF and the “Hail Mary” NVF. The NVF attempt took place in three pulses, a summary plot is presented in Figure 26. Initially the test article was evacuated to near vacuum. The transfer line was chilled down to ROV-300, at the entrance to the vacuum chamber. The vent valve was closed and the first pulse flowed vapor into the tank until the pressure equalized with the supply tank at 97 psia. The GTA was then evacuated to 2 psia and the vent was closed again. During the evacuation, the temperature of the tank continued to decrease and was approximately 158 K (–175 °F) when the second pulse was initiated. The second pulse transitioned to a liquid flow into the tank and ran until the supply tank was emptied, the tank was approximately 40 percent full. At this point the vent remained closed and a transition was made to use a secondary

supply dewar at the test facility by pressurizing the dewar and chilling down the second transfer line. During the nitrogen source change, the tank had not drastically risen in pressure, so the fill was continued without venting the tank. At the end of the third pulse, the tank was nearly 100 percent full, based on the mass of the system, the tank was 97 percent full when the transfer was terminated. It should be noted here that the vent valve was not close coupled to the tank, so several feet of vent line served as an extended ullage, effectively increasing the volume of the tank.

Of principle interest from this test is that it appears to have filled the tank to near 100 percent full. Figure 27 shows the tank pressure and fluid mass at the termination of the NVF. Additional attention is paid to the pressure curve of the tank. Previous testing has shown an initial fast rise in pressure followed by a knee and gradual increase during the fill portion (Refs. 11, 13, and 14). However, during this testing, the pressure actually began to decrease during the fill portion. This phenomenon appears to be due to the mixing of the ullage provided by the diffuser at the tank inlet. By aiming the diffuser at the lid and ullage, it was possible to fully mix the ullage during the fill.

Additionally, a NVTO was performed. The NVTO started with the tank at 77 percent full and was terminated when the tank was 97 percent full. This test appears very similar to the third pulse of the NVF. The pressure and fill level versus time for the NVTO is shown in Figure 28. After an initial pressure spike, the ullage pressure is readily collapsed during the fill of the tank. The similarity between the tests should be encouraging for the transfer of cryogenics on orbit between multiple tanks as it will allow for the topping off of a tank, or filling of a tank from more than one supply tank.

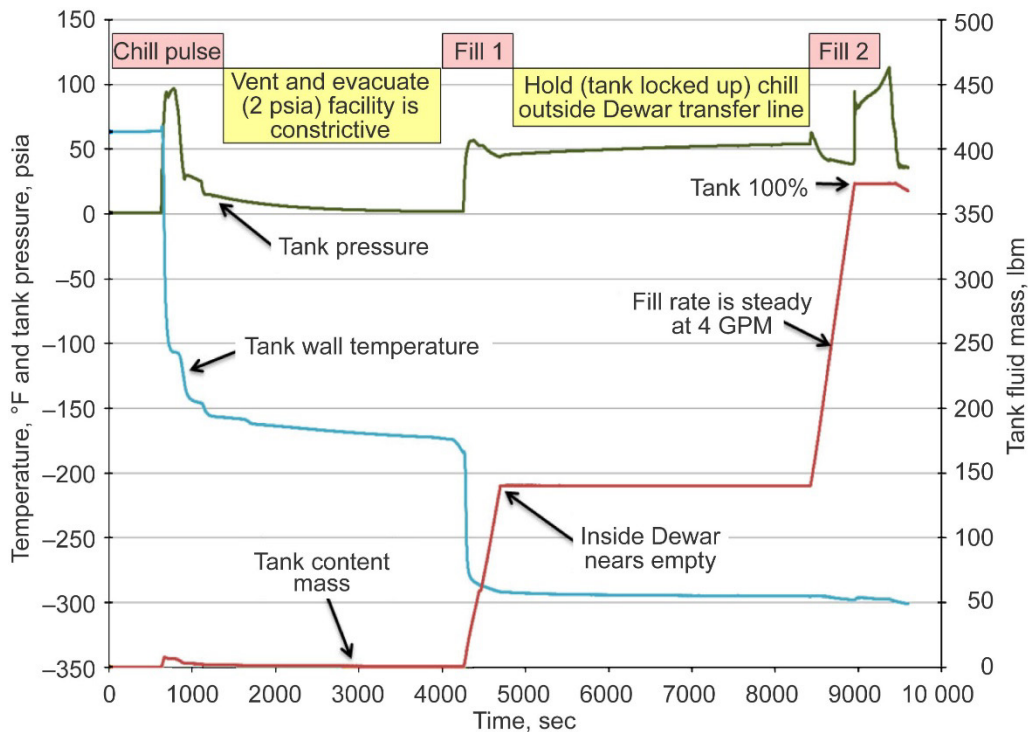

Figure 26.—NVF summary.

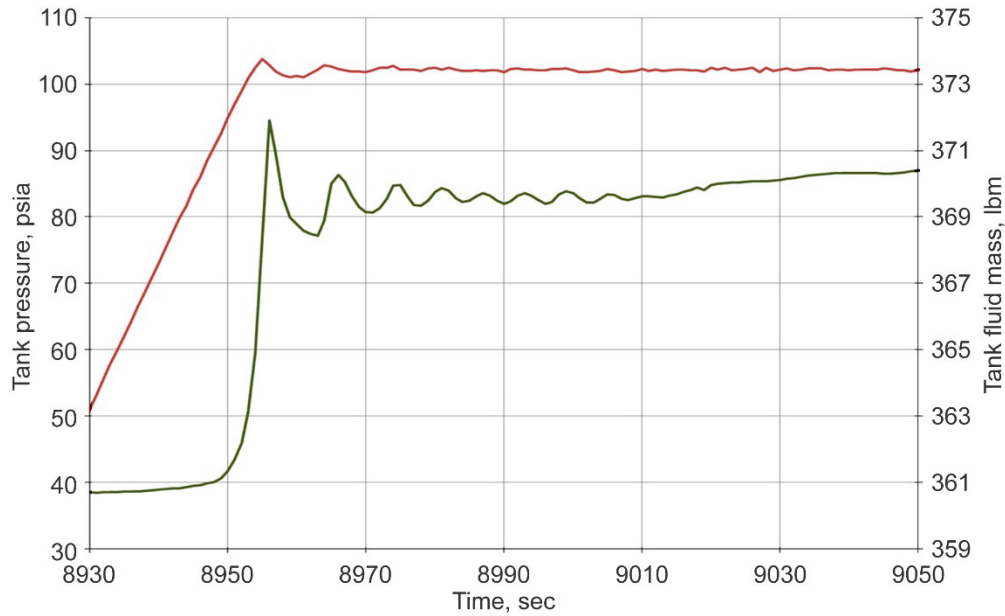

Figure 27.—Last 2 minutes of NVF.

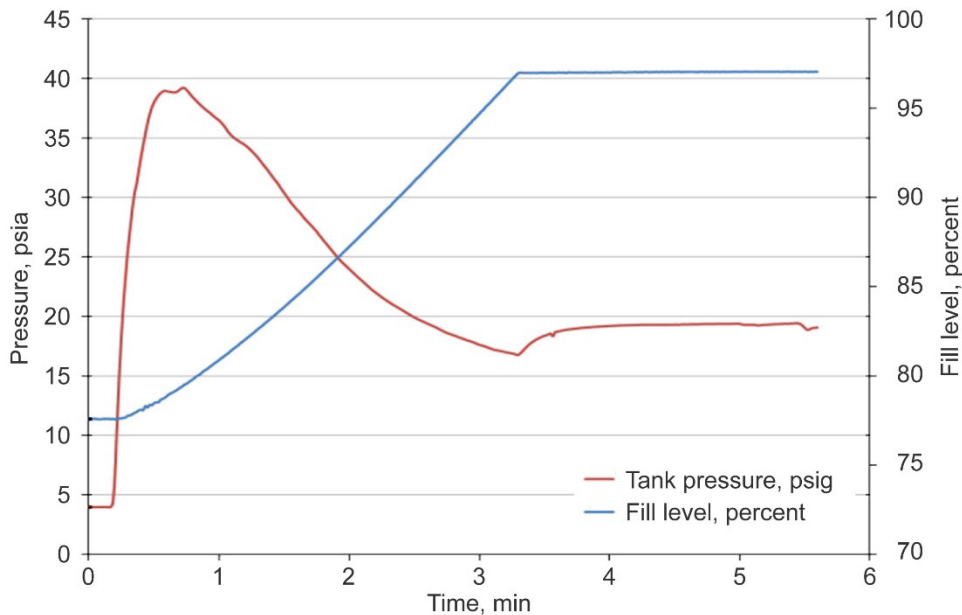

Figure 28.—NVTO pressure history.

## 6.0 Conclusion

Over 3 months of testing was completed on the Cryogenic Orbital Testbed (CRYOTE) ground test article (GTA). All test objectives were met. The test article was fully scoped out for thermal performance. While the TVS did not perform as designed, the flaws in the system are understood. The lessons learned from the testing are listed in Table 6. Vented and No-Vent-Fills (NVFs) were performed and characterized, however, time did not allow for the optimization of the NVF procedure. Additionally, a No-Vent-Top-Off (NVTO) was performed to assess the capability of filling a tank that was not empty

without venting it. The data is presented in this report to allow for verification and validation of various thermal models based on the data obtained during testing.

The thermal performance of the system was as a function of fill level. This was due to the use of titanium tank, where the tank lid temperature was a strong function of fill level. This trend generally followed the shape of the wetted surface area. At low fill levels, the tank warmed up enough at the top to reduce the heat load through the acreage multilayer insulation (MLI) fairly significantly and also to warm up the structural interface of the tank. The heat load ranged from 5.0 to 8.3 W.

TABLE 6.—LESSONS LEARNED DURING TESTING

1	For new test articles, a check out time is very important to learn how the system functions.
2	If no drain line is installed for even the smallest of tanks, it can take a very long time to change the fill level of the tank.
3	Sizing a TVS (two phase flow) orifice is very tricky, the CRYOTE orifice allowed far too much flow.
4	The TVS heat exchanger within the tank needs to be more than a single run of tubing

The TVS was demonstrated to work, dropping the temperature of the tank liquid approximately half of a degree Fahrenheit over a 30 min time period. The use of system temperatures to control the TVS ended up rejecting between 10 to 50 percent more liquid than boil-off. Additionally, attempts to use the same mass flow rate as the boil-off testing could not control the ullage pressure. This is thought to be due to a combination of not enough heat exchanger area within the ullage volume and liquid spilling out in the vent line (not fully changing phase in the tank).

The NVF demonstrated that the CRYOTE GTA could be filled to greater than 97 percent full while maintaining a pressure under 50 psia. Similarly, the NVTO demonstrated that topping off a partially full tank has a lower pressure spike than the NVF. Both demonstrated the benefit of directional cooling on the warmest part of the tank for maintaining pressure control.

## References

1. Goddard, E.C., and Pendray, G.E., eds. *The Papers of Robert H. Goddard*, 3 vols. New York: McGraw-Hill Book Co. 1970
2. Dawson, V.P., and Bowles, M.D., *Taming Liquid Hydrogen: The Centaur Upper Stage Rocket 1958 – 2002*, NASA/SP—2004-4230, 2004.
3. Fredrickson, G.O., Schweikle, J.D., “Thermo and Hydrodynamic Experiment Research Module in Orbit,” NASA CR-85271, 1967.
4. Glover, D. “NASA Cryogenic Fluid Management Space Experiment Efforts, 1960 – 1990,” NASA TM-103752, 1991.
5. Meyer, M.L., Chato, D.J, et al., “Mastering Cryogenic Propellants,” *J. Aerosp. Eng.* Vol. 26, No. 2, April 1, 2013, pg. 343-351.
6. Wollen, M.A, Gravlee, M., and Johnson, W.L. “CRYOTE (Cryogenic Orbital Testbed) Goals, Progress, and Potential,” Presented at the 57<sup>th</sup> JANNAF Propulsion Meeting, May 2010.
7. Sakla, S., Kutter, B., and Wall, J. “Centaur Test Bed (CTB) for Cryogenic Fluid Management,” NASA/CR—2006-214410, AIAA-2006-4603, 2006.
8. Chato, D.J. “Experimentation for the Maturation of Deep Space Cryogenic Refueling Technologies,” NASA/TP—2008-214929, 2008.
9. Gravlee, M., et al. “CRYOTE (Cryogenic Orbital Testbed) Concept,” AIAA-2009-6440. Sep. 2009.



10. VanDresar, N.T., Liquid Oxygen Thermodynamic Vent System Testing with Helium Pressurization, NASA/TP—2014-216633, 2014.
11. Taylor, W.J. and Chato, D.J., “Comparing the Results of an Analytical Model of the No-Vent Fill Process with No-Vent Fill Test Results for a 4.96 m<sup>3</sup> (175 ft<sup>3</sup>) Tank,” Presented at the AIAA 18<sup>th</sup> Joint Propulsion Conference and Exhibit, Jul. 1992, AIAA-92-3078.
12. Yovanovich, M.M., “A General Expression for Predicting Conduction Shape Factors,” Presented at the AIAA 11<sup>th</sup> Aerospace Sciences Meeting, Jan. 1973, AIAA-73-0121.
13. Wang, C., Li, Y., et al. “Performance Model of the Top Filling Configurations for No-Vent Fills,” Journal of Thermophysics and Heat Transfer, Vol. 25, No. 1 (2011), pp. 140-146.
14. Moran, M. E., Nyland, T. W., and Driscoll, S. L., “Hydrogen No-Vent Fill Testing in a 1.2 Cubic Foot (34 Liter) Tank,” NASATM-105273, 1991.





