

Integrated Design Capability / Instrument Design Laboratory

# Geostationary Coastal and Air Pollution Events (GeoCAPE) Wide Angle Spectrometer (WAS) ~ *Concept Presentation* ~

## Systems

Carl Kotecki & Martha Chu

July 29, 2014

*Tc VrbhUWighi Xm`YUX.*

*Antonio Mannino/616 ([Antonio.Mannino-1@nasa.gov](mailto:Antonio.Mannino-1@nasa.gov))*



NASA GODDARD SPACE FLIGHT CENTER



# Introduction

---

## Integrated Design Capability / Instrument Design Laboratory

- The GeoCAPE Wide Angle Spectrometer (WAS) Study was a revisit of the COEDI Study from 2012
- The customer primary goals were to keep mass, volume and cost to a minimum while meeting the science objectives and maximizing flight opportunities by fitting on the largest number of GEO accommodations possible.
  - Riding on a commercial GEO satellite minimizes total mission costs.
- For this study, it is desired to increase the coverage rate,  $\text{km}^2/\text{min}$ , while maintaining ground sample size, 375m, and spectral resolution, 0.4-0.5nm native resolution. To be able to do this, the IFOV was significantly increased, hence the “wide angle” moniker.
  - The field of view for COEDI was  $\pm 0.6$  degrees or (2048) 375m ground pixels.
  - The WAS “Threshold” (the IDL study baseline design) is  $\pm 2.4$  degrees or (8192) 375m ground pixels.

# S/C and LV Information

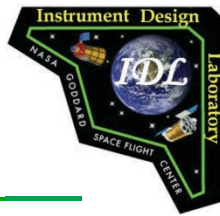

## Integrated Design Capability / Instrument Design Laboratory

- The instrument is to be hosted as a secondary payload on a commercial satellite, thus specific S/C and LV information is not available.
  - The spreadsheet on later slides contains the specifics on engineering allocations for various platforms (mass, power, volume, telemetry)
- The scarcest engineering resources addressed:
  - Mass and volume
- Pointing Line-of-Site (LOS) Error (as % of nadir pixel) Requirements
  - Pointing Knowledge LOS: <50% Threshold & ~~≤10% Baseline~~
  - Pointing Accuracy LOS: <100% Threshold & ~~≤25% Baseline~~
  - Pointing Stability LOS: <50% Threshold & ~~≤10% Baseline~~
- A vibration suppression system (at S/C to instrument interface) is needed for on station jitter control
- Roll knowledge or active compensation is needed: Roll during operation is expected to be up to  $\pm 0.1$ deg



# WAS Block Diagram

Integrated Design Capability / Instrument Design Laboratory

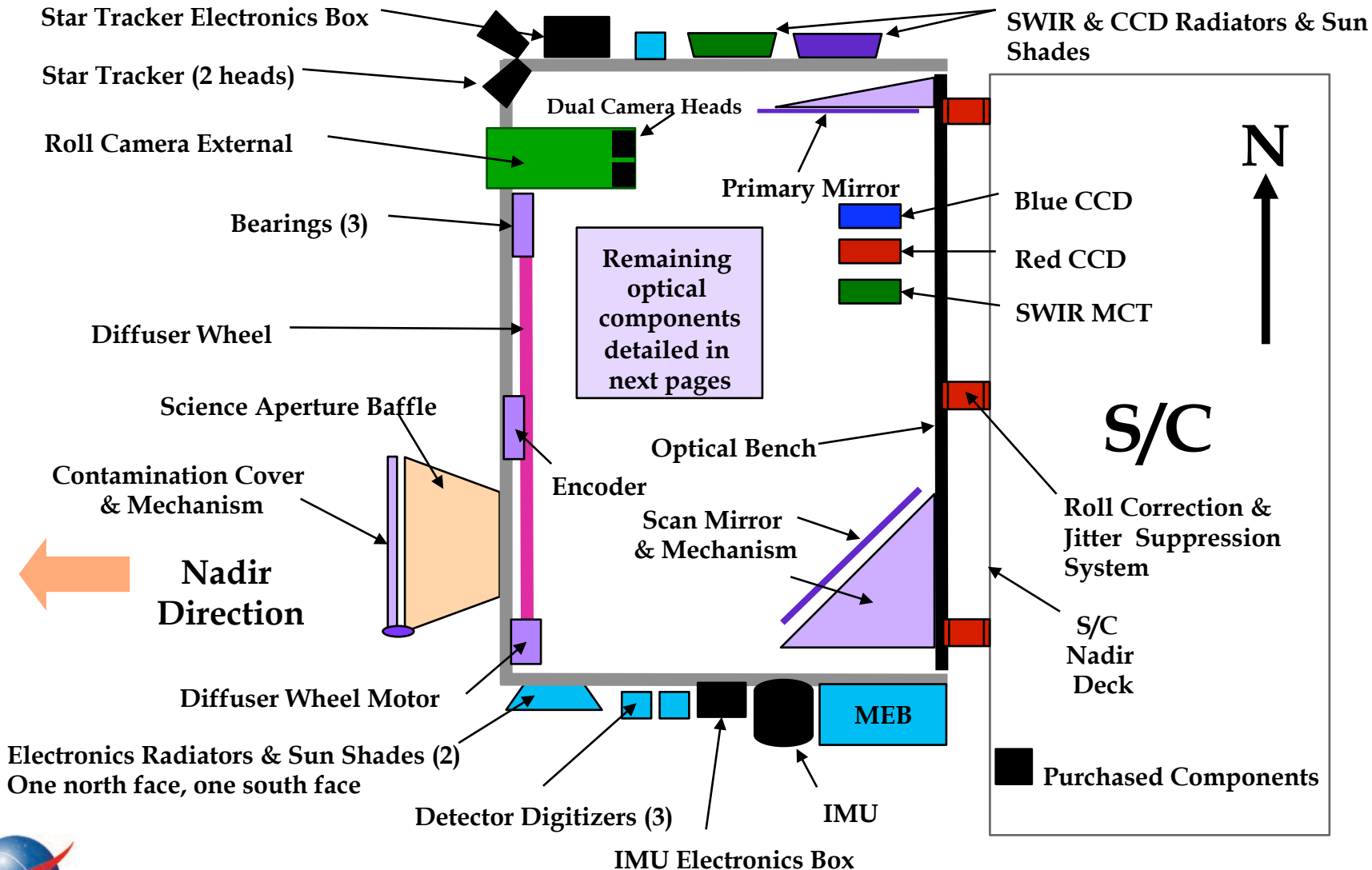

# Three Mirror Telescope Block Diagram

Integrated Design Capability / Instrument Design Laboratory

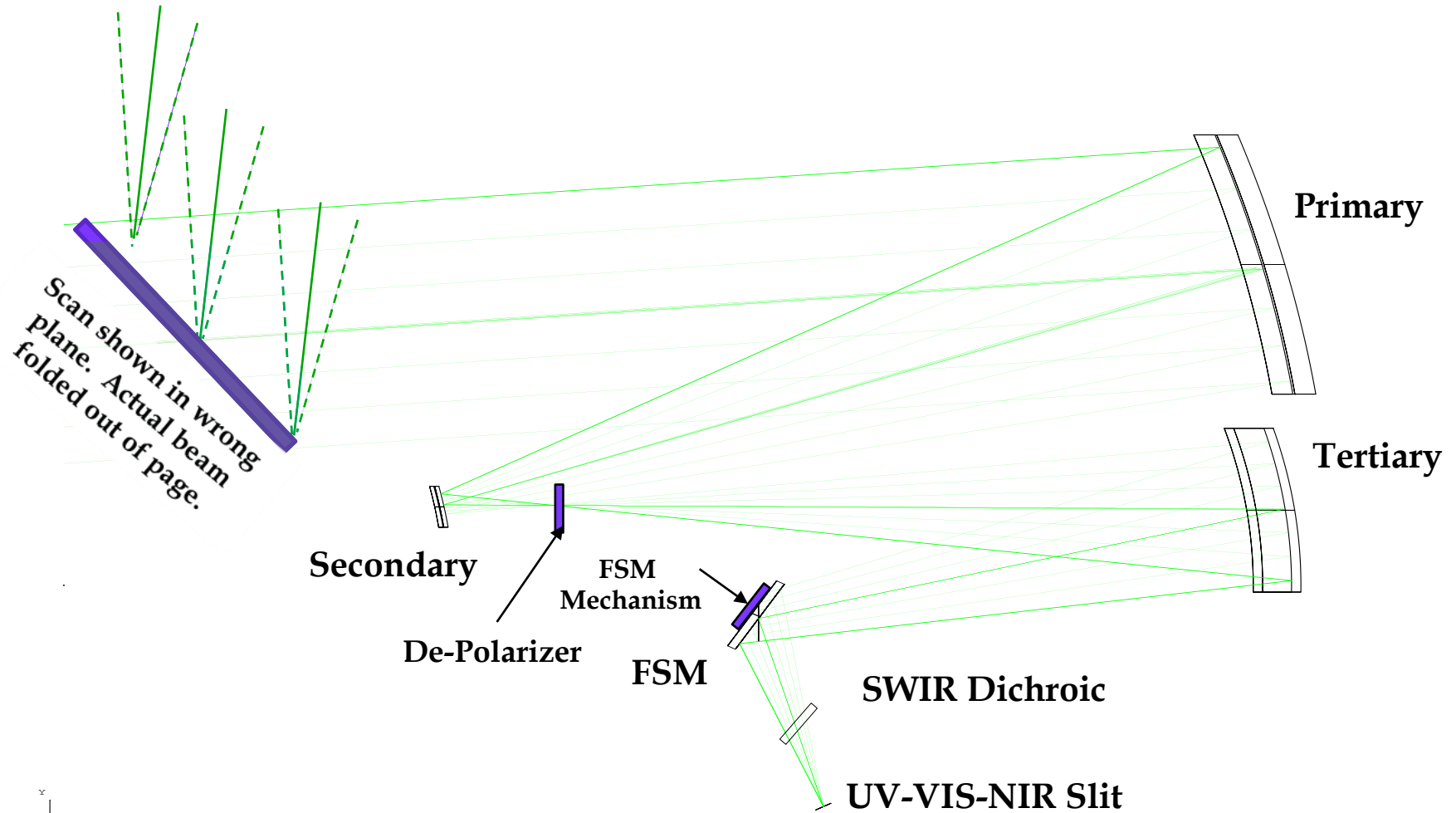

# UV/Vis Channel Block Diagram 340 nm - 600 nm



Integrated Design Capability / Instrument Design Laboratory

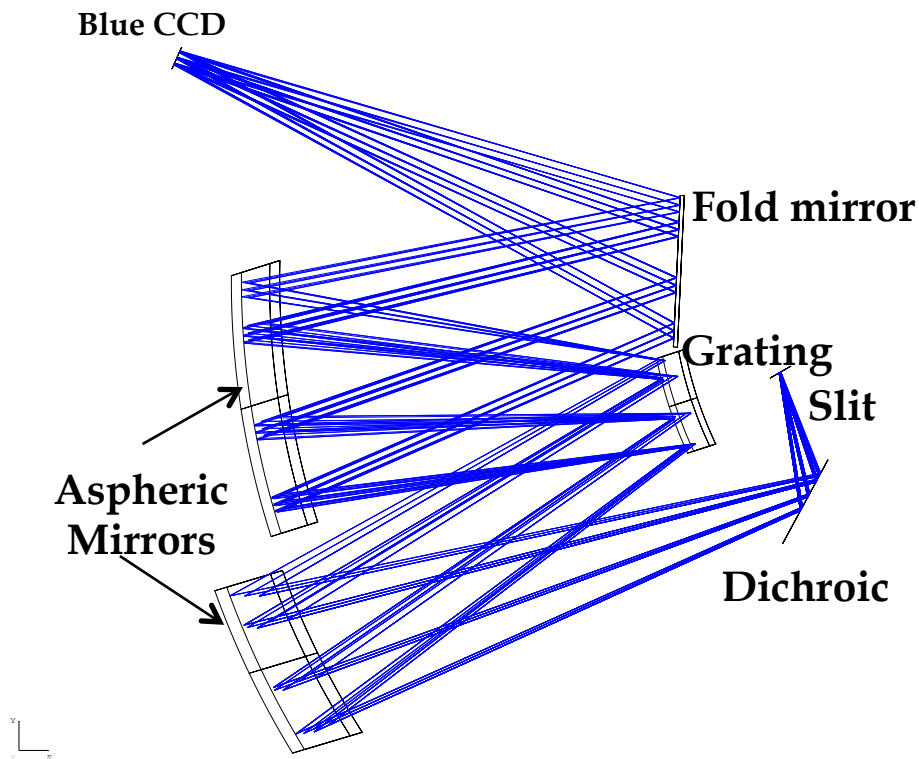

# Vis/NIR Channel Block Diagram 600nm - 1100nm

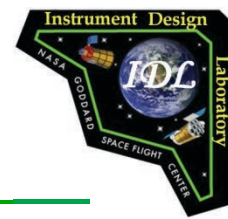

Integrated Design Capability / Instrument Design Laboratory

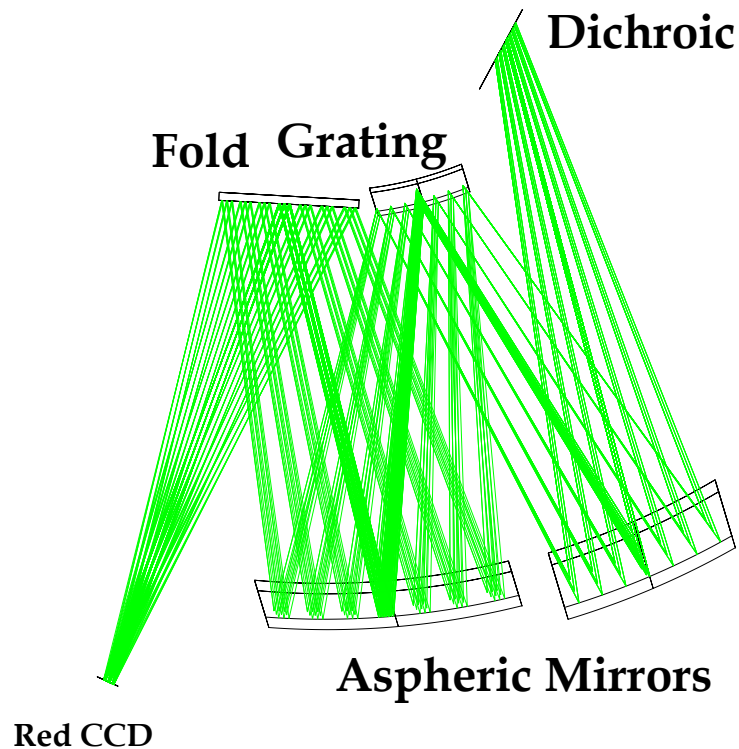



# SWIR Channel Block Diagram 1200nm - 2200nm

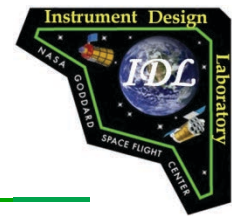

Integrated Design Capability / Instrument Design Laboratory

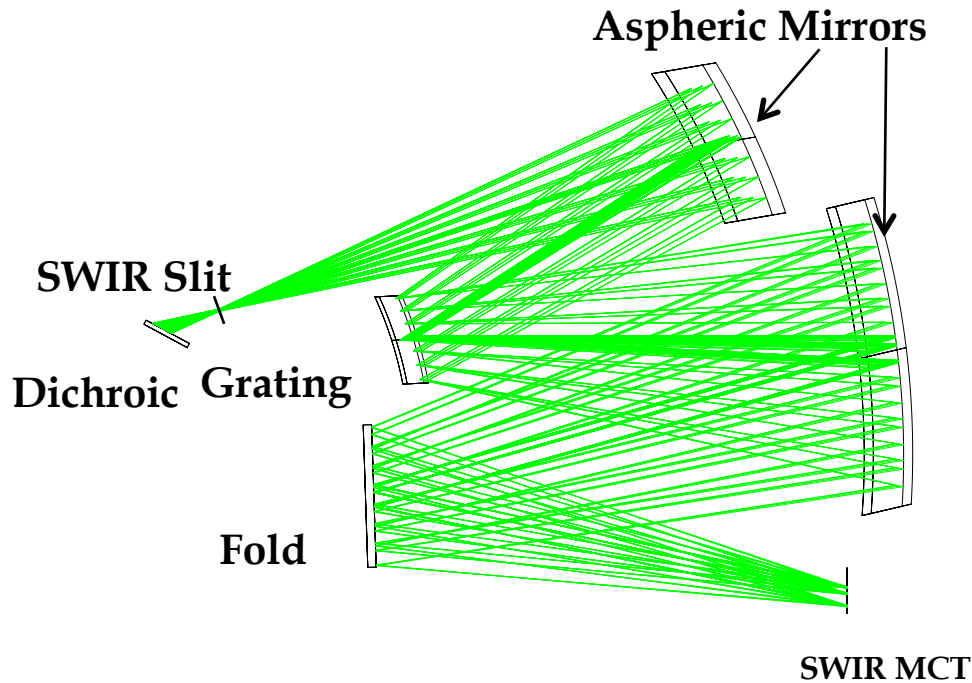

# Combined UV-Vis-NIR Channel Block Diagram 340nm - 1100nm

Integrated Design Capability / Instrument Design Laboratory

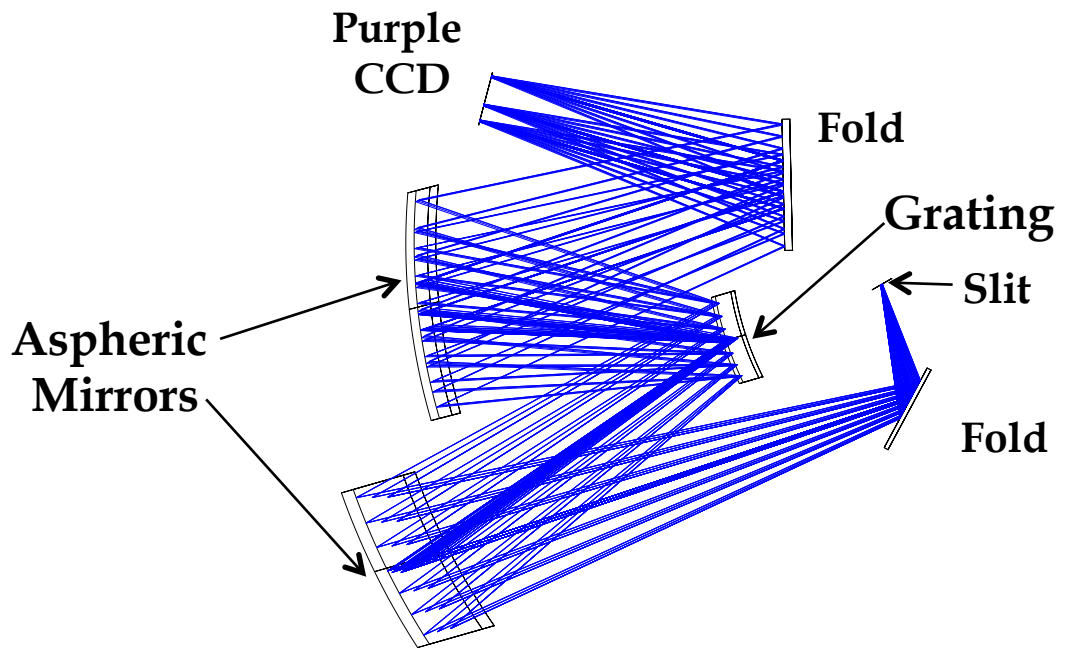

# WAS Mechanical Design

Integrated Design Capability / Instrument Design Laboratory

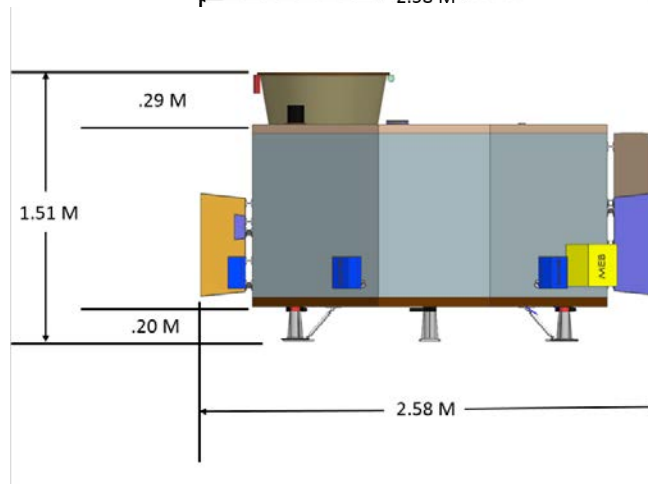
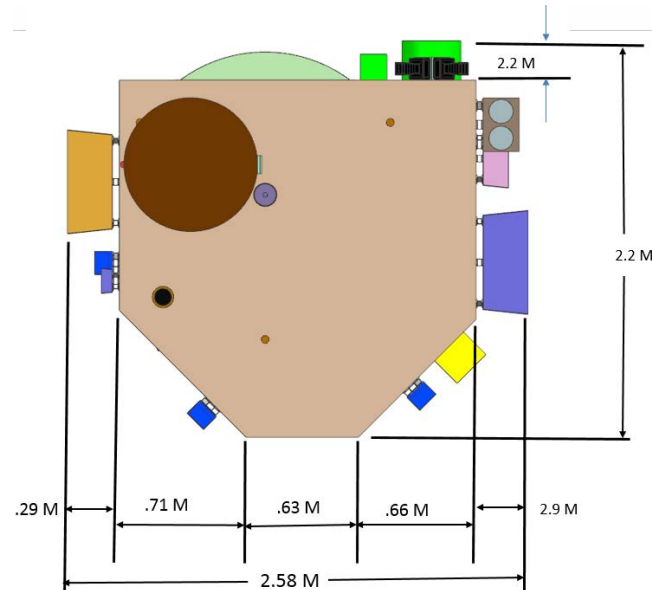
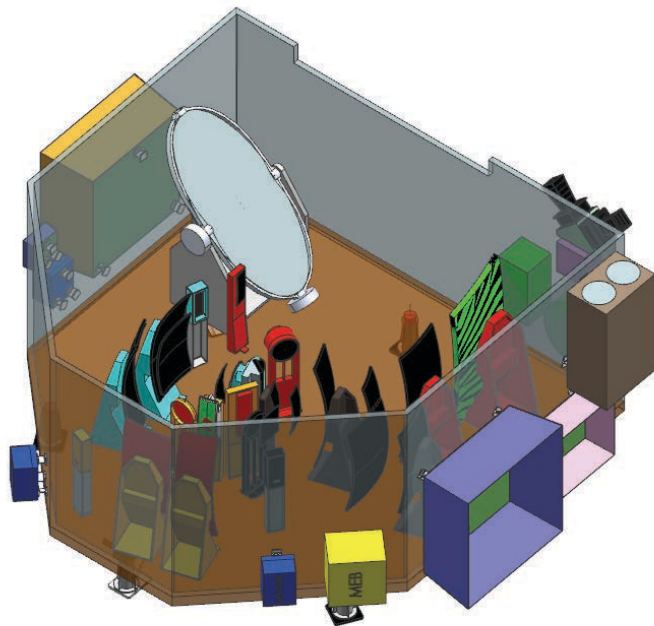

# WAS vs COEDI Total Instrument Rack-up (no contingency included)



Integrated Design Capability / Instrument Design Laboratory

	Total Mass [kg]	Total Operating Power [W] (Effective Average)	Data Rate [Mbps]	Volume [mm <sup>3</sup> ]
Wide Angle Spectrometer (WAS)	350 .3	341.3	1.37Tbits/16hrs (24hrs)	2200x2580 x1510
Coastal Ocean Ecosystem Dynamics Imager (COEDI)	215.5	192 W daily avg (220 W 17.5 hrs, 116W 5.5 hrs)	3.2 Tbits per 24hrs	1470x1663 x1107



# Coastal Ocean Biology & Biogeochemistry Mission

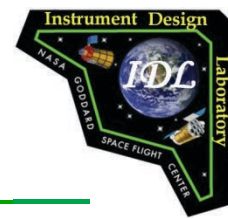

Integrated Design Capability / Instrument Design Laboratory

## New Science

- Diurnal Rates of processes
- Ecosystem Health
- Carbon Fluxes
- UV radiances
  - Colored Dissolved Organic Matter - CDOM
  - Absorbing Aerosols
- Track Hazards
  - Oil Spills
  - Harmful Algal Blooms
- Advanced atmospheric correction capabilities

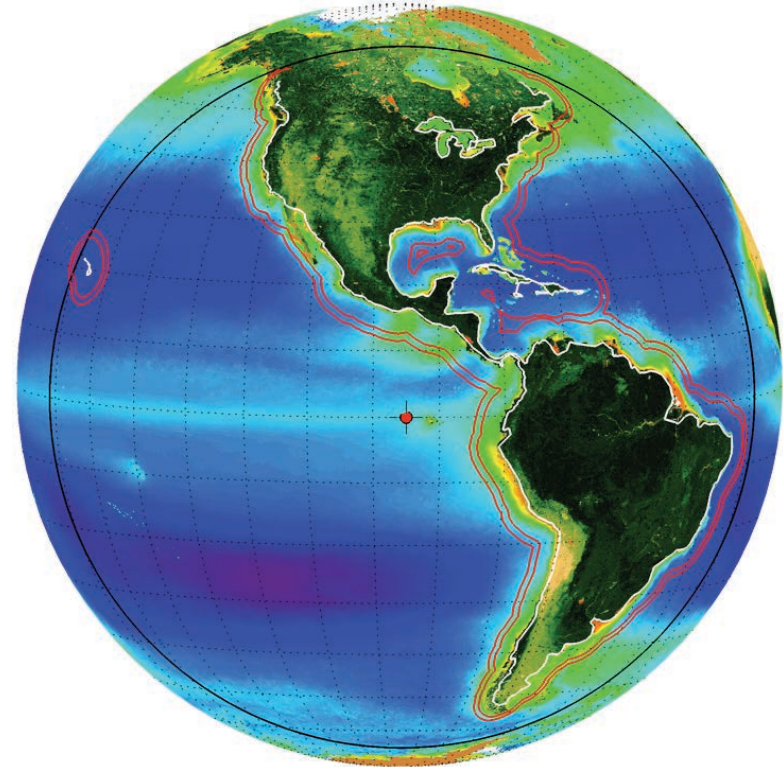

**View from 95 W**

*The black outer circle encompassing much of North and South America represents the 67° sensor viewing angle, which is the approximate limit to ocean color retrievals from 95° W. The two red lines extending beyond the continental land masses represent the 375 km and 500 km (width from inland of shore [white line] to the ocean) threshold and baseline coastal region requirements. Both lines generally extend beyond the 2500 m bathymetry of the continental margin*



# Science Measurements



Integrated Design Capability / Instrument Design Laboratory

- **Top-of-the-Atmosphere radiances leading to the following retrievals:**
  - **Water-leaving radiances (Lw) from UV-NIR (350-1050 nm); a.k.a. “ocean color”**
    - Hyperspectral Lw used to retrieve surface layer aquatic optical properties (absorption and scattering), constituents (chlorophyll, Colored Dissolved Organic Matter, phytoplankton biomass, dissolved and particulate organic carbon, phytoplankton diversity, etc.) and rate processes (photosynthesis, photo-oxidation, etc.) in coastal and ocean waters.
  - **Atmospheric corrections for ocean color**
    - SWIR band radiances for atmospheric corrections over turbid waters (ocean is black or nearly black so one can quantify aerosol contributions exclusively) - minimum of 2 bands (1020, 1245, 1640, 2135 nm)
    - Atmospheric column nitrogen dioxide (NO<sub>2</sub>) retrievals using the Differential Optical Absorption Spectroscopy (DOAS) technique requires 0.8 nm spectral resolution at 0.4nm intervals from 400-450nm.
    - Detection and quantification of absorbing and non-absorbing aerosols (350-1050 nm and SWIR bands).



# IDL Study Objectives



## Integrated Design Capability / Instrument Design Laboratory

- Create a detailed instrument point design that meets the science objectives.
- Obtain high fidelity cost estimates for various GEO-CAPE ocean color sensor capability trades to inform HQ and GEO-CAPE team.
  - *We generated credible bounds on instrument costs to demonstrate to HQ whether or not the mission is viable financially as well as technologically.*
  - Trades address spatial resolution, spectral resolution, multi versus hyperspectral, SWIR band capabilities
  - A few optical design concepts will be examined to better constrain the costs for different instrument types (multi-spectral filter radiometer, hyper-spectral multi-slit and wide-angle spectrometers, etc.).
- **This Study: July 21-29 IDL Study focuses on the wide-angle spectrometer design.**
- Aug. 6-12 IDL study will develop the multi-spectral filter radiometer.



# Study Parameters

Integrated Design Capability / Instrument Design Laboratory

- **Class C Mission (selective redundancy - thermal only)**
- **3 year design life (5-yr goal)**
- **Geostationary orbit at 95W**
  - 35,786km orbit; 0-degree inclination
- **Launch: December 2024**
- **Hosted payload on commercial satellite; nadir view deck location**
- **Class B Electronics components**
- **Assume host pointing performance**
- **Labor costs – assume out-of-house build**
- **Select lower cost options where possible while maintaining performance.**



# Sensor Trade Space for GEO-CAPE IDL Studies



Integrated Design Capability / Instrument Design Laboratory

GEO-CAPE Ocean Sensor Requirement	Filter Radiometer*	Wide-Angle Spectrometer	Roll Instrument
Spatial GSD at Nadir	O = 300 m <sup>3</sup> B = 250 m	D = 500 m <sup>3</sup> T = 375 m (primary IDL) B = 250 m (TBD)	TBD
Spectral range <sup>1</sup> T = 340-1050 nm	Multi-spectral <sup>2</sup> 16 or more bands	Hyperspectral	1 band
SWIR Bands D = 1640 nm T = 1245, 1640 nm B = 1245, 1640, 2135nm	D = 1640 nm	1 (D), 2 (T) or 3 (B) bands <sup>4</sup>	none
UV/Vis/NIR Spectral Sampling/Resolution	D = 10 nm	T = 2.5/5 nm <sup>3</sup> ; B = 0.4/0.8 nm; O = 2/5 nm, but 0.4/0.8 nm for 400-450nm <sup>3</sup>	wide

T = Threshold requirements from STM (but not including the NO<sub>2</sub> requirements)

B = Baseline Requirements from STM (includes the NO<sub>2</sub> requirements)

O = Between Threshold and Baseline      D = Descope

<sup>1</sup> SNR >1000 for UV-Vis (at 10nm FWHM) - see table

<sup>2</sup> Multispectral: ~MERIS bands plus 360, 385 & 1020 nm. SWIR additional.

<sup>3</sup> Compute cost by scaling sensor and results from IDL study.

<sup>4</sup> Track costs for additional SWIR bands within MEL without impacting instrument design.

**GREEN: This Study**



# Configuration Modifications for Delta Designs

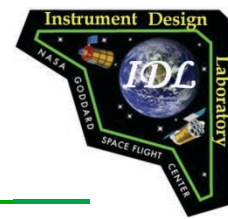

Integrated Design Capability / Instrument Design Laboratory

- **Nadir GSD**
  - IDL Baseline: 375m
  - Deltas:
    - 250 to 300m (by scaling optical design - “pre-costing” approach)
    - 500m (by scaling optical design - “pre-costing” approach)
- **Spectral Resolution UV-VIS and VIS-IR**
  - IDL Study Baseline: Two separate blue and red spectrometers
    - UV-VIS: 0.4nm sampling / 0.8nm Bands
    - VIS-NIR: 0.5nm sampling / 1.0nm Bands
  - Case 1: Same as the Baseline
  - Case 2: Combine two spectrometers onto a single CCD and
    - UV-VIS-NIR: 0.4nm sampling / 0.8nm Bands
  - Case 3: Same as Case 2
- **SWIR Bands**
  - IDL Baseline and Case 2: Three SWIR bands (1245, 1640 and 2135 nm)
    - More bands are possible since the SWIR channel is a spectrometer
  - Case 1 and Case 3 Descopes: Remove entire SWIR channel
    - By using a dispersive element with a 2D array, we either have all 3 bands or 0 bands



# Configuration Modifications for Delta Designs

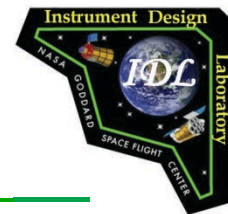

Integrated Design Capability / Instrument Design Laboratory

	Baseline	Case 1	Case 2	Case 3
UV/VIS - Blue Channel	X	X		
VIS/NIR - Red Channel	X	X		
UV/VIS/NIR - Purple Channel			X	X
SWIR Channel	X		X	



# Other Major Components

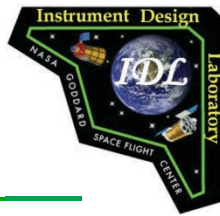

---

## Integrated Design Capability / Instrument Design Laboratory

- **2D camera for roll detection**
  - Two applications
    - Data to actuator (at S/C to instrument interface), which moves the entire instrument to correct for roll
    - Provide information for geo-location reconstruction on the ground
  - Specifications
    - Same # pixels as science instrument (8k) or more
    - Higher spatial resolution than science instrument (possibly by 10x) to detect roll motion by viewing coastline (contrast of bright land next to dark ocean).
    - Detector is readout at ~100Hz
- **Instrument IMU and star trackers, 2 heads, for pointing knowledge.**
- **FSM (fast-steering mirror) to correct for jitter motion detected by the IMU (Inertial Measurement Unit).**



# Performance Goals

## Integrated Design Capability / Instrument Design Laboratory

- **Signal-to-Noise Ratio (SNR) at L<sub>typ</sub> (70° SZA) - see STM & SNR table**
  - ≥1000:1 for 10 nm FWHM (350-800 nm) (Threshold) - **Designed to Meet**
  - Aggregate SWIR bands up to 2x2 GSD pixels to meet SNR (Threshold) - **Meets**
  - Aggregate NO<sub>2</sub> bands up to 3x3 GSD pixels to meet 500:1 SNR (Threshold) - **Meets**
- **Scanning area per unit time:**
  - Threshold: ≥25,000 km<sup>2</sup>/min; **Baseline: ≥50,000 km<sup>2</sup>/min** (these rates permit 3 and 6 scans, respectively of U.S. coastal waters including Laurentian Great Lakes).
- **Field of Regard: Full disk: 20.8° E-W and 19° N-S imaging capability from nadir for Lunar & Solar Calibrations - Meets by Design**
- **Non-saturating detector array(s) at L<sub>max</sub> - Meets by Design**
- **On-board Calibration: Lunar - minimum monthly; Solar - daily - Meets**
- **Polarization Sensitivity: Requirement <2%, goal <1.0% - May Meet**
- **Relative Radiometric Precision: ≤1% through mission lifetime - Meets**
- **Pointing Line-of-Site (LOS) Error (as % of 1 nadir pixel) - Meets**
  - **Measured by roll camera, closed loop control with actuators and combined with vibration suppression system**
  - Pointing Knowledge LOS: <50% Threshold & <10% Baseline
  - Pointing Accuracy LOS: <100% Threshold & <25% Baseline
  - Pointing Stability LOS: <50% Threshold & <10% Baseline
  - Geo-location Reconstruction: <100% Threshold & <10% Baseline



# SNR Requirements

## Integrated Design Capability / Instrument Design Laboratory

		(SZA = 70Y)			
$\lambda_o$ - nm	$\Delta\lambda$ - nm	$W/m^2 - \Delta\lambda_{lum} - ster$		Req'd	
Bands	FWHM	L <sub>typ</sub>	L <sub>max</sub>	SNR <sub>req</sub>	Required Minimum Set of Multi-Spectral Bands <sup>1</sup>
350	15	46.90	166.2	1,000	
360	10	45.40	175.6	1,000	Yes
385	10	38.40	177.9	1,000	Yes
412	10	49.50	281.1	1,000	Yes
425 <sup>^</sup>	0.8	48.20	277.0	500	
443	10	45.00	271.3	1,000	Yes
460	10	41.90	266.0	1,000	
475	10	38.20	261.3	1,000	
490	10	34.90	256.6	1,000	Yes
510	10	29.00	250.3	1,000	Yes
532	10	23.30	243.4	1,000	
555	10	18.50	224.9	1,000	Yes
583	10	15.30	227.4	1,000	
617	10	12.20	216.7	1,000	Yes
640	10	10.50	209.5	1,000	
655	10	9.57	204.7	1,000	
665	10	9.17	201.6	1,000	Yes
678	10	8.66	197.5	1,000	Yes
710	10	6.95	187.5	1,000	Yes
748	10	5.60	175.5	600	Yes
765	40	5.25	170.2	600	Yes
820	15	3.93	152.9	600	
865	40	2.77	138.8	600	Yes
1020	40	1.48	109.1	450	Yes
1245*	20	0.582	56.10	250	
1640*	40	0.178	19.70	180	
2135*	50	0.040	5.35	100	

NOTES

For estimating SNR for NO2 retrievals

<sup>1</sup> Additional bands between 360-1020nm desirable; SNR should not be an issue for the additional bands.

<sup>^</sup> Pixels can be aggregated up to 3x3 to achieve required SNR of 500:1 for atmospheric NO2 retrievals

\* Pixels can be aggregated up to 2x2 to achieve required SNR

# Operational Concept



## Integrated Design Capability / Instrument Design Laboratory

### • Calibration

- Dark calibration - performed at start and end of the day
- Solar and lunar calibrations as needed (daily to weekly solar; lunar as frequently as lunar views permit)
  - Scan as needed to illuminate all detector pixels
  - Mechanisms: wheel with diffusers for solar calibrations
    - Would like to keep costs of solar cal. capability within MEL distinct for possible de-scoping.

### • Science

- Step and Stare with scan mirror
  - Continuous science scans of the Earth for ~16 hours/day
  - Scan U.S. coastal waters (500km wide scenes) every 1-3 hours.
  - Scan non-U.S. coastal and open ocean waters as time permits.
  - Integration time per iFOV depends on minimum  $L_{typ}$  within iFOV (ranging from 0.5 to >2 seconds).
  - Survey and Targeted modes (higher frequency sampling)
- The list of targets are predefined on the ground and uploaded to the instrument on a weekly basis. The load can be updated daily if needed to take into account cloud cover. For each target, ground uploads: Target starting location, Length of time to integrate at each step (stare), Length of time to integrate at each wavelength, Total length of time to observe the target.

### • Repeat Daily



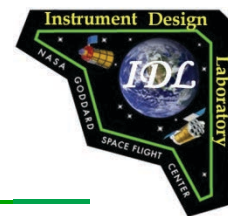

# Instrument Modes

## Integrated Design Capability / Instrument Design Laboratory

### • Launch

- Instrument Off, Survival Heaters On

### • Standby/Safe - Enter this mode upon power up or a ground command

- Diffuser Wheel is in the closed position and off; Scan Mirror and FSM are powered off
- MEB, Star tracker, IRU, Roll Camera, Detectors and Digitizers are all left on to avoid temperature cycling the electronics.
- Operational temperatures are maintained; Housekeeping data collected.
- Diagnostics and software updates are performed in this mode.

### • Science

- Survey and Targeted (high frequency sampling)
- The same operation for both Survey and Targeted: step and Stare
- Duration about 16 hours/day
- The list of targets are predefined on the ground and uploaded to the instrument on a weekly basis. The load can be updated daily if needed to take into account cloud issues. For each target, ground uploads: Target starting location, Length of time to integrate at each step (stare), Total length of time to observe the target
- Enter Science Mode by either ground or stored command.
  - Typically stored command since the start time will be in the weekly upload.

### • Calibration

- Cal-Dark - Performed regularly at the start and end of the day
- Cal-Moon and Cal-Sun - as needed
  - Commanded from the ground





# Instrument Calibration, cont.

## Integrated Design Capability / Instrument Design Laboratory

- **Cal-Moon**

- Duration ~5 min; radiometric calibration, performed when the moon is in the FOR; 3-5 times per month; Scan North/South and East/West for averaging due to craters; Performed as needed; Observation sequence and integration time are commanded from the ground

- **Cal-Sun**

- Duration ~20 min; performed when the sun is in the FOR (at night time); Initially performed daily but less frequent (weekly) later on; Observation sequence and integration time are commanded from the ground
- Cal-Sun Types:
  - Standard Solar Diffuser
  - Rare Earth Doped Diffuser
  - **Degradation Monitoring (Eliminated due to size constraints, but can be achieved with other calibrations)**

- **Cal-Star Tracker**

- Duration ~20 min; Line-of-Sight (LOS) calibration to eliminate bias error; View dark star field (no sunlight or moon); Continuous at low rate such as once per hour

- **Cal-Dark**

- Duration ~5 to 30min; Dark counts for detectors; Performed during the night to maximize science data collection; Planned twice a day (at the start and end of the day)

# Mission Operations Concept

## Integrated Design Capability / Instrument Design Laboratory

Mode	Function	Frequency	Duration	Mechanism Configuration		
				Diffuser Wheel Mechanism	Scan Mirror Mechanism	FSM
Launch				Closed, Off & Launch Locked	Off & Launch Locked	Off
Standby	Health & Safety, FSW upload, Diagnostic, overnight	Daily	~7 Hours/day	Closed; off	Off	Off
Science	Survey & Targeted	Daily	16 Hours/day	Clear	Move & Stare	On
Cal - Moon	Lunar radiometric cal	When available, 3 to 5/Month	~5 min	Clear	Move & Stare	On
Cal - Sun	Solar radiometric cal	When available, Daily - Weekly	~5 min	Solar Diffuser or Rare Earth Doped	Move & Stare	On
Cal - Star Tracker	Calibrate instrument LOS wrt attitude hardware	Once per hour	Continuously	Any	Move & Stare	On
Cal - Dark	Measure detector dark current and bias	2 x Daily	~5 min	Closed	N/A	N/A



---

Integrated Design Capability / Instrument Design Laboratory

# Systems Presentation Part II



# Baseline Top Level Mass Summary

Integrated Design Capability / Instrument Design Laboratory

GeoCape WAS	Mass (kg)	% of Total
Science Aperture Baffle Assembly	9.9	2.8%
Diffuser Select Assembly	46.5	13.3%
Scan Mirror Assembly	34.0	9.7%
Telescope Assembly	19.5	5.6%
Internal Baffles	0.5	0.1%
Common Mount Assembly	3.4	1.0%
UV/Vis Channel	9.6	2.8%
Vis/NIR Channel	10.2	2.9%
SWIR Channel	11.4	3.2%
Instrument Structure / Enclosure	111.9	31.9%
UV/VIS/NIR Digitizer Box	3.0	0.9%
SWIR Digitizer Box	1.1	0.3%
Roll Camera	7.2	2.1%
uASC Star Tracker	1.5	0.4%
IMU Assembly	10.3	2.9%
WAS Main Electronics box	7.1	2.0%
Harness	14.4	4.1%
Contamination Purge Hardware	2.0	0.6%
Thermal Subsystem	30.2	8.6%
5% Misc Hardware	16.7	4.8%
<b>Total + 5% Misc Hardware</b>	<b>350.3</b>	<b>100.0%</b>

# Baseline Mass by Subsystem

Integrated Design Capability / Instrument Design Laboratory

Subsystem	Mass (kg)	% of Total
ACS	5.4	1.5%
Contamination	2.0	0.6%
Detector	1.1	0.3%
Electrical	11.4	3.2%
Harness	14.4	4.1%
Mechanical	179.3	51.2%
Mechanism	38.8	11.1%
Optical	52.6	15.0%
Thermal	28.6	8.2%
5% misc Hardware	16.7	4.8%
<b>Total + 5% Misc Hardware</b>	<b>350.3</b>	<b>100.0%</b>

# Top Level Mass Summary for Delta Designs

Integrated Design Capability / Instrument Design Laboratory

GeoCape WAS	Baseline	Case 1	Case 2	Case 3
	Mass (kg)	Mass (kg)	Mass (kg)	Mass (kg)
Science Aperture Baffle Assembly	9.9	9.9	9.9	9.9
Diffuser Select Assembly	46.5	46.5	46.5	46.5
Scan Mirror Assembly	34.0	34.0	34.0	34.0
Telescope Assembly	19.5	19.5	19.5	19.5
Internal Baffles	0.5	0.4	0.4	0.3
Common Mount Assembly	3.4	3.4	3.4	2.7
UV/Vis Channel	9.6	9.6	-	-
Vis/NIR Channel	10.2	10.2	-	-
UV/VIS/NIR Channel	-	-	10.1	10.1
SWIR Channel	11.4	-	11.4	-
Instrument Structure / Enclosure	111.9	98.4	98.4	84.5
UV/VIS/NIR Digitizer Box	3.0	3.0	3.0	3.0
SWIR Digitizer Box	1.1	0.0	1.1	0.0
Roll Camera	7.2	7.2	7.2	7.2
uASC Star Tracker	1.5	1.5	1.5	1.5
IMU Assembly	10.3	10.3	10.3	10.3
WAS Main Electronics box	7.1	7.1	7.1	7.1
Harness	14.4	14.0	14.4	13.9
Contamination Purge Hardware	2.0	2.0	2.0	2.0
Thermal Subsystem	30.2	27.5	30.1	27.4
5% Misc Hardware	16.7	15.2	15.5	14.0
<b>Total + 5% Misc Hardware</b>	<b>350.3</b>	<b>319.6</b>	<b>325.6</b>	<b>293.7</b>



# Mass by Subsystem for Delta Designs

Integrated Design Capability / Instrument Design Laboratory

GeoCape WAS	Baseline	Case 1	Case 2	Case 3
Subsystem	Mass (kg)	Mass (kg)	Mass (kg)	Mass (kg)
ACS	5.4	5.4	5.4	5.4
Contamination	2.0	2.0	2.0	2.0
Detector	1.1	0.5	1.1	0.5
Electrical	11.4	11.1	11.4	11.1
Harness	14.4	14.0	14.4	13.9
Mechanical	179.3	159.4	161.3	141.2
Mechanism	38.8	38.8	38.8	38.8
Optical	52.6	47.0	47.2	40.6
Thermal	28.6	25.7	28.6	26.1
5% misc Hardware	16.7	15.3	15.5	14.0
<b>Total + 5% Misc Hardware</b>	<b>350.3</b>	<b>319.1</b>	<b>325.7</b>	<b>293.6</b>

# Data Rate Calculations

## (Cases 1 & 3, No SWIR)



Integrated Design Capability / Instrument Design Laboratory

<b>GeoCape-WAS</b>	UV-VIS Detector	(8K x 1K)	VIS-NIR Detector	(8K x 1K)
Array Size (pix)	8,192	1,024	8,192	1,024
# Taps, pix/tap	8	1,048,576	8	1,048,576
Int. Period, Tap pix rate	1.4	748,983	1.4	748,983
Bit Resolution, Tap bit rate	14	10,485,760	14	10,485,760
Array Readout Rate (bps)		83,886,080		83,886,080
Total Data Rate (Mbps)	1	<b>83.9</b>	1	<b>83.9</b>

Data Reduction Scheme				Readout Rate (bps)	Comments
<b>Blue Channel</b>			@ 1 pix/band		
340 - 450nm	@ 0.4nm =>	275 detector pix	275 bands	2,750.0	ie. No pixel summation for 0.4nm res
450 - 600nm	@ 0.4nm =>	375 detector pix	75 bands	910.7	ie. 5:1 pix summation for 2nm res
<b>Data Rate :</b>				<b>3,660.7</b>	<b>assuming 1.4sec integration, 14bits/pix</b>
<b>Red Channel</b>					
600 - 760nm	@ 0.5nm =>	320 detector pix	80 bands	914.3	ie. 4:1 pix summation for 2nm res
760 - 900nm	@ 0.5nm =>	280 detector pix	14 bands	190.0	ie. 20:1 pix summation for 10nm res
900 - 1100nm	@ 0.5nm =>	400 detector pix	20 bands	271.4	ie. 20:1 pix summation for 10nm res
<b>Data Rate :</b>				<b>1,375.7</b>	<b>assuming 1.4sec integration, 14bit/pix</b>
				=> <b>5,036.4</b>	<b>Kbps each of 8K rows</b>
				=> <b>40.29</b>	<b>Mbps (ie. Multiply by 8K rows)</b>
<b>Downlink Data Rate:</b>				<b>23.7</b>	<b>(ie. Assume 1.7:1 compression ratio)</b>





# Instrument Power Estimates (Cases 1 & 3, No SWIR)

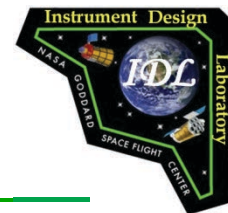

Integrated Design Capability / Instrument Design Laboratory

## Instrument & Box Power Calculator

LVPC External Load	Qty	Avg. Power Each (W)	Power Modes				
			Launch (W)	Standby (W)	Calibration (W)	Science (W)	Survival (W)
FEE Card(s)	4	8.0		6.4	32.0	32.0	
Detectors	2	2.0		4.0	4.0	4.0	
Precision heater(s)	2	1.0		2.0	2.0	2.0	
Diffuser Motor	1	50.0			50.0		50W for 10 sec, 0W otherwise
Diffuser Motor Encoder	1	5.0			5.0		5W for 10 sec, 0W otherwise
Scan Mirror Motor	1	5.0			0.3	0.3	
Scan Mirror Motor Encoder	1	5.0			5.0	5.0	
FSM & Jitter Actuators	7	2.0			14.0	14.0	
LVDT Sensors	4	2.0			8.0	8.0	
Roll Cameras	2	9.0			18.0	18.0	
<b>External Load Total:</b>	<b>25</b>	<b>89.0</b>	<b>0.0</b>	<b>12.4</b>	<b>138.3</b>	<b>83.3</b>	<b>0.0</b>
<b>E-Box Circuit Boards</b>							
1. Processor Card	1	15.0		15.0	15.0	15.0	
2. Heater Control Card	1	5.0		5.0	5.0	5.0	
3. Scan DC-Motor Card	1	5.0		5.0	5.0	5.0	
4. Diffuser Stepper Motor Card	1	4.0		4.0	4.0	4.0	
5. FSM Voice-Coil Control	1	4.0		4.0	4.0	4.0	
6. Jitter & Roll Voice-Coil Control	1	4.0		4.0	4.0	4.0	
Power Converter Efficiency (%)	80						
Power Converter(s)	1	31.5	0.0	12.3	43.8	30.1	0.0
<b>E-Box Total:</b>	<b>7</b>	<b>68.4</b>	<b>0.0</b>	<b>49.3</b>	<b>80.8</b>	<b>67.0</b>	<b>0.0</b>
<b>Direct S/C Bus Load</b>							
IMU	1	24.0		24.0	24.0	24.0	
Star Trackers	1	4.0		4.0	4.0	4.0	
Thermostat Heaters	1	163.0		163.0	163.0	163.0	
Survival Heaters	1	65.0	65.0				65.0
<b>Direct S/C Bus Load Total:</b>	<b>8</b>	<b>256.0</b>	<b>65.0</b>	<b>191.0</b>	<b>191.0</b>	<b>191.0</b>	<b>65.0</b>
<b>Instrument Total:</b>	<b>n/a</b>	<b>413.4</b>	<b>65.0</b>	<b>252.7</b>	<b>410.0</b>	<b>341.3</b>	<b>65.0</b>

S/C Power Bus Requirement



# WAS Block Diagram



Integrated Design Capability / Instrument Design Laboratory

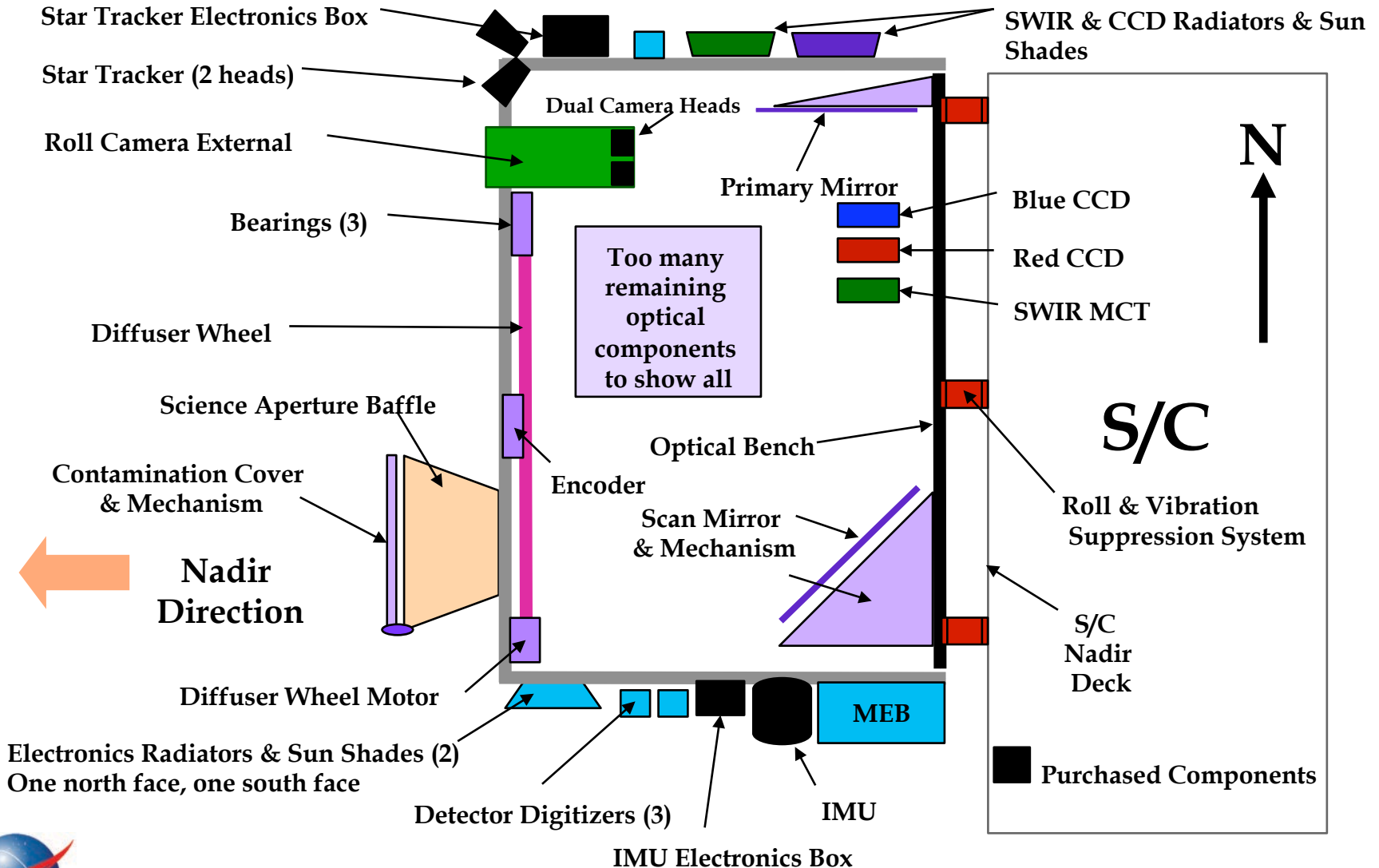

# Cost Assumptions

Integrated Design Capability / Instrument Design Laboratory

## • Instrument Life Cycle

- Project Start Date (Authorization to Proceed) Dec. 2017
- CDR Date Dec. 2018
- Payload Environmental Review May 2021
- Mission Duration 3 Years

## • Number of units to build and cost:

- 1 Fully integrated Flight units
- 0 Flight spare units
- 0 Engineering test units (ETU) or protoflight of Interface Electronics Box
- 0 Engineering Development units (EDU) (prototype)



# Cost Assumptions

Integrated Design Capability / Instrument Design Laboratory

- **Build Assumptions:**
  - Out of House
- **Dollar Assumptions**
  - Constant year dollars FY2016\$
- **Class of Electronics Parts:**
  - Class B
- **Throughput or Purchased Item(s) from Customer**
  - None



# Cost Assumptions

Integrated Design Capability / Instrument Design Laboratory

- Detectors will parametricly costed by SEER-H
- Flight Software will parametricly costed by SEER-SEM
- ASICs assembly code will use grassroots cost estimate
- FPGA firmware costs are shown in the FPGA tab
  - We have used a grassroots costing scheme from Code 560 to account for unique algorithms
  - This estimate does not account for a GSE testbed, if one cannot be reused, nor does it account for any sustaining engineering during the mission lifetime

# Cost Assumptions

## Integrated Design Capability / Instrument Design Laboratory

Instrument Level Considerations	Typical IDL Wrap	Geo Cape WAS Wrap
Ground Support Equipment (GSE) that is instrument-specific (that is, cannot be readily adapted from general purpose GSE)	5%	5%
Environmental testing at the Instrument Level	5%	5%
Component level flight spare component	10%	10%
Engineering Test Unit (ETU) @ Subassembly Level	10%	10%
Center Management & Overhead (CM&O)		No

### Notes:

We typically recommend carrying a 5% wrap of the total hardware costs to account for Instrument to S/C Integration and Test (this is typically carried in WBS 10.0, so we don't show it in our instrument totals which are carried in WBS 5.0)

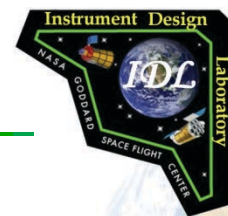

---

Integrated Design Capability / Instrument Design Laboratory

# GEO CAPE Wide Angle Spectrometer (WAS) ~ *Concept Presentations* ~

## Optics

Cathy Marx

July 29, 2014

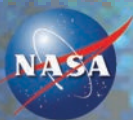

---

N A S A   G O D D A R D   S P A C E   F L I G H T   C E N T E R

# First Order Optical Parameters

Integrated Design Capability / Instrument Design Laboratory

- 3 separate spectrometer channels all sharing one common telescope. Scan mirror out front.
- **UV/Vis channel - 340 nm - 600 nm**
  - 8k x 1k array of 15  $\mu\text{m}$  pixels
  - 375m GSD
  - Focal length 1431 mm, F/4.4
  - 0.4nm/pixel dispersion
- **Vis/NIR channel - 600 nm - 1100 nm**
  - 8k x 1k array of 15  $\mu\text{m}$  pixels
  - 375m GSD
  - Focal length 1431 mm, F/4.4
  - 0.4nm/pixel dispersion
- **SWIR - 1245, 1640, 2135 nm**
  - 8k x 1k array of 15  $\mu\text{m}$  pixels
  - 375m GSD
  - Focal length 1431 mm, F/4.4
  - Dispersed across detector
- Full field of view is  $4.8^\circ$
- Scan mirror range:  $45^\circ \pm 4.75^\circ$  in N-S and  $0^\circ \pm 5.2^\circ$  E-W

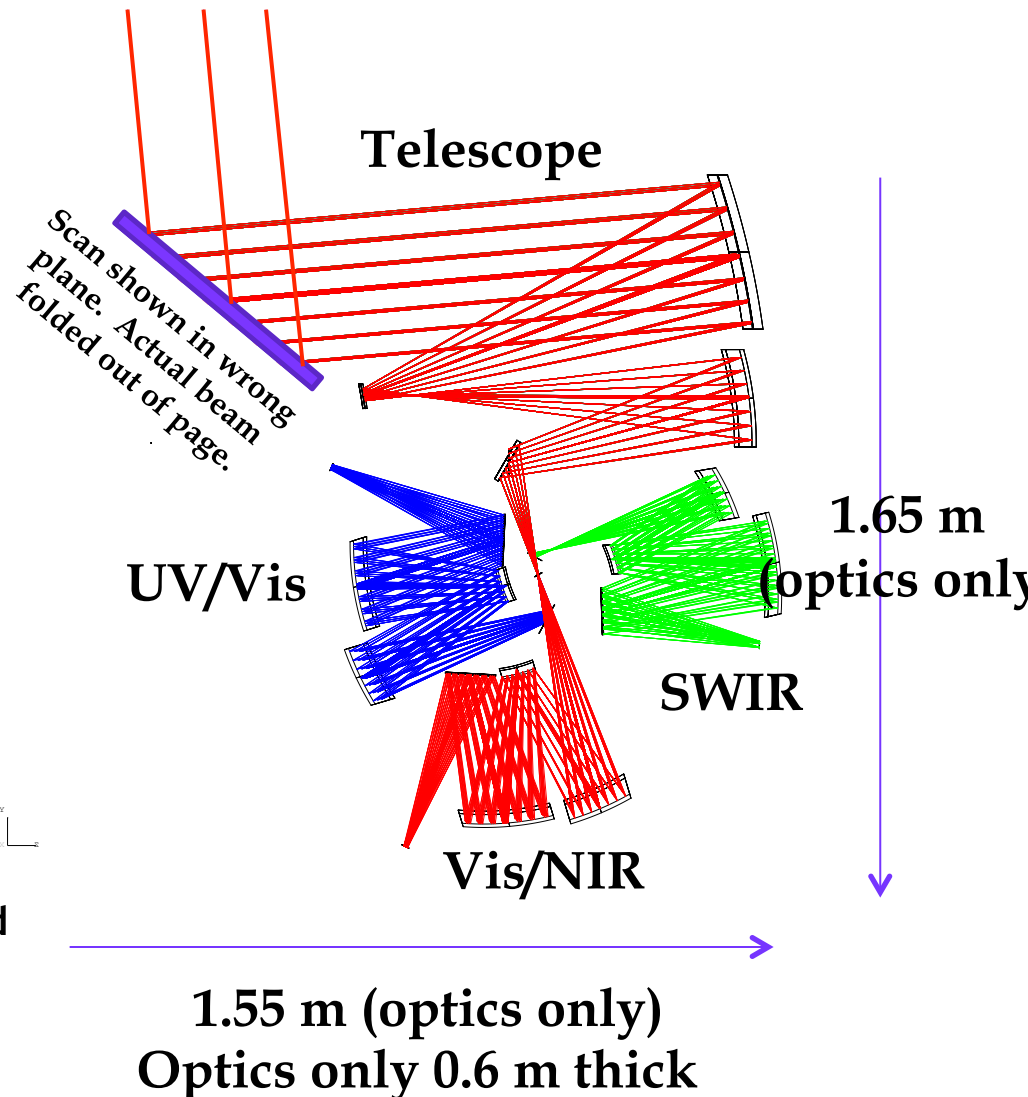



# Different Views (no scan mirror)

Integrated Design Capability / Instrument Design Laboratory

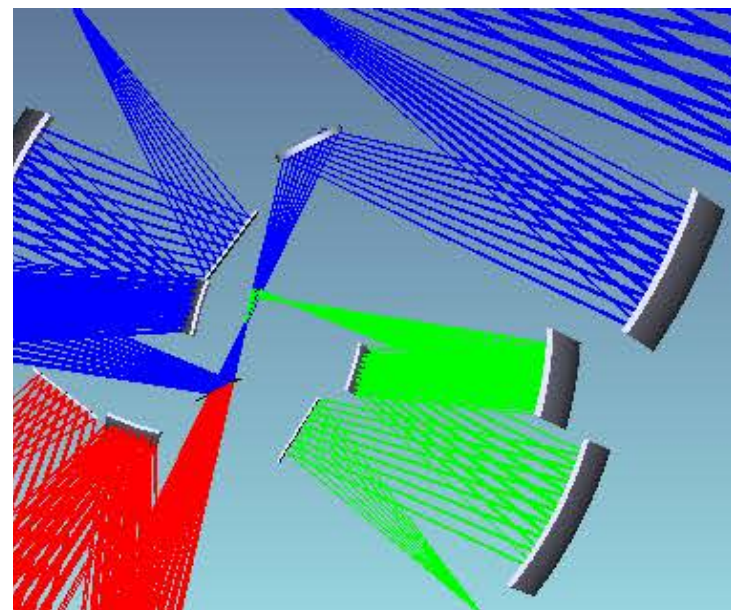
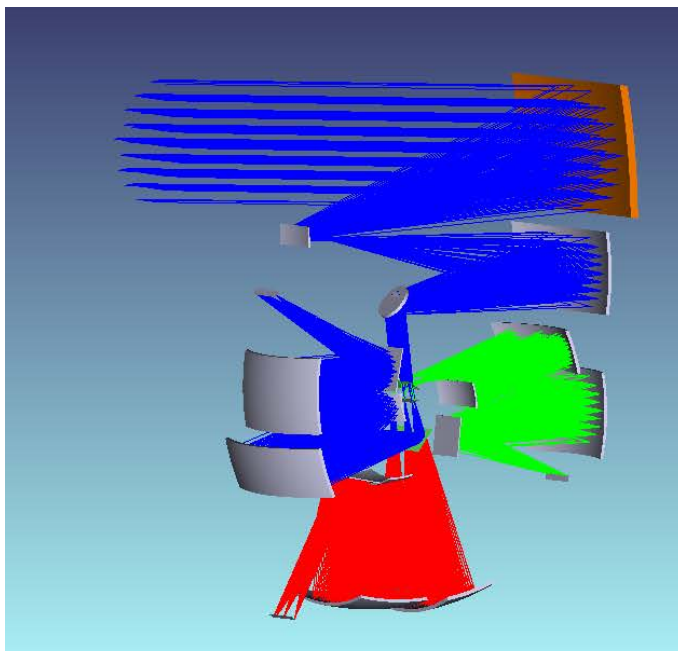

# Three Mirror Telescope

Integrated Design Capability / Instrument Design Laboratory

- Entrance aperture is 325 mm in diameter, unobscured
- Focal length 1431mm, F/4.4
- Large two-axis scan mirror out front
- Primary and tertiary are aspheric surfaces, secondary is convex conic
- Slit is 15 $\mu$ m wide and 120 mm long

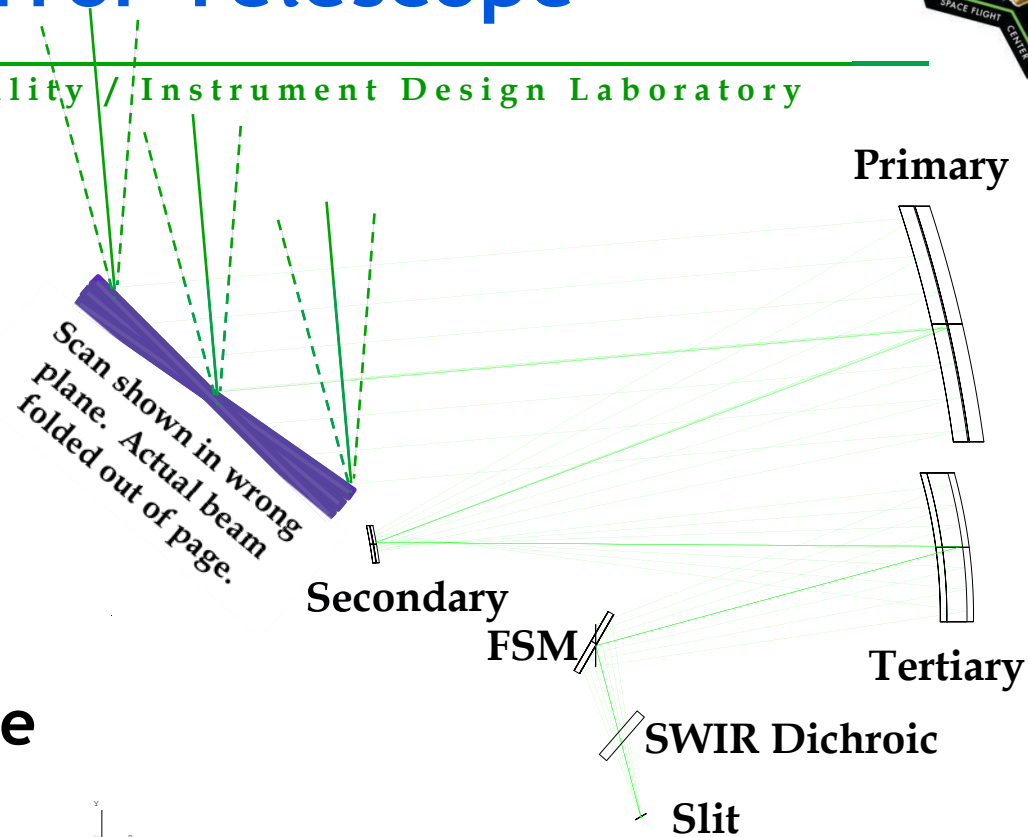

**NOTE: Depolarizer between secondary and tertiary mirror not shown but is in the MEL.**

# Telescope Performance

Integrated Design Capability / Instrument Design Laboratory

- **80% ensquared energy requirement along slit length led to aspheric mirrors. Still little margin.**
- **Three mirror anastigmat design**
- **Primary mirror**
  - Off-axis concave asphere
  - 610mm x 380 mm, 80% light-weighted ULE
- **Secondary mirror**
  - Off-axis convex conic
  - 160mm x 60mm, ULE
- **Tertiary mirror**
  - Off-axis concave asphere
  - 540mm x 240mm 80% light-weighted ULE
- **Fast Steering mirror**
  - Located at the system aperture stop
  - Flat, light weighted beryllium, 120 mm in diameter
- **SWIR dichroic is a front surface short pass fused silica dichroic**
  - Transmits below 1150nm
  - 220mm x 80mm
- **Slit is 15 $\mu$ m wide and 120 mm long**
- **All mirror surfaces coated with protected silver**

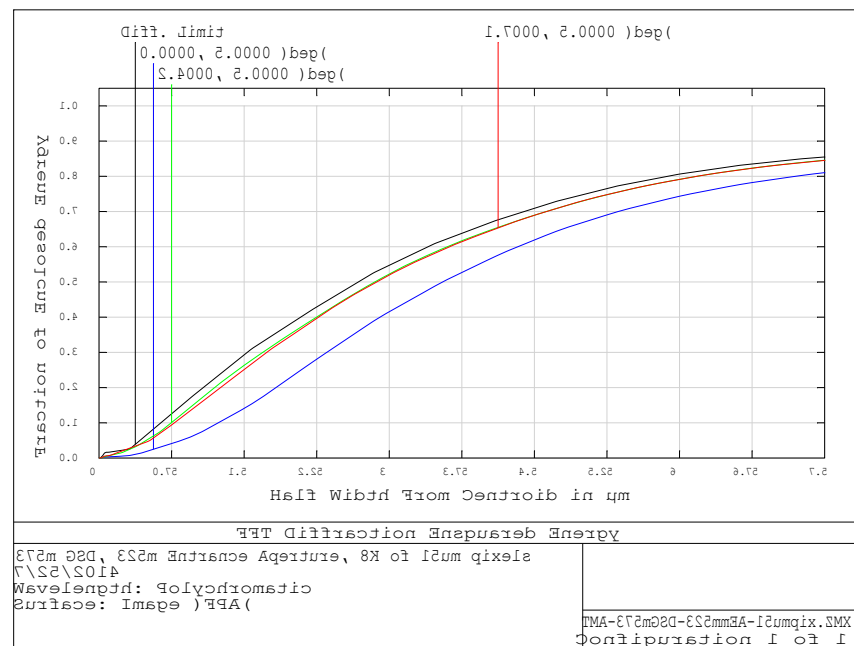

**Note: Half width of 7.5  $\mu$ m corresponds to 1 pixel.**

# Scan Mirror Specifications

## Integrated Design Capability / Instrument Design Laboratory

- **Field of Regard: Full disk: 20.8° E-W and 19° N-S imaging capability from nadir for Lunar & Solar Calibrations**
- **Assuming that scan mirror is 1.3m from the primary mirror:**
  - Un-tilted footprint is +/-225mm long slit direction by 360mm width (450 by 360)
  - Scan range is: 45°±4.75° in N-S and 0°±5.2° E-W
  - Final mirror size is: 860mm x 420mm
  - Assuming light weighted nickel plated beryllium with 25 kg/m<sup>2</sup> aerial density. This may be heavier than necessary. Will need to be examined in future work.

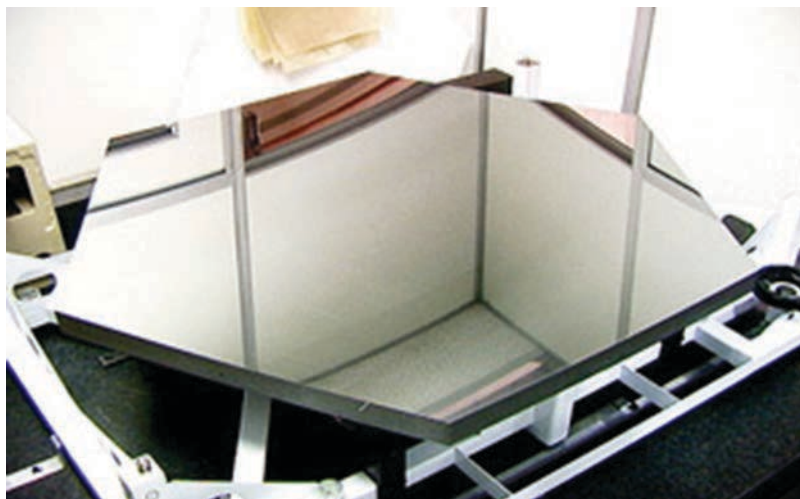

# UV/Vis Channel 340 nm - 600 nm

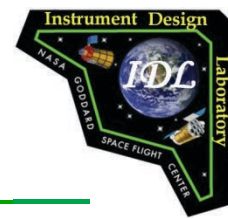

Integrated Design Capability / Instrument Design Laboratory

- Beam transmits through a mechanical slit and is reflected by a dichroic into the UV/Vis spectrometer.
- Spectrometer is a modified Offner design. Mirrors changed to aspheres to improve image quality.
- Dispersion set to 0.4nm/pixel
- Dichroic: reflects short of 600nm, 220 x 80mm
- Asphere 1: off-axis asphere, 80% light weighted ULE, 530mm x 150mm
- Grating: Convex spherical surface, 128 lines/mm, 230mm x 84mm
- Asphere 2: off-axis asphere, 80% light weighted ULE, 420mm x 220mm
- Fold mirror: required for packaging, ULE, 190mm x 128mm
- All mirrors have protected silver coating.

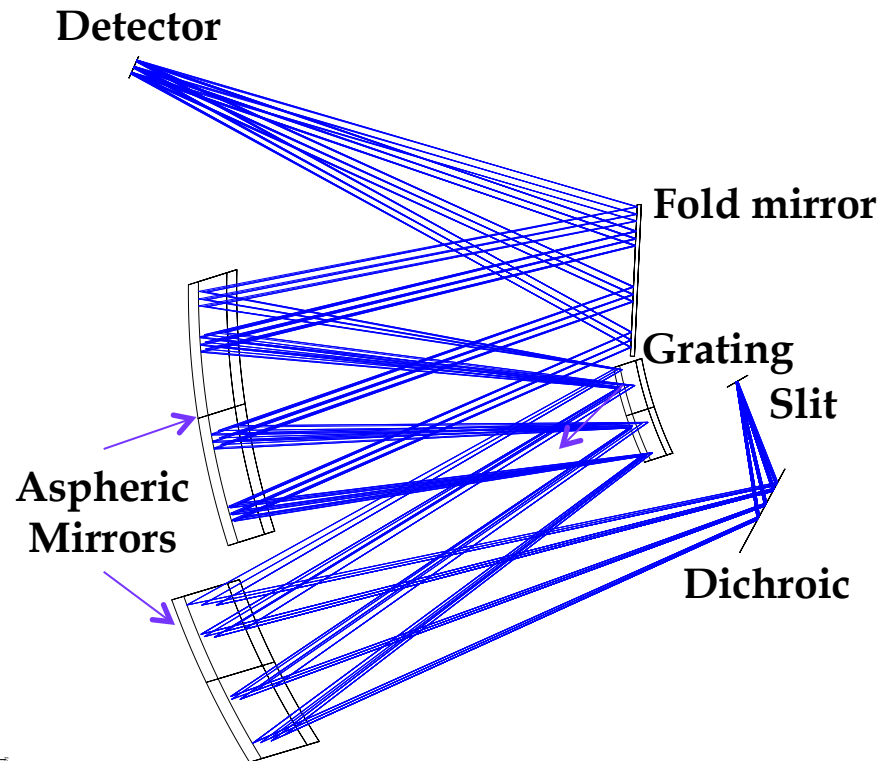

# UV/Vis Spot Diagrams

Integrated Design Capability / Instrument Design Laboratory

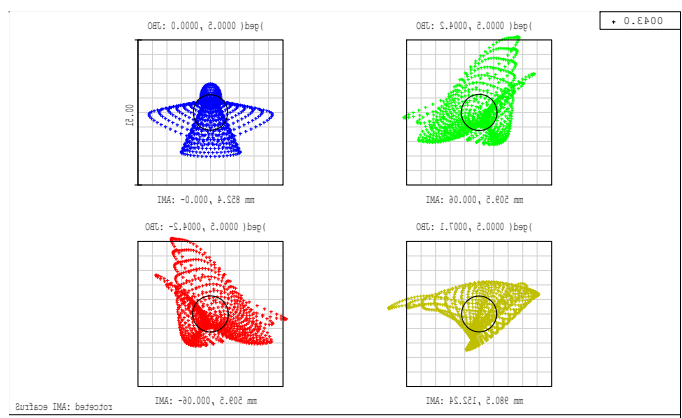

Spot Diagram

UV/Vis and Vis/NIR and SWIR -- 375m, 15um pixels	Airy Radius: 1.721 um
7/28/2014 Units are um.	
Field : 1 2 3 4	
RMS radius : 5.467 3.610 3.610 3.358	
GEO radius : 8.047 10.688 10.688 9.789	
Box width : 15	Reference : Centroid

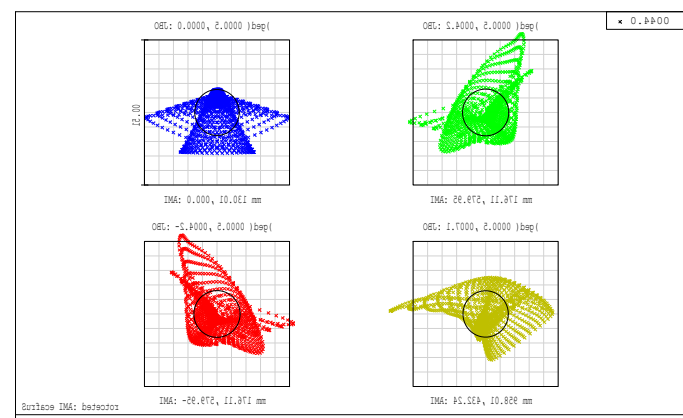

Spot Diagram

UV/Vis and Vis/NIR and SWIR -- 375m, 15um pixels	Airy Radius: 5.327 um
7/28/2014 Units are um.	
Field : 1 2 3 4	
RMS radius : 5.842 3.313 3.313 3.171	
GEO radius : 7.288 8.828 8.828 8.828	
Box width : 15	Reference : Centroid

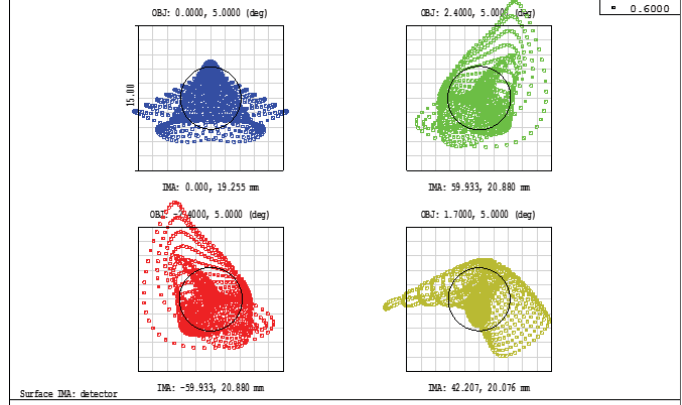

Spot Diagram

UV/Vis and Vis/NIR and SWIR -- 375m, 15um pixels	Airy Radius: 3.037 um
7/28/2014 Units are um.	
Field : 1 2 3 4	
RMS radius : 3.467 3.610 3.610 3.358	
GEO radius : 8.047 10.688 10.688 9.789	
Box width : 15	Reference : Centroid

Note: spot diagrams correspond to 1 pixel.



# UV/Vis Ensquared Energy

## Integrated Design Capability / Instrument Design Laboratory

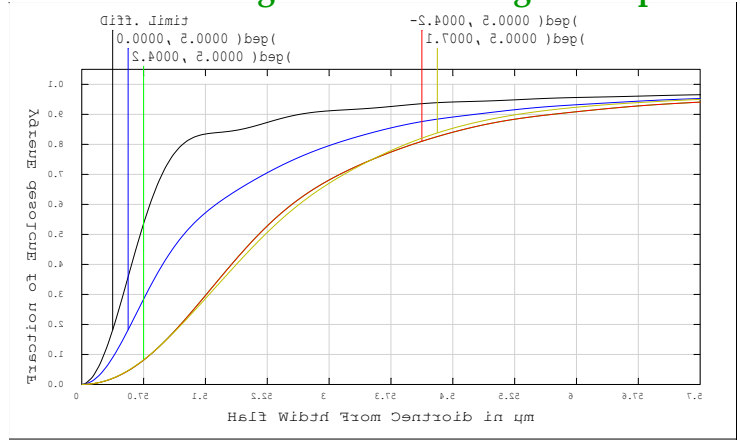

UV\Vis and Vis\NIR and SWIR -- 375m, 15um pixels  
 7/28/2014  
 Wavelength: 0.600000 um  
 Surface: Image (detector)

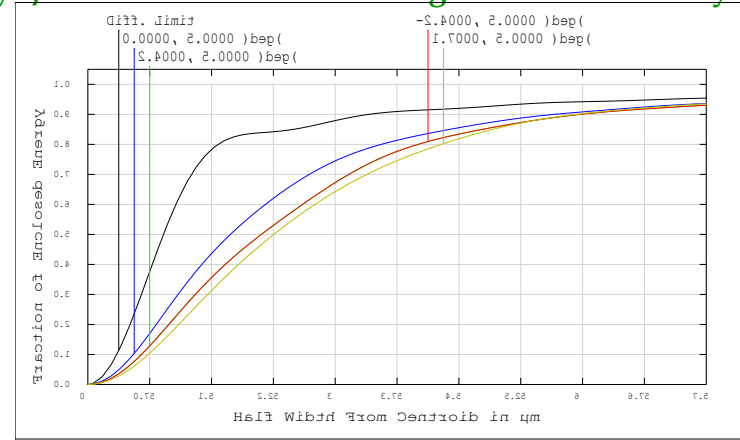

UV\Vis and Vis\NIR and SWIR -- 375m, 15um pixels  
 7/28/2014  
 Wavelength: 0.600000 um  
 Surface: Image (detector)

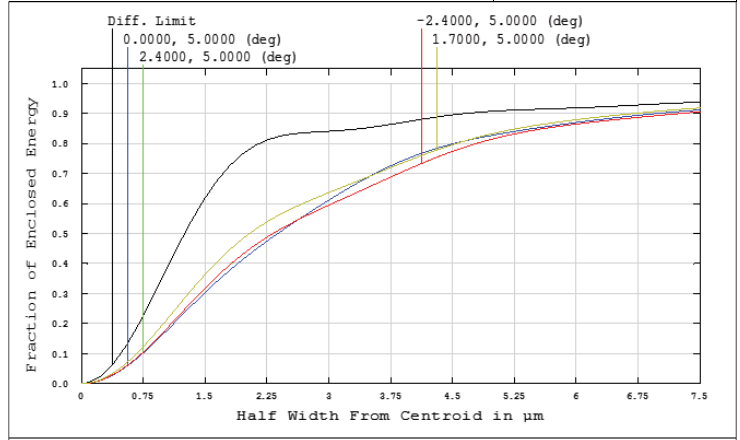

UV\Vis and Vis\NIR and SWIR -- 375m, 15um pixels  
 7/28/2014  
 Wavelength: 0.600000 um  
 Surface: Image (detector)

**Note: Half width of 7.5  $\mu$  m corresponds to 1 pixel.**



# Vis/NIR Channel 600nm - 1100nm

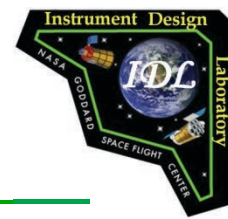

Integrated Design Capability / Instrument Design Laboratory

- Beam transmits through dichroic beamsplitter for this channel.
- Again, this is a modified Offner design. Mirrors changed to aspheres to improve image quality.
- Dispersion set to 0.5nm/pixel so image is only 1k pixels wide
- Dichroic: transmits wavelengths longer than 600nm, 220 x 80mm
- Asphere 1: off-axis asphere, 80% light weighted ULE, 530mm x 150mm
- Grating: Convex spherical surface, 52 lines/mm, 230mm x 85mm
- Asphere 2: off-axis asphere, 80% light weighted ULE, 420mm x 220mm
- Fold mirror: required for packaging, ULE, 190mm x 128mm
- All mirrors have protected silver coating.

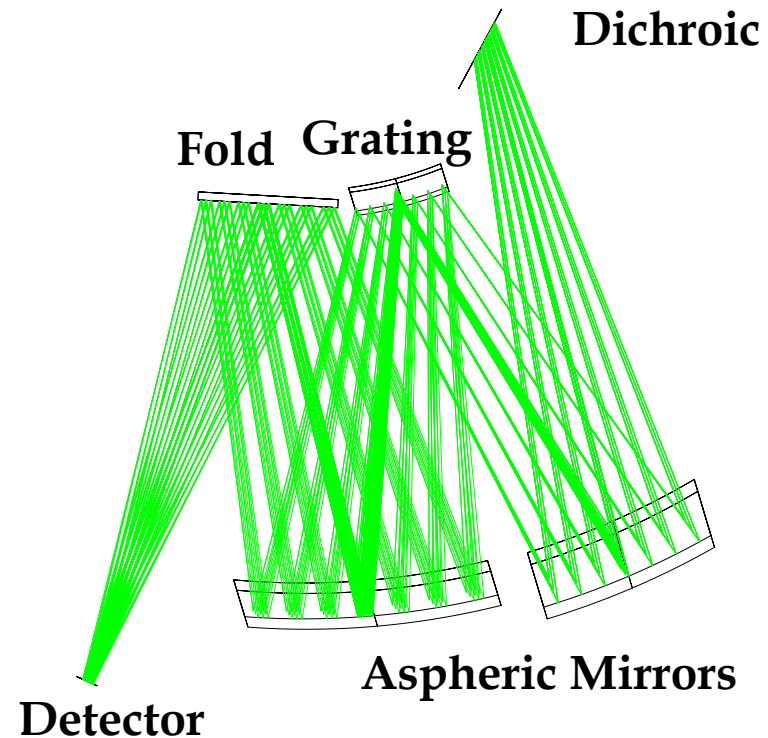



# Vis/NIR Spot Diagrams

Integrated Design Capability / Instrument Design Laboratory

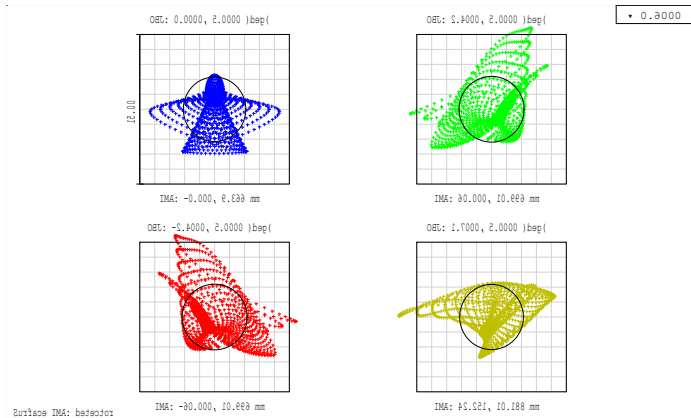

Surface IMA: detector

Spot Diagram

UV/Vis and Vis/NIR and SWIR -- 375m, 15um pixels	Units are um.	Airy Radius: 3.00 um
Field : 1	2	3
RMS radius : 3.280	3.858	3.434
GEO radius : 8.000	11.592	9.942
Box width : 15	Reference : Centroid	

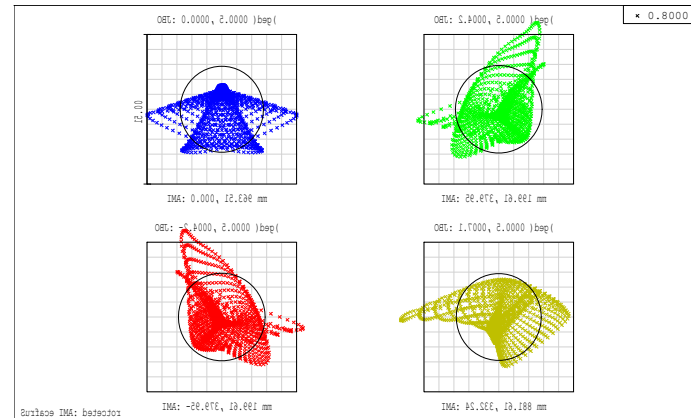

Surface IMA: detector

Spot Diagram

UV/Vis and Vis/NIR and SWIR -- 375m, 15um pixels	Units are um.	Airy Radius: 3.00 um
Field : 1	2	3
RMS radius : 3.280	3.858	3.434
GEO radius : 8.000	11.592	9.942
Box width : 15	Reference : Centroid	

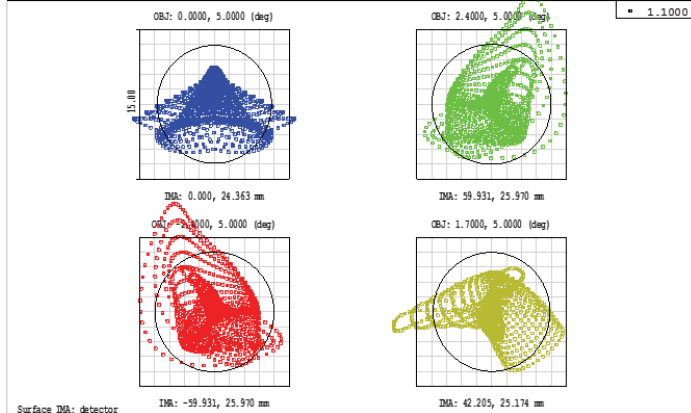

Surface IMA: detector

Spot Diagram

UV/Vis and Vis/NIR and SWIR -- 375m, 15um pixels	Units are um.	Airy Radius: 5.555 um
Field : 1	2	3
RMS radius : 3.520	3.858	3.340
GEO radius : 8.207	11.592	9.942
Box width : 15	Reference : Centroid	

Note: spot diagrams correspond to 1 pixel.

# Vis/NIR Ensquared Energy

Integrated Design Capability / Instrument Design Laboratory

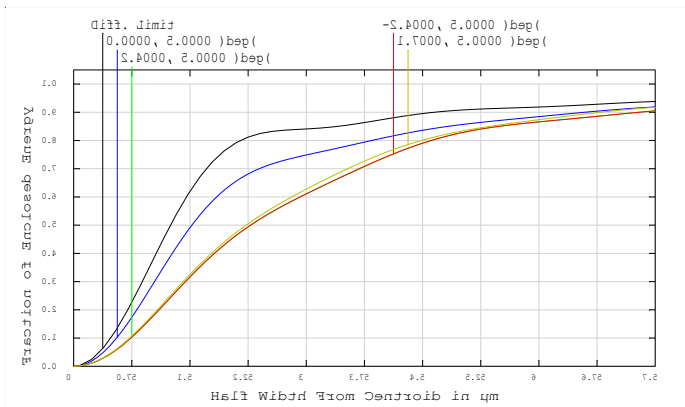

UV\Vis and Vis\NIR and SWIR -- 375m, 15um pixels  
 7/28/2014  
 Wavelength: 0.800000 um  
 Surface: Image (detector)

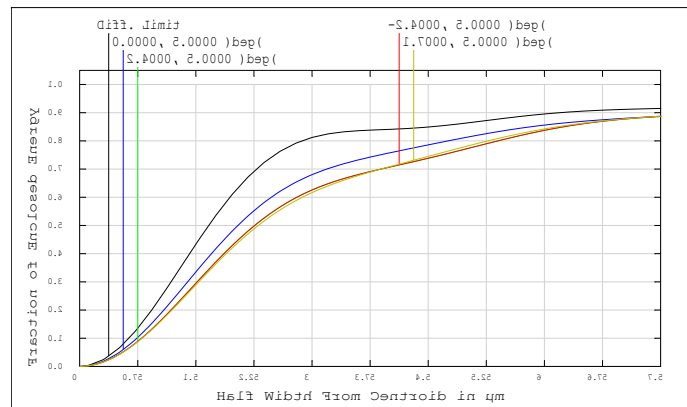

UV\Vis and Vis\NIR and SWIR -- 375m, 15um pixels  
 7/28/2014  
 Wavelength: 0.800000 um  
 Surface: Image (detector)

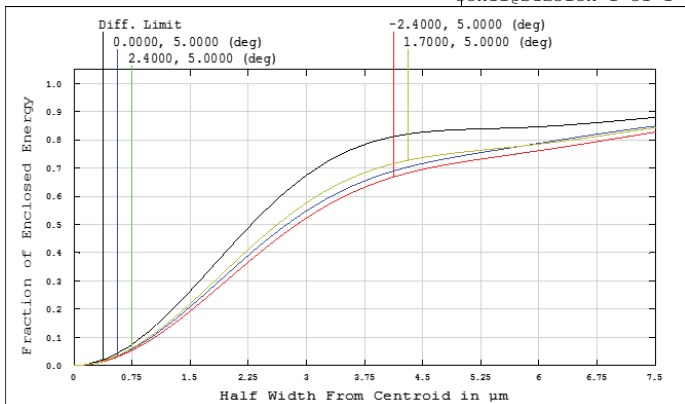

UV\Vis and Vis\NIR and SWIR -- 375m, 15um pixels  
 7/28/2014  
 Wavelength: 1.100000 um  
 Surface: Image (detector)

Note: Half width of 7.5  $\mu$  m corresponds to 1 pixel.



# SWIR Channel 1200nm - 2400nm

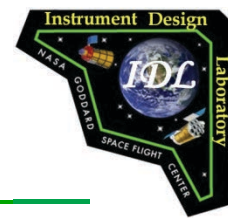

Integrated Design Capability / Instrument Design Laboratory

- Originally wanted to cover the same field of view on a 4k array of 15  $\mu\text{m}$  pixels.
  - Unable to meet image quality over the entire field
- Moved design to include 8kx1k array of 15 $\mu\text{m}$  pixels
- Modified Offner design
- Dispersion set to 1.2nm/pixel so image is only 1k pixels wide
- Dichroic: reflects wavelengths longer than 1100nm, 220 x 80mm
- Slit: 30nm wide (2 pixels), 120mm long
  - Will bin 2x2 pixels on focal plane, corresponding to 750m GSD.
- Asphere 1: off-axis asphere, 80% light weighted ULE, 530mm x 150mm
- Grating: Convex spherical surface, 52 lines/mm, 230mm x 85mm
- Asphere 2: off-axis asphere, 80% light weighted ULE, 420mm x 220mm
- Fold mirror: required for packaging, ULE, 190mm x 128mm
- All mirrors have protected silver coating.

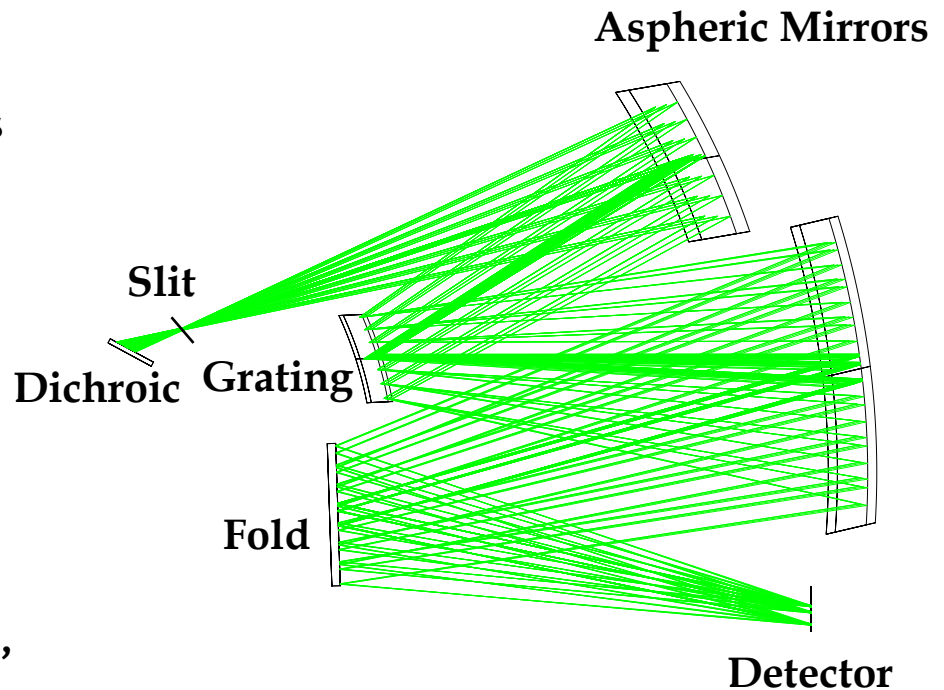

# SWIR Channel Spot Diagrams

Integrated Design Capability / Instrument Design Laboratory

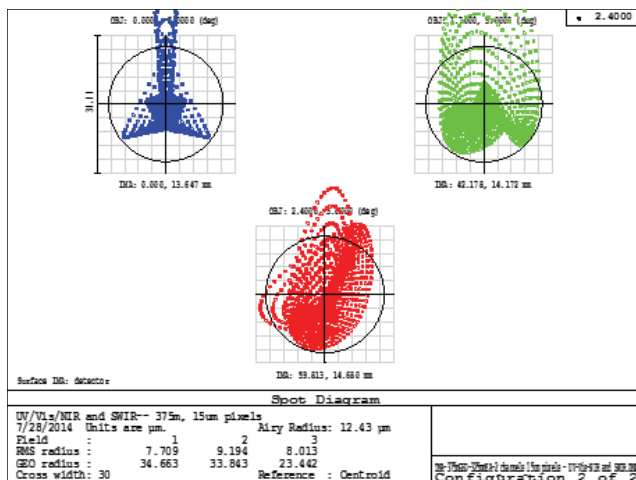
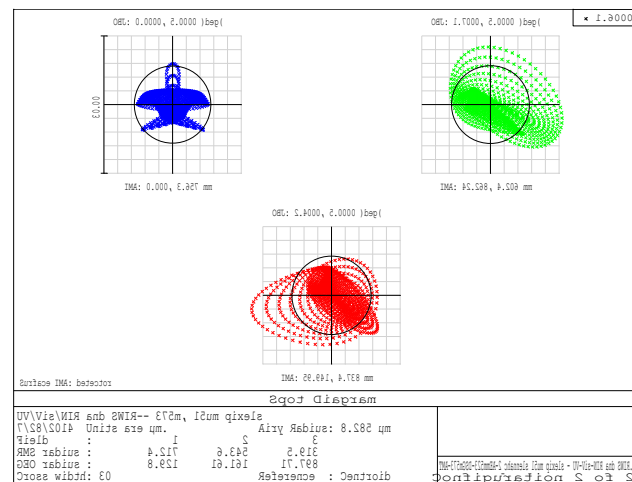
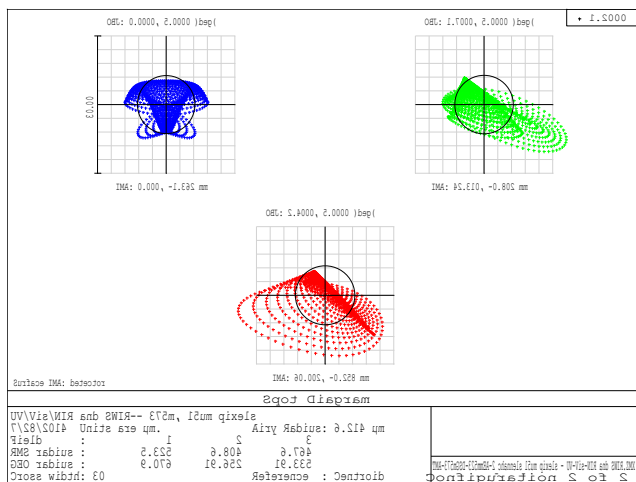

**Note: Spot diagrams correspond to 2x2 pixels. Airy disk diameter is larger than one pixel for wavelengths longer than 1.45  $\mu$  m.**

# SWIR Channel Ensquared Energy

Integrated Design Capability / Instrument Design Laboratory

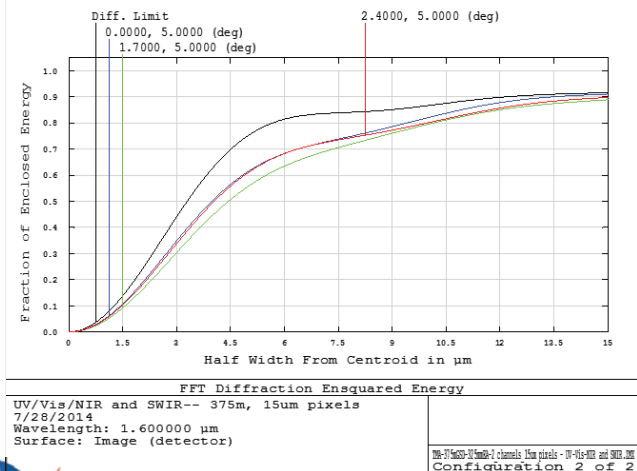
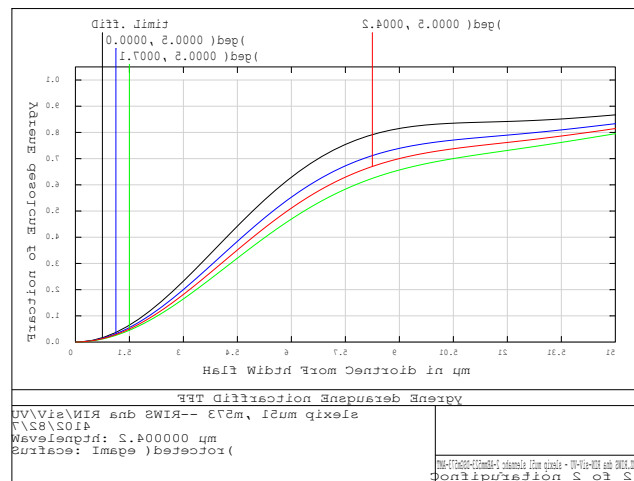
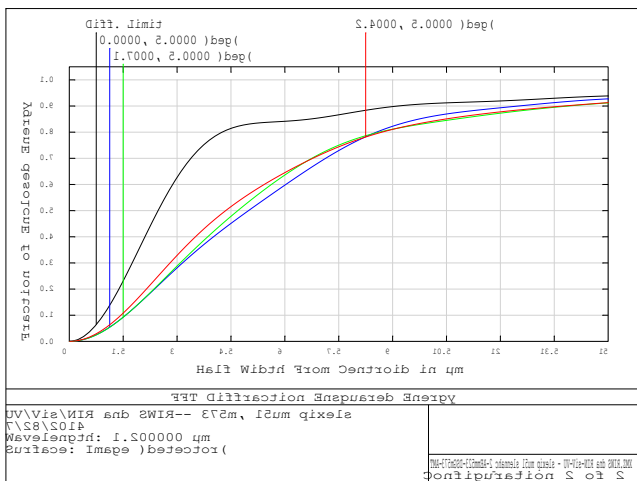

Note: Half width of 15  $\mu\text{m}$  corresponds to 2 pixels.



# Delta 2: Combined UV-Vis-NIR Channel Diffraction Efficiency



Integrated Design Capability / Instrument Design Laboratory

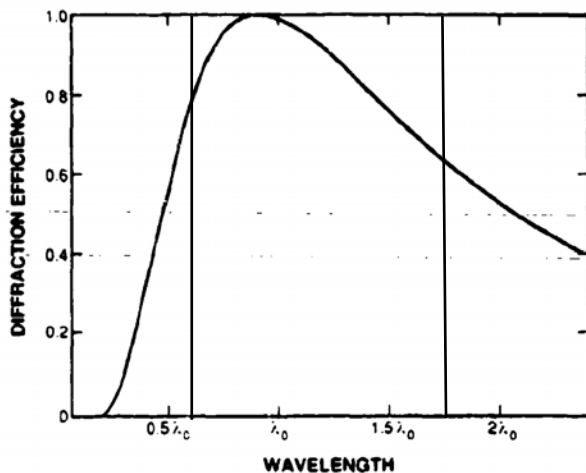

Figure 2-2. Plot of the diffraction efficiency as a function of wavelength.

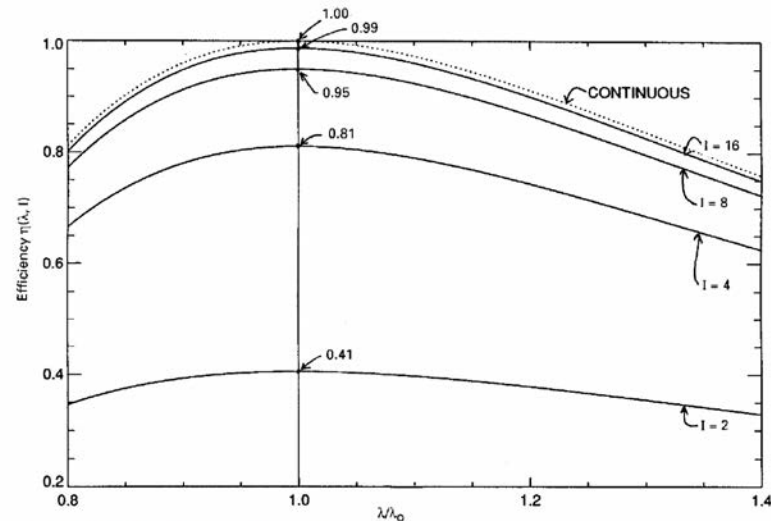
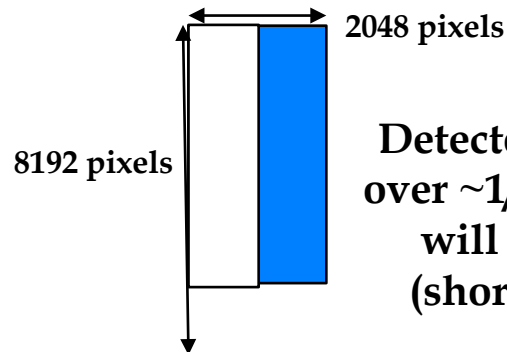

FIGURE 6 Diffraction efficiency of binary optics.<sup>4</sup>

Set  $\lambda_0$  at 600nm, then efficiency at 340nm is  $\sim 70\%$  and at 1050nm is  $\sim 60\%$ .



Detector will have filter  
over  $\sim 1/2$  of it. This filter  
will block 2<sup>nd</sup> order  
(shorter than 700nm).



# Combined UV-Vis-NIR Channel 340nm - 1100nm

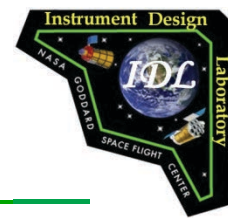

Integrated Design Capability / Instrument Design Laboratory

- Beam transmits through a mechanical slit and is reflected by a dichroic into the UV/Vis spectrometer.
- Spectrometer is a modified Offner design. Mirrors changed to aspheres to improve image quality.
- Dispersion set to 0.4nm/pixel, so image covers 1775 pixels
- Dichroic changed to fold mirror, 220 x 80mm
- Asphere 1: off-axis asphere, 80% light weighted ULE, 530mm x 150mm
- Grating: Convex spherical surface, 128 lines/mm, 200mm x 80mm
- Asphere 2: off-axis asphere, 80% light weighted ULE, 290mm x 200mm
- Fold mirror: required for packaging, ULE, 90mm x 116mm
- All mirrors have protected silver coating
- Performance is quite good from 340nm to 900nm. Performance degrades beyond 900nm.

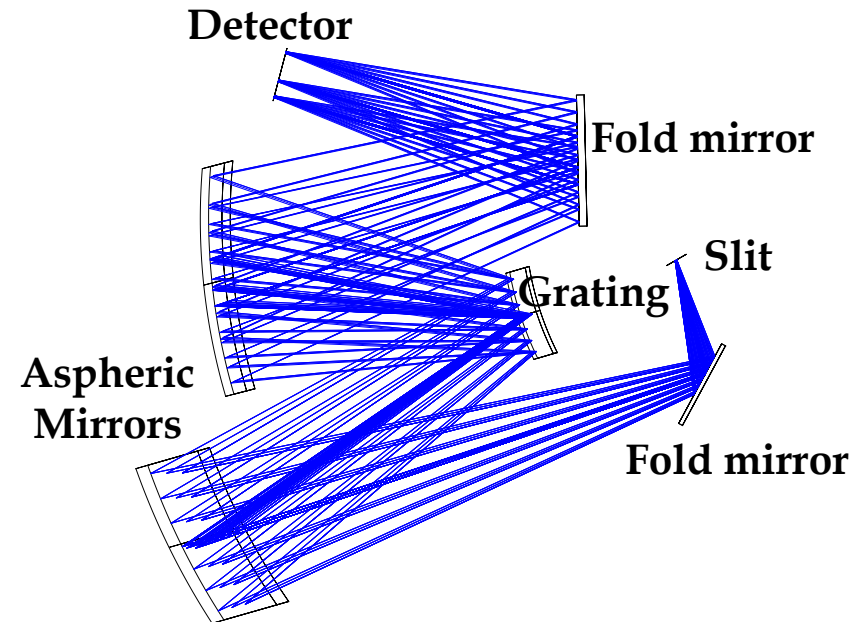

# Combined UV-Vis-NIR Channel Spot Diagrams



Integrated Design Capability / Instrument Design Laboratory

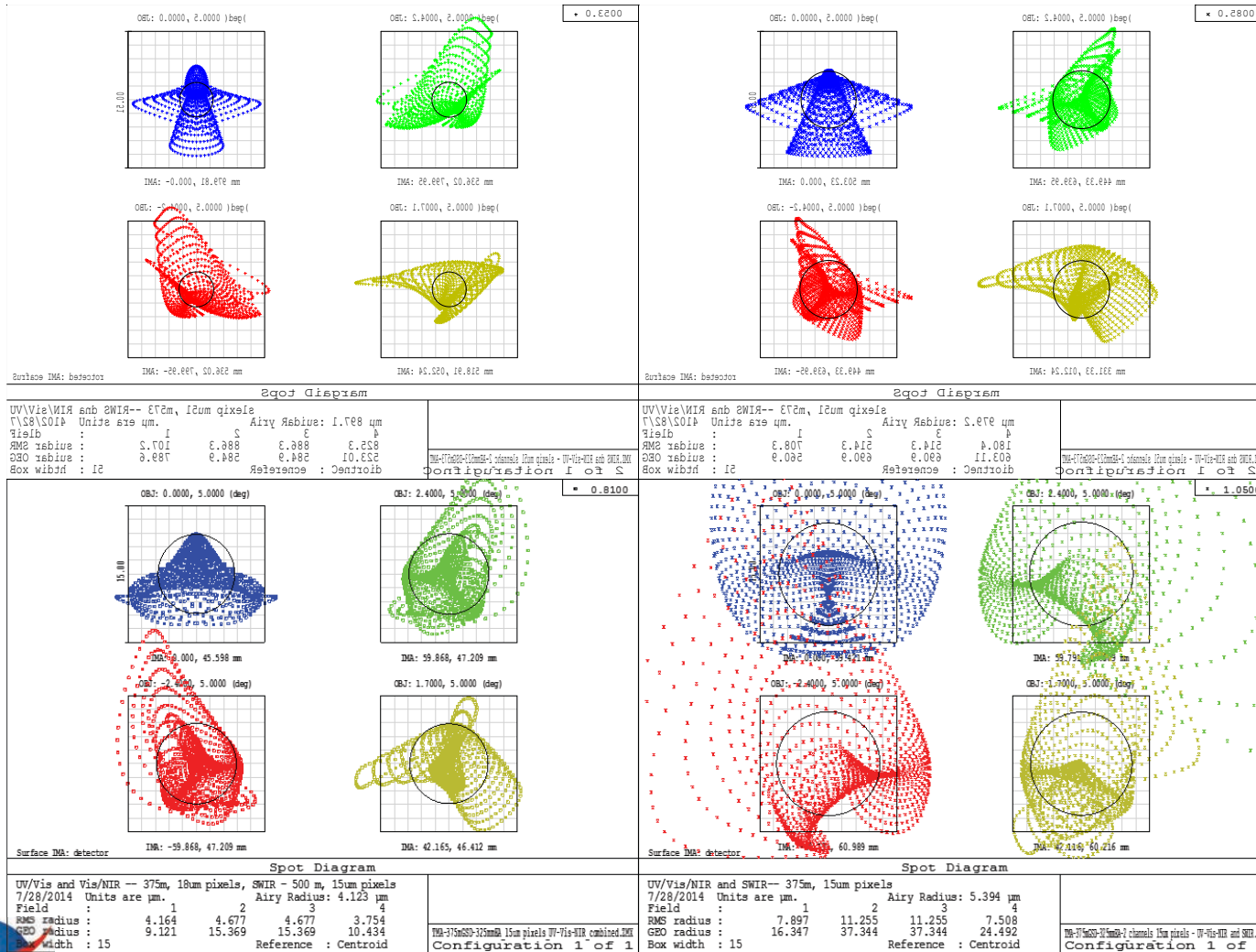

**Note: Spot diagrams correspond to 1 pixel. May be able to aggregate pixels at 1020 to improve performance.**





# Combined UV-Vis-NIR Channel Ensquared Energy

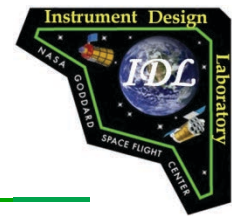

Integrated Design Capability / Instrument Design Laboratory

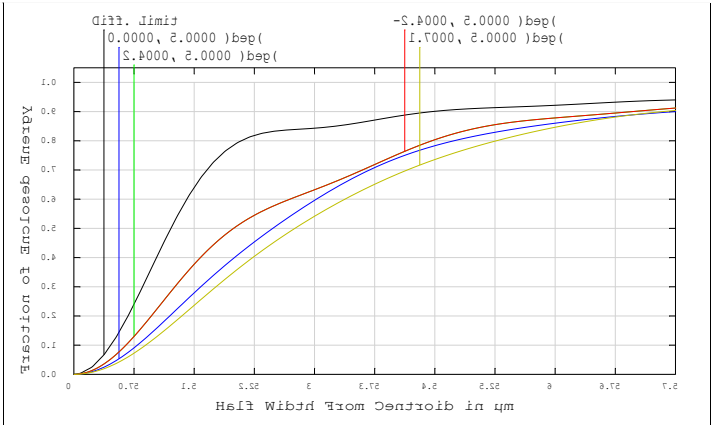
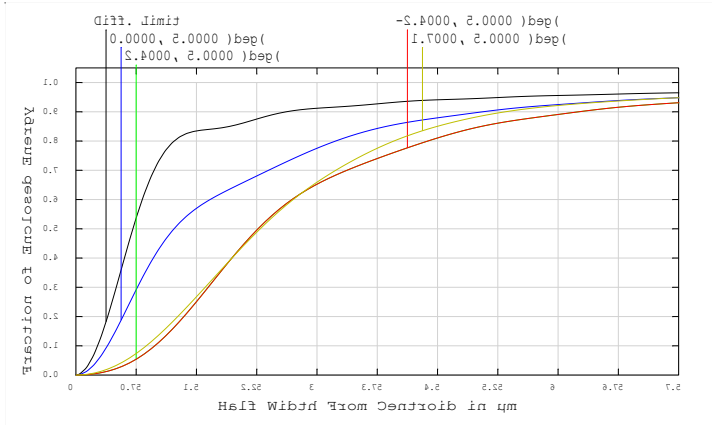

UV/Vis and Vis/NIR -- 375m, 18um pixels, SWIR - 500 m, 15um pixels  
7/28/2014  
Wavelength: 0.810000 um  
Surface: Image (detector)

UV/Vis and Vis/NIR -- 375m, 18um pixels, SWIR - 500 m, 15um pixels  
7/28/2014  
Wavelength: 0.810000 um  
Surface: Image (detector)

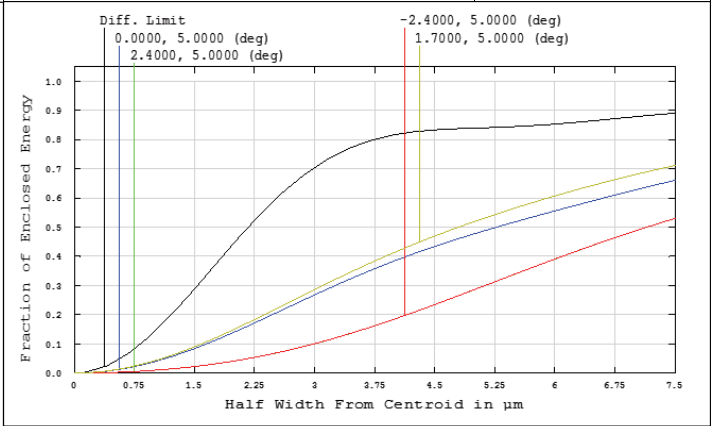
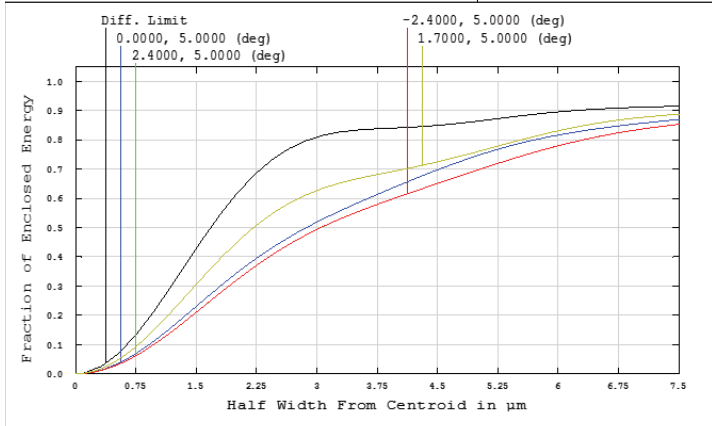

UV/Vis and Vis/NIR -- 375m, 18um pixels, SWIR - 500 m, 15um pixels  
7/28/2014  
Wavelength: 0.810000 um  
Surface: Image (detector)

UV/Vis and Vis/NIR -- 375m, 18um pixels, SWIR - 500 m, 15um pixels  
7/28/2014  
Wavelength: 1.050000 um  
Surface: Image (detector)

**Note: Half width of 7.5  $\mu$  m corresponds to 1 pixel. May be able to aggregate pixels at 1020 to improve performance.**



# Diffuser

---

## Integrated Design Capability / Instrument Design Laboratory

- At position of the diffuser, the beam is 420mm x 355mm - this does not include the +/--scan of the mirror
- Including the increase in size due to scan of the beam, the total size of diffuser will be 600mm in diameter
- Diffuser specification:
  - 600mm in diameter, 10mm thick
  - First is ground surface fused silica
  - Second is ground surface of erbium doped fused silica
- If the sun were only viewed at one angle, the diffuser could get smaller. It would be on the order of 450mm in diameter. The clear opening would still have to be 600 mm in diameter. A 450mm diameter diffuser would weigh 3.5kg for a savings of 2.7kg for each diffuser.

# Optics Specifications

## Integrated Design Capability / Instrument Design Laboratory

Assembly	Optic	Material	Material Density $\text{g}\cdot\text{cm}^{-3}$	Dimensions	Calculated Weight (no light weighting)	Light Weighting	Final Weight
Scan Mirror	Scan Mirror	Beryllium	1.85	860 x 420 x	7.1	25g/cm <sup>3</sup>	7.1
Telescope	Primary	ULE	2.21	620 x 380 x 65	33.9	80%	6.78
Telescope	Secondary	ULE	2.21	160 x 60 x 20	0.4		0.4
Telescope	Tertiary	ULE	2.21	540 x 240 x 60	17.2	80%	3.44
Telescope	FSM	Beryllium	2.21	120 circular x 12	0.03		0.029
Telescope	SWIR Dichroic	Fused Silica	2.2	220 x 80 x 18	0.70		0.70
Telescope	Slit	Silicon	2.33	120 x 12 x 1	0.01		0.01
UV/Vis	Dichroic (reflects short of 600nm)	Fused Silica	2.2	220 x 80 x 18	0.70		0.70
UV/Vis	Aspheric 1	ULE	2.21	530 x 150 x 53	9.3	80%	1.86
UV/Vis	Grating	ULE	2.21	230 x 85 x 23	0.98		0.98
UV/Vis	Aspheric 2	ULE	2.21	420 x 220 x 42	8.34	80%	1.668
UV/Vis	Fold	ULE	2.21	190 x 128 x 19	1.02		1.02

**NOTE: Depolarizer between secondary and tertiary mirror not shown but is in the MEL.**



# Optics Specifications (continued)

## Integrated Design Capability / Instrument Design Laboratory

Assembly	Optic	Material	Material Density g·cm <sup>-3</sup>	Dimensions	Calculated Weight (no light weighting)	Light Weighting	Final Weight
Vis/NIR	Aspheric 1	ULE	2.21	530 x 150 x 53	9.3	80%	1.86
Vis/NIR	Grating	ULE	2.21	230 x 85 x 23	0.98		0.98
Vis/NIR	Aspheric 2	ULE	2.21	420 x 220 x 42	8.34	80%	1.668
Vis/NIR	Fold	ULE	2.21	190 x 128 x 19	1.02		1.02
SWIR	Aspheric 1	ULE	2.21	530 x 150 x 53	9.3	80%	1.86
SWIR	Grating	ULE	2.21	230 x 85 x 23	0.98		0.98
SWIR	Aspheric 2	ULE	2.21	420 x 220 x 42	8.34	80%	1.668
SWIR	Fold	ULE	2.21	190 x 128 x 19	1.02		1.02
Diffuser Assembly	Diffuser_1	Fused Silica	2.2	600 diam x 10 thick	6.2		6.2
Diffuser Assembly	Diffuser_2	Fused Silica doped with rare earth element Erbium	2.2	600 diam x 10 thick	6.2		6.2
TOTAL							48.143

# Roll Camera

Integrated Design Capability / Instrument Design Laboratory

- Two identical roll cameras
- 100 mm entrance aperture
- Focal length of 525mm (F/5.25)
- 375m GSD for each pixel
- 4k x 4k array of 5.5 $\mu$ m pixels, corresponding to 2.4 degree full field of view
- Wavelength 500nm
- Lens assembly to detector is 400mm long
- All spherical surfaces

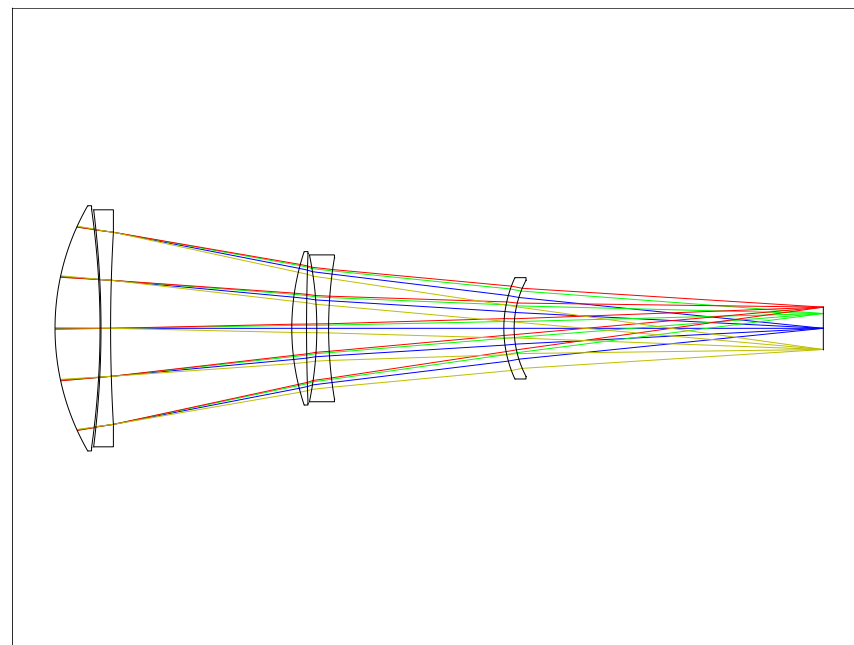

# Performance of Roll Camera

Integrated Design Capability / Instrument Design Laboratory

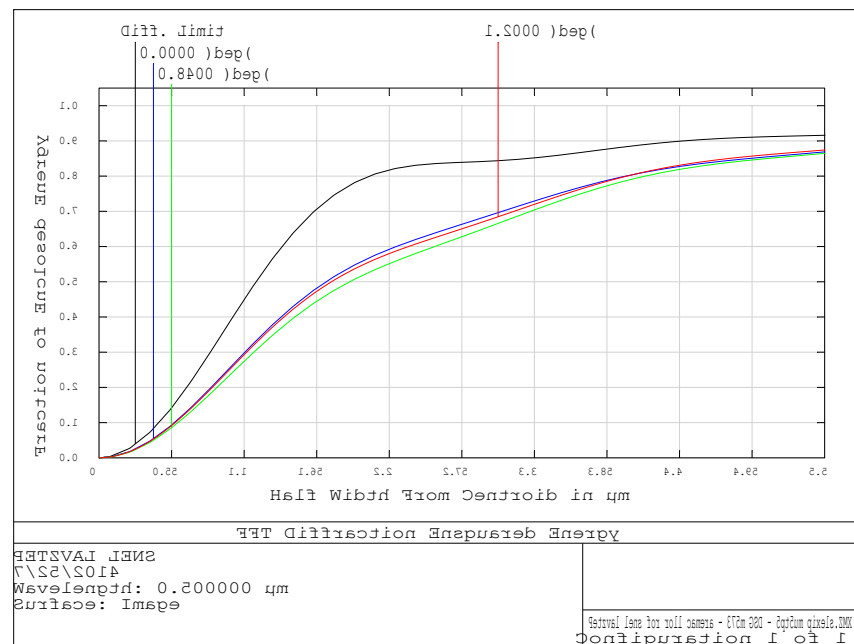
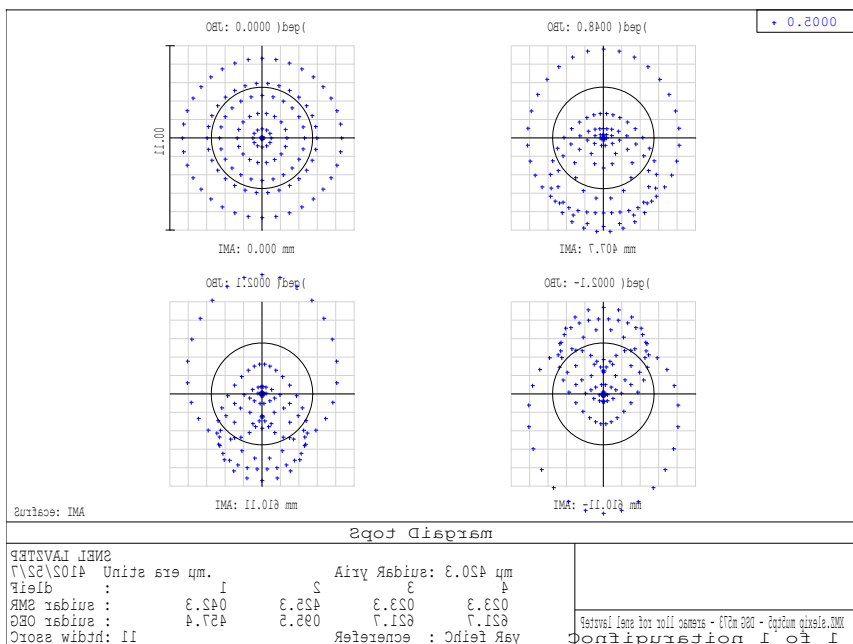

- Spot diagrams correspond to 2x2 pixels. Ensquared energy curve 5.5 $\mu$ m corresponds to 2 pixels.
- Airy disk diameter is 6 $\mu$ m, larger than a pixel. This might require diffraction limited performance.
- Expect 4:1 contrast from ground to water. Image quality does not need to be diffraction limited.
- Perhaps we should change center wavelength to 400nm to reduce Airy disk diameter to 4.8  $\mu$ m.

# Roll Camera

## Integrated Design Capability / Instrument Design Laboratory

Assembly	Optic	Material	Material Density g·cm <sup>-3</sup>	Volume (cc)	Weight (g)
Roll Camera	Lens 1	BALKN3	2.61	163.9	428
Roll Camera	Lens 2	F4	3.58	94.3	338
Roll Camera	Lens 3	BK7	2.51	24.5	62
Roll Camera	Lens 4	F2	3.60	44.4	160
Roll Camera	Lens 5	F2	3.60	12.8	46
TOTAL					1034

# Optics Only Volume for Different Cases (not including scan)

Integrated Design Capability / Instrument Design Laboratory

**Baseline  
Footprint is  
1110mm x 1650mm**

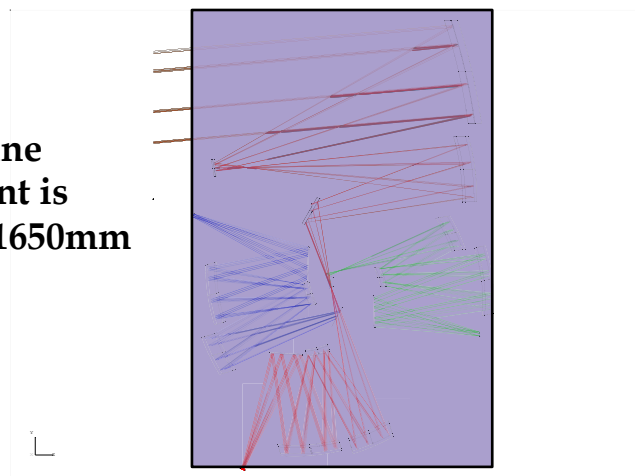

**Case 2  
Merge UV/Vis/NIR  
1050mm x 1295mm**

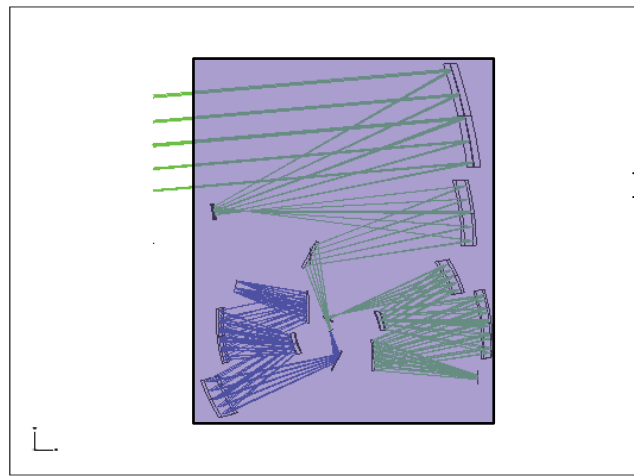

**Case 1  
No SWIR  
1020mm X 1295mm**

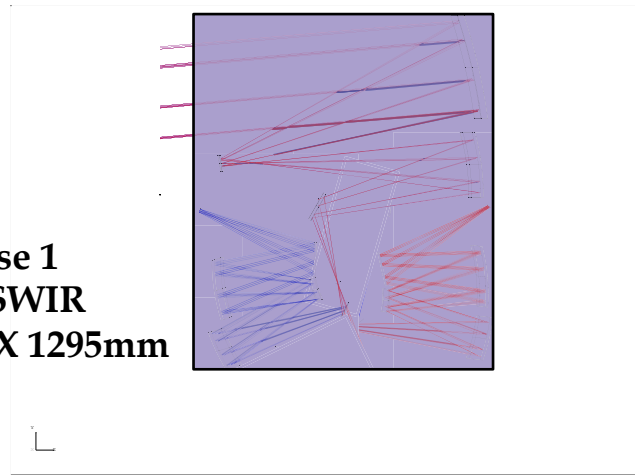

**Case 3  
Merge without SWIR  
1020mm x 1295mm**

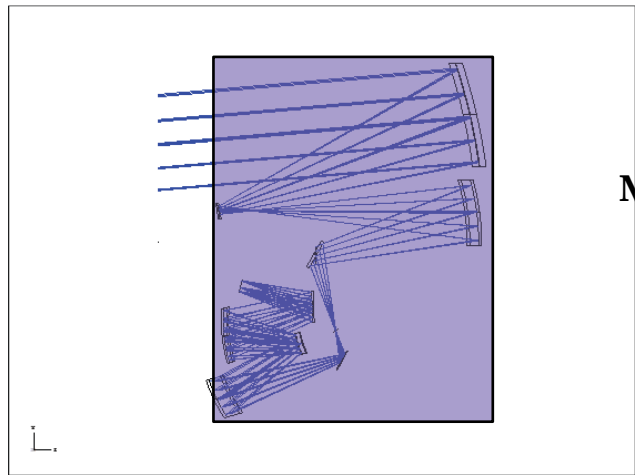



# Baffles

Integrated Design Capability / Instrument Design Laboratory

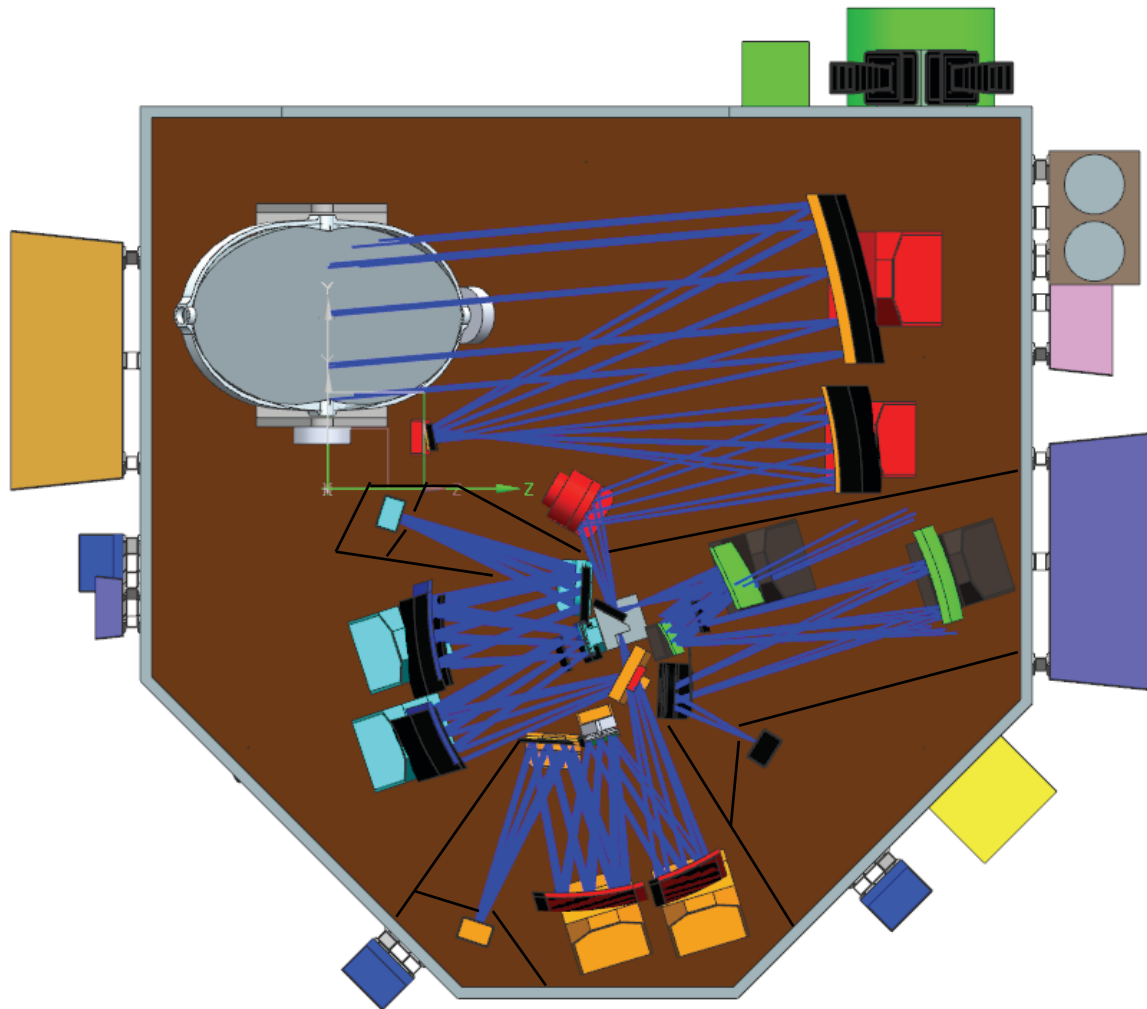

Too crowded to fit many baffles. Limit view of each detector by creating a limiting aperture around incoming beam.

# Future Recommendations

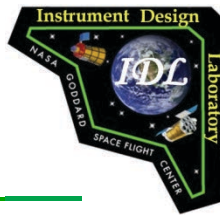

## Integrated Design Capability / Instrument Design Laboratory

- **Polarization sensitivity requirement is <1%**
  - We cannot currently meet this specification
  - Scan mirror out front rotates from  $45^{\circ} \pm 4.75^{\circ}$  in N-S and  $0^{\circ} \pm 5.2^{\circ}$  E-W
    - MODIS asked coating vendor to control difference between s- and p- components and still had 3% difference (from Waluschka data).
    - Primary and secondary mirror incidence angles range from  $2^{\circ}$  to  $18^{\circ}$  which might contribute up to 1%, each.
    - Current orientation of scan mirror and telescope mirrors may cancel some of the polarization effect. Detailed analysis should be done to understand predicted performance. We may be in the 1.5 - 2% range.
  - Depolarizer should be added to telescope design. Suggest using a double-wedged depolarizer near the telescope focus. Again, need detailed analysis to predict performance.
- **Each spectrometer packaging is very tight.**
  - Optics need to be re-optimized to space them a little farther apart.
  - Currently no room for baffles.
- **Combined UV-Vis-NIR channel is an interesting option. Saves volume and complexity. Performance is not as good at long wavelengths.**
  - Model diffraction efficiency more accurately to feed into radiometric model
  - Modify optimization weighting for wavelengths of highest importance.



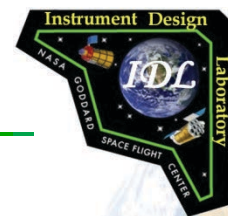

Integrated Design Capability / Instrument Design Laboratory

# **GEO CAPE Wide Angle Spectrometer (WAS)** *~ Concept Presentations ~*

## **Mechanical Systems**

**Mike Clark**

**Greg Bowers**

**Jeff Bolognese**

**Elizabeth Matson**

**July 29, 2014**

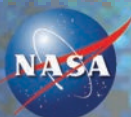

N A S A   G O D D A R D   S P A C E   F L I G H T   C E N T E R



# Requirements

---

## Integrated Design Capability / Instrument Design Laboratory

- **Package the baseline configuration**
  - Telescope, UV/Vis, Vis/NIR, SWIR
  - Scan Mirror, FSM, Diffuser Wheel
  - Electronics, Thermal
- **Package the Delta 1, Delta 2, and Delta 3 configurations**
- **Minimize the distance (< 15 in.) from the digitizer electronics to the detectors**
- **Minimize mass and volume**



# Instrument Overview

Integrated Design Capability / Instrument Design Laboratory

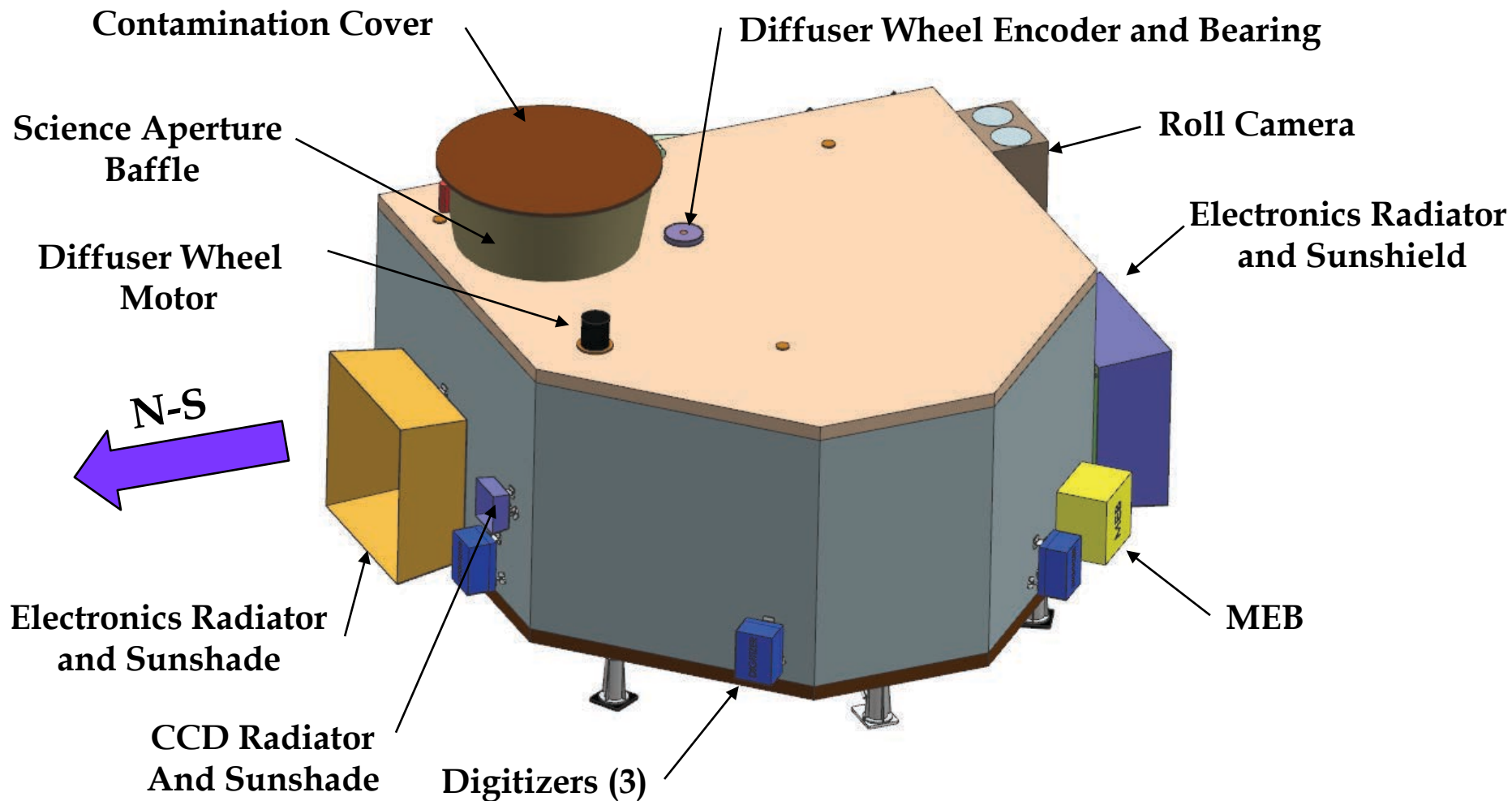

# Instrument Overview

Integrated Design Capability / Instrument Design Laboratory

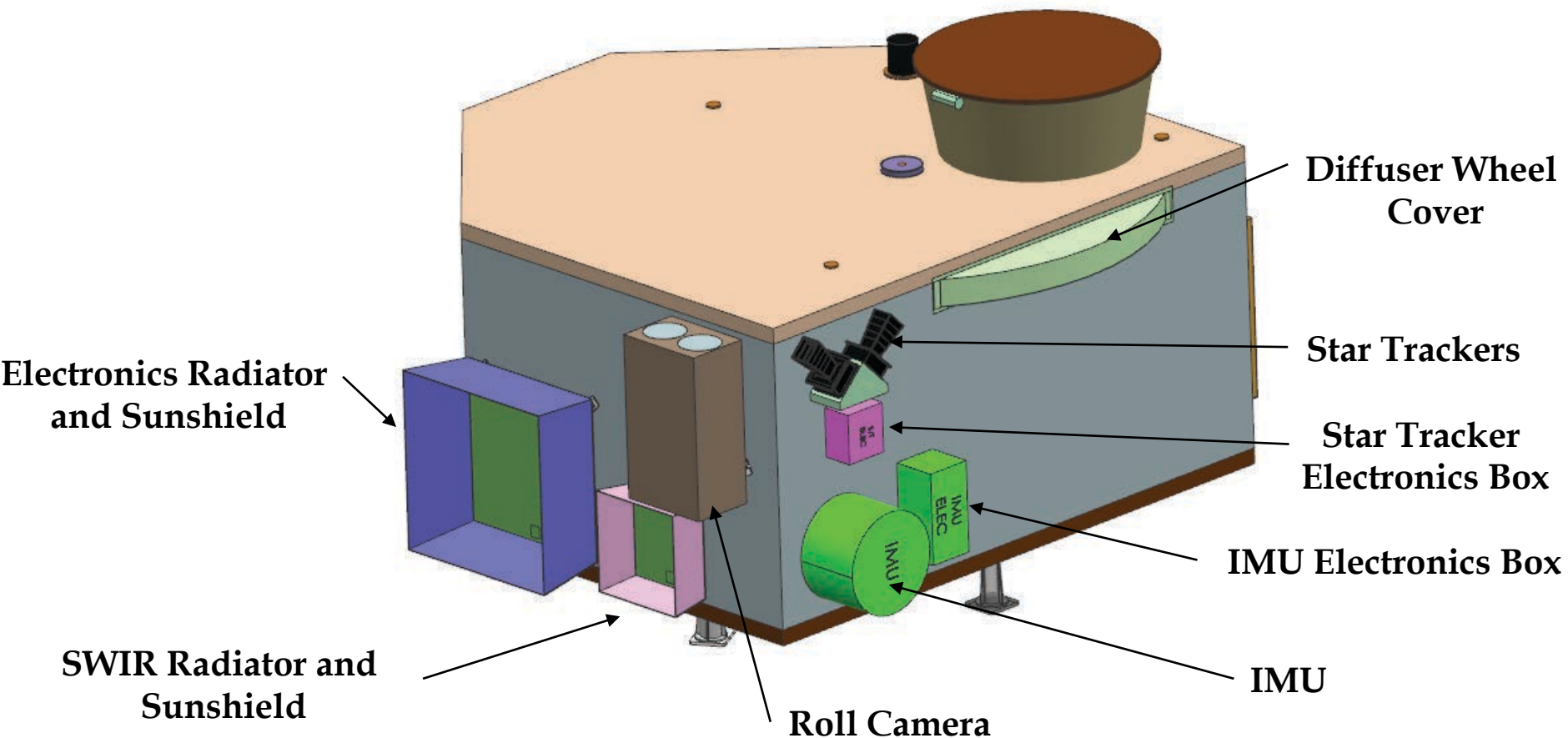

# Science Aperture Baffle & Contamination Cover

Integrated Design Capability / Instrument Design Laboratory

Contamination Cover

Hinge  
(Spring Loaded)

Science Aperture  
Baffle

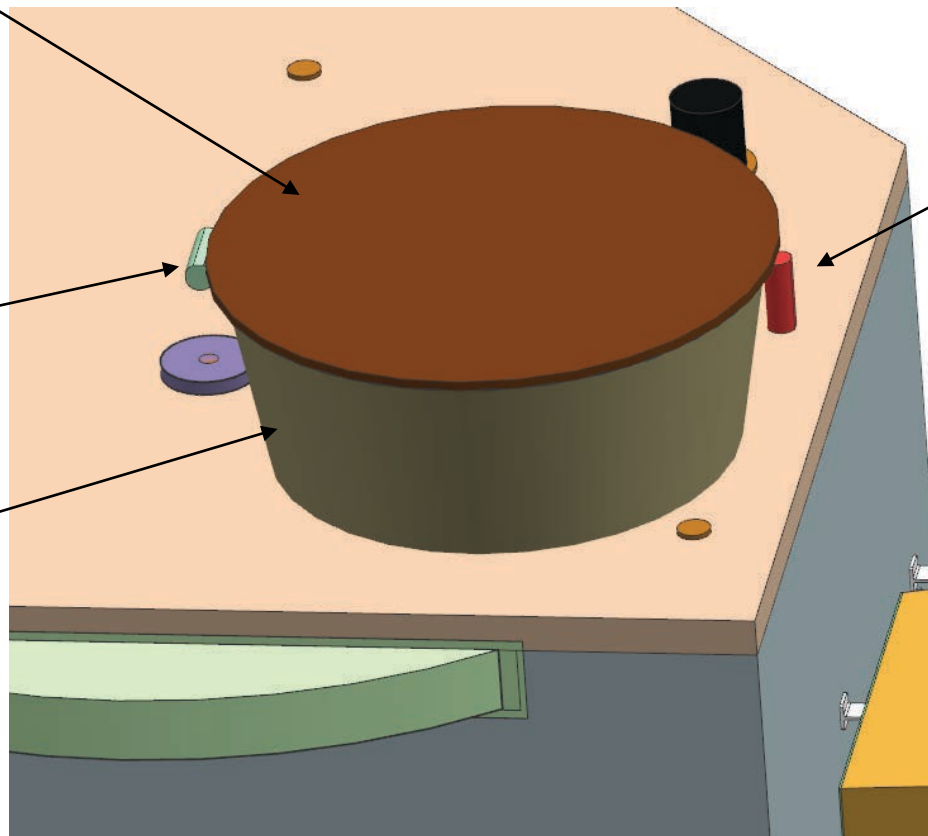

Launch Lock

See Mechanisms Presentation for design details

# Diffuser Wheel

Integrated Design Capability / Instrument Design Laboratory

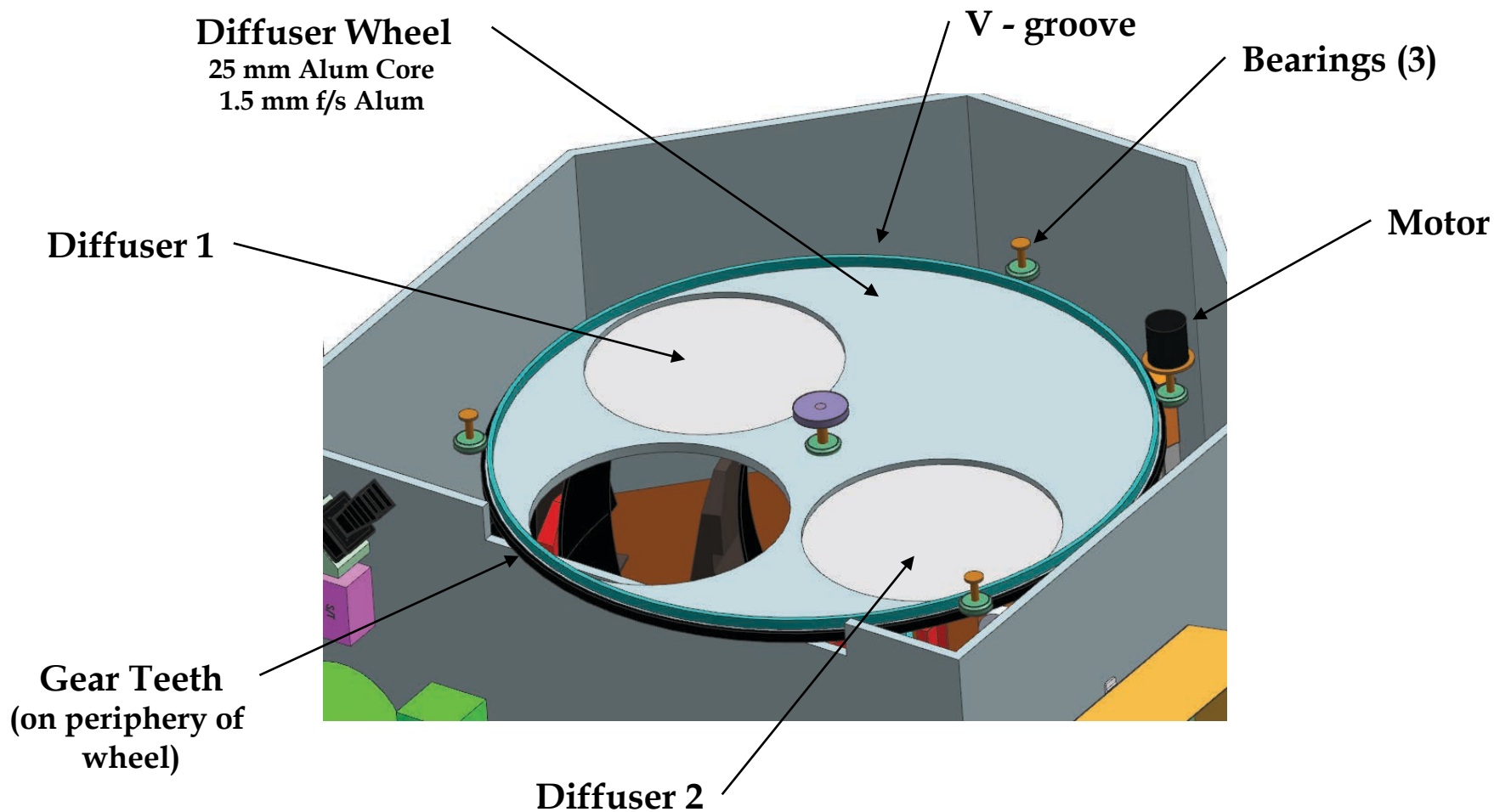

**See Mechanisms Presentation for design details**



# S/C Interface - Roll & Jitter Suppression System

Integrated Design Capability / Instrument Design Laboratory

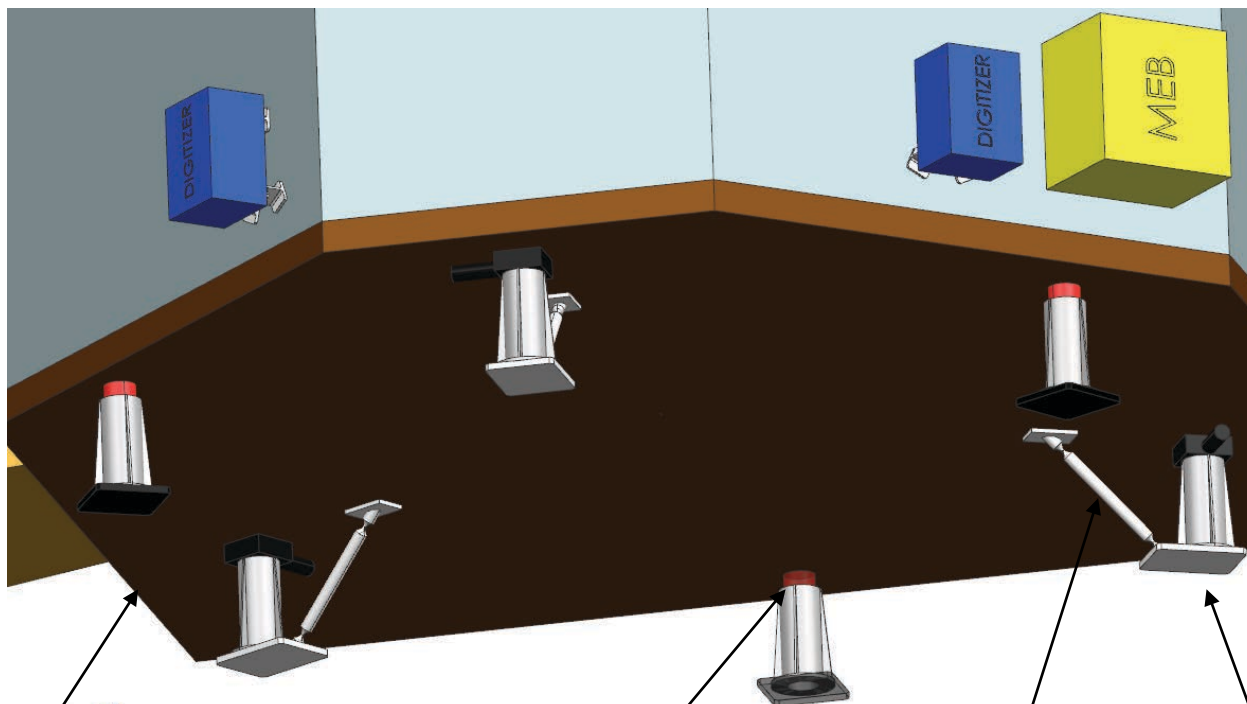

Optical Bench

Voice Coil Actuators (3)

Flexures (3)

S/C Interface (6)

Launch Locks (3)

See Mechanical Presentation for design details

# Structure

Integrated Design Capability / Instrument Design Laboratory

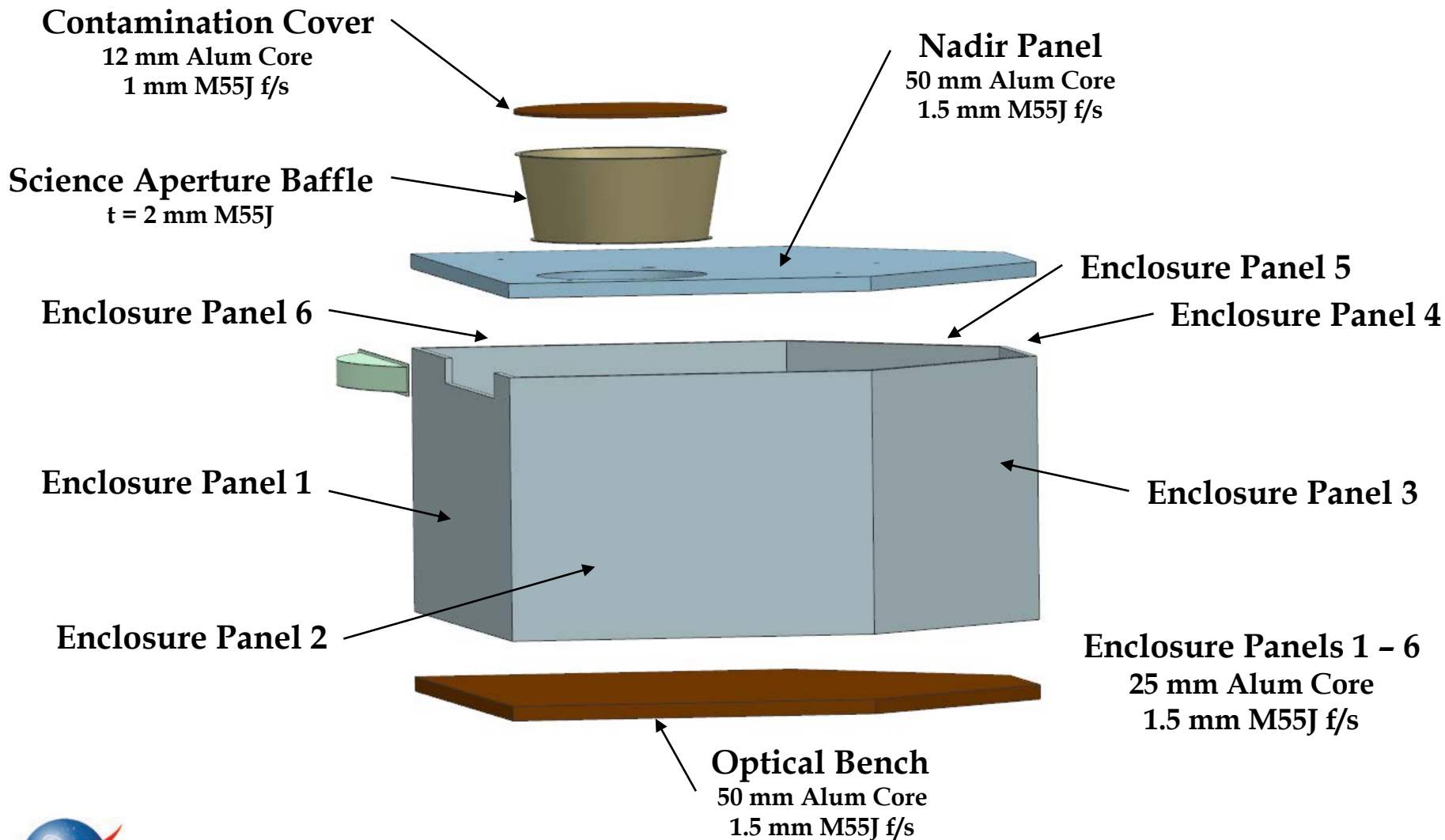

# Optical Assemblies

Integrated Design Capability / Instrument Design Laboratory

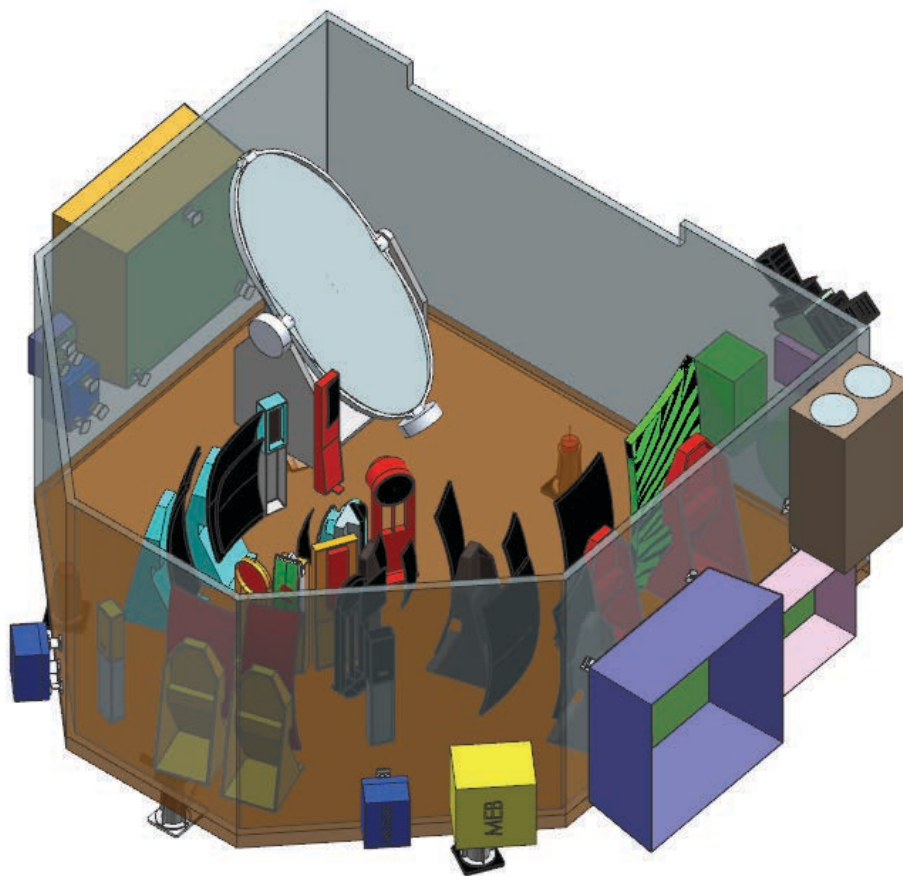

# Optical Assemblies

Integrated Design Capability / Instrument Design Laboratory

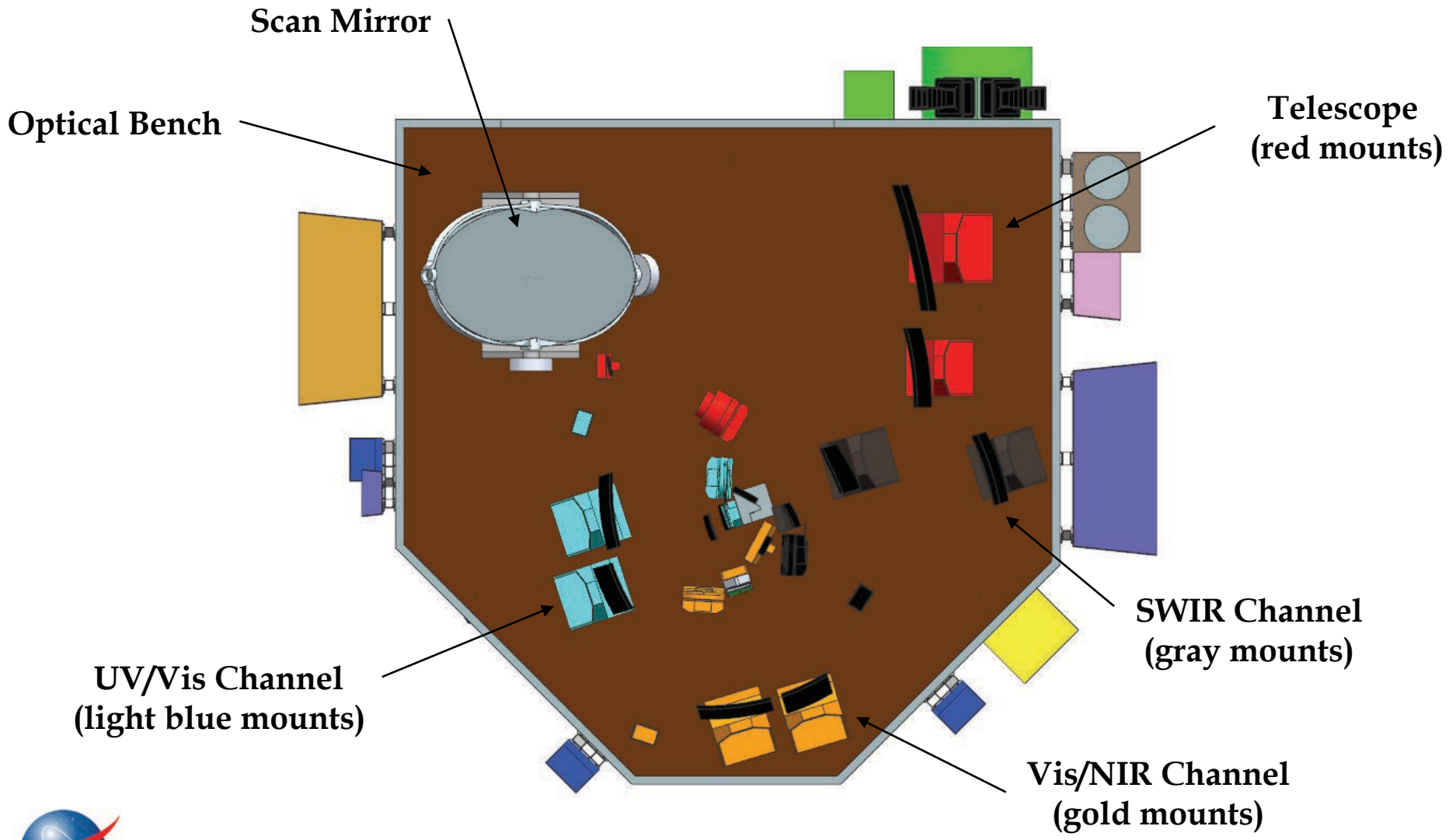

# Optical Assembly - Telescope

Integrated Design Capability / Instrument Design Laboratory

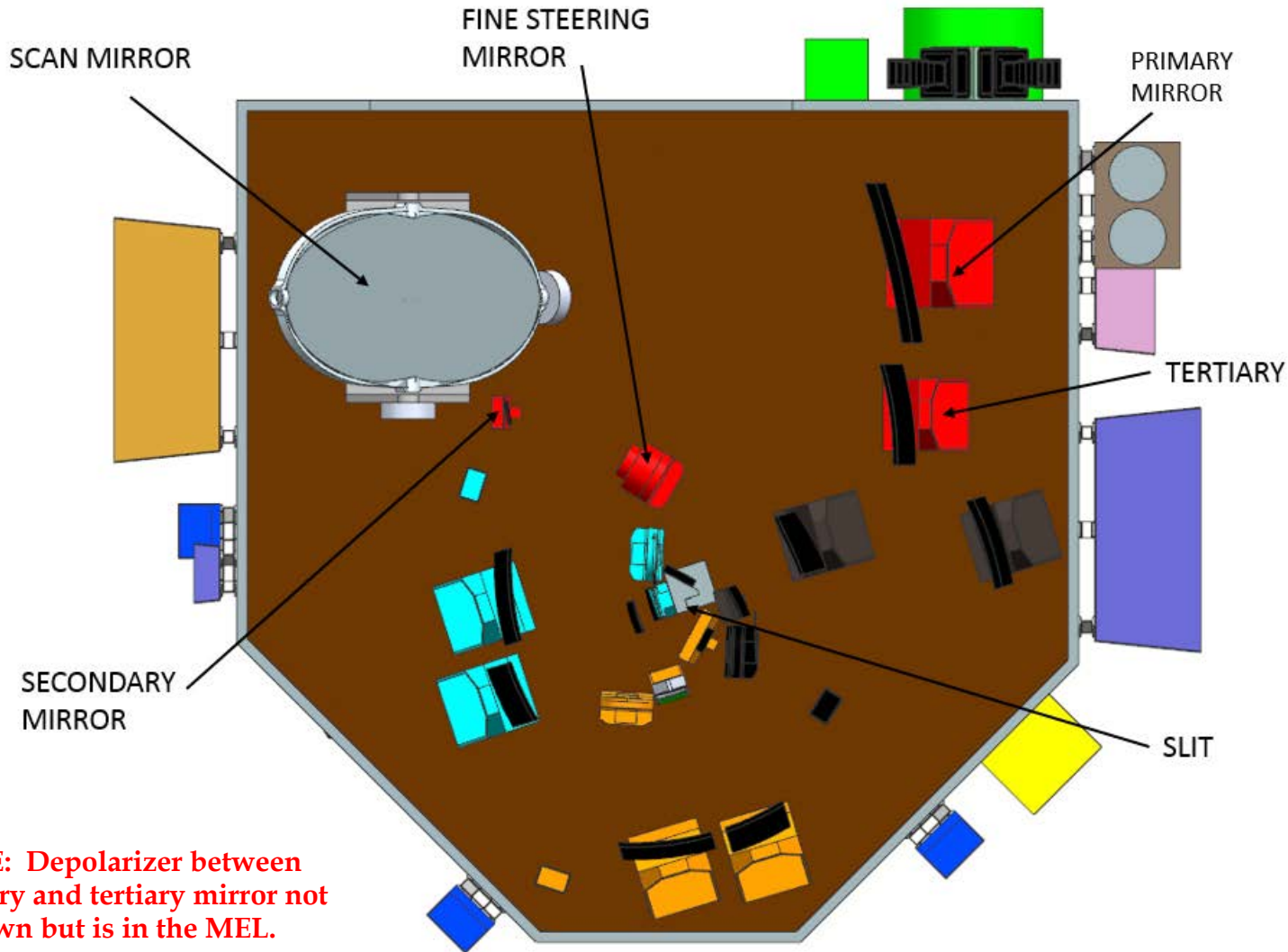

**NOTE: Depolarizer between secondary and tertiary mirror not shown but is in the MEL.**

# Optical Assembly - UV/Vis

Integrated Design Capability / Instrument Design Laboratory

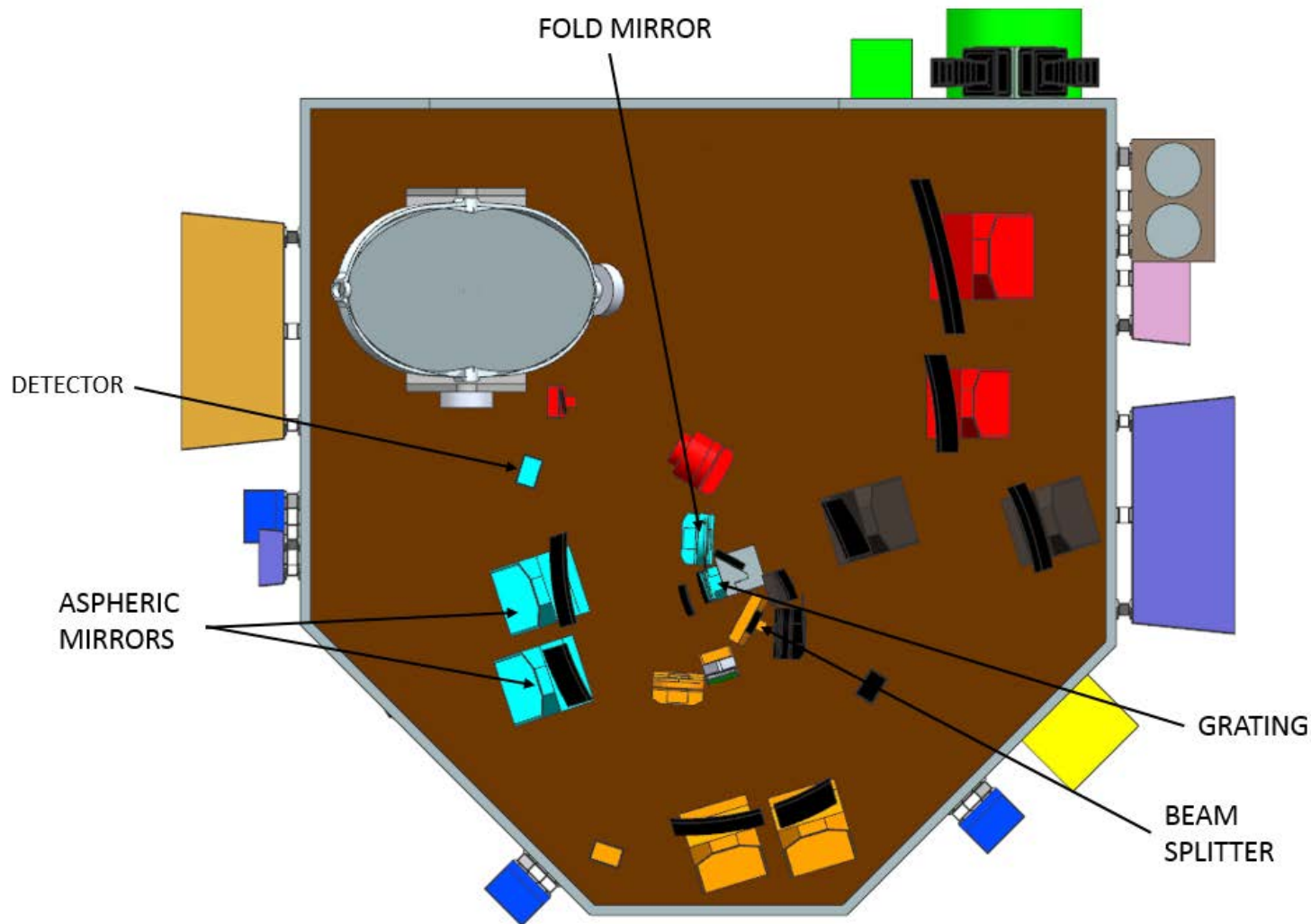

# Optical Assembly - Vis/NIR

Integrated Design Capability / Instrument Design Laboratory

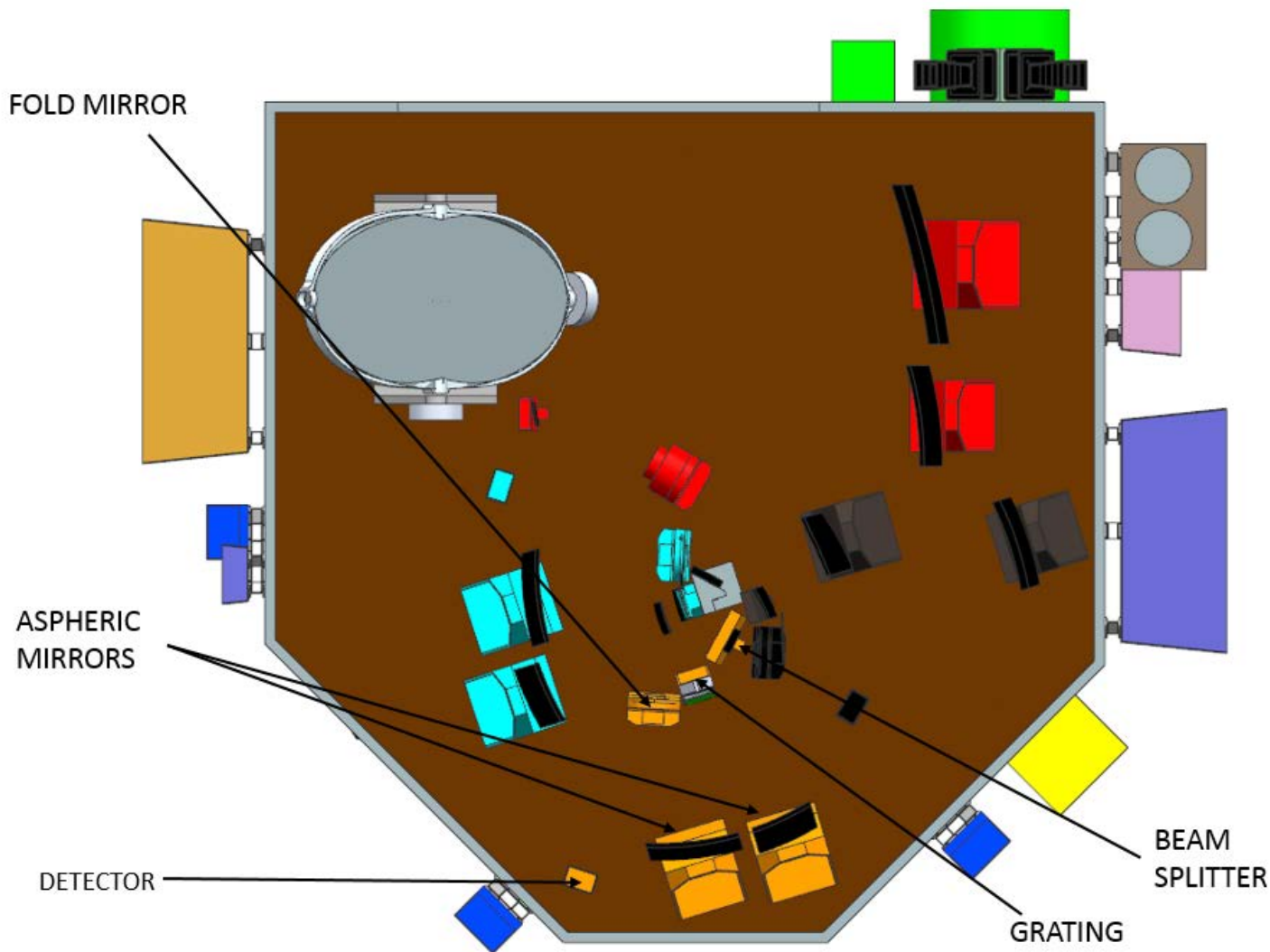

# Optical Assembly - SWIR

Integrated Design Capability / Instrument Design Laboratory

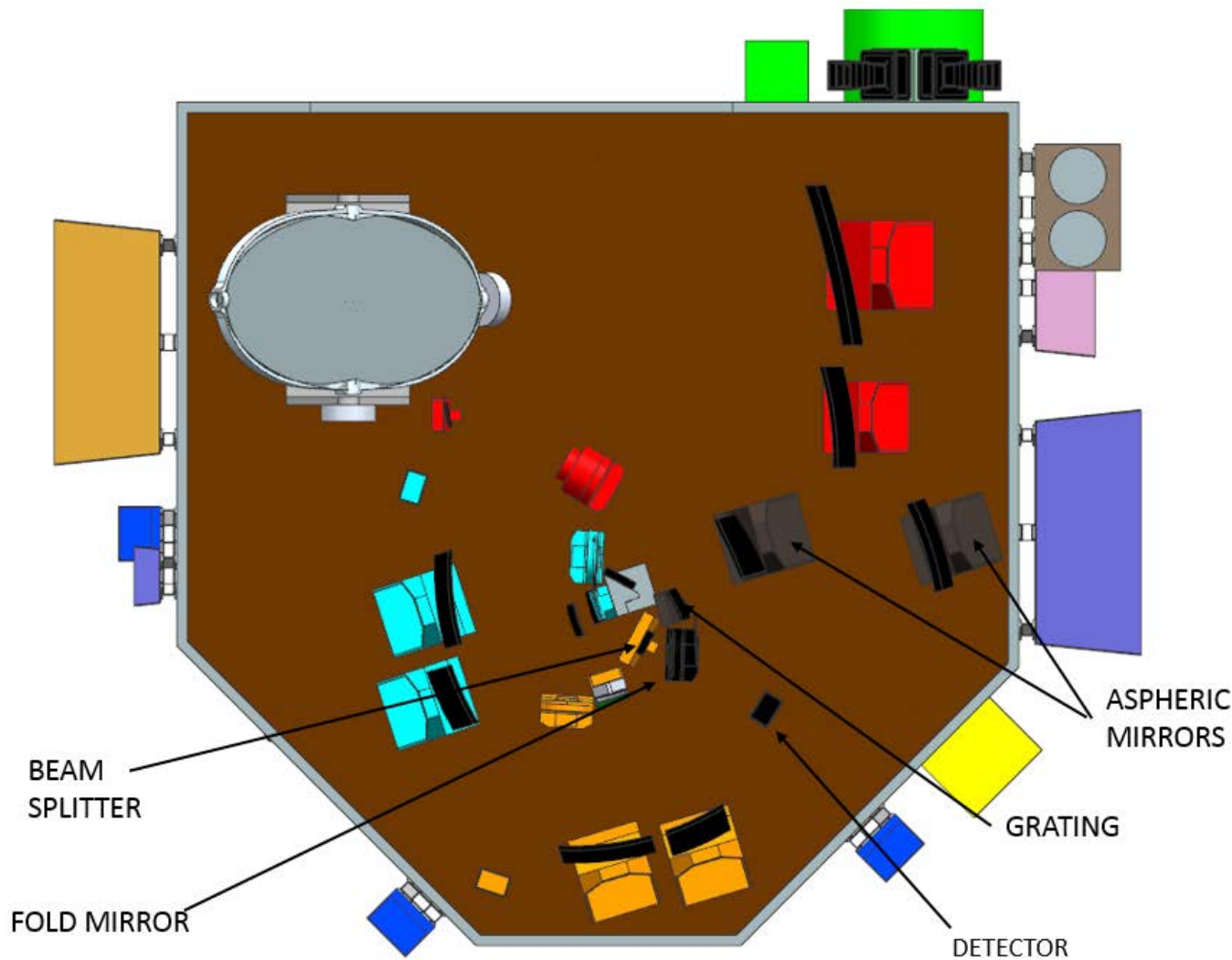



# Optical Assemblies

Integrated Design Capability / Instrument Design Laboratory

Design of the optic mounts will likely be driven by stiffness requirements due to the height of the optical path (or the center of the scan mirror) above the optical bench

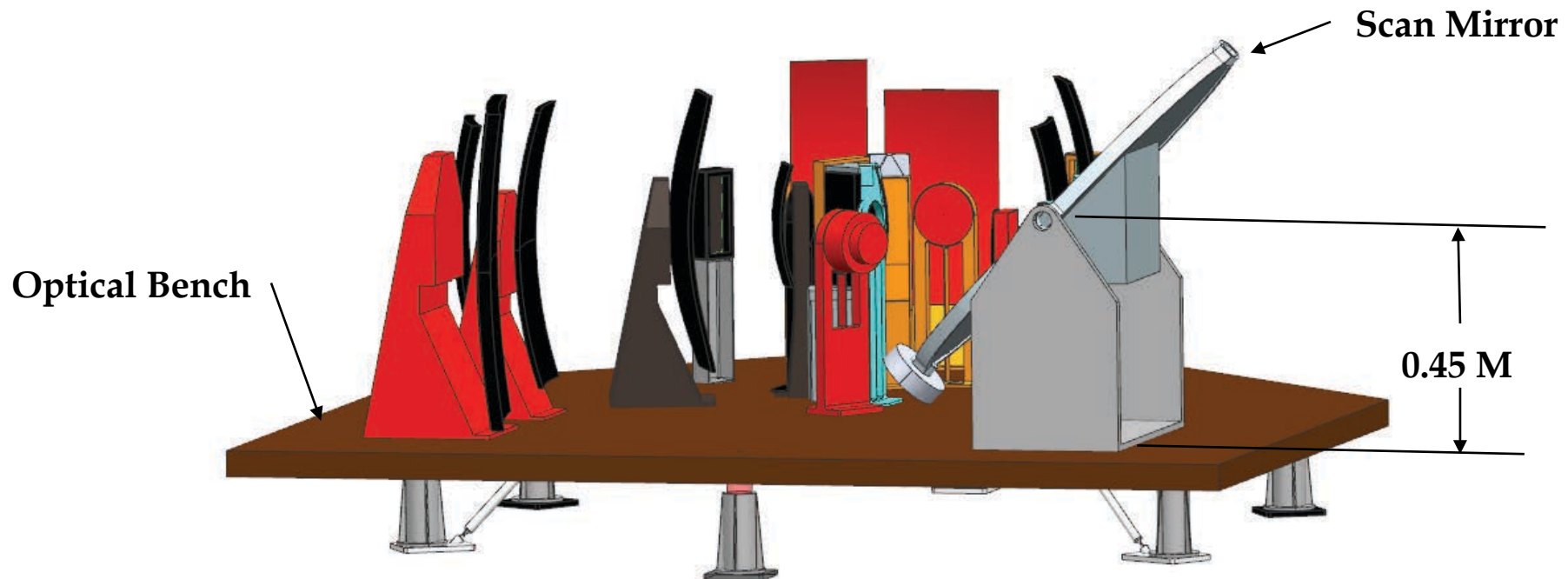

# Scan Mirror

Integrated Design Capability / Instrument Design Laboratory

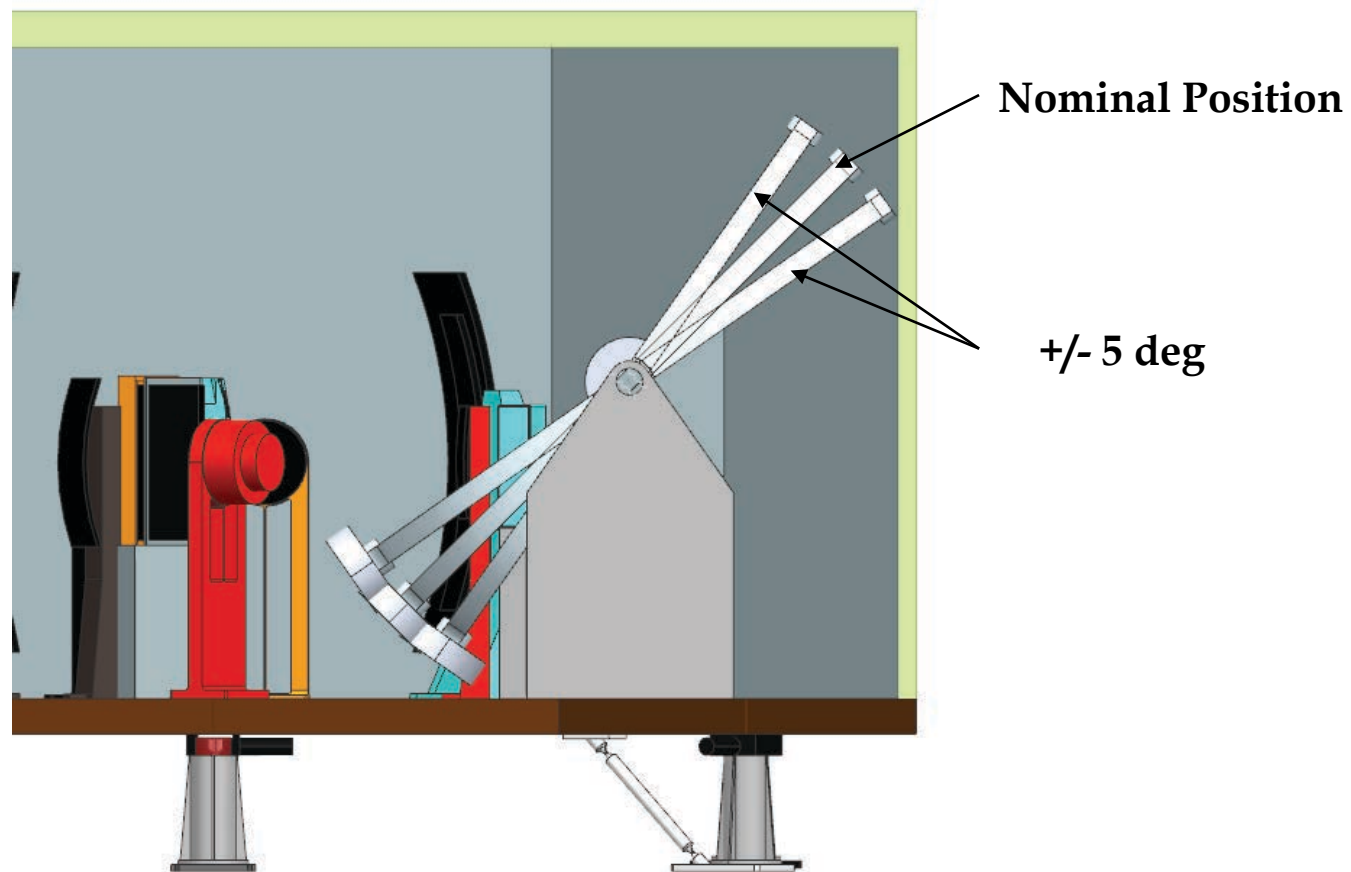

**See Mechanisms Presentation for design details**

# Ray Traces - Baseline Configuration

Integrated Design Capability / Instrument Design Laboratory

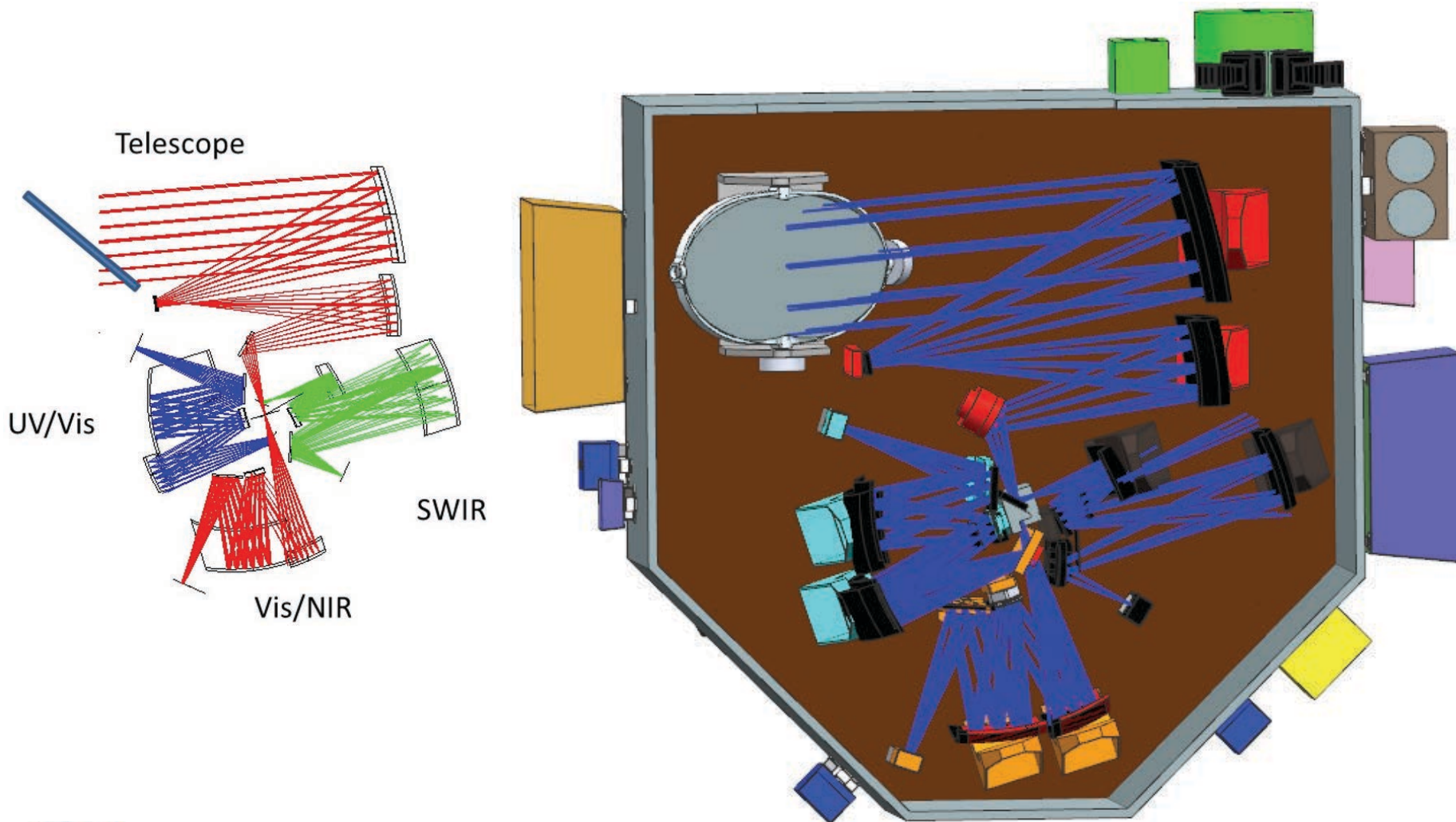

# Optical Configurations

Integrated Design Capability / Instrument Design Laboratory

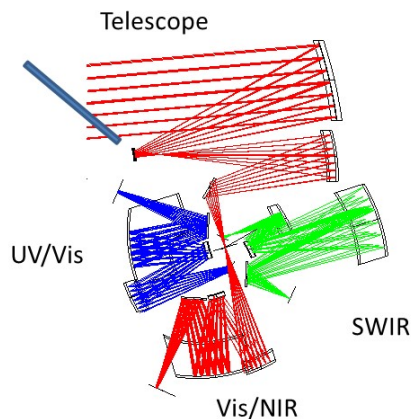

**Baseline**

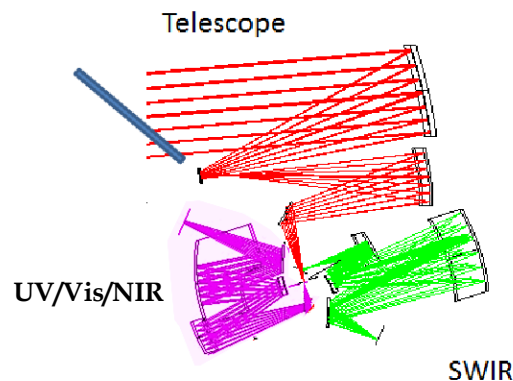

**Delta 2  
Merge UV/Vis/NIR**

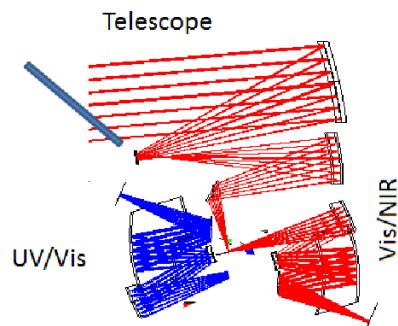

**Delta 1  
no SWIR**

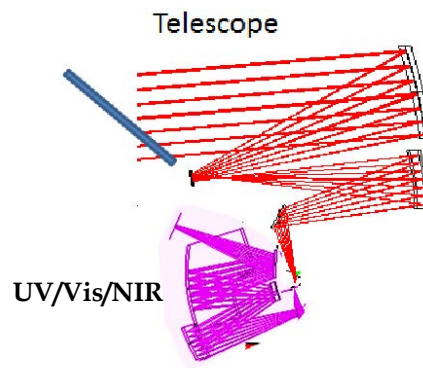

**Delta 3  
Merge without SWIR**

# Optical Configuration - Baseline

Integrated Design Capability / Instrument Design Laboratory

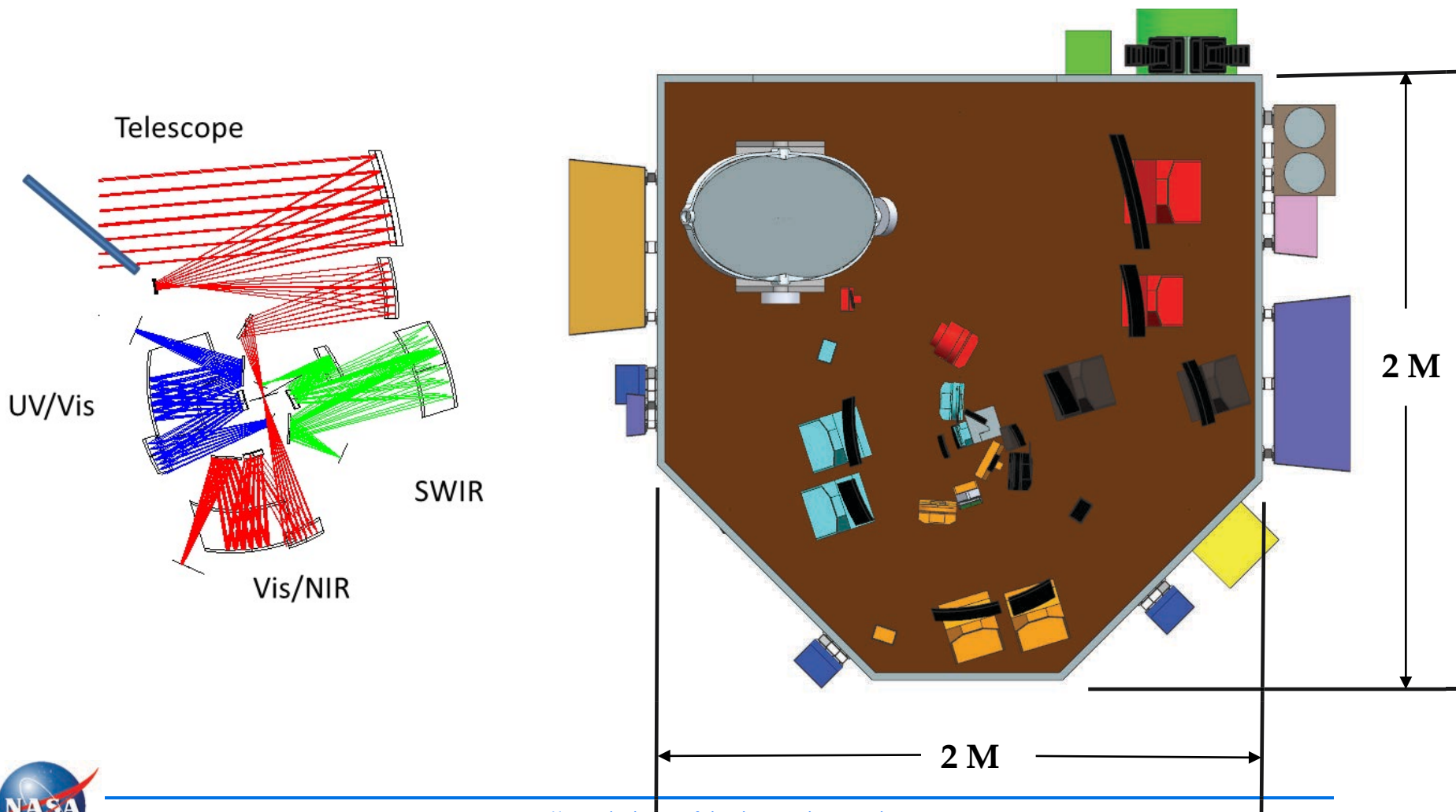

# Dimensions - Baseline

Integrated Design Capability / Instrument Design Laboratory

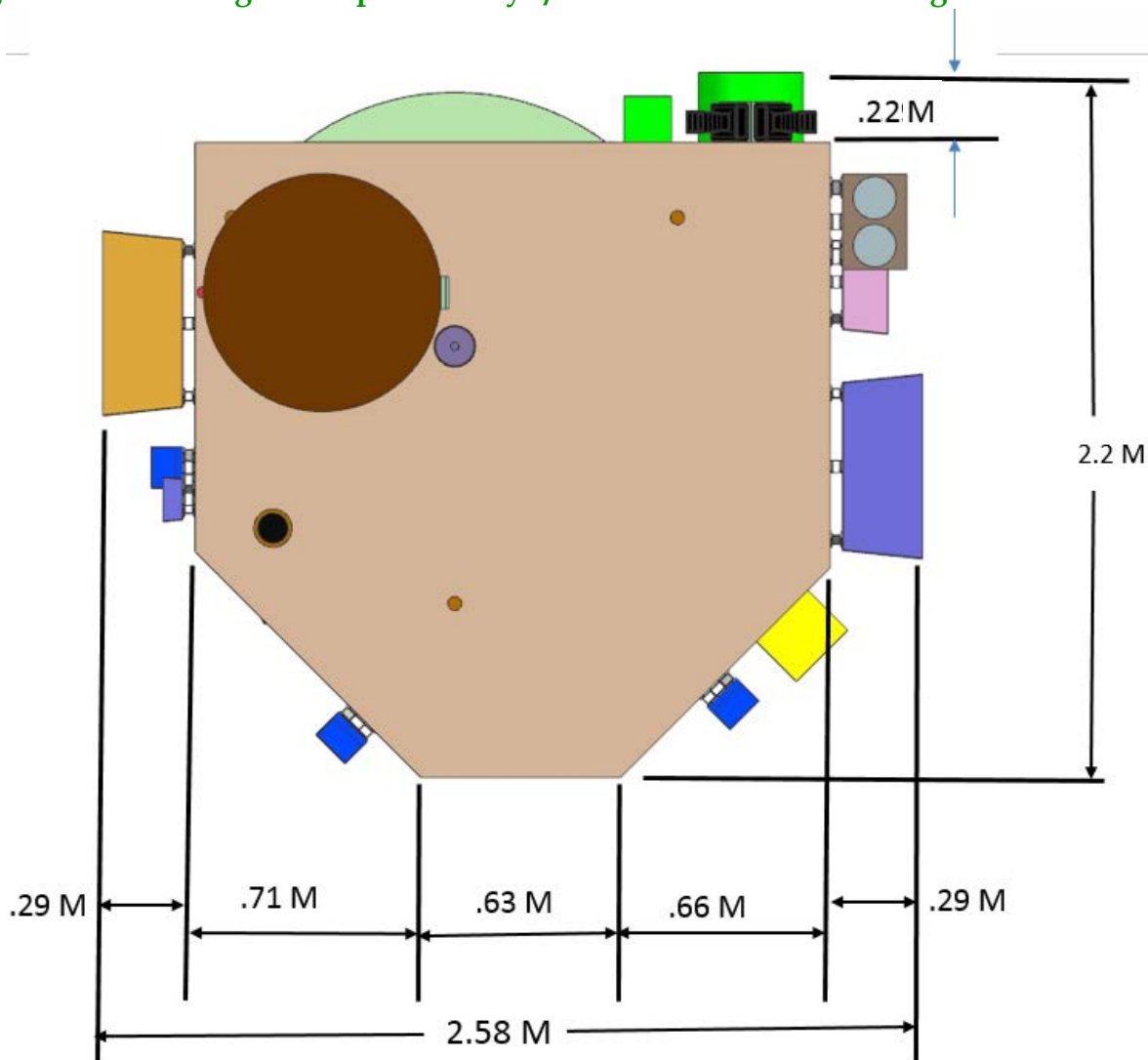

# Dimensions - Baseline

Integrated Design Capability / Instrument Design Laboratory

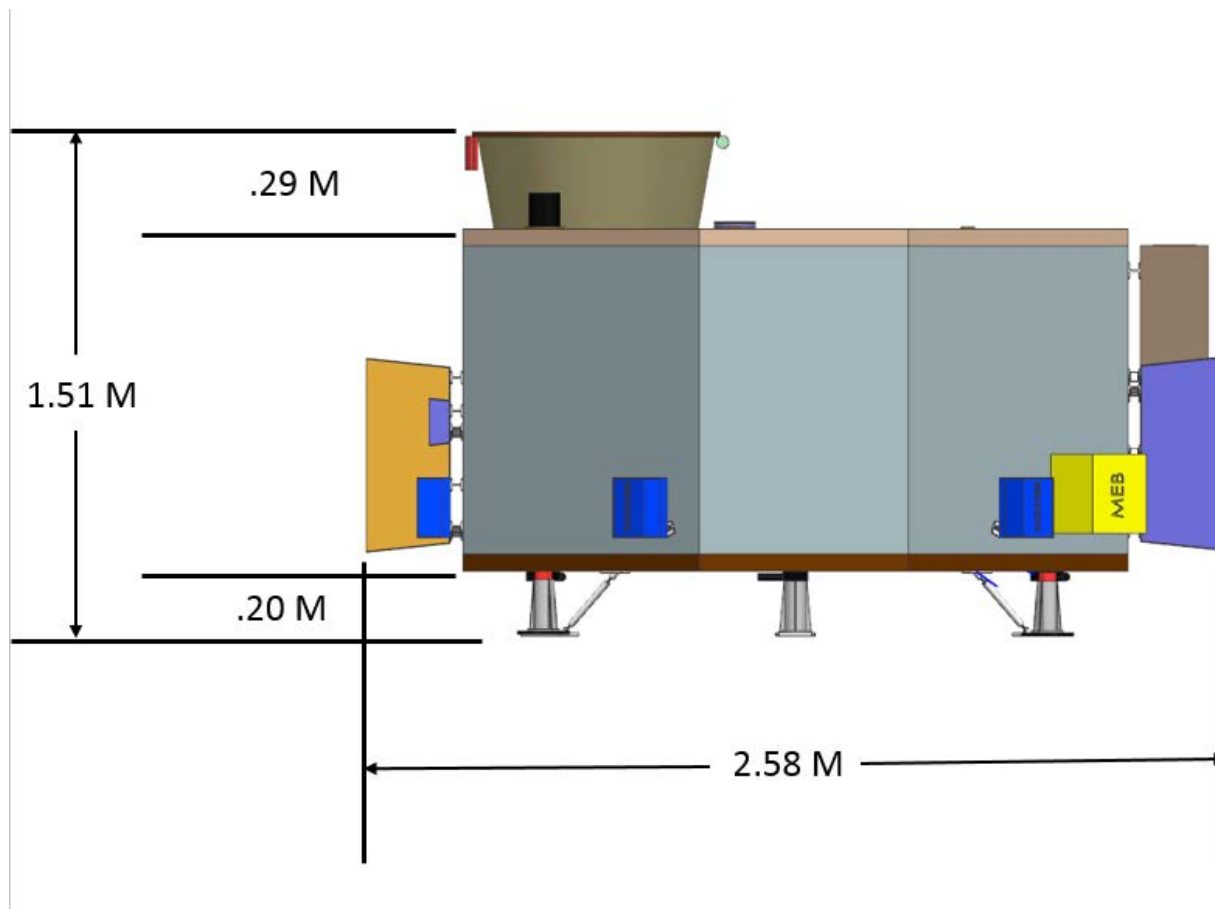

# Optical Configuration - Delta 2

Integrated Design Capability / Instrument Design Laboratory

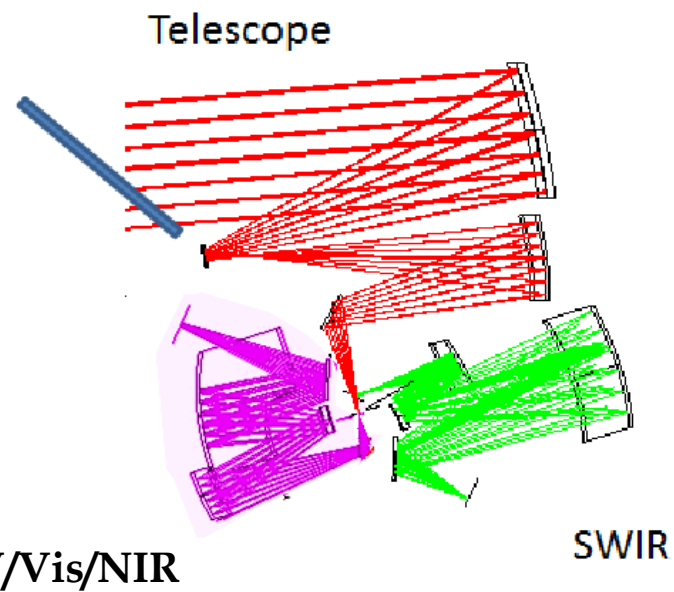
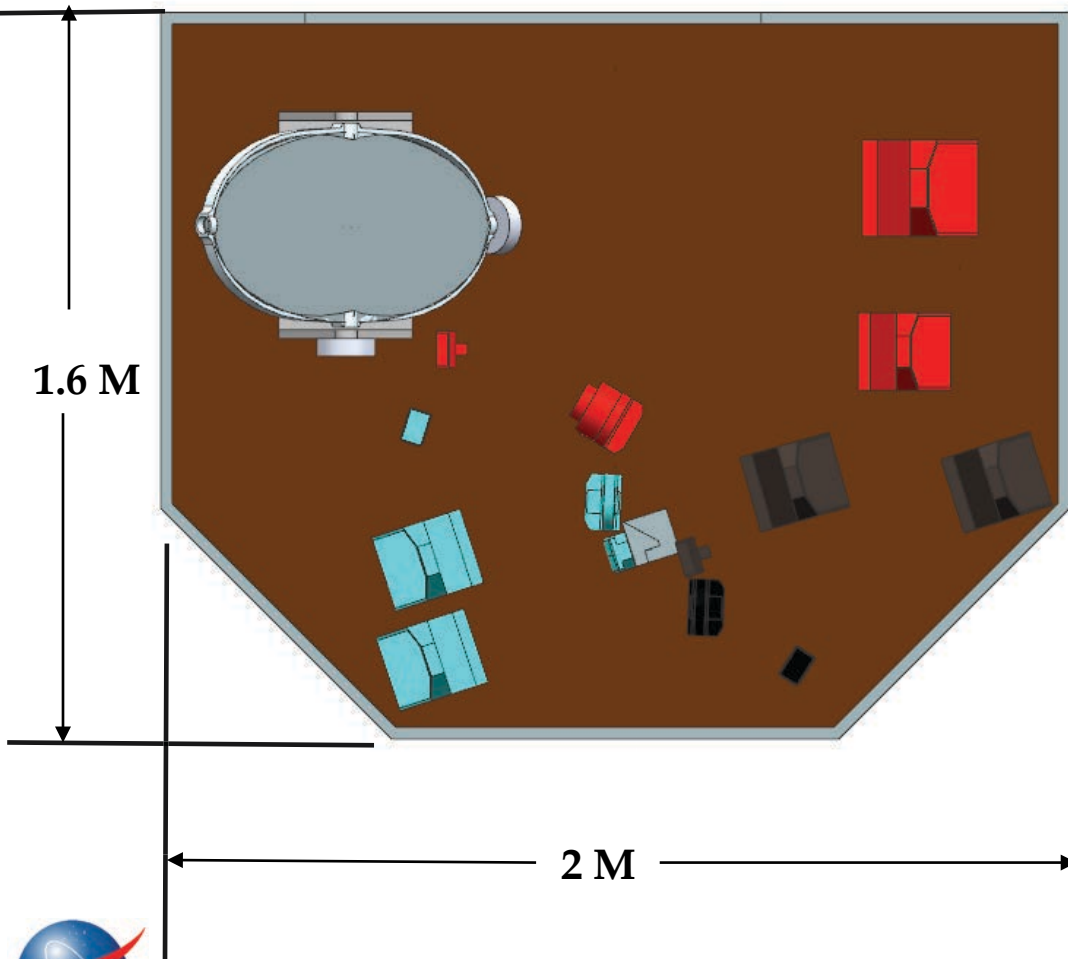

**Note: Deltas 1 & 2 are approximately the same size**



# Dimensions - Delta 1 & 2

Integrated Design Capability / Instrument Design Laboratory

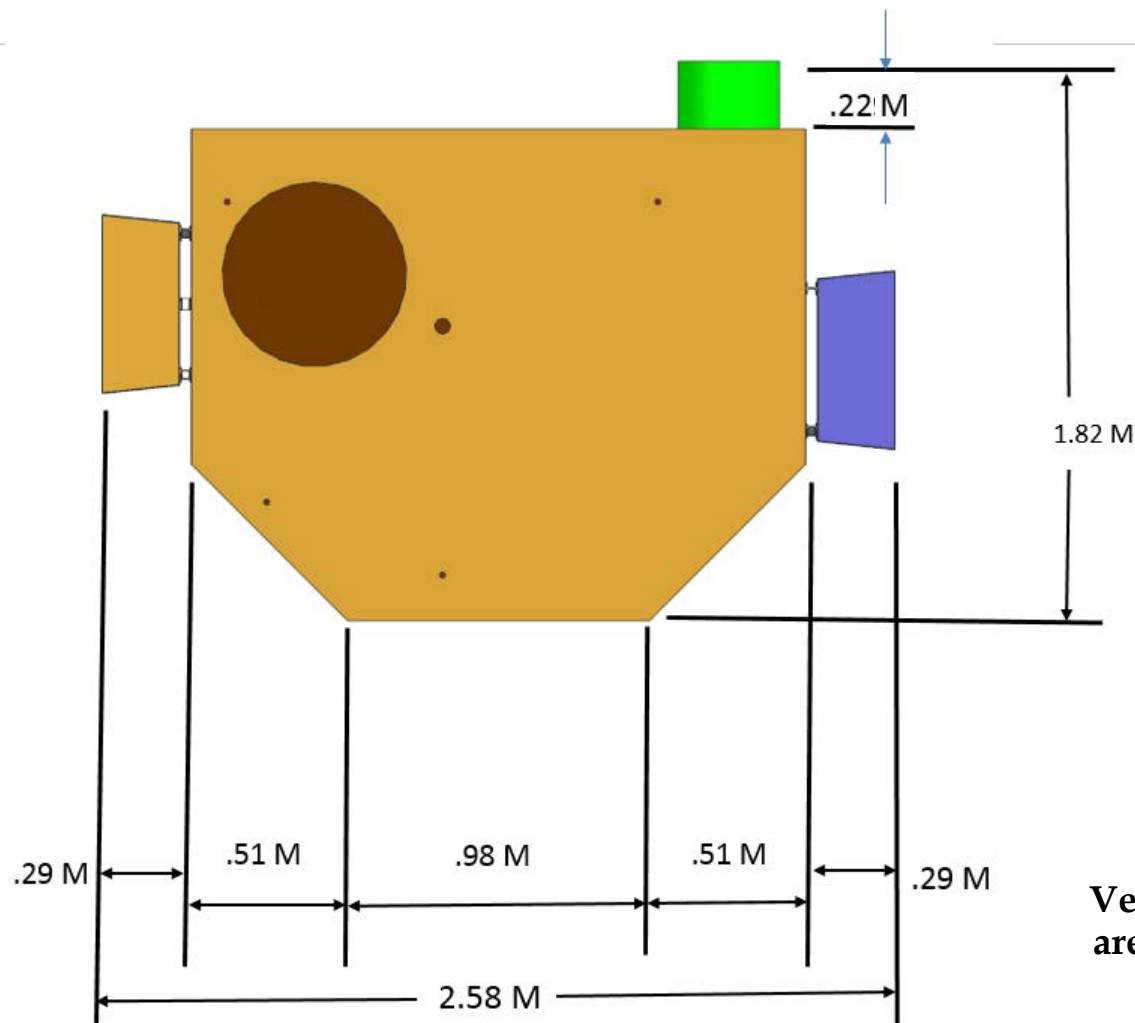

**Vertical dimensions are same as baseline**

# Optical Configuration - Delta 3

Integrated Design Capability / Instrument Design Laboratory

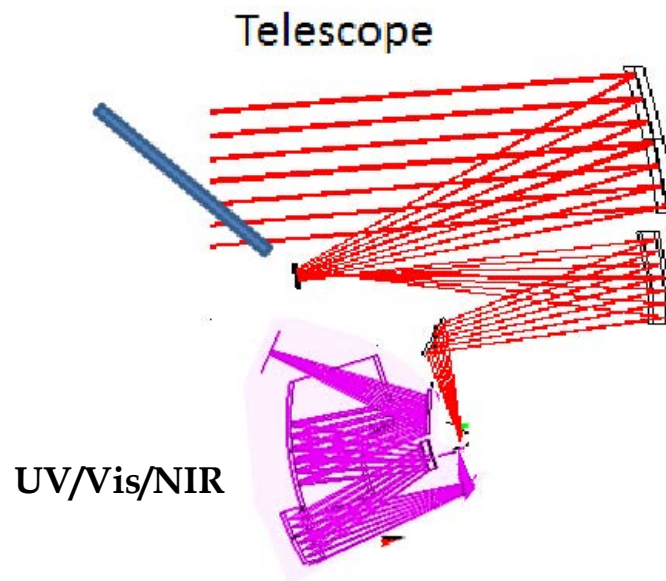
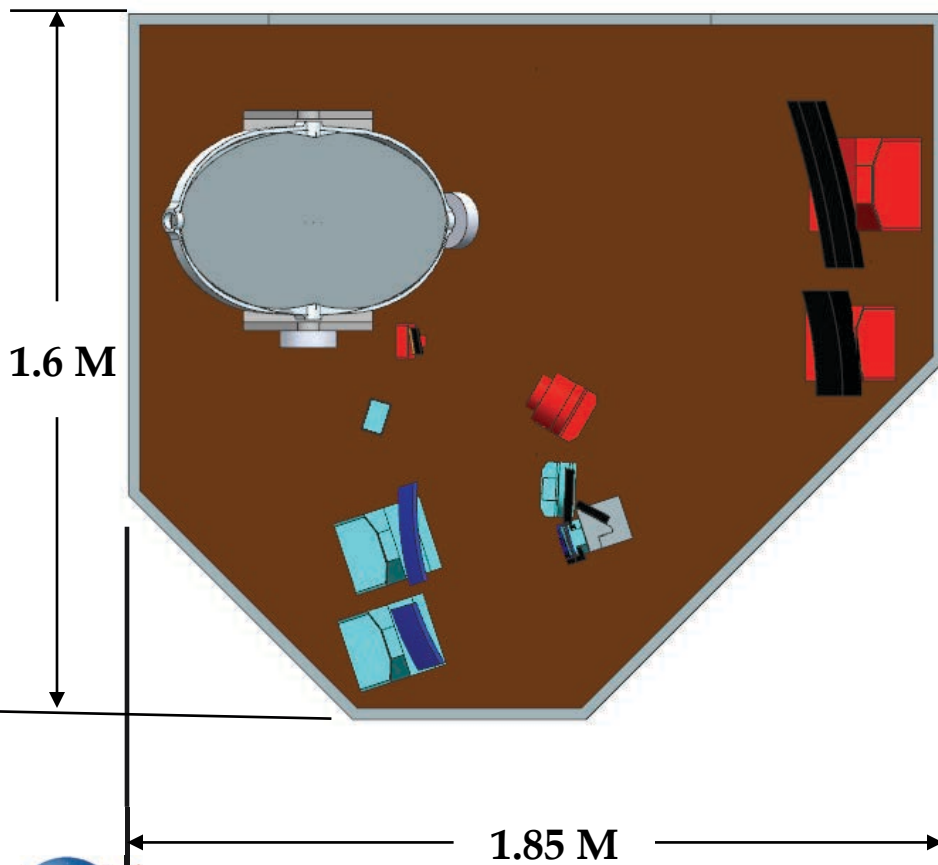

# Dimensions - Delta 3

Integrated Design Capability / Instrument Design Laboratory

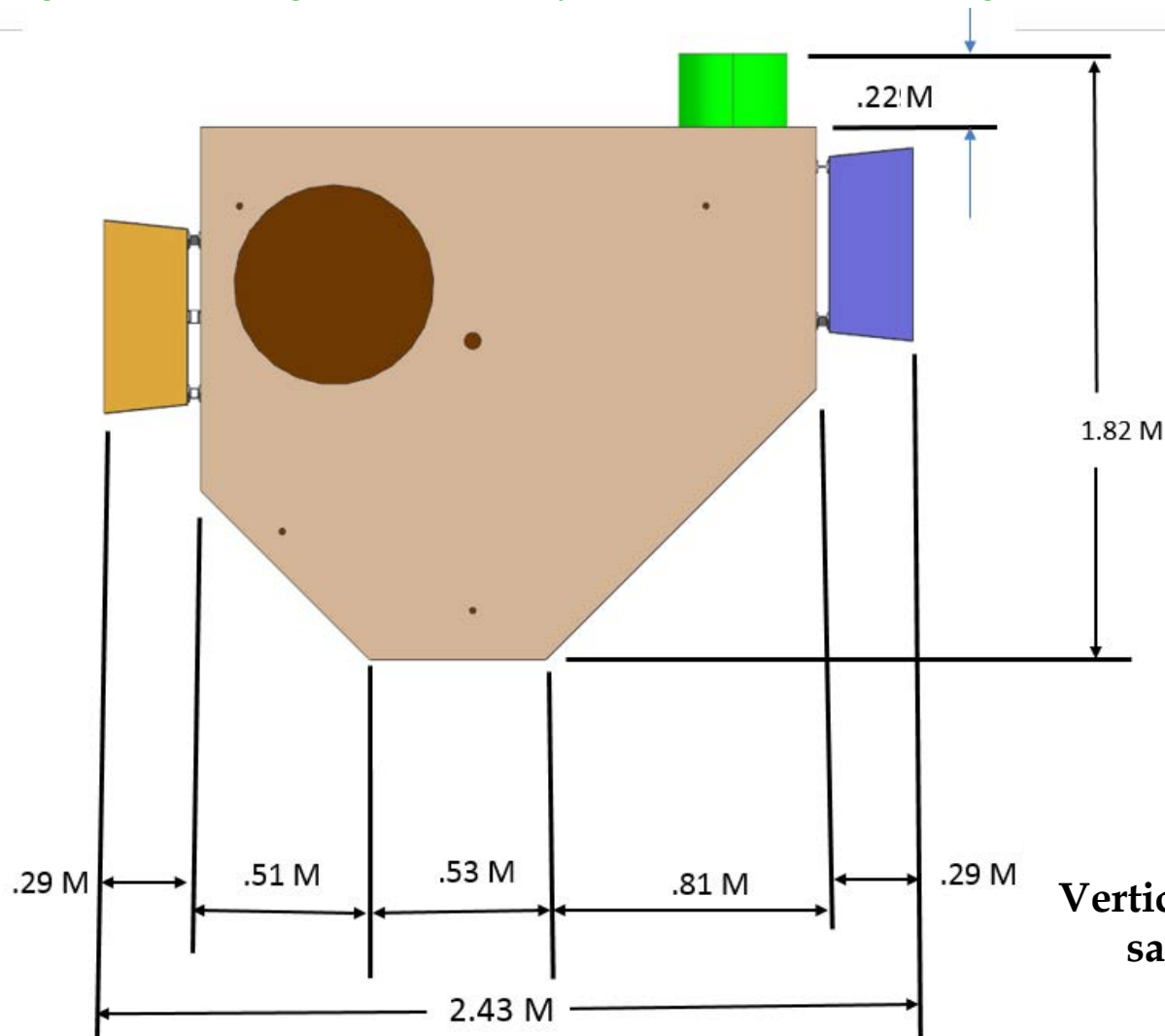

Vertical dimensions are same as baseline

# S/C Footprints - Delta Configurations Relative to Baseline



Integrated Design Capability / Instrument Design Laboratory

Delta 3 Configuration

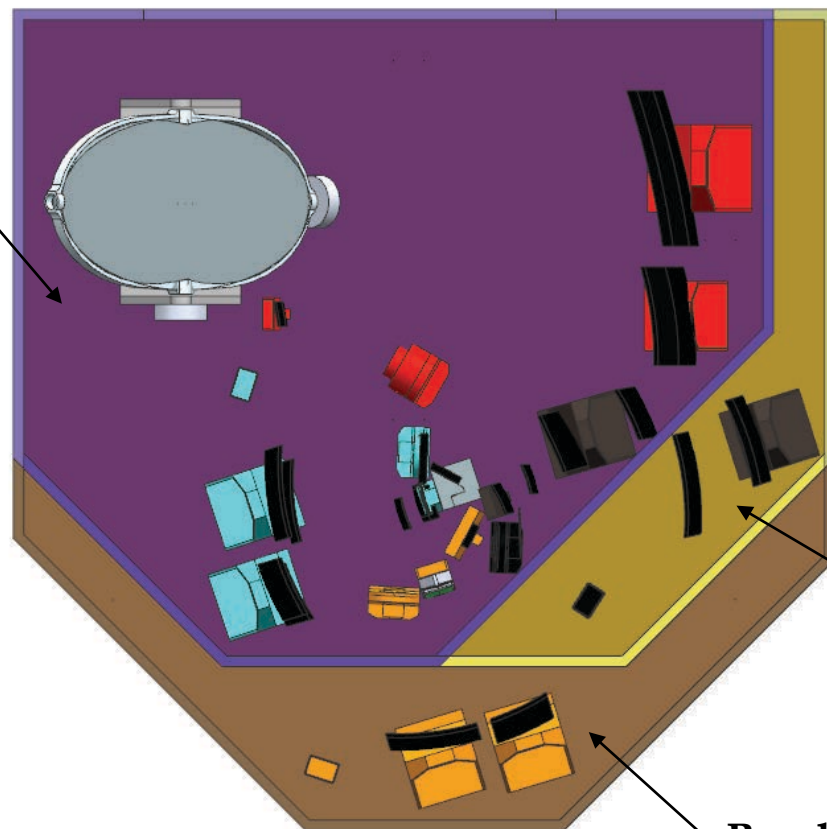

Delta 1 & 2 Configurations

Baseline Configuration



# Initial vs Updated Optical Design

Integrated Design Capability / Instrument Design Laboratory

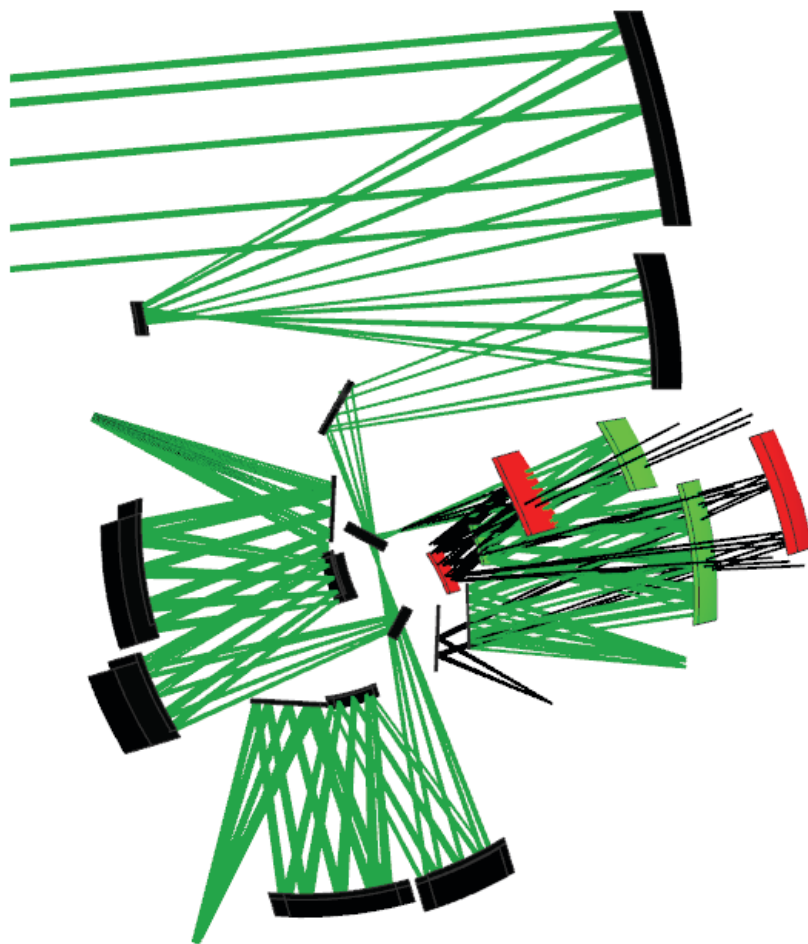

This shows the optical path used in the mechanical model over the updated optical model. For mechanical it would mean that the mount for the SWIRs channel would move slightly.

**RED** = mechanical model

**GREEN** = updated locations

# Adam!

Integrated Design Capability / Instrument Design Laboratory

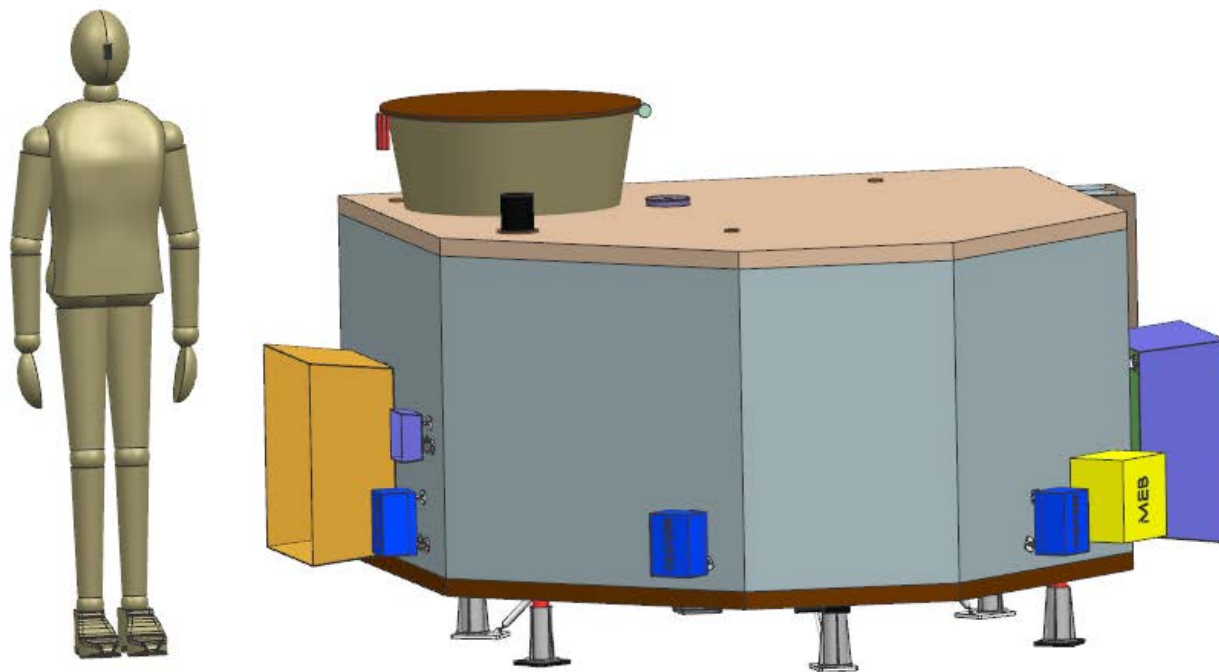

# Conclusions

## Integrated Design Capability / Instrument Design Laboratory

- There are no technology risks associated with the mechanical or structural design (i.e. standard materials as well as fabrication and assembly techniques for primary and secondary structure).
- The digitizer boxes are mounted on the outside of the instrument enclosure. Two of the boxes are within the 15 inch requirement. One box is approximately 22 inches from the detector.
- Due to the unusual height of some of the optic mounts, early effort should be put into more detailed design and optimization of those mounts.
  - The IDL designs are notional, and will not be analyzed as part of the IDL structural analysis effort.
- The Hosted Payload frequency requirements of 65 Hz lateral and 90 Hz longitudinal will likely be very challenging for an instrument of this size and mass.
  - Early discussions with the S/C provider will likely be necessary to negotiate those requirements.



# GEO CAPE Wide Angle Spectrometer (WAS)

## ~ Mechanisms Presentation ~

*Dick McBirney*

July 29, 2014

*The IDL Team shall not distribute this material without permission  
from Antonio Mannino/Code 616 (Antonio.Mannino-1@nasa.gov)  
This document contains sensitive information and is intended for NASA Official Use Only.*





# There are five mechanisms in GeoCape WAS



Integrated Design Capability / Instrument Design Laboratory

**Me1: Diffuser Wheel**

**Me2: Scan Mirror**

**Me3: Fast Steering Mirror**

**Me4: Jitter Suppression/Roll Correction System**

**Me5: Contamination Door**



# Mechanisms in the optical path

Integrated Design Capability / Instrument Design Laboratory

- Locations of mechanisms within the optical path:

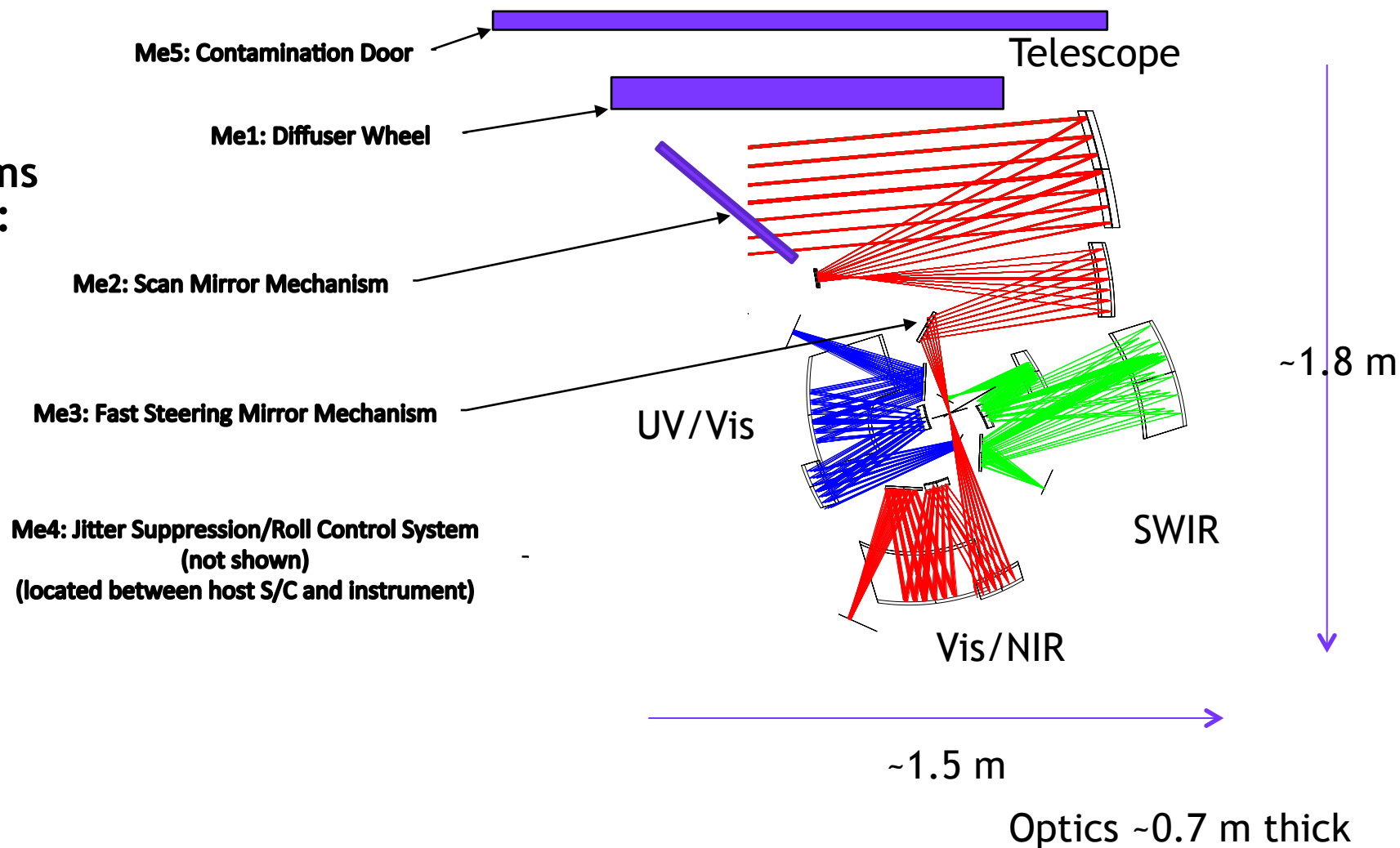

# GeoCape WAS Mechanisms

Red font To be confirmed



	Me1: Diffuser Wheel Mechanism (“DWM”)	Me2: Scan Mirror Mechanism (“SMM”)	Me3: Fast Steering Mirror (“FSM”)	Me4: Jitter Suppression/Roll Correction System (“JSS”)	Me5: Contamination Door
<b>Inertial Load</b>	2X $\Phi$ 600mm diffusers (6.2 kg ea), one “open” position and 1 cover; <b>MOI = TBD</b>	420mm x 860mm Beryllium Scan Mirror, 7.1 kg MOI = 0.091 and 0.594* kg-m <sup>2</sup> (*w/motor&encoder)	$\Phi$ 120 mm Flat <b>MOI = TBD</b>	<b>[Entire Instrument]</b>	Door diameter 706mm (27.8”) <b>MOI TBD</b>
<b>Stroke</b>	360° rotation in 90° steps	+/- 5.1° tip/tilt at mirror (for science and solar cal views)	+/- 0.25 deg tip/tilt		270° rotation
<b>Position Accuracy : Goal / Achieved</b>	$\pm 0.5^\circ$ / $\pm 0.3^\circ$ w/ 10 bit encoder	0.1 arcsec / 0.08 arcsec w/ 24 bit encoder	<0.1 arcsec / <b>TBD</b>	0.1 arcsec	$\pm 5^\circ$ in open position
<b>Duty Cycle</b>	<5%	10ms/1.4sec= 0.7%	100%	100%	<5%
<b>Bandwidth Goal / Achieved</b>	low	“fast!” / >100 Hz (step in 8ms, settle in 2ms)	High enough to cancel transmitted S/C jitter	Passive: As low as possible / Notional 1.7 Hz Active: >1.7 Hz/set by rate sensors	One time deploy
<b>Launch Lock</b>	No, “V” bearings on periphery and bearing on central shaft absorb launch loads	Yes, even if balanced (due to heavy mirror: 7.1kg)	No, with light mass balanced mirror	Yes, three TiNi Frangibolts to lock 3DOF suspension	Yes, redundant HOP Latch
<b>Motion required / Achieved</b>	Only used during solar calibration. Select between 4 positions 90° apart. Select time <30 seconds	“fast!” / 1 arcsec step in 5ms, settle in 5ms, on both axes	Jitter rejection to stabilize Beam on slit; High bandwidth Control	1) Low pass attenuation: -40db/decade above angular resonance frequency 2) Active damping: depends on closed loop performance	One time motion on command
<b>Architecture</b>	4 position, filter wheel-like device driven with stepper motor/gear	2 axis gimbal with limited range Torque Motors & encoders	Traditional FSM; quad voice coils (BEI) with LVDTs (Kavlico)	Triple flexure tripod mount with three voice coil actuators controlled by rate sensors and roll camera	HOP Latch release, kickoff springs to set deploy rate, torsion springs to sustain rate and hold in open position
<b>Comments</b>	Should be balanced by placing heavy diffusers at 180°	Must use launch locks due to mirror mass	May not be required if SMM is fast enough and JSS is soft enough	Flexures remove high freq jitter; actuators remove low freq jitter	Torsion springs hold Door in open position (no jettison, and no flopping during S/C maneuvers)

# Me1: Diffuser Wheel Mechanism DWM 1/3

Integrated Design Capability / Instrument Design Laboratory

## • Primary Requirements:

- Wheel contains: four positions: 2 Diffusers, one open position, one closed position
- Motion: rotate diffuser wheel to one of 4 positions at 90°
- 90° Step time: <30 seconds
- Position accuracy: ±0.5°
- Diffuser size: 600mm x 10mm thick
- Diffuser mass: 6.2 kg each, total of 12.4 kg; bending frequency = 302 Hz

## • Derived Requirements:

- Diffuser wheel diameter: 1550mm (61")
- Balance: diffusers should be positioned diametrically opposite at 180° to roughly balance the wheel
- Launch locks: not required; three wheel rim guide bearings and one center bearing absorb launch loads

## • Power Consumption:

- Given the mass MOI value of the wheel and the required indexing time, a power estimate could be created. Lacking those values, but impressed by the wheel size and probable friction torque to be overcome, the estimated power is 50 watts while indexing.

**4.2 Diffuser Mass**

$dia_{diff} := 600mm$      
  $thick_{diff} := 10mm$      
  $\rho_{fusedSi} := 2.2 \frac{gm}{cm^3}$

$mass_{diff} := \frac{\pi}{4} \cdot dia_{diff}^2 \cdot thick_{diff} \cdot \rho_{fusedSi}$      
  $mass_{diff} = 6.22 kg$

**4.3 Diffuser resonant frequency**

$E_{fused\_silica} := 71.7GPa$      
  $\nu_{fused\_silica} := 0.17$      
  $GPa = 10^9 \cdot Pa$

$DD := \frac{E_{fused\_silica} \cdot thick_{diff}^3}{12 \cdot (1 - \nu_{fused\_silica}^2)}$

$\omega_{n2} := \frac{10.21}{2 \cdot \pi \cdot \left(\frac{dia_{diff}}{2}\right)^2} \cdot \sqrt{\frac{DD}{\rho_{fusedSi} \cdot thick_{diff}}}$      
  $\omega_{n2} = 301.946Hz$

# Me1: Diffuser Wheel Mechanism 2/3

Integrated Design Capability / Instrument Design Laboratory

## Proposed design:

- $\Phi 1.55\text{m}$  (61") Wheel supported by three peripheral guide bearings and one central bearing for axial support.
- Two solar diffusers made of fused silica placed symmetrically for balance
- Stepper motor/gearbox drive a Delrin pinion gear that meshes with gear teeth on periphery of wheel (see next slide)
- 10 bit digital rotary position encoder attached to central shaft for position feedback. ( $360^\circ / 2^{10} = 21\text{arcmin}$ ) (see next slide)

2X  $\Phi 600\text{mm}$  x 10mm thick diffusers (6.2 kg ea), one "open" position and 1 cover

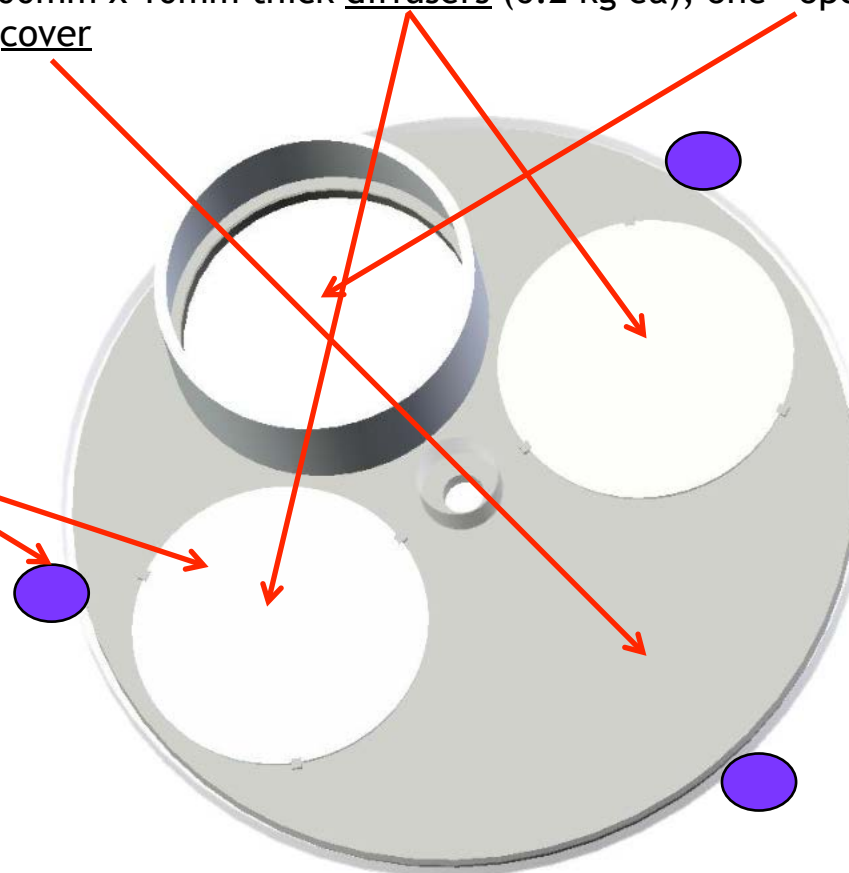

### 4.1 Diffuser Mass

$$\text{dia}_{\text{diff}} := 600\text{mm}$$

$$\text{thick}_{\text{diff}} := 10\text{mm}$$

$$\rho_{\text{fusedSi}} := 2.2 \frac{\text{gm}}{\text{cm}^3}$$

$$\text{mass}_{\text{diff}} := \frac{\pi}{4} \cdot \text{dia}_{\text{diff}}^2 \cdot \text{thick}_{\text{diff}} \cdot \rho_{\text{fusedSi}}$$

$$\text{mass}_{\text{diff}} = 6.22 \text{ kg}$$

# Me1: Diffuser Wheel Mechanism 3/3

Integrated Design Capability / Instrument Design Laboratory

- Proposed design:

- $\Phi 1.55\text{m}$  (61") Wheel supported by three peripheral guide bearings and one central bearing for axial support.
- 10 bit digital rotary position encoder attached to central shaft for position feedback. ( $360^\circ / 2^{10} = 21\text{arcmin}$ )
- Stepper motor/gearbox with pinion gear driving spur gear mesh at periphery of wheel.
- The three peripheral guide bearings (two are adjacent to the heavy diffusers) engage a V groove near the OD of the wheel. This eliminates the need for launch locks.

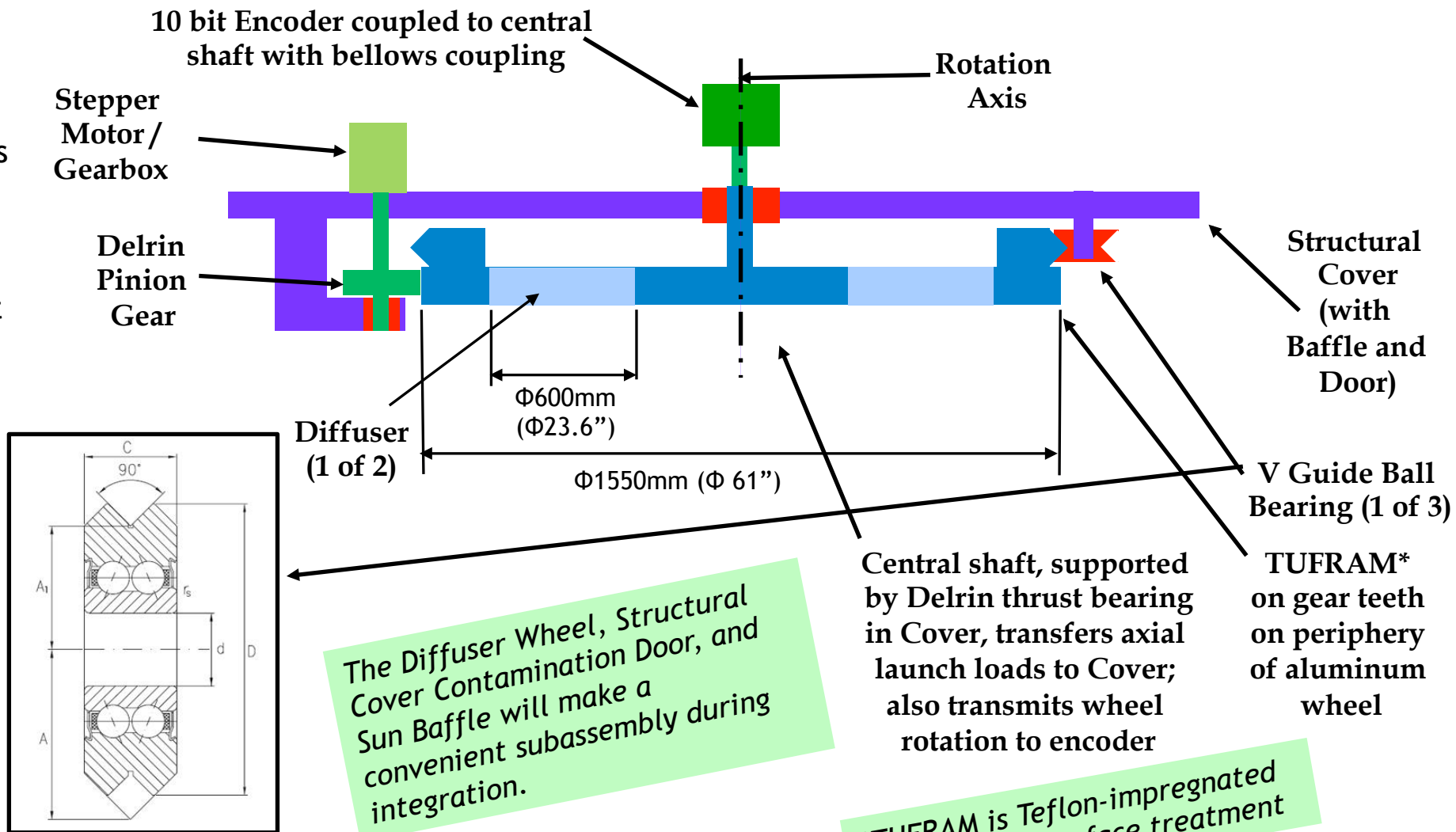

# Me2: Scan Mirror Mechanism SMM 1/7

Integrated Design Capability / Instrument Design Laboratory

- **Primary requirements:**

- Motion: Two axis tip/tilt of scan mirror.
- Mirror travel range:  $\pm 5.2^\circ$  on each axis.
- Position knowledge accuracy: 0.1 arcsec ( $1/2^{24}$  rev)
- Beam dimensions at Scan Mirror: 450mm x 360mm.
- Scan Mirror size and mass: 420mm x 860mm, est. at 25 kg/m<sup>2</sup>, 7.1 kg.
- Scan Dynamics: move Scan Mirror 1.0 arcsec; step and settle as fast as possible, then hold for 1.4 sec (during photon capture), then repeat.
- Slew Dynamics: slew  $10^\circ$  on both axes in **TBD sec.**

$$\delta\theta := \frac{360\text{deg}}{2^{24}} \quad \delta\theta = 0.077 \text{ arcsec}$$

- **Derived requirements:**

- Scan Mirror
  - Mass: 7.2 kg
  - MOI: 0.084 kg-m<sup>2</sup> and 0.590\* kg-m<sup>2</sup> (\*motor and encoder added to this axis)

# Me2: Scan Mirror Mechanism 2/7

Integrated Design Capability / Instrument Design Laboratory

- **Proposed design:**
- **Light-weighted flat Beryllium mirror with integral stub shafts mated to inner motor/encoder rotors and inner ball bearings.**
- **Mirror mass: 7.2 kg**
- **Launch locks will be required.**
- **Inner bearings mount in gimbal ring.**
  - (Flexpivot spring rates requires too much power to hold position)
- **Gimbal ring has integral stub shafts mated to outer motor/encoder rotors and outer ball bearings.**
- **Motors are limited angle Torquers (Aeroflex)**
- **Position sensors are 24 bit absolute encoders**
  - Renishaw uses 1 nm resolution technology; 24 bits resolution could be achieved in a 4mm (!) diameter
- **Pitch axis motor/encoder should be adjacent to maximize torsional resonant frequency and resultant servo bandwidth (gimbal ring is too compliant).**
- **Yaw axis motor and encoder could be on opposite sides if mirror flexibility does not overly reduce bandwidth.**

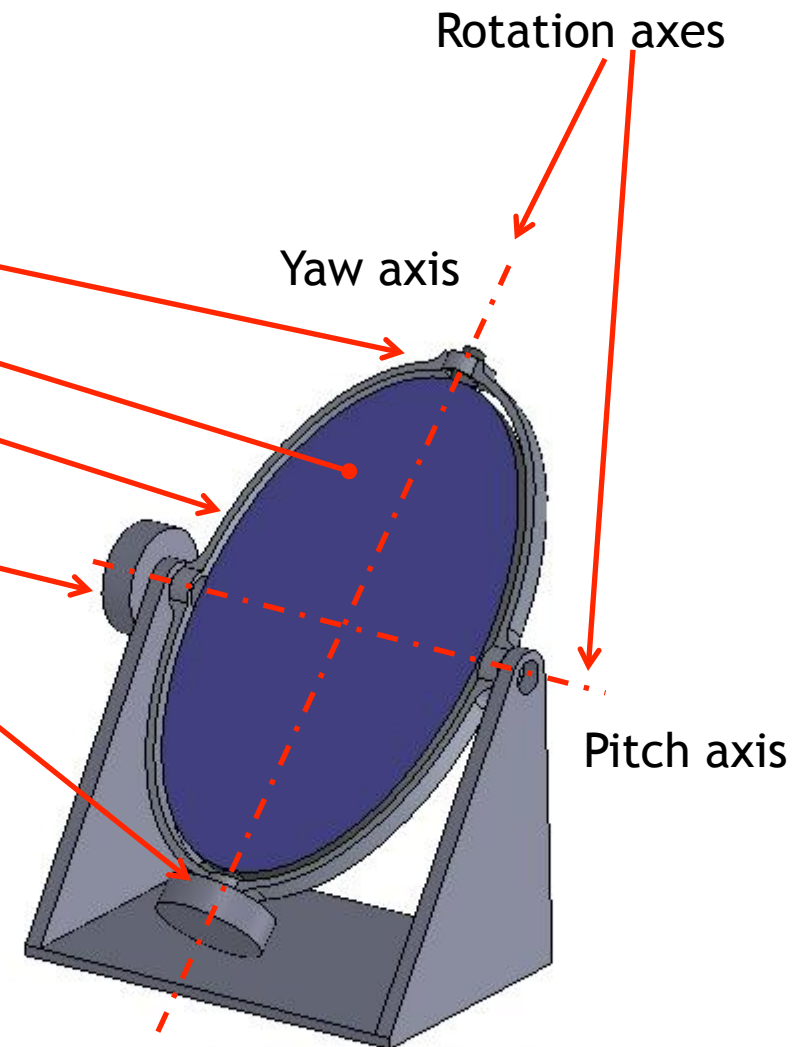



# Me2: SMM Ball Bearing Selection 3/7

Integrated Design Capability / Instrument Design Laboratory

- Launch locks will absorb 1600 lbf launch load
- Two Barden SN541TA bearings are used per axis.

## 1.6 Scan Mirror Launch loads

Accel<sub>launch</sub> := 15g

launch load g factor

rms\_factor := 3

Launch\_Force<sub>SM</sub> := mass<sub>SM</sub> • Accel<sub>launch</sub> • rms\_factor    Launch\_Force<sub>SM</sub> = 1632 lbf

## 1.2 Bearing Friction Torque

OD := 1.5 in    ID := 1.06 in

friction coeff of ball bearing     $f_b := 0.002$

axial bearing preload     $F_{axial} := 15 \text{ lbf}$

$$T_f := f_b \cdot \left( \frac{OD + ID}{2} \right) \cdot F_{axial}$$

$$T_f = 4.339 \text{ N} \cdot \text{mm}$$

$$T_f = 0.614 \text{ in} \cdot \text{ozf}$$

total ball bearing friction torque per axis

$$T_{total\_fric\_torq} := 2 \cdot T_f$$

$$T_{total\_fric\_torq} = 1.229 \text{ in} \cdot \text{ozf}$$

## DEEP GROOVE THIN SECTION (INCH)

Bore Diameters: 15.875mm to 39.688mm

• Open, shielded and sealed

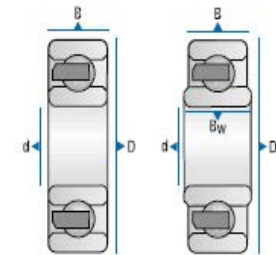

500 SERIES BASIC BEARING NUMBER	Bore Diameter d		Outside Diameter D		Width Outer Ring B		Width Inner Ring Bw		Maximum Shaft/Housing Radius Which Bearing Corner Will Clear r Max.		Static Capacity		Basic Dynamic Load Rating C (lbs.)	
	mm	inch	mm	inch	mm	inch	mm	inch	mm	inch	nd <sup>2</sup>	Radial C <sub>0</sub> (lbs.)		Thrust T <sub>0</sub> (lbs.)
SN541ZA	26.988	1.0625	38.100	1.5000	6.350	0.2500	6.350	0.2500	0.38	0.015	0.2344	256	623	484
SN541TA	26.988	1.0625	38.100	1.5000	6.350	0.2500	6.350	0.2500	0.38	0.015	0.2813	477	764	552
A541ZA	26.988	1.0625	38.100	1.5000	6.350	0.2500	7.142	0.2812	0.38	0.015	0.2344	367	376	603
A541T	26.988	1.0625	38.100	1.5000	6.350	0.2500	7.142	0.2812	0.38	0.015	0.2500	392	401	629

- This bearing has an OD of 1.5", ID of 1.0625", and a width of 0.250"
- With an axial preload of 15 lbf, the bearing friction torque per axis is estimated at 4.3N-mm (0.61 in-ozf) x 2 bearings = 6.8N-mm (1.23 in-ozf)

# Me2: SMM Torque Motor Selection 4/7

Integrated Design Capability / Instrument Design Laboratory

- We will use an Aeroflex model TQ45-2PA torque motor:

- Mass: 0.68kg (24 oz)
- Size: 4.5" OD x 0.525" ID(\*) x 0.75" w (\*need custom design w/larger ID)
- Torque gain: 66 in-ozf/amp
- Max continuous torque: 36 in-ozf

Basic Part No.	Peak Torque (in. oz.)	Peak Power (watts)	Continuous Torque (in. oz.)	Angular Excursion (degrees)	Torque Sensitivity (in-oz/amp)	Resistance at 25°C (ohms)	Weight (oz)	Outer Diameter (inch)	Width (inch)	Inner Diameter (Inch)	Torque Curve
TQ45-2PA	100	75	36	70	66	32	24	4.5	0.750	0.525	D
TQ45-3PA	100	130	38	70	30	12	24	4.5	0.750	0.525	D
TQ45W-1PA	100	80	38	70	42	14	24	4.5	0.750	0.525	D

# Me2: SMM Torque Motor 5/7

Integrated Design Capability / Instrument Design Laboratory

## • Limited Angle Torque Motor

- No commutation
- Very smooth torque curve (no torque ripple)
  - torque gain variation with angle (Curve D) varies control loop gain with position; but this is normally not a concern
- Low electrical time constant
- Direct drive, no transmission issues
- Redundant windings
- Tends to be slightly larger than commutating equivalent
- Has flight heritage



<http://aeroflex.com/ams/motion/datasheets/motion-motors-lat.pdf>

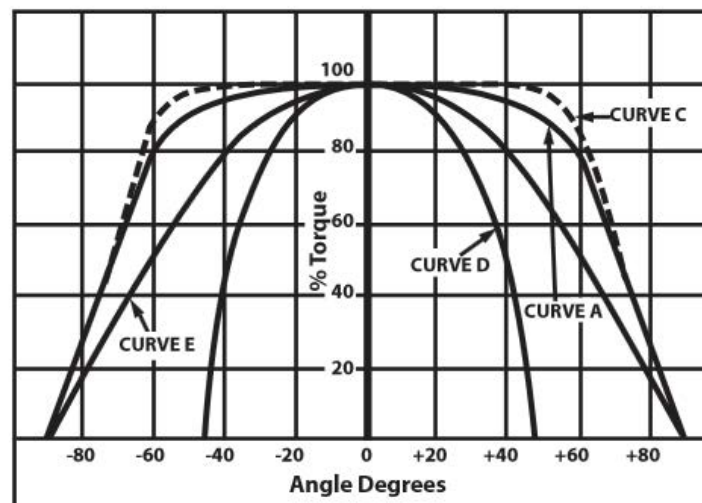

Figure 1: Performance Curves

# Me2: SMM Encoder

Integrated Design Capability / Instrument Design Laboratory

- In 1990, BEI presented a paper describing a 15” diameter, 24 bit encoder (this was the state of the art in 1990)
- [http://docs.jach.hawaii.edu/JCMT/a/019\\_encoders/07/BEI%20ITEK%20presentation%20of%2024%20bit%20encoder.pdf](http://docs.jach.hawaii.edu/JCMT/a/019_encoders/07/BEI%20ITEK%20presentation%20of%2024%20bit%20encoder.pdf)
- In 2014, Renishaw can achieve “32 bit resolution” (well...it requires an encoder diameter of 1.4m...)
- <http://www.renishaw.com/en/resolute-rotary-angle-absolute-encoder-options--10939>

## RESOLUTE UHV (Ultra-High Vacuum)

RESOLUTE™ UHV brings absolute encoder technology to Ultra-High Vacuum applications, offering sub-micron accuracy and resolutions to 1 nm for both linear and rotary applications. Constructed from clean vacuum-compatible materials and adhesives, RESOLUTE UHV gives low outgassing rates and proven clean residual gas analysis (RGA) making them suitable for high performance, semiconductor and scientific applications requiring vacuum compatibility to  $10^{-10}$  Torr.

- Clean RGA
- Low outgassing rate
- High bake-out temperature of 120 °C
- True-absolute optical encoder system: no “wake-and-shake” movements required
- Resolutions to 1 nm or 32-bit rotary
- 100 m/s maximum speed for all resolutions (to 36,000 rev/min)



▶ REXA ultra-high accuracy ring with  $\pm 1$  arc second total installed accuracy with dual readheads

With an achievable linear resolution of 1 nanometer, a rotary encoder 4 mm in diameter (!) could provide the required angular resolution of 0.1 arcsec.

$$\begin{aligned} \Delta L &:= 1 \cdot 10^{-9} \text{ m} & \frac{L}{R} &= \theta \\ \Delta \theta &:= 0.1 \text{ arcsec} & R &= \frac{L}{\theta} \\ \text{radius}_{\text{encoder}} &:= \frac{\Delta L}{\Delta \theta} & \text{radius}_{\text{encoder}} &= 2.063 \text{ mm} \end{aligned}$$

# Me2: SMM Performance 6/7

Integrated Design Capability / Instrument Design Laboratory

• With the mirror MOI determined, the torque motor selected, and the bearing friction torque defined, we can determine the performance achieved:

- The motor/mirror/encoder is operated as a closed position loop, but performance can be estimated by assuming we:
  1. Accelerate the mirror for 4.0 millisecc with +27 in-oz torque
  2. Decelerate the mirror for 4.0 millisecc with -27 in-oz torque

• So the SMM can step 1 arcsec in 10 millisecc (with 2 millisecc settling time)

• The power consumption during each step is 5.4 watts

**1.4 SMM Motor Power consumption**

$$R_{\text{motor}} := 32\text{ohm} \quad K_T := 66\text{in} \cdot \frac{\text{ozf}}{\text{A}} \quad I_{\text{motor}} := \frac{T_{\text{IandF}}}{K_T} \quad I_{\text{motor}} = 0.412\text{ A}$$

$$\text{Power}_{\text{motor}} := I_{\text{motor}}^2 \cdot R_{\text{motor}} \quad \text{Power}_{\text{motor}} = 5.444\text{ W}$$

$$V_{\text{motor}} := I_{\text{motor}} \cdot R_{\text{motor}} \quad V_{\text{motor}} = 13.199\text{ V}$$

**1.3 Performance**

After each stare, the SMM steps 1 arcsec  $\theta_{\text{step}} := 1\text{arcsec}$

Assume a constant torque to move halfway, then neg torque to stop the motion

Assume time of half step acceleration  $t_{\text{half\_step}} = 0.004\text{sec}$

$$\theta = \frac{1}{2} \cdot \alpha \cdot t^2$$

$$\alpha_{\text{SM}} := 2 \cdot \frac{\theta_{\text{step}}}{(t_{\text{half\_step}})^2} \quad \alpha_{\text{SM}} = 17.361 \frac{\text{deg}}{\text{sec}^2} \quad \alpha = 2 \cdot \frac{\theta}{t^2}$$

$$\text{torque}_{\text{bSM}} := \text{MOI}_{\text{bSM\_with\_MotorEnc}} \cdot \alpha_{\text{SM}}$$

$$\text{torque}_{\text{bSM}} = 187.893\text{ N} \cdot \text{mm} \quad \text{torque}_{\text{bSM}} = 26.608\text{ in} \cdot \text{ozf}$$

**total inertial and friction motor torque reqd**  $T_{\text{IandF}} := \text{torque}_{\text{bSM}} + T_f \quad T_{\text{IandF}} = 27.222\text{ in} \cdot \text{ozf}$

Since the duty cycle is very low, the average power is low:

**1.5 Duty Cycle and average power**

$$\text{duty\_cycle} := \frac{0.010\text{sec}}{1.4\text{sec}} \quad \text{duty\_cycle} = 0.714\%$$

$$P_{\text{average}} := \text{Power}_{\text{motor}} \cdot \text{duty\_cycle} \quad P_{\text{average}} = 0.037\text{ W}$$

# Me2: Scan Mirror Mechanism 7/7

Integrated Design Capability / Instrument Design Laboratory

- Excerpt from 2010 GeoCape Mechanisms presentation:
- “Motion
  - E-W DOF: step over 1.1 arc-sec and settle in <250 millsec, repeat once per second”
- “Image Stability
  - Goal of 0.5 arc-sec (0.5 arc-sec on N-S DOF, 0.25 arc-sec on E-W DOF)”
- “Scan Mirror mechanism is *on the edge of what is achievable*. A separate, intensive study should be performed to determine feasibility.”

- 2014 Technology is better:
- An encoder resolution of 0.1 arcsec (24 bit resolution) was the state of the art achieved by BEI in 1990 with a 15” diameter encoder, but Renishaw - and maybe others - can now achieve 30 bit resolution at that diameter.

EXAMPLE OF INDUSTRY FIRSTS RESULTING FROM ITEK IR&D ARE:

- 1959 First 17 Bit Optical Encoder (RD17 - 10" Gray Code)
- 1966 First 20 Bit Optical Encoder (DIGISEC® BD)
- 1968 First 21 Bit Optical Encoder (RA21/158)
- 1971 First Redundant Absolute Encoder
- 1975 First High Resolution Absolute Encoder with LED illuminators (RAL18/106)
- 1977 First 22 Bit Optical Encoder with X64 Multiplier (RA22/158)
- 1980 First Multiplexed, Hybrid Code Encoder (MicroSeries®)
- 1982 First 10 Inch Thru-Hole, 21 Bit Spacecraft Encoder
- 1990 First 24 Bit Optical Encoder with LED Illuminators.

ENCODER CAPABILITIES

OUTSIDE DIAMETER	INSIDE DIAMETER	HIGHEST RESOLUTION	
		STANDARD	OPTIONAL
1.6 INCH	----- SHAFT	16 BITS	-
2.3	----- SHAFT	17 BITS	-
3.5	----- SHAFT	18 BITS	-
4.0	----- 1.0 INCH	17 BITS	-
5.0	----- 2.0 INCH	19 BITS	-
6.0	----- 2.25 INCH	19 BITS	21 BITS
8.0	----- 4.0 INCH	20 BITS	21 BITS
10.0	----- 6.0 INCH	21 BITS	23 BITS
15.0	----- 8.0 INCH	24 BITS	-

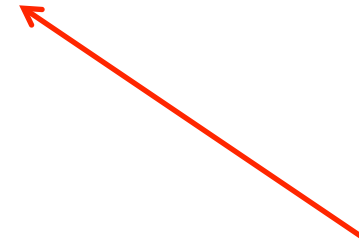

# Me3: FSM (Fast Steering Mirror) 1/4

Integrated Design Capability / Instrument Design Laboratory

## • Primary Requirements

- Motion: Two axis tip/tilt of fold mirror.
- Travel range:  $\pm 0.25^\circ$  on each axis.
- Beam diameter at FSM: 110mm
- FSM mirror size:  $\Phi 120$  mm flat, made of light-weighted Beryllium.
- Dynamics: bandwidth must be sufficient to reject angular jitter imposed on GeoCape WAS instrument from S/C.

## • Derived Performance

- FSM mirror mass: 29 grams
- Bandwidth: the required bandwidth of the FSM should be minimal; for example, if the passive instrument mount could achieve an angular resonant frequency of, say, 1 Hz, the required FSM bandwidth could be as low as 10 Hz, depending on the results of a detailed analysis of the jitter attenuation required by the instrument.

## • Power Consumption

- Power consumption is minimal: **2.9 W** to remove a 100 Hz,  $\pm 0.1^\circ$  jitter.

**2.1 power consumption of FSM Voice Coil Actuator (VCA)**

torque gain of the VCA  $K_{T\_VCA} := 2.85 \frac{\text{lbf}}{\text{amp}}$  coil resistance is  $R_{VCA} := 15\text{ohm}$

radius of the VCA  $r_{VCA} := 2.5\text{in}$

torque gain of the VCA  $K_{\theta\_VCA} := K_{T\_VCA} \cdot r_{VCA}$   $K_{\theta\_VCA} = 7.125 \frac{\text{in} \cdot \text{lbf}}{\text{amp}}$

MOI of the FSM is  $MOI_{FSM} := 611\text{kg} \cdot \text{mm}^2$

assume a sinusoidal motion of the FSM at a frequency "f" and a half amplitude of "A<sub>0</sub>". the peak angular acceleration is  $\alpha_{\text{max}} := 4 \cdot A_0 \cdot \pi^2 \cdot f^2$   $\alpha_{\text{max}} = 3.948 \times 10^4 \frac{\text{deg}}{\text{s}^2}$

so the max torque is  $T_{\text{max}} := MOI_{FSM} \cdot \alpha_{\text{max}}$   $T_{\text{max}} = 3.726\text{in} \cdot \text{lbf}$

so the max current is  $I_{\text{max}} := \frac{T_{\text{max}}}{K_{\theta\_VCA}}$   $I_{\text{max}} = 0.523\text{A}$

the max peak power is  $P_{\text{peak}} := R_{VCA} \cdot I_{\text{max}}^2$   $P_{\text{peak}} = 4.102\text{W}$

the average power for a sinusoid is  $P_{\text{avg}} := \frac{P_{\text{peak}}}{\sqrt{2}}$   $P_{\text{avg}} = 2.901\text{W}$

# Me3: FSM 2/4

Integrated Design Capability / Instrument Design Laboratory

- **Proposed design: traditional Fast Steering Mirror mechanism:**

- Flat mirror mounted on 2 bearings in gimbal ring;
- Gimbal ring mounted on 2 bearings attached to base.
- Four voice coil actuators attached to back of mirror;
- Four position sensors attached to the back of the mirror (Linear Variable Differential Transformers (LVDTs) (Kavlico)). DITs are shown, but LVDTs are recommended.

- **Alternate design choices**

1. The lightweight Be mirror could be supported by a center post with two flexural cuts to provide tip/tilt motion; this would eliminate 4 ball bearings and would eliminate the flexural compliance of the gimbal ring.
2. Each pair of actuators and sensors could be aligned radially to eliminate crosstalk; the tradeoff is between (a) the reduced operating radius of the inner pair of components and (b) the complexity of extracting 2D on-axis angular position data from sensors that sense a combination of both tip and tilt motion.

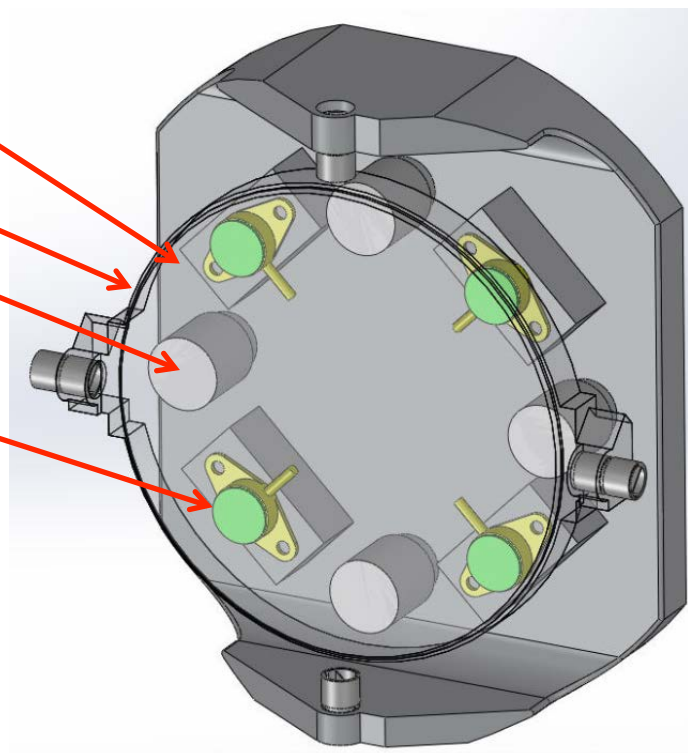



# Me3: Voice Coil Actuator 3/4

Integrated Design Capability / Instrument Design Laboratory

BEI

LA15-16-024A  
Linear Voice Coil Actuators

- Pairs of VCAs are used in push/pull mode to tip and tilt the FSM



VCA is shown partially disassembled to see the coil windings; in operation, the windings are always totally immersed in the magnetic field to ensure a linear current>force gain over the stroke of the actuator.

WINDING CONSTANTS *	UNITS	TOL	SYMBOL	WDG A	WDG B
DC RESISTANCE	OHMS	± 12.5%	R	4.7	15.0
VOLTAGE @ F <sub>P</sub>	VOLTS	NOMINAL	V <sub>P</sub>	33.0	58.6
CURRENT @ F <sub>P</sub>	AMPERES	NOMINAL	I <sub>P</sub>	7.02	3.91
FORCE SENSITIVITY	LB/AMP	± 10%	K <sub>F</sub>	2.85	5.12
	N/AMP	± 10%		12.68	22.77
BACK EMF CONSTANT	V/FT/SEC	± 10%	K <sub>B</sub>	3.86	6.94
	V/M/SEC	± 10%		12.68	22.77
INDUCTANCE ****	MILLI-HENRY	± 30%	L	1.25	4.05

ACTUATOR PARAMETERS *	UNITS	SYMBOL	VALUE
PEAK FORCE **	LB	F <sub>P</sub>	20.0
	N		89.0
CONTINUOUS STALL FORCE **	LB	F <sub>CS</sub>	5.5
	N		24.47
ACTUATOR CONSTANT	LB/√WATT	K <sub>A</sub>	1.31
	N/√WATT		5.83
ELECTRICAL TIME CONSTANT	MICRO-SEC	τ <sub>E</sub>	270
MECHANICAL TIME CONSTANT	MILLI-SEC	τ <sub>M</sub>	1.28
POWER I <sup>2</sup> R @ F <sub>P</sub>	WATTS	P <sub>P</sub>	232
STROKE	± INCHES		0.125
	± MM		3.18

P/N	TYPE	Peak Force		Continuous Stall Force		Total Stroke		Actuator Constant		O.D./ Width		Length (@ mid-stroke)	
		N	lb	N	lb	mm	in	N/√watt	lb/√watt	mm	in	mm	in
LA15-16-024A	CYL	88.96	20	24.47	5.5	6.35	0.25	5.827	1.31	38.1	1.5	39.62	1.56

# Me3: LVDT 4/4

Integrated Design Capability / Instrument Design Laboratory

Pairs of LVDTs are used in differential mode to measure the angular tip/tilt deflection of the FSM.

<http://pre.kav.com.s3.amazonaws.com/downloads/Industrial%20LVDT.pdf>

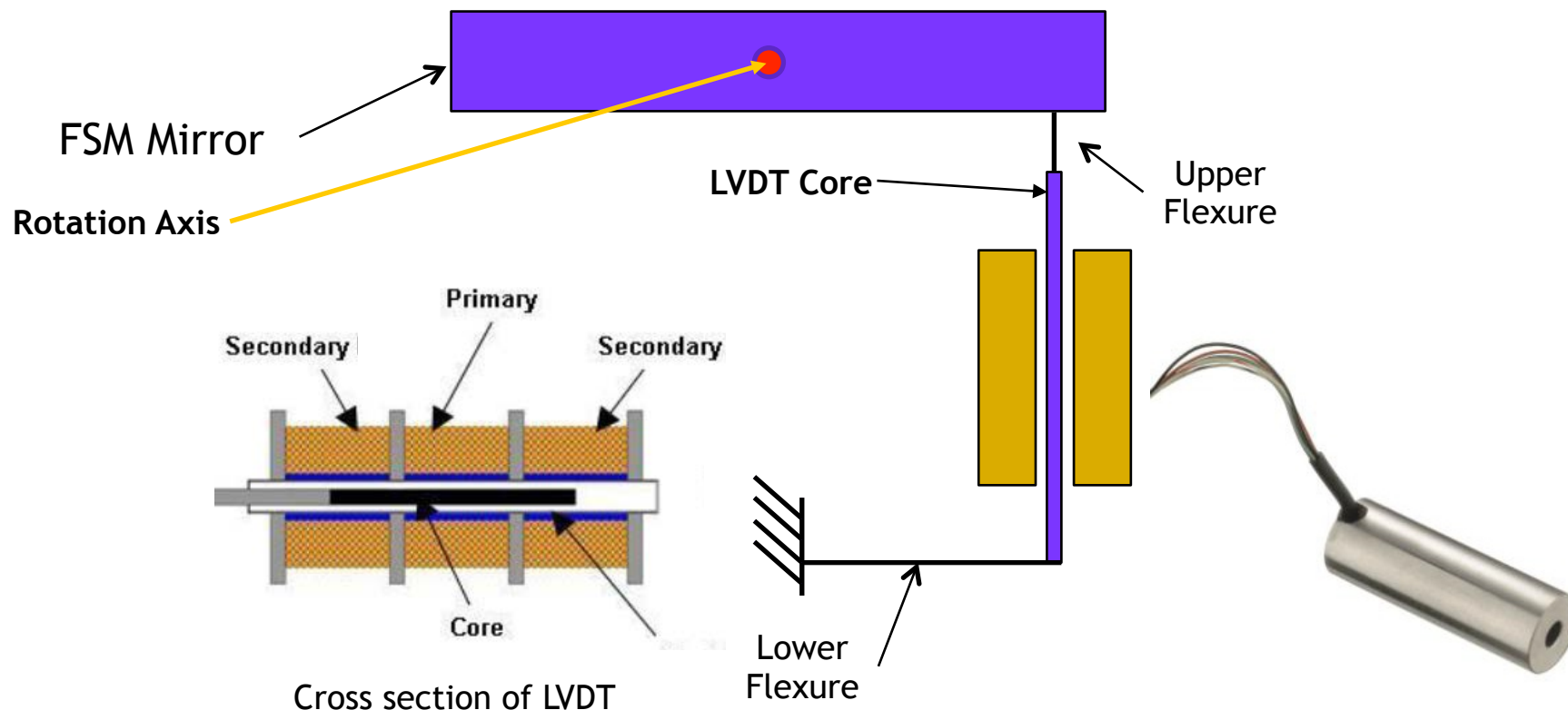

## Key Product Features

Excitation Voltage	3.0 to 26 VRMS
Excitation Frequency	60 to 5,000 Hz
Temperature Range	-65°F to +450°F
Measurement Range	.010" to 20.00"
Accuracy	±0.5% FS Typical (-65° to +250° F)
Vibration Capability	Over 100 G's
Accelerated Shock	500 G's
Pressure	10,000 psi
Linearity	±0.25% FS Typical
Environmental	MIL-STD-810 and/or RTCA DO-160

Kavlico is a leading North American and European manufacturer of OEM and off-the-shelf pressure, position (LVDT & RVDT), force, and other specialty sensors and transducers for the Transportation (including Automotive and On & Off-highway), Industrial (including HVAC, medical, wastewater, process control and other general industry applications) and Aerospace & Defense markets worldwide.

Photo is for illustration only; not to scale

# Me4: Jitter Suppression/Roll Correction System 1/9



Integrated Design Capability / Instrument Design Laboratory

- **Primary Requirements:**

- Jitter rejection: GeoCape WAS is attached to a geosynchronous communications spacecraft; these are known to have higher levels of angular pointing jitter than optical instruments can accommodate. Therefore, GeoCape WAS must attenuate the angular motion imposed on it by the host spacecraft.

- **Discussion:**

- This high BW (bandwidth) angular jitter could be removed by active, high BW mirror servos, but a passive approach is recommended: By angularly floating the instrument on flexures, the high BW jitter is removed passively, turning the high mass MOI of the instrument to our advantage, leaving only low BW jitter to be removed actively. *This approach eliminates the need for high BW sensors, actuators, and control loops.*

- **Proposed Design:**

1. Implement a flexible suspension between the GeoCape WAS instrument and the S/C:
  - Use three flexures whose action lines intersect at the CG of the instrument as shown in the following slides;
    - (The flexures will only transmit angular jitter motion to the instrument that is below the resonant frequency of the flexure stiffness/instrument MOI)
  - Use three active, low stiffness, linear actuators (i.e., voice coil actuators) at the extremities of the instrument housing.
  - Use inertial rate sensors to measure and remove the residual low frequency pitch and yaw angular motions not removed by the flexures.
2. Provide three launch locks:
  - Three launch locks placed at the extremities of the instrument housing are required to transmit the launch loads. Note that the flexure mounts are axially spring loaded to minimize axial loads while launch locks are engaged. See backup slide.

- **A question:** *This proposed design removes only the ANGULAR pitch and yaw jitter motion imposed by the spacecraft. Will the instrument - and all its sensors and optics - be affected by the LINEAR jitter motion also imposed by the spacecraft - and is NOT removed by this suspension?*



# Me4: Jitter Suppression/Roll Correction System 2/9

Integrated Design Capability / Instrument Design Laboratory

- Pitch motion of the S/C is about the Combined CG, so the motion at the CG of the GeoCape WAS instrument is a combination of lateral motion and rotation - *if* the instrument were rigidly attached to S/C.
- Now if we attach the instrument to the S/C through a spherical joint at the instrument CG, lateral motions are transmitted, but rotations are not - *but lateral motion of instrument is not a problem, since it does not change the pointing attitude.*
- A spherical joint at the instrument CG is not physically possible, but three flexural struts pointed at the instrument CG is possible, and, for small angular motions, is kinematically equivalent to a spherical joint. Rotational damping is now introduced by attaching three Voice Coil Actuators as far from the instrument CG as possible and driving them with current commands derived from pitch/yaw angular rate sensors and the roll camera.

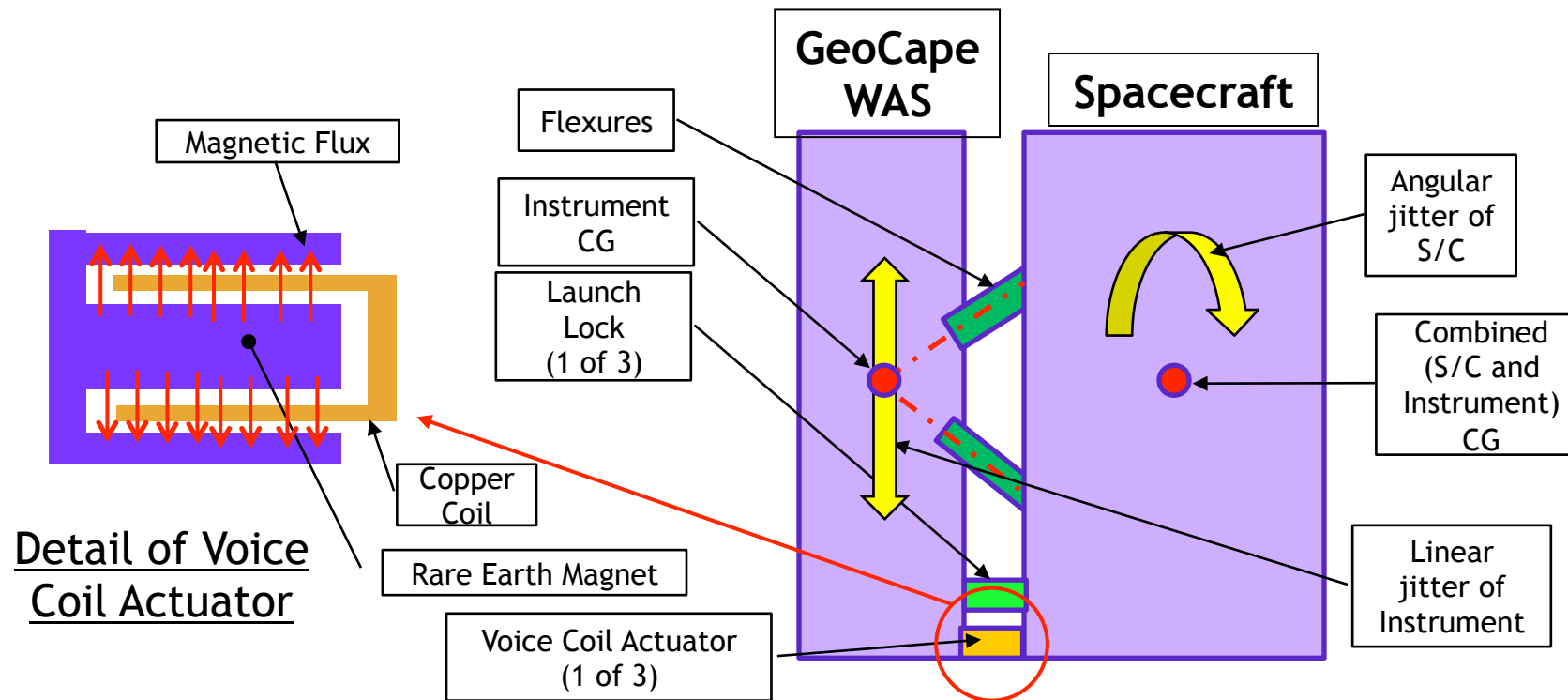

# Me4: Jitter Suppression/Roll Correction System 3/9



## Integrated Design Capability / Instrument Design

- Assuming 1m dimensions and a mass of 250 kg allows us to calculate the MOI of the instrument at 42 kg-m<sup>2</sup>
- Assuming a max flight load on each flexure of 100 lbf allows us to suggest a 0.1" diameter x 0.4" long flexure with an allowable YS of 50 ksi and a modulus of 30 x 10<sup>6</sup> psi, which has a bending stiffness of 0.006 in-ozf/μrad
- Combining these results gives a rotational resonant frequency of 1.73 Hz.
- Power Consumption**
  - The electrical power required to actively remove angular jitter from the instrument is greatly dependent on its bandwidth and amplitude, as well as the mass and mass MOI of the instrument.
  - When these values are available, a power estimate can be derived; for budgetary purposes, the power will probably be under 5 watts.

### 3. Jitter Attenuation

#### 3.1 estimate instrument angular resonance frequency on flexure tripod

##### 3.1.1 instrument MOI

$$\text{mass}_{\text{instrument}} = 250 \text{ kg} \quad L_{\text{inst}} := 1 \text{ m} \quad W_{\text{inst}} := 1 \text{ m} \quad H_{\text{inst}} := 1 \text{ m}$$

MOI of rectangular solid

$$\text{MOI}_{\text{inst}} := \frac{\text{mass}_{\text{instrument}}}{12} \cdot (L_{\text{inst}}^2 + H_{\text{inst}}^2) \quad I_h = \frac{1}{12} m (w^2 + d^2)$$

$$\text{MOI}_{\text{inst}} = 41.667 \text{ kgm}^2$$

##### 3.1.2a Launch load on Instrument Launch Locks

$$\text{Launch\_Force}_{\text{inst}} := \text{mass}_{\text{instrument}} \cdot \text{Accel}_{\text{launch}} \cdot \text{rms\_factor} \quad \text{Launch\_Force}_{\text{inst}} = 24802 \text{ lbf}$$

##### 3.1.2 max axial flight load on flexures

$$\text{Fmax} := 100 \text{ lbf} \quad a_{\text{max}} := \frac{\text{Fmax}}{\text{mass}_{\text{instrument}}} \quad a_{\text{max}} = 0.181 \text{ g} \quad \text{surely the comsat reboot thrusters cannot exceed this.}$$

##### 3.1.3 angular stiffness of flexures

assume an axially loaded cylindrical bar with a Yield Strength of  $\text{YS}_{\text{bar}} := 50000 \text{ psi}$

$$\text{dia}_{\text{bar}} := 0.1 \text{ in} \quad \text{area}_{\text{bar}} := \frac{\pi}{4} \cdot \text{dia}_{\text{bar}}^2 \quad \text{area}_{\text{bar}} = 7.854 \times 10^{-3} \text{ in}^2$$

$$\text{this bar can support an axial load of: } \text{Load}_{\text{bar}} := \text{YS}_{\text{bar}} \cdot \text{area}_{\text{bar}} \quad \text{Load}_{\text{bar}} = 392.699 \text{ lbf}$$

$$\text{Length}_{\text{bar}} := 0.4 \text{ in}$$

$$\text{The area MOI of the flexure is } I_{\text{bar}} := \frac{\pi}{4} \cdot \left(\frac{\text{dia}_{\text{bar}}}{2}\right)^4 \quad I_{\text{bar}} = 4.909 \times 10^{-6} \text{ in}^4 \quad E_{\text{bar}} := 30000000 \text{ psi}$$

$$\text{for a beam of stiffness EI, a moment M will bend the beam into a segment of a circle of radius } \rho \quad M = \frac{E \cdot I}{\rho} \quad (1)$$

$$\text{Solving (1) for } \rho, \text{ we have } \rho = \frac{E \cdot I}{M} \quad (2)$$

$$\text{Now the deflection angle } \theta \text{ created in a beam of length L by moment M is given by } \theta = \frac{L}{\rho} \quad (3)$$

$$\text{Substituting (2) into (3), we have } \theta = \frac{L}{\frac{E \cdot I}{M}} \quad (4)$$

$$\text{Noting that } M/\theta \text{ is the bending spring rate K, we can say } K_{\text{bar}} := \frac{E_{\text{bar}} \cdot I_{\text{bar}}}{\text{Length}_{\text{bar}}} \quad (5) \quad K_{\text{bar}} = 5.89 \times 10^{-3} \text{ in} \cdot \text{ozf} / \text{microrad}$$

##### 3.1.4 Resonant frequency of instrument mounted on a tripod of three flexures

$$f_{\text{inst}} := \sqrt{\frac{3 \cdot K_{\text{bar}}}{\text{MOI}_{\text{inst}}}} \quad f_{\text{inst}} = 1.731 \text{ Hz}$$



# Me4: Jitter Suppression/Roll Correction System 4/9



Integrated Design Capability / Instrument Design Laboratory

## • Roll Control Requirement:

- The estimated RMS amplitude of the spacecraft roll error is  $0.1^\circ$ , with a bandwidth of 0.1 Hz.
- Optics principles require that the entire instrument be rolled to remove this error; moving individual optics elements will not work.

## • Proposed Design

- All of this error will have to be removed by the roll axis jitter attenuation actuator, as the resonant frequency of the flexure/instrument combination is far higher than 0.1 Hz.
- The estimated torque required to rotate the instrument line of sight by  $0.1^\circ$  is 31 in-ozf.
- Assuming the roll actuator acts at a radius of 1m, the force is 0.78 ozf and the power is 1.4milliwatts.

### 3.5 Roll Control

Assume the jitter actuators have a radius of action of  $r_{\text{actuator}} := 1\text{m}$

and a torque gain of  $\text{Force\_Gain}_{\text{VCA}} := 1.31 \frac{\text{lbf}}{\sqrt{\text{W}}}$

Assume a roll angle of  $\Delta\theta_{\text{roll}} := 0.1\text{deg}$

so the torque required is  $\text{Torque}_{\text{roll}} := 3 \cdot K_{\text{bar}} \cdot \Delta\theta_{\text{roll}}$   $\text{Torque}_{\text{roll}} = 30.843\text{ in}\cdot\text{ozf}$

So the roll actuator must exert a force  $\text{Force}_{\text{roll}} := \frac{\text{Torque}_{\text{roll}}}{r_{\text{actuator}}}$   $\text{Force}_{\text{roll}} = 0.783\text{ ozf}$

The roll power required is  $P_{\text{VCA}} := \left( \frac{\text{Force}_{\text{roll}}}{\text{Force\_Gain}_{\text{VCA}}} \right)^2$   $P_{\text{VCA}} = 1.397 \times 10^{-3}\text{ W}$



# Me4: Simulated 2D performance of a notional passive isolator 5/9



Integrated Design Capability / Instrument Design Laboratory

- By creating a simplified 2D mechanism model in WM2D\*, it is possible to animate the expected motion of a notional passive angular jitter attenuation technique.

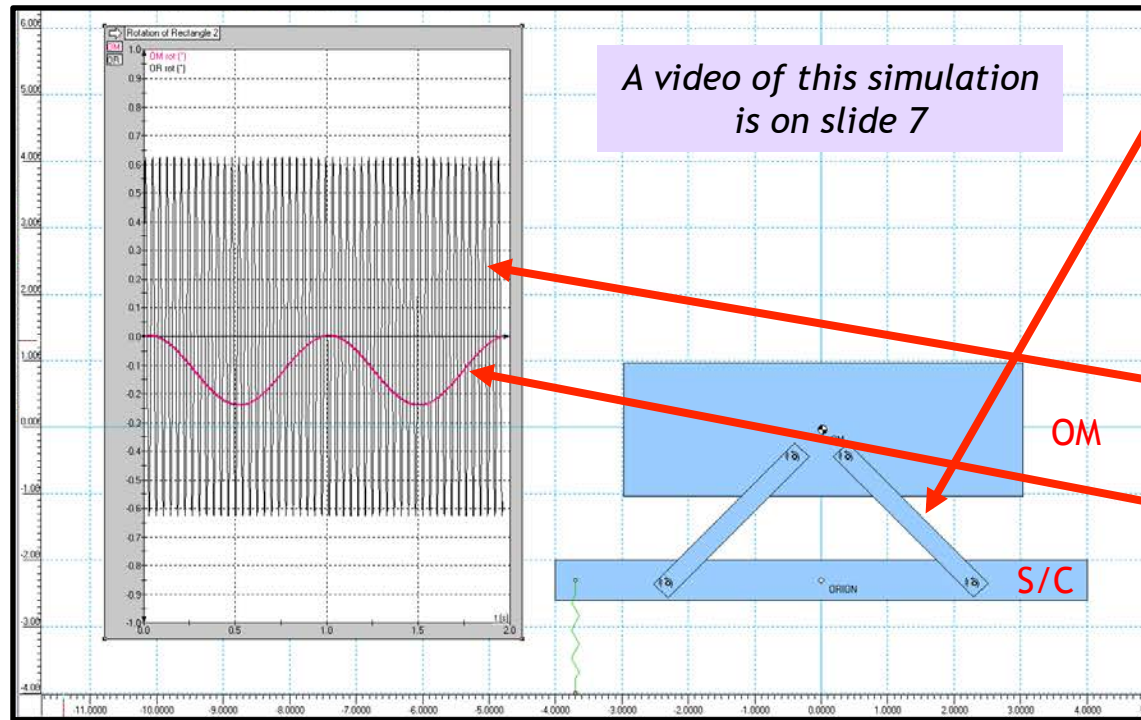

- Two dual flexures attach the OM to S/C
  - Each flexure stiffness is  $10 \text{ N-m/}^\circ$ , for an effective  $\kappa$  of more than  $20 \text{ N-m/}^\circ$
  - OM MOI =  $40 \text{ kg-m}^2$
  - Res freq =  $0.85 \text{ Hz}$
- An angular motion is imposed on S/C:
  - S/C is pivoted and given an initial angular velocity;
  - A linear spring from ground to S/C causes an angular oscillation at  $\sim 25 \text{ Hz}$ .
- The result:
  - If S/C oscillates at  $25 \text{ Hz}$  with an amplitude of  $\sim \pm 0.6^\circ$ , and...
  - ...this motion is transmitted to the OM through these flexures,...
  - ...the OM would oscillate at  $1 \text{ Hz}$  with an amplitude of  $\sim \pm 0.24^\circ$  (the  $1 \text{ Hz}$  is the resonant frequency of the flexures and the OM MOI)
- So the OM is now required to compensate for a  $1 \text{ Hz}$  disturbance, rather than the  $25 \text{ Hz}$  disturbance of the S/C.
  - Note that no damping is included here; in an actual implementation, damping would reduce the  $1 \text{ Hz}$  amplitude.

- WM2D = Working Model 2D software

Design Simulation Technologies, Inc.  
 43311 Joy Road, #237  
 Canton, MI 48187  
<http://www.workingmodel.com>



# Me4: Video of 2D model of passive damper 6/9



Integrated Design Capability / Instrument Design Laboratory

- Click your cursor on the large black rectangle below to see the start triangle.





# Me4: Transmitted Angular Jitter 7/9

Integrated Design Capability / Instrument Design Laboratory

- The **orange** data on this plot shows the angular jitter spectrum of a typical host spacecraft.
  - The horizontal axis is frequency in Hz; the vertical axis is RMS amplitude in microradians.
- The **-40 db/decade** attenuation of the passive flexure suspension is shown as the **red** line; the estimated corner frequency is **1.73 Hz**
  - If the red line is multiplied by the orange data, the result is the transmitted angular jitter RMS amplitude vs. frequency.
- With no attenuation below 1.73 Hz, the actuators must reduce the low frequency jitter to less than 0.1 arcsec, the required pointing accuracy.
- This low frequency jitter appears to be under 10 microradians (2 arcsec) RMS\* between 0.001 Hz and 0.2 Hz as shown by the **blue** line. (\*with higher peaks)
- With angular rate sampled at 15 Hz, we can achieve an active BW of about 3 Hz, which overlaps the 1.73 Hz passive BW.

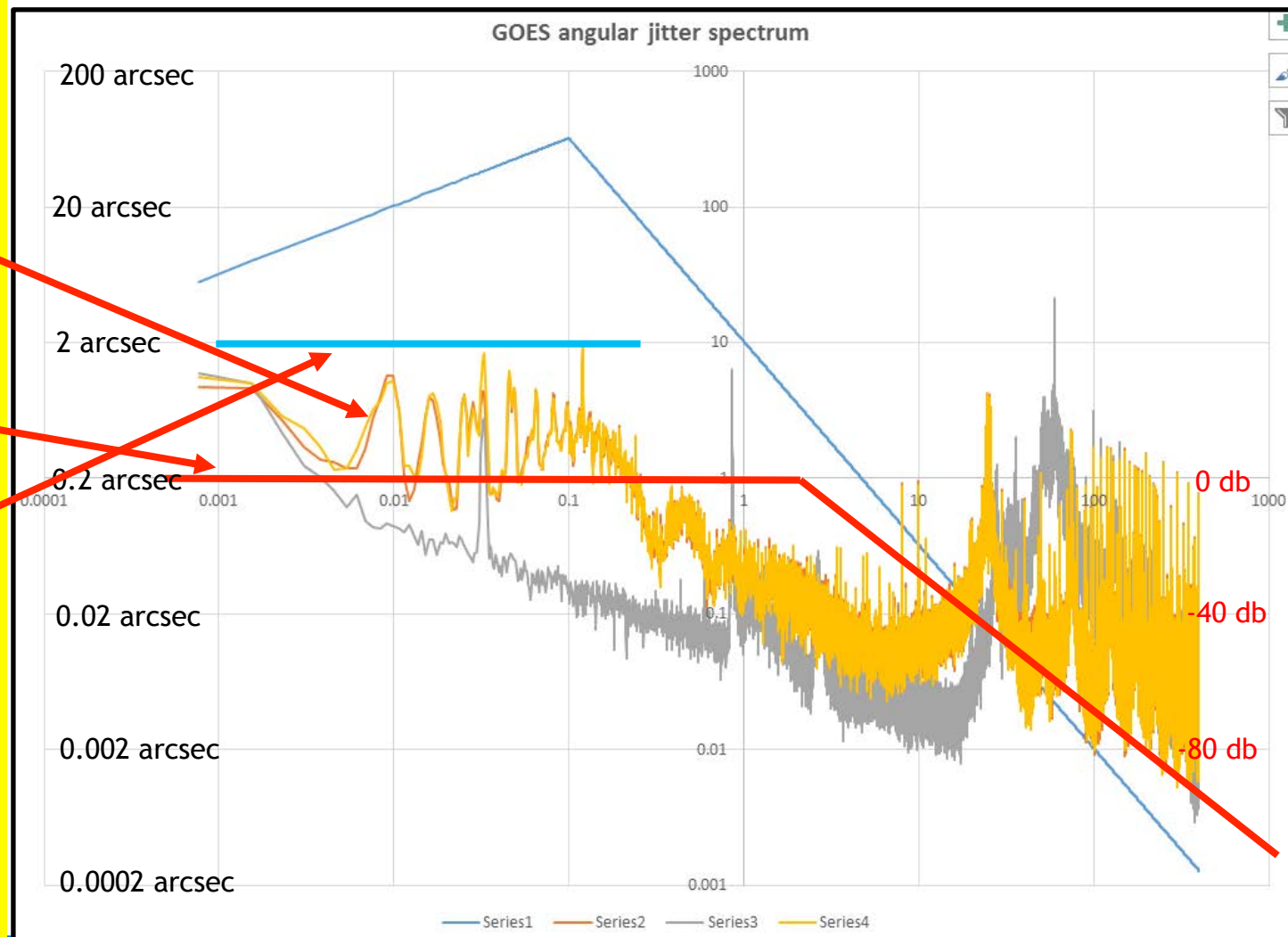

# Me4: VCA Angular motion limits 8/9

Integrated Design Capability / Instrument Design Laboratory

- In this design, the coils of all three voice coil actuators are hard mounted to the instrument, and the magnet assemblies are hard mounted to the spacecraft.
- So, when the instrument rotates about its CG, the actuator coils will move in all directions; specifically, each actuator will move radially as well as axially.
- The actuator coils can move  $\pm 0.125$ " axially, but, due to their small radial clearance, they are limited to a radial motion of  $\pm 0.018$ ". This limited radial clearance would limit the angular motion of the instrument:

Jitter and roll rotations of GeoPath WAS instrument			
Coil to magnet clearance		0.018	inches each side
Axis of Rotation	radius of actuator, in	Allowable radial angular motion before contact, $\pm$ deg	
X	40	0.026	
Y	40	0.026	
Z (Roll)	40	0.026	

*This is an active Excel spreadsheet; double click and update the values as they are available.*

- With stock actuators, the radial clearance is made small to maximize performance.
- But the maximum roll error of  $0.1^\circ$  will cause contact within the X & Y actuators (not the roll actuator, its stroke is  $1m (40") \times \pm 0.1^\circ = \pm 0.07"$ , less than its capability of  $\pm 0.125"$ ).
- So, our options are:
  - Use X and Y VCAs with a larger radial clearance; or
  - Attach the X and Y coils to their magnets with flexures to remove coil-to-magnet radial motion, and use another flexure to transmit axial X and Y actuator coil motion to the instrument.

# Me4: Increasing the VCA Angular motion limits 9/9



Integrated Design Capability / Instrument Design Laboratory

- To increase the allowable angular motion limits of the instrument, we can maintain the alignment between a VCA coil and its magnet by adding two flexures and a flex rod to the VCA; the flexures limit the VCA output to linear motion; the rod transmits that linear motion to the instrument. Housed VCAs are also available...

## “Linear Voice Coil Actuators - Housed

Housed VCAs models have been designed to simplify the use of linear voice coil actuators. With internal linear bearings the housed actuator design captures the coil assembly mechanically to keep it concentric within the field assembly as well as limiting the axial travel on both ends of the stroke. BEI Kimco’s housed actuators range from 1.2 to 2.76 inches in diameter with peak forces ranging from 3.5 to 60 Lbs. The total stroke range of BEI Kimco’s semi-housed actuators is 0.25 to 0.98 inches.

Housed voice coil actuators are ideally suited for such demanding applications as semiconductor equipment, defense systems and life-sustaining medical systems. Housed VCA same as Semi-Housed but with enclosure and connector for some mechanical and environmental protection and for ease of use in system integration.”

...but without knowing the friction and durability of these linear bearings, we should insist on the use of frictionless, high reliability flexures.

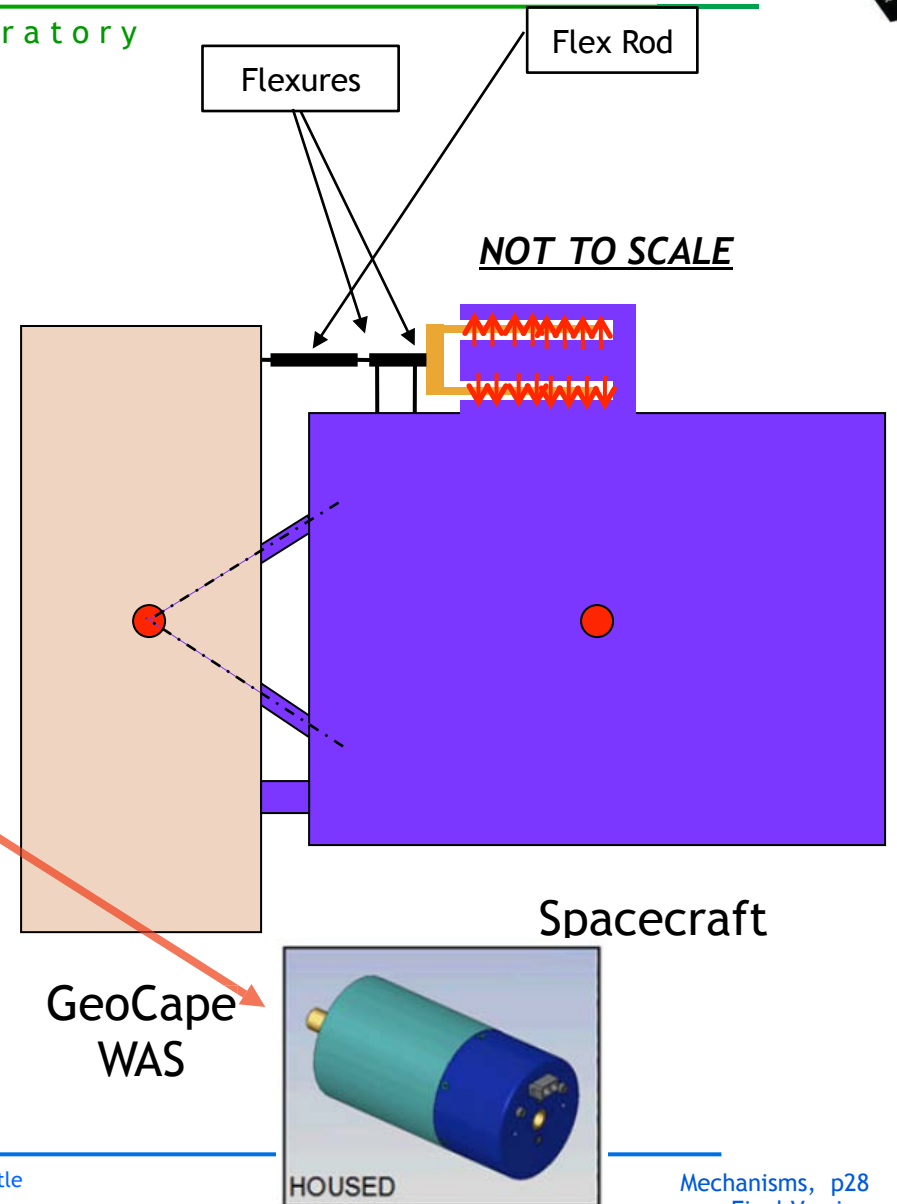

# Me5: Contamination Door

Integrated Design Capability / Instrument Design Laboratory

- **Primary Requirements:**

- Protect the optics from ground contamination and host spacecraft contamination
- Dry N2 purge requires a close fitting labyrinth seal to minimize purge flow rate
- Diameter: 706mm

- **Proposed Design:**

- Instrument contamination doors have flown many times; common features are:
  1. A door rotating on redundant sliding surface bearings;
  2. Labyrinth seal at outer edge of door.
  3. A latch with redundant HOP (High Output Paraffin) actuators;
  4. Kickoff springs to establish the deployment angular rate;
  5. Torsion springs to maintain that rate against friction torques and restrain the door against on-orbit moments;
  6. A travel stop with energy absorbing material to reduce the impact loads at the end of travel;

# Me5: Door Latch: HOP Latch

Integrated Design Capability / Instrumentation

## RL-300 Mechanically Redundant Restraint Latch

- Power input: 10 Watts
- Operating Time: 90 sec at +24C
- Operating Temp Range: -40C to +70C
- Survival Temp Range: -40C to +70C
- Note max temp is limited by self-actuation\*
  - \* Paraffin melting temperature

### System Description:

The RL-300 Mechanically Redundant Panel Restraint latch provides an off the shelf solution to small satellite panel latching and deployment. The latch is capable of holding up to 300 lbf. It has a fully redundant release mechanism consisting of two shuttles, each driven by a paraffin actuator. The latch also has redundant telemetry that can be wired to either signal or cut power after release.



### System Operation:

The release-bolt has a spherical end that is attached to a latch-plate that allows a 3° bolt misalignment. The triangular shaped latch-plate is held in place by the shuttles and the body of the mechanism. When either of the shuttles retracts the latch-plate is released with the bolt.

### Features:

- Fully redundant release mechanism
- 300 lbf latch capability
- Low mass
- 3° latch-bolt misalignment capability
- Extensive paraffin actuator flight history
- Auto shut-off and/or telemetry capability

### Product Specifications

MECHANICAL	US	SI
Latch Envelope Dimensions	2.5x3.75x2 in	6.4x9.5x5.1cm
Release Bolt Height	Depends on application	
Misalignment Capability	3°	
Mass	9.88 oz (including deployable hardware)	280 g (including deployable hardware)
Life Cycles	>50	
Redundancy	Electrical, Mechanical, Telemetry	
Operation time	~90 sec @ +24° C	
Preload Capability	300 lbf	33.9 N
Deployable Mass	2.47 oz (depending on application)	70g (depending on application)
<b>ELECTRICAL</b>		
Power Input	10 Watts	
Telemetry	2 micro switches (11HM1 Honeywell)	
Connectors	207262-2 nine pin connector	
Pinouts	8 pins	
<b>THERMAL</b>		
Operating Temperatures	-40° to +158° F (depending on paraffin used)	-40° to +70° C (depending on paraffin used)
Heater Resistance	~76 Ω	
<b>RESET</b>		
Tools Needed	Preload and C-clamp reset tools Provided	
Reset Time	~15 minutes	

### NOTES:

Latch will need snubber (cup/cone) to counter torsional and bending moments generated by preload. Cup/cone will also take shear loads, as this mechanism is not designed to take shear loads.  
Data for information only and subject to change. Contact SNC Space for design data.

# Conclusions and Concerns

Integrated Design Capability / Instrument Design Laboratory

- **Conclusions**

- Me1: Diffuser Wheel                    low risk, but it is quite large...
- Me2: Scan Mirror                        low risk, but launch locks will be needed to keep bearing preloads low and friction torques small.
- Me3: Fast Steering Mirror            low risk.
- Me4: Jitter/Roll Suppression        needs development due to new concept of passive low pass mechanical rotation filter, also the roll actuator must rotate the entire instrument to remove roll error.
- Me5: Contamination Door            low risk.

- **Concerns**

- **Me4: This proposed design removes only the ANGULAR jitter motion imposed by the spacecraft. Will the instrument - and all its sensors and optics - be affected by the LINEAR jitter motion also imposed by the spacecraft - and is NOT removed by this suspension?**



# Future Work

Integrated Design Capability / Instrument Design Laboratory

- Most of the mechanisms described here have been used many times; the exception is Me4, the active jitter suppression system.
- More specifically, the use of flexures to passively reject high frequency angular jitter is a new concept, and needs further analysis and prototype testing to verify its viability.
- However, since the concept does not involve any technological breakthroughs, but only requires the proper use of basic rigid body mechanics, the analysis and testing efforts should be straightforward.





# Backup Slides

Integrated Design Capability / Instrument Design Laboratory

- **Me1 backup:**
  - V groove ball bearing
- **Me2 backup:**
  - Renishaw Encoder (2 slides)
- **Me3 backup**
  - Voice Coil Actuator Specs
- **Me4 backup:**
  - Development of Jitter Mount Concept (4)
  - Flexure Assembly Detail
  - Effect of flexure length
  - A flexure mount that creates motion clearance





# Me1: Dual race V groove bearings

Integrated Design Capability / Instrument Design Laboratory

- Chart from [http://www.nationalprecision.com/ball-bearings/guide-wheel\\_v-groove\\_bushings.php](http://www.nationalprecision.com/ball-bearings/guide-wheel_v-groove_bushings.php)
- Lubrication notes (not shown): <http://www.pbcliner.com/Download/WhitePaper/Lubrication-for-Linear-Roller-Bearings-and-Raceways.pdf>

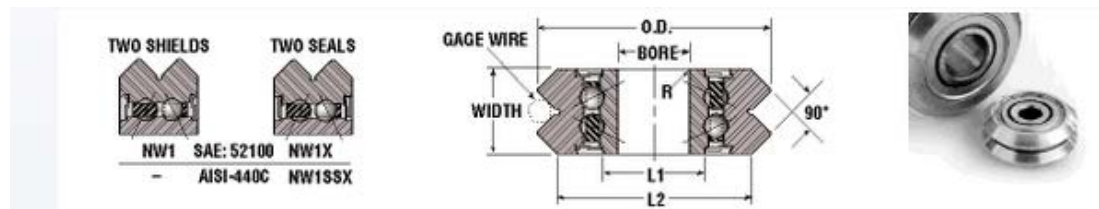

V GROOVE GUIDE WHEEL BEARINGS														
NPB Part No. RFQ per item	Industry Part No.	Bore +.0000 -.0003	O.D. +/- .005	Width +.0000 -.0050	L1 Ref.	L2 Ref.	R Will Clear Radius	Gage Wire Diam.	Dynamic Radial Load Lbs. Based on avg. life of 2500 hours				Thrust Load Lbs.	Static Radial Load Lbs.
									33.3 RPM	100 RPM	500 RPM	1000 RPM		
<a href="#">NW1</a>	W1	.1875	.771	.3100	.314	.625	.012	.0937	350	245	145	112	65	245
<a href="#">NW1X</a>	W1X	.1875	.771	.3100	.314	.625	.012	.0937	350	245	145	112	65	245
<a href="#">NW1.SSX</a>	W1SSX	.1875	.771	.3100	.314	.625	.012	.0937	310	218	126	100	55	200
<a href="#">NW2</a>	W2	.3750	1.210	.4375	.530	1.000	.012	.1250	734	487	288	227	122	610
<a href="#">NW2X</a>	W2X	.3750	1.210	.4375	.530	1.000	.012	.1250	734	487	288	227	122	610
<a href="#">NW2.SSX</a>	W2SSX	.3750	1.210	.4375	.530	1.000	.012	.1250	562	390	230	183	90	455
<a href="#">NW3</a>	W3	.4724	1.803	.6250	.640	1.500	.024	.1875	1338	925	543	435	535	910
<a href="#">NW3X</a>	W3X	.4724	1.803	.6250	.640	1.500	.024	.1875	1338	925	543	435	535	910
<a href="#">NW3.SSX</a>	W3SSX	.4724	1.803	.6250	.640	1.500	.024	.1875	1070	745	434	349	428	705
<a href="#">NW4</a>	W4	.5906	2.360	.7500	.878	2.000	.024	.2500	2055	1405	815	650	655	1235
<a href="#">NW4X</a>	W4X	.5906	2.360	.7500	.878	2.000	.024	.2500	2055	1405	815	650	655	1235
<a href="#">NW4.SSX</a>	W4SSX	.5906	2.360	.7500	.878	2.000	.024	.2500	1593	1129	648	520	510	955

**Guide wheel bearings** are precision ground, double row, angular contact bearings. These bearings are pre-lubricated and available in either 52100 chrome or 440C stainless steel. Although the standard chrome steel version is available either sealed or shielded, the stainless steel design is available sealed only. The concentric and adjustable bushings provide a simple, effective means of adjusting the free play of the guide wheel system.

# Me2: Renishaw REXA Rotary Encoder

Integrated Design Capability / Instrument Design Laboratory

From <http://resources.renishaw.com/en/details/data-sheet-rexa-ultra-high-accuracy-absolute-angle-encoder--44234>

- Accuracy is  $\pm 1$  arcsec
- Repeatability of  $\pm 0.01$  arcsec
- So on-orbit mapping may be necessary to achieve ground truth accuracy to 0.1 arcsec (10% of pixel size)

- Encoder electronics mass

- Two readheads@19gm: 36 gm
- Cable: 32 gm/m
- Interface box: 218 gm

**With zero coupling losses and exceptional repeatability, the REXA ultra-high accuracy angle encoder achieves better than  $\pm 1$  arc second total installed accuracy.**

Like the RESM encoder, the REXA is a stainless steel ring with the scale graduations marked axially onto the periphery, but with a number of differences to improve upon RESM's already impressive accuracy.

REXA has a thicker cross-section to ensure that the only significant installation error is eccentricity.

Eccentricity is easily removed by using 2 readheads, and combining the signals inside the host controller.

The only errors remaining are graduation errors and readhead SDE, both of which are so small they are often negligible.

As a non-contact encoder, REXA offers dynamic performance advantages, eliminating coupling losses, oscillation, shaft torsion and other hysteresis errors that plague enclosed encoders.

The REXA system operates at temperatures up to  $+80$  °C and speeds to 8 500 rev/min.

REXA total installed accuracy grades:

REXA diameter	Total installed accuracy (with 2 readheads)
$\geq 100$ mm	$\pm 1$ arc second
75 mm	$\pm 1.5$ arc second
$\leq 57$ mm	$\pm 2$ arc second

- Use with two **RESOLUTE**™ readheads to give ultra-high accuracy
- Installed accuracy to  $\pm 1$  arc second with dual readheads
- Sub-divisional error to  $\pm 0.04$  arc second
- Resolutions to 0.00030 arc second
- Repeatability to 0.01 arc second
- Wide range of standard sizes from 52 mm to 417 mm
- Large internal diameter for ease of integration
- Flange mounted with easy 4-point adjustment method

# Me2: Renishaw REXA Rotary Encoder

Integrated Design Capability / Instrument Design Laboratory

- Ring diameter of 417mm assumed in MEL

Ring diameter (mm)	200	206	209	229	255	300	350	417
Mass (kg)	1.35	1.43	1.49	1.68	2.02	2.73	3.59	5.09
Inertia (kg-cm <sup>2</sup> )	99	111	118	164	246	468	845	1 700

# Me3: Voice Coil Actuator Specs

Integrated Design Capability / Instrument Design Laboratory

- From <http://www.beikimco.com/pdf/LA15-16-024%20%28LTR%29.pdf>

WINDING CONSTANTS *	UNITS	TOL	SYMBOL	WDG A	WDG B
DC RESISTANCE	OHMS	±12.5%	R	4.7	15.0
VOLTAGE @ $F_p$	VOLTS	NOMINAL	$V_p$	33.0	58.6
CURRENT @ $F_p$	AMPERES	NOMINAL	$I_p$	7.02	3.91
FORCE SENSITIVITY	LB/AMP	±10%	$K_f$	2.85	5.12
	N/AMP	±10%		12.68	22.77
BACK EMF CONSTANT	V/FT/SEC	±10%	$K_B$	3.86	6.94
	V/M/SEC	±10%		12.68	22.77
INDUCTANCE ****	MILLI-HENRY	±30%	L	1.25	4.05

ACTUATOR PARAMETERS *	UNITS	SYMBOL	VALUE
PEAK FORCE **	LB	$F_p$	20.0
	N		89.0
CONTINUOUS STALL FORCE ***	LB	$F_{cs}$	5.5
	N		24.47
ACTUATOR CONSTANT	LB/√WATT	$K_A$	1.31
	N/√WATT		5.83
ELECTRICAL TIME CONSTANT	MICRO-SEC	$\tau_e$	270
MECHANICAL TIME CONSTANT	MILLI-SEC	$\tau_m$	1.28
POWER $I^2R$ @ $F_p$	WATTS	$P_p$	232
STROKE	± INCHES		0.125
	± MM		3.18
CLEARANCE ON EACH SIDE OF COIL	IN		0.018
	MM		0.46
THERMAL RESISTANCE OF COIL	°C/WATT	$\theta_{th}$	5.0
MAX. ALLOWABLE COIL TEMP.	°C	TEMP	155
WEIGHT OF COIL ASSEMBLY	OZ	$WT_c$	1.55
	G		43.94
WEIGHT OF FIELD ASSEMBLY	OZ	$WT_f$	6.5
	G		184.27

\* 25°C AMBIENT TEMPERATURE  
 \*\* 10 SECONDS AT 25°C AMBIENT & 155°C COIL TEMP  
 \*\*\* 25°C AMBIENT & 155°C WINDING TEMPERATURE  
 \*\*\*\* MEASURED AT 1000 Hz

END

# Me4: Development of Jitter Mount Concept 1/4

Integrated Design Capability / Instrument Design Laboratory

- Conceptually, mount the instrument at its C.G. (Center of Gravity) with a “frictionless spherical bearing”, so there are no angular moments applied to it by the angular jitter of the spacecraft. The attenuation of angular jitter is theoretically infinite at all frequencies.
- (\*Note that the “Combined C.G.” is calculated from the MOI of the spacecraft and only the  $md^2$  term of the instrument MOI.)

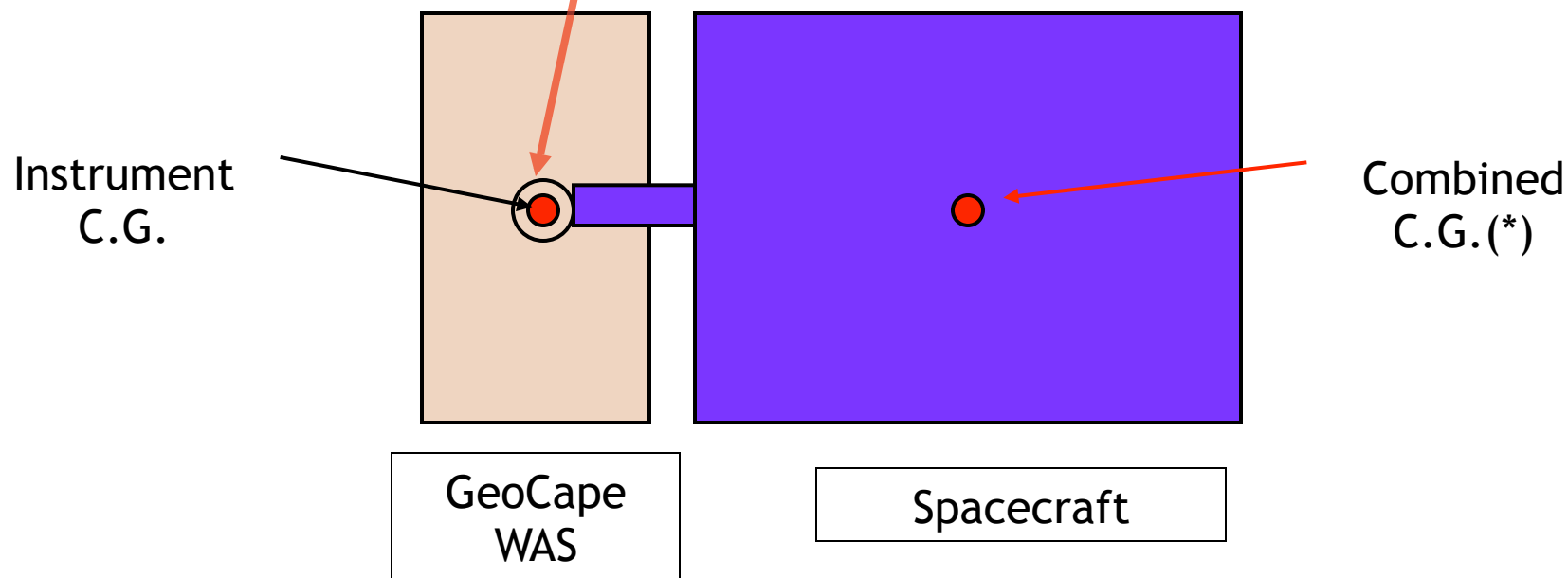

# Me4: Development of Jitter Mount Concept 2/4

Integrated Design Capability / Instrument Design Laboratory

- But a frictionless spherical bearing is impossible to build, so let's replace it with three flexures forming a tripod pointed at the instrument C.G. For limited angular travel, they will act as a frictionless bearing with small, easily measured angular spring rates.

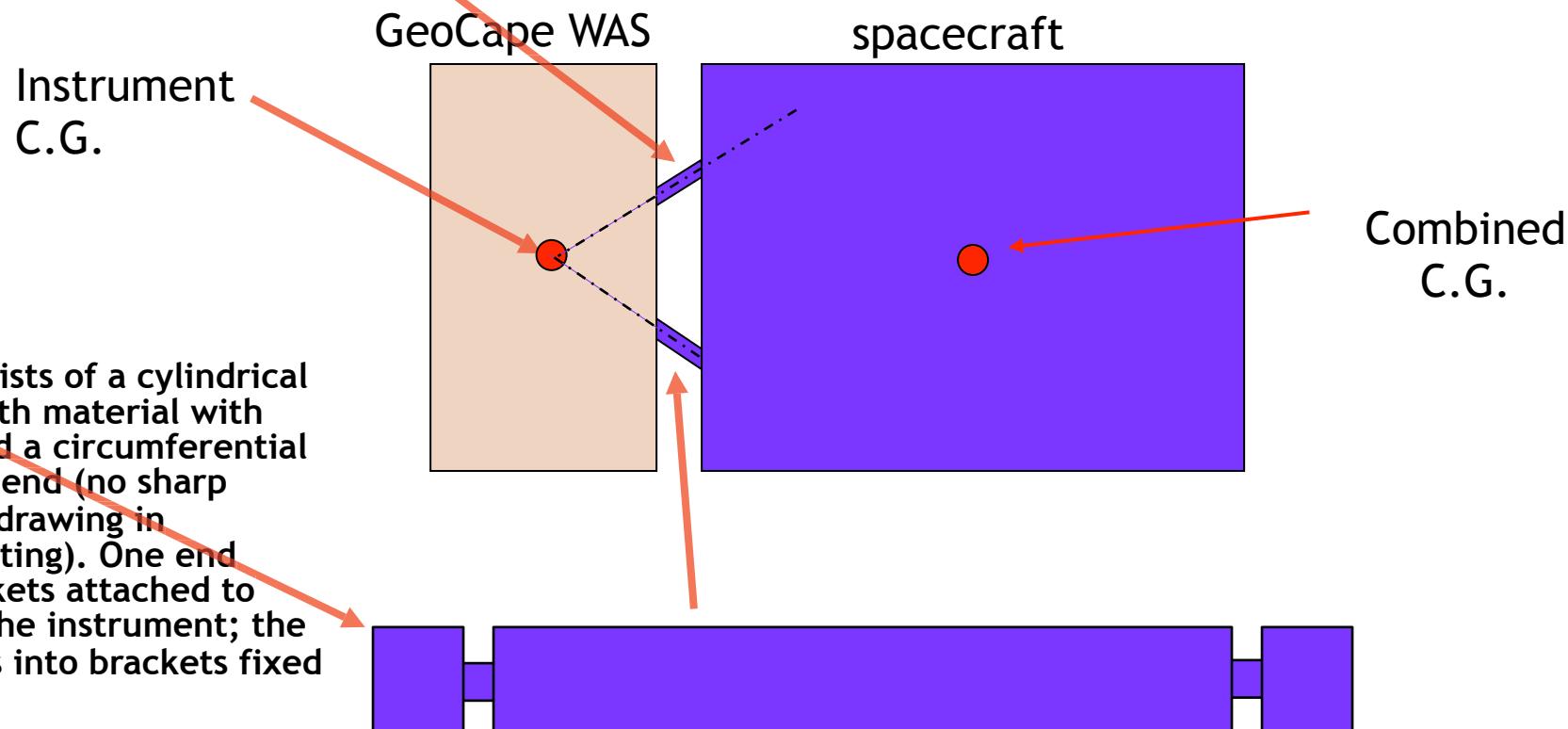

- Each flexure consists of a cylindrical bar of high strength material with threaded ends and a circumferential groove near each end (no sharp internal corners; drawing in PowerPoint is limiting). One end threads into brackets attached to strong points on the instrument; the other end threads into brackets fixed to the S/C.

# Me4: Development of Jitter Mount Concept 3/4

Integrated Design Capability / Instrument Design Laboratory

- We will add three active linear voice coil actuators at some distance from the instrument C.G. to damp angular motions of the GeoCape WAS instrument.
- The actuators' task will be minimal, since the flexure mounting passively removes the high frequency angular S/C jitter.

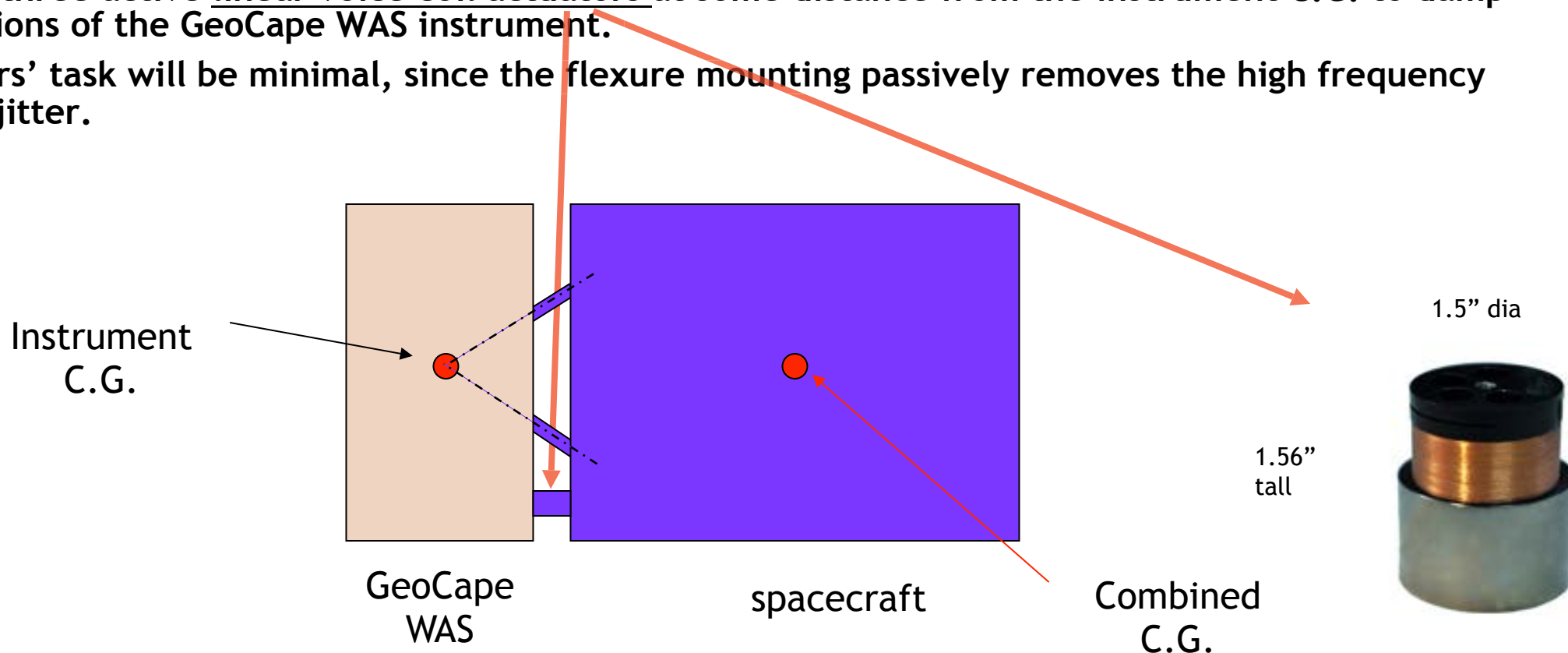

# Me4: Development of Jitter Mount Concept 4/4

Integrated Design Capability / Instrument Design Laboratory

- *But how do we ensure that the effective pivot of the flexures is precisely at the C.G. of the instrument?*
- In two steps:
  1. Careful instrument design in a 3D modeler would place the vertex of the flexures close to the instrument C.G.
  2. Fine tuning with ballast masses during Flight Acceptance vibration testing of the instrument would fine tune the instrument C.G. to locate it at the effective pivot of the flexures.

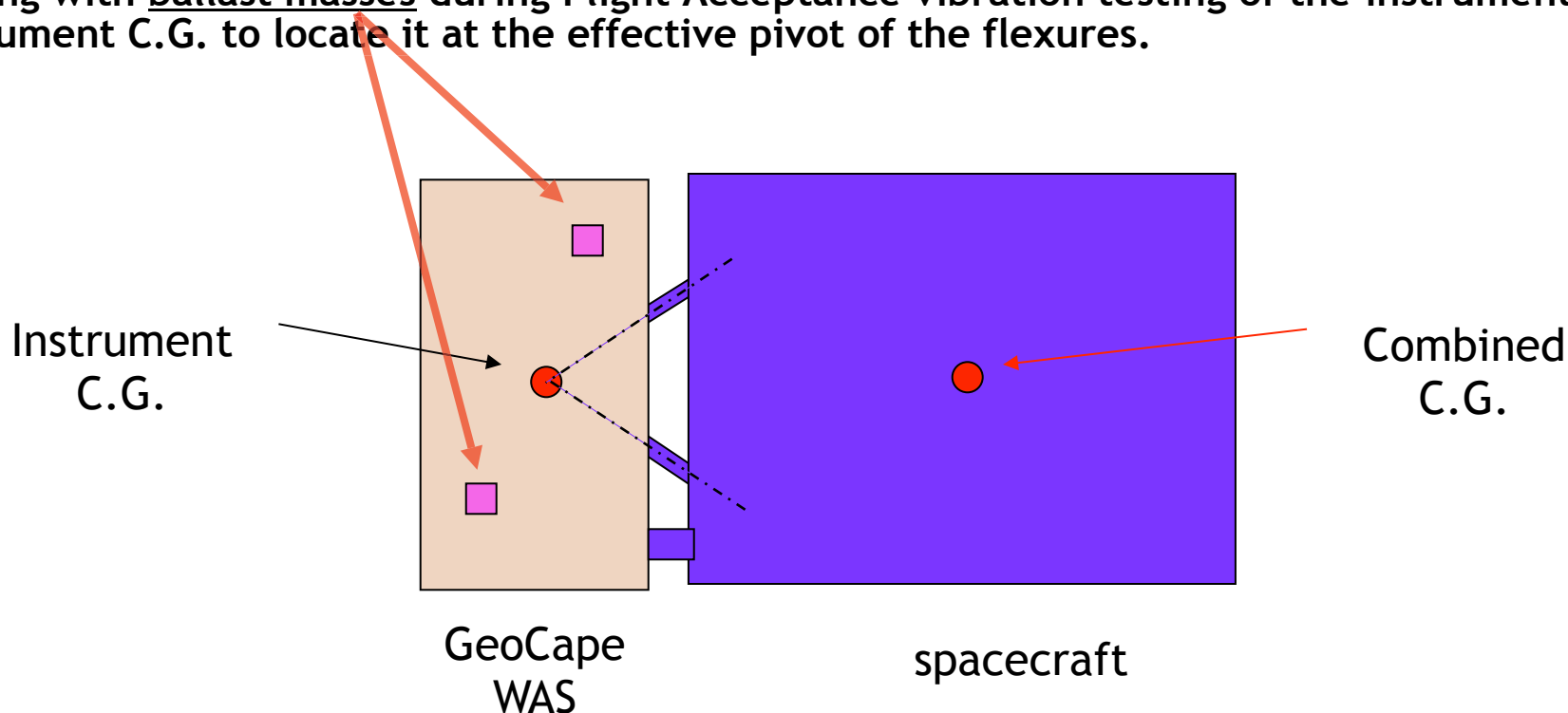



# Me4: Flexure Assembly Detail

Integrated Design Capability / Instrument Design Laboratory

- For this application, each flexure assembly conceptually is a rigid solid bar with circumferential grooves near each end.
- In practice, most of the bar could be an aluminum tube, with a high strength flexure threaded into each end of the tube.
- The outer ends of these flexures would also be threaded to attach the fitting to the spacecraft and instrument.
- The bending spring rate “K” of each flexure is derived elsewhere as:
- $K = E * I / L$ , where E = modulus, I = area MOI, L = length

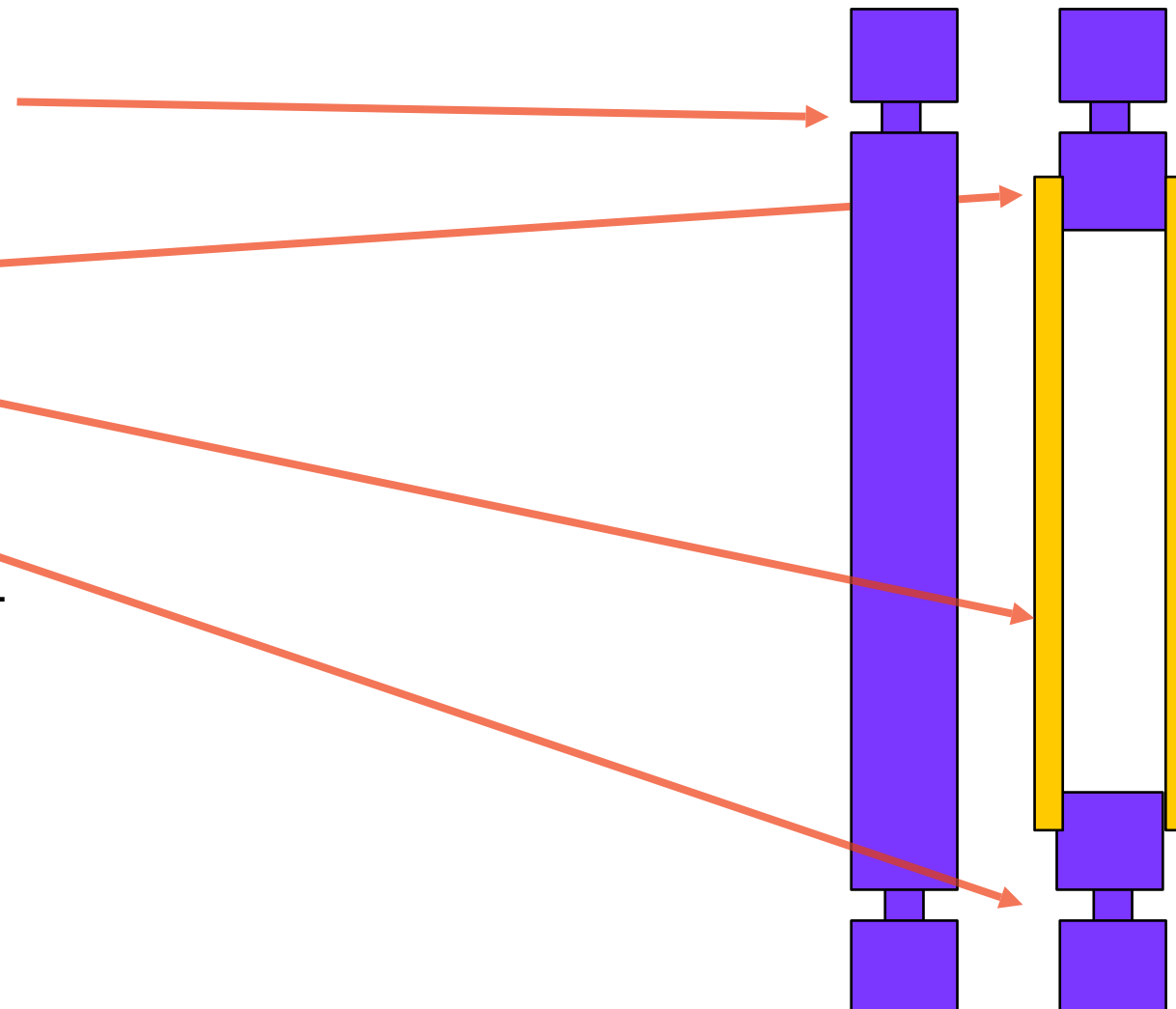

# Me4: Effect of flexure length

Integrated Design Capability / Instrument Design Laboratory

- The diagram at the right defines two dimensions:
  - L1 is the distance between the flexure grooves
  - L2 is the total distance from the spacecraft flexure groove to the CG of the instrument
- With the 2D model shown, assume that  $L1 = L2$  (i.e., the spacecraft flexure is at its CG):
  - If the instrument were rotated around an axis normal to the screen, the effective torsional spring rate would be  $2*K$  for this 2D case (for the 3D case, with 3 flexures, the rate would be  $3*K$ ), since the flexures near the spacecraft do not bend.
- However, if L1 approaches zero (very short flexure assemblies), the effective rate increases:
  - Now, if the instrument were rotated around an axis normal to the screen, the effective torsional spring rate would be  $4*K$  for this 2D case (for the 3D case, with 3 flexures, the rate would be  $6*K$ ), since the flexures near the spacecraft bend just as much as the flexures near the instrument.
- **Conclusion:**
  - The ratio  $L1/L2$  should be as high as practical to minimize the effective bending spring rate and so reduce the instrument/flexure resonant frequency.

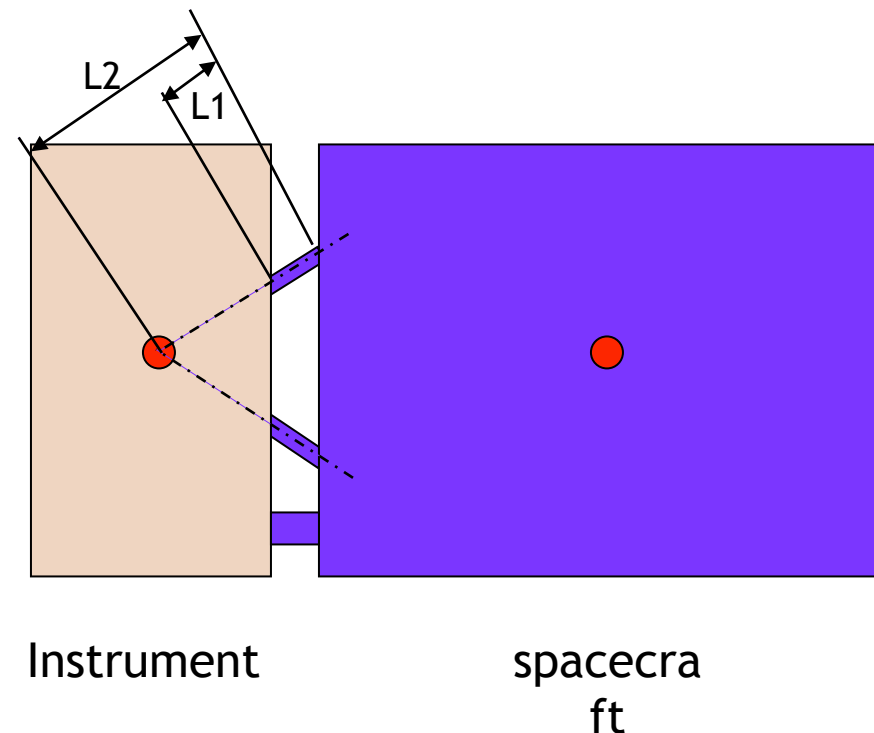

# Me4: A flexure mount that creates motion clearance

Integrated Design Capability / Instrument Design Laboratory

- For launch, the instrument is held by launch locks, but when the locks are released, the instrument must move away from the lock interface to have room to rotate through small angles to accommodate spacecraft jitter motion.
- **A means to create this motion:**
  - One end of each of the 3 flexure assemblies is supported on a sliding block with limited travel.
  - The block is preloaded to the upper end of its travel by a Belleville spring.
  - During final assembly, as the instrument is pulled down into the launch locks, each flexure assembly compresses its Belleville spring.
  - On orbit, when the launch locks are released, each Belleville spring pushes its attached flexure assembly (and the instrument) up, away from the launch lock.
- **The preload on each Belleville spring is chosen to be:**
  - More than the highest axial force expected on that flexure assembly, and
  - Less than the force that would buckle the flexures.
- **Heritage**
  - The Windsat sensor built by NRL (Naval Research Lab) rotated at 30 rpm during scanning; to create the running clearance after launch lock release, the structural lower plate was elastically deformed by the launch lock forces, so when it was released, it moved away from the stationary spacecraft, giving it clearance for rotation.

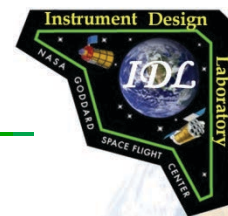

---

Integrated Design Capability / Instrument Design Laboratory

# GEO CAPE Wide Angle Spectrometer (WAS) ~ *Concept Presentations* ~

**Detectors**  
**Carl Kotecki**  
July 29, 2014

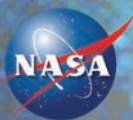

---

N A S A   G O D D A R D   S P A C E   F L I G H T   C E N T E R

# Detector Requirements

Integrated Design Capability / Instrument Design Laboratory

- **Hyper-spectral Imager: UV-VIS-NIR**

- Two bands: UV-VIS 340-600nm & VIS-NIR **600-1100nm**
  - 0.4nm resolution in band one:  $260\text{nm}/0.4 = 650$  spectral pixels needed
  - 0.5nm resolution in band two:  $500\text{nm}/0.5 = 1000$  spectral pixels needed
- Need 8k pixels in the spatial direction
- 2-D array of 15um pixels: 8192 pixels in the spatial direction X 1024 pixels in the spectral direction
- Very large SNR requirements means the detector needs:
  - High QE
  - Low read noise
  - Low dark current/noise

- **SWIR 1245, 1640 & 2135nm**

- 20, 40 and 50nm bandwidths
- The detector could be three separate 1D arrays or a single 2-D array (8192 by X) 15 X 15um pixels or (4096 by X) 30um square pixels.
  - The atmospheric correction bands as well as diffraction limited optics allows for coarser spatial resolution, 750m, at these wavelengths.

# Detector Choices

---

## Integrated Design Capability / Instrument Design Laboratory

### • UV-VIS-NIR Detector Choices

- Silicon is the best detector material choice
  - CMOS active pixel sensors
    - Not there yet: lower QE, well capacity too small, read noise too high
  - Hybrid PIN Photodiodes on ROICs such as the HAWAII-4RG
    - Low read noise, well capacity too small-integration times are too short to avoid saturation, fixed square format, 3mm gap between arrays
  - CCDs
    - Easily customized for array size and pixel size
    - Large well capacity
    - Low read noise

### • SWIR Detector Choices

- InGaAs
  - Readily available in 1-D formats
  - Requires cooling to -20C or below to reduce dark current
  - Large well sizes with moderate read noise are available
  - Material with cutoff wavelengths longer than 1.7um are more susceptible to radiation damage
  - Largest linear arrays are 1024 elements (Would need at least 4096 with 750m GSD)
- Mercury Cadmium Telluride (MCT)
  - Requires lower temperature (155K) operation to minimize dark current and noise
  - Generally not available in 1-D formats
  - 2-D formats like the HAWAII-4RG can be used, but will have a 3mm gap even though closely butted.
    - Larger well capacity with MCT still requires multiple reads to avoid saturation

# UV-VIS & VIS-NIR Custom Frame Transfer CCD



Integrated Design Capability / Instru

7/18

- Use of a standard CCD is not an option:
  - Standard CCDs with only one or two output taps cannot be read out fast enough to prevent incoming light during readout from corrupting the signal. So either a shutter or a frame transfer device is required.
    - Even so, 8 output taps are required to readout the array in 0.28sec (5 reads in 1.4sec)
    - Vertical clock speed of ~200kHz shifts frame in ~0.005sec
  - No COTS frame transfer device with the right number of pixels, pixel size and number of outputs is available.
  - Not an issue since CCDs are easily customized
    - At least two known possible vendors: STA, E2V
  - 8192 columns X 1024 rows, 15um X 15um pixels for the image area
  - 8192 columns X 1024 rows, 15um X 15um pixels for the storage area
    - Additional rows and columns may be added for dark reference pixels

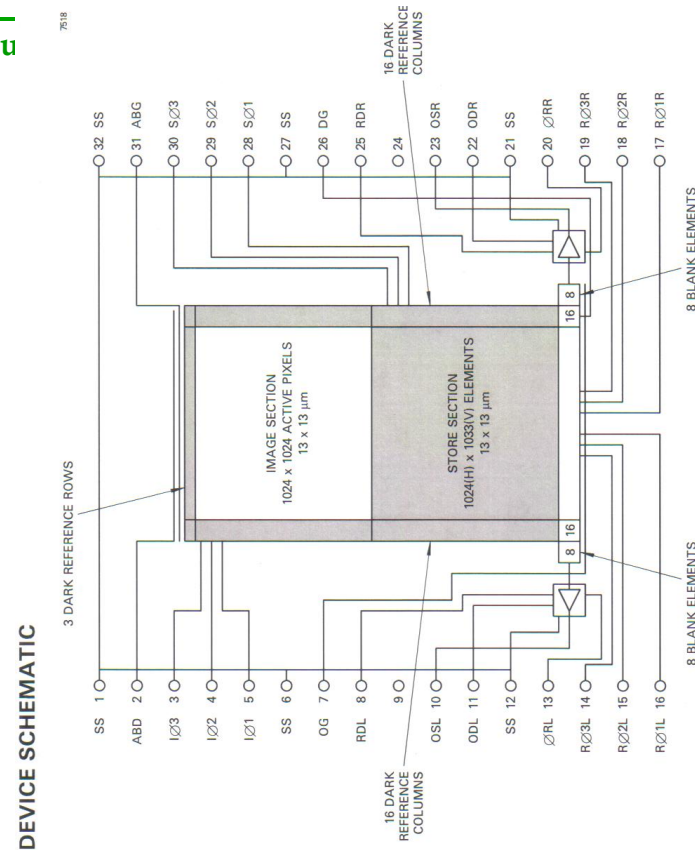

{For illustrative purposes: Actual CCDs would have an 8k x 1k imaging area and 8k x 1k storage area}



# Typical CCD Characteristics

Integrated Design Capability / Instrument Design Laboratory

TYPICAL VARIATION OF DARK SIGNAL WITH TEMPERATURE ( $V_{SS} = +9.5 \text{ V}$ )

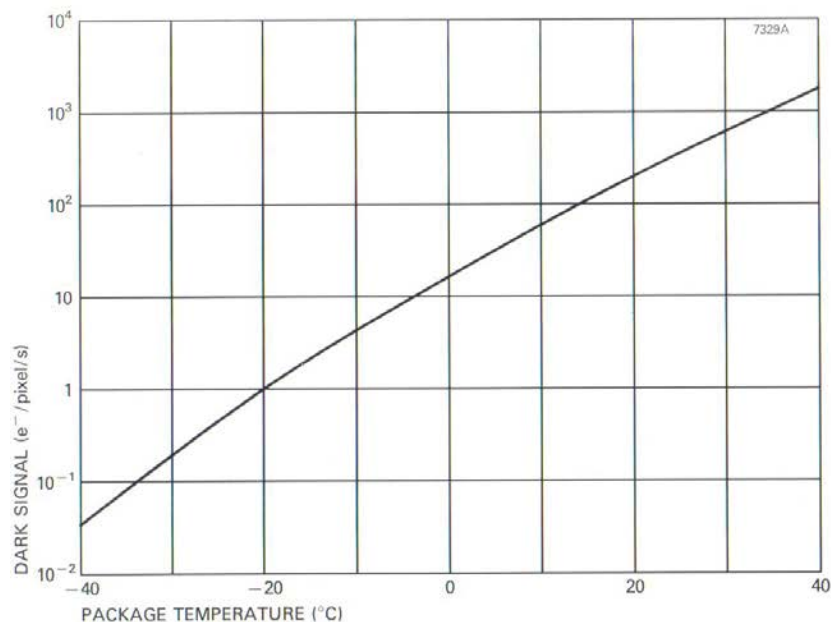

Extrapolate read noise to ~14e<sup>-</sup> @ 2MHz

TYPICAL OUTPUT NOISE

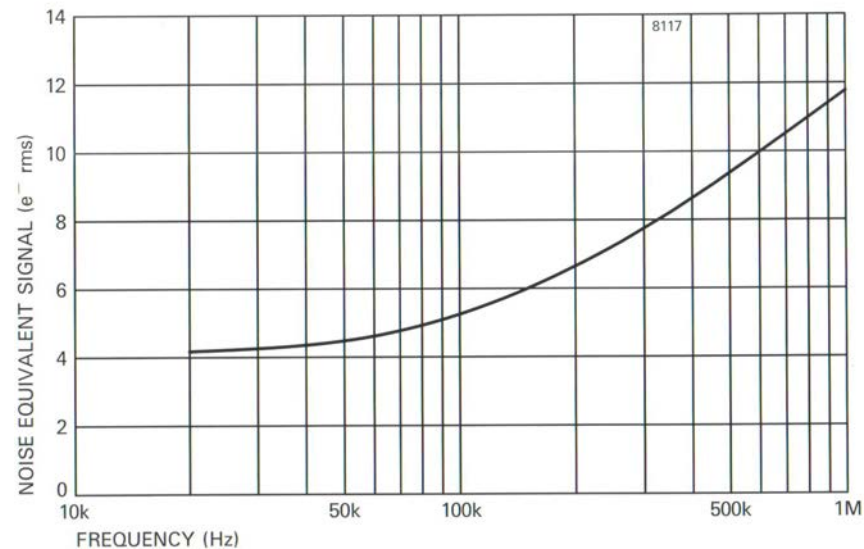

Note: Plots for E2V devices with 26um square pixels  
 Dark current will be <math>100\text{e}^-/\text{pix}/\text{sec}</math> {~0.333 (225/676) times 200} or  $35\text{e}^-/\text{pix}/0.35\text{sec}$  integration time at 20C



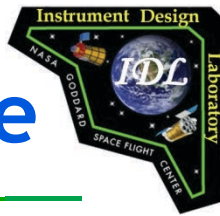

# CCD Camera Enclosure Notional Figure

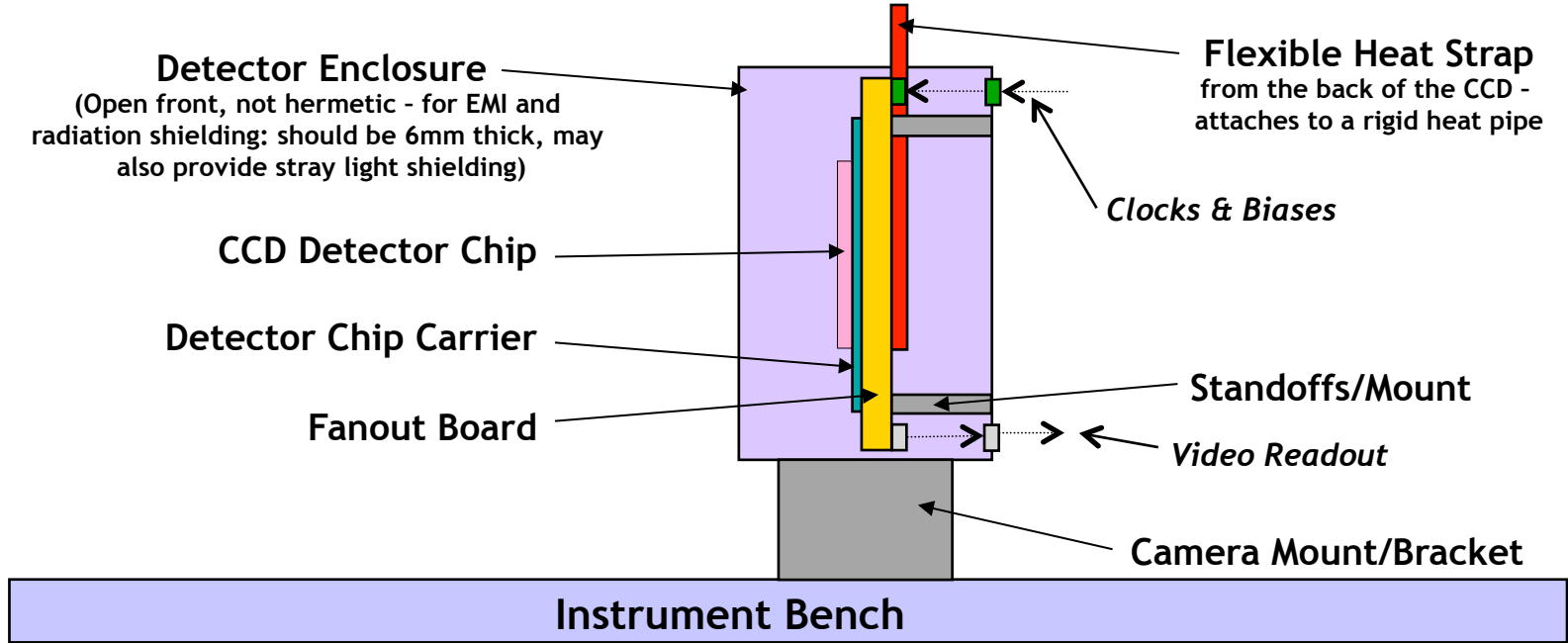

Integrated Design Capability / Instrument Design Laboratory



## Key:

-  Analog Connector - raw detector output
-  Digital Connector - clocks and biases input
-  Harness

**Note:** The ceramic detector chip carrier comes from the vendor with the silicon CCD chip permanently mounted.



# GEO Radiation Environment (for a 3 year mission)

Integrated Design Capability / Instrument Design Laboratory

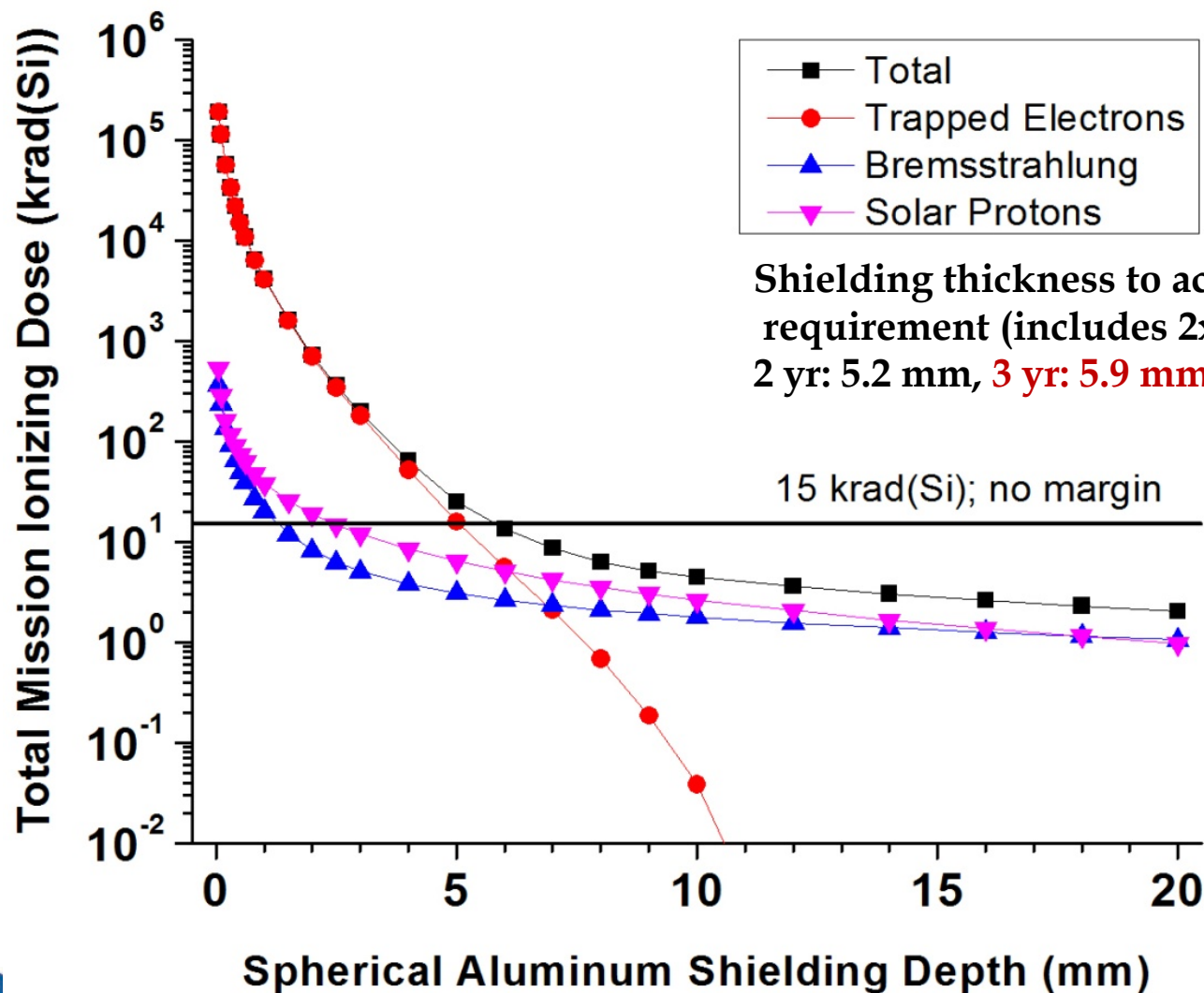

{Courtesy Jonathan Pellish}



# Teledyne HAWAII-4RG

Integrated Design Capability / Instrument Design Laboratory

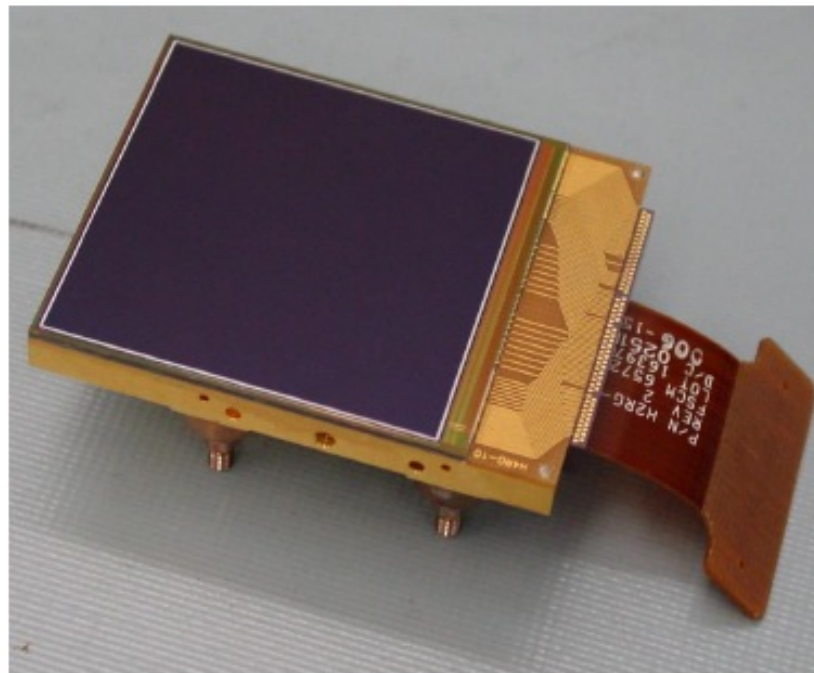
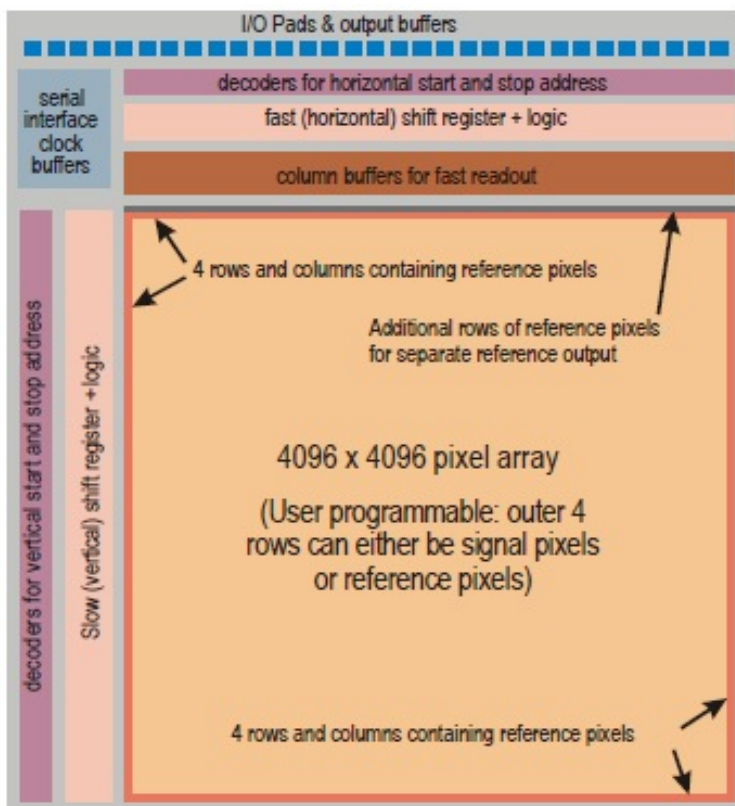

Figure 2: Block diagram (left) and photograph (right) of the HAWAII-4RG-10, hybridized to a HyViSI detector.

**Note:** The assembly comes complete from Teledyne with the MCT detector array chip, flip chip bump bonded to the Silicon ROIC, bonded to the ceramic (Al<sub>2</sub>O<sub>3</sub>) fanout board, bonded to the Molybdenum mount and micro-D connector.

# HAWAII-4RG Readout

Integrated Design Capability / Instrument Design Laboratory

- Bin multiple pixels per band
- 64 outputs from sections of 64 columns each
- 110 columns are all that is necessary, but ~1000 columns are illuminated
  - Reset pixels in illuminated area outside of bands every read cycle.
  - Periodically reset remaining non-illuminated pixels.
- 1235nm band (20)1nm pixels in one output channel, 1640 band (40) 1nm pixels spread over 2 output channels (6 & 7 channels over), 2135 band (50)1nm pixels in a single output 14 channels over)
- $64 \times 4096 = 262,144$  pixels per channel
- $262,144 \times 20 \text{ reads} / 1.4 \text{ sec} = \sim 3.75 \text{ MHz}$ 
  - Output up to 10MHz supported by both the ROIC and the SIDECAR 12 bit ADCs

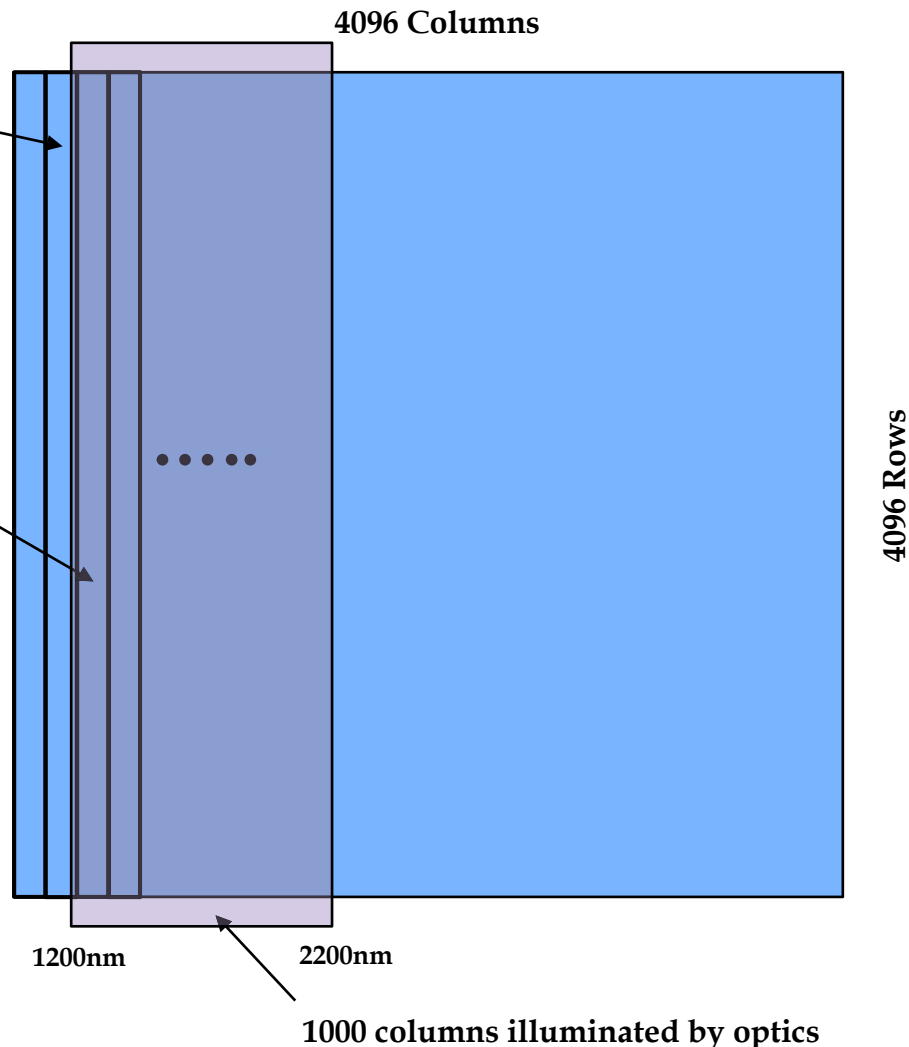

# Quantum Efficiency of Teledyne Substrate removed MCT

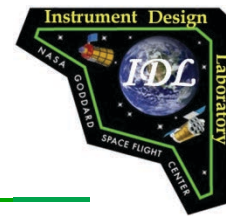

Integrated Design Capability / Instrument Design Laboratory

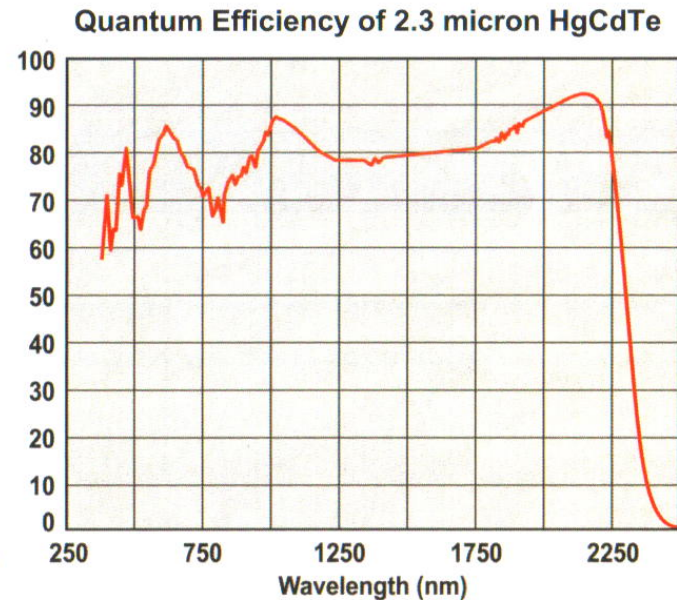
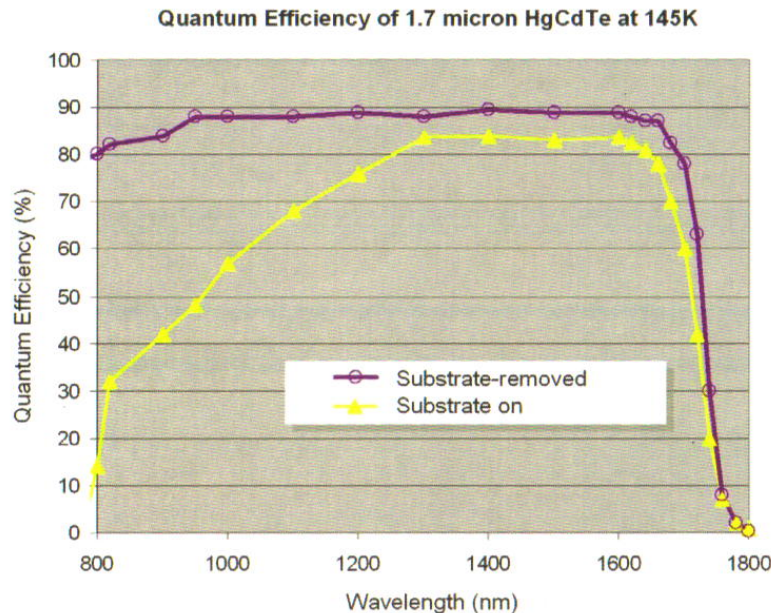

- Overall improved QE
  - Response to visible and UV
  - Less susceptible to cosmic rays

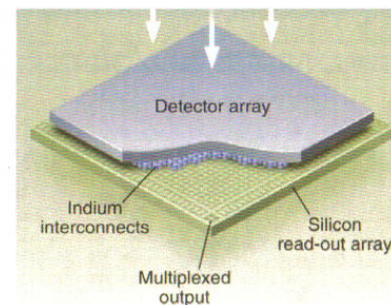

TELEDYNE  
IMAGING SENSORS

# MCT Dark Current vs Temperature

Integrated Design Capability / Instrument Design Laboratory

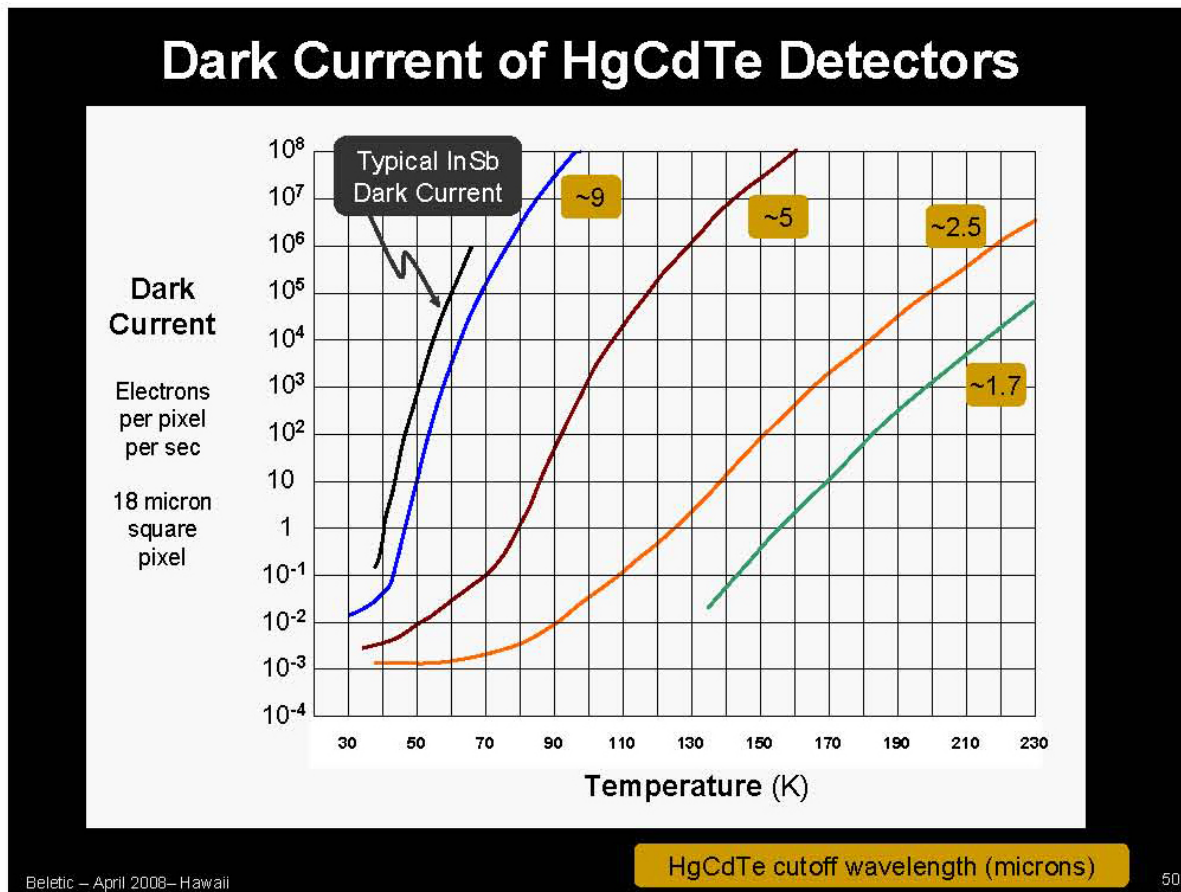

- Note: Data shown is for 18micron pixels. For 15microns pixels, values would be  $\sim 0.7X$  ( $15^2/18^2$ ). 2.5um cutoff material at 155K would be  $\sim 200e-/pix/sec \times 0.7 = 140e-/pix/sec$

# Procurement Strategy



## Integrated Design Capability / Instrument Design Laboratory

- **CCDs**

- One “blue” and one “Red” flight CCDS
- One “blue” and one “Red” flight spare CCDS
- At least three engineering units of each color type for radiation testing (each has a different thickness and AR coating optimized for the band it is being used).
  - For determining total dose effects since the major contributor is trapped electrons
    - No SEUs (single event upsets) or SEEs (single event effects) from protons or heavy ions
  - The engineering units can also be used for shake & bake qualification testing prior to radiation although no problems are anticipated (could even be waived)

- **HAWAII-4RG 2.5um MCT**

- Two flight units
- Two flight spare units
- At least three engineering units for radiation testing
  - Three for determining total dose effects since the major contributor is trapped electrons
    - Determine any increase in dark current and loss of QE in the MCT
    - Determine any total dose effect in the ROIC
      - HAWAII-2RG was tested to 200krad without issue
  - Heavy ion testing is probably not necessary
    - HAWAII-2RG was tested without issue: ROIC was not susceptible to SEUs, SEEs or latchup
      - H4RG uses the same CMOS 0.25um process and design rules as the H2RG
  - The engineering units can also be used for shake & bake qualification testing prior to radiation although no problems are anticipated (could even be waived)



# For the Combined Blue and Red Spectrometers

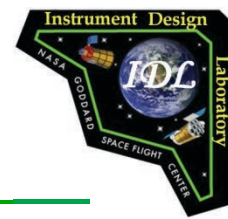

Integrated Design Capability / Instrument Design Laboratory

- Single, split frame, frame transfer CCD
- 8k x 2k total imaging area
- Two separate 8k x 1k storage areas
- Same total number of pixels and output taps as with the two separate CCDs in the baseline version
- A long wavelength pass filter over the Red half removes the higher orders from the shorter wavelength light diffracted off of the diffraction grating from landing on that half.

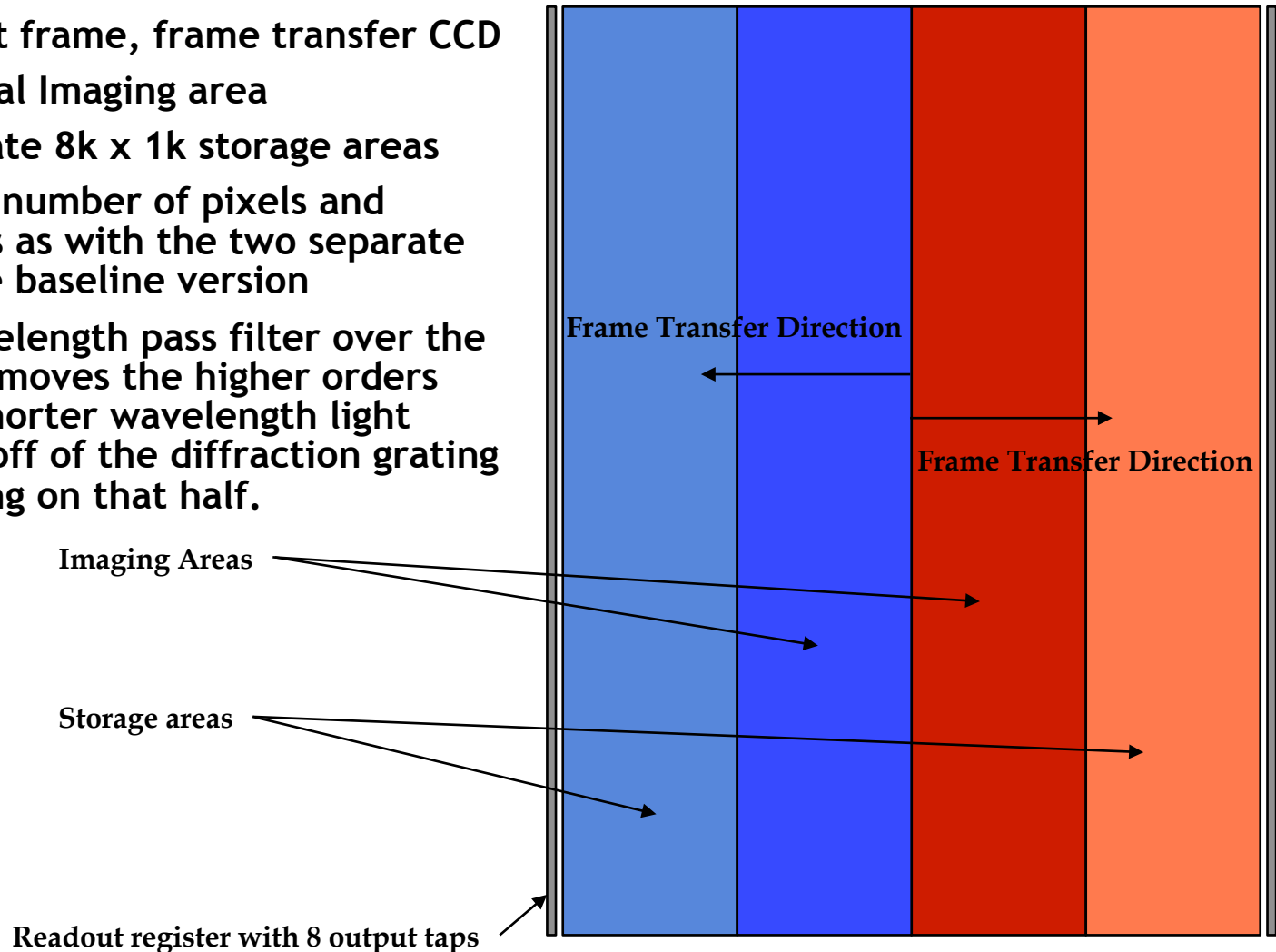





# Conclusion/Concerns

---

## Integrated Design Capability / Instrument Design Laboratory

- No new technology development is required.
- Custom CCDs are readily available for the UV-VIS-NIR wavelengths.
  - Radiation testing will be required. Typical commercial n-channel CCDs see significant degradation in performance between 5 and 35krad.
    - Increase in dark current, increased noise from traps, reduction in CTE and image smearing, hot pixels take out columns.
- 2.5um cutoff MCT material is a standard product
  - No expected issues with qualifying either the detector material or the ROIC



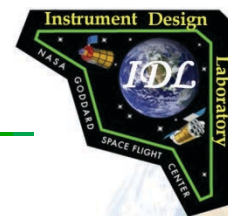

---

Integrated Design Capability / Instrument Design Laboratory

# GEO CAPE Wide Angle Spectrometer (WAS) ~ *Concept Presentations* ~

## Radiometry

Bryan Monosmith

July 29, 2014

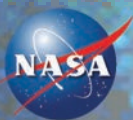

---

N A S A   G O D D A R D   S P A C E   F L I G H T   C E N T E R

# Requirements & Results Summary



## Integrated Design Capability / Instrument Design Laboratory

- **Sensor Requirements:**
  - 375m ground pixel from GEO
  - 25,000-50,000 km<sup>2</sup>/minute coverage
  - SNR 1000 across the most of the visible, with 10nm bandwidth
- **Design driver for radiometry: 710nm band. SNR=1000 at 10nm BW**
  - =>325mm aperture, 8k wide spatial array & 1.4sec integration time
- **Large dynamic range with no gain switching & no allowed saturation, require multiple detector reads per integration time due to detector full well limitations.**
- **Noise Summary:**
  - Blue; Shot noise driven with small quantization & read component
  - Red; Shot noise driven with small quantization & read component
  - SWIR; Shot & quantization noise driven
- **Scan Summary:**
  - 8k array results in 48.2k km<sup>2</sup>/minute (4k would give 24.1k km<sup>2</sup>/minute)



# Assumptions

---

## Integrated Design Capability / Instrument Design Laboratory

- Blue CCD; 0.4nm native resolution, 400k PE full well, 25 PE read noise, dark~0. QE=0.9 with roll-off at UV.
- Red CCD; 0.5nm native resolution, 400k PE full well, 25 PE read noise, dark~0. QE=0.9 with roll-off at 1 micron.
- SWIR MCT array, biased at -5V; 1nm native resolution, 100k PE full well, 10 PE read noise, 12 PE dark noise. QE=0.85
  
- A/D for blue/red CCD; 14 bit with 11.7 Effective Number of Bits (ENOB).
- A/D for SWIR; Sidecar ASIC 12 bit. Unknown ENOB, but radiometry works with 9.7 bits.
  
- Optical efficiency= 0.53
  - (8 surfaces at 0.975, depolarizer at 0.95, focus lens at 0.95, grating at 0.8 and 10% light lost in the real instrument.)
- UV enhanced silver to allow good reflectivity down to 340nm

# Blue Performance

## Integrated Design Capability / Instrument Design Laboratory

Band	BW	Ltyp	Lmax	SNR-Req	SNR-Model	SNR-Model	# Reads	QE
nm	nm	W/m <sup>2</sup> *ster*μ			BOL	-10% EOL	Reads*spectral aggregations	
350	15	46.9	166.2	1000	1495	1420	4*37	0.3 #
360	10	45.4	175.6	1000	1375	1305	4*25	0.38 #
385	10	38.4	177.9	1000	1550	1470	4*25	0.53
412	10	49.5	281.1	1000	2245	2130	4*25	0.8
350^	0.8	46.9	166.2	500	350	332	4*2	0.3
425^	0.8	48.2	277	500	650	615	4*2	0.85
443	10	45	271.3	1000	2350	2230	4*25	0.9
460	10	41.9	266	1000	2310	2195	4*25	0.9
475	10	38.2	261.3	1000	2235	2120	4*25	0.9
490	10	34.9	256.6	1000	2170	2060	4*25	0.9
510	10	29	250.3	1000	2010	1910	4*25	0.9
532	10	23.3	243.4	1000	1835	1740	4*25	0.9
555	10	18.5	224.9	1000	1665	1580	4*25	0.9
583	10	15.3	227.4	1000	1540	1460	4*25	0.9

# Better QE possible with aggressive thinning & tuned AR coating



# Red & SWIR Performance

## Integrated Design Capability / Instrument Design Laboratory

Band	BW	Ltyp	Lmax	SNR-Req	SNR-Model	SNR-Model	# Reads	QE
nm	nm	W/m <sup>2</sup> *ster*μ			BOL	-10% EOL	Reads*spectral aggregations	
617	10	12.2	216.7	1000	1405	1335	5*20	0.9
640	10	10.5	209.5	1000	1325	1255	5*20	0.9
655	10	9.57	204.7	1000	1275	1210	5*20	0.9
665	10	9.17	201.6	1000	1255	1190	5*20	0.9
678	10	8.66	197.5	1000	1230	1165	5*20	0.9
710	10	6.95	187.5	1000	1120	1060	5*20	0.9
748	10	5.6	175.5	600	1020	970	5*20	0.9
765	40	5.25	170.2	600	1995	1895	5*80	0.9
820	15	3.93	152.9	600	1080	1025	5*30	0.9
865	40	2.77	138.8	600	1495	1420	5*80	0.9
1020	40	1.48	109.1	450	735	695	5*80	0.4
1245	20	0.582	56.1	250	435 *	420 *	20*20	0.85
1640	40	0.178	19.7	180	385 *	375 *	10*40	0.85
2135	50	0.04	5.35	100	280 *	270 *	8*50	0.85

\* Multiply by Sqrt(2) if aggregating to 750m ground pixel

# Single Blue/Red Spectrograph

Integrated Design Capability / Instrument Design Laboratory

- Current SNR margins in the UV and far red are significantly larger than 15% for the dual spectrograph.
- Major impact of single spectrograph is larger grating efficiency roll-off at the UV and far red than for dual spectrograph.
- If the single grating is optimized for best performance around 700nm, then SNR at the UV & far red may drop by as much as 15%, but will largely preserve the 710nm SNR.
- Conclusion: requirements for SNR can still be met across the spectrum with the single grating option.

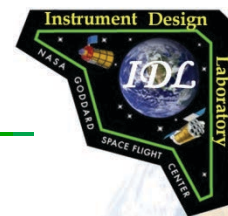

Integrated Design Capability / Instrument Design Laboratory

# GEO CAPE Wide Angle Spectrometer (WAS) ~ *Concept Presentations* ~

## Electrical Design

C. Paul Earle  
July 29, 2014

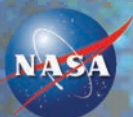

NASA GODDARD SPACE FLIGHT CENTER



# Baseline & Alternate Configuration (Baseline & Case 2, Includes SWIR Channel)

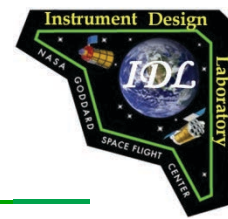

Integrated Design Capability / Instrument Design Laboratory

## Mechanical & Optical Configurations

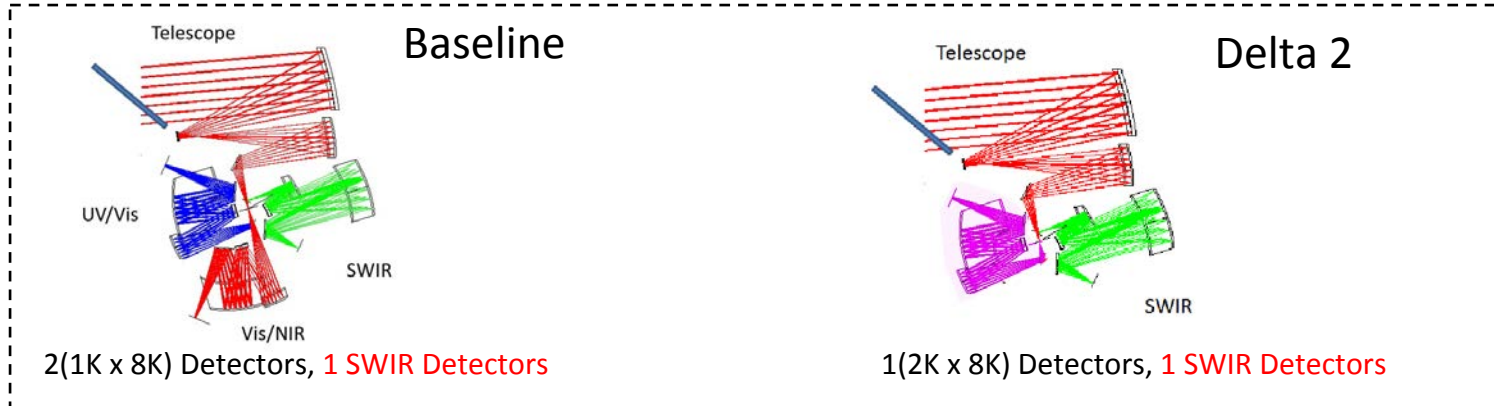

## Electrical Architecture:

- Both of these cases have **Do have a SWIR channel.**
- They also each have the same number of pixels to be readout for the UV/VIS and VIS/NIR channels, and therefore have the same electrical architecture.

Figure 1.



# Electrical Architecture

## (Baseline / Case 2)

Integrated Design Capability / Instrument Design Laboratory

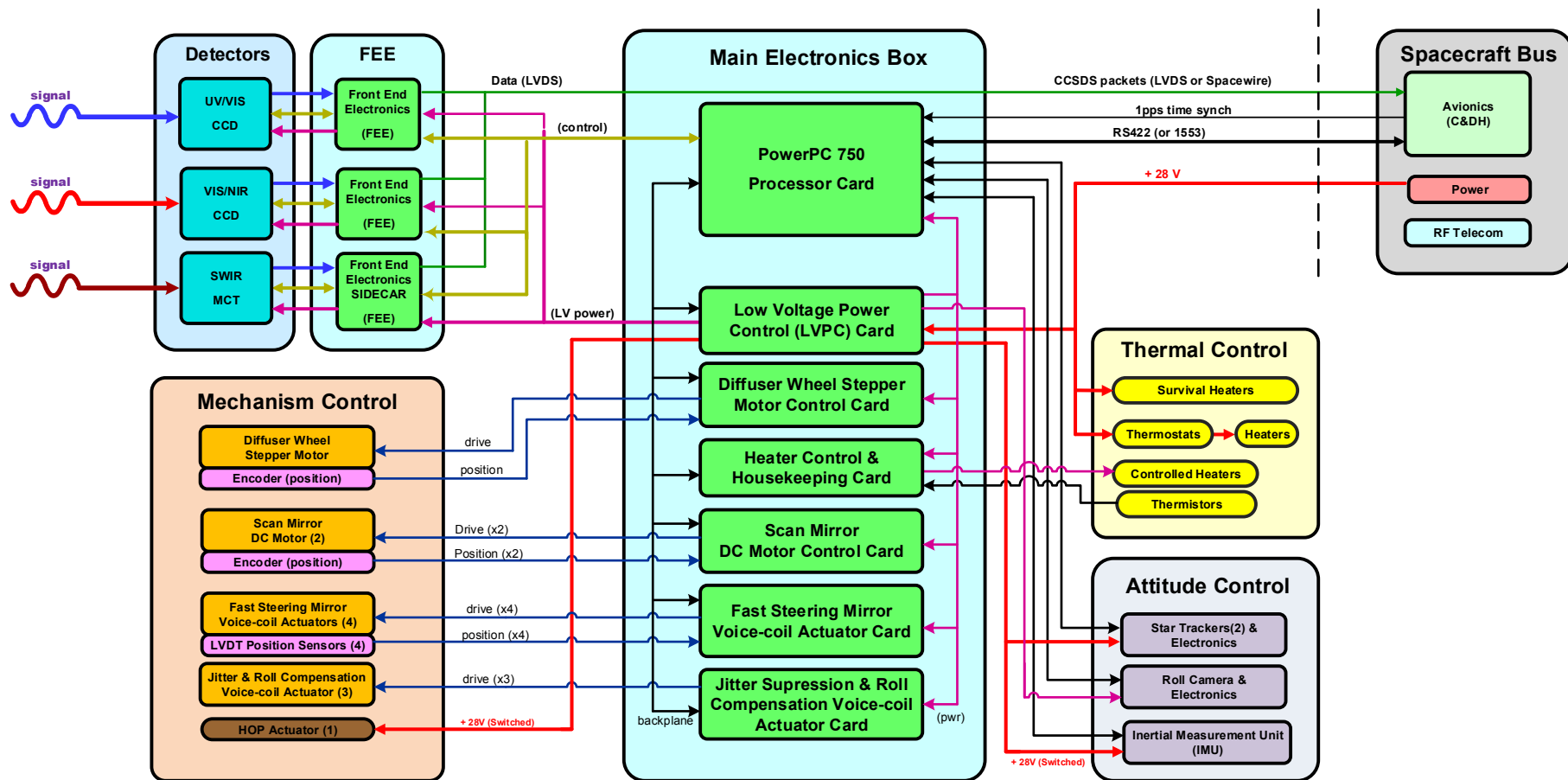
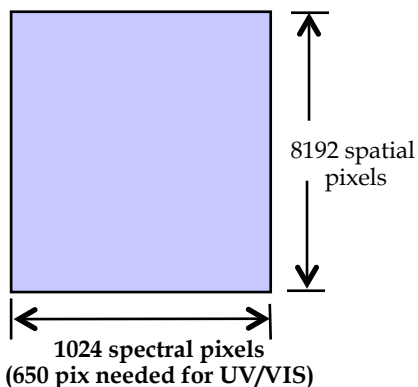

Figure 2.

# Detector Readout Assumptions

Integrated Design Capability / Instrument Design Laboratory

2 (1Kx8K)pix Array



## UV-VIS Detector Assumptions

- (1K x 8K) Detector Array, 8 outputs each (ie. 1Mpix each output)
- Readout detector 4 times for 1.4 seconds total integration
- ie, Readout each output tap in 0.35sec (ie. 2.9Mhz ADC sample rate)

## VIS-NIR Readout Assumptions

- (1K x 8 K) Detector Array, 8 outputs each (ie. 1Mpix each output)
- Readout 5 times for 1.4 seconds total integration
- ie. Readout each output tap in 0.28sec (ie. 3.6Mhz ADC sample rate)

- Perform Correlated Double Sampling (CDS) on each pixel readout
- Integrate for 0.7sec each frame and co-add for a total of 1.4sec integration
- Readout @14 bits/pix resolution
- Each detector read out by two (2) FPE Cards (ie. 4 detector outputs per card)

2(4Kx4K)pix Array

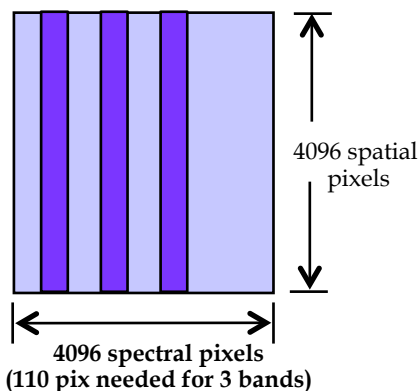

## SWIR Detector Assumptions

- 2(4K x 4K) Detector Arrays, 4 outputs each (ie. 4Mpix each output)
- Both detectors read out by 1 SIDECAR ASIC on 1 FPE Card.
- Readout 32 channels @ up to 10MHz sample rate @12 bits/pix resolution

## Note:

- A conservative 1.7:1 Loss-less compression is baselined to minimize downlink bandwidth requirement.
- Baseline design will incorporate selectable integration and/or readout period.

# UV/VIS & VIS/NIR Detector Readout

Integrated Design Capability / Instrument Design Laboratory

## FPE (Detector Readout & Digitizer) Circuit Board

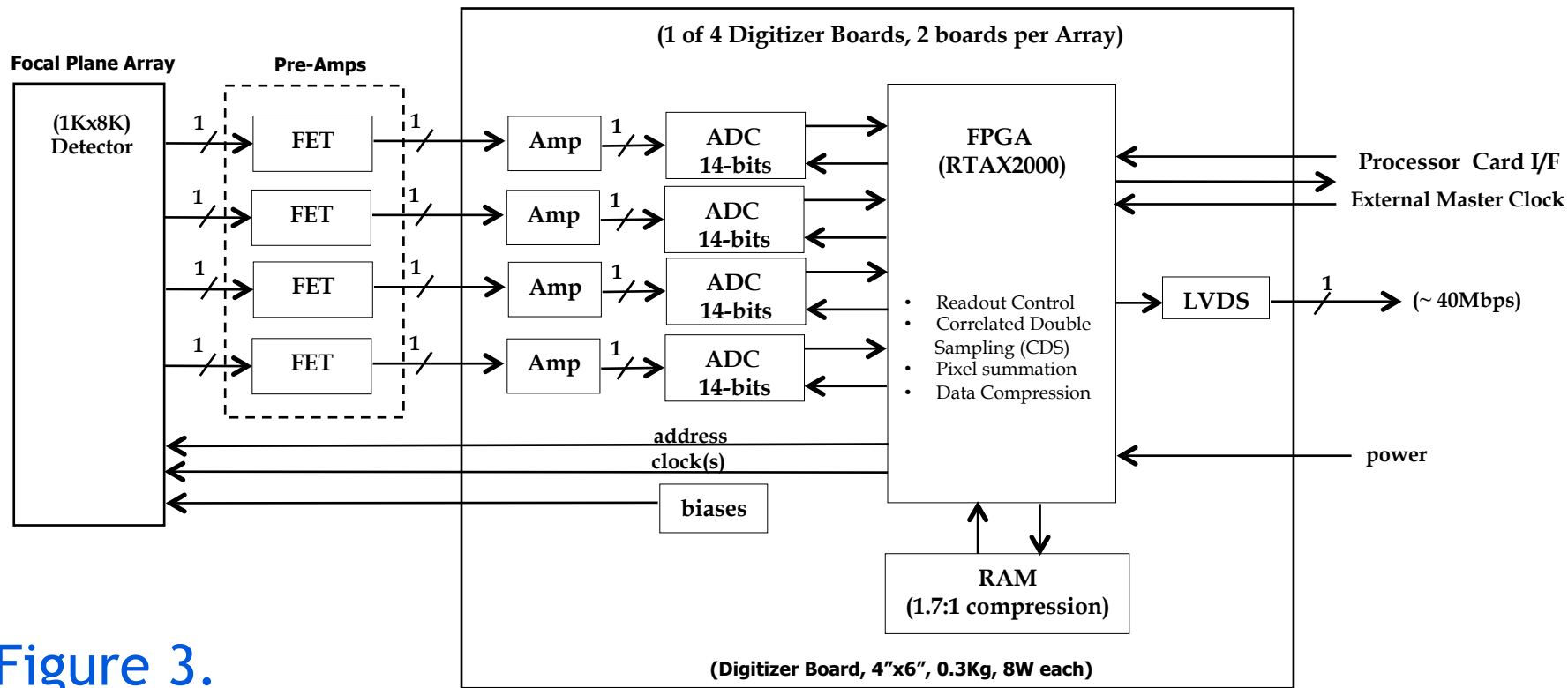

Figure 3.

**Digitizer Box Estimate: (13 x 18 x 8)cm, 1.0Kg (ie. 0.3Kg board total + 0.7Kg Housing), 8W**

Note:

- ⇒ UV/VIS ADC Sample rate = 1Mpix/0.35sec (ie. 2.9MHz sample rate each output), assume TI ADC14155QML-SP, 155MHz, 14-bits
- ⇒ VIS/NIR ADC Sample rate = 1Mpix/0.28sec (ie. 3.6MHz sample rate each output), assume TI ADC14155QML-SP, 155MHz, 14-bits

# SWIR Detector Readout

Integrated Design Capability / Instrument Design Laboratory

## SWIR FEE (Detector Readout & Digitizer) Circuit Board

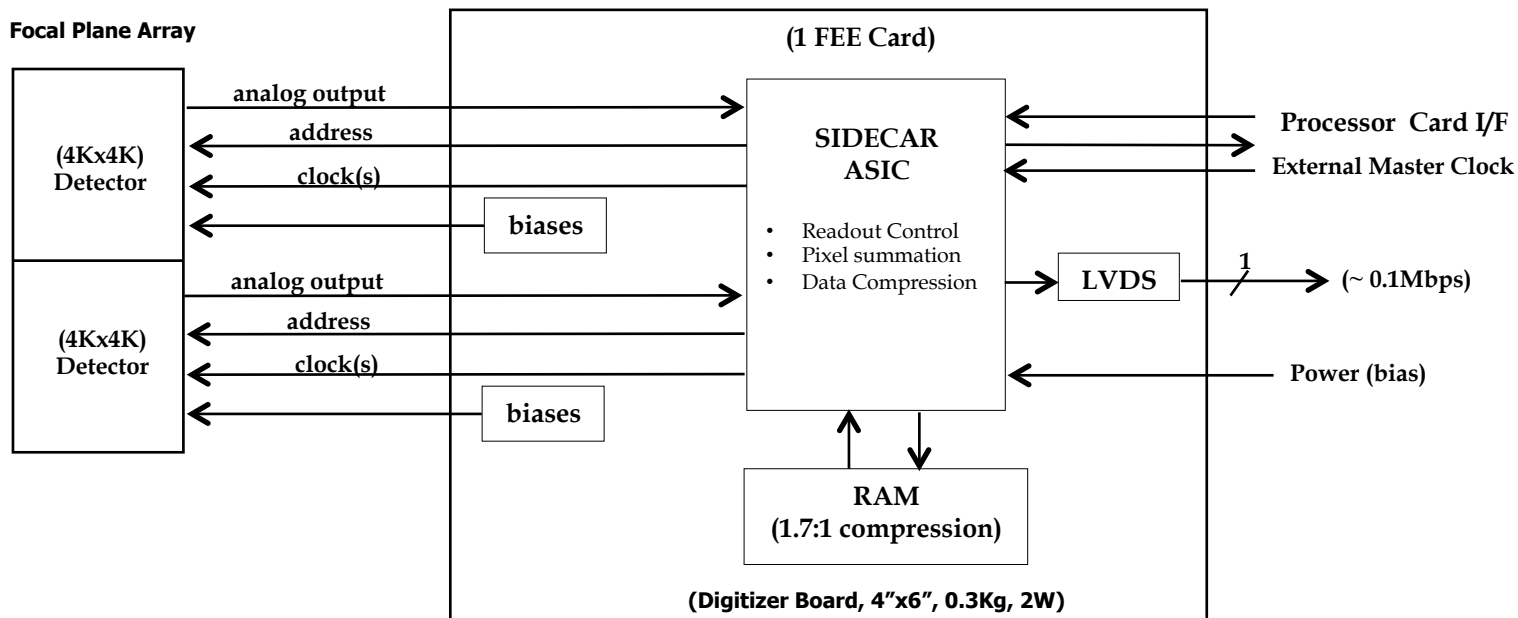

FEE Box Estimate: (13 x 18 x 8)cm, 1.0Kg (ie. 0.3Kg board total + 0.7Kg Housing), 2W

Figure 4.

Note:

⇒ SIDECAR ADC Sample rate ~ up to 10MHz on each of 32 channels @ 12 bits/sample

# Correlated Double Sampling & Co-Add

Integrated Design Capability / Instrument Design Laboratory

## FPGA Pixel Processing Algorithms (CDS & Pixel Co-Add)

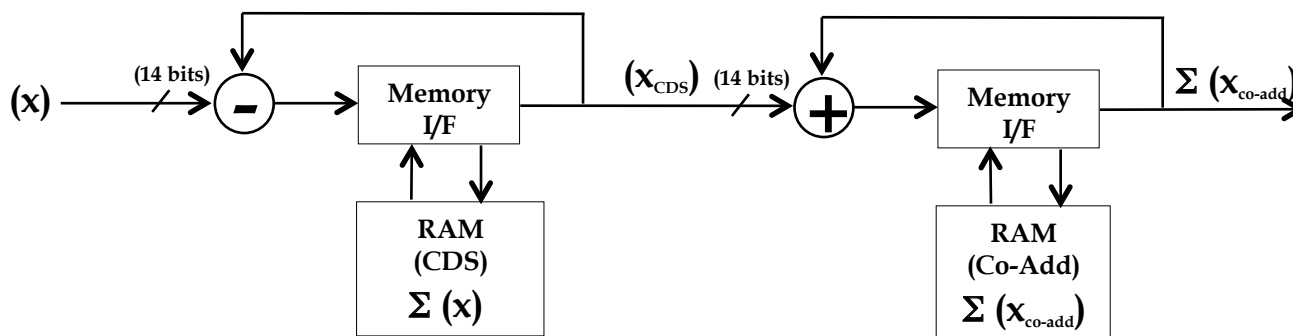

### Key

$N$  = Number of co-added frames.  
 $n$  = co-add bit overhead =  $\log_2 N$   
 ie.  
 $n=1$  for  $N=2$  (for 1.7sec integration)  
 $n=2$  for  $N=4$   
 $n=4$  for  $N=10$   
 $n=5$  for  $N=20$   
 $n=6$  for  $N=48$

### Example:

$(14 + \log_2 N)$  bits/pix  $\Rightarrow (14 + 1)$ bits/pix = 15bits/pix (for 1.7sec integration)

Figure 5.

# Data Rate Calculations (Baseline / Case 2)

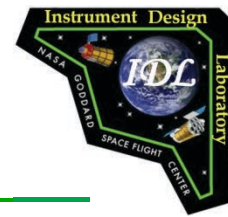

## Integrated Design Capability / Instrument Design Laboratory

GeoCape-WAS	UV-VIS Detector	(8K x 1K)	VIS-NIR Detector	(8K x 1K)	SWIR Detector	(4K x 4K)	Total
Array Size (pix)	8,192	1,024	8,192	1,024	4,096	1,024	
# Taps , pix/tap	8	1,048,576	8	1,048,576	4	1,048,576	
Int. Period , Tap pix rate	1.4	748,983	1.4	748,983	1.4	748,983	
Bit Resolution , Tap bit rate	14	10,485,760	14	10,485,760	14	10,485,760	
Array Readout Rate (bps)		83,886,080		83,886,080		41,943,040	
Total Data Rate (Mbps)	1	<b>83.9</b>	1	<b>83.9</b>	2	<b>83.9</b>	<b>251.66 Mbps</b>

Data Reduction Scheme					Readout Rate (bps)	Comments
<b>Blue Channel</b>		@ 1 pix/band				
340 - 450nm	@ 0.4nm =>	275detector pix	275bands	2,750.0	ie. No pixel summation for 0.4nm res	
450 - 600nm	@ 0.4nm =>	375detector pix	75bands	910.7	ie. 5:1 pix summation for 2nm res	
<b>Data Rate :</b>					<b>3,660.7</b>	<b>assuming 1.4sec integration, 14bits/pix</b>
<b>Red Channel</b>						
600 - 760nm	@ 0.5nm =>	320detector pix	80bands	914.3	ie. 4:1 pix summation for 2nm res	
760 - 900nm	@ 0.5nm =>	280detector pix	14bands	190.0	ie. 20:1 pix summation for 10nm res	
900 - 1100nm	@ 0.5nm =>	400detector pix	20bands	271.4	ie. 20:1 pix summation for 10nm res	
<b>Data Rate :</b>					<b>1,375.7</b>	<b>assuming 1.4sec integration, 14bit/pix</b>
<b>SWIR Channel</b>						
1245 - 2135nm	110nm	~	1 nm/pix			
	1245	20nm =>	20detector pix	1band	7.1	ie (co-add 20 pix and 20 reads, 40 additions)
	1640	40nm =>	40detector pix	1band	11.4	ie (co-add 40 pix and 10 reads, 50 additions)
	2135	50nm =>	50detector pix	1band	12.3	ie (co-add 50 pix and 8 reads, 58 additions)
<b>Data Rate:</b>					<b>30.9</b>	<b>assuming 1.4sec integration, 12bits/pix</b>
					=>	<b>5,067.3 Kbps each of 8K rows</b>
					=>	<b>40.54 Mbps</b> (ie. Multiply by 8K rows)
<b>Downlink Data Rate:</b>						<b>23.8 Mbps</b> (ie. Assume 1.7:1 compression ratio)



# Instrument Power Estimates (Baseline / Case 2)

Integrated Design Capability / Instrument Design Laboratory

## Instrument & Box Power Calculator

LVPC External Load	Qty	Avg. Power Each (W)	Power Modes				
			Launch (W)	Standby (W)	Calibration (W)	Science (W)	Survival (W)
FEE Card (s)	5	6.8		6.8	34.0	34.0	
Detectors	4	1.0		4.0	4.0	4.0	
Precision heater(s)	4	1.0		4.0	4.0	4.0	
Diffuser Motor	1	50.0			50.0		
Diffuser Motor Encoder	1	5.0			5.0		
Scan Mirror Motor	1	5.0			0.3	0.3	
Scan Mirror Motor Encoder	1	5.0			5.0	5.0	
FSM & Jitter Actuators	7	2.0			14.0	14.0	
LVDT Sensors	4	2.0			8.0	8.0	
Roll Cameras	2	9.0			18.0	18.0	
<b>External Load Total:</b>	<b>30</b>	<b>86.8</b>	<b>0.0</b>	<b>14.8</b>	<b>142.3</b>	<b>87.3</b>	<b>0.0</b>
<b>E-Box Circuit Boards</b>							
1. Processor Card	1	15.0		15.0	15.0	15.0	
2. Heater Control Card	1	5.0		5.0	5.0	5.0	
3. Scan DC-Motor Card	1	5.0		5.0	5.0	5.0	
4. Diffuser Stepper Motor Card	1	4.0		4.0	4.0	4.0	
5. FSM Voice-Coil Control	1	4.0		4.0	4.0	4.0	
6. Jitter & Roll Voice-Coil Control	1	4.0		4.0	4.0	4.0	
Power Converter Efficiency (%)	80						
Power Converter(s)	1	30.9	0.0	12.9	44.8	31.1	0.0
<b>E-Box Total:</b>	<b>7</b>	<b>67.9</b>	<b>0.0</b>	<b>49.9</b>	<b>81.8</b>	<b>68.0</b>	<b>0.0</b>
<b>Direct S/C Bus Load</b>							
IMU	1	24.0		24.0	24.0	24.0	
Star Trackers	1	4.0		4.0	4.0	4.0	
Thermostat Heaters	1	163.0		163.0	163.0	163.0	
Survival Heaters	1	65.0	65.0				65.0
<b>Direct S/C Bus Load Total:</b>		<b>256.0</b>	<b>65.0</b>	<b>191.0</b>	<b>191.0</b>	<b>191.0</b>	<b>65.0</b>
<b>Instrument Total:</b>	<b>n/a</b>	<b>410.7</b>	<b>65.0</b>	<b>255.7</b>	<b>415.0</b>	<b>346.3</b>	<b>65.0</b>

50W for 10 sec, 0W otherwise  
5W for 10 sec, 0W otherwise

S/C Power Bus Requirement





# MEB Size & Mass Estimate

Integrated Design Capability / Instrument Design Laboratory

## Box Size & Mass Calculator

Circuit Boards	Length (x)	Width (z)	Mass each	Qty	Mass (Kg)
Board Dimensions (inches)	8	6	0.50	6	3.00
(cm)	20	15			
Power Supply Card	"	"	0.75	1	0.75
Backplane (inches)	6	7	0.44	1	0.44
(cm)	15	18			
<b>Board Mass Total:</b>					<b>4.19</b>
Housing	Depth (x)	Height (z)	Width (y)	Qty	
Box Dimensions (inches)	9	7	8	1	
(cm)	23	18	20		
Box Wall Thickness (mm)	2.5mm				
Material (Aluminum) Density	2,700Kg/m <sup>3</sup>				
<b>Housing Mass :</b>					<b>1.71</b>
<b>Box Total:</b>					<b>5.89</b>

Digitizer Box size: (23 x 18 x 20)cm, 5.9Kg (ie. 4.2Kg board total + 1.7Kg Housing)

# MEB Summary

## Integrated Design Capability / Instrument Design Laboratory

E-Box Boards (Internal Load)	Qty	Masss (Kg)	Watts (W)	Description	% Analog / Digital	TRL
1. Processor Card	1	0.5	15.0	COTS	5/90	9
2. Heater Control Card	1	0.5	5.0	Custom Design	75/20	6
3. Scan DC-Motor Card	1	0.5	5.0	Custom Design	75/20	6
4. Diffuser Stepper Motor Card	1	0.5	4.0	Custom Design	75/20	6
5. FSM Voice-Coil Control	1	0.5	4.0	Custom Design	75/20	6
6. Jitter & Roll Voice-Coil Control	1	0.5	4.0	Custom Design	75/20	6
Power Converter(s)	1	0.7	26.3	assume 80% efficiency	90/5	6
Backplane	-	0.4	-	passive	-	6
Housing	-	1.7	-	Aluminum (2.5mm)	-	7
<b>MEB Totals: (Mass &amp; Power):</b>		<b>5.9</b>	<b>62.3</b>			

**MEB Box size: (23 x 18 x 20)cm, 5.9Kg (ie. 4.2Kg board total + 1.7Kg Housing)**

# FEE Size & Mass Estimate

Integrated Design Capability / Instrument Design Laboratory

## UV-VIS / VIS-NIR FEE Box Size

Circuit Boards	Length (x)	Width (z)	Mass each	Qty	Mass (Kg)
Board Dimensions (inches)	4	6	0.25	2	0.50
(cm)	10	15			
<b>Board Mass Total:</b>					<b>0.50</b>
Housing	Depth (x)	Height (z)	Width (y)	Qty	
Box Dimensions (inches)	5	7	4	1	
(cm)	13	18	10		
Box Wall Thickness (mm)	2.5mm				
Material (Aluminum) Density	2,700Kg/m <sup>3</sup>				
<b>Housing Mass :</b>					<b>0.75</b>
<b>Box Total:</b>					<b>1.25</b>

## SWIR FEE (SIDECAR) Box Size

Circuit Boards	Length (x)	Width (z)	Mass each	Qty	Mass (Kg)
Board Dimensions (inches)	4	6	0.25	1	0.25
(cm)	10	15			
<b>Board Mass Total:</b>					<b>0.25</b>
Housing	Depth (x)	Height (z)	Width (y)	Qty	
Box Dimensions (inches)	5	7	3	1	
(cm)	13	18	8		
Box Wall Thickness (mm)	2.5mm				
Material (Aluminum) Density	2,700Kg/m <sup>3</sup>				
<b>Housing Mass :</b>					<b>0.64</b>
<b>Box Total:</b>					<b>0.89</b>

# FEE Box Summary

Integrated Design Capability / Instrument Design Laboratory

## UV-VIS & VIS-NIR FEE Mass & Power Summary

FEE	Qty	Mass (Kg)	Power (W)	Description	% Analog / Digital	TRL
Readout Cards	2	0.50	16.0	FPGA control	50/45	6
Housing:	1	0.75	-	Aluminum (2.5mm)	-	7
<b>Box Totals: (Mass &amp; Power):</b>		<b>1.25</b>	<b>16.0</b>			

Digitizer Box size: (13 x 18 x 10)cm, 1.3Kg (ie. 0.5Kg board total + 0.8Kg Housing)

## SWIIV FEE Mass & Power Summary

FEE	Qty	Mass (Kg)	Power (W)	Description	% Analog / Digital	TRL
Readout Cards	1	0.25	2.0	FPGA control	50/45	6
Housing:	1	0.64	-	Aluminum (2.5mm)	-	7
<b>Box Totals: (Mass &amp; Power):</b>		<b>0.89</b>	<b>2.0</b>			

Digitizer Box size: (13 x 18 x 8)cm, 0.9Kg (ie. 0.3Kg board total + 0.6Kg Housing)

# Mechanical Layout

Integrated Design Capability / Instrument Design Laboratory

Dimensions used as basis for harness length & Mass estimates

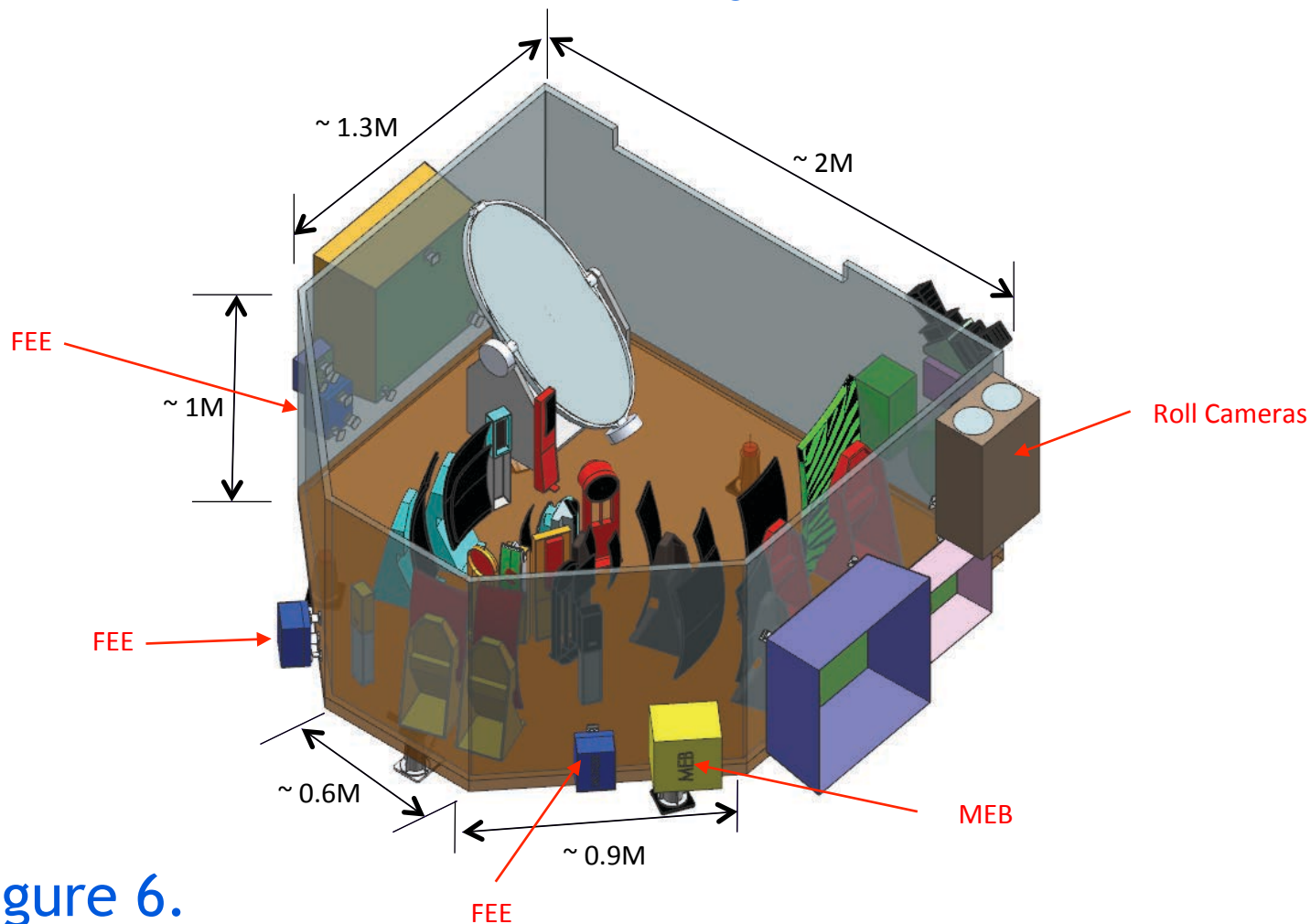

Figure 6.

# Instrument Harness Mass Estimate (Baseline / Case 2)



Integrated Design Capability / Instrument Design Laboratory

Harness ID		Harness Parameters						Connector & Backshell		Line	
Source (From)	Destination (To)	Wire Type (Select)	Description (Table lookup)	Qty	Length (m)	Density (g/m)	Mass (g)	Type (Select)	Mass (g) (2x)	Totals (g)	
UV/VIS FEE	Detector Assembly	Single-24AWG	M22759/33-24-0	20	0.3	3.25	19.49	25P (MDM)	34.40	53.89	
VIS/NIR	Detector Assembly	Single-24AWG	M22759/33-24-0	20	0.3	3.25	19.49	25P (MDM)	34.40	53.89	
SWIR FEE	Detector Assembly	Single-24AWG	M22759/33-24-0	20	0.3	3.25	19.49	25P (MDM)	34.40	53.89	
UV/VIS FEE	MEB	Power, LVDS	(20, 24)AWG	4	1.5	27.23	163.39	15P (MDM)	32.00	195.39	
VIS/NIR FEE	MEB	Power, LVDS	(20, 24)AWG	4	1.5	27.23	163.39	15P (MDM)	32.00	195.39	
SWIR FEE	MEB	Power, LVDS	(20, 24)AWG	4	1.5	27.23	163.39	15P (MDM)	32.00	195.39	
MEB	Scan Mirror Assy + Enc	TSP-22AWG	M27500-22SC2S23	15	3.0	22.97	1033.46	44P (HD)	62.00	1095.46	
MEB	FSM Voice Coils (4) + LVDT	TSP-22AWG	M27500-22SC2S23	8	3.0	22.97	551.18	25P (MDM)	34.40	585.58	
MEB	Diffuser Wheel Motor Assy+ Enc	TSP-22AWG	M27500-22SC2S23	15	3.0	22.97	1033.46	44P (HD)	62.00	1095.46	
MEB	Jitter/Roll Voice Coils (3)	TSP-22AWG	M27500-22SC2S23	3	3.0	22.97	206.69	9P (MDM)	29.20	235.89	
MEB	Launch Locks (7)	TP-20AWG	M27500-20SC2U00	7	3.0	16.40	344.49	21P (MDM)	33.20	377.69	
MEB	Star Tracker Electronics	Power, RS422	(12, 24)AWG	1	2.5	109.55	273.87	9P (MDM)	29.20	303.07	
MEB	IMU Electronics	Power, RS422	(12, 24)AWG	1	2.5	109.55	273.87	9P (MDM)	29.20	303.07	
MEB	Roll Camera Electronics	Power, RS422	(12, 24)AWG	1	2.5	109.55	273.87	9P (MDM)	29.20	303.07	
MEB	Precision Heaters (3)	TP-20AWG	M27500-20SC2U00	6	1.5	16.40	147.64	15P (MDM)	32.00	179.64	
MEB	Thermostat / Survival Heaters (15)	TP-20AWG	M27500-20SC2U00	182	2.0	16.40	5971.13	37P (MDM)	40.00	6011.13	
MEB	Temperature Sensors (20)	TSP-24AWG	M27500-24SC2S23	44	2.0	18.37	1616.80	51P (MDM)	40.00	1656.80	
MEB	SCIF	Pwr, RS422, 1553, 1pps	(12, 24, 24,24)AWG	1	2.0	151.54	303.08	15P (MDM)	32.00	335.08	
FEE	SCIF (3)	SpaceWire (SpW)	9 wires (4 TSPs + GND)	3	2.0	74.80	448.82	37P (MDM)	40.00	488.82	
							<b>Total:</b>	<b>13026.98</b>	-	<b>691.60</b>	<b>13718.58</b>

**Note:**

- This mass estimate is the current best estimate based on this point design, and represents ~6% of the total instrument mass. Historically, flight instruments have been delivered with the harness mass totaling 7-12% of the total instrument mass, so the customer may choose to book keep a more conservative estimate of harness mass until a more detailed electrical assessment can be performed.
- 5% misc added for tie-downs, ground straps, and insulation

<b>Total:</b>	<b>13.72</b>
<b>+ 5% misc</b>	<b>14.40</b>



# Alternate Configurations (Case 1 & Case 3, No SWIR Channel)

Integrated Design Capability / Instrument Design Laboratory

## Mechanical & Optical Configurations

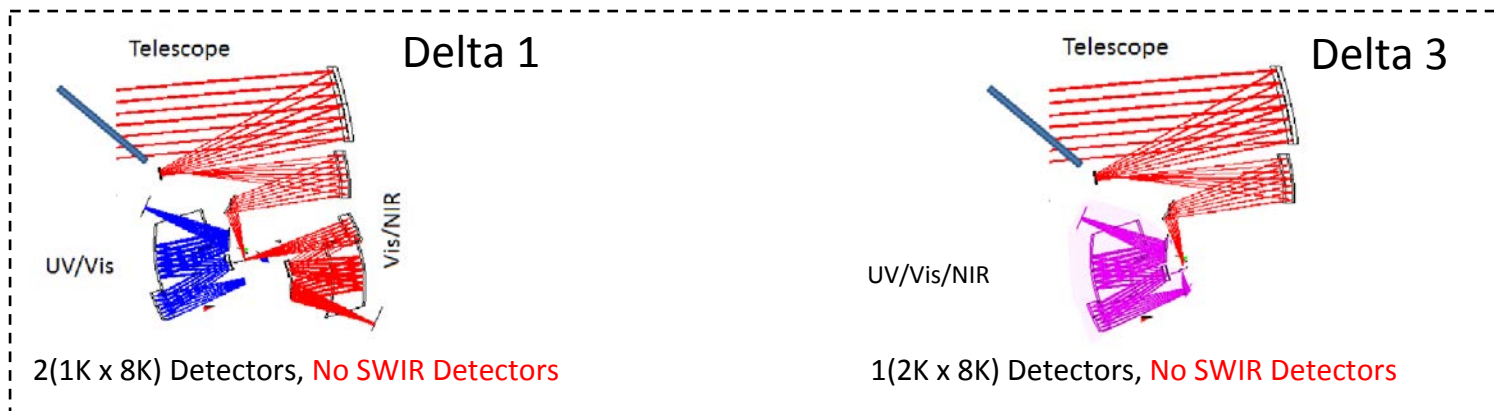

## Electrical Architecture:

- Both of these cases have **No SWIR channel**.
- They also each have the same number of pixels to be readout for the UV/VIS and VIS/NIR channels, and therefore have the same electrical architecture.

Figure 7.

# Electrical Architecture

## (Case 1 & Case 3, No SWIR)



Integrated Design Capability / Instrument Design Laboratory

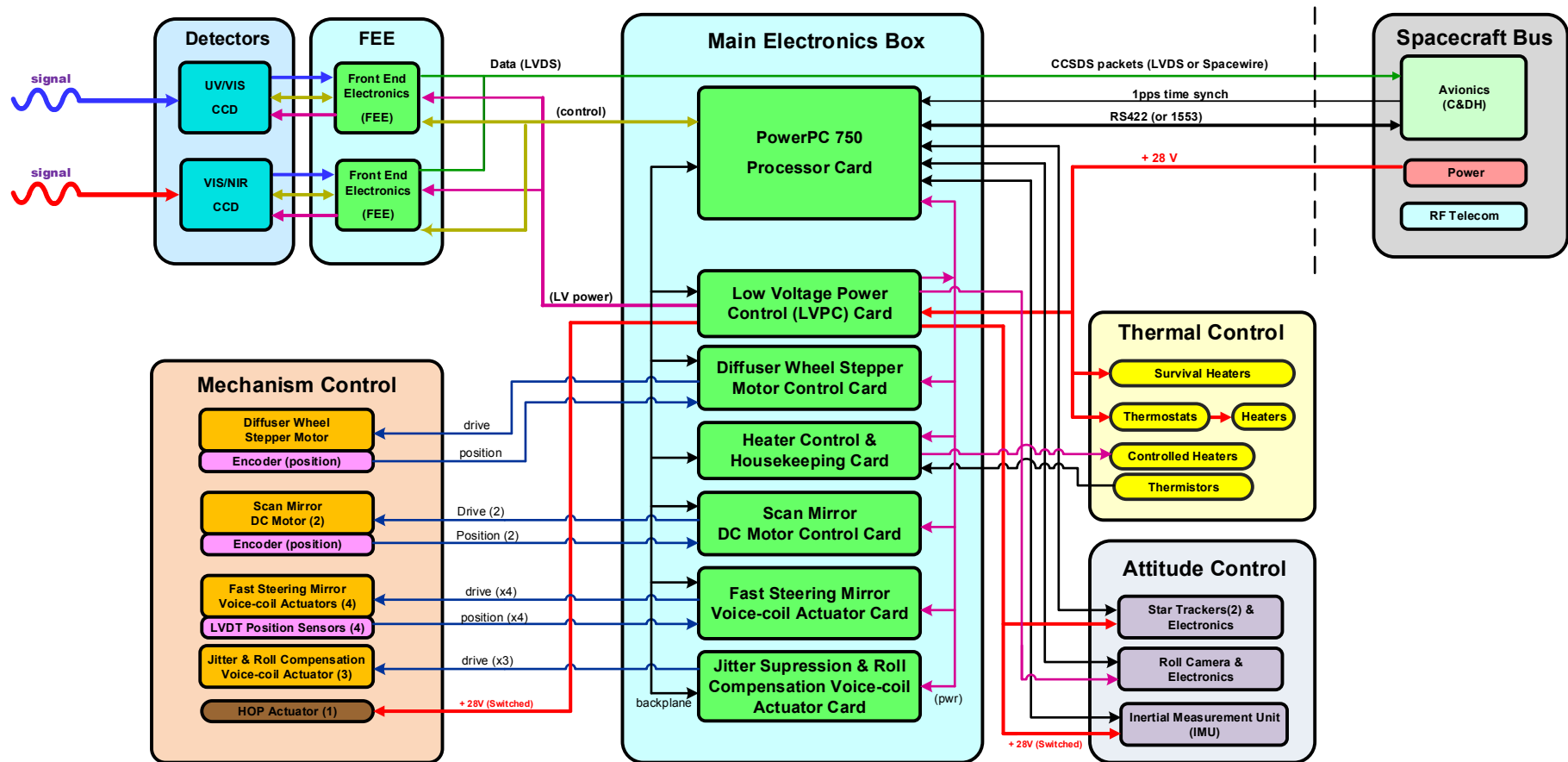

Figure 8.





# Data Rate Calculations

## (Case 1 & Case 3, No SWIR)

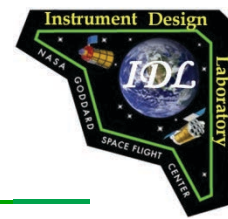

Integrated Design Capability / Instrument Design Laboratory

<b>GeoCape-WAS</b>	UV-VIS Detector	(8K x 1K)	VIS-NIR Detector	(8K x 1K)
Array Size (pix)	8,192	1,024	8,192	1,024
# Taps , pix/tap	8	1,048,576	8	1,048,576
Int. Period , Tap pix rate	1.4	748,983	1.4	748,983
Bit Resolution , Tap bit rate	14	10,485,760	14	10,485,760
Array Readout Rate (bps)		83,886,080		83,886,080
Total Data Rate (Mbps)	1	<b>83.9</b>	1	<b>83.9</b>

Data Reduction Scheme				Readout Rate (bps)	Comments
<b>Blue Channel</b>			@ 1 pix/band		
340 - 450nm	@ 0.4nm =>	275detector pix	275bands	2,750.0	ie. No pixel summation for 0.4nm res
450 - 600nm	@ 0.4nm =>	375detector pix	75bands	910.7	ie. 5:1 pix summation for 2nm res
<b>Data Rate :</b>				<b>3,660.7</b>	<b>assuming 1.4sec integration, 14bits/pix</b>
<b>Red Channel</b>					
600 - 760nm	@ 0.5nm =>	320detector pix	80bands	914.3	ie. 4:1 pix summation for 2nm res
760 - 900nm	@ 0.5nm =>	280detector pix	14bands	190.0	ie. 20:1 pix summation for 10nm res
900 - 1100nm	@ 0.5nm =>	400detector pix	20bands	271.4	ie. 20:1 pix summation for 10nm res
<b>Data Rate :</b>				<b>1,375.7</b>	<b>assuming 1.4sec integration, 14bit/pix</b>
				=> <b>5,036.4</b>	<b>Kbps each of 8K rows</b>
				=> <b>40.29</b>	<b>Mbps (ie. Multiply by 8K rows)</b>
<b>Downlink Data Rate:</b>				<b>23.7</b>	<b>(ie. Assume 1.7:1 compression ratio)</b>



# Instrument Power Estimates (Case 1 & Case 3, No SWIR)

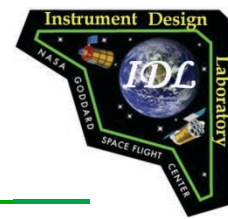

Integrated Design Capability / Instrument Design Laboratory

## Instrument & Box Power Calculator

LVPC External Load	Qty	Avg. Power Each (W)	Power Modes				
			Launch (W)	Standby (W)	Calibration (W)	Science (W)	Survival (W)
FEE Card (s)	4	8.0		6.4	32.0	32.0	
Detectors	2	2.0		4.0	4.0	4.0	
Precision heater(s)	2	1.0		2.0	2.0	2.0	
Diffuser Motor	1	50.0			50.0		
Diffuser Motor Encoder	1	5.0			5.0		
Scan Mirror Motor	1	5.0			0.3	0.3	
Scan Mirror Motor Encoder	1	5.0			5.0	5.0	
FSM & Jitter Actuators	7	2.0			14.0	14.0	
LVDT Sensors	4	2.0			8.0	8.0	
Roll Cameras	2	9.0			18.0	18.0	
<b>External Load Total:</b>	<b>25</b>	<b>89.0</b>	<b>0.0</b>	<b>12.4</b>	<b>138.3</b>	<b>83.3</b>	<b>0.0</b>
<b>E-Box Circuit Boards</b>							
1. Processor Card	1	15.0		15.0	15.0	15.0	
2. Heater Control Card	1	5.0		5.0	5.0	5.0	
3. Scan DC-Motor Card	1	5.0		5.0	5.0	5.0	
4. Diffuser Stepper Motor Card	1	4.0		4.0	4.0	4.0	
5. FSM Voice-Coil Control	1	4.0		4.0	4.0	4.0	
6. Jitter & Roll Voice-Coil Control	1	4.0		4.0	4.0	4.0	
Power Converter Efficiency (%)	80						
Power Converter(s)	1	31.5	0.0	12.3	43.8	30.1	0.0
<b>E-Box Total:</b>	<b>7</b>	<b>68.4</b>	<b>0.0</b>	<b>49.3</b>	<b>80.8</b>	<b>67.0</b>	<b>0.0</b>
<b>Direct S/C Bus Load</b>							
IMU	1	24.0		24.0	24.0	24.0	
Star Trackers	1	4.0		4.0	4.0	4.0	
Thermostat Heaters	1	163.0		163.0	163.0	163.0	
Survival Heaters	1	65.0	65.0				65.0
<b>Direct S/C Bus Load Total:</b>	<b>8</b>	<b>256.0</b>	<b>65.0</b>	<b>191.0</b>	<b>191.0</b>	<b>191.0</b>	<b>65.0</b>
<b>Instrument Total:</b>	<b>n/a</b>	<b>413.4</b>	<b>65.0</b>	<b>252.7</b>	<b>410.0</b>	<b>341.3</b>	<b>65.0</b>

50W for 10 sec, 0W otherwise  
5W for 10 sec, 0W otherwise

S/C Power Bus Requirement



# Instrument Harness Mass Estimate

## (Case 1 & Case 3, No SWIR)

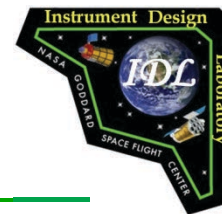

Integrated Design Capability / Instrument Design Laboratory

Harness ID		Harness Parameters						Connector & Backshell		Line	
Source (From)	Destination (To)	Wire Type (Select)	Description (Table lookup)	Qty	Length (m)	Density (g/m)	Mass (g)	Type (Select)	Mass (g) (2x)	Totals (g)	
UV/VIS FEE	Detector Assembly	Single-24AWG	M22759/33-24-0	20	0.3	3.25	19.49	25P (MDM)	34.40	53.89	
VIS/NIR	Detector Assembly	Single-24AWG	M22759/33-24-0	20	0.3	3.25	19.49	25P (MDM)	34.40	53.89	
UV/VIS FEE	MEB	Power, LVDS	(20, 24)AWG	4	1.5	27.23	163.39	15P (MDM)	32.00	195.39	
VIS/NIR FEE	MEB	Power, LVDS	(20, 24)AWG	4	1.5	27.23	163.39	15P (MDM)	32.00	195.39	
MEB	Scan Mirror Assy + Enc	TSP-22AWG	M27500-22SC2S23	15	3.0	22.97	1033.46	44P (HD)	62.00	1095.46	
MEB	FSM Voice Coils (4) + LVDT Diffuser Wheel Motor Assy+ Enc	TSP-22AWG	M27500-22SC2S23	8	3.0	22.97	551.18	25P (MDM)	34.40	585.58	
MEB	Jitter/Roll Voice Coils (3)	TSP-22AWG	M27500-22SC2S23	15	3.0	22.97	1033.46	44P (HD)	62.00	1095.46	
MEB	Jitter/Roll Voice Coils (3)	TSP-22AWG	M27500-22SC2S23	3	3.0	22.97	206.69	9P (MDM)	29.20	235.89	
MEB	Launch Locks (7)	TP-20AWG	M27500-20SC2U00	7	3.0	16.40	344.49	21P (MDM)	33.20	377.69	
MEB	Star Tracker Electronics	Power, RS422	(12, 24)AWG	1	2.5	109.55	273.87	9P (MDM)	29.20	303.07	
MEB	IMU Electronics	Power, RS422	(12, 24)AWG	1	2.5	109.55	273.87	9P (MDM)	29.20	303.07	
MEB	Roll Camera Electronics	Power, RS422	(12, 24)AWG	1	2.5	109.55	273.87	9P (MDM)	29.20	303.07	
MEB	Precision Heaters (3)	TP-20AWG	M27500-20SC2U00	6	1.5	16.40	147.64	15P (MDM)	32.00	179.64	
MEB	Thermostat / Survival Heaters (15)	TP-20AWG	M27500-20SC2U00	182	2.0	16.40	5971.13	37P (MDM)	40.00	6011.13	
MEB	Temperature Sensors (20)	TSP-24AWG	M27500-24SC2S23	44	2.0	18.37	1616.80	51P (MDM)	40.00	1656.80	
MEB	SCIF	Pwr, RS422, 1553, 1pps	(12, 24, 24,24)AWG	1	2.0	151.54	303.08	15P (MDM)	32.00	335.08	
FEE	SCIF (2)	SpaceWire (SpW)	9 wires (4 TSPs + GND)	2	2.0	74.80	299.21	37P (MDM)	40.00	339.21	
							<b>Total:</b>	<b>12694.50</b>	-	<b>625.20</b>	<b>13319.70</b>

<b>Total:</b>	<b>13.32</b>	<b>Kg</b>
<b>+ 5% misc :</b>	<b>13.99</b>	<b>Kg</b>

Note:

- This mass estimate is the current best estimate based on this point design, and represents ~6% of the total instrument mass. Historically, flight instruments have been delivered with the harness mass totaling 7-12% of the total instrument mass, so the customer may choose to book keep a more conservative estimate of harness mass until a more detailed electrical assessment can be performed.
- 5% misc added for tie-downs, ground straps, and insulation



# Baseline vs. Alternate Configurations

Integrated Design Capability / Instrument Design Laboratory

Resources	Baseline	Case 1 (no SWIR)	Case 2	Case 3 (No SWIR)
<b>Mass (kg)</b>	23.68	22.38	23.68	22.38
Difference (kg):	0	<b>-1.3</b>	0	<b>-1.3</b>
Percentage (%):	0.0	-5.5	0.0	-5.5
<b>Power (Watts)</b>	346.3	341.3	346.3	341.3
Difference (Watts):	0	<b>-5</b>	0	<b>-5</b>
Percentage (%):	0.0	-1.4	0.0	-1.4
<b>Data Rate (Mbps)</b>	23.8	23.7	23.8	23.7
Difference (Mbps):	0	<b>-0.1</b>	0	<b>-0.1</b>
Percentage (%):	0.0	-0.4	0.0	-0.4

# Issues / Conclusion / Summary

## Integrated Design Capability / Instrument Design Laboratory

- No low TRL items or concerns. All TRLs are  $\geq 6$ .
- The baseline design assumes single-string electronics, except for Heaters which are redundant.
- The main processor is dedicated to processing data from the IMU, Star Tracker, Roll Cameras, and closed-loop PID heater control, while the FPGAs are used for mechanism control, pixel processing algorithms and data compression.
- Data Compression is assumed @  $\sim 1.7:1$  to reduce downlink bandwidth/transponder requirements (23.8Mbps) and hence cost. Data volume generated over 16 hours of operation is  $\sim 1.37$ Tbits.
- Baseline design is best estimate of actual mass, power, and data rate (ie. No margins or contingency were added).

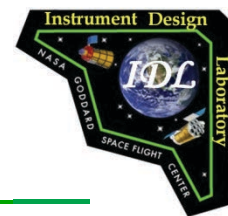

---

Integrated Design Capability / Instrument Design Laboratory

# Backup Slides

(Electrical Design Estimates)



# Sample Stepper Motor Controller Circuit

Integrated Design Capability / Instrument Design Laboratory

(Notional: Basis of Estimate)

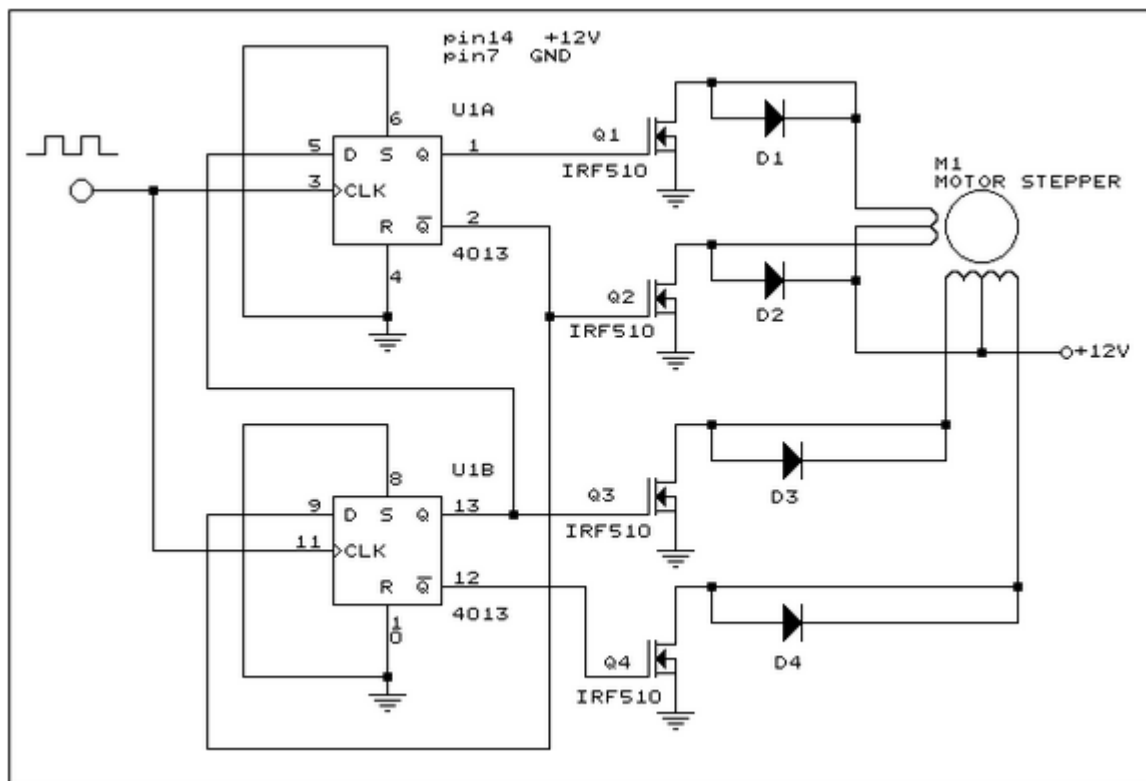

(Assume 4 circuits on 1 Card, 4W)

Figure 9.

# Closed-Loop PID Heater Control & H/K

Integrated Design Capability / Instrument Design Laboratory

(Notional: Basis of Estimate)

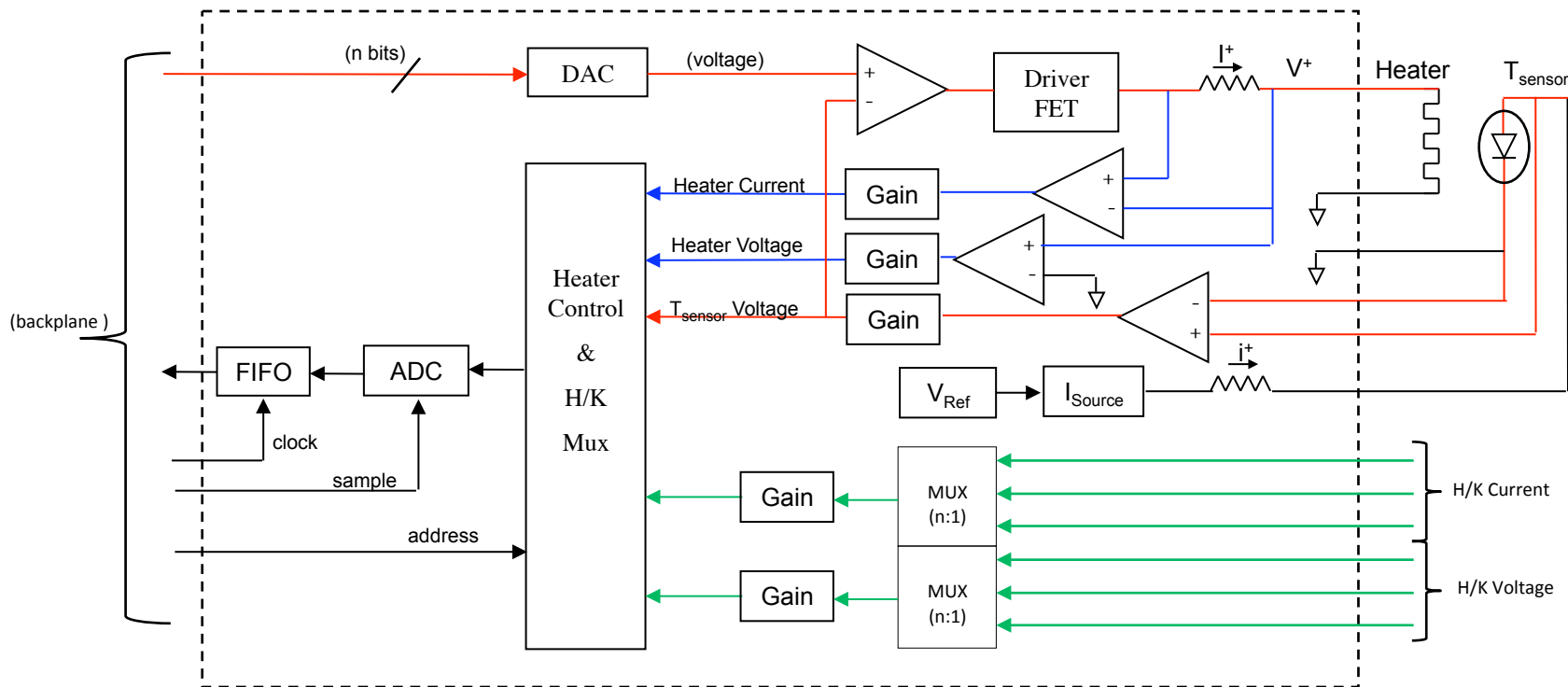
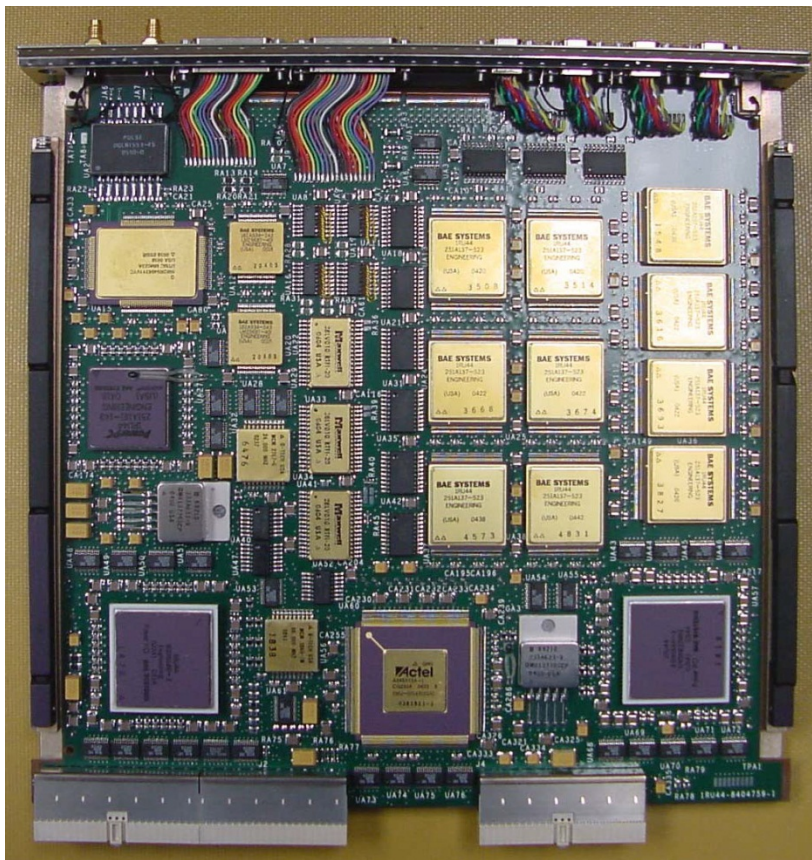

Figure 10.



# Single Board Computer

Integrated Design Capability / Instrument Design Laboratory



**BAE SYSTEMS**

## 6U CompactPCI Single Board Computer

- A Double-sided 6U CompactPCI Single Board Computer
- Populated with RAD750 capable of 133 MHz operation
- PCI Bus rate of 33 MHz
- 20 Mbytes of Local Memory SRAM
- MIL-STD-1553B Bus interface**
- 4 bi-directional SpaceWire ports
- Dimension 6U x 220mm (front side)
- Dimension 6U x 160mm (back side)
- Power is to be 15 Watts Average**
- +3.3V Nominal Operation
- The EEPROM devices use +5.0V

6U-220mm Front Side View

Backplane Speed of 32Mbytes/sec (@ 33Mhz Bus Rate) ~ 256Mbps meets Raw Data Rate requirement of 56 Mbps

# SIDECAR ASIC

Integrated Design Capability / Instrument Design Laboratory

The SIDECAR™ ASIC is designed to manage all aspects of imaging array operation and output digitization.

## SIDECAR™ ASIC Hardware:

- 36 analog to digital processing channels
  - Accommodates all 32 outputs of a H2RG™ focal plane array, plus reference output, window output, and temperature sensor
  - Preamplifier gain: 0dB – 27dB in 3dB steps
  - 16 bit analog-to-digital converter (ADC): up to 500 kHz sample rate
  - 12 bit ADC: up to 10 MHz sample rate
- Clock generation
  - 32 programmable digital I/O signals
- Bias generation
  - 20 programmable bias voltages/currents
- Digital interface to instrument electronics
  - 24 digital input/output channels for data transfer (LVDS or CMOS)
- 16-bit fully programmable microcontroller
- Low power operation
  - Less than 150 mW at 100 kHz, 32 channel, 16 bit ADC
  - Less than 1 W at 10 MHz, 32 channel, 12 bit ADC
  - Efficient power-down modes
- Requires one power supply, one fixed reference and one master clock for operation

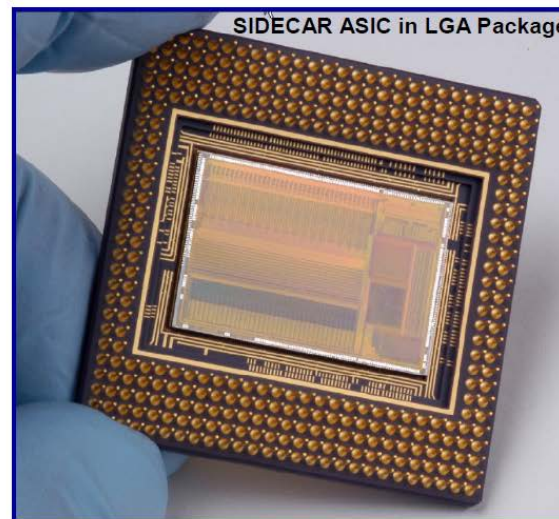

# 155 MSPS 14-bit ADC

Integrated Design Capability / Instrument Design Laboratory



ADC14155QML-SP, TI (National Semiconductor)

- 14-bits, ENOB ~11.3
- Sample Speed ~ 155MHz
- Power consumption ~ 0.967W
- Input Bandwidth ~ 1.1GHz
- Input Range ~ 2V(p-p)

# Teledyne SIDECAR ASIC

Integrated Design Capability / Instrument Design Laboratory

**S** System (for)  
**I** Image  
**D** Digitization  
**E** Enhancement  
**C** Control  
**A** And  
**R** Retrieval

*Manages FPA Operation and Science Data Digitization*

- 36 Video Input Channels
- 20 Analog Output Channels
- 32 Digital I/O (Clocks)
- 20 Bias Generators
- 16-Bit Programmable Microprocessor

**ASIC**



# Teledyne HAWAII-1RG Read Out Integrated Circuit (ROIC)

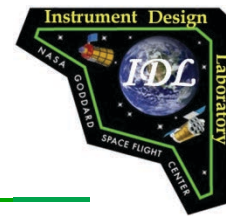

Integrated Design Capability / Instrument Design Laboratory

H  
A  
W  
A  
I  
I

HgCdTe  
Astronomy  
Wide  
Area  
Infrared  
Imager

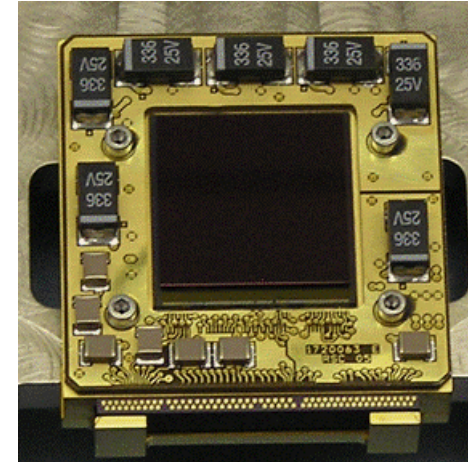
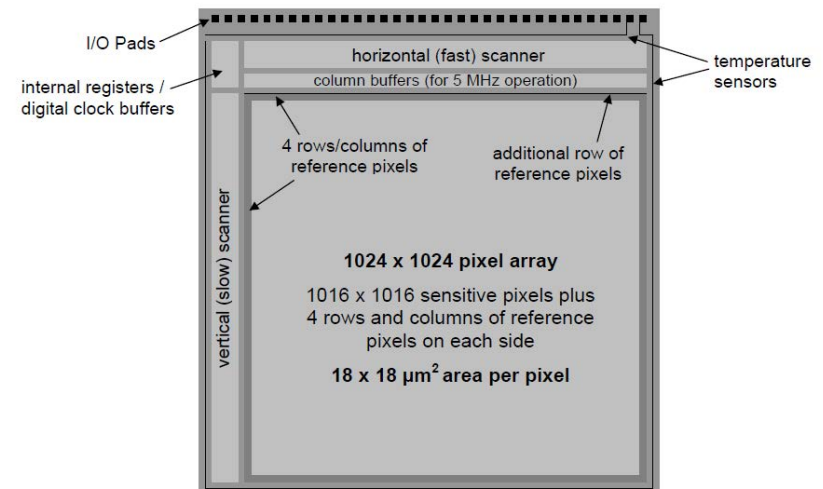
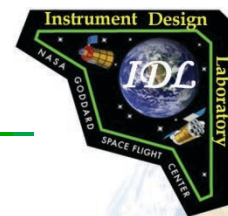

Figure 1.1: Block diagram of the HAWAII-1RG

1024 x 1024 Pixels  
Reference Pixels  
Guide Mode





Integrated Design Capability / Instrument Design Laboratory

# GEO CAPE Wide Angle Spectrometer (WAS) ~ *Concept Presentations* ~

## Thermal

Mike Choi

July 29, 2014

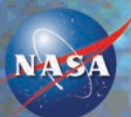

NASA GODDARD SPACE FLIGHT CENTER

# Summary of Cases

Integrated Design Capability / Instrument Design Laboratory

Baseline	Case 1	Case 2	Case 3
UV/VIS CCD	UV/VIS CCD	UV/VIS/NIR CCD	UV/VIS/NIR CCD
VIS/NIR CCD	VIS/NIR CCD		
SWIR Detector	None	SWIR Detector	None

# Operating Mode Thermal Requirements

Integrated Design Capability / Instrument Design Laboratory

Component	Temperature (°C)	Temperature Stability (°C)
UV/VIS CCD	20 (293K)	±0.1
VIS/NIR CCD	20 (293K)	±0.1
SWIR Detector	-118 (155K)	±0.1
Optics	-10 to 60	±2
Optical Bench	-10 to 60	±2
Optics Enclosure	-10 to 60	±2



# Operating Mode Thermal Requirements

Integrated Design Capability / Instrument Design Laboratory

Component	Temperature (°C)	Thermal Stability (°C)
$\mu$ ASC - CHU (2)	-10 to 60	N/A
$\mu$ ASC - DPU	-10 to 40	N/A
IMU Sensor	-10 to 50	$\pm 3$
IMU Electronics Box	-10 to 50	N/A
Digitizer (3)	-10 to 40	N/A
Main Electronics Box (MEB)	-10 to 40	N/A
Roll Camera	0 to 45	N/A
Scan Mirror Mechanism	-20 to 20	$\pm 3$
Fast Steering Mirror Mechanism	-20 to 20	$\pm 3$
Diffuser Wheel Mechanism	-10 to 60	N/A
Jitter Suppression Mechanism	-10 to 60	N/A
Contamination Cover Mechanism	-10 to 60	N/A

# Survival Mode Thermal Requirements

Integrated Design Capability / Instrument Design Laboratory

Component	Temperature (°C)
UV/VIS CCD	-120 to 60
VIS/NIR CCD	-120 to 60
SWIR Detector	-240 to 60
Optics	-30 to 60
Optical Bench	-30 to 60
Optics Enclosure	-30 to 60

# Survival Mode Thermal Requirements

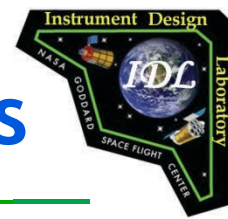

Integrated Design Capability / Instrument Design Laboratory

Component	Temperature (°C)
$\mu$ ASC-CHU	-55 to 85
$\mu$ ASC DPU	-30 to 60
IMU Sensor	-30 to 60
IMU Electronics Box	-55 to 85
Digitizer	-30 to 60
Main Electronics Box (MEB)	-30 to 60
Roll Camera	-30 to 60
Scan Mirror Mechanism	-50 to 80
Fast Steering Mirror Mechanism	-50 to 100
Diffuser Wheel Mechanism	-50 to 80
Jitter Suppression Mechanism	-50 to 100
Contamination Cover Mechanism	-40 to 70



# Baseline Power Dissipation

Integrated Design Capability / Instrument Design Laboratory

Component	Power Dissipation (W)
UV/VIS CCD	2
VIS/NIR CCD	2
SWIR Detector	0.01
Optics	0
Optical Bench	0
Optics Enclosure	0

Merged UV/VIS and VIS/NIR CCD for Case 2 and Case 3: 4 W

# Baseline Power Dissipation

Integrated Design Capability / Instrument Design Laboratory

Component	Power Dissipation (W)
$\mu$ ASC-CHU (2)	0.9 each
$\mu$ ASC DPU	3.1
IMU Sensor	1
IMU Electronics Box	23
Digitizer (3)*	34 total (UV/VIS:16 VIS/NIR:16, SWIR: 2)
Main Electronics Box (MEB)	68
Roll Camera	18
Scan Mirror Mechanism	0.04
Fast Steering Mirror Mechanism	3
Diffuser Wheel Mechanism	2.5
Jitter Suppression Mechanism	5
Contamination Cover Mechanism	0

\*Merged UV/VIS and VIS/NIR digitizer for Case 2 and Case 3: 32 W

# Differences in Electronics Boxes & Mechanisms Power between Cases

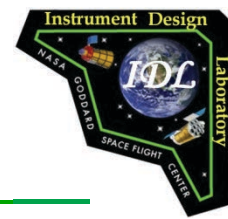

Integrated Design Capability / Instrument Design Laboratory

- Electronics boxes and mechanisms have 158 W power dissipation in baseline
- Case 1 and Case 3 have 2W less power in the digitizer and 0.5W less power in MEB
  - Total power dissipation is 155.5W
- Case 2 has the same digitizer power and same MEB power as baseline
- Basically same radiator size for Electronics Boxes and mechanisms for baseline and all three derivative cases
- 30% uncertainty margin to assure conservatism in worst hot case thermal analysis



# Instrument Thermal Interface with Spacecraft



Integrated Design Capability / Instrument Design Laboratory

- Instrument is thermally isolated from spacecraft nadir deck
- Spacecraft geometry, dimensions and components viewed by instrument are not known



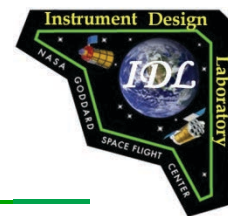

# Orbit Parameters

Integrated Design Capability / Instrument Design Laboratory

- Geostationary orbit
- 35,786 km altitude
- 0° inclination





# Beta Angle and Eclipse Duration

Integrated Design Capability / Instrument Design Laboratory

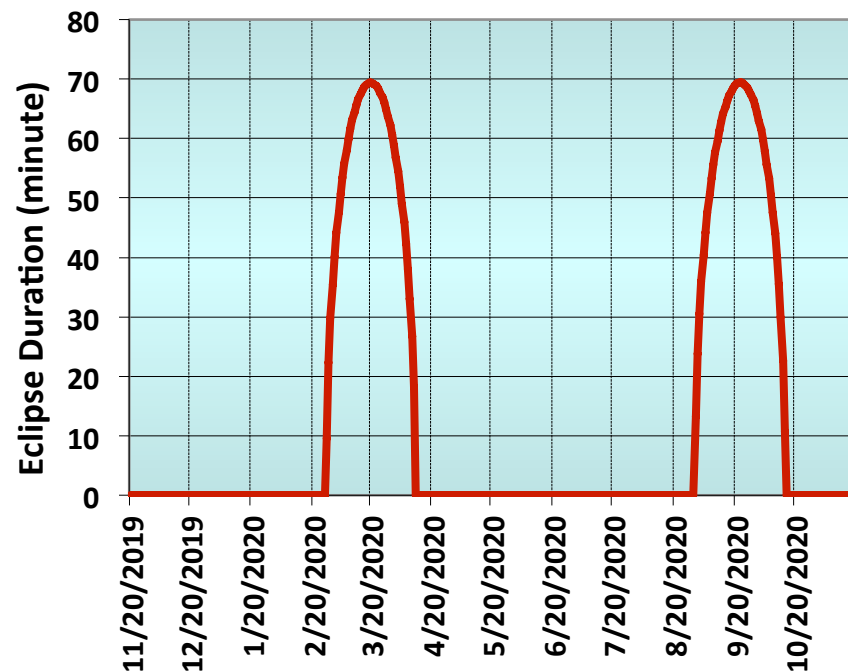
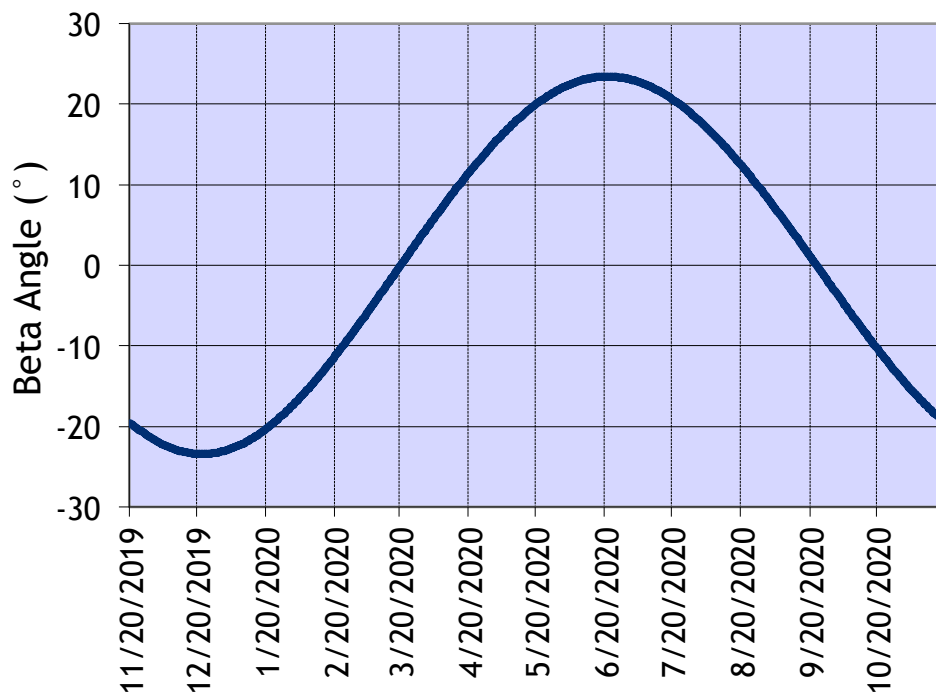

# GEO Orbit

Integrated Design Capability / Instrument Design Laboratory

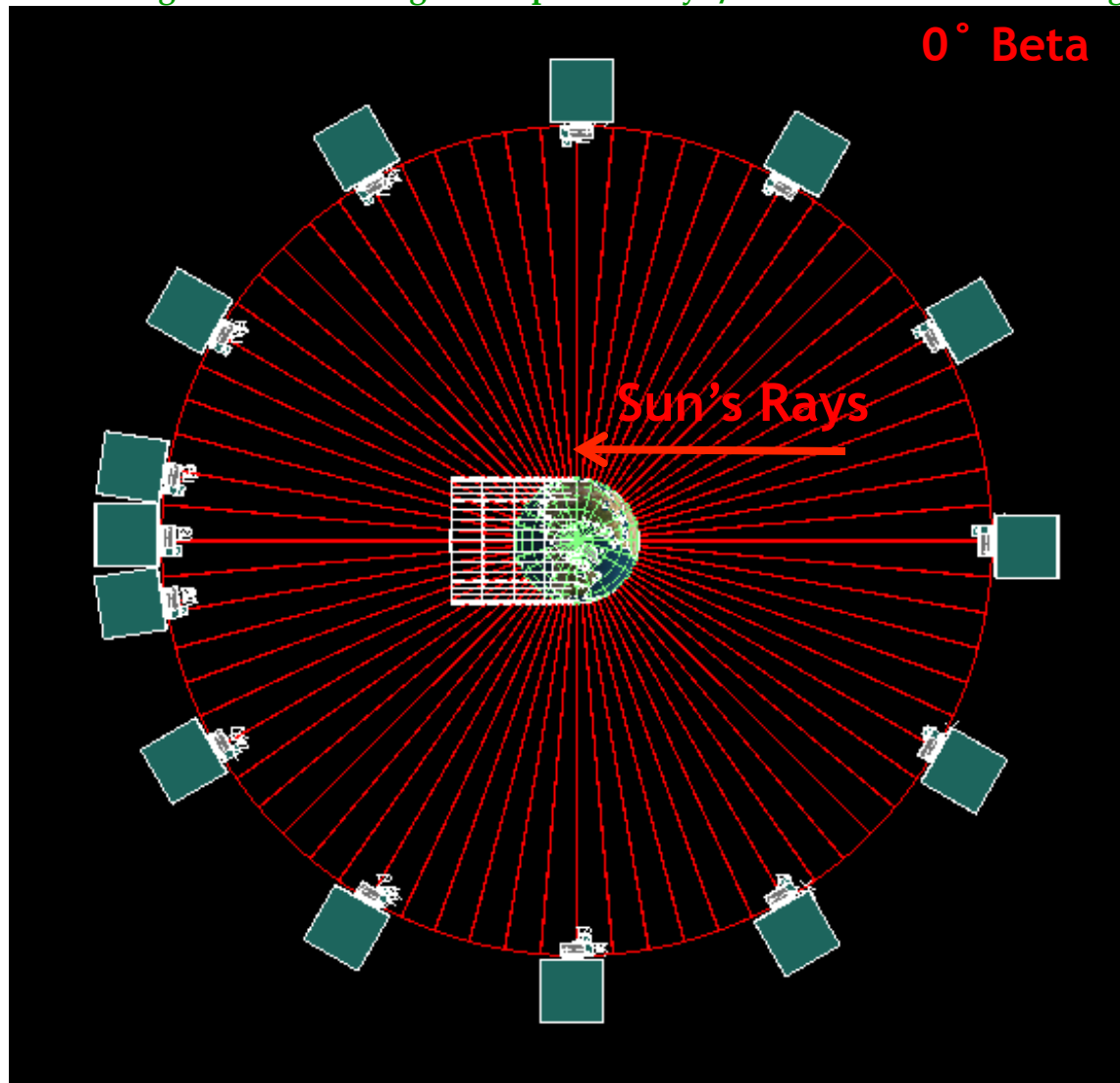

24 Hour Orbit  
Period

# GEO Orbit

Integrated Design Capability / Instrument Design Laboratory

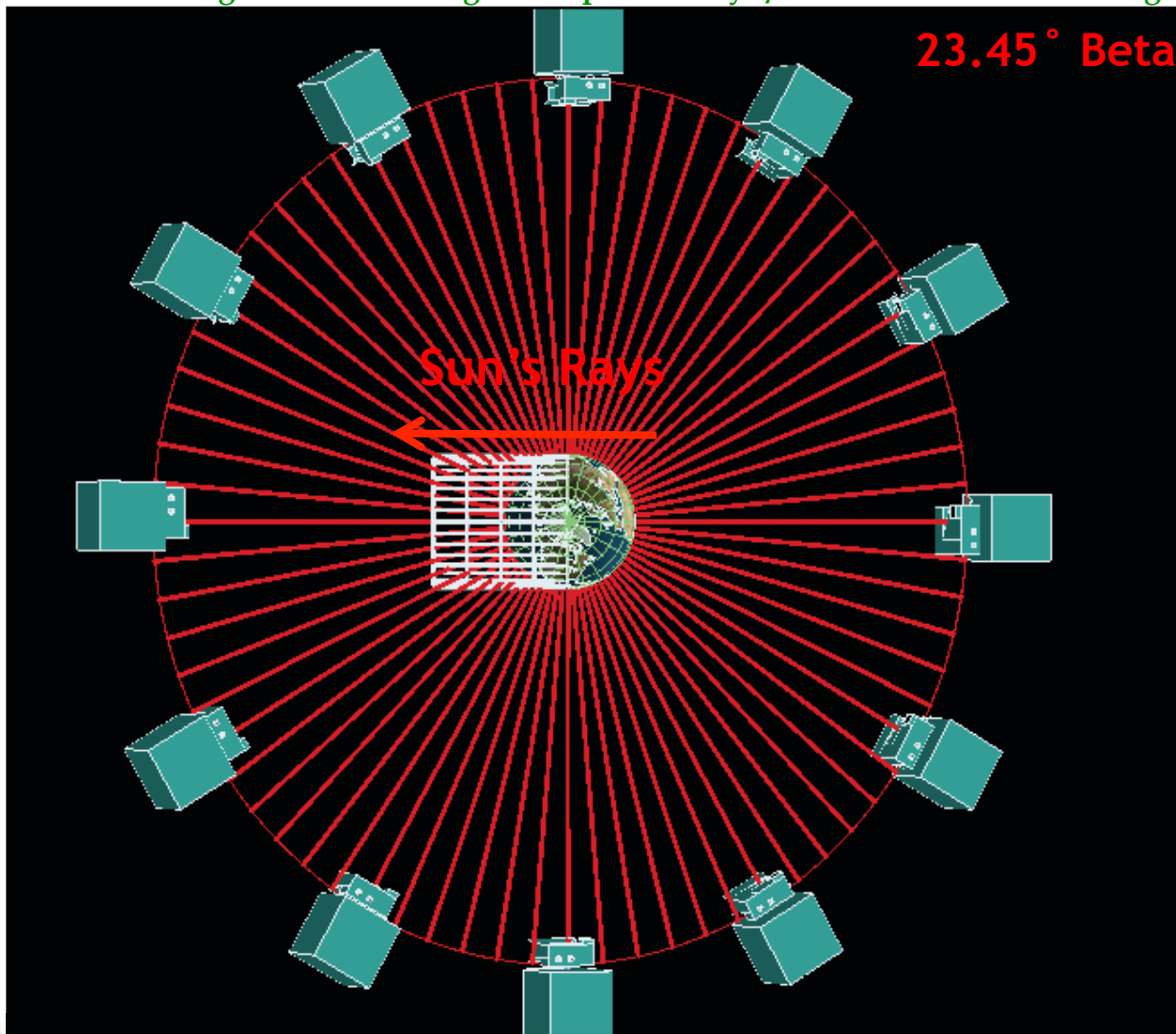

24 Hour Orbit  
Period

# GEO Orbit

Integrated Design Capability / Instrument Design Laboratory

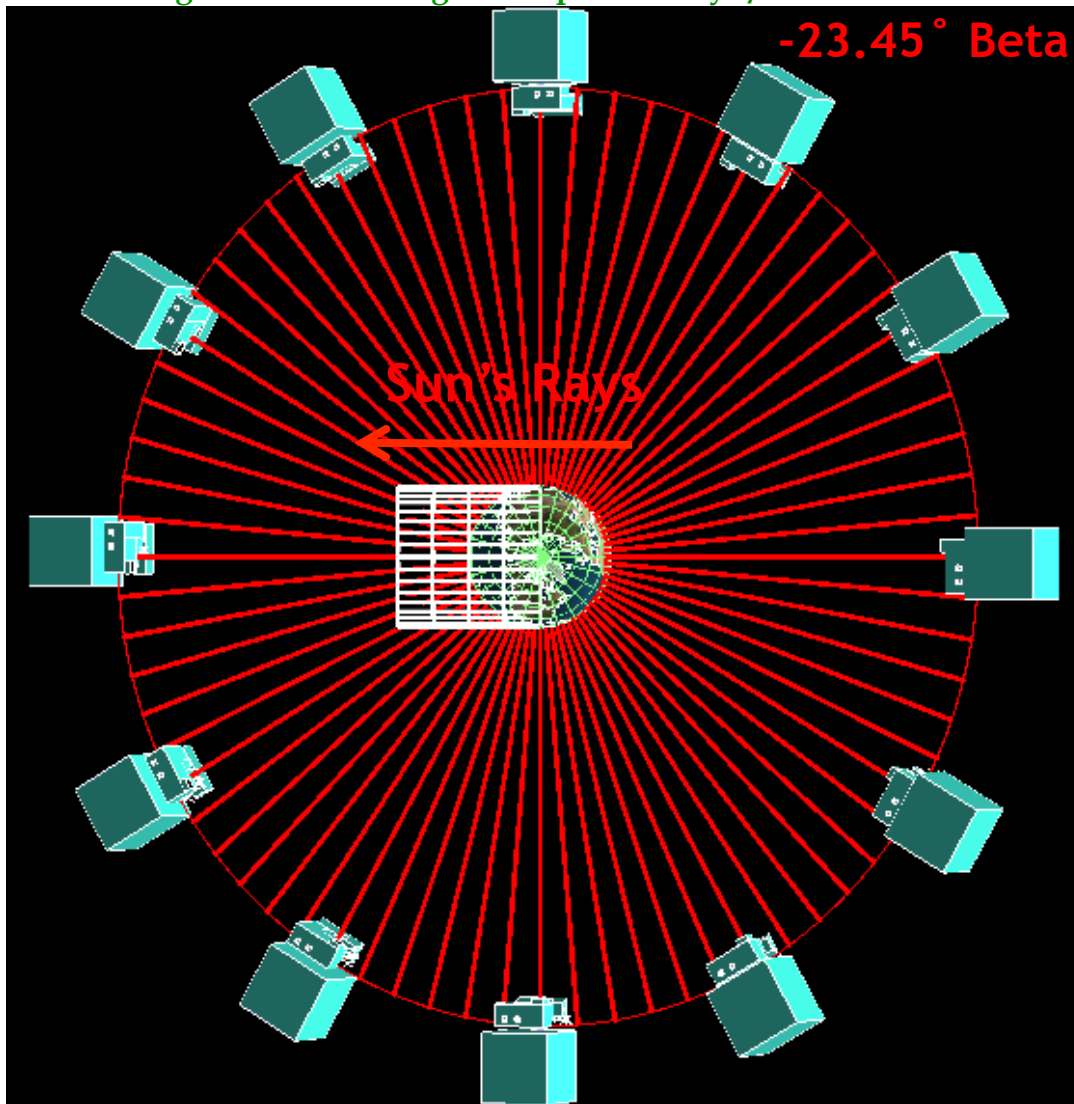

24 Hour Orbit  
Period

# Issue of Solar Flux Entering Scan Aperture

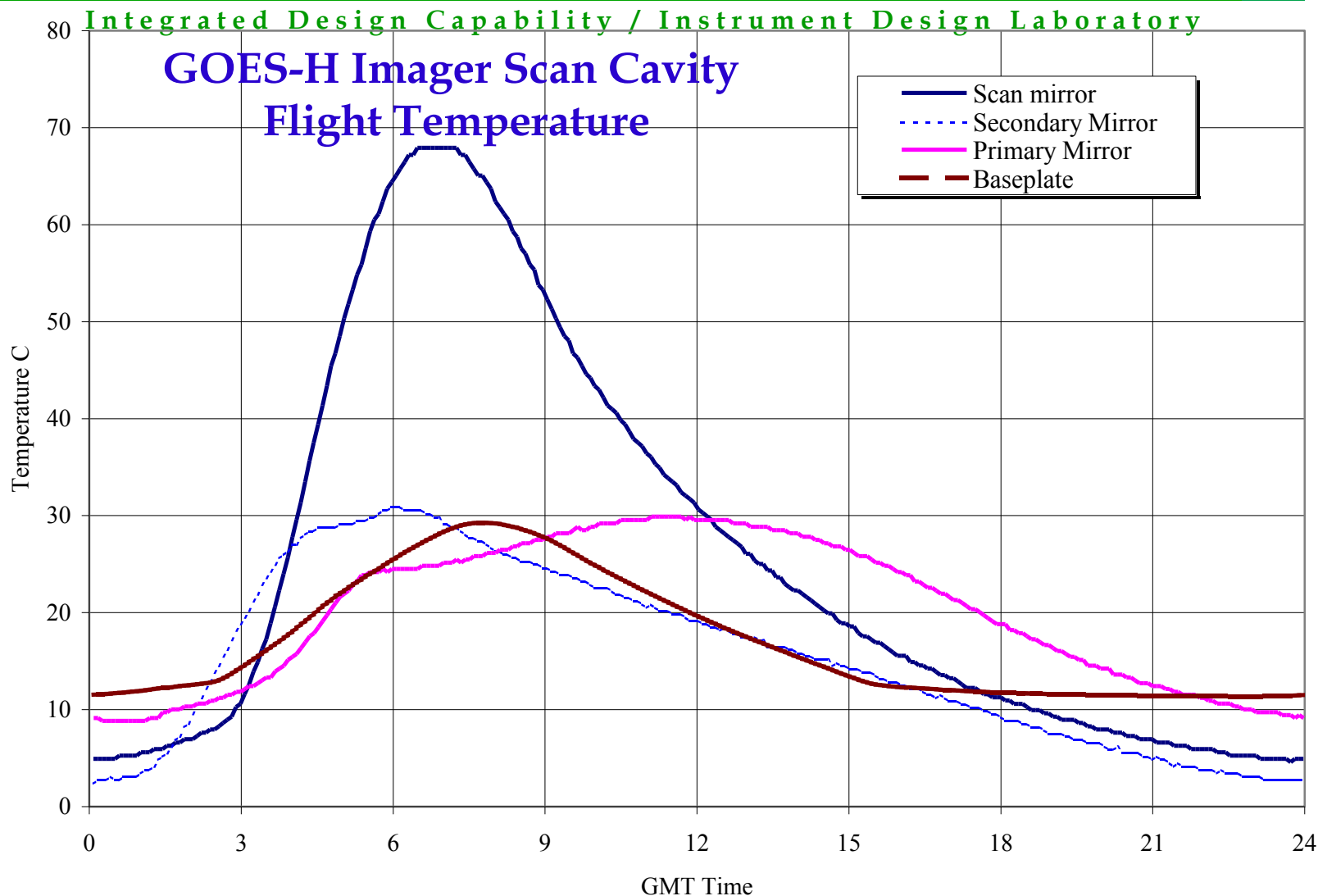

# Aperture Baffle to Meet 16 Hours Science Operations



Integrated Design Capability / Instrument Design Laboratory



Solar flux entering scan cavity is tracked in 30 minute intervals (i.e., 48 orbit positions) in thermal model

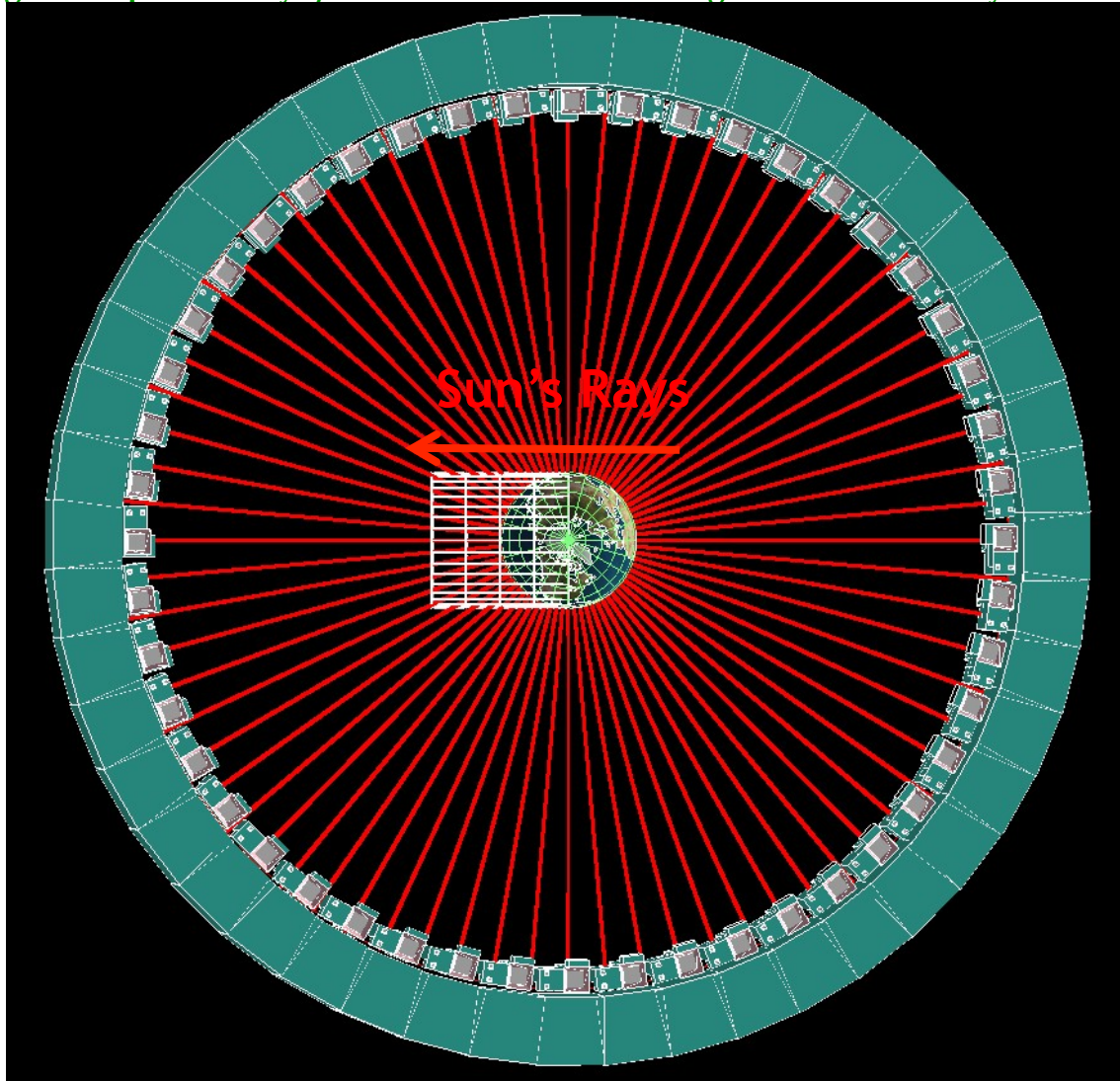

# Aperture Baffle to Meet 16 Hours Science Operations



Integrated Design Capability / Instrument Design Laboratory

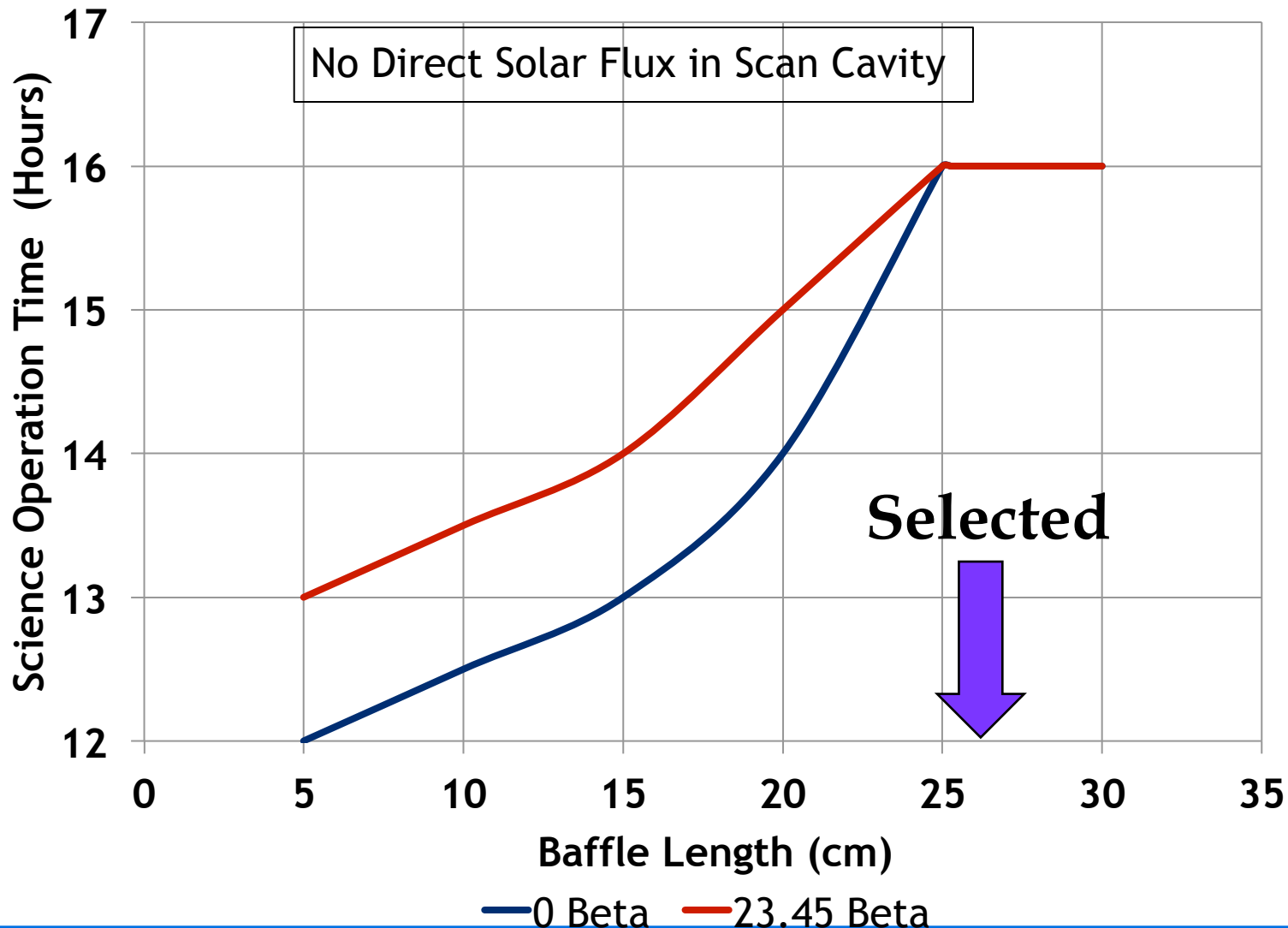

# Sunlight Scattering

Integrated Design Capability / Instrument Design Laboratory

- If aperture baffle interior is coated with Aeroglaze Z307 black paint, sunlight incident on it will be diffusely reflected
- Materials/coatings with near 1.0 solar absorptance may be considered



# Thermal Coating

Integrated Design Capability / Instrument Design Laboratory

- Radiators have optical solar reflector/indium tin oxide (OSR/ITO) conductive coating
- MLI outer cover has conductive silver composite coating
  - Low absorptance and high emittance to keep temperature cool

# Detector Thermal Control

Integrated Design Capability / Instrument Design Laboratory

- Detectors are cold biased by passive cooling
- Trim heaters maintain detector temperature stability
- Detector is thermally isolated from optical bench/optics enclosure
- Short thermal strap transfers heat from detector to cold finger
- Constant conductance heat pipe (CCHP) transfers heat from cold finger to North or South radiator
- Sun-shade/baffle for radiator
  - Exterior insulated with MLI
- CCHPs are insulated with MLI

# Detector Thermal Control

Integrated Design Capability / Instrument Design Laboratory

- **Parasitic heat load is major SWIR detector heat load since detector and radiator are about 170K colder than optics enclosure and optical bench**
  - 1 W plus 50% uncertainty margin
- **Survival heaters**
  - Bimetallic thermostats for heater control
- **SWIR detector has decontamination heater**
  - Commanded on/off
  - Bimetallic thermostats for over-temperature protection

# Electronics Boxes Thermal Control

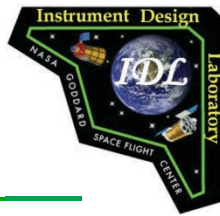

Integrated Design Capability / Instrument Design Laboratory

- **Electronics boxes thermally isolated from optical bench/optics enclosure**
- **Constant conductance heat pipe (CCHP) transfers heat from electronics boxes to North or South radiator**
- **Sun-shade/baffle for radiator**
  - Exterior insulated with MLI
- **Electronics boxes and CCHPs are insulated with MLI**
- **Survival heaters**
  - Bimetallic thermostats for heater control



# Mechanism Thermal Control

Integrated Design Capability / Instrument Design Laboratory

- Scan Mirror, Fast Steering Mirror, Jitter Suppression and Diffuser Wheel mechanisms are thermally coupled to electronics boxes CCHP
- Survival heaters for all mechanisms
  - Bimetallic thermostats for heater control

# Optical Bench and Optics Enclosure Thermal Control



Integrated Design Capability / Instrument Design Laboratory

- **Optical Bench, Optics Enclosure and flexures have active heater control and MLI**
  - Bimetallic thermostats for heater control
- **Survival heaters**
  - Bimetallic thermostats for heater control



# Optics and Optical Bench Thermal

Integrated Design Capability / Instrument Design Laboratory

- Instrument thermally isolated from spacecraft
- Flexures and exterior of optics enclosure and optical bench insulated with MLI thermal blankets
- Optical bench thermally isolated from spacecraft
- Thermal coating for interior of optics enclosure and optical bench is Aeroglaze Z307 black paint
- Kapton film heaters attached to selected locations of optics enclosure exterior and optical bench to maintain optics at 20°C in operating mode
  - Operating mode heater circuits controlled to 20°C±2°C by mechanical thermostats
- Other heater circuits
  - Survival heaters

# Standby Mode Power Management

Integrated Design Capability / Instrument Design Laboratory

- **Detectors, digitizers, mirror mechanisms and electronics boxes are powered off in Standby Mode (6.5 hours) to**
  - Minimize power requirement from S/C bus
  - Increase reliability
- **Some makeup heater power is required for detectors and electronics boxes**
  - Detector temperature needs to be maintained the same as operating mode
  - Temperature of electronics boxes needs to be maintained above  $-10^{\circ}\text{C}$



# Radiator and Heater Power Sizing



Integrated Design Capability / Instrument Design Laboratory

- Radiators are sized for worst hot operating case
- Operating mode heater power is sized for worst cold operating case
- GSFC Gold Rules call for a maximum of 70% heater duty cycle for an active heater control thermal design
  - In sizing heater electrical resistance (R), orbital average heater power shall be no more than 70% of peak heater power ( $V^{**2}/R$ )
    - Valid for both bang-bang and proportional/integral/derivative (PID) controllers



# Thermal Model

Integrated Design Capability / Instrument Design Laboratory

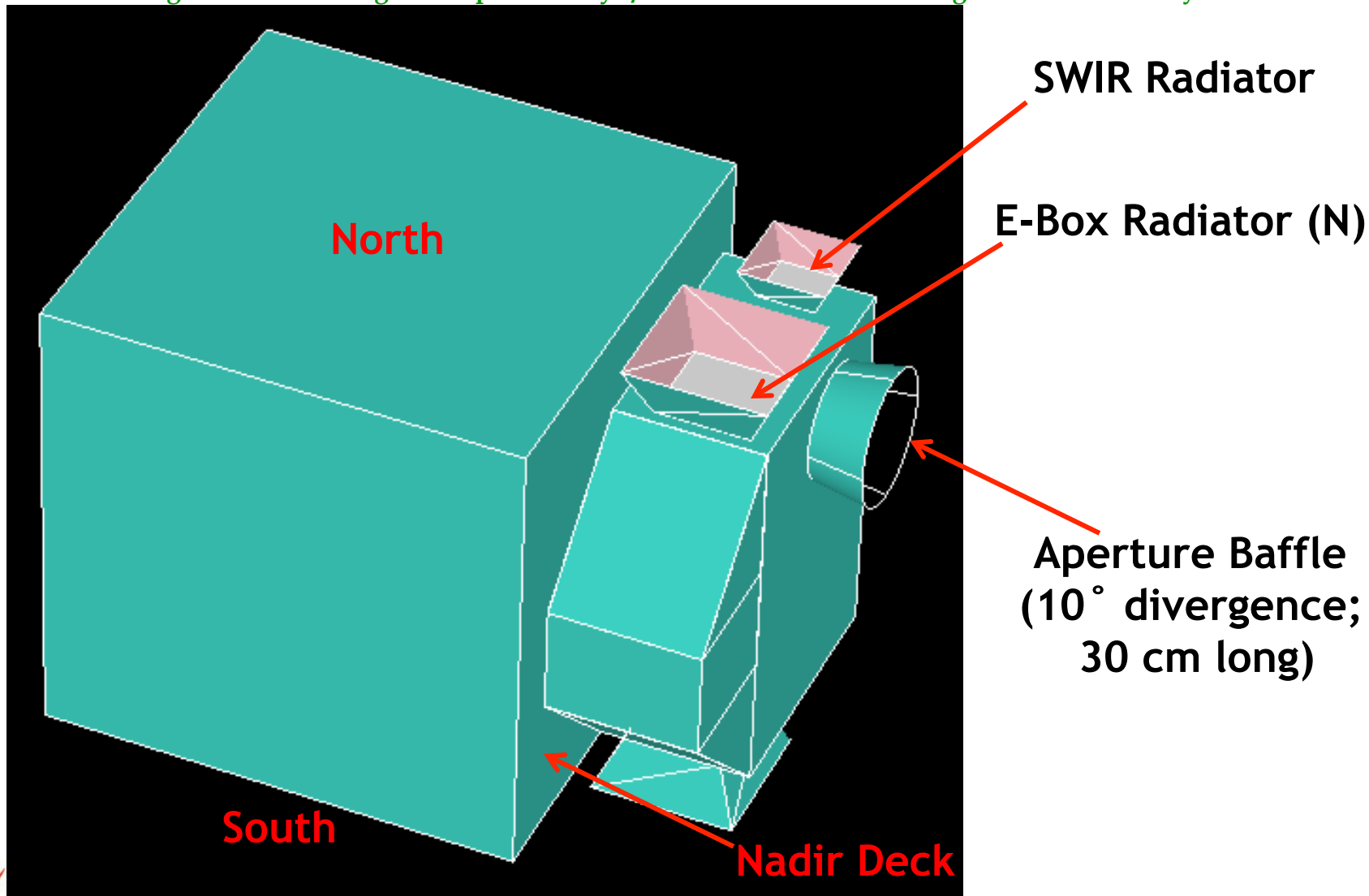

# Thermal Model

Integrated Design Capability / Instrument Design Laboratory

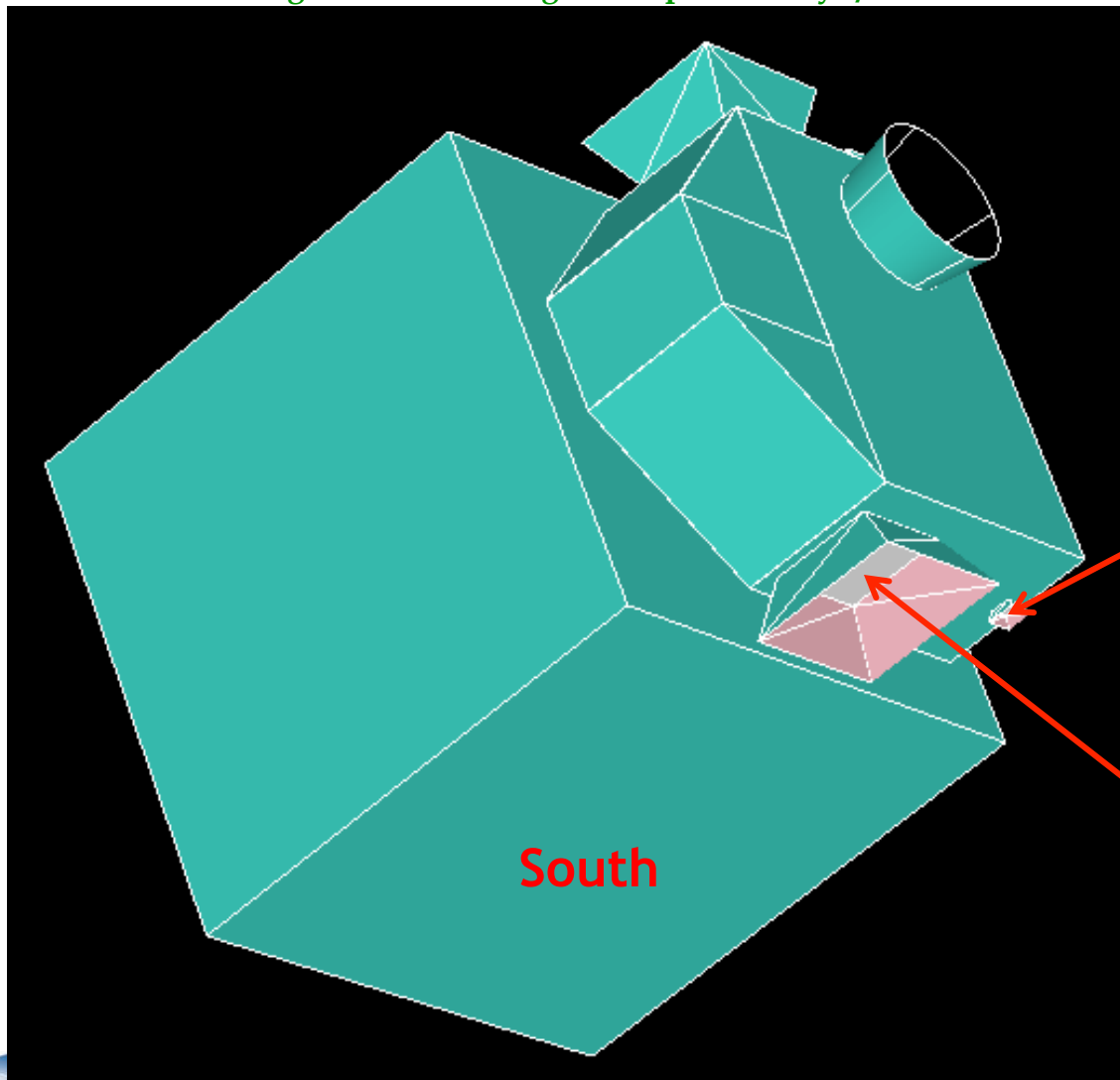

UV/VIS and VIS/NIR  
Radiator

E-Box Radiator (S)

# Thermal Model

Integrated Design Capability / Instrument Design Laboratory

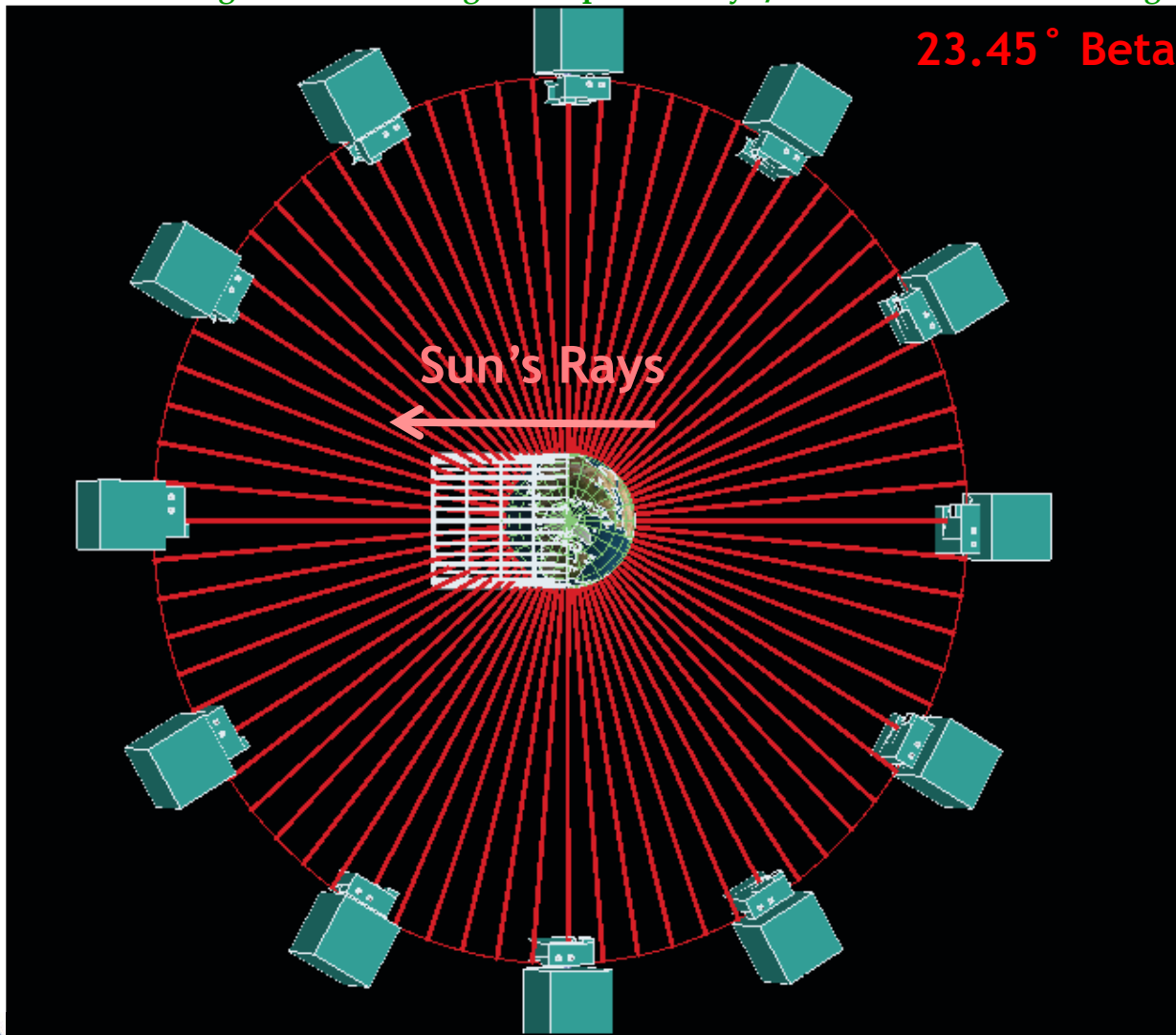

**Worst Hot Case  
for Detector  
North Radiators**

# Thermal Model

Integrated Design Capability / Instrument Design Laboratory

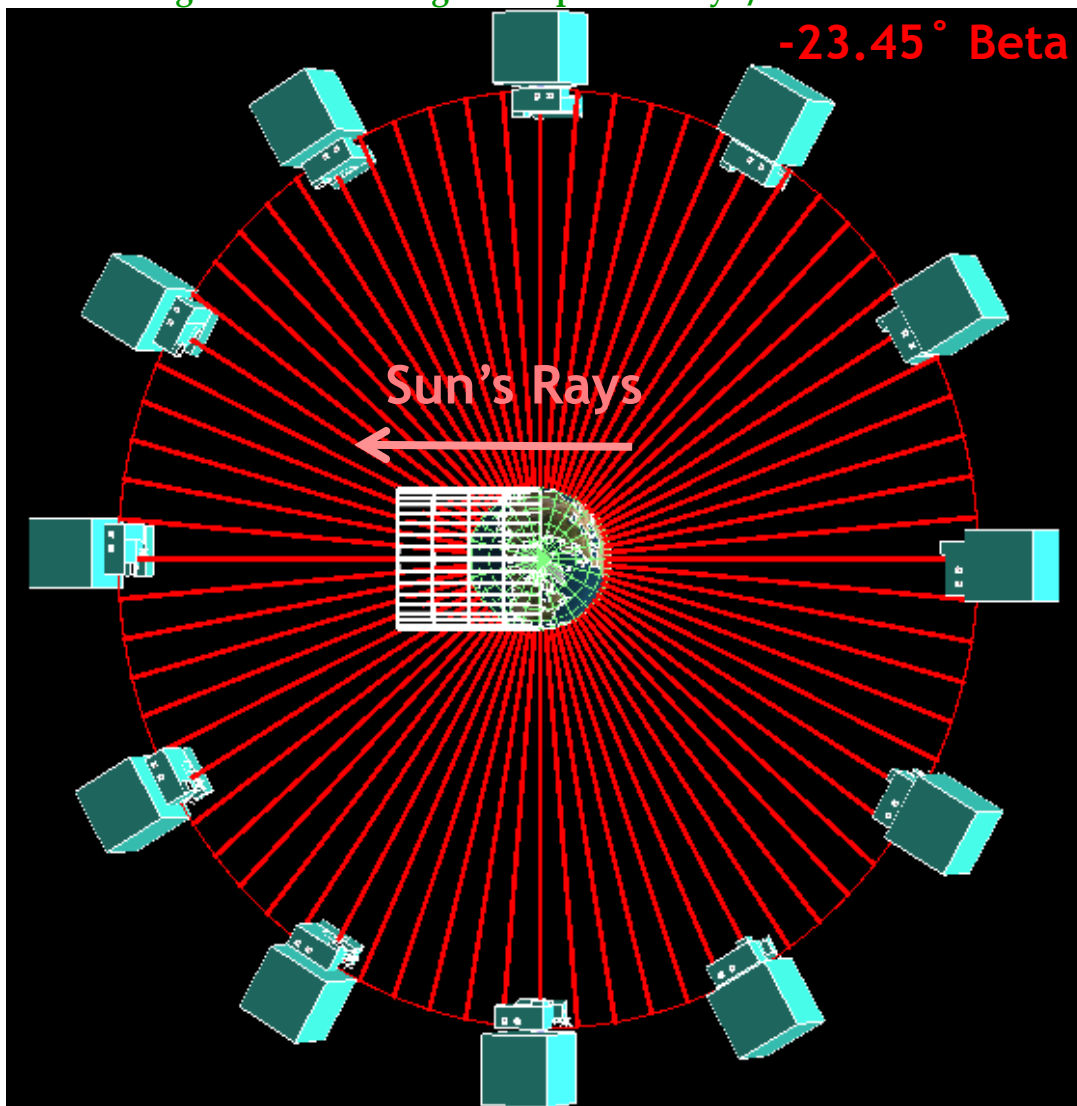

**Worst Hot Case  
 for Electronics  
 Boxes South  
 Radiator**

# Electronics Boxes and Mechanisms Worst Hot Case Temperature Predictions

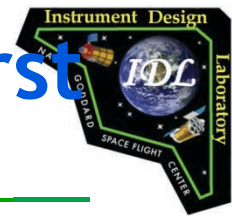

Integrated Design Capability / Instrument Design Laboratory

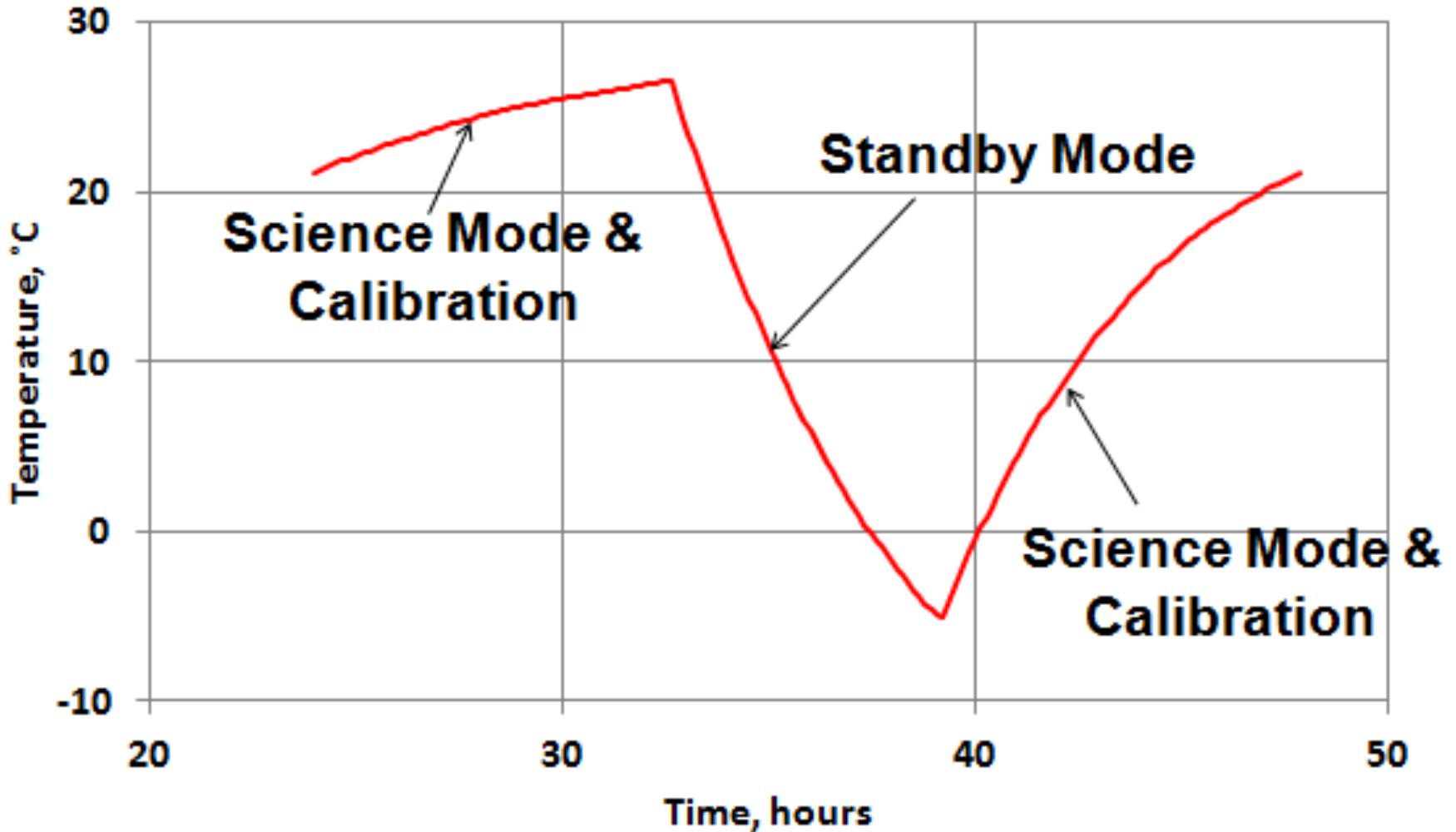

# Electronics Boxes and Mechanisms Worst Cold Case Temperature Predictions

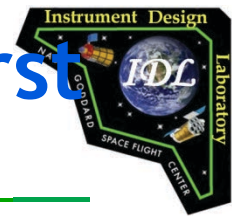

Integrated Design Capability / Instrument Design Laboratory

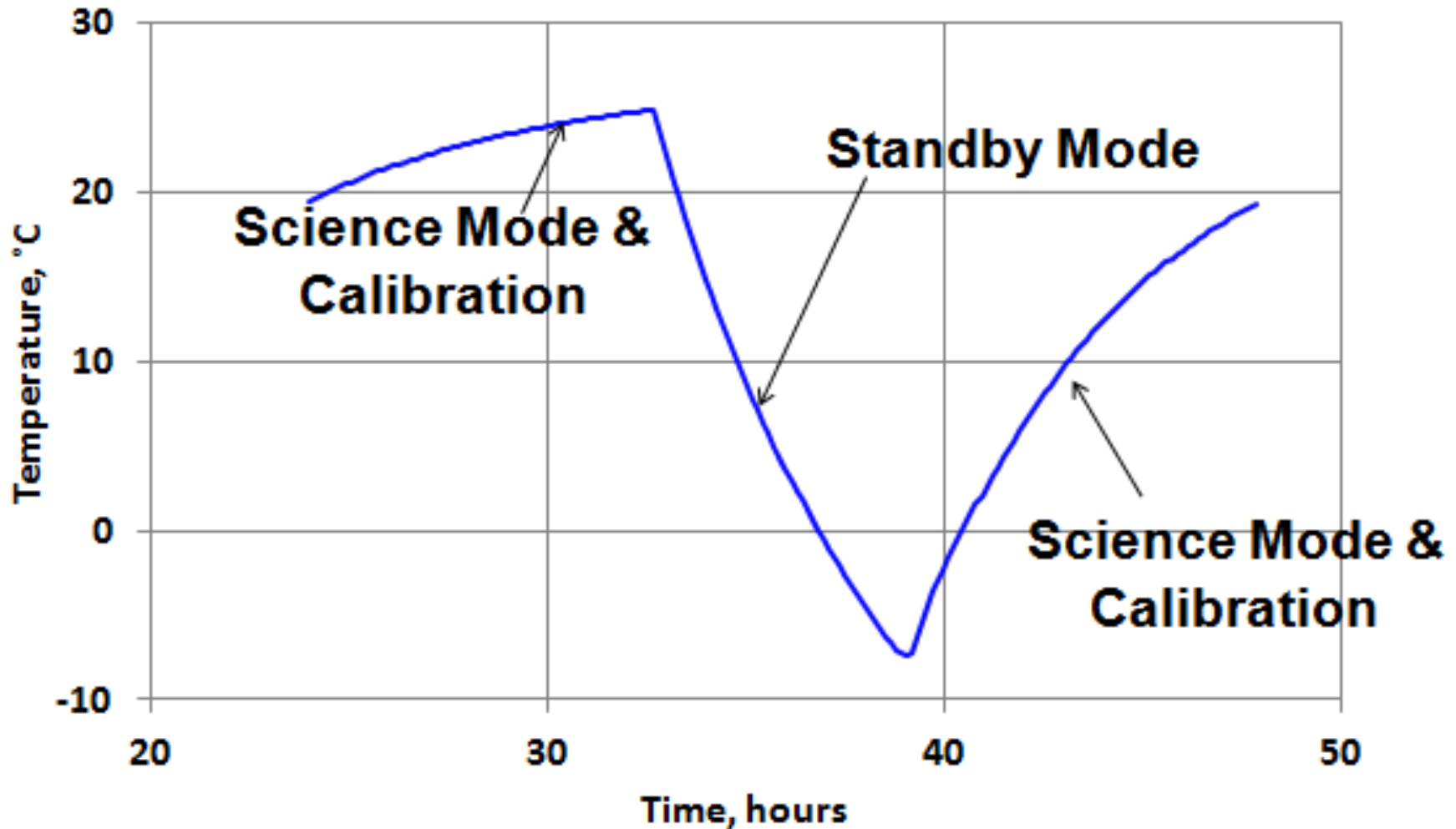

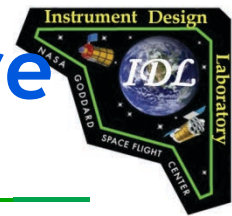

# Detector Worst Cold Case Temperature Predictions (Heater Enabled)

Integrated Design Capability / Instrument Design Laboratory

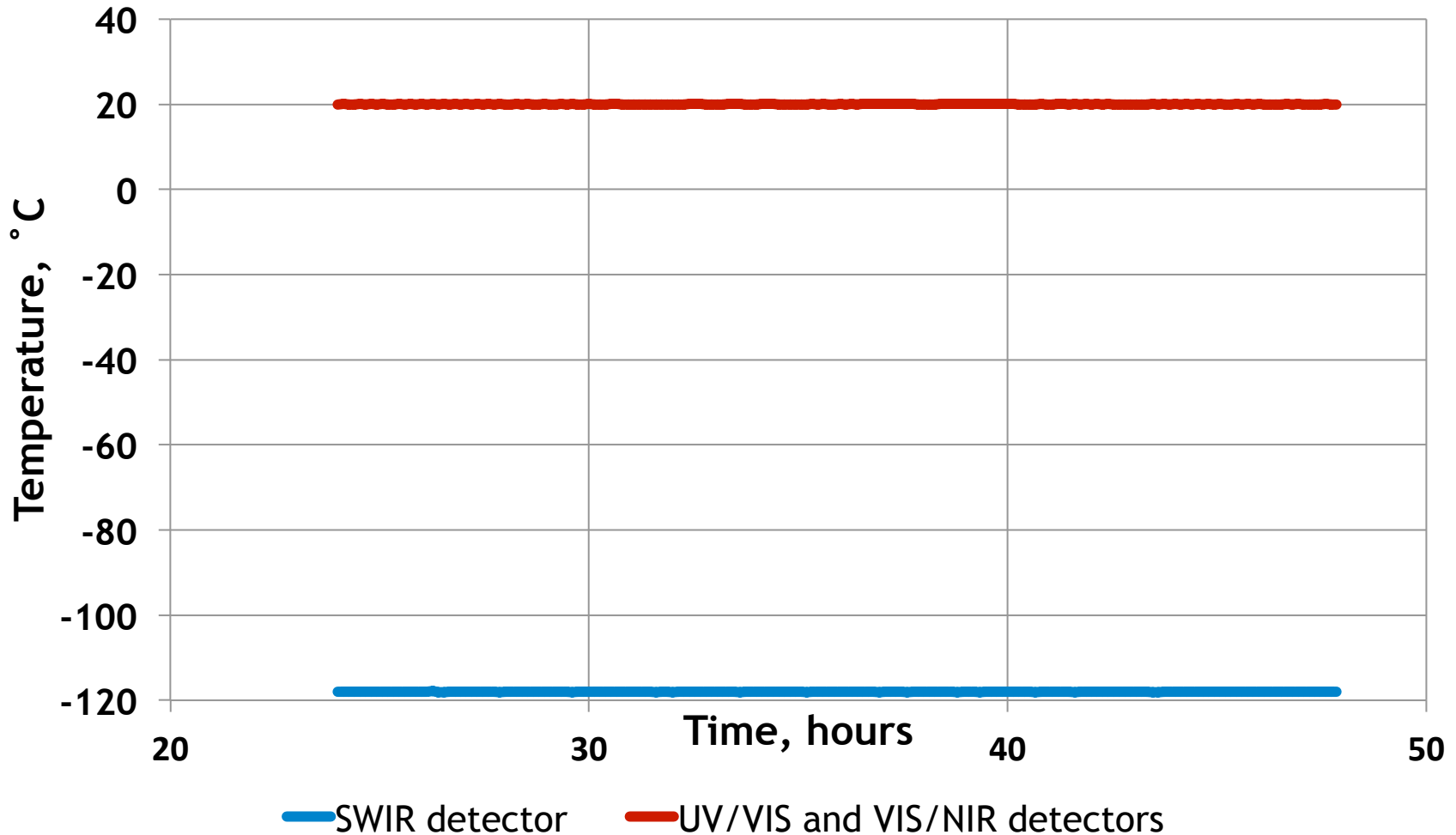



# Optics/Optical Bench Worst Cold Case Temperature Predictions (Heater Enabled)

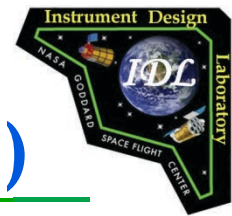

Integrated Design Capability / Instrument Design Laboratory

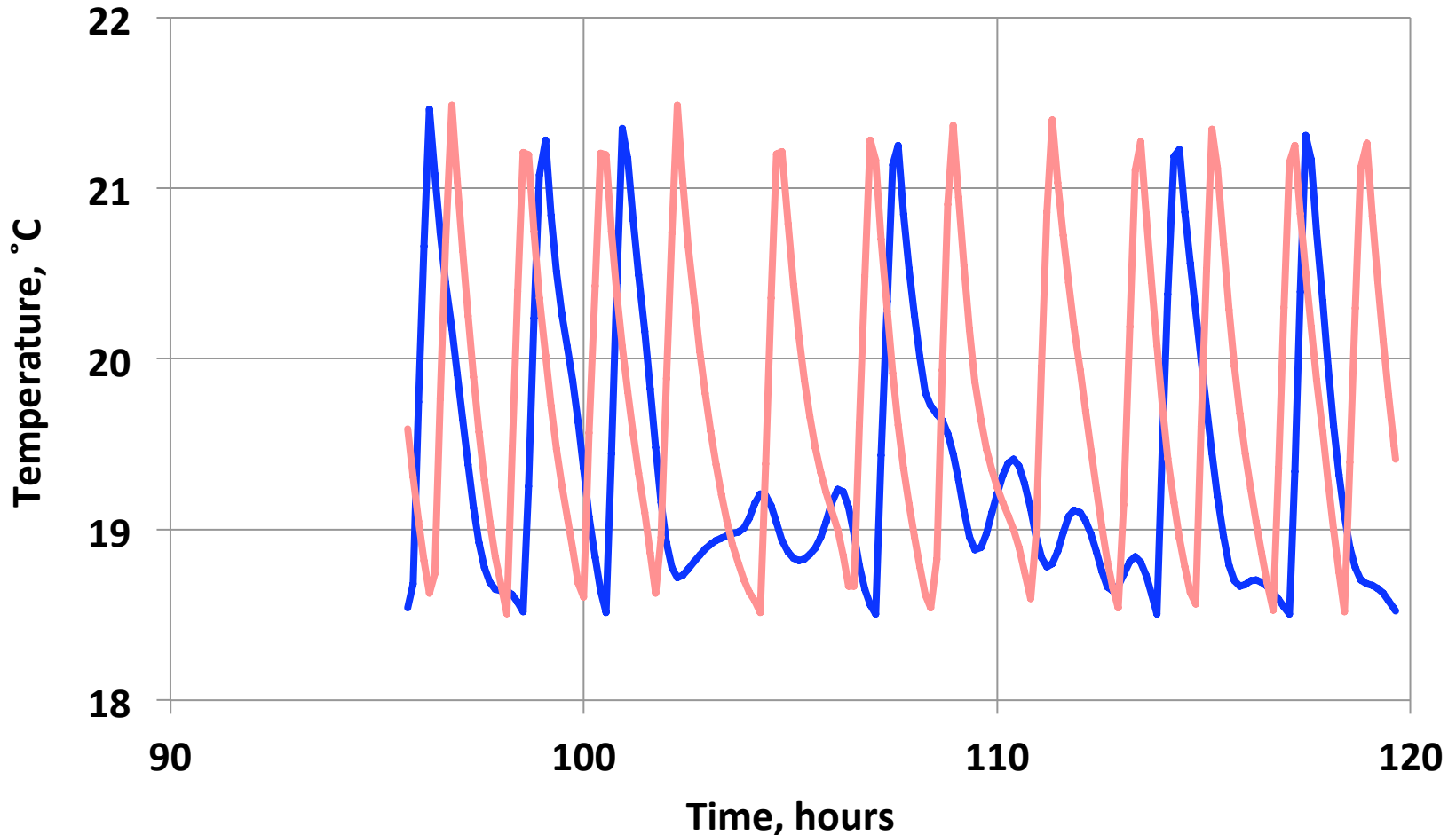



# Baseline Radiator Area Summary

Integrated Design Capability / Instrument Design Laboratory

	Radiator Area (m <sup>2</sup> )
UV/Vis and Vis/NIR CCD Detectors*	0.019
SWIR Detectors**	0.09
Electronics Boxes***	North: 0.294 South: 0.294

**\*Merged for Case 2 and Case 3 (unchanged)**

**\*\*Remove for Case 1 and Case 3**

**\*\*\*Unchanged for Derivative cases**



# Baseline Operating Mode Heater Circuits

Integrated Design Capability / Instrument Design Laboratory

	Control	Primary Circuits	Redundant Circuits
Optical Bench Optics Enclosure	Mechanical Thermostats	22	22
UV/Vis*	Electronics Controller	1	1
Vis/NIR*	Electronics Controller	1	1
SWIR**	Electronics Controller	1	1
Electronics Boxes and Mirror Mechanisms (Standby Mode)	Mechanical Thermostats	12	12
<b>Total</b>		<b>37</b>	<b>37</b>

\*Merged to 1 for Case 2 and Case 3

\*\*Remove for Case 1 and Case 3



# Survival Heater Circuits (Mechanical Thermostat Control)

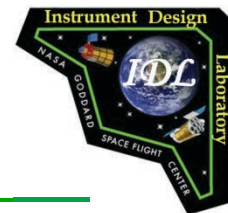

Integrated Design Capability / Instrument Design Laboratory

	Primary Circuits	Redundant Circuits
Optical Bench/Optics Enclosure	12	12
UV/Vis CCD*	1	1
Vis/NIR CCD*	1	1
SWIR**	1	1
MEB	1	1
IMU Electronics	1	1
IMU Sensor	1	1
Digitizers***	3	3
ASC/DPU	1	1
ASC/CHU	2	2
Roll Camera	1	1
Scan Mirror Mechanism	1	1
Fast Steering Mechanism	1	1
Diffuser Wheel Mechanism	1	1
Jitter Suppression Mechanism	1	1
Contamination Cover Mechanism	1	1
<b>Total</b>	<b>30</b>	<b>30</b>

\*Merged to 1 for Case 2 and Case 3      \*\*Remove for Case 1 and Case 3  
 \*\*\*2 for Case 1 and 2; 1 for Case 3



# Baseline Operating Mode Heater Power

Integrated Design Capability / Instrument Design Laboratory

	Average Heater Power (W)
Optical Bench/Optics Enclosure	160
Detectors*	4
Total	164

\*2 W for Case 1 and Case 2; 1 W for Case 3

# Operating Mode Heater Power for Delta Cases



Integrated Design Capability / Instrument Design Laboratory

	Average Heater Power (W)
Delta 1	162
Delta 2	162
Delta 3	161



# Baseline Cold Survival Heater Power



Integrated Design Capability / Instrument Design Laboratory

	Average Heater Power (W)
Optics (Heaters on Optical Bench/Optics Enclosure)	85
Detectors*	3
Electronics Boxes and Mechanisms**	82
Total	170

\*2 W for Case 1 and Case 2; 1 W for Case 3

\*\*Same for Baseline and all Derivative cases



# Cold Survival Heater Power for Delta Cases



Integrated Design Capability / Instrument Design Laboratory

	Average Heater Power (W)
Delta 1	169
Delta 2	169
Delta 3	168





# Baseline Mass Estimates and TRL

Instrument Components	Mass Each (kg)	Qty	Mass Total (kg)	TRL
SWIR Detector Radiator (0.09 m <sup>2</sup> ; 0.254 cm aluminum)*	0.618	1	0.618	7
UV/VIS and VIS/NIR CCD Detector Radiator (0.019 m <sup>2</sup> ; 0.254 cm aluminum)	0.1302	1	0.1302	7
Electronics Boxes and Mechanisms Radiator (0.294 m <sup>2</sup> ; 0.254 cm aluminum)	2.0212	2	4.0424	7
SWIR Detector Radiator OSR/ITO and Adhesive (0.09 m <sup>2</sup> )*	0.12	1	0.12	9
UV/VIS and VIS/NIR CCD Detector Radiator OSR/ITO and Adhesive (0.019 m <sup>2</sup> )	0.0244	1	0.0244	9
Electronics Boxes and Mechanisms Radiator OSR/ITO and Adhesive (0.294 m <sup>2</sup> )	0.3794	2	0.7588	9
SWIR Detector Radiator Sun-Shade (0.164 m <sup>2</sup> ; aluminum)*	0.699	1	0.699	7
UV/VIS and VIS/NIR CCD Detector Radiator Sun-Shade (0.0347 m <sup>2</sup> ; aluminum)	0.1478	1	0.1478	7
Electronics Boxes and Mechanisms Radiator Sun-Shade Support Structure (0.851 m <sup>2</sup> ; hogged out 0.254 cm aluminum)	0.8758	2	1.7516	7
Heat Pipe (CCHP) for SWIR Detectors (1.5 m long; 1.27 cm diam.; aluminum; ethane)*	0.3	2	0.6	7
Heat Pipe (CCHP) for UV/VIS and VIS/NIR Detector (1.5 m long; 1.27 cm diam.; aluminum; ammonia)	0.3	2	0.6	7
Heat Pipe (CCHP) for Electronics Boxes and Mechanisms (5.25 m long; 1.27 cm diam.; aluminum; ammonia)	1.05	2	2.1	7
Spreader CCHP for Electronics Boxes and Mechanisms Radiator (0.5 m long; 1.27 cm diam.; aluminum; ammonia)	0.1	8	0.8	7
K1100 Heat Strap from SWIR Detector to Cold Finger (7.62 cm long)*	0.066	1	0.066	7
K1100 Heat Strap from UV/VIS and VIS/NIR CCD Detector to Cold Finger (7.62 cm long)	0.132	2	0.264	7
Aeroglaze Z307 black paint for Optics Enclosure and Optical Bench (8.9 m <sup>2</sup> )	0.801	1	0.801	9
Aeroglaze Z307 black paint for aperture baffle interior (0.582 m <sup>2</sup> )	0.0524	1	0.0524	9
MLI (15-layers) for Optics Enclosure and Optical Bench (8.9 m <sup>2</sup> )	5.34	1	5.34	9
MLI (15-layers) for aperture baffle (0.582 m <sup>2</sup> )	0.3495	1	0.3495	9
MLI (15-layers) for aperture deployable contamination cover (1.2 m <sup>2</sup> )	0.72	1	0.72	9
MLI (15-layers) on Backside of SWIR Detector Radiator (0.09 m <sup>2</sup> )*	0.054	1	0.054	9
MLI (15-layers) on Backside of Electronics Boxes and Mechanisms Radiator (0.294 m <sup>2</sup> )	0.1764	2	0.3528	9
MLI (15-layers) on SWIR Detector Radiator Sun-Shade (0.164 m <sup>2</sup> )*	0.098	1	0.098	9
MLI (15-layers) on UV/VIS and VIS/NIR CCD Detector Radiator Sun-Shade (0.0347 m <sup>2</sup> )	0.0209	1	0.0209	9



# Baseline Mass Estimates and TRL

Instrument Components	Mass Each (kg)	Qty	Mass Total (kg)	TRL
MLI (15-layers) on Electronics Boxes and Mechanisms Radiator Sun-Shade (0.851 m2)	0.511	2	1.022	9
MLI (15-layers) SWIR ethane heat pipes (0.12 m2)*	0.072	1	0.072	9
MLI (15-layers) for Diffuser Wheel Enclosure (0.435 m2)	0.261	1	0.261	9
MLI (15-layers) for UV/VIS and VIS/NIR CCD Detector Housing Exterior (0.08 m2)	0.048	2	0.096	9
MLI (15-layers) for SWIR Detector Housing Exterior (0.132 m2)	0.079	1	0.079	9
MLI (15-layers) for MEB (0.247 m2)	0.148	1	0.148	9
MLI (15-layers) for UV/VIS and VIS/NIR Digitizers (0.1088 m2)	0.0653	2	0.1306	9
MLI (15-layers) for SWIR Digitizer (0.0175 m2)*	0.0105	1	0.0105	9
MLI (15-layers) for IMU Sensor (0.461 m2)	0.2768	1	0.2768	9
MLI (15-layers) for IMU Electronics Box (0.218 m2)	0.131	1	0.131	9
MLI (15-layers) for ASC DPU (0.107 m2)	0.064	1	0.064	9
MLI (15-layers) for ASC CHU and Baffles (0.032 m2)	0.019	2	0.038	9
MLI (15-layers) for roll camera (0.658 m2)	0.3948	1	0.3948	9
Thermistors/Platinum RTDs for Telemetry	0.001	34	0.034	9
Thermistors/Platinum RTDs for Heater Control (Redundancy included)	0.001	6	0.006	9
Thermostats for Op Heaters -- Honeywell 3100 Series (Redundancy included)	0.006	138	0.828	9
Thermostats for Survival Heaters -- Honeywell 3100 Series (Redundancy included)	0.006	128	0.768	9
Op Heaters -- Kapton Film 5.5 cm x 6.4 cm (Redundancy included)	0.002	24	0.048	9
Op Heaters -- Kapton Film 20 cm x 20 cm (Redundancy included)	0.0229	96	2.1984	9
Survival Heaters -- Kapton Film 5.5 cm x 6.4 cm (Redundancy included)	0.002	64	0.128	9
SWIR Decontamination Heaters	0.002	2	0.004	9
Buttons, Velcro and Tape for MLI	0.9	1	0.9	9
Adhesive (STYCAST, Nusil) and Aluminum Tape for Heaters, Thermostats and Thermistors/Platinum RTDs	0.5	1	0.5	9
<b>Total</b>			<b>28.6489</b>	



# Case-1 Mass Estimates and TRL

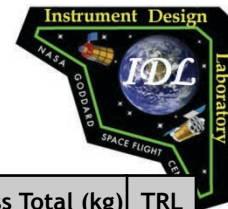

Instrument Components	Mass Each (kg)	Qty	Mass Total (kg)	TRL
UV/VIS and VIS/NIR CCD Detector Radiator (0.019 m <sup>2</sup> ; 0.254 cm aluminum)	0.1302	1	0.1302	7
Electronics Boxes and Mechanisms Radiator (0.294 m <sup>2</sup> ; 0.254 cm aluminum)	2.0212	2	4.0424	7
UV/VIS and VIS/NIR CCD Detector Radiator OSR/ITO and Adhesive (0.019 m <sup>2</sup> )	0.0244	1	0.0244	9
Electronics Boxes and Mechanisms Radiator OSR/ITO and Adhesive (0.294 m <sup>2</sup> )	0.3794	2	0.7588	9
UV/VIS and VIS/NIR CCD Detector Radiator Sun-Shade (0.0347 m <sup>2</sup> ; aluminum)	0.1478	1	0.1478	7
Electronics Boxes and Mechanisms Radiator Sun-Shade Support Structure (0.851 m <sup>2</sup> ; hogged out 0.254 cm aluminum)	0.8758	2	1.7516	7
Heat Pipe (CCHP) for UV/VIS and VIS/NIR Detector (1.5 m long; 1.27 cm diam.; aluminum; ammonia)	0.3	2	0.6	7
Heat Pipe (CCHP) for Electronics Boxes and Mechanisms (5.25 m long; 1.27 cm diam.; aluminum; ammonia)	1.05	2	2.1	7
Spreader CCHP for Electronics Boxes and Mechanisms Radiator (0.5 m long; 1.27 cm diam.; aluminum; ammonia)	0.1	8	0.8	7
K1100 Heat Strap from UV/VIS and VIS/NIR CCD Detector to Cold Finger (7.62 cm long)	0.132	2	0.264	7
Aeroglaze Z307 black paint for Optics Enclosure and Optical Bench (8.9 m <sup>2</sup> )	0.801	1	0.801	9
Aeroglaze Z307 black paint for aperture baffle interior (0.582 m <sup>2</sup> )	0.0524	1	0.0524	9
MLI (15-layers) for Optics Enclosure and Optical Bench (8.9 m <sup>2</sup> )	5.34	1	5.34	9
MLI (15-layers) for aperture baffle (0.582 m <sup>2</sup> )	0.3495	1	0.3495	9
MLI (15-layers) for aperture deployable contamination cover (1.2 m <sup>2</sup> )	0.72	1	0.72	9
MLI (15-layers) on Backside of Electronics Boxes and Mechanisms Radiator (0.294 m <sup>2</sup> )	0.1764	2	0.3528	9
MLI (15-layers) on UV/VIS and VIS/NIR CCD Detector Radiator Sun-Shade (0.0347 m <sup>2</sup> )	0.0209	1	0.0209	9
MLI (15-layers) on Electronics Boxes and Mechanisms Radiator Sun-Shade (0.851 m <sup>2</sup> )	0.511	2	1.022	9
MLI (15-layers) for Diffuser Wheel Enclosure (0.435 m <sup>2</sup> )	0.261	1	0.261	9
MLI (15-layers) for UV/VIS and VIS/NIR CCD Detector Housing Exterior (0.08 m <sup>2</sup> )	0.048	2	0.096	9
MLI (15-layers) for MEB (0.247 m <sup>2</sup> )	0.148	1	0.148	9
MLI (15-layers) for UV/VIS and VIS/NIR Digitizers (0.1088 m <sup>2</sup> )	0.0653	2	0.1306	9
MLI (15-layers) for IMU Sensor (0.461 m <sup>2</sup> )	0.2768	1	0.2768	9
MLI (15-layers) for IMU Electronics Box (0.218 m <sup>2</sup> )	0.131	1	0.131	9
MLI (15-layers) for ASC DPU (0.107 m <sup>2</sup> )	0.064	1	0.064	9
MLI (15-layers) for ASC CHU and Baffles (0.032 m <sup>2</sup> )	0.019	2	0.038	9
MLI (15-layers) for roll camera (0.658 m <sup>2</sup> )	0.3948	1	0.3948	9
Thermistors/Platinum RTDs for Telemetry	0.001	32	0.032	9
Thermistors/Platinum RTDs for Heater Control (Redundancy included)	0.001	4	0.004	9
Thermostats for Op Heaters -- Honeywell 3100 Series (Redundancy included)	0.006	138	0.828	9
Thermostats for Survival Heaters -- Honeywell 3100 Series (Redundancy included)	0.006	124	0.744	9
Op Heaters -- Kapton Film 5.5 cm x 6.4 cm (Redundancy included)	0.002	16	0.032	9
Op Heaters -- Kapton Film 20 cm x 20 cm (Redundancy included)	0.0229	96	2.1984	9
Survival Heaters -- Kapton Film 5.5 cm x 6.4 cm (Redundancy included)	0.002	62	0.124	9
Buttons, Velcro and Tape for MLI	0.9	1	0.9	9
Adhesive (STYCAST, Nusil) and Aluminum Tape for Heaters, Thermostats and Thermistors/Platinum RTDs	0.5	1	0.5	9
<b>Total</b>			<b>26.1804</b>	



# Case-2 Mass Estimates and TRL

Instrument Components	Mass Each (kg)	Qty	Mass Total (kg)	TRL
SWIR Detector Radiator (0.09 m <sup>2</sup> ; 0.254 cm aluminum)*	0.618	1	0.618	7
Merged UV/VIS/NIR CCD Detector Radiator (0.019 m <sup>2</sup> ; 0.254 cm aluminum)	0.1302	1	0.1302	7
Electronics Boxes and Mechanisms Radiator (0.294 m <sup>2</sup> ; 0.254 cm aluminum)	2.0212	2	4.0424	7
SWIR Detector Radiator OSR/ITO and Adhesive (0.09 m <sup>2</sup> )*	0.12	1	0.12	9
Merged UV/VIS/NIR CCD Detector Radiator OSR/ITO and Adhesive (0.019 m <sup>2</sup> )	0.0244	1	0.0244	9
Electronics Boxes and Mechanisms Radiator OSR/ITO and Adhesive (0.294 m <sup>2</sup> )	0.3794	2	0.7588	9
SWIR Detector Radiator Sun-Shade (0.164 m <sup>2</sup> ; aluminum)*	0.699	1	0.699	7
Merged UV/VIS/NIR CCD Detector Radiator Sun-Shade (0.0347 m <sup>2</sup> ; aluminum)	0.1478	1	0.1478	7
Electronics Boxes and Mechanisms Radiator Sun-Shade Support Structure (0.851 m <sup>2</sup> ; hogged out 0.254 cm aluminum)	0.8758	2	1.7516	7
Heat Pipe (CCHP) for SWIR Detectors (1.5 m long; 1.27 cm diam.; aluminum; ethane)*	0.3	2	0.6	7
Heat Pipe (CCHP) for Merged UV/VIS/NIR Detector (1.5 m long; 1.27 cm diam.; aluminum; ammonia)	0.3	2	0.6	7
Heat Pipe (CCHP) for Electronics Boxes and Mechanisms (5.25 m long; 1.27 cm diam.; aluminum; ammonia)	1.05	2	2.1	7
Spreader CCHP for Electronics Boxes and Mechanisms Radiator (0.5 m long; 1.27 cm diam.; aluminum; ammonia)	0.1	8	0.8	7
K1100 Heat Strap from SWIR Detector to Cold Finger (7.62 cm long)*	0.066	1	0.066	7
K1100 Heat Strap from Merged UV/VIS/NIR CCD Detector to Cold Finger (7.62 cm long)	0.132	2	0.264	7
Aeroglaze Z307 black paint for Optics Enclosure and Optical Bench (8.9 m <sup>2</sup> )	0.801	1	0.801	9
Aeroglaze Z307 black paint for aperture baffle interior (0.582 m <sup>2</sup> )	0.0524	1	0.0524	9
MLI (15-layers) for Optics Enclosure and Optical Bench (8.9 m <sup>2</sup> )	5.34	1	5.34	9
MLI (15-layers) for aperture baffle (0.582 m <sup>2</sup> )	0.3495	1	0.3495	9
MLI (15-layers) for aperture deployable contamination cover (1.2 m <sup>2</sup> )	0.72	1	0.72	9
MLI (15-layers) on Backside of SWIR Detector Radiator (0.09 m <sup>2</sup> )*	0.054	1	0.054	9
MLI (15-layers) on Backside of Electronics Boxes and Mechanisms Radiator (0.294 m <sup>2</sup> )	0.1764	2	0.3528	9
MLI (15-layers) on SWIR Detector Radiator Sun-Shade (0.164 m <sup>2</sup> )*	0.098	1	0.098	9
MLI (15-layers) on Merged UV/VIS/NIR CCD Detector Radiator Sun-Shade (0.0347 m <sup>2</sup> )	0.0209	1	0.0209	9



# Delta-2 Mass Estimates and TRL

## Integrated Design Capability / Instrument Design Laboratory

Instrument Components	Mass Each (kg)	Qty	Mass Total (kg)	TRL
MLI (15-layers) on Electronics Boxes and Mechanisms Radiator Sun-Shade (0.851 m2)	0.511	2	1.022	9
MLI (15-layers) SWIR ethane heat pipes (0.12 m2)*	0.072	1	0.072	9
MLI (15-layers) for Diffuser Wheel Enclosure (0.435 m2)	0.261	1	0.261	9
MLI (15-layers) for Merged UV/VIS/NIR CCD Detector Housing Exterior (0.085 m2)	0.051	1	0.051	9
MLI (15-layers) for SWIR Detector Housing Exterior (0.132 m2)	0.079	1	0.079	9
MLI (15-layers) for MEB (0.247 m2)	0.148	1	0.148	9
MLI (15-layers) for Merged UV/VIS/NIR Digitizers (0.1088 m2)	0.0653	2	0.1306	9
MLI (15-layers) for SWIR Digitizer (0.0175 m2)*	0.0105	1	0.0105	9
MLI (15-layers) for IMU Sensor (0.461 m2)	0.2768	1	0.2768	9
MLI (15-layers) for IMU Electronics Box (0.218 m2)	0.131	1	0.131	9
MLI (15-layers) for ASC DPU (0.107 m2)	0.064	1	0.064	9
MLI (15-layers) for ASC CHU and Baffles (0.032 m2)	0.019	2	0.038	9
MLI (15-layers) for roll camera (0.658 m2)	0.3948	1	0.3948	9
Thermistors/Platinum RTDs for Telemetry	0.001	32	0.032	9
Thermistors/Platinum RTDs for Heater Control (Redundancy included)	0.001	4	0.004	9
Thermostats for Op Heaters -- Honeywell 3100 Series (Redundancy included)	0.006	138	0.828	9
Thermostats for Survival Heaters -- Honeywell 3100 Series (Redundancy included)	0.006	124	0.744	9
Op Heaters -- Kapton Film 5.5 cm x 6.4 cm (Redundancy included)	0.002	16	0.032	9
Op Heaters -- Kapton Film 20 cm x 20 cm (Redundancy included)	0.0229	96	2.1984	9
Survival Heaters -- Kapton Film 5.5 cm x 6.4 cm (Redundancy included)	0.002	62	0.124	9
SWIR Decontamination Heaters	0.002	2	0.004	9
Buttons, Velcro and Tape for MLI	0.9	1	0.9	9
Adhesive (STYCAST, Nusil) and Aluminum Tape for Heaters, Thermostats and Thermistors/Platinum RTDs	0.5	1	0.5	9
<b>Total</b>			<b>28.5559</b>	



# Case-3 Mass Estimates and TRL

Instrument Components	Mass Each (kg)	Qty	Mass Total (kg)	TRL
Merged UV/VIS/NIR CCD Detector Radiator (0.019 m2; 0.254 cm aluminum)	0.1302	1	0.1302	7
Electronics Boxes and Mechanisms Radiator (0.294 m2; 0.254 cm aluminum)	2.0212	2	4.0424	7
Merged UV/VIS/NIR CCD Detector Radiator OSR/ITO and Adhesive (0.019 m2 )	0.0244	1	0.0244	9
Electronics Boxes and Mechanisms Radiator OSR/ITO and Adhesive (0.294 m2 )	0.3794	2	0.7588	9
Merged UV/VIS/NIR CCD Detector Radiator Sun-Shade (0.0347 m2; aluminum)	0.1478	1	0.1478	7
Electronics Boxes and Mechanisms Radiator Sun-Shade Support Structure (0.851 m2; hogged out 0.254 cm aluminum)	0.8758	2	1.7516	7
Heat Pipe (CCHP) for Merged UV/VIS/NIR Detector (1.5 m long; 1.27 cm diam.; aluminum; ammonia)	0.3	2	0.6	7
Heat Pipe (CCHP) for Electronics Boxes and Mechanisms (5.25 m long; 1.27 cm diam.; aluminum; ammonia)	1.05	2	2.1	7
Spreader CCHP for Electronics Boxes and Mechanisms Radiator (0.5 m long; 1.27 cm diam.; aluminum; ammonia)	0.1	8	0.8	7
K1100 Heat Strap from Merged UV/VIS/NIR CCD Detector to Cold Finger (7.62 cm long)	0.132	2	0.264	7
Aeroglaze Z307 black paint for Optics Enclosure and Optical Bench (8.9 m2)	0.801	1	0.801	9
Aeroglaze Z307 black paint for aperture baffle interior (0.582 m2)	0.0524	1	0.0524	9
MLI (15-layers) for Optics Enclosure and Optical Bench (8.9 m2)	5.34	1	5.34	9
MLI (15-layers) for aperture baffle (0.582 m2)	0.3495	1	0.3495	9
MLI (15-layers) for aperture deployable contamination cover (1.2 m2)	0.72	1	0.72	9
MLI (15-layers) on Backside of Electronics Boxes and Mechanisms Radiator (0.294 m2)	0.1764	2	0.3528	9
MLI (15-layers) on Merged UV/VIS/NIR CCD Detector Radiator Sun-Shade (0.0347 m2)	0.0209	1	0.0209	9
MLI (15-layers) on Electronics Boxes and Mechanisms Radiator Sun-Shade (0.851 m2)	0.511	2	1.022	9
MLI (15-layers) for Diffuser Wheel Enclosure (0.435 m2)	0.261	1	0.261	9
MLI (15-layers) for Merged UV/VIS/NIR CCD Detector Housing Exterior (0.085 m2)	0.051	1	0.051	9
MLI (15-layers) for MEB (0.247 m2)	0.148	1	0.148	9
MLI (15-layers) for Merged UV/VIS/NIR Digitizers (0.1088 m2)	0.0653	2	0.1306	9
MLI (15-layers) for IMU Sensor (0.461 m2)	0.2768	1	0.2768	9
MLI (15-layers) for IMU Electronics Box (0.218 m2)	0.131	1	0.131	9
MLI (15-layers) for ASC DPU (0.107 m2)	0.064	1	0.064	9
MLI (15-layers) for ASC CHU and Baffles (0.032 m2)	0.019	2	0.038	9
MLI (15-layers) for roll camera (0.658 m2)	0.3948	1	0.3948	9
Thermistors/Platinum RTDs for Telemetry	0.001	30	0.03	9
Thermistors/Platinum RTDs for Heater Control (Redundancy included)	0.001	2	0.002	9
Thermostats for Op Heaters -- Honeywell 3100 Series (Redundancy included)	0.006	138	0.828	9
Thermostats for Survival Heaters -- Honeywell 3100 Series (Redundancy included)	0.006	116	0.696	9
Op Heaters -- Kapton Film 5.5 cm x 6.4 cm (Redundancy included)	0.002	8	0.016	9
Op Heaters -- Kapton Film 20 cm x 20 cm (Redundancy included)	0.0229	96	2.1984	9
Survival Heaters -- Kapton Film 5.5 cm x 6.4 cm (Redundancy included)	0.002	58	0.116	9
Buttons, Velcro and Tape for MLI	0.9	1	0.9	9
Adhesive (STYCAST, Nusil) and Aluminum Tape for Heaters, Thermostats and Thermistors/Platinum RTDs	0.5	1	0.5	9
<b>Total</b>			<b>26.0594</b>	

# Mass Comparison

Integrated Design Capability / Instrument Design Laboratory

## Mass in kg

Baseline	Case 1	Case 2	Case 3
28.6489	26.1804	28.5559	26.0594

# Conclusions

## Integrated Design Capability / Instrument Design Laboratory

- **30cm long aperture baffle allows 16 hours of continuous science operation**
  - Z307 black paint has 0.97 absorptance
- **Near 1.0 solar absorptance coating/material may be considered to minimize scattering of sunlight that impinges on aperture baffle interior**
- **Passive cooling meets thermal requirement for detectors**
- **SWIR radiator is required for baseline and Case 2 only**
- **Two radiators, one North and one South, for electronics boxes and mechanisms reduces thermal risk (and possibly mechanical packaging) of accommodating a single large radiator/sunshade on an unknown spacecraft**
- **Baseline and all 3 Derivative cases have same radiator size for electronics boxes and mechanisms**



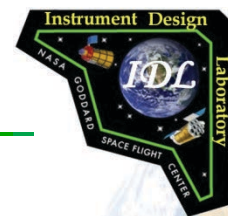

Integrated Design Capability / Instrument Design Laboratory

# GEO CAPE Wide Angle Spectrometer (WAS) ~ *Concept Presentations* ~

## Flight Software

Kequan Luu

July 29, 2014



NASA GODDARD SPACE FLIGHT CENTER

# Agenda

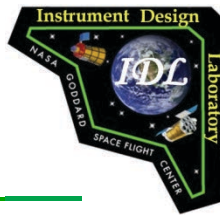

---

## Integrated Design Capability / Instrument Design Laboratory

- Electrical Block Diagrams
- Flight Software Requirements
- Conceptual Architecture
- LOC Estimate for SEER Input
- Summary
- Back up charts (estimates, testing, etc.)



# Electrical Block Diagram

as documented in the electrical presentation



Integrated Design Capability / Instrument Design Laboratory

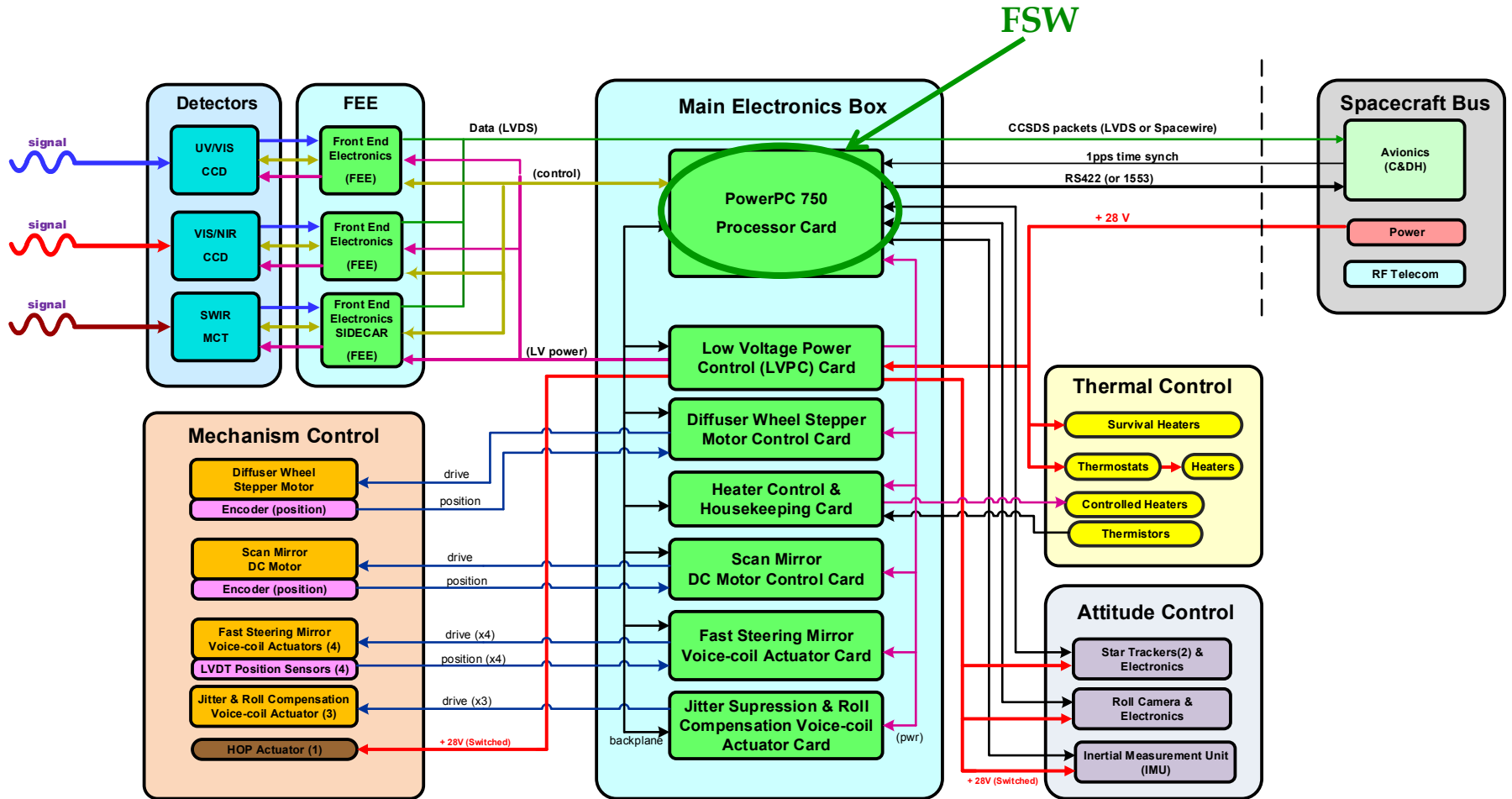

# Mode of Operations

*as documented in the systems presentation*

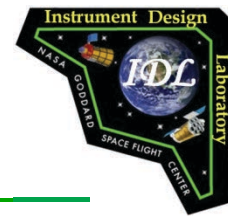

## Integrated Design Capability / Instrument Design Laboratory

Mode	Function	Frequency	Duration	Mechanism Configuration		
				Diffuser Wheel Mechanism	Scan Mirror Mechanism	FSM
Launch				Closed, Off & Launch Locked	Off & Launch Locked	Off
Standby	Health & Safety, FSW upload, Diagnostic, overnight	Daily	~7 Hours/day	Closed; off	Off	On but not moving
Science	Survey & Targeted	Daily	16 Hours/day	Clear	Move & Stare	On
Cal - Moon	Lunar radiometric cal	When available, 3 to 5/Month	5 min	Clear	Move & Stare	On
Cal - Sun	Solar radiometric cal	When available, Daily - Weekly	5 min	Solar Diffuser or Rare Earth Doped	Move & Stare	On
Cal - Star Tracker	Calibrate instrument LOS wrt attitude hardware	Once per hour	Continuously	Solar Diffuser or Rare Earth Doped	Move & Stare	On
Cal - Dark	Measure detector dark noise and bias	2 x Daily	5 min	Closed	N/A	N/A



# Top-Level Pointing System Diagram

Integrated Design Capability / Instrument Design Laboratory

**Knowledge**

**Control**

**Jitter & Compensation**

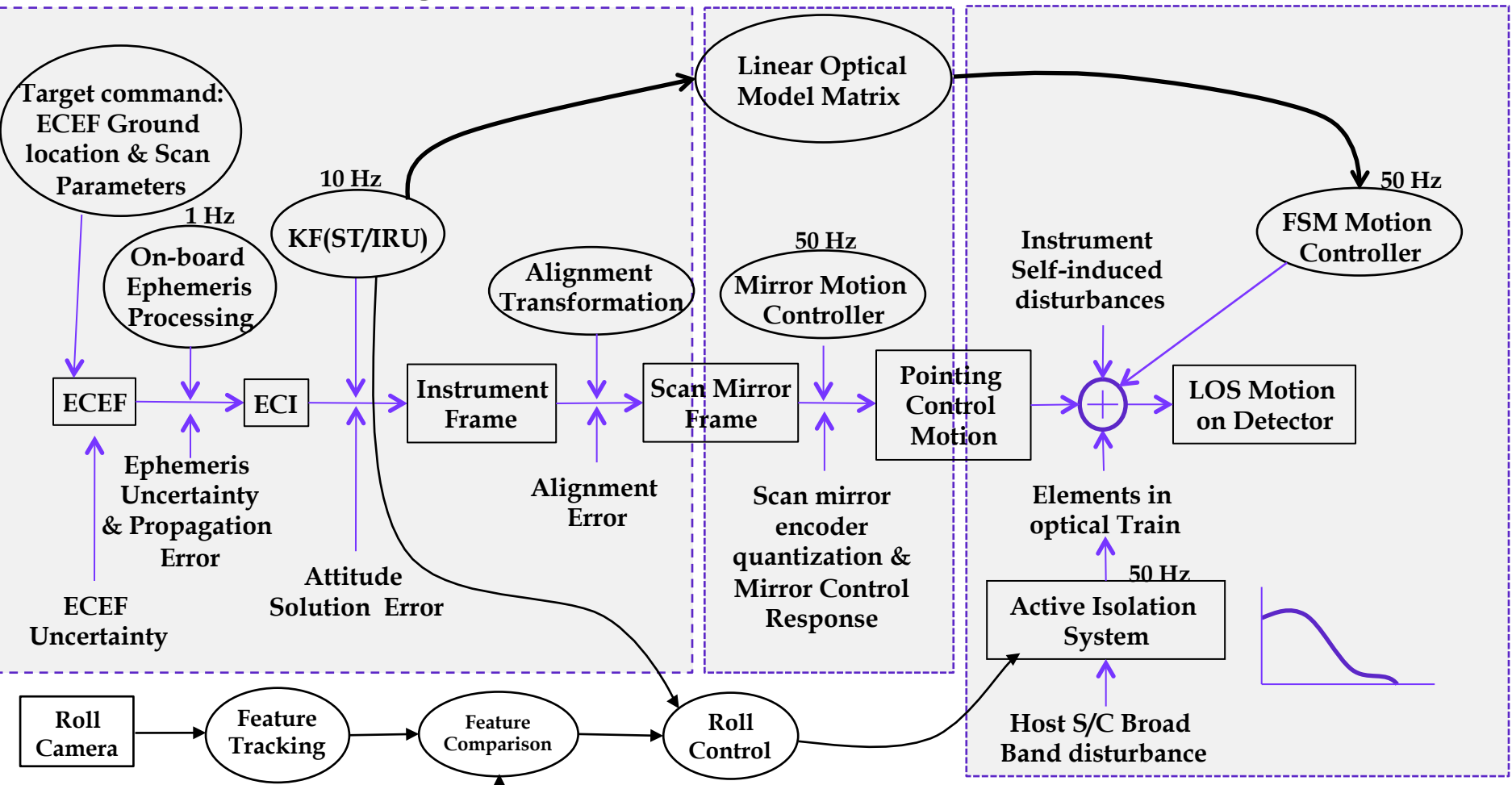

# Flight Software Requirements



## Integrated Design Capability / Instrument Design Laboratory

- Mode management
  - Launch, Standby/Engineering, Calibration, Science, etc.
- Instrument Support
  - Command processing (ST, IMU, Target, etc.)
  - Setup/Control digitizer board (i.e. detectors readout, programmable integration period)
  - SIDE CAR Code image storage & management of image download to SIDE CAR
  - SIDE CAR FSW Management (e.g. memory dump/load/table updates, etc.)
- Instrument pointing
  - Sensors data processing (ST, IMU, etc.)
  - Roll camera image processing/feature tracking
  - s/c ephemeris propagation
  - AD + Kalman Filter
- Mechanisms control/commanding
  - Scan Mirror @50Hz
  - Fast Steering Mirror @50Hz
  - Diffuser (commanded, 4 positions 90 degree)
  - Active Isolation System @50Hz
- PID thermal controllers for the detectors (4x) @1Hz, +/- 0.1k stability
- Time Management - maintain time synch with spacecraft to sub second accuracy
- Collect and CCSDS packetization of HK data including time stamping
- Autonomy (e.g. operations, FDC)
  - Limit Checker (safing, power & thermal monitoring, etc.)
  - Store Command Processor
- Software Management (e.g. memory dump/load, software/table updates, etc.)
- Interfaces
  - 1PPS and time message from Spacecraft
  - 1553/RS422 cmd/data I/F to Spacecraft
  - SpaceWire science data I/F to Spacecraft
  - RS422 to ACS sensors (ST, IMU, Roll camera)
  - Store and forward S/C provided attitude data
- Science data processing/reduction/compression done by hardware/FPGA
- Derived
  - VxWork RTOS
  - Bootstrap
  - Health & Safety



# Flight SW Architecture

Integrated Design Capability / Instrument Design Laboratory

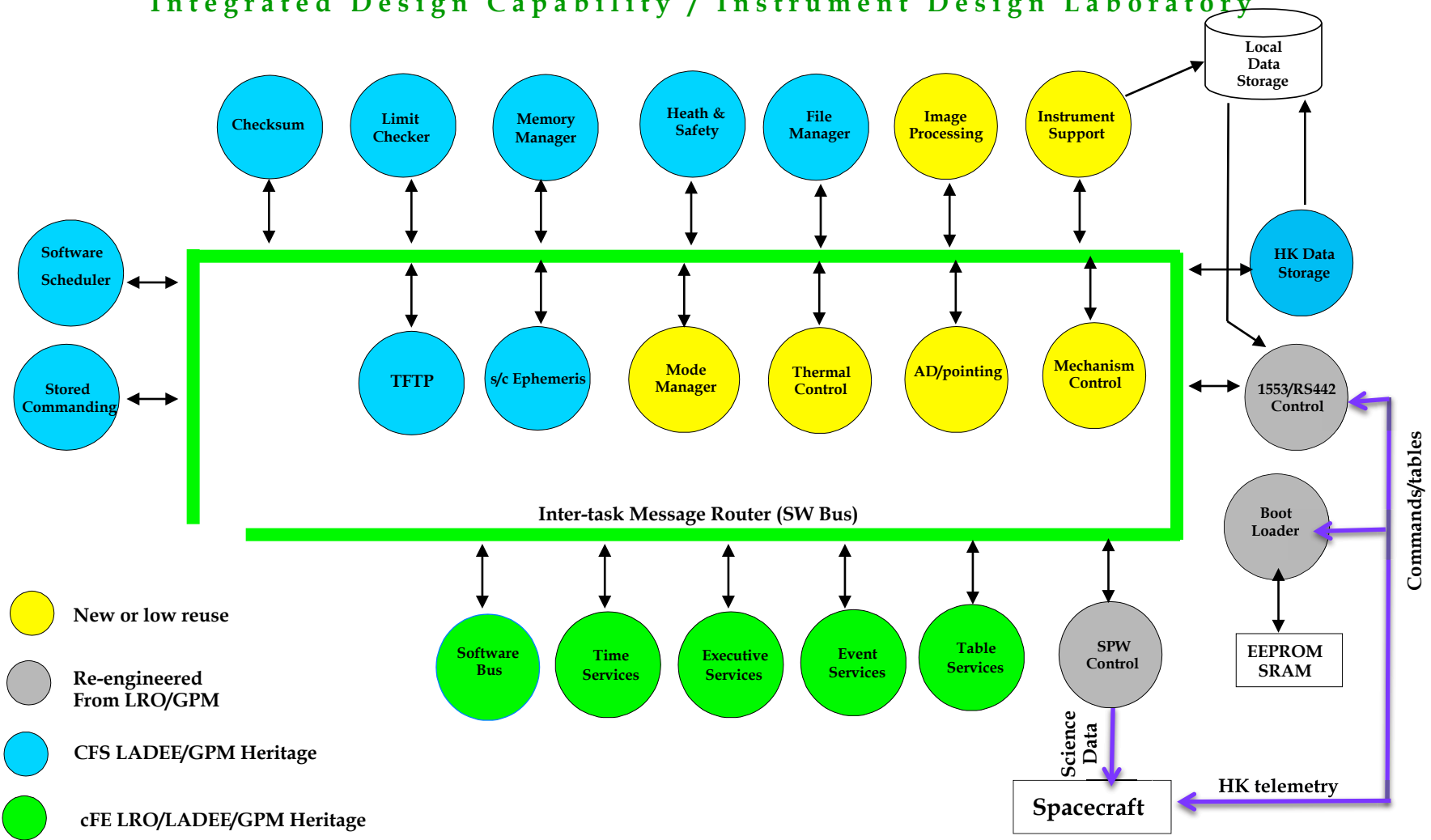

# Processor Utilization Estimates

Integrated Design Capability / Instrument Design Laboratory

Component	CPU Percentages		Basis of Estimate	BAE750(%) Base Value	12Mhz ST5/SD	60Mhz LRO
	50 Mhz	32 Mhz			0.75	3.75
cFE	0.12	0.19	LRO B2.5 Measured	0.05		0.19
HK Data Storage	0.12	0.19	LRO B2.5 Measured	0.05		0.19
Memory Manager	0.01	0.02	LRO B2.5 Measured	0.01		0.02
Health & Safety	0.17	0.26	LRO B2.5 Measured	0.07		0.26
Stored Commands	0.10	0.15	LRO B2.5 Measured	0.04		0.15
Limit Checker	0.10	0.15	LRO B2.5 Measured	0.04		0.15
Scheduler	1.46	2.29	LRO B2.5 Measured	0.61		2.29
Checksum	0.48	0.75	LRO B2.5 Measured	0.20		0.75
File Manager	0.02	0.04	LRO B2.5 Measured	0.01		0.04
Mode Manager	0.02	0.04	Estimate	0.01		0.04
1553/RS422 Control	4.80	7.50	Estimate	2.00		7.50
SpaceWire Control	6.00	9.38	Estimate	2.50		9.38
Instrument Support	4.80	7.50	Estimate	2.00		7.50
TFTP	2.40	3.75	Estimate	1.00		3.75
Image Data Processing	76.80	120.00	Estimate	32.00		120.00
ACS Orbit Models	4.80	7.50	Estimate	0.50		7.50
AD/Pointing	115.20	180.00	Estimate	12.00		180.00
Mechanisms Control	144.00	225.00	Estimate	15.00		225.00
Thermal Control	7.20	11.25	Estimate	0.75		11.25
<b>Subtotal</b>	<b>368.60</b>	<b>575.94</b>		<b>68.83</b>		

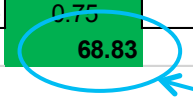

~31% Margin



# Onboard Data Processing Assessment (Hazardous Site Identification)

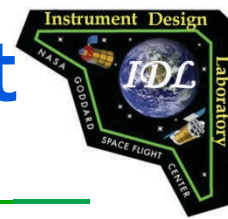

Integrated Design Capability / Instrument Design Laboratory

	<b>MIPS</b>	<b>Time required (seconds)</b>
<b>Quad-Core AMD Opteron(tm) Processor 8356</b>	<b>10,500</b>	<b>309</b>
<b>RAD750</b>	<b>240</b>	<b>13,518</b>
<b>GSFC SpaceCube 2.0</b>	<b>5,000</b>	<b>648</b>

**Note – assuming the hazard site processing only occur when CPU cycles are available, it will take the RAD750  $13,518/0.3 = 45,060$  seconds = 12.5 hours to process one scene**



# FSW Development Testbeds

Integrated Design Capability / Instrument Design Laboratory

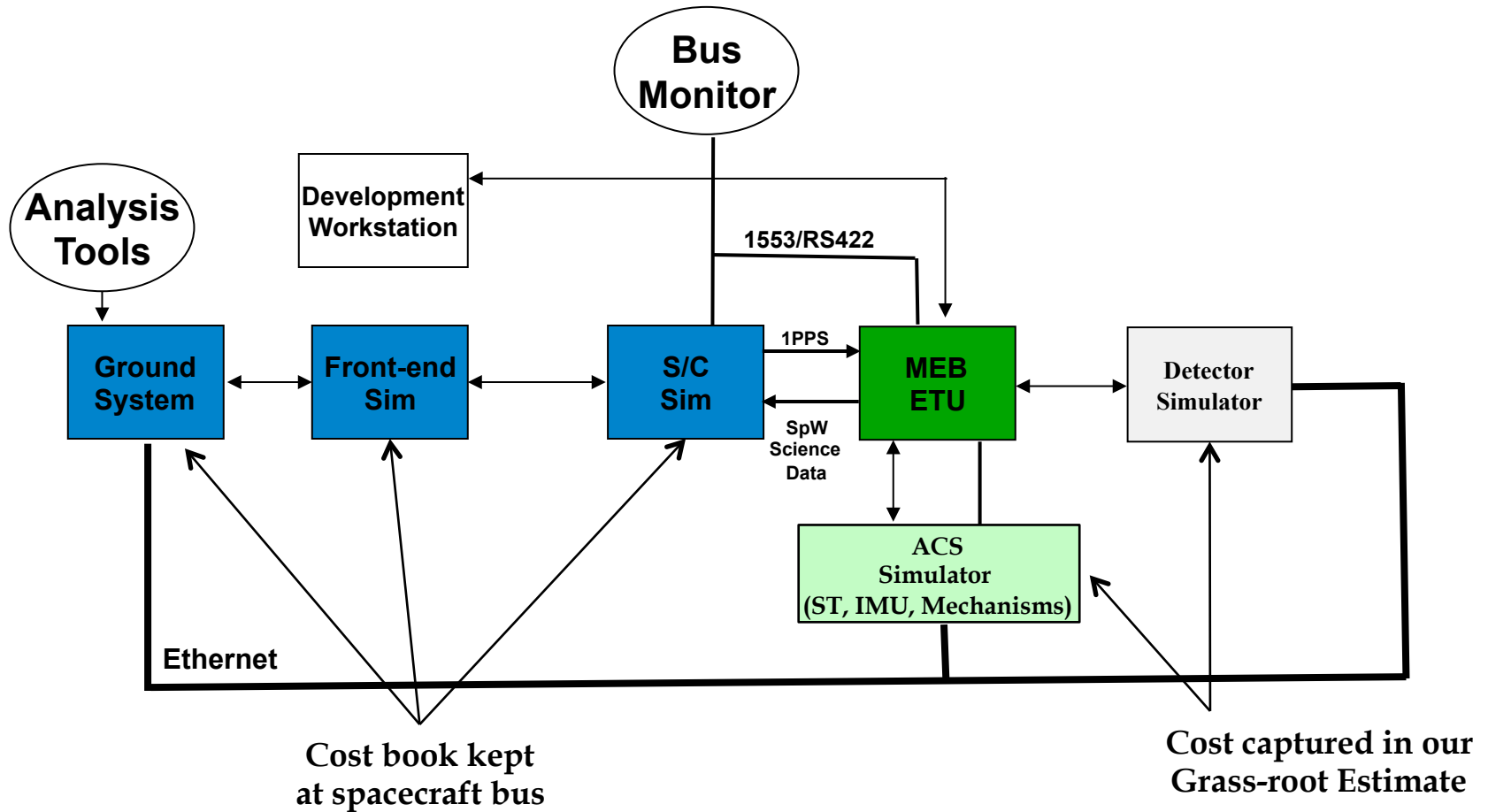

# Basis of Cost Estimate



## Integrated Design Capability / Instrument Design Laboratory

- **FSW development costs estimated using SEER: System Evaluation & Estimation of Resources**
  - Separate modules for Hardware, Software, Integrated Circuits, Manufacturability and Life Cycle
  - NASA-wide site license for SEER managed by Langley Research Center
  - The IDL made in-house assumptions for FSW re-use and labor efforts; the IDL cannot confidently make assumptions about unknown vendor reuse libraries or control measures, or labor efforts or experience, so we apply GSFC reuse and labor assumptions
- **Grassroots test bed costs**
  - FSW test bed simulator software development 3 FTE
  - FSW development tools and test bed GSE \$251k
    - \$6k for 3 pc
    - \$15k for 1553/RS422 bus monitor
    - \$180k custom simulator hardware
    - \$50k for software development tools and VxWorks
    - **The SpW bus monitor/test set is quite expensive and is not needed most of the time, assumed one is available to share with other GSFC projects**



# SLOC Estimate

Module Name  (Hierarchical/Indented list as appropriate)	Environment  (Flight, Ground)	SW type  (Control, Data mining, Database, Web, etc.)	Approach  (New, Reuse, Rehost, Maintenance, COTS I&T, etc.)	Development Method	Software Lines of Code (Logical)				% Retest needed on Reuse code
					Total	New	Reuse		
							Total Reuse SLOC	% Re-engin.	
*** OS API & OSAL	Flight	OS/Executive	Modification, Minor	Waterfall	2338	200	2138	20%	80
*** Boot Loader	Flight	Flight System	Modification, Minor	Waterfall	1868	100	1768	20%	100
*** BSP	Flight	Flight System	Reengineering, Major	Waterfall	1492	300	1192	20%	80
*** Executive Services	Flight	OS/Executive	Integrate /w config	OTS integration	4737	0	4737	10%	10
*** Event Service	Flight	Flight System	Integrate /w config	OTS integration	1429	0	1429	10%	10
File System	Flight	Flight System	Integrate /w config	OTS integration	763	0	763	10%	10
*** Mission Config Include Files	Flight	Flight System	Reengineering, Major	OTS integration	1857	1200	657	80%	100
*** Software Bus	Flight	Flight System	Integrate /w config	OTS integration	2017	0	2017	10%	10
*** Table Service	Flight	Flight System	Integrate /w config	OTS integration	2182	0	2182	10%	10
*** Time Service	Flight	Flight System	Integrate /w config	OTS integration	1941	0	1941	10%	10
*** cFE Configuration (hdr files)	Flight	Flight System	Integrate /w config	OTS integration	226	0	226	10%	10
*** cFE platform Support Pkg	Flight	Flight System	Reengineering, Major	Waterfall	827	200	627	50%	100
CFS Library	Flight	Flight System	Integrate /w config	OTS integration	166	0	166	0%	0
Checksum	Flight	Flight System	Integrate /w config	OTS integration	2811	0	2811	10%	10
File Manager	Flight	Flight System	Integrate /w config	OTS integration	1664	0	1664	10%	10
File Commanding	Flight	Flight System	Integrate /w config	OTS integration	447	0	447	10%	10
Health & Safety	Flight	Flight System	Integrate /w config	OTS integration	1433	0	1433	10%	10
Memory Manager	Flight	Flight System	Integrate /w config	OTS integration	1927	0	1927	10%	10
Scheduler	Flight	Flight System	Integrate /w config	OTS integration	1067	0	1067	10%	10
Limit Checker	Flight	Flight System	Integrate /w config	OTS integration	1742	0	1742	0%	10
Limit Checker Configuratoin	Flight	Flight System	Modification, Major	Waterfall	300	200	100	40%	100
Store Command Processor	Flight	Flight System	Integrate /w config	OTS integration	1625	0	1625	10%	10
Housekeeping	Flight	Flight System	Reengineering, Major	Waterfall	554	300	254	80%	50
Command Ingest	Flight	Flight System	Modification, Major	Waterfall	1721	400	1321	20%	60
Telemetry Output	Flight	Flight System	Modification, Major	Waterfall	3067	800	1767	30%	60
TFTP	Flight	Flight System	Modification, Major	Spiral	1678	100	1578	30%	80
Instrument Support	Flight	Flight System	Reengineering, Major	Waterfall	1800	1500	300	80%	80
Mechanism Control	Flight	Flight System	Modification, Major	Waterfall	3000	2000	1000	90%	100
Image Processing	Flight	Flight System	Modification, Major	Waterfall	2000	1800	200	90%	100
Ephem	Flight	Flight System	Integrate /w config	OTS integration	155	0	155	0%	10
AD/Pointing	Flight	Flight System	Modification, Major	Waterfall	3000	1000	2000	80%	100
Thermal Control	Flight	Flight System	Modification, Minor	Waterfall	300	100	200	30%	60
Mode Manager	Flight	Flight System	Reengineering, Major	Waterfall	800	400	400	60%	80
C&DH Library	Flight	Flight System	Integrate /w config	OTS integration	4267	0	4267	0%	10
Math Library	Flight	Flight System	Integrate /w config	OTS integration	1123	0	1123	0%	10
GNC Application Framework	Flight	Flight System	Integrate /w config	OTS integration	1041	0	1041	0%	10
FSW Tables (ex: SC & filter Tables)	Flight	Flight System	New	Waterfall	2500	2000	500	100%	100
*** Bus Control	Flight	Flight System	Modification, Minor	Spiral	3947	500	2447	50%	100
Total SLOC					64312	13100	51212	80% Reuse	





# FSW Configurations

## Integrated Design Capability / Instrument Design Laboratory

- **Case 1 - no SWIR**

- Reduce thermal PID controllers from 4 to 2, saving is small because the code will still have to be there. We just don't run them as much, so CPU margin will improve and there is small saving in testing
- Remove SIDECAR microcode and the FSW required to maintain it. ~300 SLOC can be removed from the instrument support module

- **Case 2 - Merge UV/Vis/NIR**

- Reduce thermal PID controllers from 4 to 3, saving is small because the code will still have to be there. We just don't run them as much, so CPU margin will improve and there is small saving in testing

- **Case 3 - no SWIR, merge UV/Vis/NIR**

- Reduce thermal PID controllers from 4 to 1, saving is small because the code will still have to be there. We just don't run them as much, so CPU margin will improve and there is small saving in testing
- Remove SIDECAR microcode and the FSW required to maintain it. ~300 SLOC can be removed from the instrument support module



# Summary and Recommendations



## Integrated Design Capability / Instrument Design Laboratory

- Lines Of Code estimation shows ~80% code reuse for MEB
  - High heritage based on GSFC CFS approach
  - An implementation at another Center or at an experienced Vendor should also take advantage of reuse algorithms, but the specific ratio should be evaluated
  - No technical show-stoppers
- Significant flight computational resources are needed If additional science data processing/reduction is to be implemented onboard (i.e. hazardous site identification). Flight computing options:
  - Spacecube 2.0: GSFC developed, older version demonstrated on ISS
  - Maestro: maximum 7x7 = 49 cores; the team is working on a 4x4 flight version
  - Xilinx Virtex 7: capable of hosting many ARM processor cores. 587 is working to get a prototype board
  - BAE RAD5545 Quad Core
  - NASA/DoD recently put out a RFP for high performance computing technology development
  - Recommendation: benchmark the Image Data Processing and the Hazard Site Identification algorithms on a RAD750 and on a Spacecube 2.0



# 582/587 Technology Road Map

Integrated Design Capability / Instrument Design Laboratory

## Next Generation Space Systems

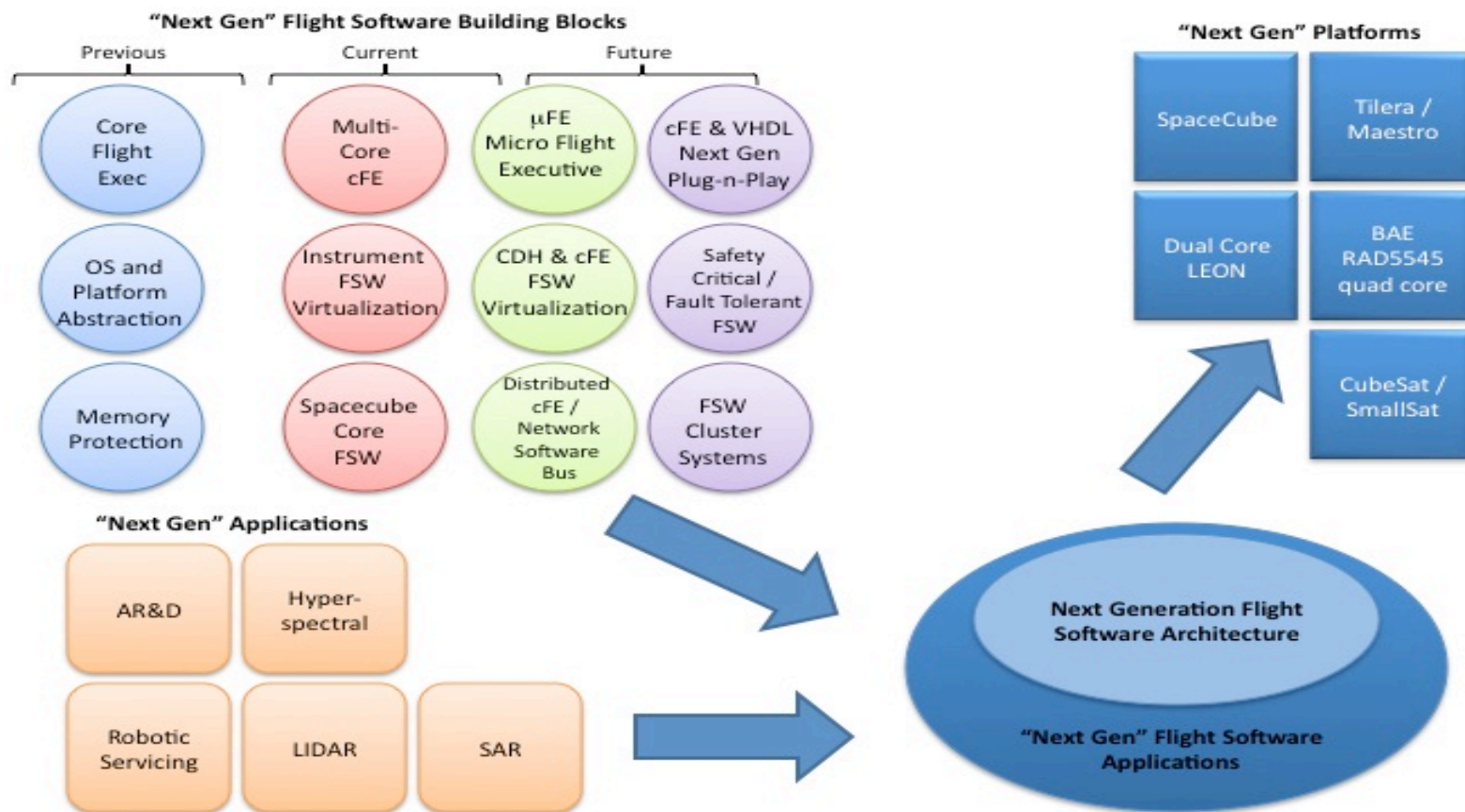

# SpaceCube 2.0 Use Cases

Integrated Design Capability / Instrument Design Laboratory

## On-Board Processing

- Data Volume Reduction
- Image Processing
- Autonomous Operations
- Product Generation
- Event / Feature Detection
- Real-time / Direct Broadcast
- Docking / Servicing
- Compression
- Calibration / Correction
- Classification
- Inter-platform collaboration

## Hybrid Science Data Processing

- CPU
- FPGA
- DSP

## GSFC SpaceCube On-Board Processor

- 10x-100x computing performance
- Lower power (MIPS/watt)
- Lower cost (commercial parts)
- Radiation tolerant (not hardened)
- Software upset mitigation

*Lower FSW heritage than RAD750 base*





# Processor Comparison

Integrated Design Capability / Instrument Design Laboratory

	MIPS	Power	MIPS/W
MIL-STD-1750A	3	15W	0.2
RAD6000	35	10-20W	2.33 <sub>1</sub>
RAD750	300	10-20W	20 <sub>2</sub>
SPARC V8	86	1W <sub>3</sub>	86 <sub>3</sub>
LEON 3FT	60	3-5W <sub>3</sub>	15 <sub>3</sub>
GSFC SpaceCube 1.0	3000	5-15W	400 <sub>4</sub>
GSFC SpaceCube 2.0	5000	10-20W	500 <sub>5</sub>

**Notes:**

- 1 – typical, 35 MIPS at 15 watts
- 2 – typical, 300 MIPS at 15 watts
- 3 – processor device only ... total board power TBD
- 4 – 3000 MIPS at 7.5 watts (measured)
- 5 – 5000 MIPS at 10 watts (calculated)





# Current SpaceCube Systems

SpaceCube 1.0a

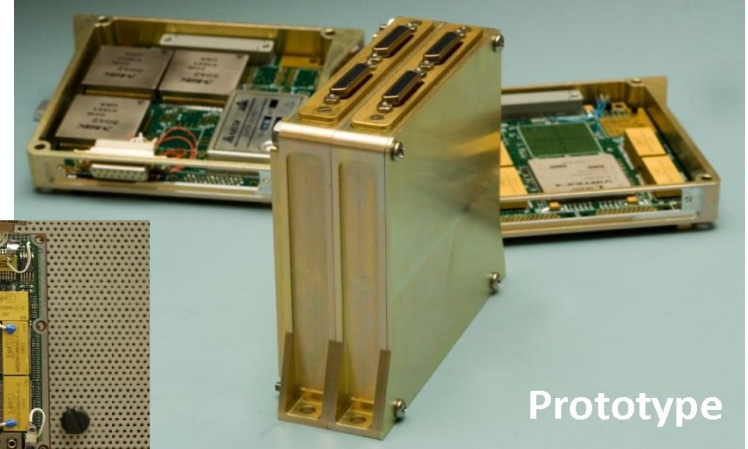
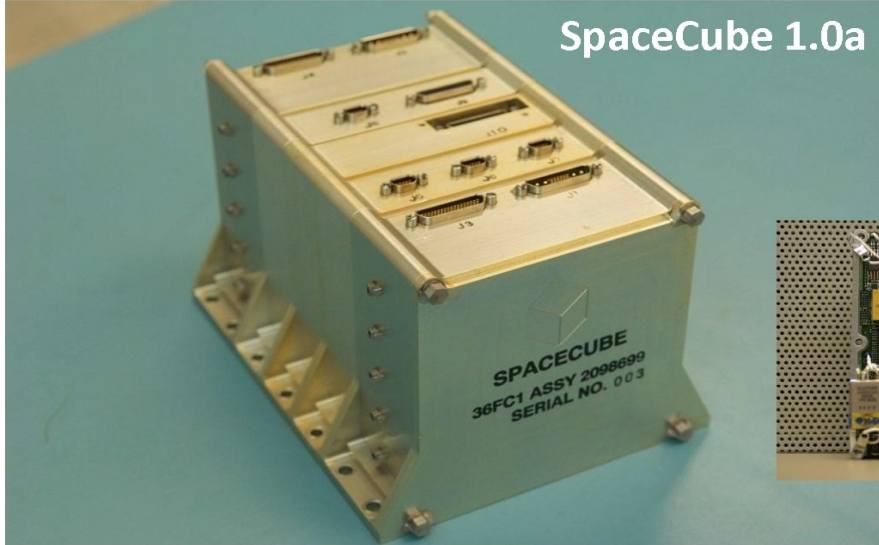

Prototype

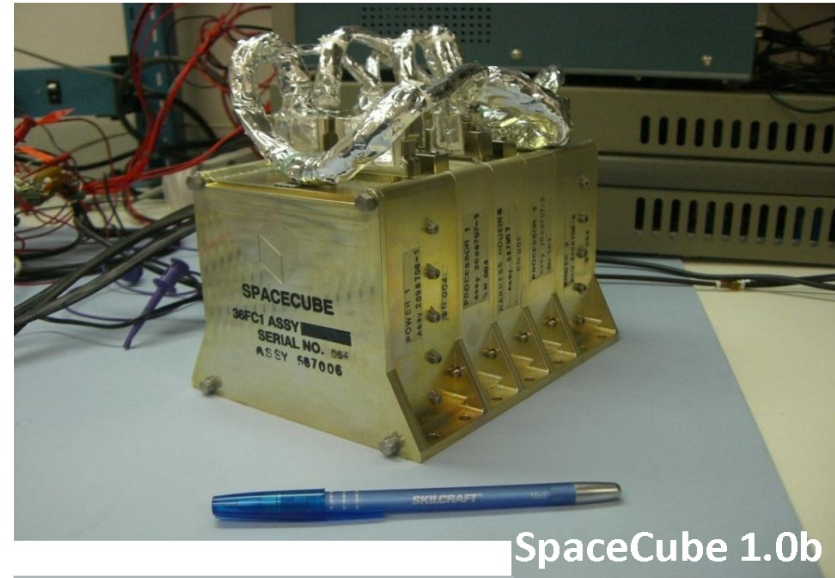

SpaceCube 1.0b



# SpaceCube Family Overview

Integrated Design Capability / Instrument Design Laboratory

Unit	Mission	Notes	Specs	Stats	Status
SpaceCube 1.0a	Hubble Servicing Mission 4	Relative Navigation Sensors Experiment STS-125 May 2009	4"x4" card (2) Virtex4	Size: 5"x5"x7" Wt: 7.5 lbs Pwr: 37W	2009 Flight
SpaceCube 1.0b	MISSE-7 (ISS)	added RS-485, RHBS, STS-129 Nov 2009	4"x4" card (2) Virtex4	Size: 5"x5"x7" Wt: 7.5 lbs Pwr: 32W	In Flight
SpaceCube 1.0c	DEXTRE Pointing Package (ISS)	Original RNS unit, w/added 1553 & Ethernet	4"x4" card (2) Virtex4	Size: 5"x5"x7" Wt: 7.5 lbs Pwr: 40W	Final stages of Implementation
SpaceCube 1.5	SMART (DoD/ORS)	adds GigE & SATA, commercial parts, sounding rocket flight	4"x4" card (1) Virtex5	Size: 5"x5"x4" Wt: 4 lbs Pwr: < 20W	
SpaceCube 2.0	Earth/Space Science Exploration missions	Std 3U form factor, GigE, SATA, Spacewire, cPCI	4"x6" card (2) Virtex5 (1) SIRF	Size: 5"x5"x7" Wt: < 10 lbs Pwr: 20-40W	Under Development
SpaceCube 2.0 Mini	CubeSats, Sounding Rocket, UAV	"Mini" version of SpaceCube 2.0, CubeSat form factor	2.5"x2.5" card (1) Virtex5/SIRF	Size: 3.5"x3.5"x3.5" Wt: 3 lbs Pwr: <10W	



# HyspiRI Demonstrator Testbed

## HyspiRI SpaceCube IPM Testbed

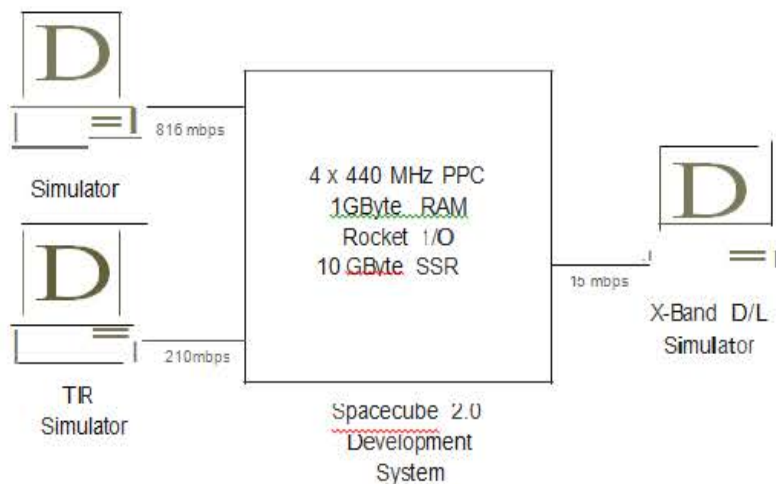

## Cloud Classifier

# SpaceCube 2.0 Processor Card

Integrated Design Capability / Instrument Design Laboratory

3U Compact PCI Card

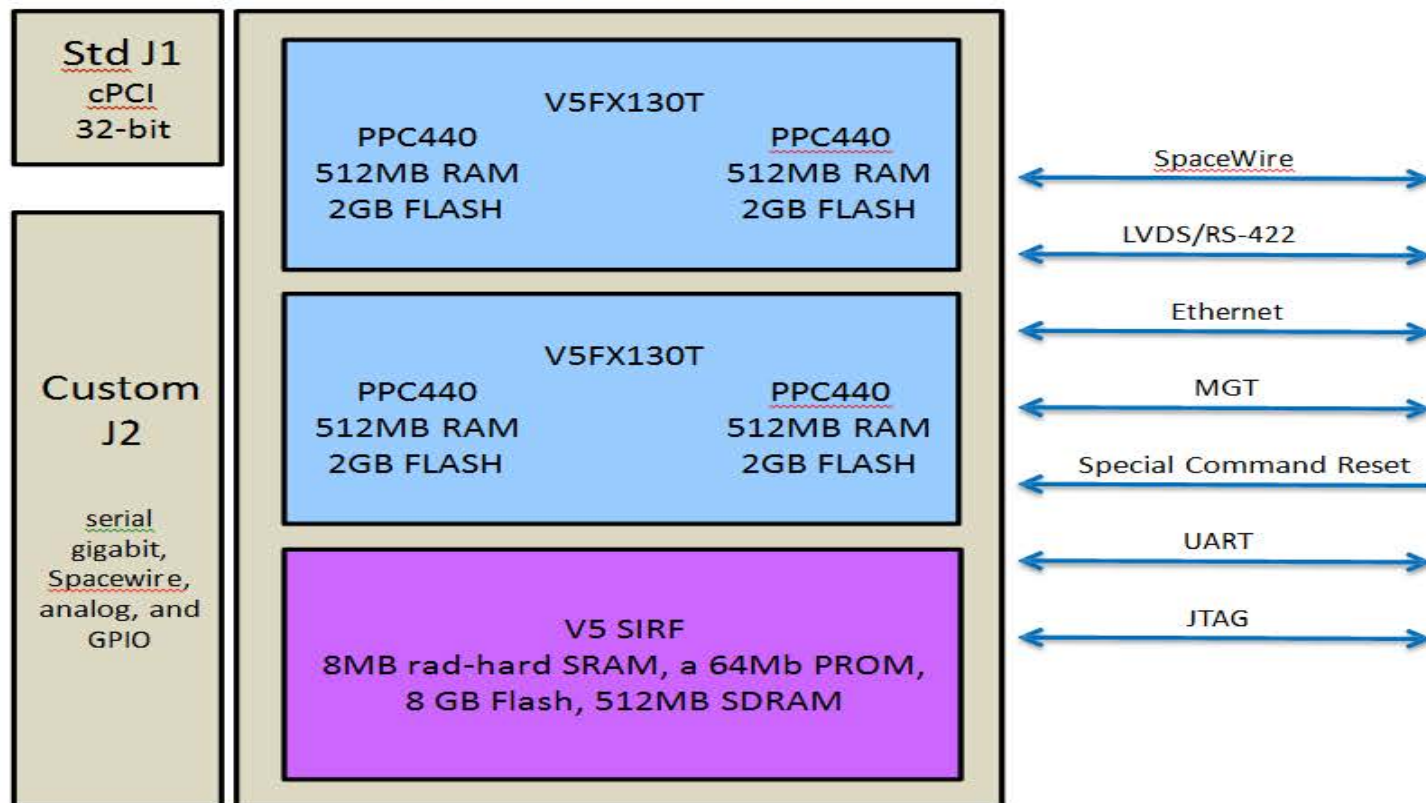

System	EDU	FLT	Notes
1.0	\$500K	\$850K	RNS configuration
1.5	\$200K	N/A	All commercial parts
2.0	\$640K	\$1.1M	
Mini	\$300K	\$600K	Best guest for now

# SpaceCube 2.0

## Data & Processing Flow Diagram



Integrated Design Capability / Instrument Design Laboratory

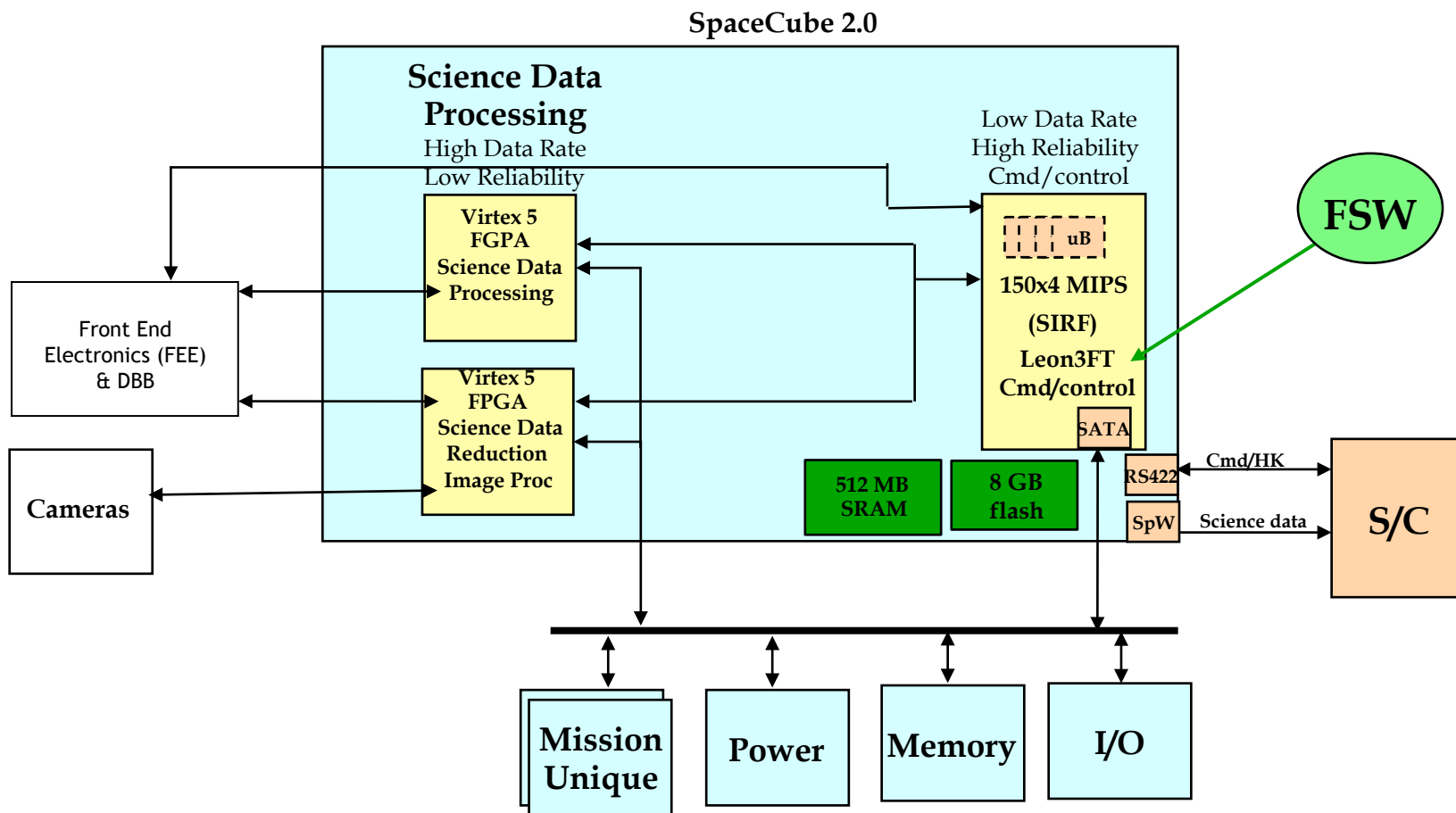



# Backup Slides

---

Integrated Design Capability / Instrument Design Laboratory

- Development Approach
- Management Approach
- Verification & Validation



# FSW Development Approach

## Integrated Design Capability / Instrument Design Laboratory

- **Reuse LRO/GPM C&DH FSW (Med to high heritage, low risk - LRO launched 2009, GPM launch 2014)**
  - LRO/GPM FSW Features (based on 582's Core Flight Executive)
    - Developed using FSW best practices consistent w/NPR 7150.2
    - Onboard file systems and associated file transfer mechanisms
    - Onboard networks with standard interfaces
    - Standard application interfaces (API) for ease of development and rapid prototyping
    - Dynamic application loading, middleware (SB) provide dynamic cmd/tlm registration
    - POSIX APIs and open source Integrated Development Environment
  - Benefits
    - Will enable parallel collaborative development and system interoperability
    - Will automate many previously manual development activities
    - Will simplify technology infusion and system evolution during development and on-orbit
    - Will enable rapid deployment of low cost, high quality mission software
- **Reengineer LRO/GPM FSW for all mission specific components**
  - Mission-specific ops concept support, thermal electronics, etc.



# Management Approach



## Integrated Design Capability / Instrument Design Laboratory

- **Product Development Process Will Comply with NPR 7150.2 (NASA Software Engineering Requirements and GOLD Rule)**
- **Development**
  - Product Development Plan per 582 branch standards, approved by Branch & Project
  - Detailed FSW development schedule integrated with project & subsystems schedules
  - Requirements management using MKS tool
  - Monthly PSR with AETD & project; branch status reviews
  - Weekly system engineering meetings, FSW team meetings
  - FSW Design & Code reviews
  - Major milestones (SCR, PDR, CDR, etc)
- **Configuration Management**
  - FSW CM Plan per 582 branch standards, approve by Branch & Project
  - Commercial CM tool (i.e., MKS) to manage source codes and document
  - Proposed FSW changes affecting missions requirements, cost and/or schedule will be forwarded to Project level CCB
- **Test Plan**
  - FSW Test Plan per 582 branch standards, approve by Branch & Project



# FSW Verification and Validation

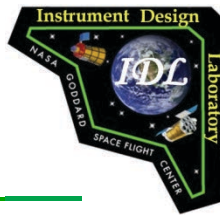

## Integrated Design Capability / Instrument Design Laboratory

- **Unit Test**

- Done by developers using PC tools
- Follow Branch 582 Unit Level Test Standard - Tailored
- Includes Path testing, Input/Output testing, Boundary testing, and Error Reporting verification
- Occasionally BB H/W is required to verify H/W I/F

- **Build Integration Test**

- Done by developers to verify that the FSW performs properly on the BB H/W in the FSW testbeds using embedded system tools
- First level functionality ensured for integrated software
- Build Test Team to assist in GSE I/F checkout

- **Build Verification Test**

- Done by independent test team with Science Team support on the BB H/W in the FSW testbeds using embedded system tools
- Test each requirement in the Flight Software Requirements documents (where possible at the build level)
- Use test scenarios to test requirements in both a positive and negative fashion.
- Scenarios constructed to combine requirements that are logically connected to create a test flow.
- Automation to be utilized as much as possible
- Requirements Traceability Matrix maintained



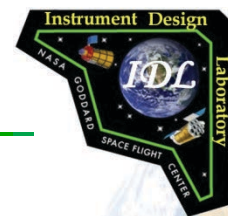

---

Integrated Design Capability / Instrument Design Laboratory

# GEO CAPE Wide Angle Spectrometer (WAS) ~ *Concept Presentations* ~

## Pointing and Jitter

Eric Stoneking

July 29, 2014

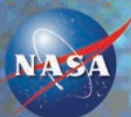

---

N A S A   G O D D A R D   S P A C E   F L I G H T   C E N T E R

# Sample Host Disturbance Spectra

Integrated Design Capability / Instrument Design Laboratory

- Sample spectra shown as RMS amplitude
- Blue trace is derived from a strawman 160-arcsec RMS specification
- Other traces are derived from GOES-13 on-orbit data

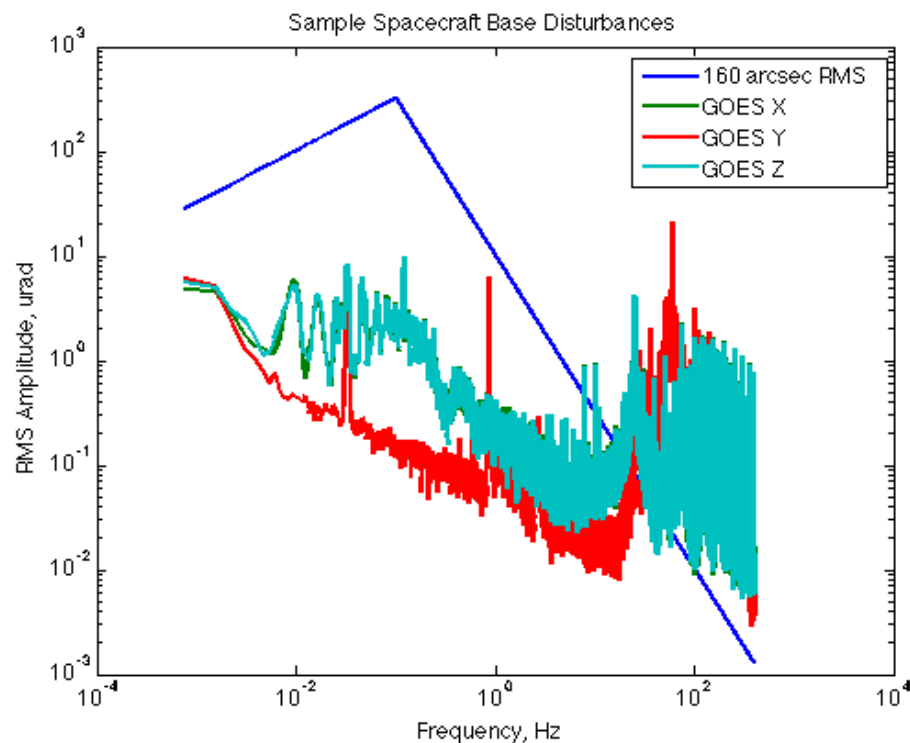

# Disturbance Rejection Apportioned by Frequency

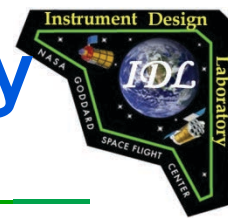

Integrated Design Capability / Instrument Design Laboratory

- Spacecraft attitude control rejects **low-frequency** disturbances (0.1 Hz and below)
- Jitter suppression system on instrument mount rejects **high-frequency** disturbances (1.5 Hz and above)
  - Active elements, plus passive rolloff due to inertia
- Active “fast steering loop” rejects **mid-frequency** disturbances (0.1 to 17 Hz)
  - Overlap for better suppression
  - Needs IMU sampled at ~100 Hz
  - Actuation by either:
    - A fast steering mirror (baseline), or
    - By steering the scanning mirror, or
    - Active portion of the jitter suppression system

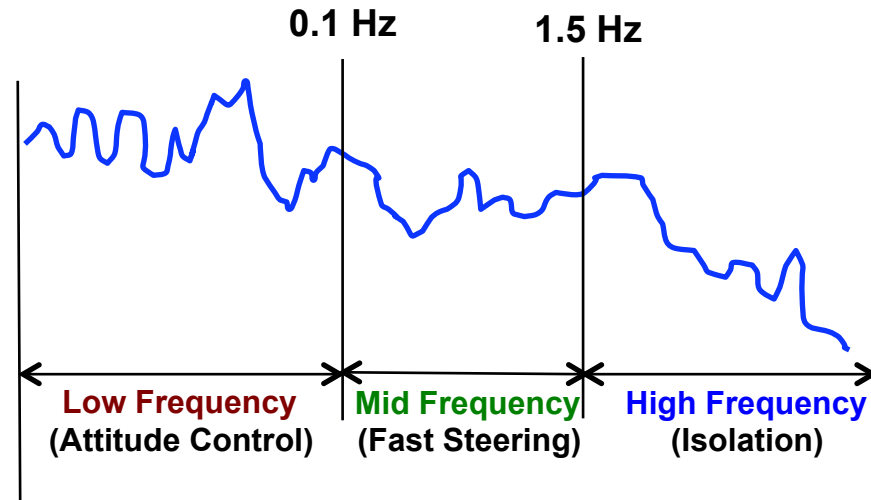

# IMU Sample Rate

---

## Integrated Design Capability / Instrument Design Laboratory

- **We assume the Astrix 200 has a sample rate of at least 100 Hz, to support a fast steering loop with a 17 Hz bandwidth**
  - 17 Hz bandwidth found as a result of analysis presented in GEO-CAPE FR study presentation
- **Available documentation for the Astrix 200 does not quote a sample rate**
  - Online factsheet implies, but does not state outright
- **To judge whether 100 Hz is a reasonable assumption, and to provide fallback positions, we note the following IMUs and their sample rates:**
  - Northrup Grumman SSIRU: 25 Hz (on Fermi)
  - LN200S: Up to 400 Hz
  - Honeywell IFOG: Up to 200 Hz
  - Honeywell MIMU: Up to 200 Hz
- **Conclusion: It is reasonable to assume that the Astrix 200 can support at least a 100-Hz sample rate**
  - If it turns out not to be the case, alternative gyros are available

# Pointing Component Assumptions



Integrated Design Capability / Instrument Design Laboratory

- **DTU MicroASC Star Tracker**
  - Two optical heads required for accuracy
    - Reliability is sufficient so no redundancy is required
  - Offset in pointing North and South to view clear sky
  - Nominally orthogonal to each other
- **Astrix 200 IMU**
  - Same IMU assumed for COEDI study
  - Sample rate is assumed to be at least 100 Hz
    - No sample rate is given in available documentation



# Roll Measurement Block Diagram

Integrated Design Capability / Instrument Design Laboratory

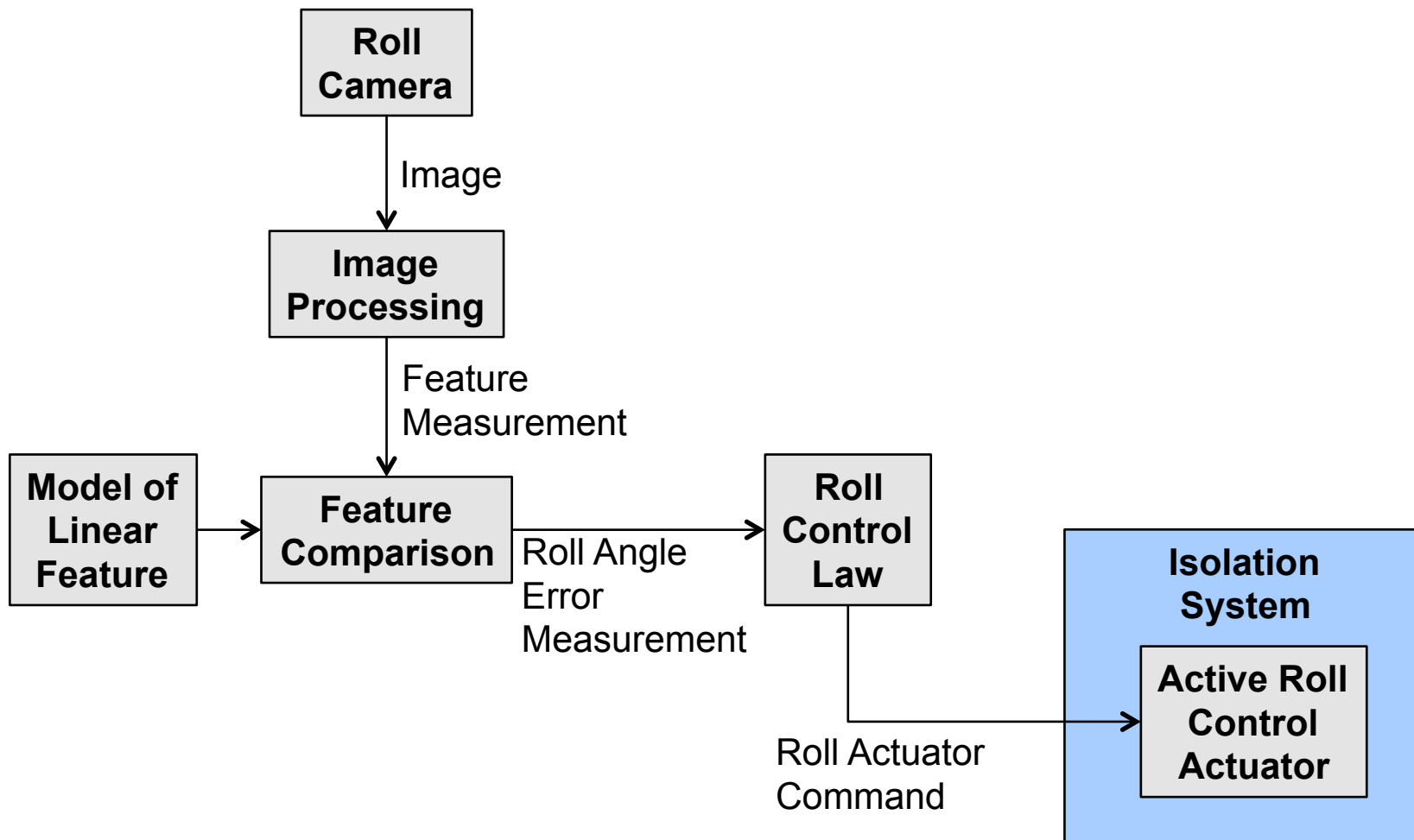



# Roll Control Requirement Driven by Smear at Ends of 8K-pixel Array



Integrated Design Capability / Instrument Design Laboratory

- Smear Requirement is  $< 1/10$ -pixel (or  $< 1/2$  pixel as a descope)
- Equivalent roll angle is  $1/10$  pixel divided by 8K-pixel span of array
- Roll camera scales the same way as the smear requirement
  - If we can resolve a  $1/10$ -pixel offset over an 8K-pixel span, then we can resolve the roll angle
  - This measurement is independent of the actual pixel size
- Roll camera solution is presented elsewhere



# Conclusions

---

## Integrated Design Capability / Instrument Design Laboratory

- **Star tracker placement is feasible**
  - Gives good view to stars
- **GOES disturbance spectrum used to drive isolation system design**
  - Isolation system is feasible
- **GEO-CAPE requires a roll control system**
  - Spacecraft roll errors violate smear requirements if not compensated
  - Roll control actuation applied at instrument base
  - Roll camera design driven by smear requirement
- **“Fast steering” loop is feasible**
  - Fast steering mirror is baseline. Other actuation options exist.
  - Need to confirm Astrix 200 sample rate supports fast steering bandwidth

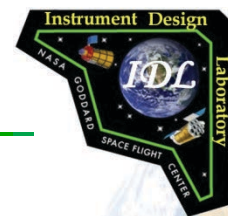

Integrated Design Capability / Instrument Design Laboratory

# GEO CAPE Wide Angle Spectrometer (WAS) ~ *Concept Presentations* ~

## Contamination

Mark Secunda

July 29, 2014

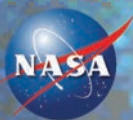

NASA GODDARD SPACE FLIGHT CENTER

# Wide Angle Spectrometer

## Integrated Design Capability / Instrument Design Laboratory

- Key Parameters:
- Geostationary
- Commercial Satellite
- Covers wavelengths from 360-1020 nm minimum, or 340-2200 nm
- 10% throughput loss acceptable

		(SZA = 70°)		Req'd		
$\lambda_0$ - nm	$\Delta\lambda$ - nm	$W/m^2 \cdot \Delta\lambda \cdot \mu\text{-ster}$			Required Minimum Set of Multi-Spectral Bands <sup>1</sup>	NOTES
Bands	FWHM	L <sub>typ</sub>	L <sub>max</sub>	SNR <sub>req</sub>		
350	15	46.90	166.2	1,000		
360	10	45.40	175.6	1,000	Yes	
385	10	38.40	177.9	1,000	Yes	
412	10	49.50	281.1	1,000	Yes	
425*	0.8	48.20	277.0	500		For estimating SNR for NO2 retrievals
443	10	45.00	271.3	1,000	Yes	
460	10	41.90	266.0	1,000		
475	10	38.20	261.3	1,000		
490	10	34.90	256.6	1,000	Yes	
510	10	29.00	250.3	1,000	Yes	
532	10	23.30	243.4	1,000		
555	10	18.50	224.9	1,000	Yes	
583	10	15.30	227.4	1,000		
617	10	12.20	216.7	1,000	Yes	
640	10	10.50	209.5	1,000		
655	10	9.57	204.7	1,000		
665	10	9.17	201.6	1,000	Yes	
678	10	8.66	197.5	1,000	Yes	
710	10	6.95	187.5	1,000	Yes	
748	10	5.60	175.5	600	Yes	
765	40	5.25	170.2	600	Yes	
820	15	3.93	152.9	600		
865	40	2.77	138.8	600	Yes	
1020	40	1.48	109.1	450	Yes	
1245*	20	0.582	56.10	250		
1640*	40	0.178	19.70	180		
2135*	50	0.040	5.35	100		

<sup>1</sup> Additional bands between 360-1020nm desirable; SNR should not be an issue for the additional bands.

^ Pixels can be aggregated up to 3x3 to achieve required SNR of 500:1 for atmospheric NO2 retrievals

\* Pixels can be aggregated up to 2x2 to achieve required SNR



# WAS Concerns

---

## Integrated Design Capability / Instrument Design Laboratory

- **Commercial satellite I&T is not done to same cleanliness standards as we're used to.**
  - WAS will need extra protection against unknowns
    - Well sealed instrument
    - Aperture one-time deploy cover
    - Purge
      - This will likely be a special request - often not used at all for commercial satellites
  - Lack of satellite contamination requirements may affect radiator EOL values
  - Need to confirm nothing in line of sight to aperture
- **Large wavelength band means sensitivity to lots of materials**
- **Large number of optics and surfaces**
  - Bake outs may be required
  - Keep particle contamination low
- **Long slit (15  $\mu\text{m}$  x 120 mm) means increased chance of a particle bridging the gap. At a cleanliness Level of 200, there is a 10% chance, at Level 175, ~5% chance.**
- **Electrostatic Return (ESR) of contamination can be a problem if the host spacecraft and instrument aren't completely grounded**

# WAS Wavelength Sensitivity

Integrated Design Capability / Instrument Design Laboratory

- **UV/Vis Channel**
  - 340-600 nm, 20°C, 13 optical surfaces
  - Estimate for 10% throughput loss, launch to end-of-life, is 287 Angstroms per surface
- **Vis/NIR Channel**
  - 600-1100 nm, 20°C, 14 optical surfaces
  - Estimate for 10% throughput loss, launch to end-of-life, is 490 Angstroms per surface
- **UV/Vis/NIR Channel**
  - 340-1100 nm, 20°C, 13 optical surfaces
  - Estimate for 10% throughput loss, launch to end-of-life, is 410 Angstroms per surface
    - Weighted average. If 340 nm is more important, estimate should be considered 287 Angstroms
- **SWIR Channel**
  - 1200-2200 nm, 155K, 11 optical surfaces
  - Estimate for 10% throughput loss, launch to end-of-life, is 120 Angstroms per surface, and 75 Angstroms for the detector
    - Most of this sensitivity is from 2000-2200 nm. Otherwise, similar to UV/Vis Channel



# Effects on Processes

---

## Integrated Design Capability / Instrument Design Laboratory

- **Multiple optics with limited throughput loss means more care**
  - bake-outs for internal components
  - Clean bench use for subassemblies, clean rooms for assemblies
  - SWIR Channel (specifically towards 2200 nm) limits allowable contamination on shared optics.
- **Sealing required to protect against possibly unclean spacecraft build**
- **May not allow spacecraft level testing with aperture open**
- **Instrument purge**
  - Cost, complexity, schedule impacts



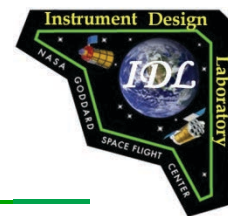

# Conclusions

---

## Integrated Design Capability / Instrument Design Laboratory

- Internally, nothing unusual, but still sensitive in some channels.
- A contamination sensitive instrument on a satellite with no contamination concerns, and no ability to enforce requirements, is problematic.
  - A well sealed instrument should mitigate this.
  - Large allowable throughput loss (10%) helps





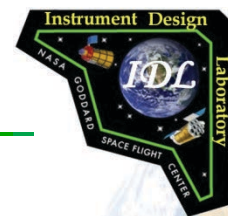

Integrated Design Capability / Instrument Design Laboratory

# GEO CAPE Wide Angle Spectrometer (WAS) ~ *Concept Presentations* ~

## Reliability

Aron Brall

July 29, 2014



N A S A   G O D D A R D   S P A C E   F L I G H T   C E N T E R

# Reliability Requirements

## Integrated Design Capability / Instrument Design Laboratory

- **Success criteria**
  - Class C mission
  - 3 year mission requirement with an Instrument Probability of Success (Ps) of 0.85 or greater at 3 years
  - 5 year mission goal
  - 4 Configurations - Baseline and three “Cases”
- **Reliability Assurance**
  - Designs are validated with appropriate Reliability Analyses - FTA, FMEA, Parts Stress Analysis, PRA, etc
  - Parts are Level 3 (Class S or Class B upscreened to requirements of EEE-INST-002 for Level 3 parts)
- **Designs meet NASA and GSFC specifications including:**
  - EEE-INST-002
  - GEVS (GSFC-STD-7000: General Environmental Verification Standard)
  - GSFC Gold Rules (GSFC-STD-1000)
  - NPR-8705-4

# Reliability Assumptions - 1

## Integrated Design Capability / Instrument Design Laboratory

- Component lifetimes follow the exponential distribution except bearings and gears which are modeled using the Weibull distribution
- The following are considered non-credible single point failures (SPF):
  - Structural and non-moving mechanical components
  - Short or open on power bus
  - Flexure Failures
  - Optical Failures (non active components)
- Software and procedural failures are not included in the analysis
  - Software is modeled as reliability of 1
  - Software Reliability needs to be formally addressed in development process
    - Software can have as low as 80% Reliability if this is not seriously addressed
- Standby (Idle Time) Reliability was not addressed
- Reliability of Host Spacecraft and Launch Vehicle were not assessed

# Reliability Assumptions - 2

## Integrated Design Capability / Instrument Design Laboratory

- **Exact models were used to determine subsystem reliabilities**
  - Binomial models for k of n subsystems:
    - Detector and Roll Camera Arrays
      - 8110 of 8192 rows for 8192 X 1024 detector
      - 3000 of 3072 rows for 4096 X 3072 Roll Camera sensor
  - Hot Standby Redundant exponential models for:
    - Operational and Survival Heater Circuits
  - All other components are Single String

# Reliability Assumptions - 3



## Integrated Design Capability / Instrument Design Laboratory

- **Bearing loads on rotating assemblies are loaded to their recommended preloads per manufacturers recommendations.**
- **On orbit rotating radial loads in addition to the preloads are negligible and do not exceed preloads.**
  - These are very small loads with respect to a typical dynamic load rating on a bearing
  - Suggests extremely long lifetimes at the low speeds the design is calling for
- **Launch loads on the bearings do not exceed their static load ratings to create initial damage.**
- **Lubrication to the bearings is adequate, and are maintained in clean room conditions (from bearing manufacturer) during integration**
- **CCD Row failures occur randomly and will not be concentrated in one given area**
  - Multiple adjacent rows failing is more severe degradation than rows failing in multiple isolated areas on the CCD



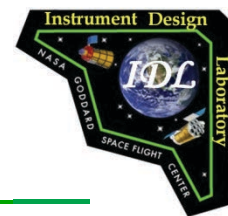

# Reliability Assumptions - 4

Integrated Design Capability / Instrument Design Laboratory

- **Duty Cycles**

- Diffuser Wheel	--	5%
- Scan Mirror Bearings	--	1%
- Operational Heaters	--	70%
- Survival Heaters	--	10%
- All other components	--	100%



# System Description - 1



## Integrated Design Capability / Instrument Design Laboratory

### • Detectors

- UV/VIS Silicon CCD - All Configurations
  - 8192 rows X 1024 columns (individual detector Baseline & Case 1; detector strip Case 2 and Case 3)
    - 5% row loss permitted over life each array (Modeled at 1%)
- VIS/NIR Silicon CCD - All Configurations (individual detector Baseline & Case 1; detector strip Case 2 and Case 3)
  - 8192 rows X 1024 columns
    - 5% row loss permitted over life each array (Modeled at 1%)
- SWIR Mercury Cadmium Telluride - Baseline and Delta 2
  - 8192 rows X 1024 columns in two arrays
    - 5% row loss permitted over life for grouped array (Modeled at 1%)
- Roll Camera
  - Two cameras each: 3072 rows X 4096 columns
    - Substantial row loss permitted over life each array (Modeled at 2.5%)



# System Description - 2

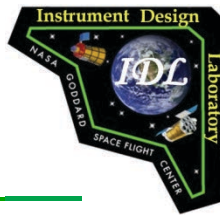

## Integrated Design Capability / Instrument Design Laboratory

### • Electronics

- Processor Card	--	1 Card
- Heater Control & H/K	--	1 Card
- Scan Mirror Motor Control	--	1 Card
- FSM Voice-Coil Control	--	1 Card
- Diffuser Wheel Control	--	1 Card
- Jitter & Roll Voice Coil Control	--	1 Card
- Power Converter	--	1 Card
- Digitizer	--	5 Cards (Baseline & Case 2) 4 Cards (Case 1 & Case 3)
- Roll Camera Processor & I/O	--	1 Card
- HAWAII ROIC Sidecar for SWIR	--	1 Device (Baseline & Case 2)

### • ACS

- IMU	--	1 Astrix 200
- Star Tracker	--	μASC, 2 heads, 1 processor





# System Description - 3



Integrated Design Capability / Instrument Design Laboratory

## • Mechanisms

- Diffuser Wheel
  - Stepper Motor
  - Encoder
  - Gear Set
- Scan Mirror
  - 2 axes each with:
    - Torquer Motor (Frameless)
    - 24 bit Encoder
    - Mechanism Bearings (2)
- Fast Scan Mirror - 2 axes each with:
  - 2 Voice Coil actuators
  - 2 LVDT position detectors
- Jitter Suppression/Roll Correction
  - 3 Flexure Mounts (not modeled)
  - 3 Voice Coil Actuators
- Contamination Door
  - Redundant HOP actuators each with Redundant Heaters





# System Description - 4

## Integrated Design Capability / Instrument Design Laboratory

- **Thermal**

- 4 Thermistor controlled redundant Operational Heater Circuits (Baseline & Case 2))
- 2 Thermistor controlled redundant Operational Heater Circuits (Case 1 & Case 3)
- 10 Thermostat controlled redundant Operational Heater Circuits
- 12 Thermostat controlled redundant Survival Heater Circuits
- Redundant heat pipes



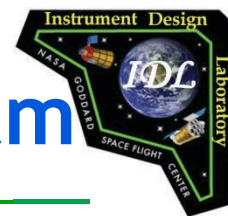

# GEO-CAPE WAS Reliability Block Diagram

Integrated Design Capability / Instrument Design Laboratory

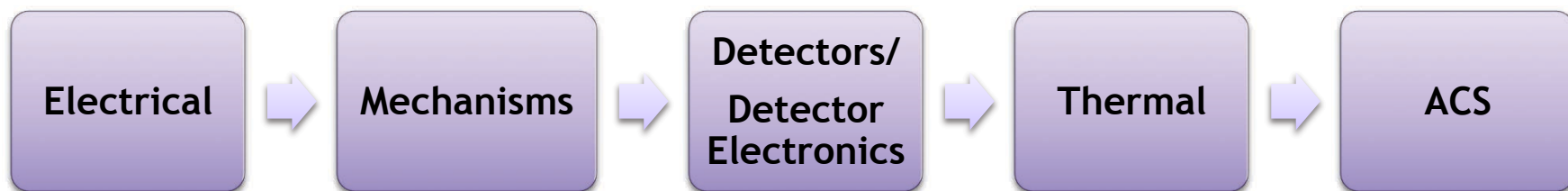



# Instrument Reliability Summary

Integrated Design Capability / Instrument Design Laboratory

	Baseline & Case 2		Case 1 & Case 3	
	Years on Orbit		Years on Orbit	
	3	5	3	5
<b>Detectors-Detector Electronics</b>	<b>0.9679</b>	<b>0.9470</b>	<b>0.9716</b>	<b>0.9531</b>
<b>Electrical</b>	<b>0.9629</b>	<b>0.9389</b>	<b>0.9629</b>	<b>0.9389</b>
<b>Mechanisms</b>	<b>0.9805</b>	<b>0.9701</b>	<b>0.9805</b>	<b>0.9701</b>
<b>ACS</b>	<b>0.9919</b>	<b>0.9865</b>	<b>0.9919</b>	<b>0.9865</b>
<b>Thermal</b>	<b>0.9996</b>	<b>0.9991</b>	<b>0.9996</b>	<b>0.9991</b>
<b>Design Reliability</b>	<b>0.9060</b>	<b>0.8501</b>	<b>0.9095</b>	<b>0.8556</b>



# Reliability Boundary Limits (Baseline & Case 2)



Integrated Design Capability / Instrument Design Laboratory

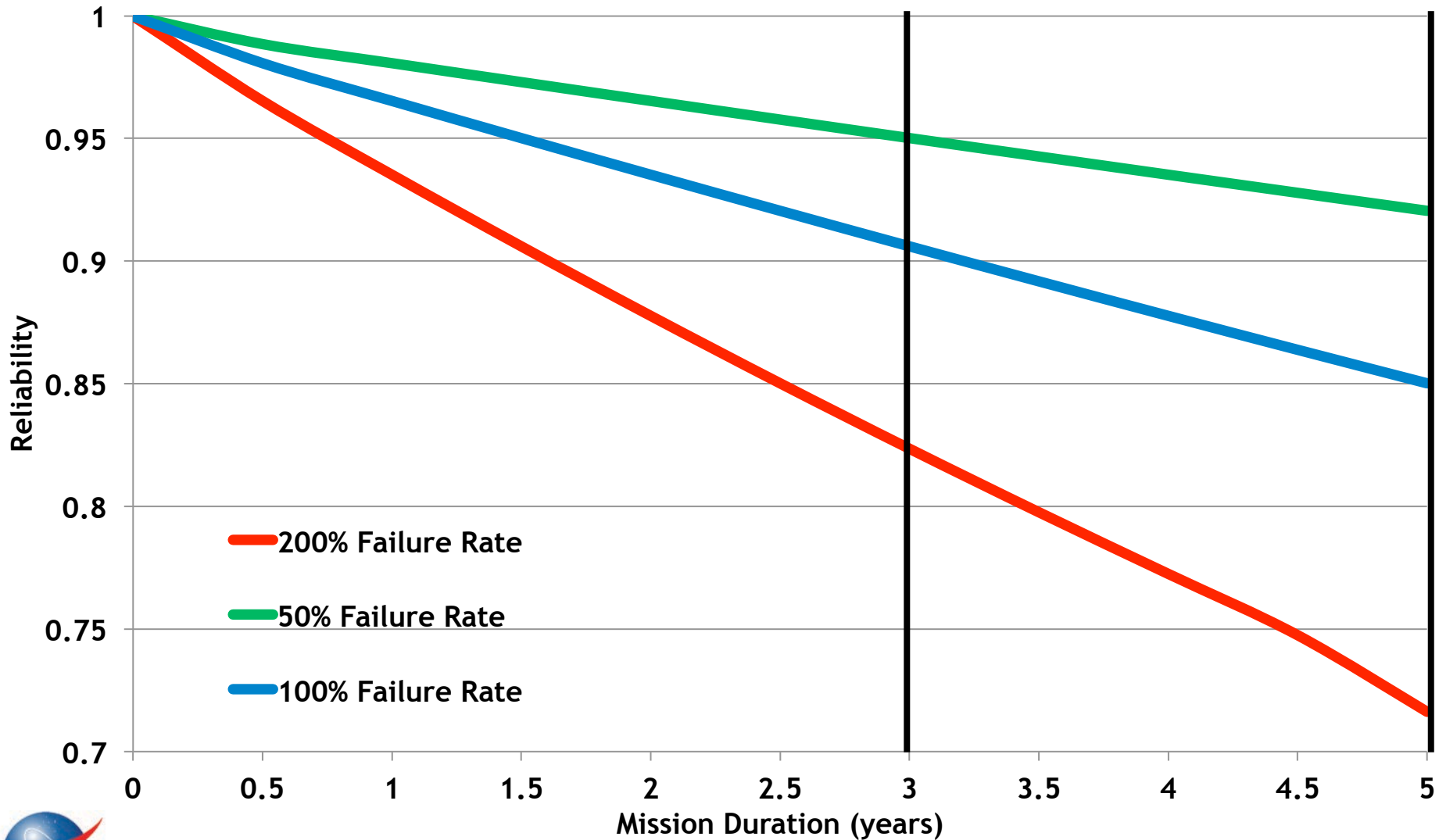

# Conclusions and Recommendations



## Integrated Design Capability / Instrument Design Laboratory

- Design exceeds required 85% reliability for 3 years (90.6% for Baseline & Case 2 Configuration), and actually meets 85% at 5 years for Baseline & Case 2 Configuration
  - Lower Boundary Limit (200% Failure Rate) just misses 85% for 3 years (82.3% for Baseline and Case 2 Configuration)
- Assure all assemblies (in- and out-of-house) have Parts Stress Analysis (PSA) and Failure Modes and Effects Analysis (FMEA) performed to assure compliance with derating and fault tolerance requirements
- Perform Probabilistic Risk Analysis (PRA) early in the program to identify high risk items and assure estimated reliability is met by designs
- Perform Worst Case Analysis (WCA) to assure part functionality over entire mission duration
- “Non-credible” Single Point Failures should be addressed with Probabilistic Risk Analysis, Failure Modes and Effects Analysis, and detailed Failure Modeling to assure they are truly “non-credible”



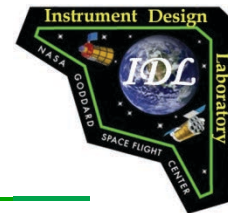

---

Integrated Design Capability / Instrument Design Laboratory

# BACKUP SLIDES



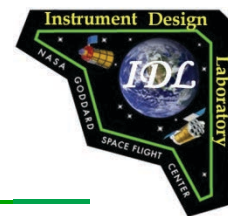

# Electrical Model - All Options

Integrated Design Capability / Instrument Design Laboratory

## Electrical

Subsystem / Component Name	Qty	Model	MTTF/ Char Life / Lognormal Mean	Failure Rate / Shape / Lognormal Std Dev	Relative Duty Cycle	Component Reliability (for time in years)			Redundancy Configuration	Subsystem Reliability (for time in years)		
						3	5	5		3	5	5
<b>Main Electrical Box</b>	1				100%	0.96289522	0.938926762	0.938926762	Single String	0.96289522	0.938926762	0.938926762
Processor	1	E	1824484.5	5.481E-07		0.985699174	0.976279089	0.976279089	Single String	0.96289522	0.938926762	0.938926762
LVPS	1	E	4865292.2	2.0554E-07		0.994613036	0.991037859	0.991037859				
Diffuser Wheel Stepper Motor Control	1	E	7297938.3	1.3703E-07		0.996405459	0.994016279	0.994016279				
Heater Control and H/K	1	E	7297938.3	1.3703E-07		0.996405459	0.994016279	0.994016279				
Fast Steering Mirror Voice Coil Actuator	1	E	7297938.3	1.3703E-07		0.996405459	0.994016279	0.994016279				
Jitter & Roll Comp. Voice Coil Actuator	1	E	7297938.3	1.3703E-07		0.996405459	0.994016279	0.994016279				
Scan Mirror Motor Control	1	E	7297938.3	1.3703E-07		0.996405459	0.994016279	0.994016279				
									<b>Electrical Total</b>			
									3 years	5 years	5 years	
									Min Redundancy	0.96289522	0.938926762	0.938926762
									Max Redundancy	0.96289522	0.938926762	0.938926762







# Mechanisms Model

## Integrated Design Capability / Instrument Design Laboratory

### Mechanisms

Subsystem / Component Name	Qty	Model	MTTF/ Char Life / Lognormal Mean	Failure Rate / Shape / Lognormal Std Dev	Relative Duty Cycle	Component Reliability (for time in years)			Redundancy Configuration	Subsystem Reliability (for time in years)		
						3	5	5		3	5	5
<b>Diffuser Wheel Mechanism</b>	1				5%	0.99969202	0.999453833	0.999453833	Single String	0.99969202	0.999453833	0.999453833
Motor Winding	1	E	5000000	0.0000002		0.999737235	0.999562096	0.999562096	Single String	0.99969202	0.999453833	0.999453833
Motor Bearings	2	W	100000	3.5		0.99999948	0.999996891	0.999996891				
Resolver	1	E	76923076	1.3E-08		0.999982918	0.99997153	0.99997153				
Gear set	1	W	250000	2		0.999972375	0.999923265	0.999923265				
<b>Scan Mirror Mechanism (SMM) Bearings</b>	1				1%	0.999999996	0.999999978	0.999999978	Single String	0.999999996	0.999999978	0.999999978
Mechanism Bearings	4	W	100000	3.5		0.999999996	0.999999978	0.999999978	Single String	0.999999996	0.999999978	0.999999978
<b>Scan Mirror Mechanism (SMM) Electrical</b>	1				100%	0.988867154	0.981514198	0.981514198	Single String	0.988867154	0.981514198	0.981514198
Motor Winding	2	E	5000000	0.0000002		0.989543058	0.982632583	0.982632583	Single String	0.988867154	0.981514198	0.981514198
Encoder	2	E	76923076	1.3E-08		0.999316953	0.998861848	0.998861848				
<b>Fast Steering Mirror (FSM)</b>	1				100%	0.997113374	0.995193588	0.995193588	Single String	0.997113374	0.995193588	0.995193588
Voice Coil	4	E	50000000	0.00000002		0.997899808	0.996502132	0.996502132	Single String	0.997113374	0.995193588	0.995193588
LVDT	4	E	133333333	7.5E-09		0.999211911	0.998686863	0.998686863				
<b>Vibration Suppression System Locks</b>	3				100%	0.98	0.98	0.98	Hot Redundancy	0.99880048	0.99880048	0.99880048
Frangibolt	1	U				0.98	0.98	0.98	Hot Redundancy	0.99880048	0.99880048	0.99880048
<b>Contamination Door</b>	1				100%	0.95	0.95	0.95	Hot Redundancy	0.9975	0.9975	0.9975
HOP	1	U				0.95	0.95	0.95	Hot Redundancy	0.9975	0.9975	0.9975
<b>Vibration Suppression System - Active</b>	1				100%	0.998424442	0.99737545	0.99737545	Single String	0.998424442	0.99737545	0.99737545
Voice Coil	3	E	50000000	0.00000002		0.998424442	0.99737545	0.99737545	Single String	0.998424442	0.99737545	0.99737545

### Mechanisms Total

	3 years	5 years	5 years
Min Redundancy	0.980517994	0.970101563	0.970101563
Max Redundancy	0.980517994	0.970101563	0.970101563





# Detector - Detector Electronics Model Baseline & Case 2 Configuration

## Detector-Detector Electronics

Subsystem / Component Name	Qty	Model	MTTF/ Char Life / Lognormal Mean	Failure Rate / Shape / Lognormal Std Dev	Relative Duty Cycle	Component Reliability (for time in years)			Redundancy Configuration	Subsystem Reliability (for time in years)		
						3	5	5		3	5	5
									8150	of	8192	
<b>UV/VIS Detector Array</b>	1				100%	0.998686863	0.997812396	0.997812396	K of N (Hot)	1	0.999999656	0.999999656
CCD 1K Row	1	E	20000000	0.00000005		0.998686863	0.997812396	0.997812396	K of N (Hot)	1	1	1
									8110	of	8192	
									8150	of	8192	
<b>VIS/NIR Detector Array</b>	1				100%	0.998686863	0.997812396	0.997812396	K of N (Hot)	1	0.999999656	0.999999656
CCD 1K Row	1	E	20000000	0.00000005		0.998686863	0.997812396	0.997812396	K of N (Hot)	1	1	1
									8110	of	8192	
									8150	of	8192	
<b>SWIR Detector Array</b>	1				100%	0.99880235	0.998004713	0.998004713	K of N (Hot)	1	0.99999997	0.99999997
MERCAD Photodetector (1 pixel)	1024	E	2.25E+10	4.4531E-11		0.99880235	0.998004713	0.998004713	K of N (Hot)	1	1	1
									8110	of	8192	
									3000	of	3072	
<b>Roll Camera</b>	2				100%	0.994757789	0.991278257	0.991278257	K of N (Hot)	1	1	1
CMOS 1K Row	4	E	20000000	0.00000005		0.994757789	0.991278257	0.991278257	K of N (Hot)	1	1	1
									3000	of	3072	
<b>Detector Electronics</b>	1				100%	0.981910864	0.970033594	0.970033594	Single String	0.981910864	0.970033594	0.970033594
Digitizers	5	E	7297938	1.3703E-07		0.982156038	0.970437309	0.970437309	Single String	0.981910864	0.970033594	0.970033594
HAWAII ROIC	1	E	1.05E+08	9.5E-09		0.999750371	0.999583987	0.999583987				
<b>Roll Camera Electronics</b>	2				100%	0.992823838	0.988068363	0.988068363	Single String	0.985699174	0.97627909	0.97627909
Electronics	1	E	7297938	1.3703E-07		0.996405459	0.994016279	0.994016279	Single String	0.985699174	0.97627909	0.97627909
Roll Camera Proc & I/O	1	E	7297938	1.3703E-07		0.996405459	0.994016279	0.994016279				

<b>Detector-Detector Electronics</b>			
	3 years	5 years	5 years
Min Redundancy	0.967868727	0.947022835	0.947022835
Max Redundancy	0.967868727	0.947023515	0.947023515



# Detector - Detector Electronics Model Case 1 & Case 3 Configuration



## Detector-Detector Electronics

Subsystem / Component Name	Qty	Model	MTTF / Char Life / Lognormal Mean	Failure Rate / Shape / Lognormal Std Dev	Relative Duty Cycle	Component Reliability (for time in years)			Redundancy Configuration	Subsystem Reliability (for time in years)		
						3	5	5		3	5	5
									8150	of	8192	
<b>UV/VIS Detector Array</b>	1				100%	0.998686863	0.997812396	0.997812396	K of N (Hot)	1	0.999999656	0.999999656
CCD 1K Row	1	E	20000000	0.00000005		0.998686863	0.997812396	0.997812396	K of N (Hot)	1	1	1
									8110	of	8192	
									8150	of	8192	
<b>VIS/NIR Detector Array</b>	1				100%	0.998686863	0.997812396	0.997812396	K of N (Hot)	1	0.999999656	0.999999656
CCD 1K Row	1	E	20000000	0.00000005		0.998686863	0.997812396	0.997812396	K of N (Hot)	1	1	1
									8110	of	8192	
									3012	of	3072	
<b>Roll Camera</b>	2				100%	0.994757789	0.991278257	0.991278257	K of N (Hot)	1	0.999999983	0.999999983
CMOS 1K Row	4	E	20000000	0.00000005		0.994757789	0.991278257	0.991278257	K of N (Hot)	1	0.999999983	0.999999983
									3012	of	3072	
									0.985699174	0.97627909	0.97627909	
<b>Detector Electronics</b>	4				100%	0.996405459	0.994016279	0.994016279	Single String	0.985699174	0.97627909	0.97627909
Digitizers	1	E	7297938	1.37025E-07		0.996405459	0.994016279	0.994016279	Single String	0.985699174	0.97627909	0.97627909
									0.985699174	0.97627909	0.97627909	
<b>Roll Camera Electronics</b>	2				100%	0.992823838	0.988068363	0.988068363	Single String	0.985699174	0.97627909	0.97627909
Electronics	1	E	7297938	1.37025E-07		0.996405459	0.994016279	0.994016279	Single String	0.985699174	0.97627909	0.97627909
Roll Camera Proc & I/O	1	E	7297938	1.37025E-07		0.996405459	0.994016279	0.994016279				
									<b>Detector-Detector Electronics</b>			
									3 years	5 years	5 years	
									<b>Min Redundancy</b>	0.971602862	0.95312019	0.95312019
									<b>Max Redundancy</b>	0.971602862	0.953120846	0.953120846



# Thermal Model

## Integrated Design Capability / Instrument Design Laboratory

Thermal													
Subsystem / Component Name	Qty	Model	MTTF/ Char Life / Lognormal Mean	Failure Rate / Shape / Lognormal Std Dev	Relative Duty Cycle	Component Reliability (for time in years)			Redundancy Configuration	Subsystem Reliability (for time in years)			
						3	5	5		3	5	5	
<b>Operational Heaters</b>	10				70%	0.999983575	0.999972625	0.999972625	Single String	0.999835763	0.999726287	0.999726287	
Redun Htr/T-Stat Ckt	1	E	1.12E+09	8.9286E-10		0.999983575	0.999972625	0.999972625	Single String	0.999835763	0.999726287	0.999726287	
<b>Survival Heaters</b>	12				10%	0.999997654	0.999996089	0.999996089	Single String	0.999971843	0.999953073	0.999953073	
Redun Htr/T-Stat Ckt	1	E	1.12E+09	8.9286E-10		0.999997654	0.999996089	0.999996089	Single String	0.999971843	0.999953073	0.999953073	
<b>Thermistors</b>	1				100%	0.9999429	0.999904835	0.999904835	K of N (Hot)	25	of	26	
Thermistors	1	E	4.6E+08	2.1728E-09		0.9999429	0.999904835	0.999904835	K of N (Hot)	0.999998941	0.999997061	0.999997061	
										25	of	26	
<b>Controlled Heaters</b>	4				70%	0.992628929	0.987745092	0.987745092	Hot Redundancy	0.999782687	0.999399404	0.999399404	
Heater	1	E	2500000	0.0000004		0.992668607	0.987810896	0.987810896	Hot Redundancy	0.999782687	0.999399404	0.999399404	
thermistor	1	E	4.6E+08	2.1728E-09		0.99996003	0.999933384	0.999933384					
<b>Heat Pipes</b>	2				100%	0.99957	0.999283436	0.999283436	Hot Redundancy	0.99999963	0.999998973	0.999998973	
fixed conductance heat pipe (FCHP)	1	E	61103138	1.6366E-08		0.99957	0.999283436	0.999283436	Hot Redundancy	0.99999963	0.999998973	0.999998973	
										<b>Thermal Total</b>			
										3 years	5 years	5 years	
										Min Redundancy	0.999588912	0.999075008	0.999075008
										Max Redundancy	0.999588912	0.999075008	0.999075008





# ACS Model

## Integrated Design Capability / Instrument Design Laboratory

ACS												
Subsystem / Component Name	Qty	Model	MTTF/ Char Life / Lognormal Mean	Failure Rate / Shape / Lognormal Std Dev	Relative Duty Cycle	Component Reliability (for time in years)			Redundancy Configuration	Subsystem Reliability (for time in years)		
						3	5	5		3	5	5
<b>Star Tracker</b>	1				100%	0.994862363	0.991451944	0.991451944	Single String	0.994862363	0.991451944	0.991451944
Star Tracker Head (Mini Star Tracker)	2	E	38461538	0.000000026		0.998634373	0.997724992	0.997724992	Single String	0.994862363	0.991451944	0.991451944
Star Tracker Processor (Mini Star Tracker)	1	E	6944444.4	0.000000144		0.996222832	0.993712649	0.993712649				
<b>IMU</b>	1				100%	0.996996993	0.995	0.995	Single String	0.996996993	0.995	0.995
Astrix 200	1	E	8738081.7	1.14442E-07		0.996996993	0.995	0.995	Single String	0.996996993	0.995	0.995
									<b>ACS Total</b>			
									3 years	5 years	5 years	
									Min Redundancy	0.991874784	0.986494684	0.986494684
									Max Redundancy	0.991874784	0.986494684	0.986494684



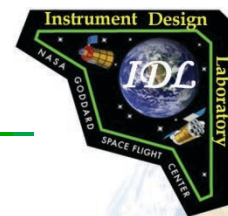

---

Integrated Design Capability / Instrument Design Laboratory

# GEO CAPE Wide Angle Spectrometer (WAS) ~ *Concept Presentations* ~

## Parametric Cost

Cabin Samuels

September 5, 2014

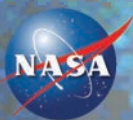

---

N A S A   G O D D A R D   S P A C E   F L I G H T   C E N T E R

# NASA Cost Estimating Overview



## Integrated Design Capability / Instrument Design Laboratory

### NASA Cost Estimating Handbook 2008

- Defines three cost estimating Methodologies
  - **Parametric:** based on key engineering data and Cost Estimating Relationships (CERs)
  - **Analogy:** comparison and extrapolation to like items or efforts
  - **Engineering Build-Up** (i.e., “**grass-roots**”): Labor and Material estimates based on experience and “professional judgment”
- Defines two cost estimating Processes
  - **Advocacy Cost Estimates (ACE)**
    - Cost Estimators are members of program/project team
  - **Independent Cost Estimates (ICE)**
    - Cost Estimators are from an organization separate from project
- Encourages parametric modeling and analogy estimates during pre-Phase A and Phase A studies

<http://www.nasa.gov/offices/ooe/CAD.html>

<http://ceh.nasa.gov>

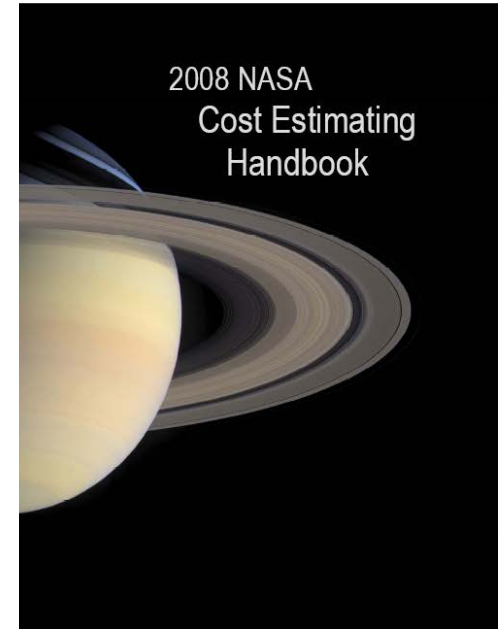

### Proposal cost estimates evaluated at NASA Langley Research Center during Technical, Management, and Cost (TMCO) review

- Parametric models used to validate proposal cost estimate
- Assumed criteria for validation of Step 1 proposal (based on feedback): proposal estimate and TMCO consensus estimate within 20%



# Current GSFC Proposal Cost Estimating “Best Practices”

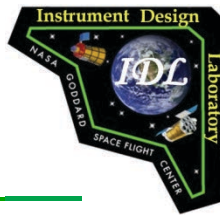

Integrated Design Capability / Instrument Design Laboratory

- **Advocacy Cost Estimating**
  - **Proposal Teams**
    - Grassroots estimate based on Work Breakdown Structure (WBS)
    - Parametric modeling used for Grassroots validation
  - **IDC**
    - Parametric modeling used to generate a stand-alone cost estimate
    - No Grassroots (WBS) cost estimate to validate
- **Independent “Assessment” (provided by RAO)**
  - Internal cost estimating tools and historical databases
  - Provides critical “Sanity Check”
- **Evolving “Best Practices”**
  - GSFC Chief Financial Officer (CFO)
  - NASA Cost Analysis Steering Group
  - NASA Cost Estimating Handbook





# Proposal Cost Estimating Process

Integrated Design Capability / Instrument Design Laboratory

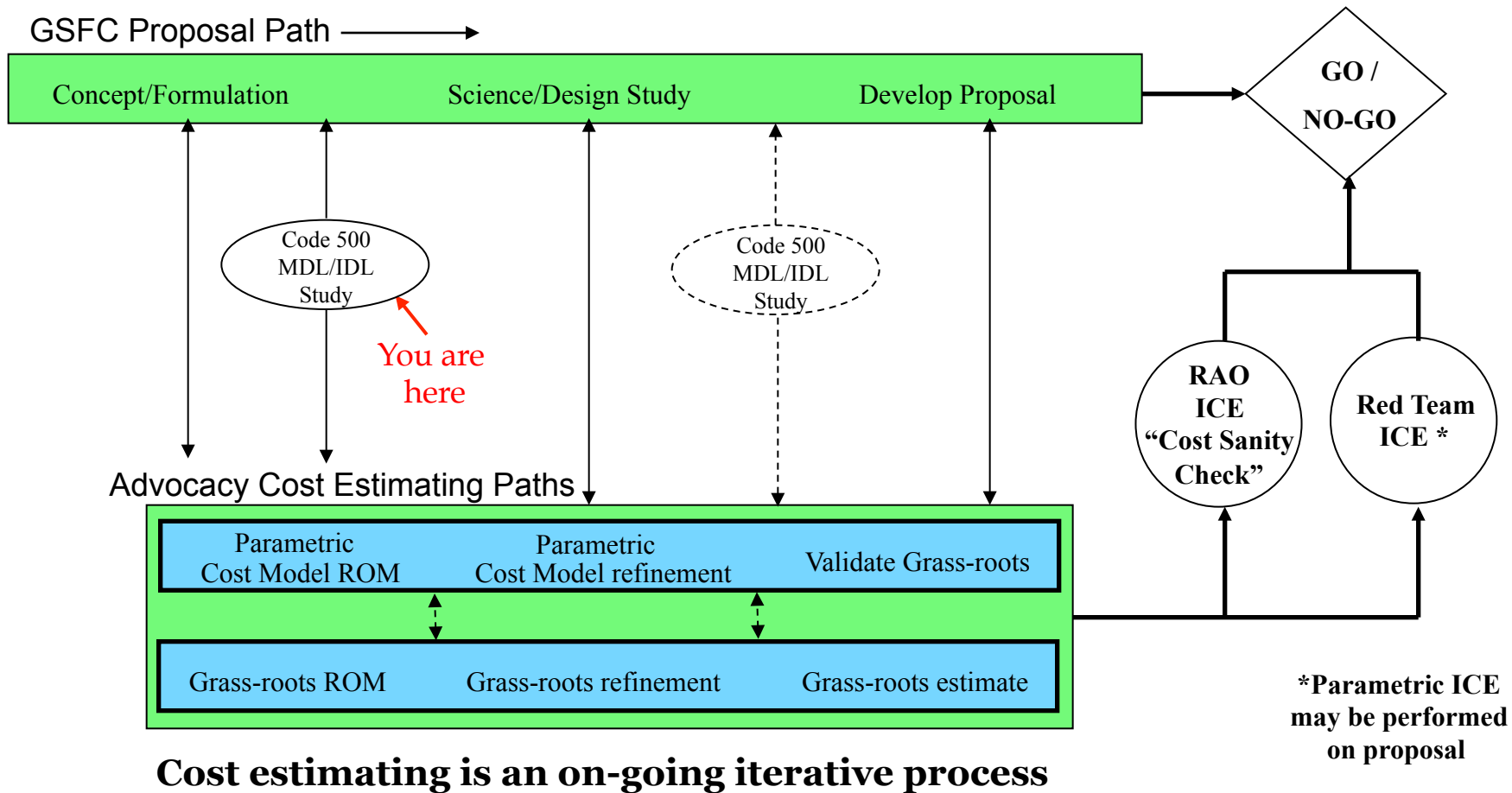

# Parametric Cost Estimating Tools

## Integrated Design Capability / Instrument Design Laboratory

- **NASA Cost Estimating Handbook 2008 describes two commercial tools**
  - **PRICE: Parametric Review of Information for Costing and Evaluation**
    - Separate modules for Hardware, Software, Integrated Circuits, and Life Cycle
    - PRICE H (Hardware) approaches cost estimates by parametrically defining:
      - Hardware to be built
      - Development and manufacturing environments
      - Operational environment
      - Schedule
    - PRICE H model is built from key engineering data (e.g., MEL: Master Equipment List)
    - Tool Heritage: Developed by RCA in the 1960's for the U.S. NAVY, Air force & NASA; Commercialized by PRICE Systems, L.L.C.
    - NASA-wide site license for PRICE H managed by Langley Research Center (GSFC Contact: Dedra Billings, Code 305.0, e-mail: [Dedra.S.Billings@nasa.gov](mailto:Dedra.S.Billings@nasa.gov))
    - PRICE H use at GSFC:
      - Mission Design Lab (MDL/IMDC), 10+ years experience and 150+ S/C Bus models
      - Instrument Design Lab (IDL/ISAL), 8+ years experience and 120+ Instrument models
      - Code 600/158, 10+ years experience, 100+ S/C Bus and 100+ Instrument models
  - **SEER: System Evaluation & Estimation of Resources**
    - Separate modules for Hardware, Software, Integrated Circuits, Manufacturability and Life Cycle
    - NASA-wide site license for SEER managed by Langley Research Center
    - Application-specific use of SEER-H at GSFC (e.g., detectors, cryocoolers, etc.)
    - SEER-SEM at GSFC used for estimating FSW w/ SLOC



# PRICE H: Key Input Parameters

## Integrated Design Capability / Instrument Design Laboratory

- **Global Parameters:**

- Labor Rates (set as appropriate)

- GSFC Bid Rates

This Study



- GSFC Typical Contractor Rates

- Used for GSFC vendor provided hardware

- Used when actual rates are not available

- 10% G&A, 14% Fee

- PRICE H Industry Labor Rates (default labor rates provided by Price Systems, Inc.)

- ?% G&A, ?% Fee

- Inflation (NASA escalation rates)

- Engineering Environment (Defined for NASA by PRICE Systems, Inc. calibration study)

- Emphasizes: System Engineering, Project Management, Automated design capabilities

- **Individual Cost Component Parameters:**

- Complexity Factors (Table driven, defined by Price Systems from industry experience)

- Modification Level/Remaining Design Factor (Heritage)

- Quantity and Design Repeat (Learning Curve)

- Composition (Structure, Electronic, Purchased, Cost Pass-through)

- Mass

- Operating Platform (Unmanned Space – High Reliability)

# IDL Parametric Cost Modeling

*Integrated Design Capability / Instrument Design Laboratory*

- **GEO CAPE WAS Parametric Cost Inputs (used for PRICE-H):**
  - IDL Discipline Engineering Final Presentations
  - Master Equipment List (MEL)
  
- **GEO CAPE WAS Grassroots Cost Inputs:**  
(provided by IDL Discipline Engineers)
  - IDL provided grassroots cost estimates for:
    - FPGA Firmware (see MEL FPGA tab and Final Electrical Presentation)
    - FSW Testbed (see MEL FSW tabs and Final FSW Presentation)
    - SideCar ASIC Assembly Code (see MEL ASIC Code tab and Final FSW Presentation)
    - Roll Camera repackaging and ruggedization (See MEL Roll Camera tab)
    - Nickel Plating NRE - Optics
  
- **GEO CAPE WAS Customer Furnished and Other Purchased Items:**
  - uASC Star Tracker and IMU ASTRIX-200
  
- **GEO CAPE WAS Cost Output Customer Products:**
  - PowerPoint presentation
  - Model results exported to Excel Spreadsheet and merged with grassroots costs (if any) and appropriate GSFC wrap factors
    - Excel output spreadsheet includes multiple tabs (at bottom)

# GEO CAPE WAS

## Cost Modeling Key Assumptions

Integrated Design Capability / Instrument Design Laboratory

- **GEO CAPE WAS Key Assumptions:**

- ETUs and Component Spares covered by wrap factors
- Class C Mission (Class B Parts – upscreening not included in cost estimate)
- Costs reported in FY2016 constant year dollars
- Instrument built by contractor – do not apply GSFC CM&O
- No existing Manufacturing Process and Assembly Line
- PRICE-H Estimate is for a Protoflight Unit and EDUs
- Schedule used:

ATP:	12/1/2017
CDR:	12/1/2018
PER:	5/1/2021
Instrument Delivery:	-
Science Mission Duration:	3 years

- Detailed assumptions are tagged CME (Cost Modeler Engineered) in model
- Minimum mass increment modeled is 3 grams. Items below 3 grams were increased to 3 grams
- SEER-H cost estimates for CCD & HgCdTe Detectors (Red, Blue, Purple, & MCT)
- SEER-SEM cost estimates for FSW based on SLOC
- IDL Grassroot cost estimates for FPGA firmware, FSW Testbed, SideCar ASIC Micro Code, Roll Camera repackaging, and NRE for optics with nickel plating
- Costs not calculated by PRICE-H accounted for by GSFC calibrated placeholder ‘wrap’ factors:
  - Ground Support Equipment (GSE) - 5% of PRICE-H Instrument Payload Estimate
  - Environmental Testing - 5% of PRICE-H Instrument Payload Estimate
  - Component Level Flight Spares - 10% of PRICE-H Partial Instrument Payload Estimate
  - Engineering Test Units (ETUs) at subassy level – 10% of PRICE-H Partial Instrument Payload Estimate
  - Instrument to S/C Bus I&T - 5% of PRICE-H Instrument Payload Estimate (Typically Included in WBS 10.0)



# GEO CAPE WAS

## Cost Modeling Key Assumptions

Integrated Design Capability / Instrument Design Laboratory

### FU

- Flight Unit (1 for GEO CAPE WAS)
- Protoflight
- “Fly the unit you qualify”
- Used for Class C mission

### ETU

- Engineering Test Unit
- Hardware tested to environmental qualification levels
- May be flown as flight spare if successfully qualified
- **For GEO CAPE WAS :** Placeholder bin of money provided via “wrap factor”
- ETUs to be determined after leaving IDL by customer team to address Gold Rule requirements and/or risk reduction
- ETUs selected by customer should be commensurate with Class C mission risk posture
- Adequacy of placeholder bin of money should be adjusted once ETU list is developed.

### EDU

- Engineering Development Unit
- Can not be flown
- Used to prove out first build of early concept engineering
- Test form/function only
- Limited or no environmental testing
- **For GEO CAPE WAS :** EDUs selected are noted in cost detail output.
- EDU of entire instrument for consistency with other GEO CAPE studies
- Kept to minimum for Class C mission.

### Spares

- Placeholder bin of money provided via “wrap factor”
- Customer should determine necessary spares at component and/or subassembly level commensurate with a Class C mission risk posture after leaving IDL
- Adequacy of placeholder bin of money should be adjusted once spares list is developed.

# GEO CAPE WAS Baseline Parametric Cost Summary



## Integrated Design Capability / Instrument Design Laboratory

GEOCAPE Wide Angle Spectrometer (WAS) Baseline Summary

IDL Parametric Cost Estimate (IDL = Instrument Design Lab) (Development and Production Costs)	Flight Units = 1 Eng Design Units = 1 Cost Estimate (FY\$016)
<b>PRICE-H Cost Model Summary 27-Aug-14</b>	
<b>GEOCAPE WAS Instrument Baseline Assembly (351.62 kg) (351.62 Kg)</b>	<b>\$123,468,941</b>
<i>Science Aperture Baffle Assembly (9.88 kg)</i>	\$2,090,012
<i>Diffuser Select Assembly (46.80 kg)</i>	\$9,570,386
<i>Scan Mirror Assembly (33.97 kg)</i>	\$13,690,010
<i>Telescope Assembly (19.54 kg)</i>	\$10,815,177
<i>Internal Baffles Assembly (0.52 kg)</i>	\$309,251
<i>Common Mount Assembly (3.39 kg)</i>	\$4,125,431
<i>UV/Vis Channel Assembly (9.64 kg)</i>	\$7,019,908
<i>Vis/NIR Channel Assembly (10.23 kg)</i>	\$7,318,080
<i>SWIR Channel Assembly (11.38 kg)</i>	\$8,451,891
<i>Instrument Structure/Enclosure Assembly (111.91 kg)</i>	\$15,740,856
<i>UV/VIS/NIR Digitizer Box (Qty 2, 1.49 kg ea)</i>	\$2,028,298
<i>SWIR Digitizer Box (1.19 kg)</i>	\$1,524,768
<i>Roll Camera Assembly (4.49 kg)</i>	\$4,632,296
<i>uASC Star Tracker (1.50 kg)</i>	\$3,538,035
<i>IMU Assembly (10.25 kg)</i>	\$4,818,392
<i>WAS Main Electronics Box (MEB) Assembly (7.05 kg)</i>	\$12,811,403
<i>Harness Assembly (14.04 kg)</i>	\$2,983,003
<i>Contamination Purge Hardware (SS ,TRL 6)</i>	\$427,129
<i>Thermal Subsystem Assembly (33.55 kg)</i>	\$7,471,798
<i>5% Misc H/W (SS ,TRL 7)</i>	\$1,474,898
<i>GEOCAPE WAS Instrument Assembly Integration and Test</i>	\$2,627,918
<i>Optical Nickel Plating NRE - IDL Grassroots Estimate</i>	\$197,523
<i>Blue and Red CCDs - SEER-H Estimate</i>	\$2,323,919
<i>Teledyne HAWAII-4RG HgCd - SEER-H Estimate</i>	\$15,228,490
<i>Roll Camera Modification Life Cycle Cost - IDL Grassroots Estimate</i>	\$1,390,637
<b>PRICE-H Instrument Payload Estimate</b>	<b>\$142,609,510</b>

\* Cost of I&T at Indenture Level 2 Assembly only--See Instrument details tab for other I&T costs

Continued on next page



# GEO CAPE WAS Baseline Parametric Cost Summary

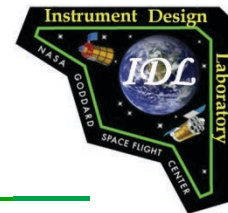

## Integrated Design Capability / Instrument Design Laboratory



<p>The Following are NOT PRICE-H estimates but are derived from PRICE-H estimates. These are included for completeness and are considered ROM 'Grass-roots' estimates. Consult the Grass-roots estimating organization for a more accurate estimate.</p>	
Flight Software (SEER-SEM Estimate based on SLOC Table from IDL)	\$2,351,212
Flight Software Sustaining Engineering (SEER-SEM Estimate based on SLOC Table from IDL, Include in WBS 7.0 = \$1.24M)	<< see note
Total FSW Testbed GSE (Grassroots)	\$899,175
FPGA Development (7 Unique FPGAs @ \$430K ea & 7 Unique Algorithms @ \$430K ea identified)	\$6,020,000
ASIC Code Development (Grassroots)	\$1,628,917
Ground Support Equipment (GSE) (5% of Instrument Cost Estimate)	\$7,130,475
Environmental Testing (5% of Instrument Cost Estimate)	\$7,130,475
Flight Spares (10% of Instrument Cost Estimate)	\$14,260,951
Engineering Test Unit (ETU) (10% of Instrument Cost Estimate)	\$14,260,951
Instrument to S/C Bus Integration & Test (5% of Instrument Cost Estimate, Typically Included in WBS 10.0=\$7.06M)	<< see note
<b>Instrument Subtotal</b>	<b>\$196,291,667</b>
<b>Institutional Charges (Basis of Estimate: 0% GSFC CM&amp;O)</b> (For GSFC, Contact Code 153 to verify applicability to your project)	N/A
<b>WBS 5.0 Instrument Point Estimate for Point Design - Does not include Cost Risk</b>	<b><u>\$196,291,667</u></b>







# GEO CAPE WAS Baseline PRICE-H Cost Summary

Integrated Design Capability / Instrument Design Laboratory

Basic Estimate (Metric)			
Cost Summary	LM Totals	LM Production	LM Development
IDL: GEOCAPE WAS Baseline (Class B EE Parts, FY2016\$, Contra Tue September 02 2014 1:35 PM (PRICE Estimating Suite 2014 Release) System Cost Summary Costs in (\$1000 Constant 2016)			
Program Cost	Development	Production	Total Cost
Engineering			
Draft	8141.4	290.0	8431.4
Design	33465.3	1552.5	35017.8
System	12218.9	-	12218.9
Proj. Mgmt.	12906.8	3825.2	16732.0
Data	190.9	64.5	255.4
<b>SubTotal(ENG)</b>	<b>66923.4</b>	<b>5732.2</b>	<b>72655.6</b>
Des Int Cost	[ 4307.2]		
Manufacturing			
Production	-	11283.7	11283.7
Prototype	5013.8	-	5013.8
Tool Test Eq.	711.9	385.9	1097.8
Purchased	4530.6	5061.4	9592.0
<b>SubTotal(MFG)</b>	<b>10256.3</b>	<b>16731.0</b>	<b>26987.2</b>
G & A / CoM	7103.4	1559.9	8663.3
Fee / Profit	11799.6	3363.2	15162.9
<b>Total Cost</b>	<b>96082.7</b>	<b>27386.3</b>	<b>123468.9</b>
<b>Total (Thruput)</b>	<b>196.7</b>	<b>0.0</b>	<b>196.7</b>
<b>Total w/Thruput</b>	<b>96279.4</b>	<b>27386.3</b>	<b>123665.7</b>
Schedule Start	Dec 17 [ 19]	Dec 18 [ 9]	
First Item	Jun 19	Aug 19 [ 21]	
Finish	Jun 19 [ 19]	May 21 [ 30]	
System Weight	351.62	System WS	339.58
System Series MTBF Hrs	464.602	Unit Sys Cost	19739807.71
System Quantity	1	Avg System Cost	27386272.61

Engineering

Project Management

Manufacturing

Schedule

Mass

Cost Element  
(Summary Report  
Available for each  
cost element)

Constant  
Year Dollars  
(\$14)

Production

Development

PRICE-H Instrument  
Development and  
Production Cost Estimate  
~\$123.7M



# GEO CAPE WAS Baseline PRICE-H Top-Level Cost Model

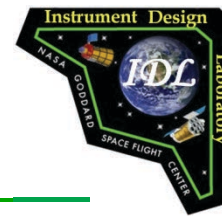

Integrated Design Capability / Instrument Design Laboratory

Sys IDL: GEOCAPE WAS Baseline (Class B EE Parts, FY2016\$, Contractor Rates)		H/L	Print	Ctrl	Esc	Fin	Dep
Assembly	GEOCAPE WAS Instrument Baseline Assembly (351.62 kg)	H/L	Print	Ctrl	Esc	Fin	Dep
Electronic	Science Aperture Baffle Assembly (9.88 kg)	H/L	Print	Ctrl	Esc	Fin	Dep
Struct/Mech	Diffuser Select Assembly (46.80 kg)	H/L	Print	Ctrl	Esc	Fin	Dep
Purchased	Scan Mirror Assembly (33.97 kg)	H/L	Print	Ctrl	Esc	Fin	Dep
Furnished	Telescope Assembly (19.54 kg)	H/L	Print	Ctrl	Esc	Fin	Dep
Modified	Internal Baffles Assembly (0.52 kg)	H/L	Print	Ctrl	Esc	Fin	Dep
Mod/Chip	Common Mount Assembly (3.39 kg)	H/L	Print	Ctrl	Esc	Fin	Dep
Design Integ	UV/Vis Channel Assembly (9.64 kg)	H/L	Print	Ctrl	Esc	Fin	Dep
Hw/Sw Int	Vis/NIR Channel Assembly (10.23 kg)	H/L	Print	Ctrl	Esc	Fin	Dep
Integ & Test	SWIR Channel Assembly (11.38 kg)	H/L	Print	Ctrl	Esc	Fin	Dep
Calibration	Instrument Structure/Enclosure Assembly (111.91 kg)	H/L	Print	Ctrl	Esc	Fin	Dep
Thruput	UV/VIS/NIR Digitizer Box (Qty 2, 1.49 kg ea)	H/L	Print	Ctrl	Esc	Fin	Dep
Multiple Lot	SWIR Digitizer Box (1.19 kg)	H/L	Print	Ctrl	Esc	Fin	Dep
	Roll Camera Assembly (4.49 kg)	H/L	Print	Ctrl	Esc	Fin	Dep
	uASC Star Tracker (1.50 kg)	H/L	Print	Ctrl	Esc	Fin	Dep
	IMU Assembly (10.25 kg)	H/L	Print	Ctrl	Esc	Fin	Dep
	WAS Main Electronics Box (MEB) Assembly (7.05 kg)	H/L	Print	Ctrl	Esc	Fin	Dep
	Harness Assembly (14.04 kg)	H/L	Print	Ctrl	Esc	Fin	Dep
	Contamination Purge Hardware (SS ,TRL 6)	H/L	Print	Ctrl	Esc	Fin	Dep
	Thermal Subsystem Assembly (33.55 kg)	H/L	Print	Ctrl	Esc	Fin	Dep
	5% Misc H/W (SS ,TRL 7)	H/L	Print	Ctrl	Esc	Fin	Dep
	GEOCAPE WAS Instrument Assembly Integration and Test	H/L	Print	Ctrl	Esc	Fin	Dep



# GEO CAPE WAS Baseline Expanded PRICE-H Model



## Integrated Design Capability / Instrument Design Laboratory

Item #	Description	Weight	TRL	Material	Notes
0	Sys IDL: GEOCAPE WAS Baseline (Class B EE Parts, FY2016\$, Contractor Rates)				
1	GEOCAPE WAS Instrument Baseline Assembly	351.62 kg	6		
2	Science Aperture Baffle Assembly	9.88 kg	6		
3	Contamination Cover (12mm Al H/C - 1mm M55J FS, TRL 6)		6		
4	Cover Hinge Assembly (Al/steel/Delrin, TRL 6)		6		
5	Cover HOP Actuator RL-300 Restraint Latch (TRL 9)		9		
6	Cover Limit/Status Sensors/Microswitches (TRL 9)		9		
7	Cover Kickoff and Torsion Springs (CRES, TRL 6)		6		
8	Science Aperture Baffle (M55J, TRL 6)		6		
9	Diffuser Select Assembly Integration & Test				
10	Diffuser Select Assembly	46.80 kg	6		
11	Diffuser Wheel Edge Cover (M55J, TRL 6)		6		
12	Diffuser Wheel (Al H/C - AL FS, TRL 6)		6		
13	Drive Ring (Al, TRL 6)		6		
14	Diffuser-1 (Fused Silica, TRL 6)		6		
15	Diffuser-2 (Fused Silica, TRL-5)		5		
16	Diffuser Wheel Stepper Motor/Gearbox (TRL 6)		6		
17	Diffuser Wheel Gearbox Pinion Gear (Steel, TRL 6)		6		
18	Diffuser Wheel Central Bearing (Steel, TRL 6)		6		
19	Diffuser Wheel Guide Bearing (Qty 3, Steel, TRL 6)		6		
20	Diffuser Wheel 10 bit Absolute Encoder (TRL 6)		6		
21	Diffuser Select Assembly Integration & Test				
22	Scan Mirror Assembly	33.97 kg	6		
23	Scan Mirror (Nickel Plated Be, TRL 6)		6		
24	Scan Mirror Mount (M55J, TRL 6)		6		
25	Mirror Pads (Qty 6 totaling to 6 grams, Invar, TRL 6)		6		
26	Mirror Flexures (Qty 3 totaling to 4 grams, Ti, TRL-6)		6		
27	Nickel Plating NRE (IDL Estimated Cost \$180K FY12\$ escalated to FY16\$)				
28	Scan Mirror Mechanism Assembly	15.49 kg	6		
29	Tip / Tilt Axis Limited Angle Torque Motor (Qty 2, TRL 6)		6		
30	Tip / Tilt Axis 24 bit Absolute Angle Encoder (Qty 2, TRL-6)		6		
31	Encoder Read Heads and Interface Box (Qty 2, TRL 6)		6		
32	Tip / Tilt Axis Bearing (Qty 4, Steel, TRL 6)		6		
33	Gimbal Ring (Ti, TRL 6)		6		
34	Launch Lock (Qty 2, TRL 6)		6		
35	Scan Mirror Mechanism Assembly Integration & Test				
36	Scan Mirror Assembly Integration & Test				



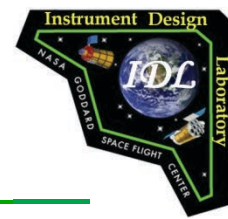

# GEO CAPE WAS Baseline PRICE-H Detailed Cost Estimate

## Integrated Design Capability / Instrument Design Laboratory

Indenture	PRICE H Cost Model Summary Typical GSFC-Contractor (2004) Rates Escalated	Total Quantity	Quantity Next Higher Assembly	Unit Mass		Total Mass (Kg)	FY016	Mode
				Unit Mass	Total Mass (Kg)			
	<b>IDL: GEOCAPE WAS Baseline (Class B EE Parts, FY2016\$, Contractor Rates)</b>	1	1			<b>351.620</b>	<b>\$123,468,941</b>	<b>System</b>
1	GEOCAPE WAS Instrument Baseline Assembly (351.62 kg)	1	1				\$123,468,941	Assembly
2	<b>Science Aperture Baffle Assembly (9.88 kg)</b>	1	1				\$2,090,012	Assembly
3	Contamination Cover (12mm Al H/C - 1mm M55J FS, TRL 6)	1	1	2.000	2.000		\$414,014	STRUCTURAL / MECHANICAL
3	Cover Hinge Assembly (Al/Steel/Delrin, TRL 6)	1	1	1.000	1.000		\$225,827	STRUCTURAL / MECHANICAL
3	Cover HOP Actuator RL-300 Restraint Latch (TRL 9)	1	1	0.280	0.280		\$31,807	ELECTRO / MECHANICAL
3	Cover Limit/Status Sensors/Microswitches (TRL 9)	1	1	0.100	0.100		\$16,984	ELECTRO / MECHANICAL
3	Cover Kickoff and Torsion Springs (CRES, TRL 6)	1	1	0.500	0.500		\$158,727	STRUCTURAL / MECHANICAL
3	Science Aperture Baffle (M55J, TRL 6)	1	1	6.000	6.000	9.880	\$1,117,297	STRUCTURAL / MECHANICAL
3	Diffuser Select Assembly Integration & Test	1	1			9.880	\$125,356	INTEG & TEST
2	<b>Diffuser Select Assembly (46.80 kg)</b>	1	1				\$9,570,386	Assembly
3	Diffuser Wheel Edge Cover (M55J, TRL 6)	1	1	0.340	0.340		\$143,343	STRUCTURAL / MECHANICAL
3	Diffuser Wheel (Al H/C - AL FS, TRL 6)	1	1	12.160	12.160		\$1,362,240	STRUCTURAL / MECHANICAL
3	Drive Ring (Al, TRL 6)	1	1	19.000	19.000		\$1,843,099	STRUCTURAL / MECHANICAL
3	Diffuser-1 (Fused Silica, TRL 6)	1	1	6.200	6.200		\$1,153,544	STRUCTURAL / MECHANICAL
3	Diffuser-2 (Fused Silica, TRL-5)	1	1	6.200	6.200		\$1,742,910	STRUCTURAL / MECHANICAL
3	Diffuser Wheel Stepper Motor/Gearbox (TRL 6)	1	1	2.000	2.000		\$1,212,259	ELECTRO / MECHANICAL
3	Diffuser Wheel Gearbox Pinion Gear (Steel, TRL 6)	1	1	0.100	0.100		\$63,930	STRUCTURAL / MECHANICAL
3	Diffuser Wheel Central Bearing (Steel, TRL 6)	1	1	0.200	0.200		\$97,183	STRUCTURAL / MECHANICAL
3	Diffuser Wheel Guide Bearing (Qty 3, Steel, TRL 6)	3	3	0.100	0.300		\$122,916	STRUCTURAL / MECHANICAL
3	Diffuser Wheel 10 bit Absolute Encoder (TRL 6)	1	1	0.300	0.300	46.800	\$1,109,800	ELECTRO / MECHANICAL
3	Diffuser Select Assembly Integration & Test	1	1			46.800	\$719,160	INTEG & TEST
2	<b>Scan Mirror Assembly (33.97 kg)</b>	1	1				\$13,690,010	Assembly
3	Scan Mirror (Nickel Plated Be, TRL 6)	1	1	7.100	7.100		\$4,339,315	STRUCTURAL / MECHANICAL
3	Scan Mirror Mount (M55J, TRL 6)	1	1	11.372	11.372		\$3,076,981	STRUCTURAL / MECHANICAL
3	Mirror Pads (Qty 6 totaling to 6 grams, Invar, TRL 6)	1	1	0.006	0.006		\$13,689	STRUCTURAL / MECHANICAL
3	Mirror Flexures (Qty 3 totaling to 4 grams, Ti, TRL-6)	1	1	0.004	0.004		\$16,085	STRUCTURAL / MECHANICAL
3	Nickel Plating NRE (IDL Estimated Cost \$180K FY12\$ escalated to FY16\$)	1						THRU-PUT
3	Scan Mirror Mechanism Assembly (15.49 kg)	1	1				\$4,967,226	Assembly
4	Tip / Tilt Axis Limited Angle Torque Motor (Qty 2, TRL 6)	2	2	0.680	1.360		\$678,742	ELECTRO / MECHANICAL
4	Tip / Tilt Axis 24 bit Absolute Angle Encoder (Qty 2, TRL-6)	2	2	5.090	10.180		\$2,150,448	ELECTRO / MECHANICAL
4	Encoder Read Heads and Interface Box (Qty 2, TRL 6)	2	2	0.254	0.508		\$645,553	ELECTRO / MECHANICAL
4	Tip / Tilt Axis Bearing (Qty 4, Steel, TRL 6)	4	4	0.050	0.200		\$86,341	STRUCTURAL / MECHANICAL
4	Gimbal Ring (Ti, TRL 6)	1	1	3.200	3.200		\$641,899	STRUCTURAL / MECHANICAL
4	Launch Lock (Qty 2, TRL 6)	2	2	0.020	0.040	33.970	\$101,773	ELECTRO / MECHANICAL
4	Scan Mirror Mechanism Assembly Integration & Test	1	1				\$662,470	INTEG & TEST
3	Scan Mirror Assembly Integration & Test	1	1			33.970	\$1,276,714	INTEG & TEST
2	<b>Telescope Assembly (19.54 kg)</b>	1	1				\$10,815,177	Assembly
3	Primary Mirror Assembly (9.96 kg)	1	1				\$4,331,778	Assembly
4	Primary Mirror (ULE, TRL 6)	1	1	6.780	6.780		\$3,308,372	STRUCTURAL / MECHANICAL
4	Primary Mirror Pad (Qty 6, Invar, TRL 6)	6	6	0.067	0.402		\$73,701	STRUCTURAL / MECHANICAL
4	Primary Mirror Flexure Blade (Qty 3, Ti, TRL 6)	3	3	0.013	0.039		\$30,363	STRUCTURAL / MECHANICAL
4	Primary Mirror Mount (M55J, TRL 6)	1	1	2.744	2.744	9.965	\$529,310	STRUCTURAL / MECHANICAL
4	Primary Mirror Assembly Integration & Test	1	1				\$390,032	INTEG & TEST



# IDL Point Design Estimate & Cost Risk

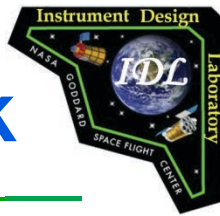

## Integrated Design Capability / Instrument Design Laboratory

- The IDL Cost Estimate is a Point Estimate based on the single point design of the instrument
- The point design that the IDL derives in a 1-week study is an engineering solution, but not necessarily THE solution that will be implemented for flight
- The point estimate is described by the IDL in the MEL in terms of Current Best Estimate (CBE) of mass and materials, and represents a single estimate among a range of feasible possibilities
- Cost risk analysis attempts to address the risk that the eventual outcome of the parameters may differ from the CBE selections made at the conceptual design phase of pre-formulation
- Cost risk capabilities within the parametric cost modeling tool allow a range of input values to be entered to generate a range of cost outcomes
- Cost risk simulation is performed using well known sampling techniques (e.g. Monte Carlo simulation) of the parameter ranges resulting in a Probability Distribution Function (PDF) of possible outcomes, also known as a Density Curve
- PDF can also be represented as a Cumulative Distribution Function (CDF), also known as an S-Curve to provide a graphical representation of the possibilities of various cost outcomes
- Cost risk analysis takes additional labor and is beyond a 1-week IDL study, and is not recommended for the initial IDL instrument conceptual design, but will be necessary for proposal development



# Cost Confidence Level

Integrated Design Capability / Instrument Design Laboratory



## Definition of Confidence Level (CL)

- X = Point estimate
- Z = Project requirement
- Y = Cost estimate where there is a 70% chance that final actual cost will be less than cost estimate
- Y-Z = Management reserve (MR) which is REQUIRED to meet 70% CL

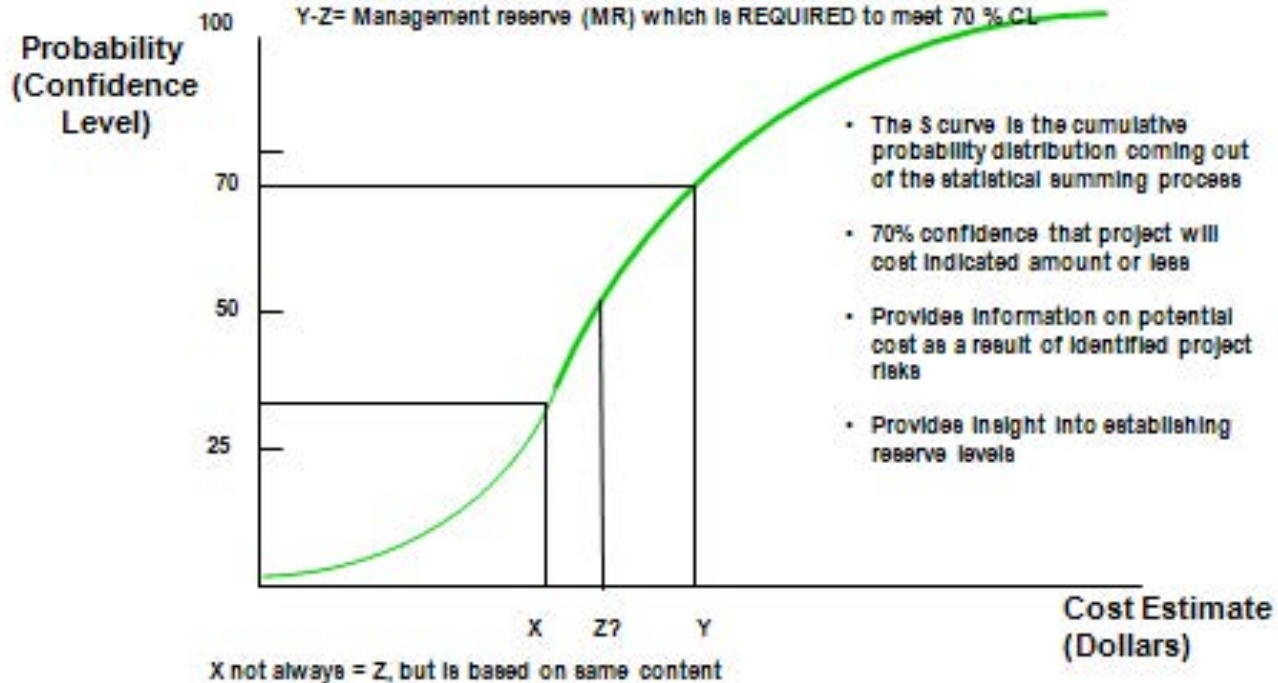

Selected Slide, Definition of Confidence Level (CL), from “NASA Cost Risk Workshop at GSFC”.



# GEO CAPE WAS Recommended Future Work



---

## Integrated Design Capability / Instrument Design Laboratory

1. Revisit parametric cost analysis when significant changes to mass and/or schedule are made.
2. Include costs for upsampling of Class B EEE parts
3. Project should make sure to carry Instrument contribution to WBS 10.0 (see summary).
4. Perform parametric cost-risk analysis once candidate design is close to being frozen. Bring updated 'frozen' MEL and charge number to Code 158 to initiate work—contact Sanjay Verma or Anthony McNair.



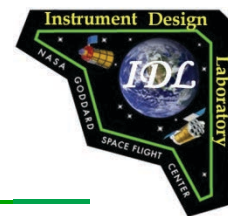

---

Integrated Design Capability / Instrument Design Laboratory

# DELTA DESIGN COST ESTIMATES





# WAS Mechanical Configurations

Integrated Design Capability / Instrument Design Laboratory

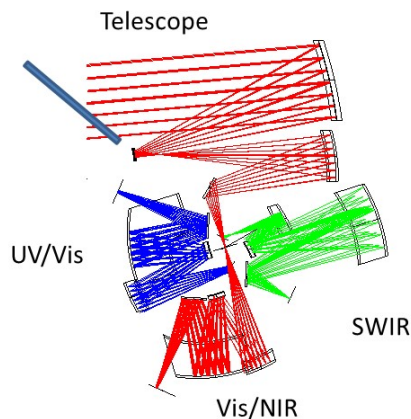

**Baseline**

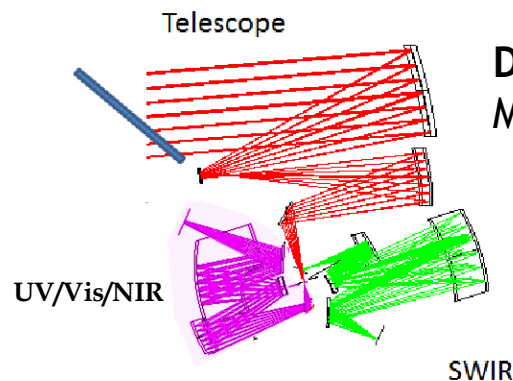

**Delta 2**  
Merge UV/Vis/NIR

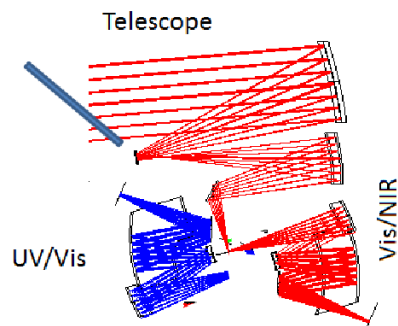

**Delta 1**  
no SWIR

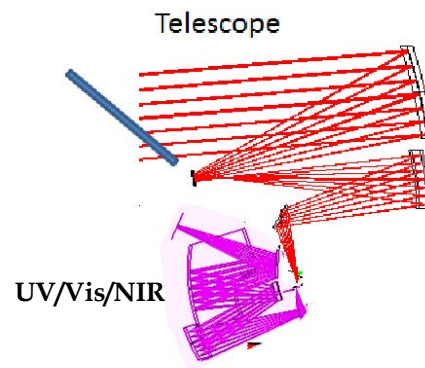

**Delta 3**  
Merge without SWIR

# Top Level Mass Summary for Delta Designs

## Integrated Design Capability / Instrument Design Laboratory

GeoCape WAS	Baseline	Case 1	Case 2	Case 3
	Mass (kg)	Mass (kg)	Mass (kg)	Mass (kg)
Science Aperture Baffle Assembly	9.9	9.9	9.9	9.9
Diffuser Select Assembly	46.5	46.5	46.5	46.5
Scan Mirror Assembly	34.0	34.0	34.0	34.0
Telescope Assembly	19.5	19.5	19.5	19.5
Internal Baffles	0.5	0.4	0.4	0.3
Common Mount Assembly	3.4	3.4	3.4	2.7
UV/Vis Channel	9.6	9.6	-	-
Vis/NIR Channel	10.2	10.2	-	-
UV/VIS/NIR Channel	-	-	10.1	10.1
SWIR Channel	11.4	-	11.4	-
Instrument Structure / Enclosure	111.9	98.4	98.4	84.5
UV/VIS/NIR Digitizer Box	3.0	3.0	3.0	3.0
SWIR Digitizer Box	1.1	0.0	1.1	0.0
Roll Camera	7.2	7.2	7.2	7.2
uASC Star Tracker	1.5	1.5	1.5	1.5
IMU Assembly	10.3	10.3	10.3	10.3
WAS Main Electronics box	7.1	7.1	7.1	7.1
Harness	14.4	14.0	14.4	13.9
Contamination Purge Hardware	2.0	2.0	2.0	2.0
Thermal Subsystem	30.2	27.5	30.1	27.4
5% Misc Hardware	16.7	15.2	15.5	14.0
<b>Total + 5% Misc Hardware</b>	<b>350.3</b>	<b>319.6</b>	<b>325.6</b>	<b>293.7</b>



# GEO CAPE WAS Delta 1 Parametric Cost Summary

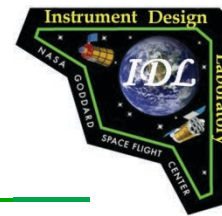

## Integrated Design Capability / Instrument Design Laboratory

### GEOCAPE Wide Angle Spectrometer (WAS) Delta 1 Summary

IDL Parametric Cost Estimate (IDL = Instrument Design Lab) (Development and Production Costs)	Flight Units = 1 Eng Design Units = 1 Cost Estimate (FY\$016)
PRICE-H Cost Model Summary 27-Aug-14  GEOCAPE WAS Instrument Delta 1 Assembly (319.14 kg) (319.14 Kg) <i>Science Aperture Baffle Assembly (9.88 kg)</i> <i>Diffuser Select Assembly (46.80 kg)</i> <i>Scan Mirror Assembly (33.97 kg)</i> <i>Telescope Assembly (19.54 kg)</i> <i>Internal Baffles Assembly (0.39 kg)</i> <i>Common Mount Assembly (3.39 kg)</i> <i>UV/Vis Channel Assembly (9.64 kg)</i> <i>Vis/NIR Channel Assembly (10.23 kg)</i> <i>Instrument Structure/Enclosure Assembly (98.38 kg)</i> <i>UV/VIS/NIR Digitizer Box (Qty 2, 1.49 kg ea)</i> <i>Roll Camera Assembly (4.49 kg)</i> <i>uASC Star Tracker (1.50 kg)</i> <i>IMU Assembly (10.25 kg)</i> <i>WAS Main Electronics Box (MEB) Assembly (7.05 kg)</i> <i>Harness Assembly (13.98 kg)</i> <i>Contamination Purge Hardware (SS ,TRL 6)</i> <i>Thermal Subsystem Assembly (29.47 kg)</i> <i>5% Misc H/W (SS ,TRL 7)</i> GEOCAPE WAS Instrument Assembly Integration and Test	\$110,331,295  \$2,090,012 \$9,570,386 \$13,690,010 \$10,815,177 \$233,572 \$4,125,431 \$6,752,884 \$7,318,080 \$14,353,261 \$2,028,298 \$4,632,296 \$3,538,035 \$4,818,392 \$12,811,403 \$2,848,149 \$427,129 \$6,451,601 \$1,372,270 \$2,454,909
Optical Nickel Plating NRE - IDL Estimate Blue and Red CCDs - SEER-H Estimate Roll Camera Modification Life Cycle Cost - IDL Grassroots Estimate	\$197,523 \$2,323,919 \$1,390,637
PRICE-H Instrument Payload Estimate	\$114,243,373

\* Cost of I&T at Indenture Level 2 Assembly only--See Instrument details tab for other I&T costs



Continued on next page



# GEO CAPE WAS Delta 1 Parametric Cost Summary



## Integrated Design Capability / Instrument Design Laboratory



The Following are NOT PRICE-H estimates but are derived from PRICE-H estimates. These are included for completeness and are considered ROM 'Grass-roots' estimates. Consult the Grass-roots estimating organization for a more accurate estimate.

Flight Software (SEER-SEM Estimate based on SLOC Table from IDL)	\$2,318,507
Flight Software Sustaining Engineering (SEER-SEM Estimate based on SLOC Table from IDL, Include in WBS 7.0 = \$1.24M)	<< see note
Total FSW Testbed GSE (Grassroots)	\$899,175
FPGA Development (6 Unique FPGAs @ \$430K ea & 7 Unique Algorithms @ \$430K ea identified)	\$5,590,000
Ground Support Equipment (GSE) (5% of Instrument Cost Estimate)	\$5,712,169
Environmental Testing (5% of Instrument Cost Estimate)	\$5,712,169
Flight Spares (10% of Instrument Cost Estimate)	\$11,424,337
Engineering Test Unit (ETU) (10% of Instrument Cost Estimate)	\$11,424,337
Instrument to S/C Bus Integration & Test (5% of Instrument Cost Estimate, Typically Included in WBS 10.0=\$5.64M)	<< see note
<b>Instrument Subtotal</b>	<b>\$157,324,068</b>
<b>Institutional Charges (Basis of Estimate: 0% GSFC CM&amp;O)</b> (For GSFC, Contact Code 153 to verify applicability to your project)	N/A
<b>WBS 5.0 Instrument Point Estimate for Point Design - Does not include Cost Risk</b>	<b><u>\$157,324,068</u></b>



# GEO CAPE WAS Delta 2 Parametric Cost Summary

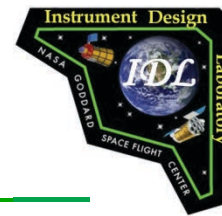

## Integrated Design Capability / Instrument Design Laboratory

### GEOCAPE Wide Angle Spectrometer (WAS) Delta 2 Summary

IDL Parametric Cost Estimate (IDL = Instrument Design Lab) (Development and Production Costs)	Flight Units = 1 Eng Design Units = 1 Cost Estimate (FY\$016)
<b>PRICE-H Cost Model Summary</b> 27-Aug-14	
GEOCAPE WAS Instrument Delta2 Assembly (326.95 kg) (326.95 Kg)	<b>\$115,122,579</b>
<i>Science Aperture Baffle Assembly (9.88 kg)</i>	\$2,090,012
<i>Diffuser Select Assembly (46.80 kg)</i>	\$9,570,386
<i>Scan Mirror Assembly (33.97 kg)</i>	\$13,690,010
<i>Telescope Assembly (19.54 kg)</i>	\$10,815,177
<i>Internal Baffles Assembly (0.39 kg)</i>	\$233,572
<i>Common Mount Assembly (3.39 kg)</i>	\$4,125,431
<i>UV/Vis/NIR Channel Assembly (10.14 kg)</i>	\$7,674,013
<i>SWIR Channel Assembly (11.38 kg)</i>	\$8,451,891
<i>Instrument Structure/Enclosure Assembly (98.38 kg)</i>	\$14,353,261
<i>UV/VIS/NIR Digitizer Box (Qty 2, 1.49 kg ea)</i>	\$2,028,298
<i>SWIR Digitizer Box (1.19 kg)</i>	\$1,524,768
<i>Roll Camera Assembly (4.49 kg)</i>	\$4,632,296
<i>uASC Star Tracker (1.50 kg)</i>	\$3,538,035
<i>IMU Assembly (10.25 kg)</i>	\$4,818,392
<i>WAS Main Electronics Box (MEB) Assembly (7.05 kg)</i>	\$12,811,403
<i>Harness Assembly (14.04 kg)</i>	\$2,983,003
<i>Contamination Purge Hardware (SS , TRL 6)</i>	\$427,129
<i>Thermal Subsystem Assembly (33.44 kg)</i>	\$7,417,370
<i>5% Misc H/W (SS , TRL 7)</i>	\$1,397,199
<i>GEOCAPE WAS Instrument Assembly Integration and Test</i>	\$2,540,932
<i>Optical Nickel Plating NRE - IDL Estimate</i>	\$197,523
<i>Purple CCDs - SEER-H Estimate</i>	\$2,303,688
<i>Teledyne HAWAII-4RG HgCd - SEER-H Estimate</i>	\$15,228,490
<i>Roll Camera Modification Life Cycle Cost - IDL Grassroots Estimate</i>	\$1,390,637
<b>PRICE-H Instrument Payload Estimate</b>	<b><u>\$134,242,917</u></b>

\* Cost of I&T at Indenture Level 2 Assembly only--See Instrument details tab for other I&T costs

Continued on next page



# GEO CAPE WAS Delta 2 Parametric Cost Summary



## Integrated Design Capability / Instrument Design Laboratory



<p>The Following are NOT PRICE-H estimates but are derived from PRICE-H estimates. These are included for completeness and are considered ROM 'Grass-roots' estimates. Consult the Grass-roots estimating organization for a more accurate estimate.</p>	
Flight Software (SEER-SEM Estimate based on SLOC Table from IDL)	\$2,351,212
Flight Software Sustaining Engineering (SEER-SEM Estimate based on SLOC Table from IDL, Include in WBS 7.0 = \$1.24M)	<< see note
Total FSW Testbed GSE (Grassroots)	\$899,175
FPGA Development (7 Unique FPGAs @ \$430K ea & 7 Unique Algorithms @ \$430K ea identified)	\$6,020,000
ASIC Code Development (Grassroots)	\$1,628,917
Ground Support Equipment (GSE) (5% of Instrument Cost Estimate)	\$6,712,146
Environmental Testing (5% of Instrument Cost Estimate)	\$6,712,146
Flight Spares (10% of Instrument Cost Estimate)	\$13,424,292
Engineering Test Unit (ETU) (10% of Instrument Cost Estimate)	\$13,424,292
Instrument to S/C Bus Integration & Test (5% of Instrument Cost Estimate, Typically Included in WBS 10.0=\$6.64M)	<< see note
<b>Instrument Subtotal</b>	<b>\$185,415,096</b>
<b>Institutional Charges (Basis of Estimate: 0% GSFC CM&amp;O)</b> (For GSFC, Contact Code 153 to verify applicability to your project)	N/A
<b>WBS 5.0 Instrument Point Estimate for Point Design - Does not include Cost Risk</b>	<b>\$185,415,096</b>





# GEO CAPE WAS Delta 3 Parametric Cost Summary

## Integrated Design Capability / Instrument Design Laboratory

### GEOCAPE Wide Angle Spectrometer (WAS) Delta 3 Summary

IDL Parametric Cost Estimate (IDL = Instrument Design Lab) (Development and Production Costs)	Flight Units = 1 Eng Design Units = 1 Cost Estimate (FY\$016)
PRICE-H Cost Model Summary 27-Aug-14	
GEOCAPE WAS Instrument Delta3 Assembly (296.75 kg) (296.75 Kg)	<b>\$101,875,662</b>
<i>Science Aperture Baffle Assembly (9.88 kg)</i>	\$2,090,012
<i>Diffuser Select Assembly (46.80 kg)</i>	\$9,570,386
<i>Scan Mirror Assembly (33.97 kg)</i>	\$13,690,010
<i>Telescope Assembly (19.54 kg)</i>	\$10,815,177
<i>Internal Baffles Assembly (0.26 kg)</i>	\$157,471
<i>Common Mount Assembly (2.68 kg)</i>	\$3,568,053
<i>UV/Vis/NIR Channel Assembly (10.14 kg)</i>	\$7,674,013
<i>Instrument Structure/Enclosure Assembly (88.11 kg)</i>	\$13,273,495
<i>UV/VIS/NIR Digitizer Box (Qty 2, 1.49 kg ea)</i>	\$2,028,298
<i>Roll Camera Assembly (4.49 kg)</i>	\$4,632,296
<i>uASC Star Tracker (1.50 kg)</i>	\$3,538,035
<i>IMU Assembly (10.25 kg)</i>	\$4,818,392
<i>WAS Main Electronics Box (MEB) Assembly (7.05 kg)</i>	\$12,811,403
<i>Harness Assembly (13.88 kg)</i>	\$2,766,147
<i>Contamination Purge Hardware (SS ,TRL 6)</i>	\$427,129
<i>Thermal Subsystem Assembly (29.27 kg)</i>	\$6,361,070
<i>5% Misc H/W (SS ,TRL 7)</i>	\$1,288,174
<i>GEOCAPE WAS Instrument Assembly Integration and Test</i>	\$2,366,102
Optical Nickel Plating NRE - IDL Estimate	\$197,523
Purple CCDs - SEER-H Estimate	\$2,303,688
Roll Camera Modification Life Cycle Cost - IDL Grassroots Estimate	\$1,390,637
<b>PRICE-H Instrument Payload Estimate</b>	<b>\$105,767,509</b>

\* Cost of I&T at Indenture Level 2 Assembly only--See Instrument details tab for other I&T costs

Continued on next page



# GEO CAPE WAS Delta 3 Parametric Cost Summary

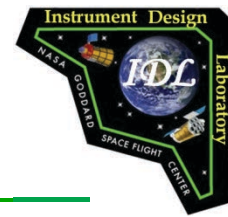

## Integrated Design Capability / Instrument Design Laboratory



<p>The Following are NOT PRICE-H estimates but are derived from PRICE-H estimates. These are included for completeness and are considered ROM 'Grass-roots' estimates. Consult the Grass-roots estimating organization for a more accurate estimate.</p>	
Flight Software (SEER-SEM Estimate based on SLOC Table from IDL)	\$2,318,507
Flight Software Sustaining Engineering (SEER-SEM Estimate based on SLOC Table from IDL, Include in WBS 7.0 = \$1.24M)	<< see note
Total FSW Testbed GSE (Grassroots)	\$899,175
FPGA Development (6 Unique FPGAs @ \$430K ea & 7 Unique Algorithms @ \$430K ea identified)	\$5,590,000
Ground Support Equipment (GSE) (5% of Instrument Cost Estimate)	\$5,288,375
Environmental Testing (5% of Instrument Cost Estimate)	\$5,288,375
Flight Spares (10% of Instrument Cost Estimate)	\$10,576,751
Engineering Test Unit (ETU) (10% of Instrument Cost Estimate)	\$10,576,751
Instrument to S/C Bus Integration & Test (5% of Instrument Cost Estimate, Typically Included in WBS 10.0=\$5.22M)	<< see note
<b>Instrument Subtotal</b>	<b>\$146,305,444</b>
<b>Institutional Charges (Basis of Estimate: 0% GSFC CM&amp;O)</b> (For GSFC, Contact Code 153 to verify applicability to your project)	N/A
<b>WBS 5.0 Instrument Point Estimate for Point Design - Does not include Cost Risk</b>	<b><u>\$146,305,444</u></b>





# Configuration Modifications for Delta Designs

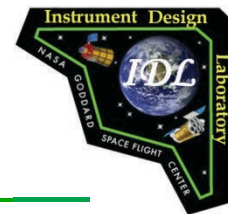

Integrated Design Capability / Instrument Design Laboratory

	Baseline	Case 1	Case 2	Case 3
UV/VIS - Blue Channel	X	X		
VIS/NIR - Red Channel	X	X		
UV/VIS/NIR - Purple Channel			X	X
SWIR Channel	X		X	
<b>COST</b> (WBS 5.0 point estimate in FY16\$M)	196.3	157.3	185.4	146.3



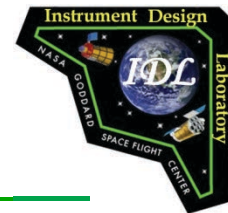

---

## Integrated Design Capability / Instrument Design Laboratory

# BACKUP



# WAS Block Diagram



Integrated Design Capability / Instrument Design Laboratory

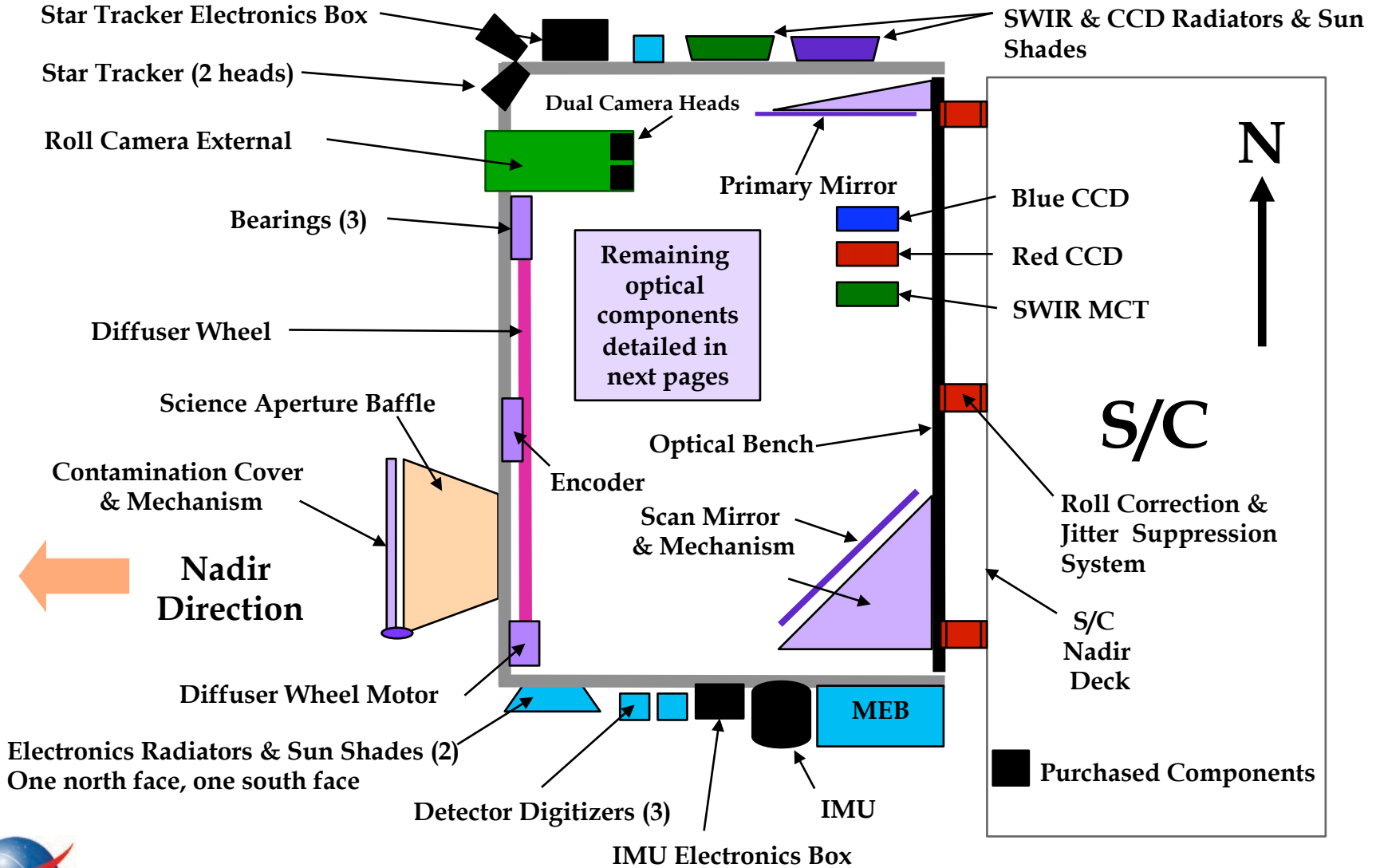

# WAS Mechanical Design

Integrated Design Capability / Instrument Design Laboratory

