

Loop Heat Pipe Temperature Oscillation Induced by Gravity Assist and Reservoir Heating

Jentung Ku, Matt Garrison, Deepak Patel

Frank Robinson, Laura Ottenstein

NASA/GSFC

Code 545

301-286-3130

Jentung.Ku-1@nasa.gov

45th International Conference on Environmental Systems

Bellevue, Washington, July 13 – 16, 2015

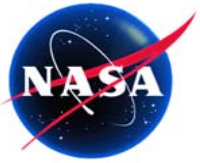

Outline

- **Introduction/Background**
- **A Theory for Temperature Oscillation Induced by Gravity Assist and Reservoir Heating**
- **ICESat-2 ATLAS LTCS TV Test Results**
- **Summary and Conclusions**

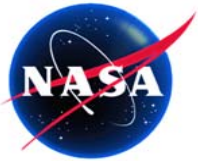

Introduction

- **During ICESat-2 ATLAS LTCS TV testing, the laser mass simulators could not be controlled at desired set point temperatures.**
- **The LHP reservoir control heaters appeared to be under-sized despite flight analysis showing no issue.**
- **An investigation of the LHP behaviors found that the root cause of the problem was the temperature oscillation of the reservoir, which was in turn caused by gravity assist and continuous reservoir heating.**
- **Results of the investigation are presented.**

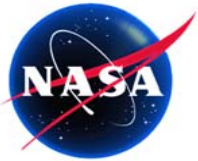

ICESat-2 and ATLAS

- Ice, Cloud and land Elevation Satellite-2 (ICESat-2) is an earth observing satellite expected to launch in 2016.
- The Advanced Topographic Laser Altimeter System (ATLAS) will estimate sea ice thickness and measure vegetation canopy height.
- Only one of the two redundant lasers in ATLAS will be used at a time. These lasers have stringent thermal control requirements.
- The thermal control system were designed and fabricated while the ATLAS lasers were being developed.

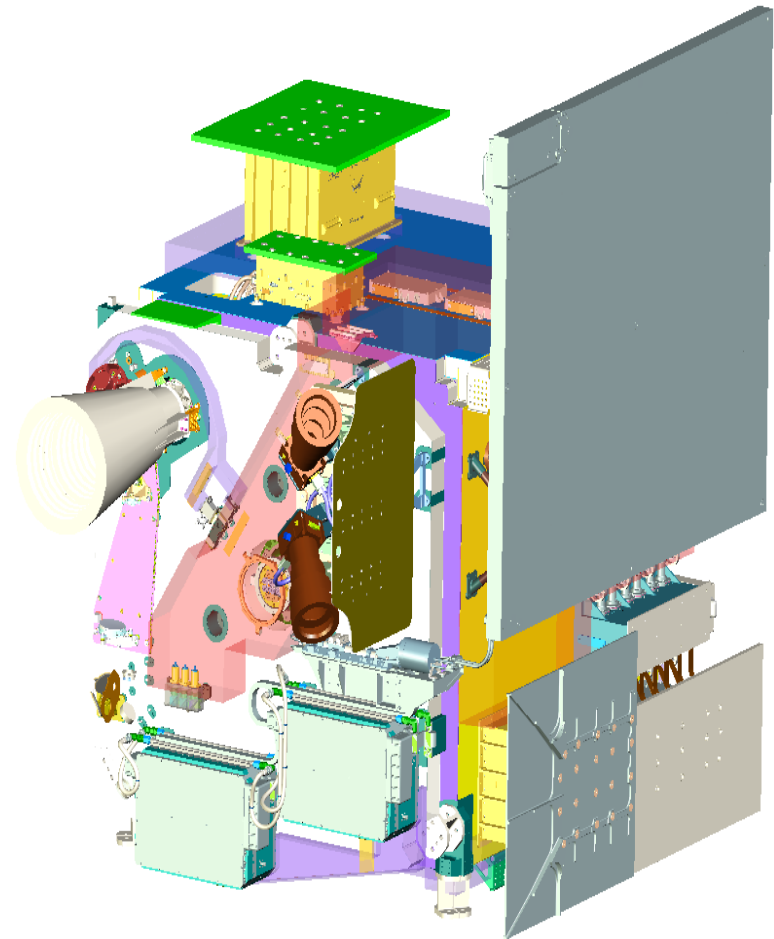

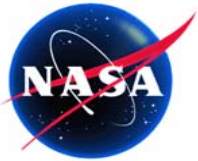

ATLAS Laser Thermal Control System (LTCS)

Redundant lasers are cooled via a single Laser Thermal Control System (LTCS) consisting of a constant conductance heat pipe (CCHP), a loop heat pipe (LHP), and a radiator.

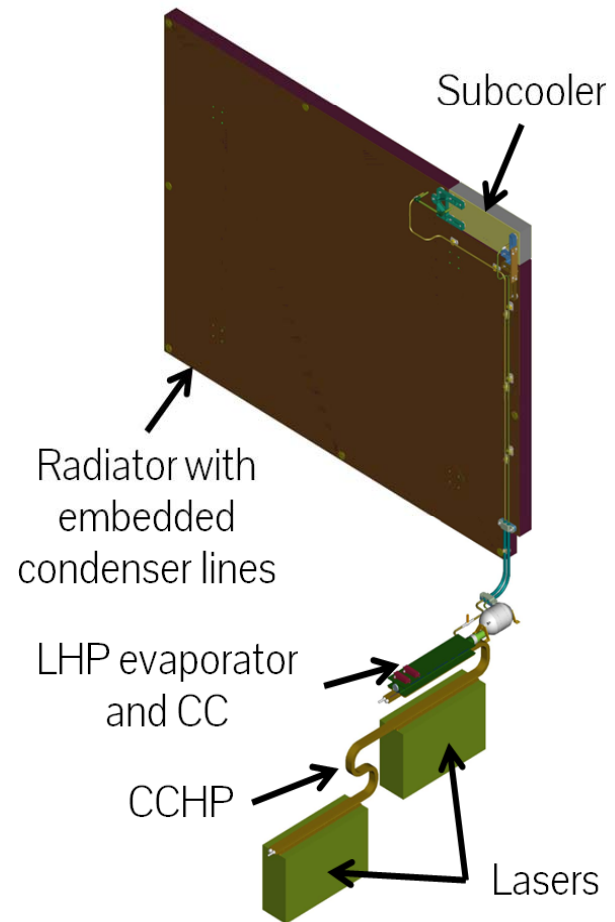
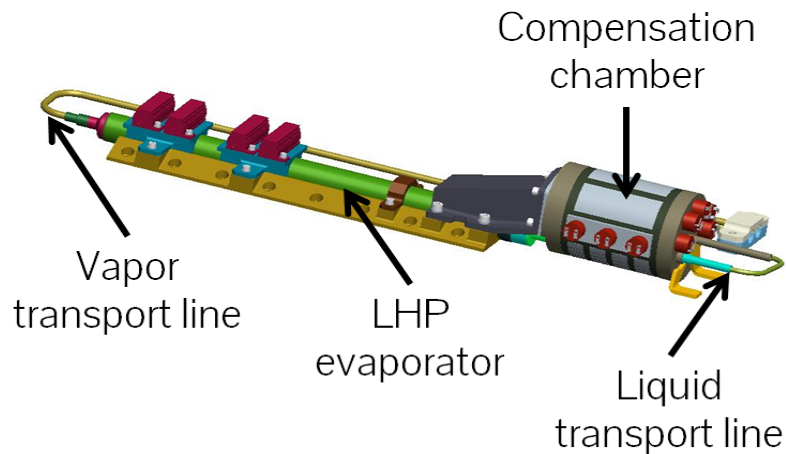

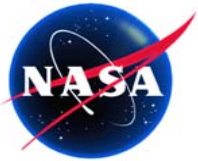

High Reservoir Control Heater Power

- In thermal balance tests, using 100% of the available heater power could not maintain the commanded reservoir temperature.
- One example:
 - 136W laser, -101 °C shroud
 - Expected Laser 1 simulator to run at +10 °C (and reservoir at +4°C) with 10.6W control power based on ATK analysis at CDR
 - Test results: Laser 1 simulator ran at -14 °C (reservoir at -24 °C) with 22W control heater power
- The reservoir displayed persistent temperature oscillations.

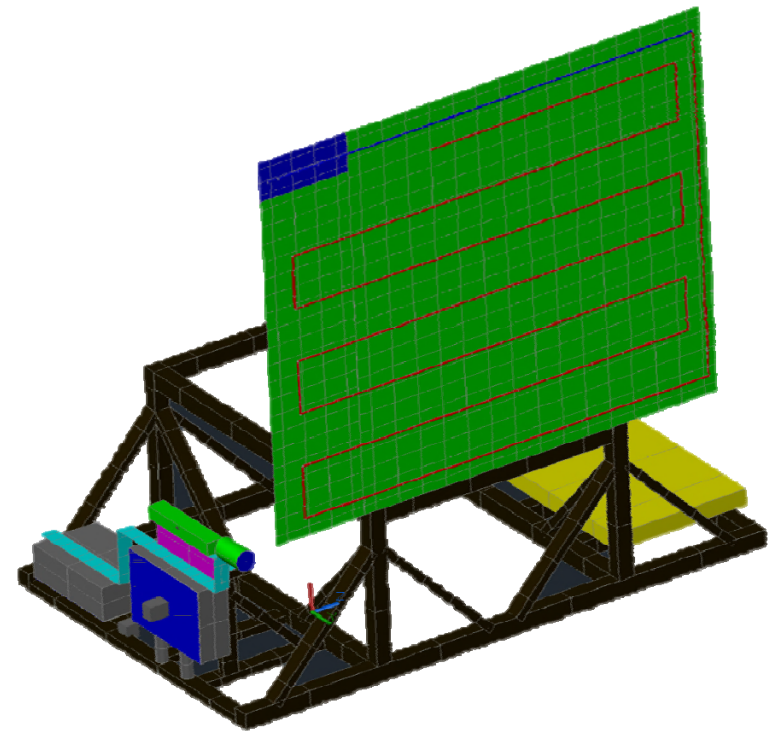

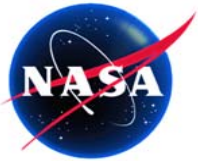

Theory for Temperature Oscillation with Gravity Assist and Reservoir Heating

- **A theory has been developed to explain the temperature oscillation and high control heater power requirement based on:**
 - **Mass, momentum and energy balance**
 - **LHP operating principles**
- **The theory is presented in the following order:**
 - **Pressure drop diagrams in LHP operation**
 - **Thermodynamic constraints in two-phase systems**
 - **Reservoir energy balance**
 - **Physical processes involved during temperature oscillation**
 - **Conditions leading to persistent temperature oscillation**
 - **Relevant ATLAS LTCS TV test data that partially verify the theory**

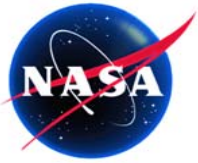

Pressure Profile in Gravity-Neutral LHP Operation Capillary Force Driven

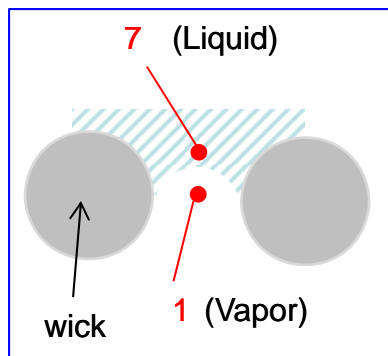
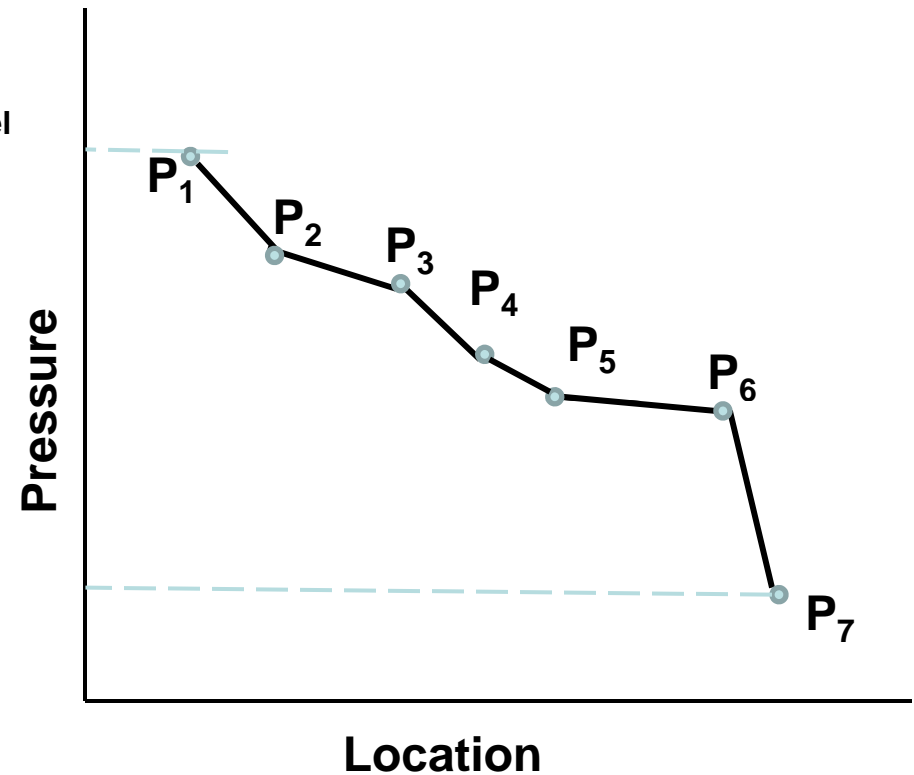
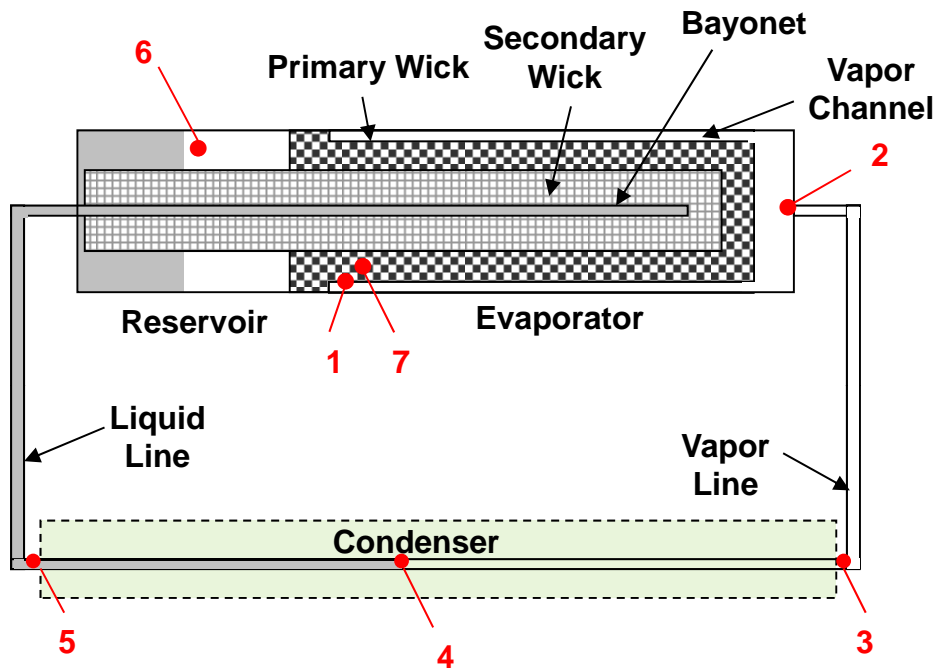

- Evaporator core is considered part of reservoir.
- P_6 is the reservoir saturation pressure.
- All other pressures are governed by P_6
- All pressure drops are viscous pressure drops.

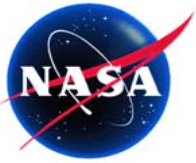

Simplified Pressure Profile in Gravity-Assist LHP Operation - Capillary Force and Gravity Co-Driven

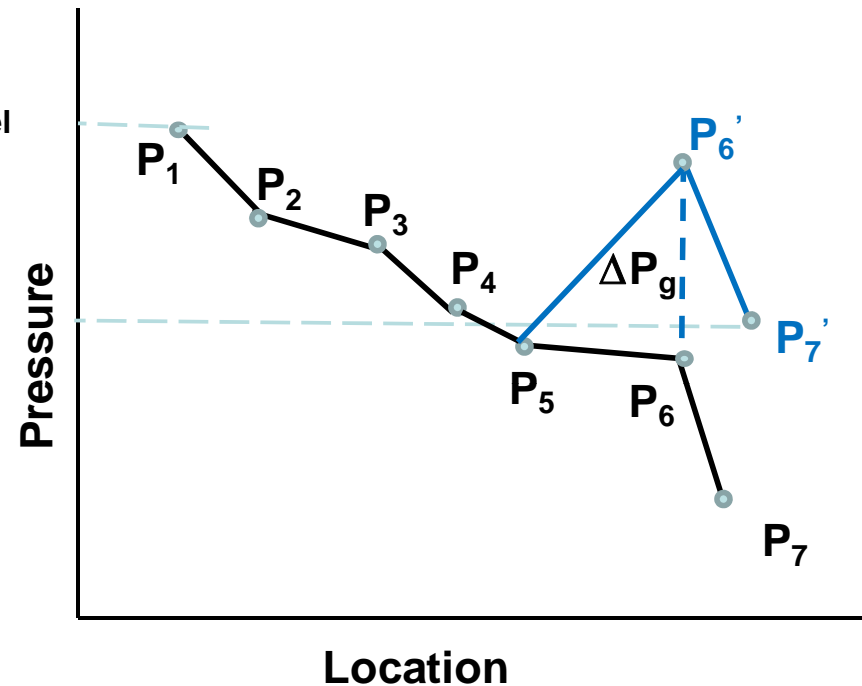
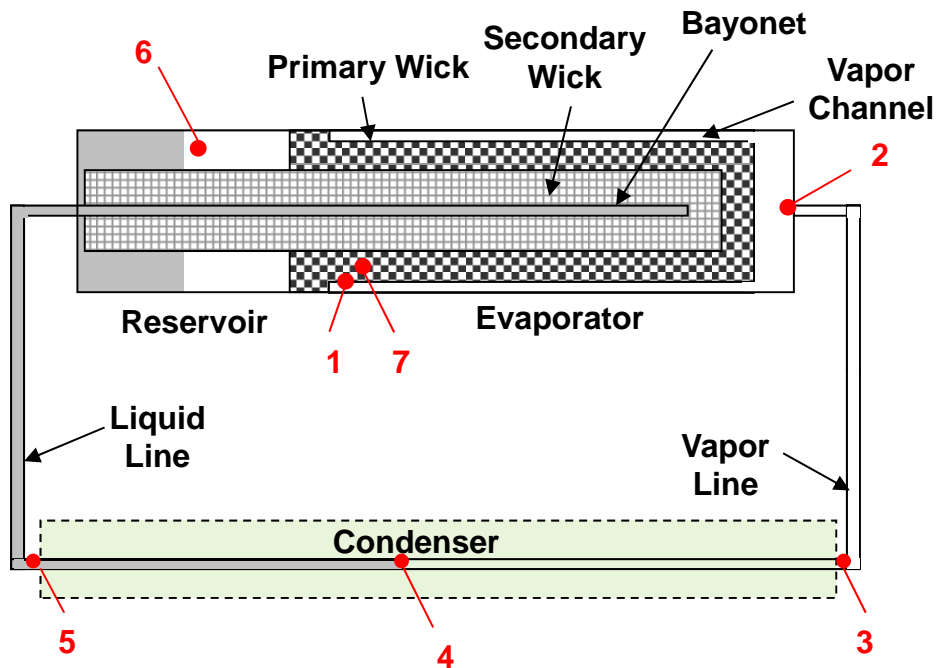

- Heat load > threshold heat load (vapor line contains all vapor).
- Gravity assist raises the reservoir pressure from P_6 to P_6'
- All other pressures are governed by P_6'
- Viscous pressure drops remain practically the same.
- Maximum heat transport capability increases compared to no gravity.

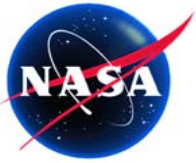

Pressure-Temperature Constraints in LHP Operation

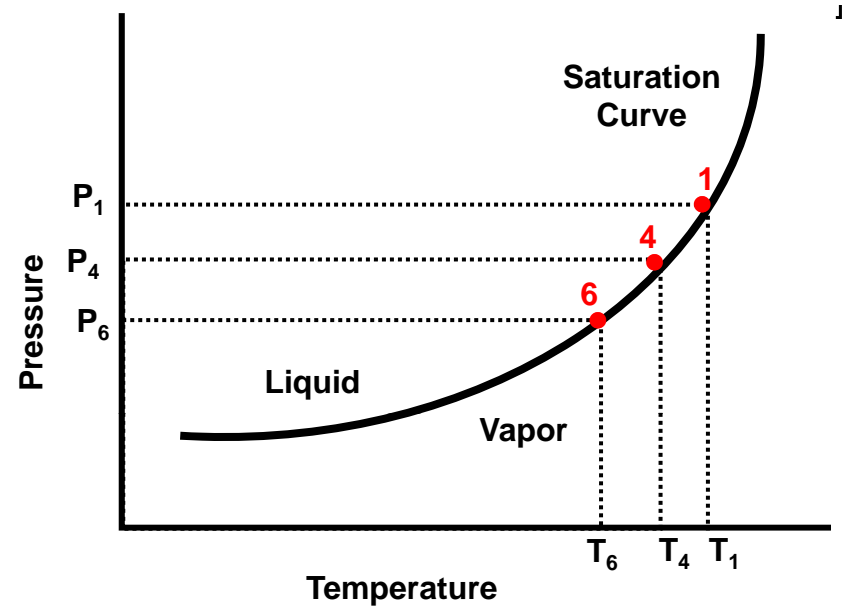
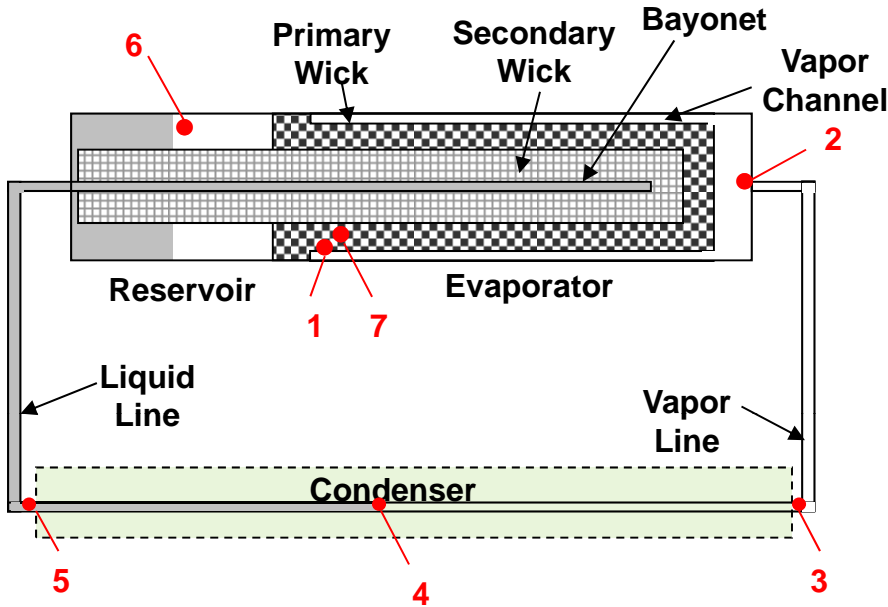

$$P_E - P_{\text{cond}} = (dP/dT) (T_E - T_{\text{cond}})$$

$$P_{\text{cond}} - P_{\text{cc}} = (dP/dT) (T_{\text{cond}} - T_{\text{cc}})$$

$$P_E - P_{\text{cc}} = (dP/dT) (T_E - T_{\text{cc}})$$

- These constraints can be used for loop operating temperature control and loop shutdown.

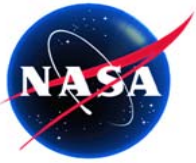

Pressure Profile in LHP Operation Liquid Reverse Flow/Gravity Assist

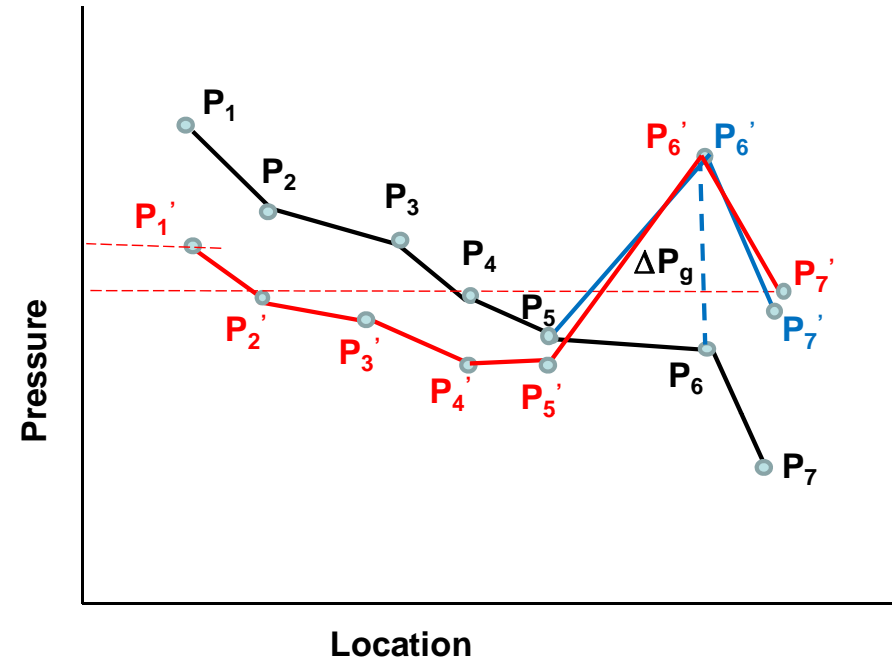
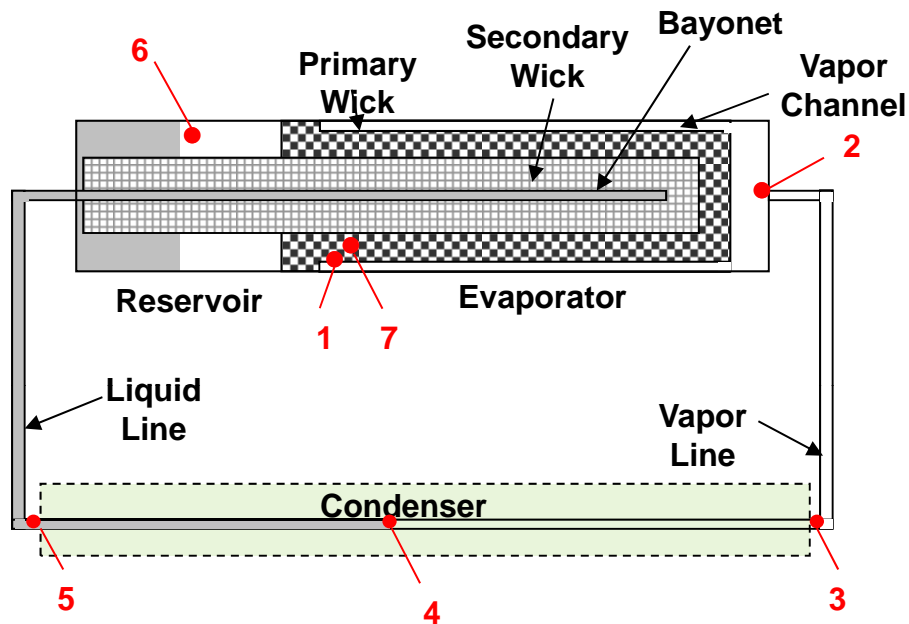

- Absolute pressures with a reverse liquid flow are shown in red.
- When T_6 rises faster than T_1 , P_6' also rises faster than P_1' and P_4'
- Reverse flow will begin when the difference between P_6' and P_4' (due to temperature difference in T_6 and T_4) exceeds what is needed to support the liquid column on the liquid line.

$$P_{cc} - P_{cond} = (dP/dT) (T_{cc} - T_{cond})$$

- The loop will shut down when $P_7' > P_1'$.

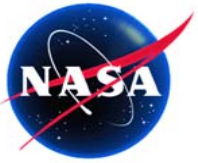

Gravity Pressure Head with a Vertical Radiator

$$\Delta P_g = (\rho_l - \rho_v)g \Delta H$$
$$\Delta H = H - h$$

ΔH and ΔP_g vary with the vapor front position.

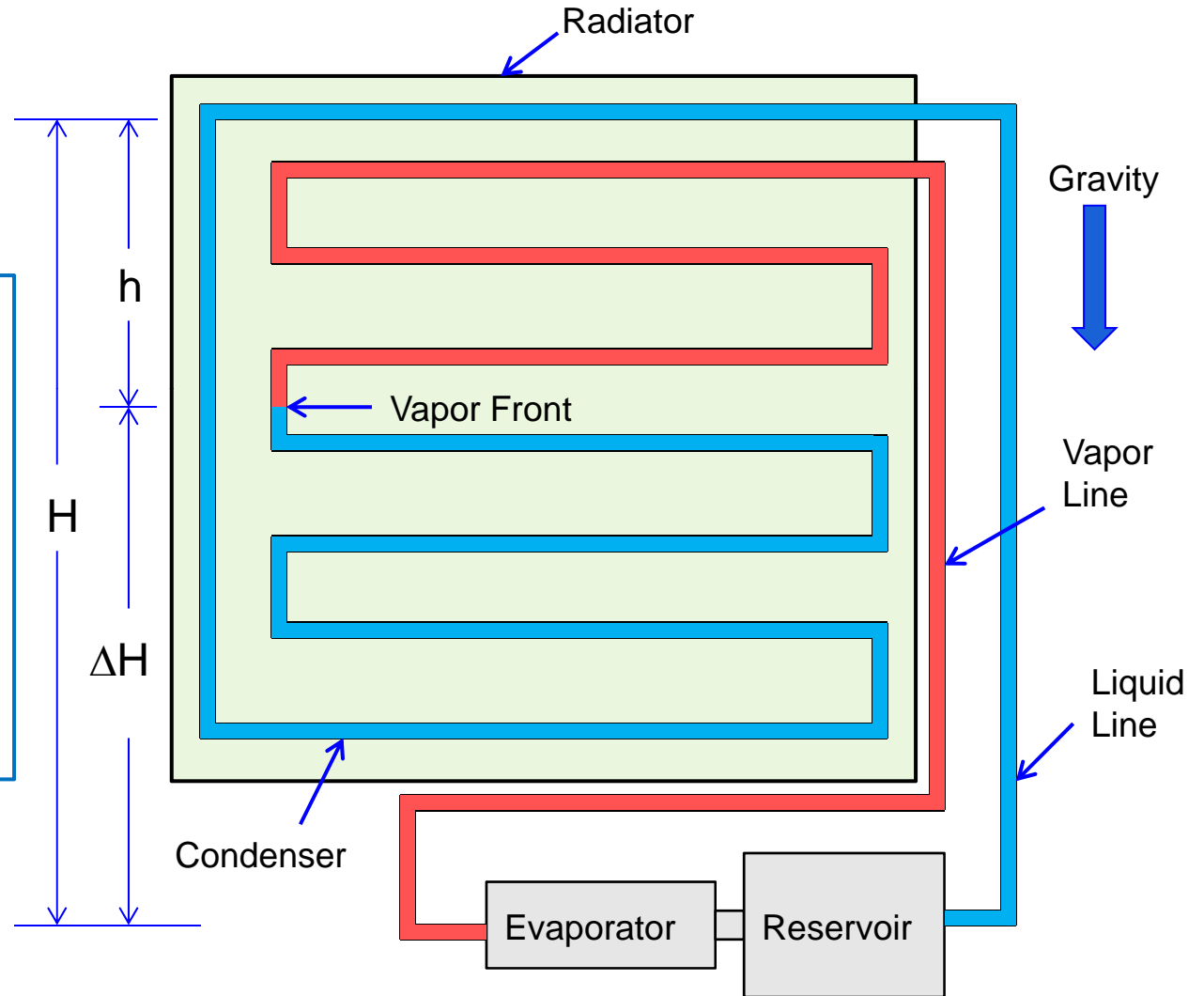

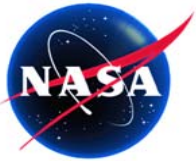

Energy Balance in Reservoir

- For steady state operation:

$$Q_{CC} = Q_{sub} - Q_{leak}$$

$$Q_{sub} = m_{liq} C_p (T_{cc} - T_{in})$$

$$m_{liq} = (Q_E - Q_{leak}) / \lambda$$

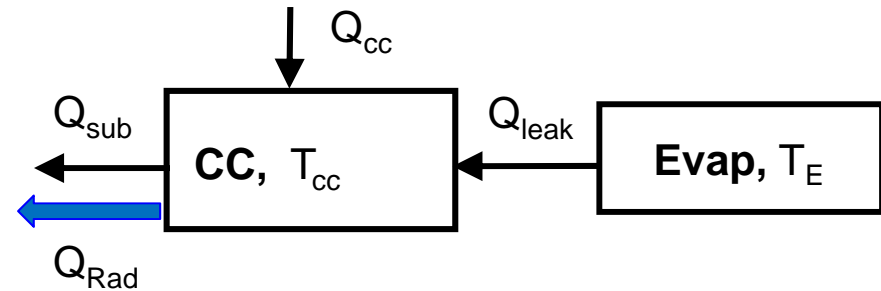

- m_{liq} is not constant during temperature oscillation.
 - m_{liq} and Q_{sub} are increasing when T_{cc} is decreasing.
 - A reverse liquid flow occurs when T_{cc} is increasing, carrying warm fluid to the condenser.
 - Q_{rad} represents additional heat leak during temperature oscillation compared to steady state.
- During quasi-steady of temperature oscillation*:
Total energy loss as reservoir temperature drops from its peak to valley = Total energy provided by control heater as reservoir temperature rises from its valley to peak

*The control heater is turned on at all times with persistent temperature oscillation.

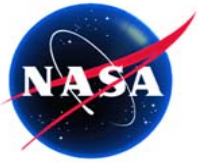

Physical Processes during Temperature Oscillation

Reservoir Temperature Decreasing

- When the reservoir temperature decreases, the evaporator temperature also decreases.
- Because of an increasing temperature gradient, the thermal mass releases sensible heat, increasing heat load to evaporator.

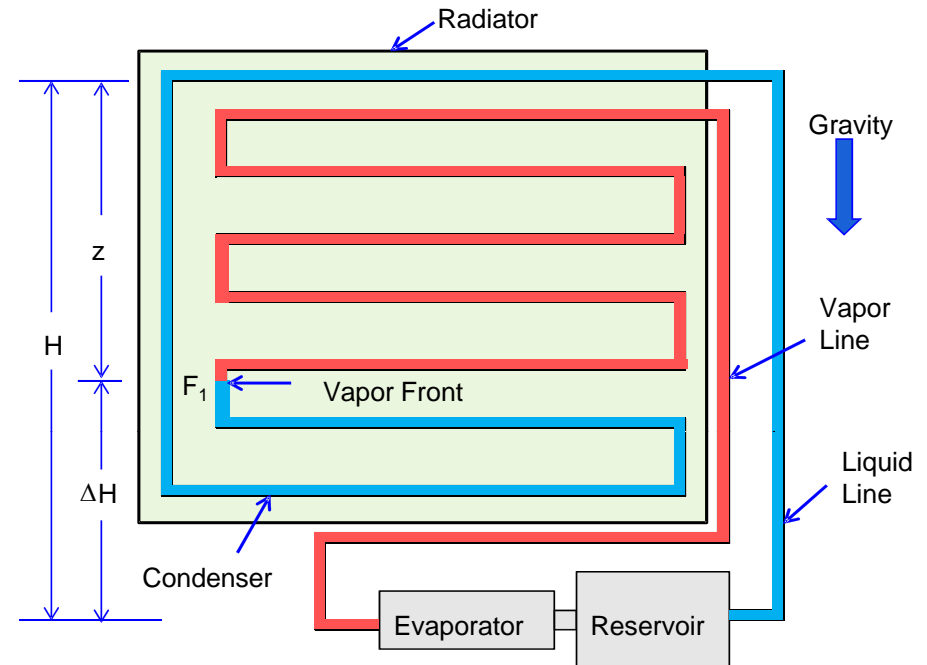

- Vapor front inside condenser advances with increasing heat load and decreasing reservoir temperature.
- Liquid mass flow rate increases; reservoir temperature drops further.
- Liquid mass flow rate is greater than vapor mass flow rate.
- Vapor front will stop advancing because of energy balance requirement in condenser and the decreased gravity pressure head.
- Control heater is always turned on. Reservoir temperature begins to increase.

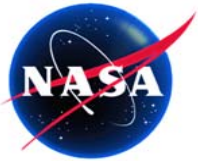

Physical Processes during Temperature Oscillation

Reservoir Temperature Increasing

- When reservoir temperature increases, thermal mass stores sensible heat.
- With a decreasing heat load and increasing reservoir temperature, vapor front recedes.
- Control heater causes reverse liquid flow along liquid line, filling the space left by vapor front recession.
- Vapor and liquid flow in opposite directions.
- As vapor front recedes, gravity pressure head increases, slowing down the rate of reverse liquid flow.
- Because a certain length is required to dissipate heat load from evaporator, vapor length reaches it minimum.
- Vapor front stops receding and starts advancing.
- Liquid drops from condenser to reservoir. Reservoir temperature begins to decrease, repeating the temperature oscillation cycles.

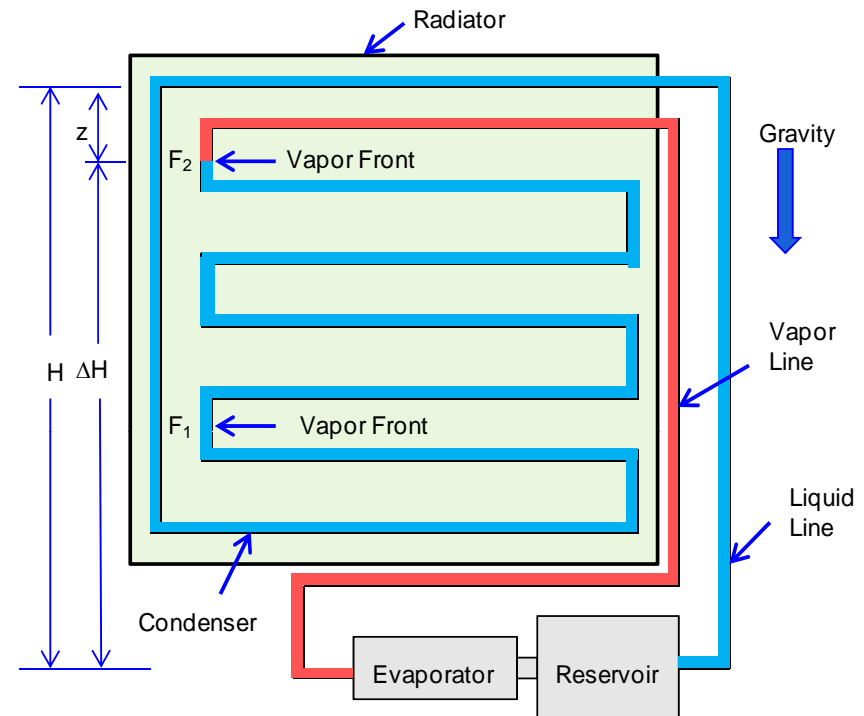

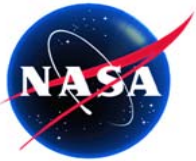

Sustaining Persistent Temperature Oscillation

- **Three driving forces interact to sustain the temperature oscillation:**
 - Heat load to evaporator
 - Reservoir heater power
 - Gravity
- Reservoir heater power is large enough to cause a liquid reverse flow, but not large enough to reach reservoir set point temperature.
- Cold radiator and large thermal mass amplify the effect of these driving forces.
- The vapor front moves back and froth between positions F_1 and F_2 .
- Causes and effects of temperature oscillation intermingled, leading to a “circular” mechanism.
- If the reservoir set point temperature can be maintained, there will be no persistent temperature oscillation.

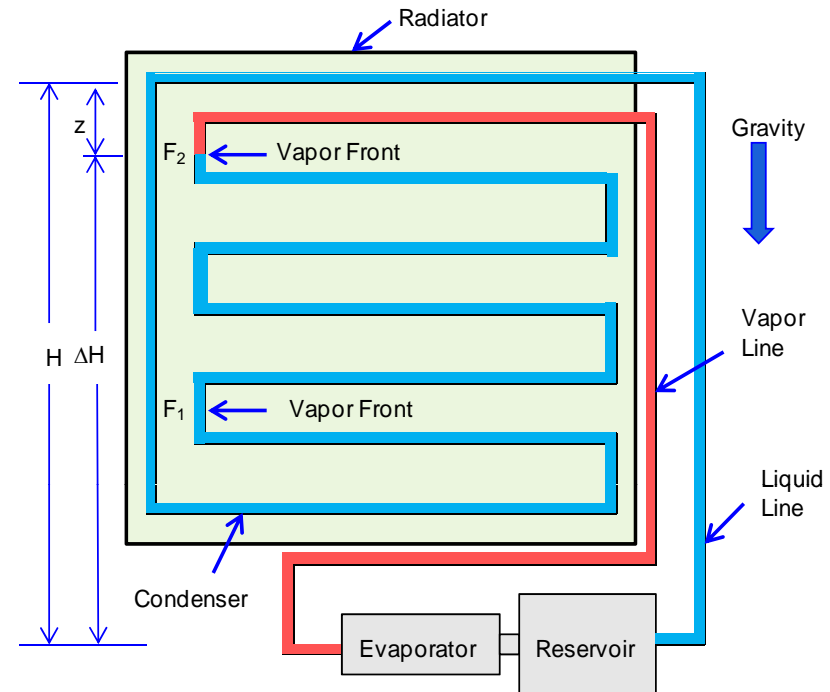

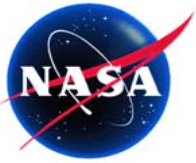

Root Cause of High Control Heater Power

- When the reservoir temperature is decreasing, cold liquid drops from the cold radiator .
- When the reservoir temperature is increasing, a reverse liquid flow occurs, carrying some warm liquid to the cold radiator.
 - Before the reservoir set point temperature can be reached, the next round of cold liquid is injected into the reservoir.

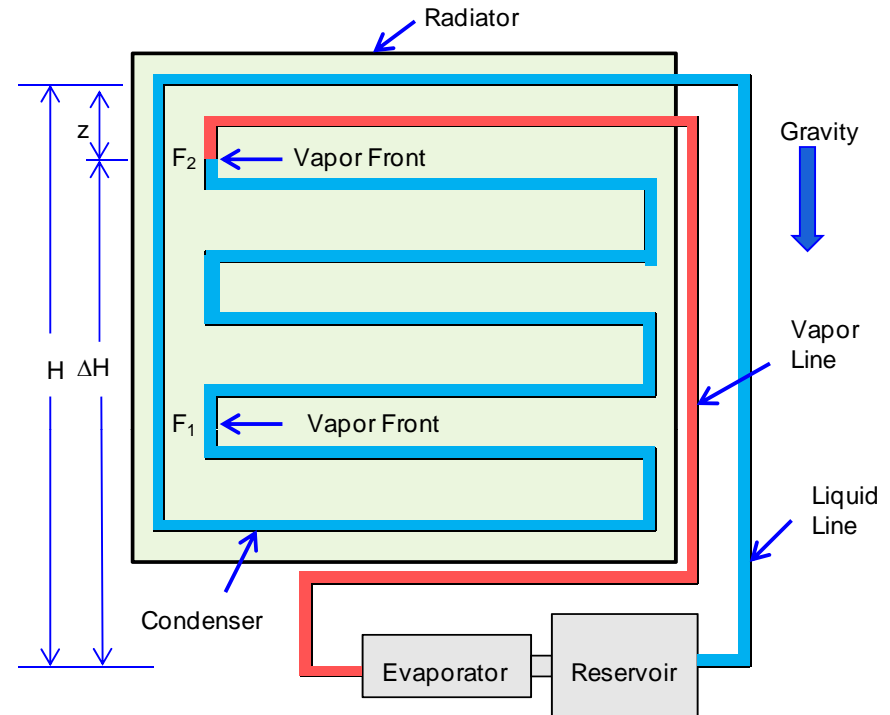

- The control heater is tuned on at all times, and its power is consumed largely to warm the reservoir toward its set point temperature which cannot be reached with existing heater power.
- The persistent reservoir temperature oscillation is the root cause of high control heater power requirement.

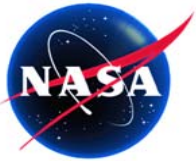

Verification of the Theory with ATLAS LTCS TV Test Data

- **The theory cannot be fully verified by the existing ATLAS LTCS TV test data.**
 - **No temperature sensors on the condenser itself**
 - **Data collection rate of once every two minutes is not sufficient to verify LHP transient behaviors**
- **Some relevant data are used to provide partial verification of the theory.**
- **Part of the theory that was verified by ATLAS LTCS test data.**
 - **Liquid drainage from the condenser to the reservoir**
 - **Reverse liquid flow**
 - **No persistent temperature oscillation without sufficient reservoir heater power**
 - **Effects of some parameters on temperature oscillation**
- **Part of the theory that cannot be verified by ATLAS LTCS test data.**
 - **Vapor front movement**
 - **Mass and energy balance in the reservoir**
 - **No persistent temperature oscillation if the reservoir set point can be maintained.**

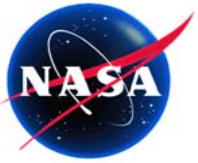

ATLAS LTCS TV Test Setup Schematic

Heat pipe and LHP both operating in reflux

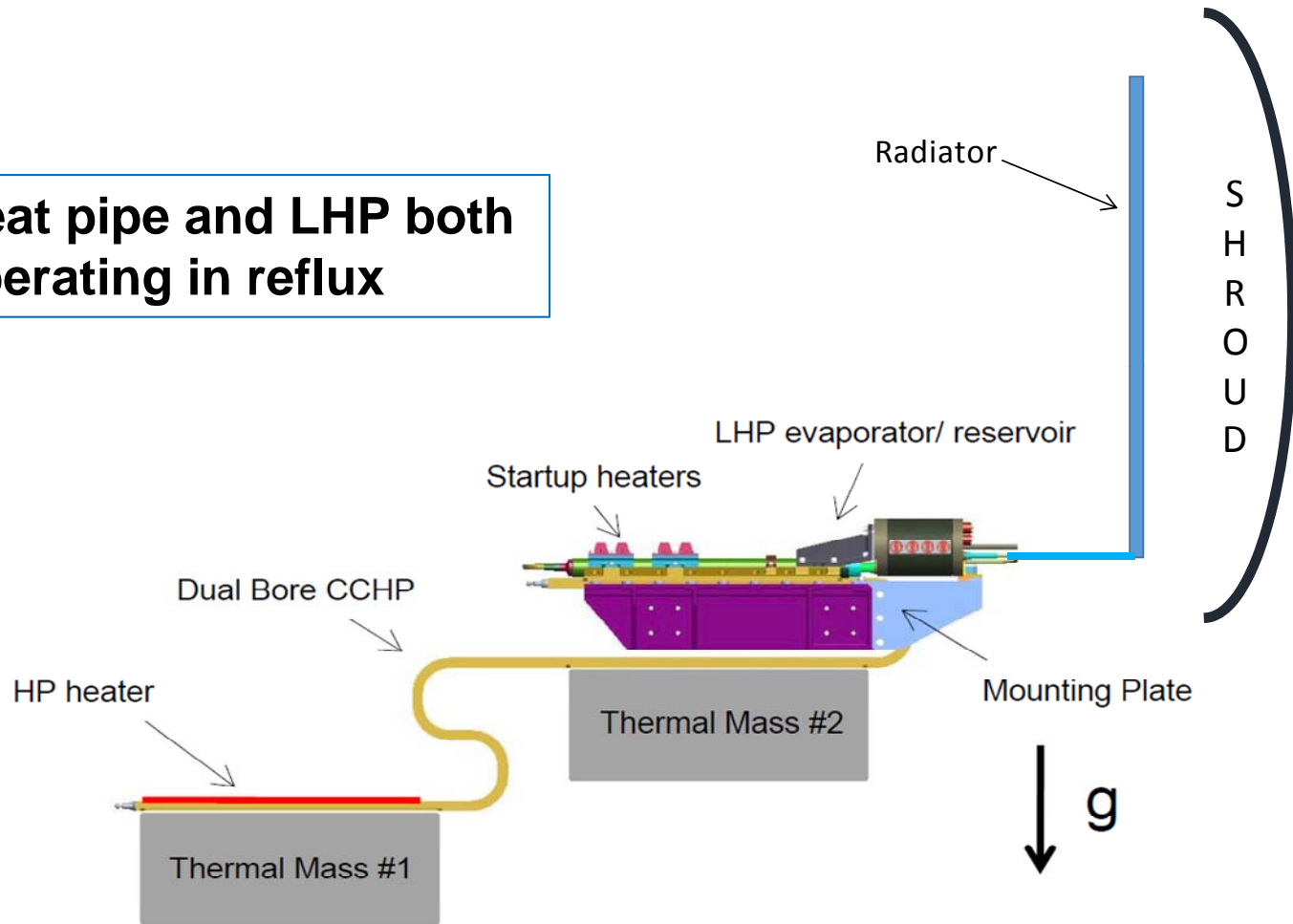

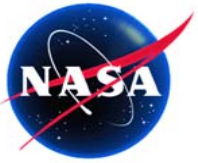

Some Temperature Sensors on ATLAS LTCS

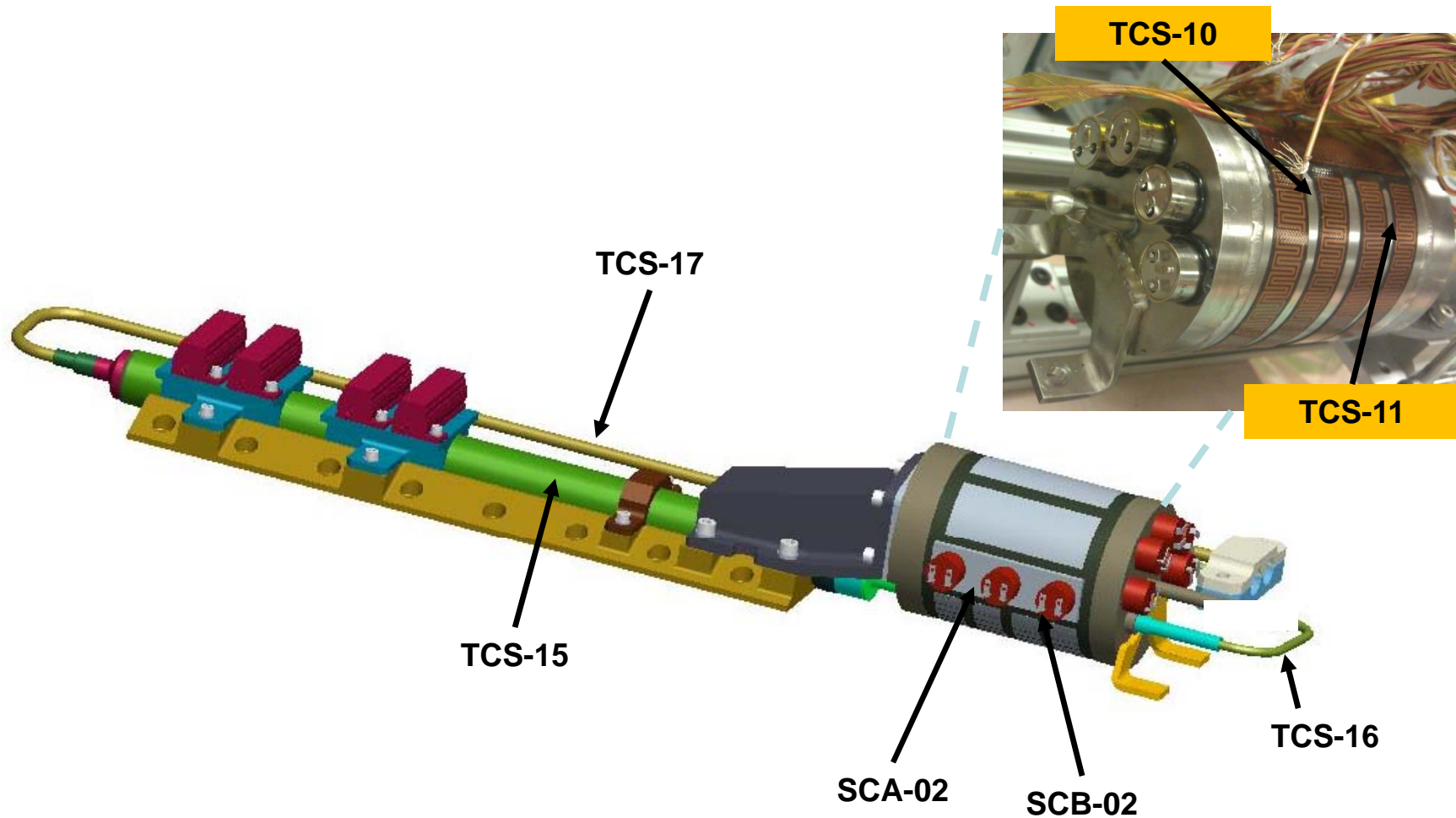

- Only data from TCS-10 and TCS-11 were collected once every four seconds.
- All other data were collected once every two minutes.

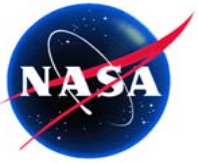

TC Locations on Radiator

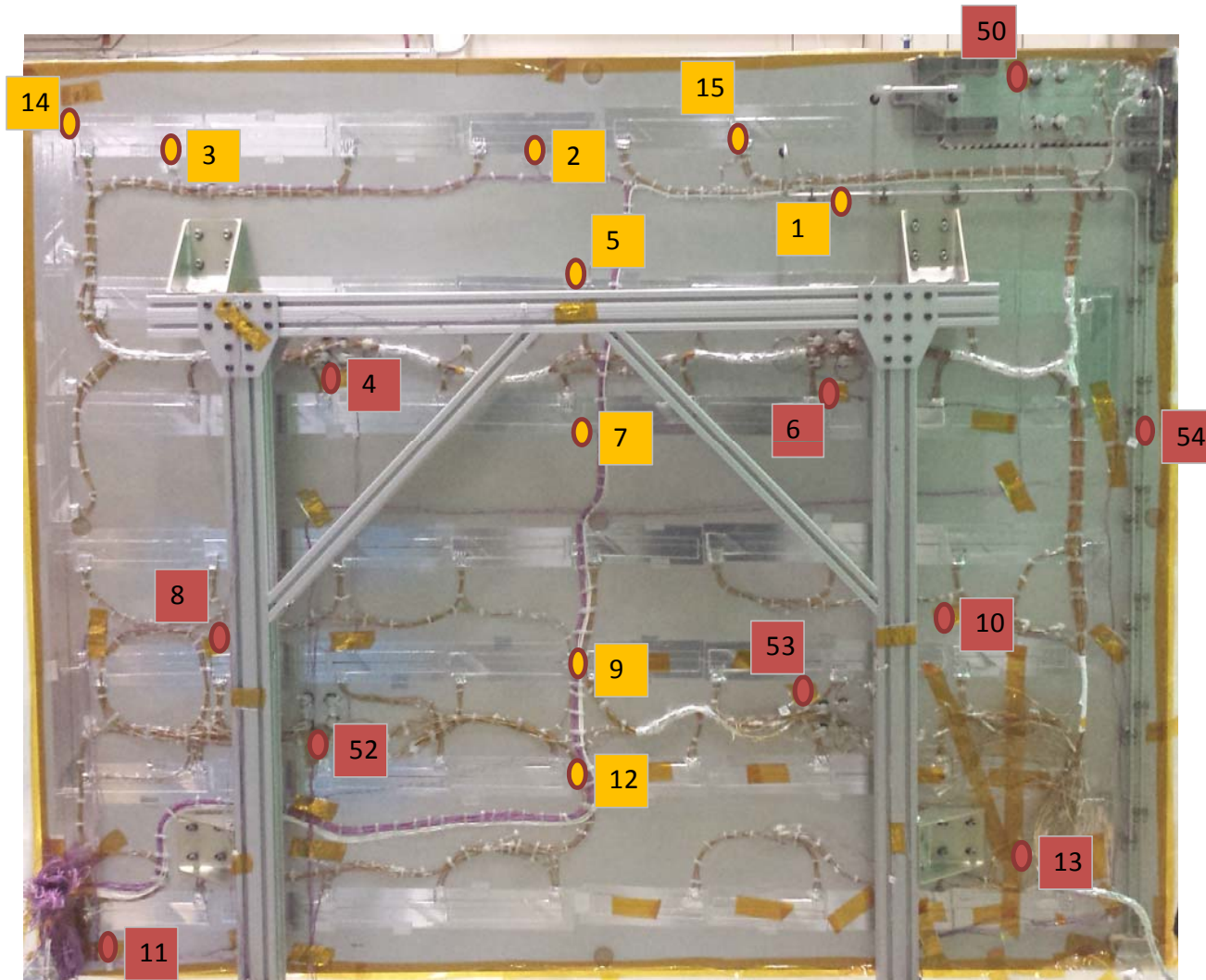

- TCs 1, 2, 3, 5, 6, 7, 9, 8, 12, 11, 14, 15 follow the condenser footprints.
- Data were collected once every two minutes.

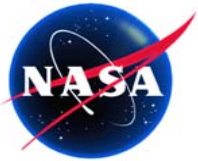

AB = 63.5 mm (2.5 in)
AD = 1212.4 mm (47.7 in)
CD = 158.3 mm (6.2 in)

Maximum $\Delta P_g = 7450 \text{ Pa}$
Minimum $\Delta P_g = 1010 \text{ Pa}$

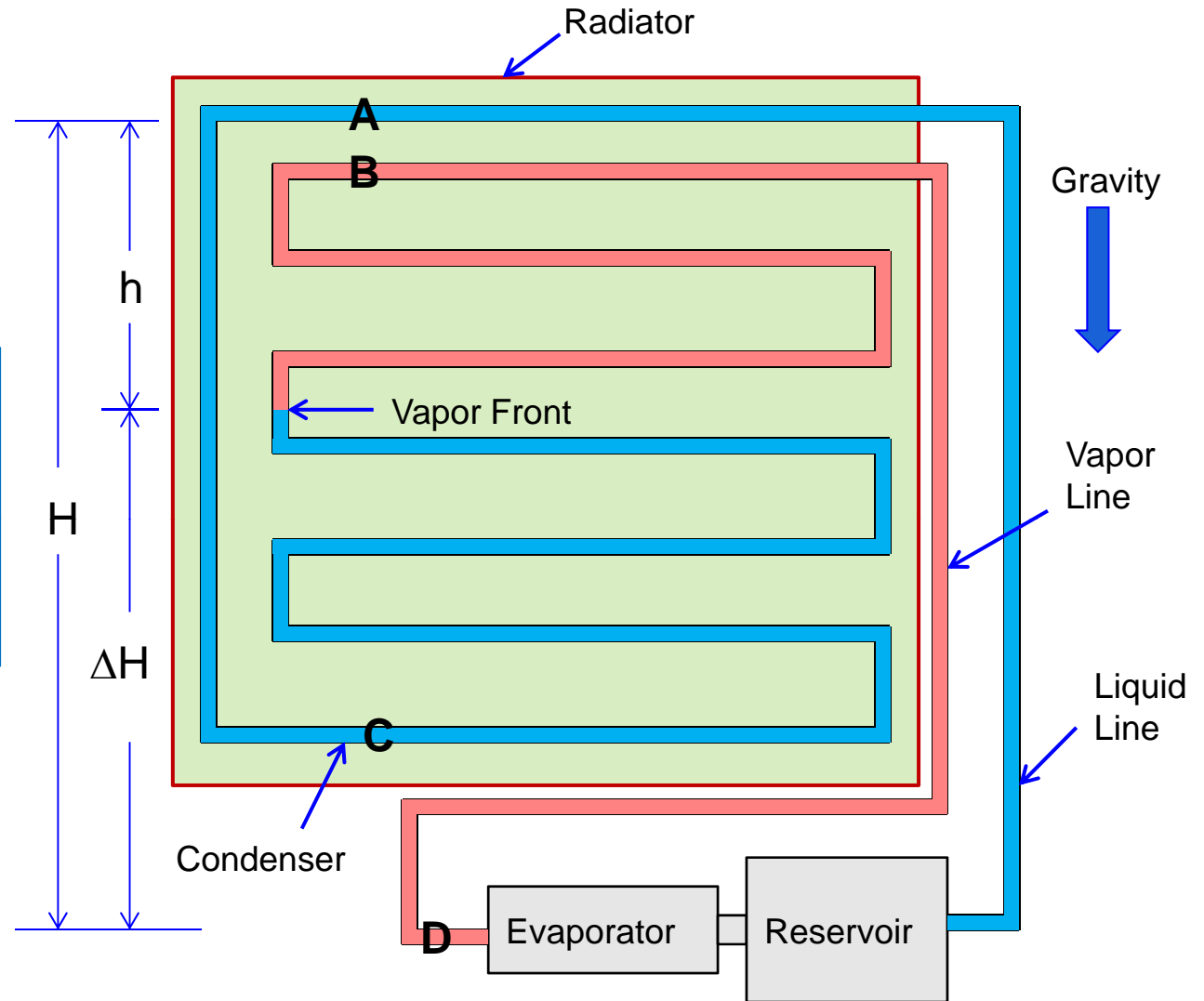

- The minimum gravity pressure head is 1010Pa

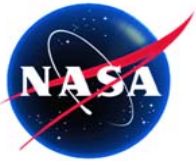

Reverse Flow During Cold Transition Test

- Test #1: Cold Transition, reservoir temperature was decreasing
- Temperatures of TCS16 and Radiator LL show that liquid drainage and reverse liquid flow did occur alternately along the liquid line.
- Oscillating reservoir temperature decreased toward its quasi-steady temperature.
- Data were collected once every two minutes.

136W to thermal mass 1, shroud at -101°C , 22W of control heater power with set points of $4^{\circ}\text{C}/5^{\circ}\text{C}$

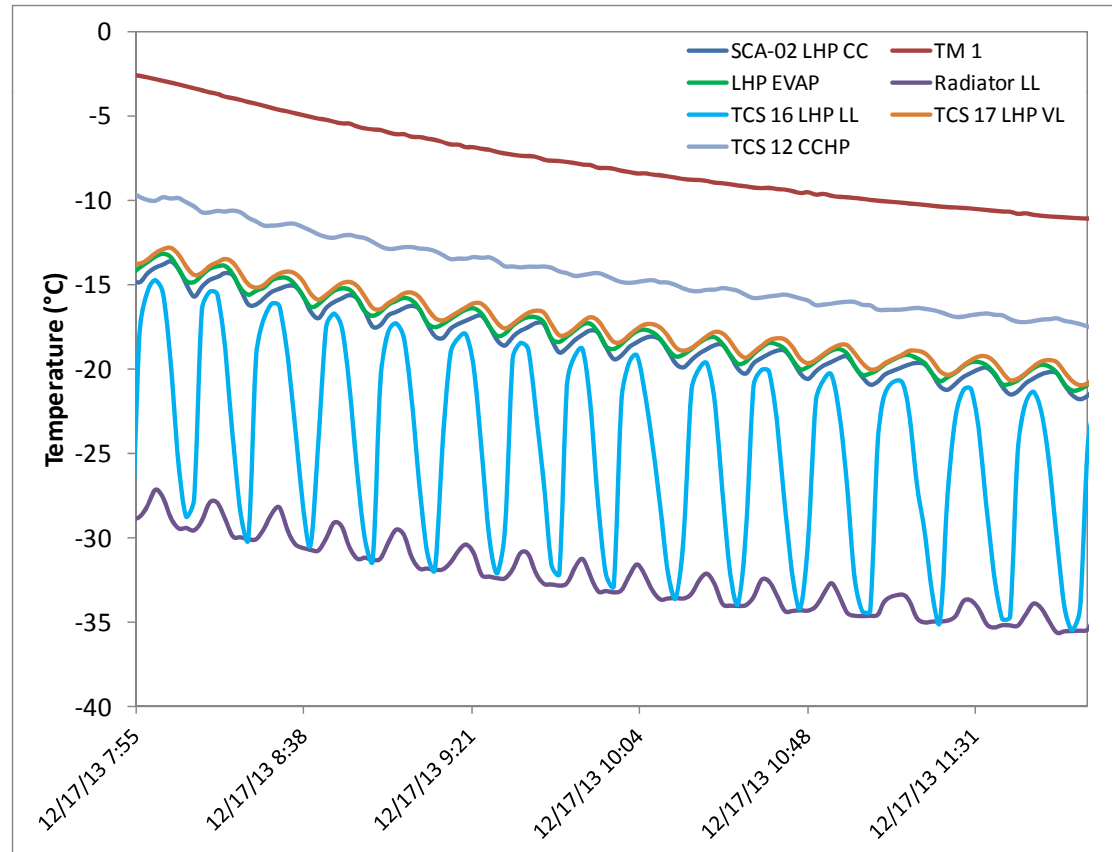

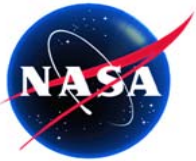

Reverse Flow During Cold Soak Test

- Test #2: Cold Soak, quasi-steady state
- Temperatures of TCS16 and Radiator LL show that liquid drainage and reverse liquid flow did occur alternately along the liquid line.
- Oscillating reservoir temperature was at a quasi-steady state.
- Data were collected once every two minutes.

136W to thermal mass 1, shroud at -101°C , 22W of control heater power with set points of $4^{\circ}\text{C}/5^{\circ}\text{C}$

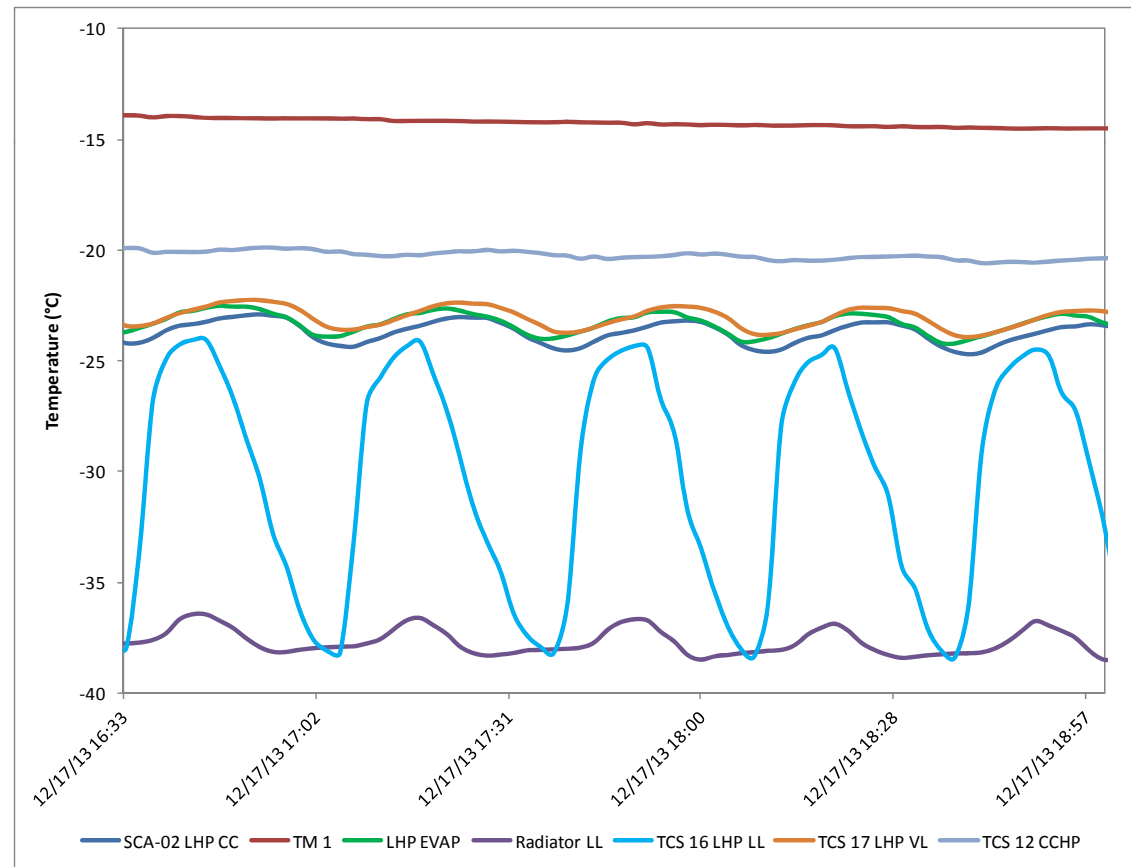

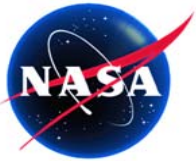

Reservoir Temperature Oscillation During Cold Transition Test

- Test #1: Cold Transition, reservoir temperature was decreasing
- Data were collected once every four seconds.
- Reservoir temperature was decreasing.
- In each cycle, reservoir temperature decreased 2.1°C in 24 seconds and rose 2.1°C in 32 seconds.

136W to thermal mass 1, shroud at -101°C, 22W of control heater power with set points of 4°C/5°C

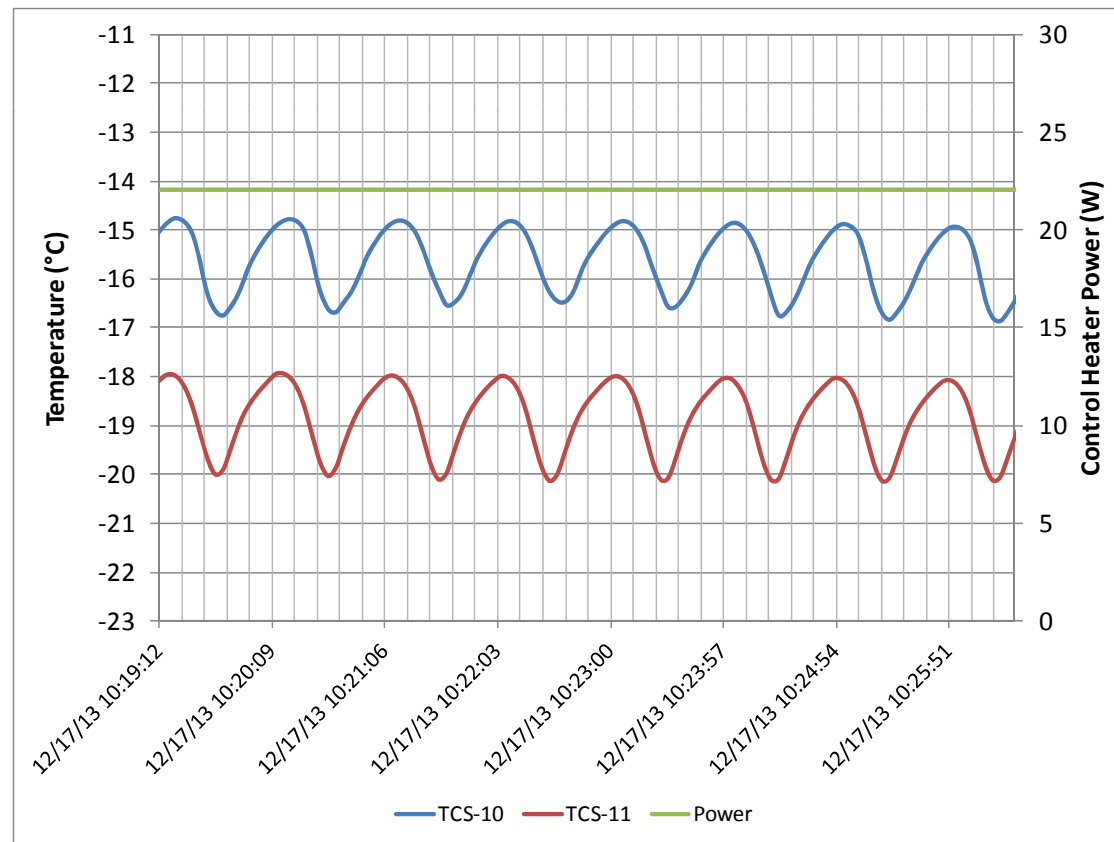

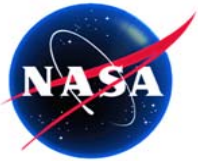

Reservoir Temperature Oscillation During Cold Soak Test

- Test #2: Cold Soak, quasi-steady state
- Data were collected once every four seconds.
- In each cycle, reservoir temperature decreased 2.1°C in 24 seconds and rose 2.1°C in 32 seconds.

136W to thermal mass 1, shroud at -101°C , 22W of control heater power with set points of $4^{\circ}\text{C}/5^{\circ}\text{C}$

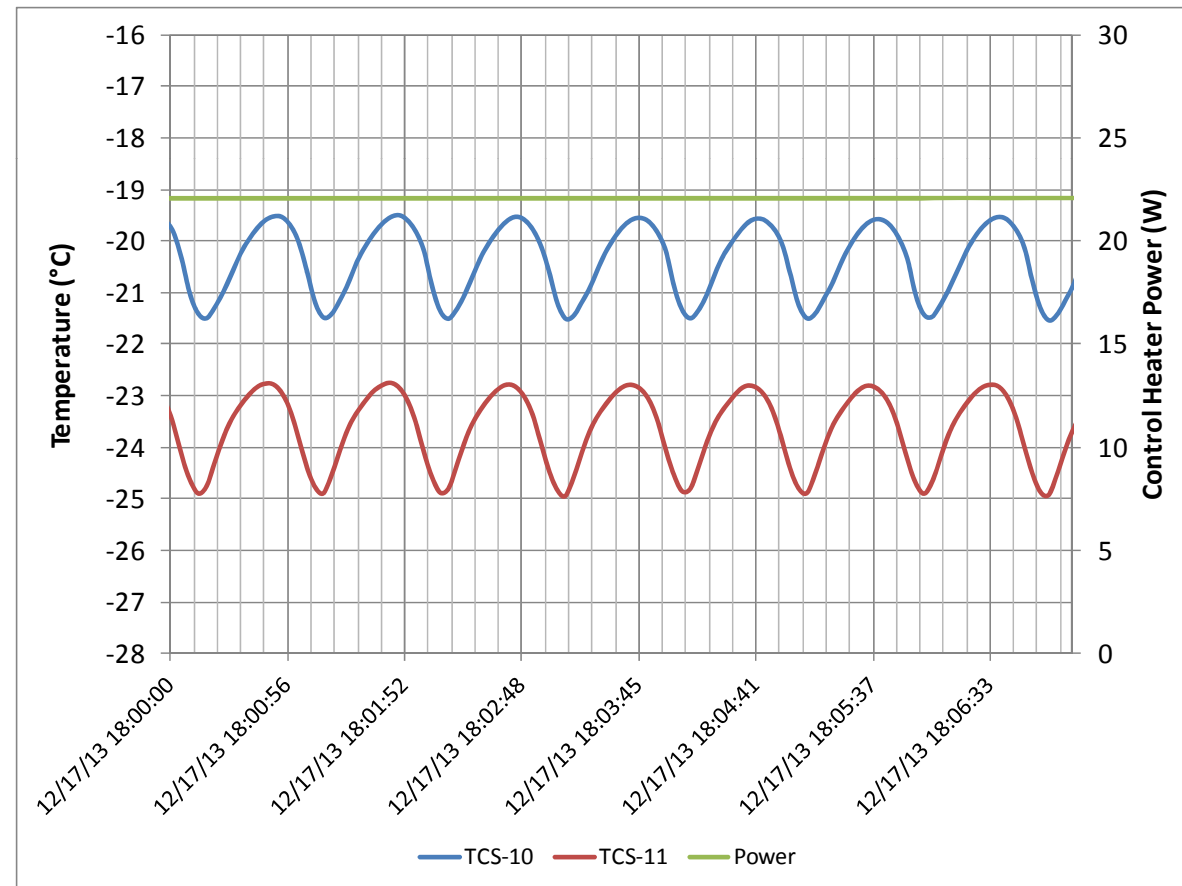

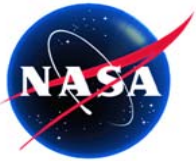

Temperature Oscillation with 38W/19W to Reservoir

- Test #5: Soak
- 38W/19W of control heater power with set points of $-2^{\circ}\text{C}/-1^{\circ}\text{C}$
- On/off of one control heater (19W) affected the reverse liquid flow.
- Data were collected once every two minutes.

196W to thermal mass 1, shroud at -78°C

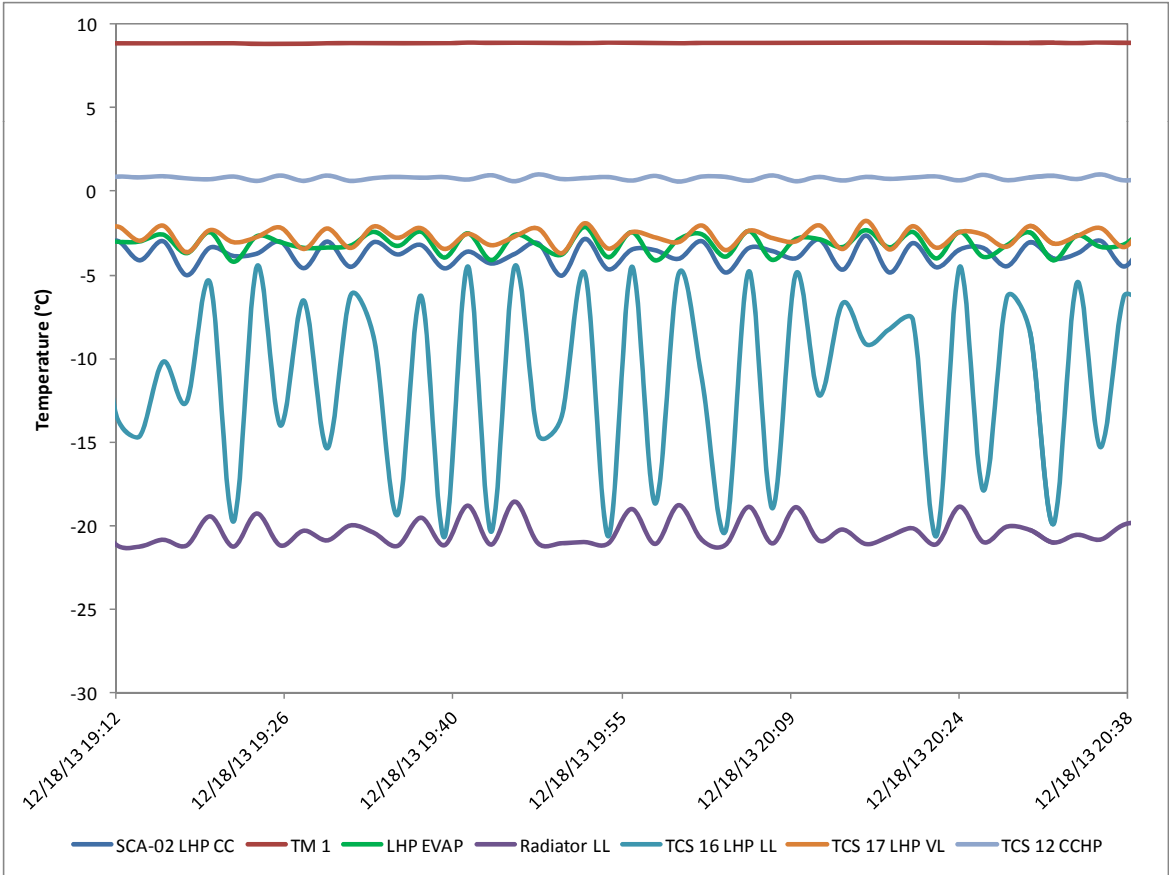

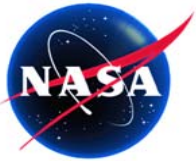

Temperature Oscillation with Various Control Heater Powers

- Test #4 and #5: 196W to thermal mass 1, shroud at -78°C , reservoir heaters set points at $-2^{\circ}\text{C}/-1^{\circ}\text{C}$
- Both heaters used TCS-11 as the control sensor.
- Increasing heater power from 22W to 38W raised reservoir temperature by 4.2°C . At 38W, one of the heaters was turned on and off. The other was on at all times.

Test #4: 22W control heater power

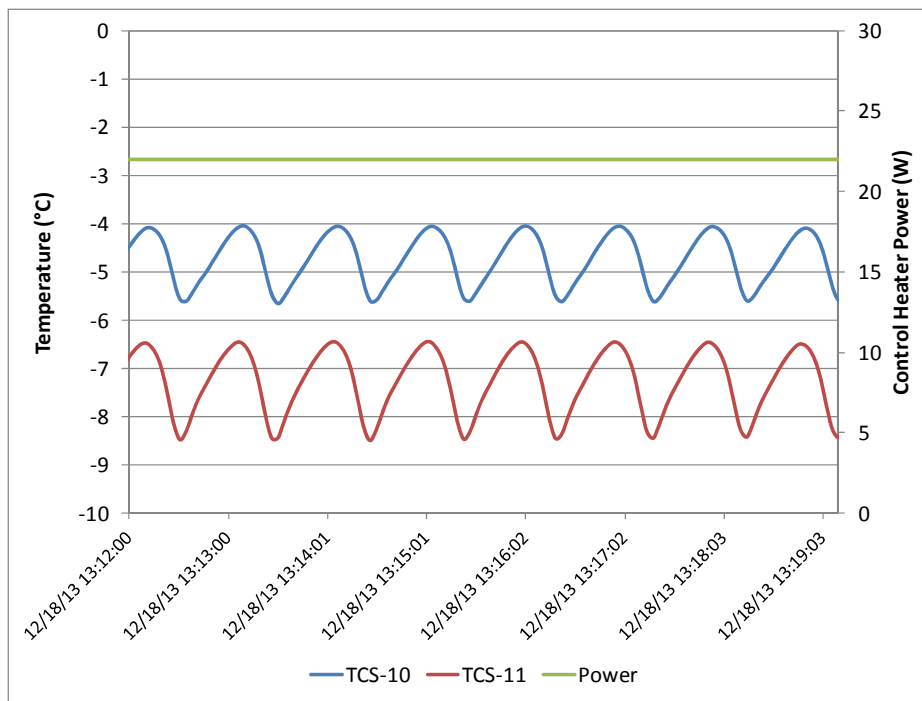

Test #5: 38W control heater power

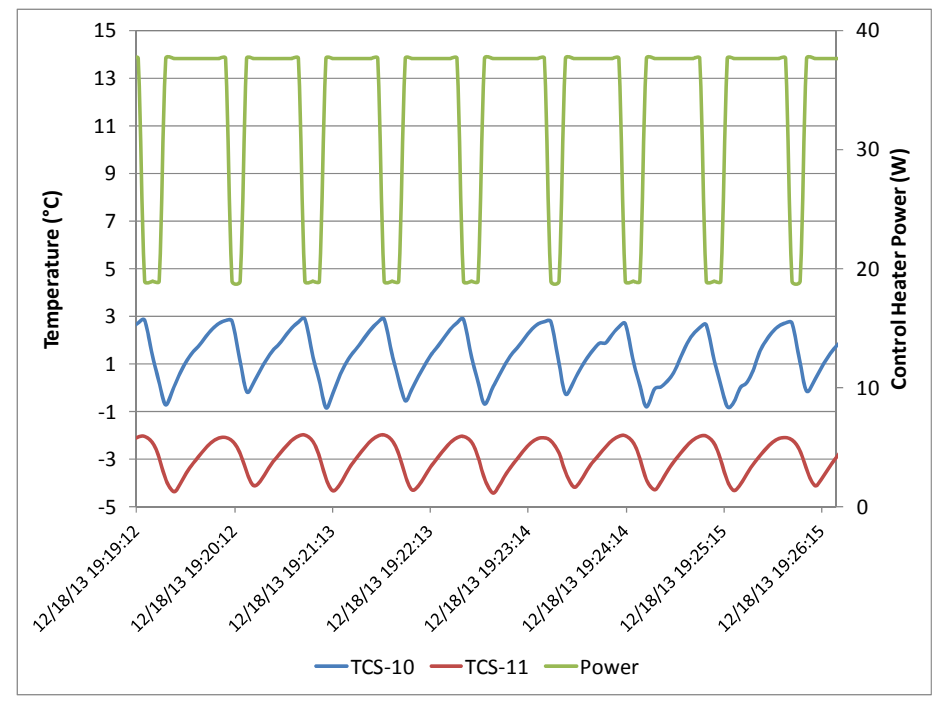

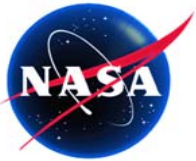

Loop Temperatures with and without Reservoir Heater Power (1/2)

- Test #6: Cold Transition
- Reservoir temperature oscillated when control heater was turned on continuously.
- Without control heater power, there was no reverse liquid flow and no temperature oscillation.
- Data were collected once every two minutes.

196W to thermal mass 1, shroud at -78°C

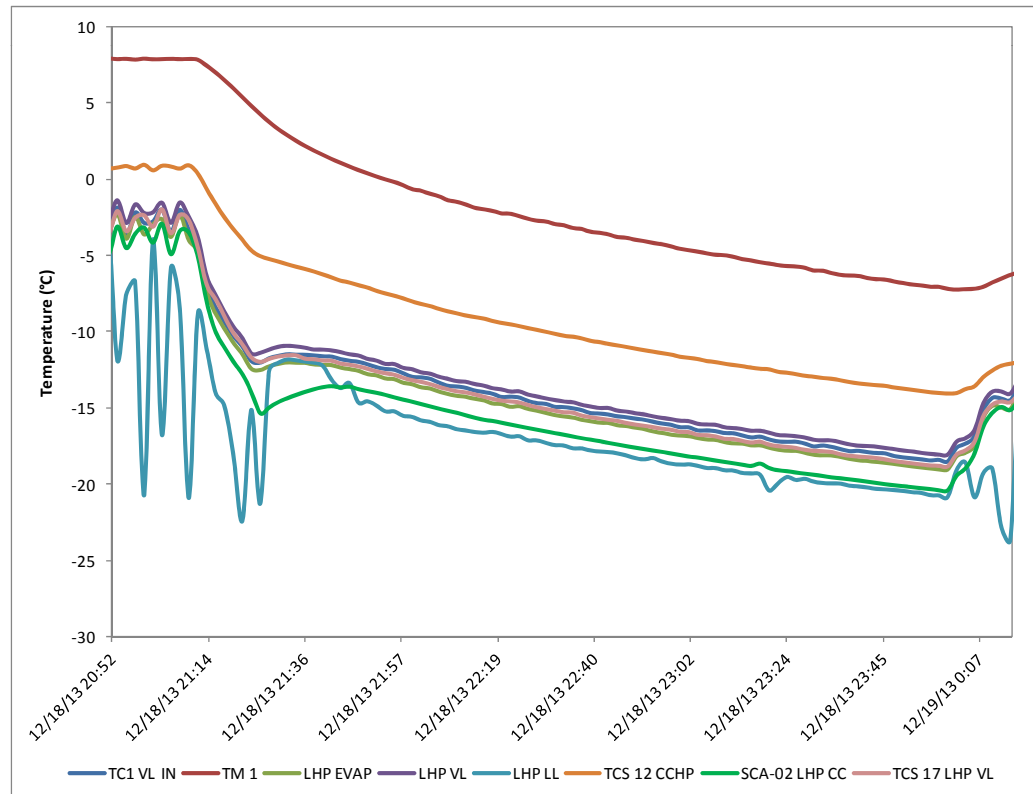

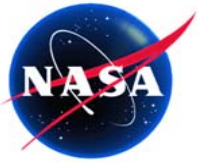

Reservoir Temperatures with and without Reservoir Heater Power (2/2)

- Test #6: Cold Transition
- Reservoir temperature oscillated when control heater was turned on continuously.
- Without control heater power, there was no reverse liquid flow and no temperature oscillation.
- Data were collected once every four seconds.

196W to thermal mass 1, shroud at -78°C

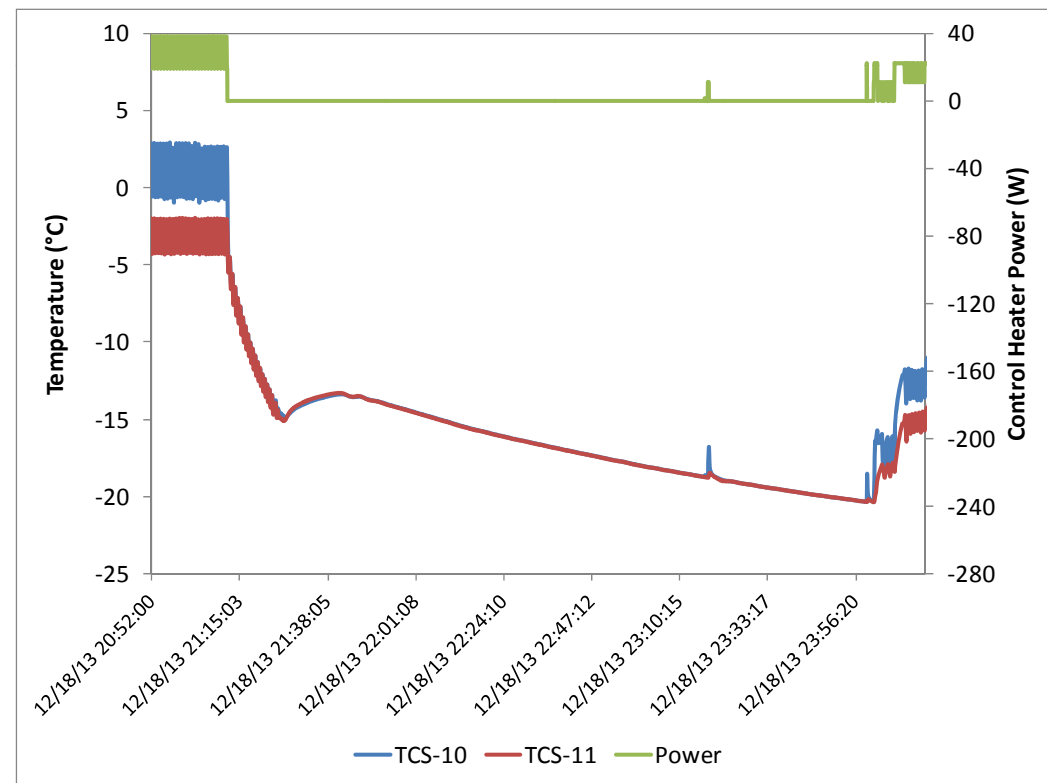

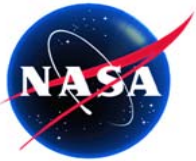

Radiator Temperatures

- Test #6: Cold Transition
- No temperature oscillation on radiator at any time due to conduction and radiation effects.
- During the period without control heater power, the reservoir was at its natural operating temperature and the radiator was fully utilized.
- Data were collected once every two minutes.

196W to thermal mass 1, shroud at -78°C

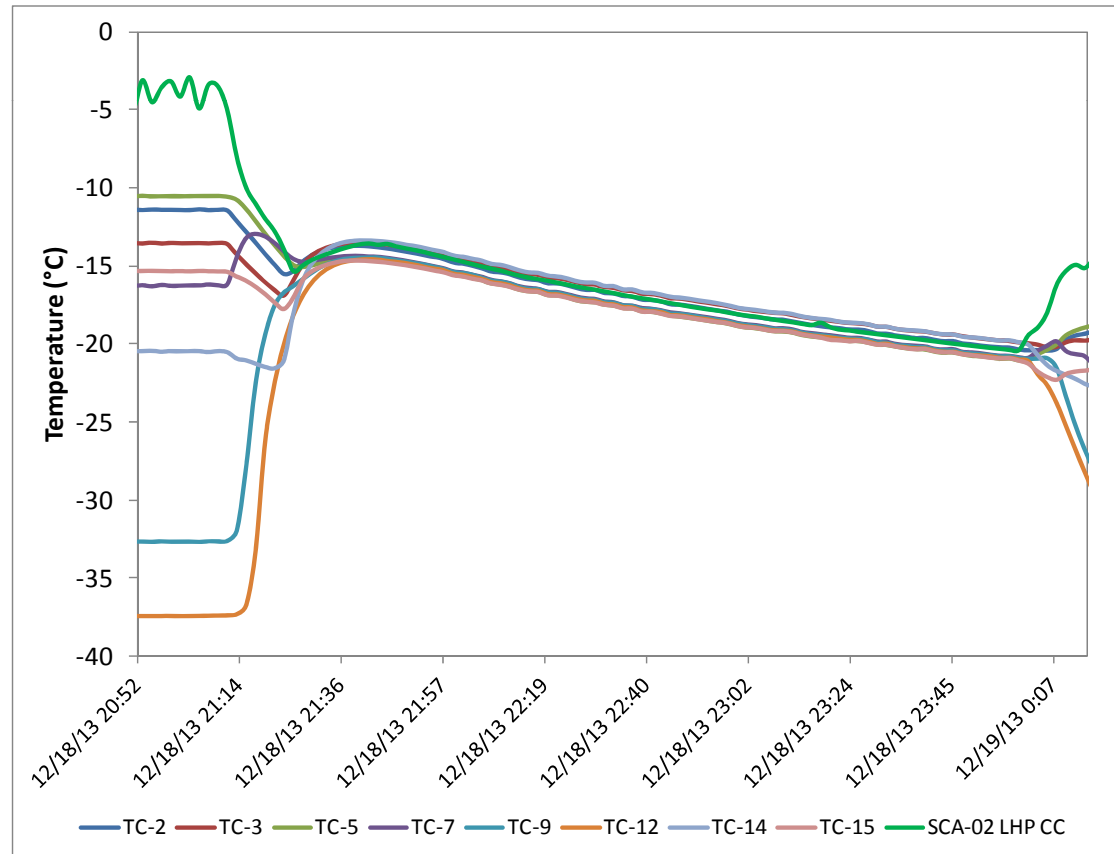

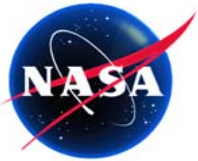

Tracking Vapor Front Movement

- **Test #2: Cold Soak**
- **Data were collected once every two minutes.**
- **Vapor front movement could not be tracked without temperature sensors on the condenser itself. The liquid mass flow rate cannot not be derived.**
- **Reservoir energy balance cannot be verified.**

136W to thermal mass 1, shroud at -101°C, 22W of control heater power with set points of 4°C/5°C

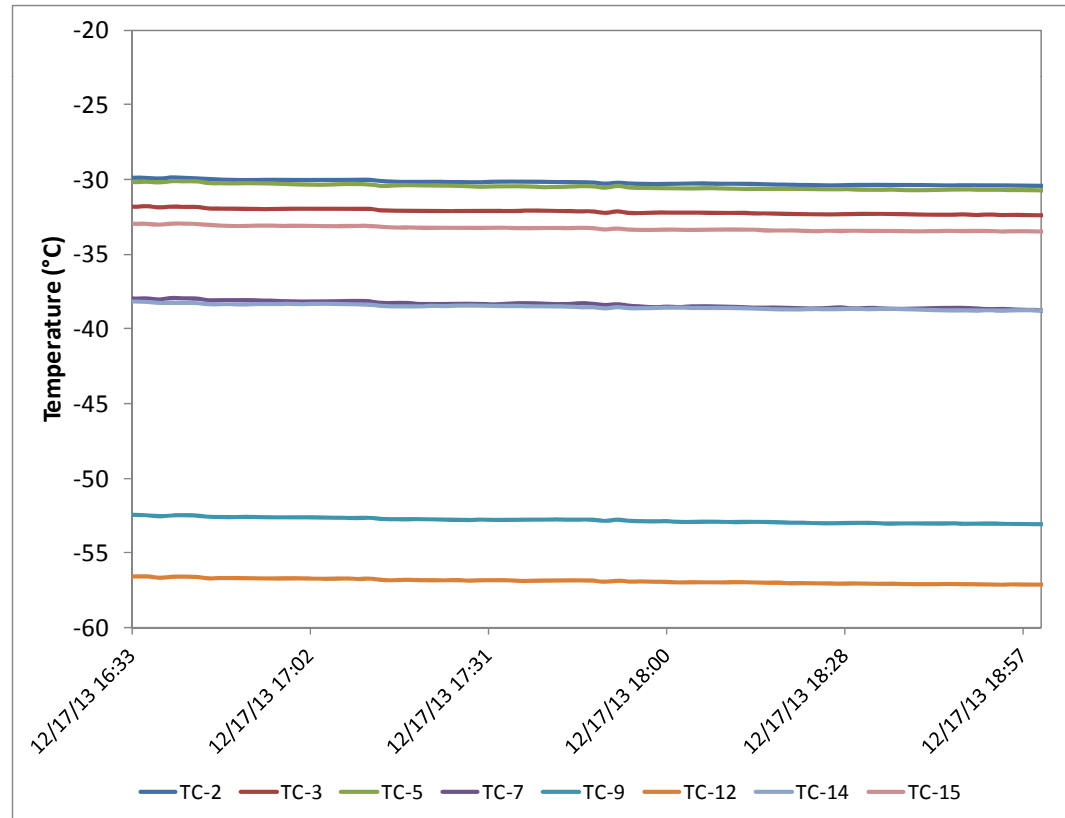

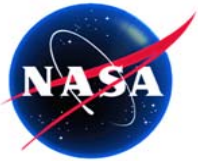

Reservoir Temperature under Various Test Conditions

- Effects of thermal mass power, reservoir heater power, and shroud temperature on reservoir temperature can be inferred from the table.

Test #	Loop Status	Thermal Mass Power (W)	Reservoir Heater Set Points (°C)	Reservoir Heater Power (W)	Chamber Shroud Temperature (°C)	Reservoir Temperature Valley/Peak (°C)
1	Transient	136	+4/+5	22	-101	Decreasing, oscillation
2	Quasi-steady	136	+4/+5	22	-101	-25.0/-22.9
3	Near quasi-steady	196	-2/-1	22	-101	-16.2/-14.2
4	Near quasi-steady	196	-2/-1	22	-78	-8.5/-6.5
5	Near quasi-steady	196	-2/-1	38/19	-78	-4.4/-2.0
6	Transient	196	N/A	0	-78	-20.2 (still decreasing, no oscillation)

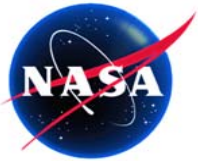

Summary and Conclusions

- **The high control heater power in ICESat-2 ATLAS LTCS TV testing was caused by persistent temperature oscillation.**
- **With persistent temperature oscillation, the reservoir was subjected to a repeated influx of cold liquid from the condenser.**
- **When the reservoir temperature was increasing, reverse liquid flow brought warm fluid from reservoir to condenser.**
- **The control heater was turned on at all times, but was unable to maintain the reservoir set point temperature due to the additional heat leak to the radiator with persistent temperature oscillation.**
- **Persistent temperature oscillation was sustained by the combination of gravity assist, reverse liquid flow, and inability of the control heater to maintain the reservoir at the desired set point temperature. Cold radiator temperature and a large thermal mass amplified this effect.**
- **Causes and effects of persistent temperature oscillation intermingled.**
- **The theory of temperature oscillation was only partially verified using data from ATLAS LTCS TV testing due to the lack of condenser temperature data. Additional data from past or future LHP tests are needed to fully verify the theory.**